

Cambium 450 Platform User Guide

System Release 15.1.4

For Regulatory Review Only



Accuracy

While reasonable efforts have been made to assure the accuracy of this document, Cambium Networks assumes no liability resulting from any inaccuracies or omissions in this document, or from use of the information obtained herein. Cambium reserves the right to make changes to any products described herein to improve reliability, function, or design, and reserves the right to revise this document and to make changes from time to time in content hereof with no obligation to notify any person of revisions or changes. Cambium does not assume any liability arising out of the application or use of any product, software, or circuit described herein; neither does it convey license under its patent rights or the rights of others. It is possible that this publication may contain references to, or information about Cambium products (machines and programs), programming, or services that are not announced in your country. Such references or information must not be construed to mean that Cambium intends to announce such Cambium products, programming, or services in your country.

Copyrights

This document, Cambium products, and 3rd Party software products described in this document may include or describe copyrighted Cambium and other 3rd Party supplied computer programs stored in semiconductor memories or other media. Laws in the United States and other countries preserve for Cambium, its licensors, and other 3rd Party supplied software certain exclusive rights for copyrighted material, including the exclusive right to copy, reproduce in any form, distribute and make derivative works of the copyrighted material. Accordingly, any copyrighted material of Cambium, its licensors, or the 3rd Party software supplied material contained in the Cambium products described in this document may not be copied, reproduced, reverse engineered, distributed, merged or modified in any manner without the express written permission of Cambium. Furthermore, the purchase of Cambium products shall not be deemed to grant either directly or by implication, estoppel, or otherwise, any license under the copyrights, patents or patent applications of Cambium or other 3rd Party supplied software, except for the normal non-exclusive, royalty free license to use that arises by operation of law in the sale of a product.

Restrictions

Software and documentation are copyrighted materials. Making unauthorized copies is prohibited by law. No part of the software or documentation may be reproduced, transmitted, transcribed, stored in a retrieval system, or translated into any language or computer language, in any form or by any means, without prior written permission of Cambium.

License Agreements

The software described in this document is the property of Cambium and its licensors. It is furnished by express license agreement only and may be used only in accordance with the terms of such an agreement.

High Risk Materials

Cambium and its supplier(s) specifically disclaim any express or implied warranty of fitness for any high risk activities or uses of its products including, but not limited to, the operation of nuclear facilities, aircraft navigation or aircraft communication systems, air traffic control, life support, or weapons systems ("High Risk Use"). Any "High Risk Use" is unauthorized, is made at your own risk and you shall be responsible for any and all losses, damage or claims arising out of any High Risk Use.

© 2018 Cambium Networks Limited. All Rights Reserved.

Contents

Cambium 450 Platform User Guide	1
Contents	i
List of Figures	xiv
List of Tables.....	xix
About This User Guide.....	1
Contacting Cambium Networks.....	1
Purpose	2
Product notation conventions in document	2
Cross references.....	3
Feedback	3
Important regulatory information.....	4
Application software.....	4
USA specific information.....	4
Canada specific information	5
Renseignements spécifiques au Canada	6
EU Declaration of Conformity	7
Specific expertise and training for professional installers.....	7
Ethernet networking skills	7
Lightning protection.....	8
Training	8
Problems and warranty	9
Reporting problems	9
Repair and service.....	9
Hardware warranty	9
Security advice	10
Warnings, cautions, and notes	11
Warnings.....	11
Cautions	11
Notes	11
Caring for the environment.....	12
In EU countries	12
In non-EU countries	12
Chapter 1: Product description.....	1-1
Overview of the 450 Platform Family.....	1-2
Purpose	1-2
PMP 450m Series	1-2
PMP/PTP 450i Series	1-4

PMP 450b Series.....	1-8
PMP/PTP 450 Series	1-10
Supported interoperability for 450m/450i/450b/450 Series.....	1-13
Typical deployment.....	1-14
Product variants	1-16
Wireless operation	1-17
Time division duplexing	1-17
Encryption.....	1-20
MIMO.....	1-20
MU-MIMO	1-20
System management.....	1-22
Management agent.....	1-22
Web server.....	1-22
Remote Authentication Dial-in User Service (RADIUS).....	1-24
Network Time Protocol (NTP)	1-24
Wireless Manager (WM).....	1-25
cnMaestro™	1-26
Radio recovery mode.....	1-27
Chapter 2: System hardware	2-1
System Components	2-2
Point-to-Multipoint (PMP).....	2-2
Backhaul (PTP).....	2-5
450 Platform Family interfaces	2-7
ATEX/HAZLOC variants	2-15
Diagnostic LEDs.....	2-16
Power supply options	2-20
ODU mounting brackets & accessories.....	2-29
Lightning protection.....	2-29
ODU interfaces	2-30
PMP 450m Series AP.....	2-30
PMP/PTP 450i	2-31
PMP 450b SM (Mid Gain)	2-33
PMP 450b SM (High Gain).....	2-34
Cabling	2-35
Ethernet standards and cable lengths.....	2-35
Outdoor copper Cat5e Ethernet cable	2-36
SFP module kits.....	2-37
Main Ethernet port	2-39
Aux port	2-39
Lightning protection unit (LPU) and grounding kit.....	2-43
Cable grounding kit.....	2-44
Antennas and antenna cabling	2-45
Antenna requirements	2-45

Supported external AP antennas.....	2-45
Supported external BH/SM antenna.....	2-45
RF cable and connectors	2-46
Antenna accessories	2-46
GPS synchronization.....	2-47
GPS synchronization description.....	2-47
Universal GPS (UGPS)	2-47
CMM5	2-48
CMM5 Controller Module.....	2-50
CMM5 Injector Module	2-51
CMM5 Injector Compatibility Matrix	2-51
CMM5 Specifications	2-52
CMM4 (Rack Mount)	2-53
CMM4 (Cabinet with switch).....	2-56
CMM4 (Cabinet without switch)	2-56
CMM3/CMMmicro	2-57
Installing a GPS receiver	2-59
GPS receiver location.....	2-59
Mounting the GPS receiver	2-60
Cabling the GPS Antenna.....	2-61
Installing and connecting the GPS LPU	2-61
Ordering the components	2-62
Chapter 3: System planning	3-1
Typical deployment	3-2
ODU with PoE interface to PSU	3-2
Site planning.....	3-7
Site selection for PMP/PTP radios	3-7
Power supply site selection.....	3-8
Maximum cable lengths	3-8
Grounding and lightning protection.....	3-8
ODU and external antenna location	3-10
ODU ambient temperature limits	3-10
ODU wind loading.....	3-11
Hazardous locations.....	3-15
Drop cable grounding points	3-15
Lightning Protection Unit (LPU) location	3-16
Radio Frequency planning	3-17
Regulatory limits	3-17
Conforming to the limits.....	3-17
Available spectrum	3-17
Analyzing the RF Environment	3-18
Channel bandwidth	3-18
Anticipating Reflection of Radio Waves.....	3-18

Obstructions in the Fresnel Zone.....	3-19
Planning for co-location.....	3-19
Multiple OFDM Access Point Clusters.....	3-20
Considerations on back-to-back frequency reuse.....	3-22
Link planning.....	3-27
Range and obstacles.....	3-27
Path loss.....	3-27
Calculating Link Loss.....	3-28
Calculating Rx Signal Level.....	3-28
Calculating Fade Margin.....	3-29
Adaptive modulation.....	3-29
Planning for connectorized units.....	3-30
When to install connectorized units.....	3-30
Choosing external antennas.....	3-30
Calculating RF cable length (5.8 GHz FCC only).....	3-30
Data network planning.....	3-32
Understanding addresses.....	3-32
Dynamic or static addressing.....	3-32
DNS Client.....	3-33
Network Address Translation (NAT).....	3-33
Developing an IP addressing scheme.....	3-34
Address Resolution Protocol.....	3-34
Allocating subnets.....	3-35
Selecting non-routable IP addresses.....	3-35
Translation bridging.....	3-36
Engineering VLANs.....	3-36
Network management planning.....	3-40
Planning for SNMP operation.....	3-40
Enabling SNMP.....	3-40
Security planning.....	3-41
Isolating AP/BHM from the Internet.....	3-41
Encrypting radio transmissions.....	3-41
Planning for HTTPS operation.....	3-42
Planning for SNMPv3 operation.....	3-42
Managing module access by passwords.....	3-43
Planning for RADIUS operation.....	3-44
Filtering protocols and ports.....	3-44
Encrypting downlink broadcasts.....	3-48
Isolating SMs in PMP.....	3-48
Filtering management through Ethernet.....	3-48
Allowing management from only specified IP addresses.....	3-49
Configuring management IP by DHCP.....	3-49
Controlling PPPoE PADI Downlink Forwarding.....	3-50

Remote AP Deployment	3-51
Remote AP (RAP) Performance.....	3-52
Example Use Case for RF Obstructions	3-52
Example Use Case for Passing Sync.....	3-53
Physical Connections Involving the Remote AP	3-54
Passing Sync signal	3-56
Wiring to Extend Network Sync.....	3-59
Chapter 4: Legal and regulatory information	4-1
Cambium Networks end user license agreement	4-2
Definitions.....	4-2
Acceptance of this agreement	4-2
Grant of license	4-2
Conditions of use	4-3
Title and restrictions	4-4
Confidentiality	4-4
Right to use Cambium’s name.....	4-5
Transfer	4-5
Updates	4-5
Maintenance	4-5
Disclaimer	4-6
Limitation of liability	4-6
U.S. government	4-6
Term of license	4-7
Governing law	4-7
Assignment.....	4-7
Survival of provisions	4-7
Entire agreement.....	4-7
Third party software.....	4-7
Compliance with safety standards	4-22
Electrical safety compliance.....	4-22
Electromagnetic compatibility (EMC) compliance	4-22
Human exposure to radio frequency energy.....	4-22
Hazardous location compliance.....	4-33
Compliance with radio regulations	4-35
Type approvals	4-36
Brazil specific information.....	4-37
Australia Notification	4-37
Regulatory Requirements for CEPT Member States (www.cept.org)	4-37
Chapter 5: Preparing for installation	5-1
Safety	5-2
Hazardous locations.....	5-2
Power lines	5-2
Working at heights.....	5-2

Power supply	5-2
Grounding and protective earth	5-3
Powering down before servicing.....	5-3
Primary disconnect device	5-3
External cables	5-3
RF exposure near the antenna	5-3
Minimum separation distances	5-3
Grounding and lightning protection requirements.....	5-4
Grounding cable installation methods.....	5-4
Siting ODU and antennas.....	5-4
Thermal Safety	5-4
Preparing for installation.....	5-6
ODU pre-configuration	5-6
Preparing personnel.....	5-6
Preparing inventory	5-6
Preparing tools	5-7
Testing system components.....	5-8
Unpacking Components	5-8
Preparing the ODU.....	5-8
Configuring Link for Test.....	5-17
Configuring the management PC	5-17
Logging into the web interface – AP/SM/BH	5-18
Using the Quick Start Configuration Wizard of the AP/BHM	5-18
Chapter 6: Installation	6-1
ODU variants and mounting bracket options.....	6-2
Mount the ODU, LPU and surge suppressor	6-3
Attach ground cables to the ODU.....	6-3
Mount the ODU on the mast	6-6
Mount the top LPU	6-12
Mount the Surge Suppressor.....	6-12
General protection installation	6-16
Installing the copper Cat5e Ethernet interface	6-22
Install the main drop cable.....	6-22
Install the bottom LPU to PSU drop cable	6-24
Installing external antennas to a connectorized ODU	6-26
PMP 450i Series.....	6-26
PMP 450 Series.....	6-34
PMP 450i Series AP 900 MHz	6-43
PMP 450 Series SM 900 MHz	6-50
Installing an integrated ODU.....	6-54
PMP 450m Series – AP.....	6-54
PMP/PTP 450i Series – AP/SM/BH.....	6-57
Connecting Cat5e Ethernet cable.....	6-58

Connecting an RJ45 and gland to a unit	6-58
Disconnecting an RJ45 and gland from a unit	6-60
Installing ODU	6-61
Installing a 450 Platform Family AP.....	6-61
Installing a 450 Platform Family SM.....	6-62
Installing a 450 Platform Family BHM	6-63
Installing a 450 platform BHS	6-64
Configuring the Link.....	6-65
Monitoring the Link.....	6-65
Installing the AC Power Injector	6-66
Installing the AC Power Injector	6-66
Installing CMM4	6-67
Supplemental installation information	6-68
Stripping drop cable	6-68
Creating a drop cable grounding point.....	6-69
Attaching and weatherproofing an N type connector	6-72
Chapter 7: Configuration.....	7-1
Preparing for configuration.....	7-2
Safety precautions	7-2
Regulatory compliance.....	7-2
Connecting to the unit	7-3
Configuring the management PC	7-3
Connecting to the PC and powering up	7-4
Using the web interface.....	7-5
Logging into the web interface	7-5
Web GUI.....	7-6
Using the menu options	7-7
Quick link setup	7-12
Initiating Quick Start Wizard	7-12
Configuring time settings.....	7-18
Powering the SM/BHS for test	7-19
Viewing the Session Status of the AP/BHM to determine test registration.....	7-20
Configuring IP and Ethernet interfaces	7-23
Configuring the IP interface	7-24
Auxiliary port.....	7-27
NAT, DHCP Server, DHCP Client and DMZ	7-28
DHCP – BHS	7-45
Reconnecting to the management PC.....	7-45
VLAN configuration for PMP	7-45
VLAN configuration for PTP	7-55
PPPoE page of SM.....	7-59
IP4 and IPv6	7-62
Upgrading the software version and using CNUT	7-66

Checking the installed software version	7-66
Upgrading to a new software version	7-66
General configuration	7-70
PMP 450m and PMP/PTP 450i Series	7-70
PMP/PTP 450 Series	7-88
Configuring Unit Settings page	7-93
Setting up time and date	7-97
Time page of 450 Platform Family - AP/BHM	7-97
Configuring synchronization	7-99
Configuring security	7-101
Managing module access by password	7-102
Isolating from the internet – APs/BHMs	7-105
Encrypting radio transmissions	7-105
Requiring SM Authentication	7-106
Filtering protocols and ports	7-107
Encrypting downlink broadcasts	7-110
Isolating SMs	7-110
Filtering management through Ethernet	7-111
Allowing management only from specified IP addresses	7-111
Restricting radio Telnet access over the RF interface	7-111
Configuring SNMP Access	7-114
Configuring Security	7-116
Configuring radio parameters	7-128
PMP 450m Series – configuring radio	7-129
PMP/PTP 450i Series – configuring radio	7-134
PMP 450b Series - configuring radio	7-153
PMP/PTP 450 Series – configuring radio	7-157
Custom Frequencies page	7-174
DFS for 5 GHz Radios	7-177
MIMO-A mode of operation	7-179
Improved PPS performance of 450 Platform Family	7-181
Setting up SNMP agent	7-182
Configuring SM/BHS’s IP over-the-air access	7-183
Configuring SNMP	7-185
Configuring syslog	7-191
Syslog event logging	7-192
Configuring system logging	7-192
Configuring remote access	7-197
Accessing SM/BHS over-the-air by Web Proxy	7-197
Monitoring the Link	7-198
Link monitoring procedure	7-198
Exporting Session Status page of AP/BHM	7-200
Configuring quality of service	7-201

Maximum Information Rate (MIR) Parameters	7-201
Token Bucket Algorithm	7-201
MIR Data Entry Checking.....	7-202
Committed Information Rate (CIR)	7-202
Bandwidth from the SM Perspective.....	7-203
Interaction of Burst Allocation and Sustained Data Rate Settings	7-203
High-priority Bandwidth	7-203
Traffic Scheduling	7-205
Setting the Configuration Source.....	7-206
Configuring Quality of Service (QoS).....	7-208
Installation Color Code	7-214
Zero Touch Configuration Using DHCP Option 66.....	7-215
Configuration Steps	7-215
Troubleshooting	7-220
Configuring Radio via config file	7-221
Import and Export of config file.....	7-221
Configuring cnMaestro™ Connectivity	7-223
Configuring a RADIUS server	7-229
Understanding RADIUS for PMP 450 Platform Family.....	7-229
Choosing Authentication Mode and Configuring for Authentication Servers - AP	7-230
SM Authentication Mode – Require RADIUS or Follow AP.....	7-235
Handling Certificates.....	7-240
Configuring RADIUS servers for SM authentication	7-241
Assigning SM management IP addressing via RADIUS.....	7-243
Configuring RADIUS server for SM configuration.....	7-243
Configuring RADIUS server for SM configuration using Zero Touch feature.....	7-247
Using RADIUS for centralized AP and SM user name and password management.....	7-248
RADIUS Device Data Accounting.....	7-253
RADIUS Device Re-authentication.....	7-257
RADIUS Change of Authorization and Disconnect Message	7-258
Microsoft RADIUS support.....	7-259
Cisco ACS RADIUS Server Support.....	7-263
Configuring VSA.....	7-266
Configuring Ping Watchdog.....	7-270
Chapter 8: Tools	8-1
Using Spectrum Analyzer tool.....	8-2
Mapping RF Neighbor Frequencies.....	8-2
Spectrum Analyzer tool	8-3
Remote Spectrum Analyzer tool.....	8-12
Using the Alignment Tool	8-15
Aiming page and Diagnostic LED – SM/BHS.....	8-16
Alignment Tone.....	8-20
Using the Link Capacity Test tool	8-22

Performing Link Test.....	8-22
Performing Extrapolated Link Test.....	8-27
Link Capacity Test page of AP.....	8-29
Link Capacity Test page of BHM/BHS/SM.....	8-30
Using AP Evaluation tool.....	8-32
AP Evaluation page.....	8-32
Using BHM Evaluation tool.....	8-36
BHM Evaluation page of BHS.....	8-36
Using the OFDM Frame Calculator tool.....	8-40
Using the Subscriber Configuration tool.....	8-45
Using the Link Status tool.....	8-46
Link Status – AP/BHM.....	8-46
Link Status – SM/BHS.....	8-49
Using BER Results tool.....	8-51
Using the Sessions tool.....	8-52
Using the Ping Test tool.....	8-53
Chapter 9: Operation.....	9-1
System information.....	9-2
Viewing General Status.....	9-2
Viewing Session Status.....	9-20
Viewing Remote Subscribers.....	9-29
Interpreting messages in the Event Log.....	9-29
Viewing the Network Interface.....	9-32
Viewing the Layer 2 Neighbors.....	9-33
System statistics.....	9-34
Viewing the Scheduler statistics.....	9-34
Viewing list of Registration Failures statistics.....	9-36
Interpreting Bridging Table statistics.....	9-38
Interpreting Translation Table statistics.....	9-38
Interpreting Ethernet statistics.....	9-39
Interpreting RF Control Block statistics.....	9-42
Interpreting Sounding statistics for AP.....	9-1
Interpreting Sounding statistics for SM.....	9-1
Interpreting VLAN statistics.....	9-2
Interpreting Data VC statistics.....	9-3
Interpreting MIR/Burst statistics.....	9-5
Interpreting Throughput statistics.....	9-7
Interpreting Overload statistics.....	9-11
Interpreting DHCP Relay statistics.....	9-13
Interpreting Filter statistics.....	9-14
Viewing ARP statistics.....	9-15
Viewing NAT statistics.....	9-15
Viewing NAT DHCP Statistics.....	9-17

Interpreting Sync Status statistics	9-18
Interpreting PPPoE Statistics for Customer Activities	9-19
Interpreting Bridge Control Block statistics	9-21
Interpreting Pass Through Statistics	9-24
Interpreting SNMPv3 Statistics	9-25
Interpreting syslog statistics	9-27
Interpreting Frame Utilization statistics	9-27
Radio Recovery	9-39
Radio Recovery Console– PMP/PTP 450i/450b and PMP 450m	9-39
Default Mode (or Default/Override Plug) - PMP/PTP 450 Series	9-41
Chapter 10: Reference information	10-1
Equipment specifications	10-2
Specifications for PMP 450m Series - AP	10-2
Specifications for PMP 450i Series - AP	10-6
Specifications for PMP 450i Series - SM	10-12
Specifications for PTP 450i Series - BH	10-17
Specifications for PMP 450b Series - SM (Mid Gain)	10-21
Specifications for PMP 450b Series - SM (High Gain)	10-26
Specifications for PMP 450 Series - AP	10-30
Specifications for PMP 450 Series - SM	10-35
Specifications for PTP 450 Series - BH	10-40
PSU specifications	10-45
Data network specifications	10-47
Ethernet interface	10-47
Wireless specifications	10-48
General wireless specifications	10-48
Link Range and Throughput	10-49
Country specific radio regulations	10-50
Type approvals	10-50
DFS for 2.4 and 5 GHz Radios	10-52
Equipment Disposal	10-54
Waste (Disposal) of Electronic and Electric Equipment	10-54
Country specific maximum transmit power	10-55
Maximum transmit power 900 MHz band	10-55
Maximum transmit power 2.4 GHz band	10-56
Maximum transmit power 3.5 GHz band	10-57
Maximum transmit power 3.65 GHz band	10-58
Maximum transmit power 4.9 GHz band	10-58
Maximum transmit power 5.1 GHz band	10-60
Maximum transmit power 5.2 GHz band	10-63
Maximum transmit power 5.4 GHz band	10-66
Maximum transmit power 5.8 GHz band	10-71
Country specific frequency range	10-75

Frequency range 900 MHz band	10-75
Frequency range 2.4 GHz band.....	10-76
Frequency range 3.5 GHz band.....	10-76
Frequency range 3.65 GHz band.....	10-77
Frequency range 4.9 GHz band.....	10-78
Frequency range 5.1 GHz band.....	10-79
Frequency range 5.2 GHz band.....	10-82
Frequency range 5.4 GHz band.....	10-84
Frequency range 5.8 GHz band.....	10-90
FCC specific information	10-95
FCC compliance testing	10-95
FCC IDs	10-95
FCC approved antenna list	10-101
Innovation Science and Economic Development Canada (ISED) specific information	10-105
900 MHz ISED notification.....	10-105
4.9 GHz ISED notification	10-105
Utilisation de la bande 4.9 GHz FCC et ISED	10-105
5.2 GHz and 5.4 GHz ISED notification.....	10-105
Utilisation de la bande 5.2 and 5.4 GHz ISED.....	10-106
ISED notification 5.8 GHz	10-106
Utilisation de la bande 5.8 GHz ISED	10-106
ISED certification numbers	10-107
Canada approved antenna list	10-107
Chapter 11: Troubleshooting.....	11-1
General troubleshooting procedure.....	11-2
General planning for troubleshooting.....	11-2
General fault isolation process	11-3
Secondary Steps	11-4
Troubleshooting procedures.....	11-5
Module has lost or does not establish connectivity	11-5
NAT/DHCP-configured SM has lost or does not establish connectivity	11-7
SM Does Not Register to an AP	11-9
Module has lost or does not gain sync	11-10
Module does not establish Ethernet connectivity.....	11-11
CMM4 does not pass proper GPS sync to connected modules.....	11-12
Module Software Cannot be Upgraded	11-13
Module Functions Properly, Except Web Interface Became Inaccessible	11-13
Power-up troubleshooting	11-14
Registration and connectivity troubleshooting.....	11-15
SM/BMS Registration.....	11-15
Logs.....	11-16
Persistent Logging	11-16
Appendix A - 450m Reference information	I

A.1 Specifications..... |
A.2 450m overload |
Glossary |||

List of Figures

Figure 1 PMP/PTP 450 Platform Family typical bridge deployment.....	1-14
Figure 2 TDD frame division.....	1-17
Figure 3 PMP 450m Series interfaces.....	2-7
Figure 4 PMP/PTP 450i interfaces.....	2-8
Figure 5 PMP 450b Series - SM interfaces.....	2-9
Figure 6 PMP 450b Series - SM interfaces (High Gain).....	2-10
Figure 7 PMP/PTP 450 Series - AP interfaces.....	2-11
Figure 8 PMP/PTP 450 Series – SM/BH interfaces.....	2-12
Figure 9 PMP/PTP 450 Series – SM/BH Connectorized interfaces.....	2-13
Figure 10 PMP 450d Series - SM Integrated Dish.....	2-14
Figure 11 PMP 450 Series – SM 3 GHz Integrated.....	2-14
Figure 12 PTP 450 Series – BHM/BHS.....	2-14
Figure 13 AP/BHM diagnostic LEDs, viewed from unit front.....	2-16
Figure 14 AP/BH diagnostic LEDs, viewed from unit front.....	2-18
Figure 15 AC Power Injector interfaces.....	2-22
Figure 16 AC+DC Enhanced Power Injector interfaces.....	2-23
Figure 17 -48 V DC Power Injector interfaces.....	2-25
Figure 18 -20 to 32 VDC Power Injector interfaces.....	2-26
Figure 19 Gigabit Enet Capable power supply.....	2-28
Figure 20 PMP 450m Series - AP rear interfaces.....	2-30
Figure 21 PMP/PTP 450i Series - ODU rear interfaces.....	2-31
Figure 22 PMP/PTP 450i Series – Connectorized ODU antenna interfaces.....	2-32
Figure 23 PMP 450b SM (Mid Gain) - ODU rear interfaces.....	2-33
Figure 24 PMP 450b SM (High Gain) - ODU rear interfaces.....	2-34
Figure 25 Outdoor drop cable.....	2-36
Figure 26 Optical SFP transceiver module.....	2-38
Figure 27 Long cable gland.....	2-38
Figure 28 Alignment Tone Cable.....	2-40
Figure 29 RJ12 Alignment Tone Cable.....	2-41
Figure 30 Cable gland (part number #N000065L033).....	2-42
Figure 31 Cable grounding kit.....	2-44
Figure 32 UGPS.....	2-47
Figure 33 Cluster Management: Scenario 1.....	2-49
Figure 34 Cluster Management: Scenario 2.....	2-50
Figure 35 Controller Module.....	2-50
Figure 36 Injector Module.....	2-51
Figure 37 CMM4 (Rack Mount).....	2-53
Figure 38 CMM4 56 V power adapter (dongle).....	2-54
Figure 39 CMM4 power adapter cabling diagram.....	2-54

Figure 40 CMM4 (Cabinet with switch)	2-56
Figure 41 CMM3	2-58
Figure 42 Pole mounted CMM3	2-58
Figure 43 GPS antenna mounting	2-60
Figure 44 Mast or tower installation.....	3-2
Figure 45 Wall installation	3-3
Figure 46 Roof installation.....	3-4
Figure 47 GPS receiver wall installation	3-5
Figure 48 GPS receiver tower or mast installation	3-6
Figure 49 Rolling sphere method to determine the lightning protection zones	3-9
Figure 50 Example layout of 16 Access Point sectors (ABCD), 90-degree sectors.....	3-20
Figure 51 Example layout of 6 Access Point sectors (ABC), 60-degree sectors	3-21
Figure 52 Reflection	3-23
Figure 53 Sector Antenna	3-24
Figure 54 cnMedusa Antenna	3-25
Figure 55 PMP 450m Series AP antenna beam	3-26
Figure 56 Determinants in Rx signal level	3-28
Figure 57 Cambium networks management domain	3-33
Figure 58 Example of IP address in Class B subnet	3-35
Figure 59 Categorical protocol filtering.....	3-46
Figure 60 Remote AP deployment.....	3-51
Figure 61 Example for 900-MHz remote AP behind 5 GHz SM	3-53
Figure 62 Remote AP wired to SM that also serves a customer.....	3-54
Figure 63 Remote AP wired to SM that serves as a relay	3-55
Figure 64 Additional link to extend network sync, Design 3	3-56
Figure 65 Additional link to extend network sync, Design 4	3-57
Figure 66 Additional link to extend network sync, Design 5	3-58
Figure 67 Co-located AP or BH timing master Sync Setting configuration	3-59
Figure 68 Pin 1 location	5-11
Figure 69 Straight-through Ethernet Cable.....	5-13
Figure 70 Crossover Ethernet Cable	5-13
Figure 71 AP/BHM to UGPS cable	5-15
Figure 72 Alignment tone cable pin configuration	5-16
Figure 73 RJ-12 pinout for the default plug	5-16
Figure 74 PMP 450 900 MHz SM grounding	6-6
Figure 75 Gigabit Ethernet Surge Suppressor	6-13
Figure 76 600SSH Surge Suppressor – inside.....	6-14
Figure 77 Grounding cable minimum bend radius and angle	6-16
Figure 78 Grounding and lightning protection on wall	6-18
Figure 79 Grounding and lightning protection on mast or tower	6-20
Figure 80 Grounding and lightning protection on building	6-21
Figure 81 RJ45 cable	6-23
Figure 82 AP antenna parts	6-28

Figure 83 Antenna top plate	6-29
Figure 84 Attaching antenna plate to the AP	6-29
Figure 85 Attaching the plate	6-30
Figure 86 Connect the port A and B to the PMP 450i AP	6-30
Figure 87 AP antenna upper bracket assembly	6-31
Figure 88 AP antenna upper bracket attached to upper adjustment arms	6-31
Figure 89 Rear strap connected to upper AP antenna bracket.....	6-32
Figure 90 Assembled upper bracket connected to AP antenna	6-32
Figure 91 AP Antenna Lower Bracket Assembly	6-32
Figure 92 Lower bracket attached to AP antenna	6-33
Figure 93 Completed AP and antenna assembly	6-33
Figure 94 PMP 450 AP antenna parts	6-34
Figure 95 AP antenna upper bracket assembly	6-35
Figure 96 AP antenna upper bracket attached to upper adjustment arms	6-35
Figure 97 Rear strap connected to upper AP antenna bracket.....	6-36
Figure 98 Assembled upper bracket connected to AP antenna	6-36
Figure 99 AP Antenna Lower Bracket Assembly	6-37
Figure 100 Lower bracket attached to AP antenna	6-37
Figure 101 Attaching bracket to the rear of the AP	6-38
Figure 102 Lower bracket attached to AP antenna	6-38
Figure 103 Mounted PMP 450 AP and antenna assembly, viewed from back and back.....	6-39
Figure 104 Attaching the AP antenna upper bracket to the pole.....	6-40
Figure 105 Attaching the AP antenna lower bracket to the pole	6-40
Figure 106 Variables for calculating angle of elevation (and depression).....	6-42
Figure 107 PMP 450i AP 900 MHz antenna unbox view	6-43
Figure 108 PMP 450i AP 900 MHz antenna inventory	6-43
Figure 109 Attaching radio mounting PMP 450i AP 900 MHz antenna to the pole.....	6-48
Figure 110 900 MHz sector antenna alignment	6-49
Figure 111 PMP 450i SM 900 MHz external directional antenna	6-50
Figure 112 Attach the antenna to the pole.....	6-50
Figure 113 Fixing the nuts	6-51
Figure 114 Fixing the radio to the antenna.....	6-52
Figure 115 Connecting RF cable to the radio.....	6-52
Figure 116 Yagi antenna alignment - horizontally	6-53
Figure 117 Yagi antenna alignment - upward tilt.....	6-53
Figure 118 Yagi antenna alignment - downward tilt.....	6-53
Figure 119 PMP 450m Series - AP unbox view.....	6-54
Figure 120 Fixing the mounting plate to the back of the ODU.....	6-57
Figure 121 Attaching the bracket body	6-57
Figure 122 Ethernet cable gland for PMP/PTP 450 Series	6-59
Figure 123 Ethernet cable gland for PMP/PTP 450i Series	6-59
Figure 124 Disarm Installation page (top and bottom of page shown)	7-12
Figure 125 Regional Settings tab of AP/BHM	7-13

Figure 126 Radio Carrier Frequency tab of AP/BHM.....	7-14
Figure 127 Synchronization tab of AP/BHM.....	7-15
Figure 128 LAN IP Address tab of the AP/BHM	7-16
Figure 129 Review and Save Configuration tab of the AP/BHM.....	7-17
Figure 130 Time tab of the AP/BHM	7-18
Figure 131 Time and date entry formats.....	7-19
Figure 132 Session Status tab of AP	7-21
Figure 133 NAT disabled implementation	7-29
Figure 134 NAT with DHCP client and DHCP server implementation	7-30
Figure 135 NAT with DHCP client implementation	7-30
Figure 136 NAT with DHCP server implementation.....	7-31
Figure 137 NAT without DHCP implementation.....	7-31
Figure 138 General page attributes - PMP 450 AP	7-89
Figure 139 General page attributes - PMP 450 SM	7-90
Figure 140 General page attributes - PTP 450 BHM.....	7-91
Figure 141 General page attributes - PTP 450 BHS.....	7-92
Figure 142 Sync Setting configuration.....	7-99
Figure 143 AP Evaluation Configuration parameter of Security tab for PMP.....	7-104
Figure 144 BHM Evaluation Configuration parameter of Security tab for PTP	7-104
Figure 145 RF Telnet Access Restrictions (orange) and Flow through (green)	7-111
Figure 146 RF Telnet Access Restriction (orange) and Potential Security Hole (green).....	7-112
Figure 147 PMP 450i AP Radio attributes - 3 GHz	7-134
Figure 148 PMP 450i SM Radio attributes - 3 GHz	7-140
Figure 149 Multicast VC statistics	7-173
Figure 150 Multicast scheduler statistics	7-173
Figure 151 AP DFS Status.....	7-177
Figure 152 AP Session Status page.....	7-197
Figure 153 AP Remote Subscribers page.....	7-197
Figure 154 Session Status page.....	7-198
Figure 155 Exporting Session Status page of PMP 450m AP	7-200
Figure 156 Uplink and downlink rate caps adjusted to apply aggregate cap.....	7-202
Figure 157 Uplink and downlink rate cap adjustment example.....	7-202
Figure 158 Installation Color Code of AP	7-214
Figure 159 Configuration File upload and download page.....	7-221
Figure 160 Software Upgrade from cnMaestro™	7-224
Figure 161 DNS Test for cnMaestro™ connectivity	7-225
Figure 162 Device Agent Logs	7-226
Figure 163 Example cnMaestro™ screenshot	7-227
Figure 164 SM Certificate Management.....	7-241
Figure 165 User Authentication and Access Tracking tab of the SM	7-252
Figure 166 RADIUS accounting messages configuration.....	7-256
Figure 167 Device re-authentication configuration.....	7-257
Figure 168 RADIUS CoA configuration for AP.....	7-258

Figure 169 EAPPEAP settings.....	7-259
Figure 170 Importing certificate in NPS	7-260
Figure 171 Selecting MD5 from NPS console.....	7-261
Figure 172 User configuration.....	7-261
Figure 173 RADIUS VSA configuration	7-262
Figure 174 Adding RADIUS client.....	7-263
Figure 175 Creating users.....	7-263
Figure 176 Creating RADIUS instance.....	7-264
Figure 177 RADIUS protocols	7-264
Figure 178 Service selection	7-265
Figure 179 Adding Trusted CA.....	7-265
Figure 180 Installing Server Certificate	7-265
Figure 181 Monitoring logs	7-266
Figure 182 VSA list.....	7-267
Figure 183 Spectrum analysis - Results	8-3
Figure 184 Spectrum Analyzer page result – PMP 450 SM	8-11
Figure 185 Alignment Tool tab of SM – Receive Power Level > -70 dBm.....	8-15
Figure 186 Alignment Tool tab of SM – Receive Power Level between -70 to -80 dBm	8-15
Figure 187 Alignment Tool tab of SM – Receive Power Level < -80 dBm.....	8-15
Figure 188 PMP/PTP 450i Series link alignment tone	8-20
Figure 189 Link Capacity Test – PMP 450m Series AP	8-23
Figure 190 Link Test with Multiple VCs (1518-byte packet length).....	8-25
Figure 191 Link Capacity Test – PMP 450/450i Series AP	8-25
Figure 192 Link Test without Bridging (1714-byte packet length)	8-26
Figure 193 Extrapolated Link Test results.....	8-28
Figure 194 SM Configuration page of AP	8-45
Figure 195 BER Results tab of the SM.....	8-51
Figure 196 Sessions tab of the AP	8-52
Figure 197 Ping Test tab of the AP	8-53
Figure 198 Remote Subscribers page of AP.....	9-29
Figure 199 Event log data.....	9-30
Figure 200 Network Interface tab of the AP	9-32
Figure 201 Network Interface tab of the SM	9-32
Figure 202 Layer 2 Neighbors page.....	9-33
Figure 203 Bridging Table page.....	9-38
Figure 204 Translation Table page of SM	9-39
Figure 205 ARP page of the SM	9-15
Figure 206 Recovery Options page.....	9-40
Figure 207 SM Logs	11-16
Figure 208 SM Session log.....	11-16
Figure 209 SM Authentication log	11-16
Figure 210 SM Authorization log	11-17

List of Tables

Table 1 Main characteristics of the PMP 450m Series AP	1-3
Table 2 PMP 450m Series hardware configurations	1-4
Table 3 Main characteristics of the PMP/PTP 450i Series.....	1-5
Table 4 PMP/PTP 450i Series hardware configurations.....	1-6
Table 5 Main characteristics of the PMP 450b Series	1-8
Table 6 PMP 450b Series hardware configurations	1-9
Table 7 Main characteristics of the PMP/PTP 450 Series.....	1-11
Table 8 PMP/PTP 450 Series hardware configurations.....	1-12
Table 9 Supported Interoperability for PMP	1-13
Table 10 Supported Interoperability for PTP	1-13
Table 11 Modulation levels	1-19
Table 12 PMP 450m Series variants	2-2
Table 13 PMP 450i Series variants.....	2-3
Table 14 PMP 450b Series variants	2-3
Table 15 PMP 450 Series variants.....	2-4
Table 16 PTP 450i Series variants.....	2-5
Table 17 PTP 450 Series variants.....	2-6
Table 18 PMP 450m Series AP interface descriptions and cabling	2-7
Table 19 PMP/PTP 450i Series - AP/SM/BH interface descriptions and cabling	2-9
Table 20 PMP 450b Series - SM (Mid Gain) interface descriptions and cabling	2-10
Table 21 PMP 450b Series - SM (High Gain) interface descriptions and cabling.....	2-10
Table 22 PMP/PTP 450 Series - AP interface descriptions and cabling – 2.4 GHz and 5 GHz	2-11
Table 23 AP/BHM LED descriptions.....	2-17
Table 24 SM/BHS LED descriptions.....	2-19
Table 25 PSU part numbers for PMP 450m AP	2-20
Table 26 PSU part numbers for PMP/PTP 450i Series	2-21
Table 27 AC Power Injector interface functions	2-22
Table 28 AC+DC Enhanced Power Injector interface functions	2-24
Table 29 -48V DC Power Injector interfaces.....	2-25
Table 30 -Power Injector interfaces	2-26
Table 31 PSU part numbers for PMP 450b SM.....	2-26
Table 32 PSU part numbers for PMP/PTP 450 Series	2-27
Table 33 –Gigabit Enet Capable power supply	2-27
Table 34 Accessories part numbers	2-29
Table 35 Lightning protection part numbers	2-29
Table 36 PMP 450m Series – AP rear interfaces.....	2-30
Table 37 PMP/PTP 450i Series – ODU rear interfaces	2-31
Table 38 PMP 450b SM (Mid Gain) – ODU rear interfaces	2-33
Table 39 PMP 450b SM (High Gain) – ODU rear interfaces.....	2-34

Table 40 PSU drop cable length restrictions	2-35
Table 41 Drop cable part numbers	2-36
Table 42 SFP module kit part numbers	2-37
Table 43 Single Mode Optical SFP Interface per ODU (part number C000065L008)	2-37
Table 44 Multi-mode Optical SFP Interface per ODU (part number C000065L009)	2-37
Table 45 Main port PoE cable pinout	2-39
Table 46 Aux port PoE cable pinout	2-39
Table 47 Aux port PoE cable pinout	2-40
Table 48 RJ12 Aux port PoE cable pinout.....	2-41
Table 49 Alignment tone adapter third party product details.....	2-41
Table 50 RJ45 connector and spare gland part numbers.....	2-42
Table 51 LPU and grounding kit contents.....	2-43
Table 52 LPU and grounding kit part number	2-44
Table 53 Cable grounding kit part numbers	2-44
Table 54 List of AP external antennas	2-45
Table 55 PTP 450i Series BH or PMP 450/450i Series SM external antenna.....	2-45
Table 56 RF cable and connector part numbers.....	2-46
Table 57 CMM5 Cluster Management Scenario 1.....	2-48
Table 58 CMM5 Cluster Management Scenario 2.....	2-49
Table 59 Injector Compatibility Matrix	2-51
Table 60 CMM5 Specifications.....	2-52
Table 61 CMM4 power adapter cable pinout.....	2-55
Table 62 PMP 450m Series ODU part numbers.....	2-62
Table 63 PMP 450i Series ODU part numbers	2-62
Table 64 PMP 450i ATEX/HAZLOC ODU models/part numbers.....	2-63
Table 65 PTP 450i Series ODU part numbers	2-64
Table 66 PTP 450i ATEX/HAZLOC ODU models/part numbers.....	2-65
Table 67 PMP 450b Series ODU part numbers.....	2-65
Table 68 PMP 450 Series ODU part numbers	2-66
Table 69 PTP 450 Series ODU part numbers	2-68
Table 70 PMP/PTP 450/450i Series Accessories	2-68
Table 71 PMP 450m Series wind loading (Newton).....	3-12
Table 72 PMP/PTP 450i Series wind loading (Newton)	3-12
Table 73 PMP 450m Series wind loading (lb force)	3-12
Table 74 PMP/PTP 450i Series wind loading (lb force)	3-13
Table 75 PMP/PTP 450 Series wind loading (Newton)	3-13
Table 76 PMP/PTP 450 Series wind loading (lb force)	3-14
Table 77 EIRP limits from ATEX and HAZLOC standards.....	3-15
Table 78 Example 5.8 GHz 4-channel assignment by access site.....	3-20
Table 79 Example 5.8 GHz 3-channel assignment by access site.....	3-21
Table 80 RF cable lengths required to achieve 1.2 dB loss at 5.8 GHz.....	3-31
Table 81 Special case VLAN IDs	3-37
Table 82 VLAN filters in point-to-multipoint modules.....	3-38

Table 83 Q-in-Q Ethernet frame	3-39
Table 84 HTTPS security material.....	3-42
Table 85 Ports filtered per protocol selections	3-47
Table 86 Device default port numbers	3-47
Table 87 Safety compliance specifications	4-22
Table 88 EMC emissions compliance.....	4-22
Table 89 FCC minimum safe distances – PMP 450m 5.1 GHz, 5.2 GHz, 5.4 GHz and 5.8 GHz	4-25
Table 90 FCC minimum safe distances – PMP/PTP 450i 900 MHz, 3.65 GHz, 4.9 GHz, 5.1 GHz, 5.2 GHz, 5.4 GHz and 5.8 GHz	4-27
Table 91 ISEDC minimum safe distances – PMP/PTP 450i, 900 MHz, 3.5 GHz, 3.65 GHz, 4.9 GHz, 5.2 GHz, 5.4 GHz, and 5.8 GHz	4-28
Table 92 FCC minimum safe distances – PMP/PTP 450 900 MHz, 2.4 GHz, 3.65 GHz and 5 GHz ...	4-30
Table 93 ISEDC minimum safe distances – PMP/PTP 450 900 MHz, 2.4 GHz, 3.5/3.65 GHz and 5 GHz	4-31
Table 94 Radio certifications	4-36
Table 95 Tools for PMP and PTP 450 Platform ODU installation.....	5-9
Table 96 Main port pinout	5-12
Table 97 Aux port pinout.....	5-12
Table 98 RJ-45 pinout for straight-through Ethernet cable.....	5-13
Table 99 RJ-45 pinout for crossover Ethernet cable	5-14
Table 100 AP/BHM to UGPS cable pinout.....	5-15
Table 101 PMP/PTP 450i Series - ODU mounting bracket part numbers.....	6-2
Table 102 RJ45 connector and cable color code.....	6-23
Table 103 Menu options and web pages	7-7
Table 104 Session Status Attributes – AP.....	7-22
Table 105 IP interface attributes	7-25
Table 106 SM/BHS private IP and LUID.....	7-26
Table 107 Aux port attributes.....	7-27
Table 108 IP attributes - SM with NAT disabled.....	7-33
Table 109 IP attributes - SM with NAT enabled.....	7-35
Table 110 NAT attributes - SM with NAT disabled	7-36
Table 111 NAT attributes - SM with NAT enabled	7-39
Table 112 SM DNS Options with NAT Enabled.....	7-44
Table 113 NAT Port Mapping attributes - SM.....	7-44
Table 114 VLAN Remarking Example.....	7-46
Table 115 AP/BHM VLAN tab attributes	7-48
Table 116 Q-in-Q Ethernet frame	7-49
Table 117 SM VLAN attributes.....	7-51
Table 118 SM VLAN Membership attributes	7-55
Table 119 BHM VLAN page attributs.....	7-55
Table 120 BHS VLAN page attributes.....	7-58
Table 121 SM PPPoE attributes.....	7-60
Table 122 DiffServ attributes – AP/BHM.....	7-62
Table 123 Packet Filter Configuration attributes	7-64

Table 124 General page attributes – PMP 450i AP	7-70
Table 125 General page attributes –PMP 450m AP.....	7-75
Table 126 General page attributes – PMP 450i SM	7-77
Table 127 General page attributes – PTP 450i BHM.....	7-80
Table 128 General page attributes – PTP 450i BHS.....	7-82
Table 129 General page attributes – PMP 450b SM.....	7-85
Table 130 Unit Settings attributes – 450 Platform Family AP/BHM.....	7-94
Table 131 SM Unit Settings attributes	7-96
Table 132 450 Platform Family - AP/BHM Time attributes	7-97
Table 133 Add User page of account page - AP/ SM/BH.....	7-102
Table 134 Delete User page - 450 Platform Family - AP/ SM/BH.....	7-103
Table 135 Change User Setting page - 450 Platform Family AP/ SM/BH.....	7-103
Table 136 User page –450 Platform Family AP/SM/BH.....	7-104
Table 137 AP/BHM Protocol Filtering attributes.....	7-107
Table 138 SM/BHS Protocol Filtering attributes.....	7-109
Table 139 Port Configuration attributes – AP/SM/BHM/BMS.....	7-110
Table 140 Security attributes –450 Platform Family AP.....	7-116
Table 141 Security attributes –450 Platform Family SM.....	7-121
Table 142 Security attributes - 450 Platform Family BHS.....	7-126
Table 143 PMP 450m AP Radio attributes - 5 GHz	7-129
Table 144 PMP 450i AP Radio attributes - 5 GHz.....	7-135
Table 145 PMP 450i SM Radio attributes – 5 GHz.....	7-141
Table 146 PMP 450i AP Radio attributes - 900 MHz	7-145
Table 147 PTP 450i BHM Radio page attributes – 5 GHz	7-147
Table 148 PTP 450i BHS Radio attributes – 5 GHz.....	7-150
Table 149 PMP 450b SM Radio attributes – 5 GHz.....	7-153
Table 150 PMP 450 AP Radio attributes - 5 GHz.....	7-157
Table 151 PMP 450 AP Radio attributes - 3.65 GHz.....	7-159
Table 152 PMP 450 AP Radio attributes - 3.5 GHz.....	7-160
Table 153 PMP 450 AP Radio attributes - 2.4 GHz.....	7-161
Table 154 PMP 450 SM Radio attributes – 5 GHz.....	7-162
Table 155 PMP 450 SM Radio attributes – 3.65 GHz.....	7-164
Table 156 PMP 450 SM Radio attributes – 3.5 GHz	7-165
Table 157 PMP 450 SM Radio attributes – 2.4 GHz.....	7-166
Table 158 PMP 450 SM Radio attributes –900 MHz	7-167
Table 159 PTP 450 BHM Radio attributes –5 GHz.....	7-169
Table 160 PTP 450 BHM Radio attributes –5 GHz.....	7-170
Table 161 Example for mix of multicast and unicast traffic scenarios.....	7-172
Table 162 450 Platform Family AP/SM/BH Custom Frequencies page – 5 GHz.....	7-174
Table 163 PMP/PTP 450 SM/BH Custom Frequencies page – 3.65 GHz.....	7-175
Table 164 PMP/PTP 450 SM/BH Custom Frequencies page – 3.5 GHz	7-176
Table 165 Contention slots and number of SMs.....	7-178
Table 166 450 Platform Family Modulation levels	7-179

Table 167 Co-channel Interference per (CCI) MCS.....	7-180
Table 168 Adjacent Channel Interference (ACI) per MCS.....	7-180
Table 169 LAN1 Network Interface Configuration tab of IP page attributes.....	7-183
Table 170 SNMP page attributes	7-185
Table 171 Syslog parameters.....	7-192
Table 172 Syslog Configuration attributes - AP	7-193
Table 173 Syslog Configuration attributes - SM	7-194
Table 174 Syslog Configuration attributes - BHS.....	7-195
Table 175 Characteristics of traffic scheduling.....	7-205
Table 176 Recommended combined settings for typical operations.....	7-206
Table 177 Where feature values are obtained for a SM with authentication required.....	7-207
Table 178 MIR, VLAN, HPC, and CIR Configuration Sources, Authentication Disabled	7-207
Table 179 QoS page attributes - AP.....	7-208
Table 180 QoS page attributes - SM.....	7-210
Table 181 QoS page attributes - BHM	7-212
Table 182 QoS page attributes - BHS	7-213
Table 183 Configuring cnMaestro	7-223
Table 184 Security tab attributes	7-231
Table 185 SM Security tab attributes	7-235
Table 186 RADIUS Vendor Specific Attributes (VSAs)	7-244
Table 187 AP User Authentication and Access Tracking attributes.....	7-250
Table 188 SM User Authentication and Access Tracking attributes.....	7-252
Table 189 Device data accounting RADIUS attributes	7-253
Table 190 Ping Watchdog attributes	7-270
Table 191 Spectrum Analyzer page attributes - AP	8-5
Table 192 Spectrum Analyzer page attributes - SM	8-7
Table 193 Spectrum Analyzer page attributes - BHM.....	8-8
Table 194 Spectrum Analyzer page attributes - BHS.....	8-9
Table 195 Remote Spectrum Analyzer attributes - AP.....	8-13
Table 196 Remote Spectrum Analyzer attributes - BHM.....	8-14
Table 197 Aiming page attributes – SM.....	8-17
Table 198 Aiming page attributes - BHS.....	8-19
Table 199 Alignment Tool Headsets and Alignment tone adapter third party product details	8-21
Table 200 Link Capacity Test page attributes – AP	8-29
Table 201 Link Capacity Test page attributes – BHM/BHS	8-31
Table 202 AP Evaluation tab attributes - AP	8-32
Table 203 BHM Evaluation tab attributes - BHS.....	8-36
Table 204 OFDM Frame Calculator page attributes	8-41
Table 205 OFDM Calculated Frame Results attributes	8-42
Table 206 Color code versus uplink/downlink rate column	8-46
Table 207 Link Status page attributes – AP/BHM	8-47
Table 208 Link Status page attributes – SM/BHS	8-49
Table 209 General Status page attributes – PMP 450m AP.....	9-3

Table 210 General Status page attributes – PMP 450/450i AP	9-8
Table 211 General Status page attributes - SM.....	9-11
Table 212 General Status page attributes - BHM	9-15
Table 213 General Status page attributes - BHS	9-18
Table 214 Device tab attributes.....	9-20
Table 215 Session tab attributes.....	9-21
Table 216 Power tab attributes	9-23
Table 217 Configuration tab attributes.....	9-25
Table 218 Session Status > Configuration CIR configuration denotations.....	9-27
Table 219 Link Quality tab attributes.....	9-28
Table 220 Event Log messages for abnormal events	9-31
Table 221 Event Log messages for normal events	9-31
Table 222 Scheduler tab attributes.....	9-34
Table 223 SM Registration Failures page attributes - AP	9-36
Table 224 BHS Registration Failures page attributes - BHM.....	9-37
Table 225 Flags status.....	9-37
Table 226 Ethernet tab attributes.....	9-39
Table 227 Radio (Statistics) page attributes – RF Control Block	9-42
Table 228 Radio (Statistics - AP) page attributes - Sounding	9-1
Table 229 Radio (Statistics - SM) page attributes - Sounding	9-1
Table 230 VLAN page attributes	9-2
Table 231 Data VC page attributes	9-3
Table 232 MIR/Burst page attributes for AP.....	9-5
Table 233 MIR/Burst page attributes for SM.....	9-6
Table 234 RF overload Configuration attributes – AP/BHM	9-8
Table 235 Overload page attributes – AP/SM/BHM/BHS	9-11
Table 236 DHCP Relay page attributes – AP/SM	9-13
Table 237 Filter page attributes - SM	9-14
Table 238 NAT page attributes - SM	9-16
Table 239 NAT DHCP Statistics page attributes - SM	9-17
Table 240 Sync Status page attributes - AP.....	9-18
Table 241 PPPoE Statistics page attributes - SM	9-19
Table 242 Bridge Control Block page attributes – AP/SM/BHM/BHS	9-21
Table 243 Pass Through Statistics page attributes – AP	9-24
Table 244 SNMPv3 Statistics page attributes – AP	9-25
Table 245 Syslog statistics page attributes – AP/SM/BH	9-27
Table 246 Frame utilization statistics for PMP 450m AP	9-28
Table 247 Frame utilization statistics for 450/450i/450m	9-36
Table 248 Recovery Options attributes	9-40
Table 249 PMP 450m Series - AP specifications	10-2
Table 250 PMP 450i Series - AP specifications.....	10-6
Table 251 PMP 450i Series - SM specifications.....	10-12
Table 252 PTP 450i Series - BH specifications.....	10-17

Table 253 PMP 450b Series - SM (High Gain) specifications	10-21
Table 254 PMP 450b Series - SM (High Gain) specifications	10-26
Table 255 PMP 450 Series - AP specifications	10-30
Table 256 PMP 450 Series - SM specifications	10-35
Table 257 PTP 450 Series - BH specifications	10-40
Table 258 PMP/PTP 450i AC power Injector specifications	10-45
Table 259 PMP/PTP 450 power supply specifications (part number: N000900L001A)	10-46
Table 260 450m/450i Series Main and Aux Ethernet bridging specifications	10-47
Table 261 450 Series Ethernet bridging specifications	10-47
Table 262 450 Platform Family - wireless specifications	10-48
Table 263 Radio certifications	10-50
Table 264 Country & Bands DFS setting	10-52
Table 265 Default combined transmit power per country – 900 MHz band PMP 450i Series	10-55
Table 266 Default combined transmit power per country – 2.4 GHz band PMP/PTP 450 Series..	10-56
Table 267 Default combined transmit power per country – 3.5 GHz band PMP/PTP 450 Series..	10-57
Table 268 Default combined transmit power per country – 3.65 GHz band PMP/PTP 450	10-58
Table 269 Default combined transmit power per country – 4.9 GHz band PMP/PTP 450i Series.	10-58
Table 270 Default combined transmit power per country – 4.9 GHz band PMP 450b Series	10-59
Table 271 Default combined transmit power per Country – 5.1 GHz band PMP/PTP 450i Series	10-60
Table 272 Default combined transmit power per country – 5.1 GHz band PMP 450b Series	10-61
Table 273 Default combined transmit power per Country – 5.1 GHz band PMP 450m Series	10-62
Table 274 Default combined transmit power per country – 5.2 GHz band PMP/PTP 450i Series.	10-63
Table 275 Default combined transmit power per country – 5.2 GHz band PMP 450b Series	10-64
Table 276 Default combined transmit power per Country – 5.2 GHz band PMP 450m Series	10-65
Table 277 Default combined transmit power per country – 5.4 GHz band PMP 450m Series	10-66
Table 278 Default combined transmit power per country – 5.4 GHz band PMP/PTP 450i Series.	10-67
Table 279 Default combined transmit power per country – 5.4 GHz band PMP 450b Series	10-69
Table 280 Default combined transmit power per country – 5.4 GHz band PMP 450 Series	10-70
Table 281 Default combined transmit power per Country – 5.8 GHz band PMP 450m Series	10-71
Table 282 Default combined transmit power per country – 5.8 GHz band PMP/PTP 450i Series.	10-72
Table 283 Default combined transmit power per country – 5.8 GHz band PMP 450b Series	10-72
Table 284 Default combined transmit power per country – 5.8 GHz band PMP 450 Series	10-73
Table 285 Frequency range per country – 900 MHz band	10-75
Table 286 Frequency range per country – 2.4 GHz band PMP/PTP 450 Series.....	10-76
Table 287 Frequency range per country – 3.5 GHz band PMP/PTP 450/450i Series.....	10-76
Table 288 Frequency range per country – 3.65 GHz band PMP/PTP 450/450i Series.....	10-77
Table 289 Frequency range per country – 4.9 GHz band PMP/PTP 450i/450b Series	10-78
Table 290 Frequency range per country – 4.9 GHz band PMP 450b Series	10-78
Table 291 Frequency range per country – 5.1 GHz band PMP/PTP 450i Series.....	10-79
Table 292 Frequency range per country – 5.1 GHz band PMP 450b Series	10-80
Table 293 Frequency range per country – 5.1 GHz band PMP 450m Series.....	10-81
Table 294 Frequency range per country – 5.2 GHz band PMP/PTP 450i Series.....	10-82
Table 295 Frequency range per country – 5.2 GHz band PMP 450b Series	10-83

Table 296 Frequency range per country – 5.2 GHz band PMP 450m Series.....	10-83
Table 297 Frequency range per country – 5.4 GHz band PMP/PTP 450i Series.....	10-84
Table 298 Frequency range per country – 5.4 GHz band PMP 450b Series.....	10-85
Table 299 Frequency range per country – 5.4 GHz band PMP/PTP 450 Series.....	10-86
Table 300 Frequency range per country – 5.4 GHz band PMP 450m Series.....	10-89
Table 301 Frequency range per country – 5.8 GHz band PMP/PTP 450i Series.....	10-90
Table 302 Frequency range per country – 5.8 GHz band PMP 450b Series.....	10-91
Table 303 Frequency range per country – 5.8 GHz band PMP/PTP 450 Series.....	10-91
Table 304 Frequency range per country – 5.8 GHz band PMP 450m Series.....	10-94
Table 305 US FCC IDs	10-95
Table 306 USA approved antenna list 4.9 GHz.....	10-101
Table 307 USA approved antenna list 5.1 and 5.2 GHz	10-102
Table 308 USA approved antenna list 5.4 GHz.....	10-103
Table 309 USA approved antenna list 5.8 GHz.....	10-104
Table 310 ISED Certification Numbers.....	10-107
Table 311 Canada approved antenna list 4.9 and 5.8 GHz	10-108
Table 312 Canada approved antenna list 5.2 and 5.4 GHz	10-109

About This User Guide

This guide describes the planning, installation, configuration and operation of the Cambium point-to-point and point-to-multipoint wireless Ethernet bridges. It covers PMP/PTP 450, 450i, 450b, 450d and PMP 450m platform Series. It is intended for use by the system designer, system installer and system administrator.

For radio network design, refer to the following chapters:

- [Chapter 1: Product description](#)
- [Chapter 2: System hardware](#)
- [Chapter 3: System planning](#)
- [Chapter 4: Legal and regulatory information](#)
- [Chapter 5: Preparing for installation](#)
- [Chapter 6: Installation](#)

For system configuration, tools and troubleshooting, refer to the following chapters:

- [Chapter 7: Configuration](#)
- [Chapter 8: Tools](#)
- [Chapter 9: Operation](#)
- [Chapter 10: Reference information](#)
- [Chapter 11: Troubleshooting](#)

Contacting Cambium Networks

Support website:	https://support.cambiumnetworks.com
Main website:	http://www.cambiumnetworks.com
Sales enquiries:	solutions@cambiumnetworks.com
Support enquiries:	https://support.cambiumnetworks.com
Repair enquiries:	https://support.cambiumnetworks.com
Telephone number list:	http://www.cambiumnetworks.com/contact
Address:	Cambium Networks Limited, Global Headquarters, 3800 Golf Road, Suite 360, Rolling Meadows, IL 60008 USA

Purpose

Cambium Networks Point-to-Multi-Point (PMP)/Point-To-Point (PTP) 450 documents are intended to instruct and assist personnel in the operation, installation and maintenance of the Cambium PMP/PTP equipment and ancillary devices of 450 Platform Family. It is recommended that all personnel engaged in such activities be properly trained.

Cambium disclaims all liability whatsoever, implied or express, for any risk of damage, loss or reduction in system performance arising directly or indirectly out of the failure of the customer, or anyone acting on the customer's behalf, to abide by the instructions, system parameters, or recommendations made in this document.

Product notation conventions in document

This document covers Cambium 450 Series, 450i Series and 450m Series products. The following notation conventions are followed while referring to product series and product family:

Product notation	Description
<ul style="list-style-type: none">450 Platform Family	Refers to the complete 450 Series family, which includes 450 Series, 450i Series, 450b Series and 450m Series
<ul style="list-style-type: none">450 Series	Refers to 450 Series devices in the following configurations: <ul style="list-style-type: none">- PMP 450<ul style="list-style-type: none">- AP [2.4GHz/3.5 GHz/3.65 GHz /5 GHz]<ul style="list-style-type: none">- Connectorized- SM [900 MHz/2.4GHz/3.5 GHz/3.65 GHz /5 GHz]<ul style="list-style-type: none">- Connectorized/ Integrated- PTP 450 BHM/ BHS [900 MHz/3.5 GHz/3.65 GHz/5 GHz]<ul style="list-style-type: none">- Connectorized/ Integrated- PMP 450d SM [5 GHz]
<ul style="list-style-type: none">450i Series	Refers to 450i Series devices in the following configurations: <ul style="list-style-type: none">- PMP 450i<ul style="list-style-type: none">- AP [900 MHz/3 GHz/5 GHz]<ul style="list-style-type: none">- Connectorized/ Integrated- SM [3 GHz/5 GHz]<ul style="list-style-type: none">- Connectorized/ Integrated- PTP 450i BHM/ BHS [3 GHz/5 GHz]<ul style="list-style-type: none">- Connectorized/ Integrated
<ul style="list-style-type: none">450b Series	Refers to 450b Series devices in the following configurations: <ul style="list-style-type: none">- PMP 450b<ul style="list-style-type: none">- SM [5 GHz]<ul style="list-style-type: none">- Integrated

Product notation	Description
<ul style="list-style-type: none">450m Series	Refers to 450m Series device configuration: <ul style="list-style-type: none">- PMP 450m AP 5 GHz- Integrated

Cross references

References to external publications are shown in italics. Other cross references, emphasized in blue text in electronic versions, are active links to the references.

This document is divided into numbered chapters that are divided into sections. Sections are not numbered, but are individually named at the top of each page, and are listed in the table of contents.

Feedback

We appreciate feedback from the users of our documents. This includes feedback on the structure, content, accuracy, or completeness of our documents. To provide feedback, visit our support website. <https://support.cambiumnetworks.com>.

Important regulatory information

The 450 Platform Family products are certified as an unlicensed device in frequency bands where it is not allowed to cause interference to licensed services (called primary users of the bands).

Application software

Download the latest 450 Platform Family software and install it in the Outdoor Units (ODUs) before deploying the equipment. Instructions for installing software are provided in [Upgrading the software version and using CNUT](#) on page 7-66.

USA specific information



Caution

This device complies with Part 15 of the FCC Rules. Operation is subject to the following two conditions:

- This device may not cause harmful interference, and
 - This device must accept any interference received, including interference that may cause undesired operation
-

The USA Federal Communications Commission (FCC) requires manufacturers to implement special features to prevent interference to weather radar systems that operate in the band 5600 MHz to 5650 MHz. These features must be implemented in all products able to operate outdoors in the band 5470 MHz to 5725 MHz.

Manufacturers must ensure that such radio products cannot be configured to operate outside of FCC rules; specifically it must not be possible to disable or modify the radar protection functions that have been demonstrated to the FCC.

Cambium supplies variants of the 450i and 450m Series specifically for operation in the USA in order to comply with FCC requirements (KDB 905462 D02 UNII DFS Compliance Procedures New Rules v01r02). These variants are only allowed to operate with license keys that comply with FCC rules.

Similarly, Cambium supplies variants of the 450 Series specifically for operation in the USA in order to comply with FCC requirements (KDB 443999 D01 Approval of DFS UNII Devices v01r04). These variants are only allowed to operate with license keys that comply with FCC rules. To ensure compliance when using PMP 450 Series and PTP 450 Series, follow the recommendation in [Avoidance of weather radars \(USA only\)](#).

External antennas

When using a connectorized version of the product, the conducted transmit power may need to be reduced to ensure the regulatory limit on transmitter EIRP is not exceeded. The installer must have an understanding of how to compute the effective antenna gain from the actual antenna gain and the feeder cable losses.

The range of permissible values for maximum antenna gain and feeder cable losses are included in this user guide together with a sample calculation. The product GUI automatically applies the correct conducted power limit to ensure that it is not possible for the installation to exceed the EIRP limit, when the appropriate values for antenna gain and feeder cable losses are entered into the GUI.

Avoidance of weather radars (USA only)

To comply with FCC rules (KDB 443999: Interim Plans to Approve UNII Devices Operating in the 5470 - 5725 MHz Band with Radar Detection and DFS Capabilities), units which are installed within 35 km (22 miles) of a Terminal Doppler Weather Radar (TDWR) system (or have a line of sight propagation path to such a system) must be configured to avoid any frequency within +30 MHz or -30 MHz of the frequency of the TDWR device. This requirement applies even if the master is outside the 35 km (22 miles) radius but communicates with outdoor clients which may be within the 35 km (22 miles) radius of the TDWRs. If interference is not eliminated, a distance limitation based on line-of-sight from TDWR will need to be used. Devices with bandwidths greater than 20 MHz may require greater frequency separation.

When planning a link in the USA, visit <http://spectrumbridge.com/udia/home.aspx>, enter the location of the planned link and search for TDWR radars. If a TDWR system is located within 35 km (22 miles) or has line of sight propagation to the PTP device, perform the following tasks:

- Register the installation on <http://spectrumbridge.com/udia/home.aspx>.
- Make a list of channel center frequencies that must be barred, that is, those falling within +30 MHz or -30 MHz of the frequency of the TDWR radars.

The 450 Platform Family AP must be configured to not operate on the affected channels.

Canada specific information



Caution

This device complies with ISED's license-exempt RSSs. Operation is subject to the following two conditions:

- (1) This device may not cause interference; and
 - (2) This device must accept any interference, including interference that may cause undesired operation of the device.
-

ISED requires manufacturers to implement special features to prevent interference to weather radar systems that operate in the band 5600 MHz to 5650 MHz. These features must be implemented in all products able to operate outdoors in the band 5470 MHz to 5725 MHz.

Manufacturers must ensure that such radio products cannot be configured to operate outside of ISEDC rules; specifically it must not be possible to disable or modify the radar protection functions that have been demonstrated to ISEDC .

In order to comply with these ISEDC requirements, Cambium supplies variants of the 450 Platform Family for operation in Canada. These variants are only allowed to operate with license keys that comply with ISEDC rules. In particular, operation of radio channels overlapping the band 5600 MHz to 5650 MHz is not allowed and these channels are permanently barred.

In addition, other channels may also need to be barred when operating close to weather radar installations.

Other variants of the 450 Platform Family are available for use in the rest of the world, but these variants are not supplied to Canada except under strict controls, when they are needed for export and deployment outside Canada.

Renseignements spécifiques au Canada



Attention

Le présent appareil est conforme aux CNR d'Industrie Canada applicables aux appareils radio exempts de licence. L'exploitation est autorisée aux deux conditions suivantes :

- (1) l'appareil ne doit pas produire de brouillage, et
 - (2) l'utilisateur de l'appareil doit accepter tout brouillage radioélectrique subi, même si le brouillage est susceptible d'en compromettre le fonctionnement.
-

ISEDC a demandé aux fabricants de mettre en œuvre des mécanismes spécifiques pour éviter d'interférer avec des systèmes radar fonctionnant dans la bande 5600 MHz à 5650 MHz. Ces mécanismes doivent être mis en œuvre dans tous les produits capables de fonctionner à l'extérieur dans la bande 5470 MHz à 5725 MHz.

Les fabricants doivent s'assurer que les produits de radiocommunications ne peuvent pas être configurés pour fonctionner en dehors des règles ISEDC , en particulier, il ne doit pas être possible de désactiver ou modifier les fonctions de protection des radars qui ont été démontrés à ISEDC .

Afin de se conformer à ces exigences de ISEDC , Cambium fournit des variantes du 450 Platform Family exclusivement pour le Canada. Ces variantes ne permettent pas à l'équipement de fonctionner en dehors des règles de ISEDC . En particulier, le fonctionnement des canaux de radio qui chevauchent la bande 5600-5650 MHz est interdite et ces canaux sont définitivement exclus.

ISEDC Approved Antennas

The list of antennas used to obtain ISEDC approvals is provided in section [Country specific radio regulations, Innovation Science and Economic Development Canada \(ISEDC\) , Table 313.](#)

Antennas externes

Lorsque vous utilisez une version du produit sans antenne intégrée, il peut être nécessaire de réduire la puissance d'émission pour garantir que la limite réglementaire de puissance isotrope rayonnée équivalente (PIRE) n'est pas dépassée. L'installateur doit avoir une bonne compréhension de la façon de calculer le gain de l'antenne réelle et les pertes dans les câbles de connections.

La plage de valeurs admissibles pour un gain maximal de l'antenne et des pertes de câbles de connections sont inclus dans ce guide d'utilisation avec un exemple de calcul. L'interface utilisateur du produit applique automatiquement la limite de puissance menée correct afin de s'assurer qu'il ne soit pas possible pour l'installation de dépasser la limite PIRE, lorsque les valeurs appropriées pour le gain d'antenne et les pertes de câbles d'alimentation sont entrées dans l'interface utilisateur.

Antennes approuvées par ISEDC

La liste des antennes approuvées pour l'opération au Canada est fournie dans le chapitre [Country specific radio regulations, Innovation Science and Economic Development Canada \(ISEDC\)](#) tableaux [Table 313](#).

EU Declaration of Conformity

Hereby, Cambium Networks declares that the Cambium 450 Series, 450i Series and 450m Series Wireless Ethernet Bridge complies with the essential requirements and other relevant provisions of Directive 1999/5/EC. The declaration of conformity may be consulted at:

<http://www.cambiumnetworks.com/support/ec-doc>

Specific expertise and training for professional installers

To ensure that the 450 Platform Family products – PMP/PTP 450 Series, PMP/PTP 450i Series, PMP 450m Series are installed and configured in compliance with the requirements of ISEDC and the FCC, installers must have the radio engineering skills and training described in this section.

The Cambium Networks technical training program details can be accessed from below link:

<http://www.cambiumnetworks.com/training/category/technical-training/>

Ethernet networking skills

The installer must have the ability to configure IP addressing on a PC and to set up and control products using a web browser interface.

Lightning protection

To protect outdoor radio installations from the impact of lightning strikes, the installer must be familiar with the normal procedures for site selection, bonding and grounding. Installation guidelines for the 450 Platform Family can be found in [Chapter 2: System hardware](#) and [Chapter 3: System planning](#).

Training

The installer needs to have basic competence in radio and IP network installation. The specific requirements applicable to the 450 Platform should be gained by reading [Chapter 5: Preparing for installation](#), [Chapter 6: Installation](#), [Chapter 7: Configuration](#), [Chapter 8: Tools](#) and [Chapter 9: Operation](#); and by performing sample set ups at base workshop before live deployments.

The Cambium Networks technical training program details can be accessed from below link:
<http://www.cambiumnetworks.com/training/category/technical-training/>

Problems and warranty

Reporting problems

If any problems are encountered when installing or operating this equipment, follow this procedure to investigate and report:

- 1 Search this document and the software release notes of supported releases.
- 2 Visit the support website.
- 3 Ask for assistance from the Cambium product supplier.
- 4 Gather information from affected units, such as any available diagnostic downloads.
- 5 Escalate the problem by emailing or telephoning support.

Repair and service

If unit failure is suspected, obtain details of the Return Material Authorization (RMA) process from the support website (<http://www.cambiumnetworks.com/support>).

Hardware warranty

Cambium's standard hardware warranty is for one (1) year from date of shipment from Cambium Networks or a Cambium distributor. Cambium Networks warrants that hardware will conform to the relevant published specifications and will be free from material defects in material and workmanship under normal use and service. Cambium shall within this time, at its own option, either repair or replace the defective product within thirty (30) days of receipt of the defective product. Repaired or replaced product will be subject to the original warranty period but not less than thirty (30) days.

To register PMP and PTP products or activate warranties, visit the support website. For warranty assistance, contact the reseller or distributor. The removal of the tamper-evident seal will void the warranty.



Caution

Using non-Cambium parts for repair could damage the equipment or void warranty. Contact Cambium for service and repair instructions.

Portions of Cambium equipment may be damaged from exposure to electrostatic discharge. Use precautions to prevent damage.

Security advice

Cambium Networks systems and equipment provide security parameters that can be configured by the operator based on their particular operating environment. Cambium recommends setting and using these parameters following industry recognized security practices. Security aspects to be considered are protecting the confidentiality, integrity, and availability of information and assets. Assets include the ability to communicate, information about the nature of the communications, and information about the parties involved.

In certain instances Cambium makes specific recommendations regarding security practices, however the implementation of these recommendations and final responsibility for the security of the system lies with the operator of the system.

Warnings, cautions, and notes

The following describes how warnings and cautions are used in this document and in all documents of the Cambium Networks document set.

Warnings

Warnings precede instructions that contain potentially hazardous situations. Warnings are used to alert the reader to possible hazards that could cause loss of life or physical injury. A warning has the following format:



Warning

Warning text and consequence for not following the instructions in the warning.

Cautions

Cautions precede instructions and are used when there is a possibility of damage to systems, software, or individual items of equipment within a system. However, this damage presents no danger to personnel. A caution has the following format:



Caution

Caution text and consequence for not following the instructions in the caution.

Notes

A note means that there is a possibility of an undesirable situation or provides additional information to help the reader understand a topic or concept. A note has the following format:



Note

Note text.

Caring for the environment

The following information describes national or regional requirements for the disposal of Cambium Networks supplied equipment and for the approved disposal of surplus packaging.

In EU countries

The following information is provided to enable regulatory compliance with the European Union (EU) directives identified and any amendments made to these directives when using Cambium equipment in EU countries.



Disposal of Cambium equipment

European Union (EU) Directive 2002/96/EC Waste Electrical and Electronic Equipment (WEEE)

Do not dispose of Cambium equipment in landfill sites. For disposal instructions, refer to <http://www.cambiumnetworks.com/support/weee-compliance>

Disposal of surplus packaging

Do not dispose of surplus packaging in landfill sites. In the EU, it is the individual recipient's responsibility to ensure that packaging materials are collected and recycled according to the requirements of EU environmental law.

In non-EU countries

In non-EU countries, dispose of Cambium equipment and all surplus packaging in accordance with national and regional regulations.

Chapter 1: Product description

This chapter provides a high level description of 450 Platform Family products. It describes in general terms the function of the product, the main product variants and the main hardware components. The following topics are described in this chapter:

- [Overview of the 450 Platform Family](#) on page 1-2 introduces the key features, typical uses, product variants and components of the 450 Platform Family.
- [Wireless operation](#) on page 1-17 describes how the 450 Platform Family wireless link is operated, including modulation modes and spectrum management.
- [System management](#) on page 1-22 introduces the 450 Platform Family management system, including the web interface, configuration, security, alerts and recovery.

Overview of the 450 Platform Family

This section introduces the key features, typical uses, product variants and components of the 450 Platform Family.

Purpose

Cambium 450 Platform Family products are designed for Ethernet bridging over point-to-point and point-to-multipoint microwave links in unlicensed and lightly-licensed frequency bands 900MHz, 2.4 GHz, 3.5/3.65 GHz and 4.9 to 5.925 GHz.

Users must ensure that the 450 Platform Family complies with local operating regulations.

The 450 Platform Family acts as a transparent bridge between two or more segments of the operator's network. In this sense, it can be treated as a virtual wired connection among points. The 450 Series platform forwards 802.3 Ethernet frames destined for the other part of the network and filters frames it does not need to forward.

450 Platform Family

The 450 Series platform supports following:

- PMP 450m Series
- PMP/PTP 450i Series
- PMP 450b Series
- PMP/PTP 450 Series

PMP 450m Series

The PMP 450m Series AP is a revolutionary product which is based on Multi-User Multiple-Input and Multiple-Output (MU-MIMO) technology. By combining a sophisticated beam forming antenna array with multiple transceivers, Cambium Networks is using leading edge technology to provide a substantial shift upward in capacity per sector.

Key features

The Cambium PMP 450m Series AP offers the following benefits:

- MU-MIMO Access Point is a technologically cutting-edge device providing more than 400 Mbps in 20 MHz Channel bandwidth using 2.5 ms frame size depending upon SMs position within sector. Even higher data rates are possible in releases 15.1.3 and beyond by using 5 ms frame sizes, or using 30 MHz or 40 MHz bandwidths.

- PMP 450m AP is compatible with existing PMP 450/450i Series Subscriber Modules(SM), providing an easy network upgrade path. This benefits to re-use existing SMs (i.e. capital investment). With releases 15.1.3 and beyond, PMP 450m also provides basic sector mode support for 430 SMs.
- 3x higher throughput packet rate compare 450 Series
- Integrated with 14x14 MU-MIMO antenna
- Gigabit copper/power port combined, 1000BaseT port with power out and SFP port, 2.5G Copper SFP
- More than 20 bps/Hz spectral efficiency and over 40 bps/Hz when deployed in frequency re-use configuration

Table 1 gives a summary of the main PMP 450m Series AP characteristics.

Table 1 Main characteristics of the PMP 450m Series AP

Characteristic	Value
Topology	PMP
Wireless link condition	LOS, near LOS or non-LOS
Range	PMP: Up to 40 mi (or 64 km)
Duplexing	TDD (symmetric and asymmetric)
Connectivity	1000Base-T Ethernet Main port with PoE input
Operating frequencies	5.150 to 5.925 GHz
Tx Power	42 dBm EIRP
Channel bandwidth	5, 10, 15, 20, 30, and 40 MHz
High spectral efficiency	More than 60 bps/Hz ¹
Timing synchronization	CMM5 or UGPS
Data rate	More than 400 Mbps with 20 MHz channel bandwidth and 2.5ms frame size. Additional data rate improvements are available in release 15.1.3 or later by using 30 MHz and 40 MHz channel bandwidths, or 5 ms frame size.

Frequency bands

The PMP 450m Series AP operates from 5150 to 5925 MHz bands.

¹ This is achieved in an ABAB frequency reuse AP deployment model.

Hardware components

The ODU (Outdoor unit) is a self-contained transceiver unit that houses both radio and networking electronics.

The **PMP 450m Series** is supplied in the following configurations:

Table 2 PMP 450m Series hardware configurations

ODU	Frequency	ODU type	
PMP 450m AP	5150 to 5925 MHz	Integrated	14 dBi, 90° MU-MIMO sector antenna

PMP/PTP 450i Series

The PMP/PTP 450i Series is a high performance wireless bridge for Ethernet traffic. It is capable of operating in line-of-sight (LOS), near-LOS and non-LOS propagation conditions. It supports 900 MHz, 3 GHz, and 4.9 to 5.925 GHz frequency band.

Key features

The PMP/PTP 450i Series has extensive quality of service (QoS) involving traffic classification, traffic policy and shaping capability.

The Cambium PMP/PTP 450i Series offers the following benefits:

- Cambium's high performing point-to-multipoint solution, with up to 310 Mbps (40 MHz Channel Bandwidth and 5 ms Frame Period) usable throughput for PMP and PTP
- State-of-the-art MIMO (Multi In Multi Out) technology
- Upto 7.5 bps/Hz spectral efficiency
- Increased Packet Processing rate
- Efficient GPS synchronized, scheduled TDD operation for easy AP/BHM site deployment and performance that is consistent regardless of SM/BHS loading
- A range of cost-effective subscriber device solutions to meet the business case of any network application
- MIMO B Mode: This technique provides for the ability to double the throughput of a radio transmission under proper RF conditions. Different data streams are transmitted simultaneously on two different antennas
- MIMO-A mode: This mode of operation has same modulation levels as the MIMO-B mode, namely: QPSK, 16-QAM, 64-QAM and 256-QAM. This mode increases system reliability in the links.
- Timing synchronization via CMM4, CMM5, or UGPS

[Table 3](#) gives a summary of the main PMP/PTP 450i Series characteristics.

Table 3 Main characteristics of the PMP/PTP 450i Series

Characteristic	Value
Topology	PMP/PTP
Wireless link condition	LOS, near LOS or non-LOS
Range	PTP: Up to 186 mi (or 299 km) depending on configuration for all bands PMP: Up to 40 mi (or 64 km) for 5 GHz band PMP: Up to 120 mi (or 193 km) for 900 MHz band
Duplexing	TDD (symmetric and asymmetric)
Connectivity	1000Base-T Ethernet Main port with PoE input
Operating frequencies	902 to 928 MHz 3.3 to 3.9 GHz 4.9 to 5.925 GHz
Tx Power	Max 25 dBm (3 GHz) Max 27 dBm (5 GHz) Max 25 dBm (900 MHz)
Channel bandwidth	5, 7, 10, 15, 20, 30, and 40 MHz
	 Note All bands do not support all channel bandwidths. For more information, refer to this link .
Spectral efficiency	Up to 7.5 bps/Hz
Timing synchronization	CMM4, CMM5, or UGPS
Data rate	Up to 310 Mbps (40 MHz channel BW) for PMP/PTP

Frequency bands

The PMP/PTP 450i Series ODU can operate in the following bands:

- 900 MHz band: 902 to 928 MHz
- 3 GHz band: 3300 to 3900 MHz
- 5 GHz band: 4900 to 5925 MHz

**Note**

900 MHz, 3 GHz, and 5 GHz bands with different frequencies require different hardware components.

Hardware components

The ODU (Outdoor unit) is a self-contained transceiver unit that houses both radio and networking electronics. The main hardware components of the PMP/PTP 450i Series are as follows:

- PMP 450i AP
- PMP 450i SM
- PTP 450i BH (BHM/BHS)

The **PMP/PTP 450i** Series is supplied in the following configurations:

Table 4 PMP/PTP 450i Series hardware configurations

ODU	Frequency	ODU type	
PMP 450i AP	902 to 928 MHz	Connectorized	Use with an external antenna
	3.3 to 3.9 GHz	Integrated	17 dBi, 90° sector dual slant antenna
		Connectorized	Use with an external antenna
	4.9 to 5.925 GHz (support 4.9, 5.1, 5.2, 5.4 and 5.8 GHz)	Integrated	16 dBi, 90° sector antenna
Connectorized		Use with an external antenna	
PMP 450i SM	3.3 to 3.9 GHz	Integrated	19 dBi, SM/BH with MARS antenna
		Connectorized	Use with an external antenna
	4.9 to 5.925 GHz (support 4.9, 5.1, 5.2, 5.4 and 5.8 GHz)	Integrated	23 dBi flat panel antenna
		Connectorized	Use with an external antenna
PTP 450i BH	3.3 to 3.9 GHz	Integrated	19 dBi, SM/BH with MARS antenna
		Connectorized	Use with an external antenna
	4.9 to 5.925 GHz (support 4.9, 5.1, 5.2, 5.4 and 5.8 GHz)	Integrated	23 dBi flat panel antenna
		Connectorized	Use with an external antenna



Note

The BH ODU can be configured as a BHM or a BHS in PTP mode.

PMP 450b Series

The PMP 450b Series is a high performance wireless Subscriber Module. It supports 4.9 to 5.925 GHz frequency band.

Key features

The Cambium PMP 450b Series offers the following benefits:

- Ultra-wide band radios support the entire band from 4.9 to 5.925 GHz.
- Gigabit Ethernet Interface provides the maximum transfer rates to the device.
- 3.5 mm audio jack allows direct connection of headphones without any adapters.
- Updated FPGA enhances Packet Processing Power more than 4 times that of the 450 SM.
- Capable of up to 300 Mbps aggregate in a 40 MHz channel.

Table 5 gives a summary of the main PMP 450b Series characteristics.

Table 5 Main characteristics of the PMP 450b Series

Characteristic	Value
Topology	PMP
Wireless link condition	LOS, near LOS or non-LOS
Range	PMP: Up to 40 mi (or 64 km)
Duplexing	TDD (symmetric and asymmetric)
Connectivity	100/1000Base-T Ethernet Main port with PoE input
Operating frequencies	4.9 to 5.925 GHz
Tx Power	Max 27 dBm
Channel bandwidth	5, 10, 15, 20, 30, and 40 MHz
	 Note All bands do not support all channel bandwidths. For more information, refer to this link .
Spectral efficiency	Up to 7.5 bps/Hz
Timing synchronization	CMM4, CMM5, or UGPS
Data rate	Up to 300 Mbps (40 MHz channel BW) for PMP

Frequency bands

The PMP 450b Series ODU can operate in the following band:

- 5 GHz band: 4900 to 5925 MHz

Hardware components

The ODU (Outdoor unit) is a self-contained transceiver unit that houses both radio and networking electronics. The main hardware components of the PMP 450b Series are as follows:

- PMP 450b SM

The **PMP 450b** Series is supplied in the following configurations:

Table 6 PMP 450b Series hardware configurations

ODU	Frequency	ODU type	
PMP 450b SM	4.9 to 5.925 GHz (support 4.9, 5.1, 5.2, 5.4 and 5.8 GHz)	Integrated	17 dBi flat panel antenna

PMP/PTP 450 Series

Cambium PMP/PTP 450 Series networks are designed for wireless point-to-multipoint and point-to-point links in the unlicensed/licensed 900 MHz, 2.4 GHz, 3.5 GHz, 3.65 GHz, 5.4 GHz and 5.8 GHz bands. Users must ensure that the PMP/PTP 450 Series complies with local operating regulations.

The PMP/PTP 450 Series enables network operators to grow their business by offering more capacity for data, voice and video applications.

Key features

The Cambium PMP/PTP 450 Series offers the following benefits:

- Cambium's point-to-multipoint and point-to-point solution, with up to 310 Mbps usable throughput
- State-of-the-art MIMO (Multi In Multi Out) technology
- Efficient GPS synchronized, scheduled TDD operation for easy Access Point site deployment and performance that is consistent regardless of subscriber loading
- A range of cost-effective subscriber device solutions to meet the business case of a network application
- MIMO-B Mode: This technique provides for the ability to double the throughput of a radio transmission under proper RF conditions. Different data streams are transmitted simultaneously on two different antennas.
- MIMO-A Mode: This mode of operation using the same modulation levels as the MIMO-B mode, namely: QPSK, 16-QAM, 64-QAM and 256-QAM but it provides an additional combining gain.

[Table 7](#) gives a summary of PMP/PTP 450 Series products main characteristics .

Table 7 Main characteristics of the PMP/PTP 450 Series

Characteristic	Value
Topology	PMP/PTP
Wireless link condition	LOS, near LOS or non-LOS
Range	Up to 40 mi (or 64 km) for PMP Up to 186 mi (or 299 km) for PTP
Duplexing	TDD (symmetric and asymmetric)
Connectivity	100Base-T Ethernet Main port with PoE input
Operating frequencies	900 MHz, 2.4 GHz, 3.5 GHz, 3.65 GHz and 5 GHz
Tx Power	max 22 dBm (2.4 GHz and 5 GHz) max 25 dBm (3.5 GHz and 3.65 GHz) max 25 dBm (900 MHz - PMP 450 SM and BH)
Channel bandwidth	5, 7, 10, 15, 20, 30, and 40 MHz  NOTE All bands do not support all channel bandwidths. For more information, refer to this link .
High spectral efficiency	Up to 7.5 bps/Hz
Timing synchronization	CMM4 or UGPS
Data rate	Up to 310 Mbps (40 MHz channel BW) for PMP/PTP

Frequency bands

The PMP/PTP 450 Series ODU can operate in the following bands:

- 900 MHz band: 902 to 928 MHz (SM and BH)
- 2.4 GHz band: 2400 to 2483 MHz
- 3.5 GHz band: 3300 to 3600 MHz
- 3.65 GHz band: 3500 to 3850 MHz
- 5 GHz band: 5470 to 5875 MHz

Hardware components

The main hardware components of the PMP/PTP 450 are as follows:

- PMP 450 AP
- PMP 450 SM
- PTP 450 BH (BHM/BHS)

The **PMP/PTP 450** is supplied in the following configurations:

Table 8 PMP/PTP 450 Series hardware configurations

ODU	Frequency	ODU type	
PMP 450 AP	2.4 GHz	Connectorized	Use with an external antenna
		Integrated	18 dBi Dual Slant
	3.5/3.65 GHz	Connectorized	Use with an external antenna
		Integrated	16 dBi Dual Slant
	5 GHz (5.4 and 5.8 GHz)	Connectorized	Use with an external antenna
PMP 450 SM	900 MHz	Connectorized	Use with an external antenna
	2.4 GHz	Connectorized	Use with an external antenna
		Integrated	7 dBi Dual Slant, integrated patch
	3.5/3.65 GHz	Connectorized	Use with an external antenna
		Integrated	8 dBi Dual Slant, integrated patch
		Integrated	19 dBi Flat Plate, integrated patch
	5 GHz (5.4 and 5.8 GHz)	Connectorized	Use with an external antenna
		Integrated	9 dBi H+V, integrated patch
		Integrated	25 dBi H+V, Integrated dish
PTP 450 BH	902 to 928 MHz	Connectorized	Use with an external antenna
	3.5/3.65 GHz	Connectorized	Use with an external antenna
		Integrated	8 dBi Dual Slant
	5 GHz (5.4 and 5.8 GHz)	Connectorized	Use with an external antenna
		Integrated	9 dBi H+V

**Note**

The BH ODU can be configured as a BHM or a BHS in PTP mode

Supported interoperability for 450m/450i/450b/450 Series

The supported interoperability among various 450m/450i/450 Series hardwares are listed below:

Table 9 Supported Interoperability for PMP

Band	AP	SM
5.1, 5.2 and 5.9 GHz	PMP 450m AP	PMP 450i SM, PMP 450b SM
4.9, 5.1, 5.2 and 5.9 GHz	PMP 450i AP	PMP 450i SM, PMP 450b SM
5.4 and 5.8 GHz	PMP 450m AP	PMP 450i SM, PMP 450 SM, PMP 450d SM, and PMP 450b SM
	PMP 450i AP	
	PMP 450 AP	
3.5 and 3.65 GHz	PMP 450 AP	PMP 450 SM, PMP 450i SM
	PMP 450i AP	PMP 450i SM, PMP 450 SM
2.4 GHz	PMP 450 AP	PMP 450 SM
900 MHz	PMP 450i AP	PMP 450 SM

Table 10 Supported Interoperability for PTP

Band	BH
900 MHz	PTP 450 BHM and BHS
3.5 and 3.65 GHz	PTP 450/450i BHM and BHS
4.9, 5.1, 5.2, 5.4 and 5.8 GHz	PTP 450i BHM and BHS
5.4 and 5.8 GHz	PTP 450/450i BHM and BHS

Typical deployment

The 450 Platform Family is an “all outdoor” solution consisting of a wireless bridge across sites. Each site installation consists of an Integrated or Connectorized outdoor unit (ODU) and a power supply (PSU) (see [Figure 1](#)). The ODU provides the following interfaces:

- Ethernet port: This provides proprietary power over Ethernet and connection to the management and/or data networks.

Figure 1 PMP/PTP 450 Platform Family typical bridge deployment

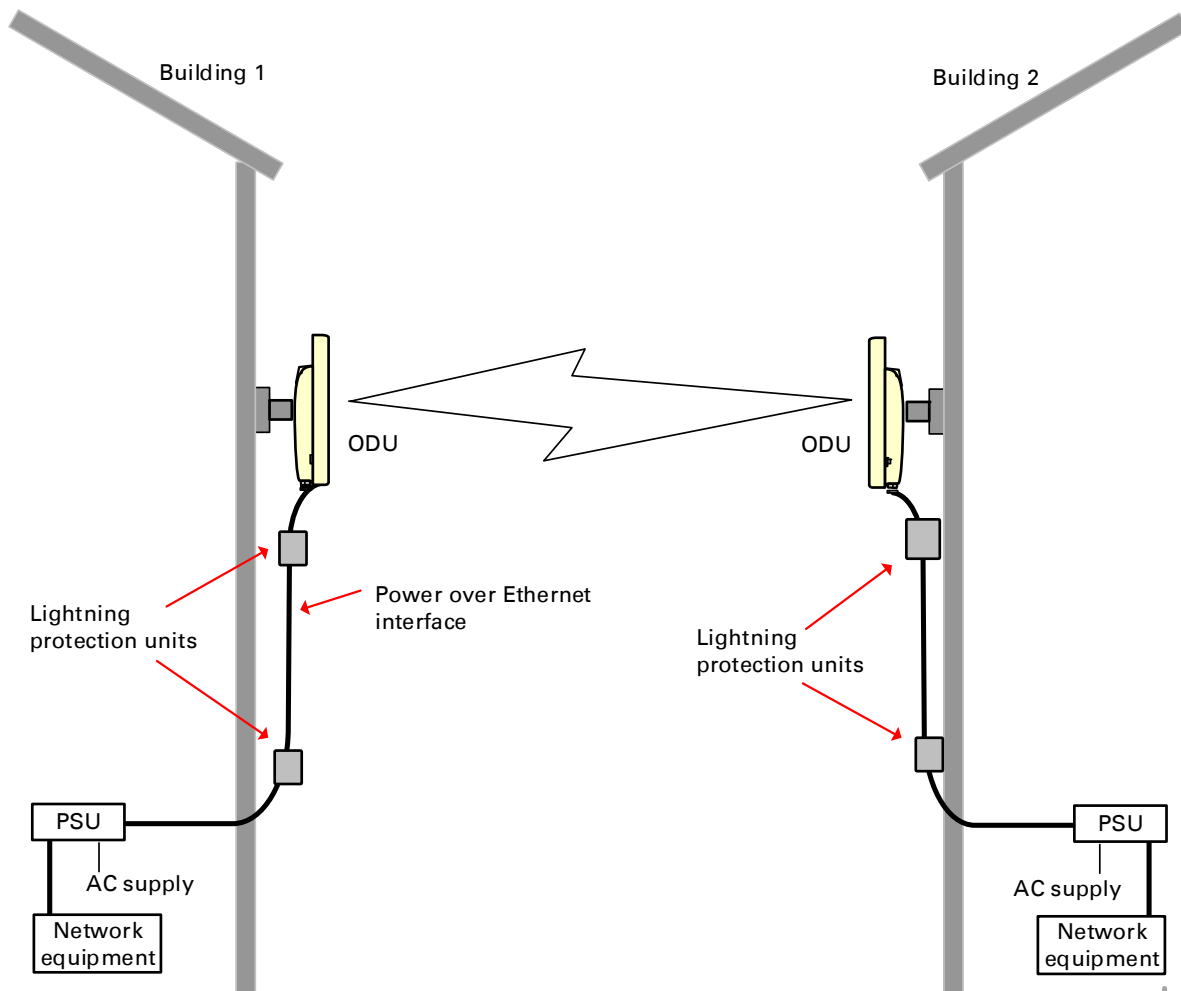

Point-to-Multipoint

The PMP configuration of 450 Platform Family consists of Access Point (AP) and Subscriber Module (SM) ODU. The radio link operates on a single frequency channel in each direction using Time Division Duplex (TDD). [The AP operates in TDMA mode to service multiple SMs.](#)

Applications for the PMP Series include:

- High throughput enterprise applications
- nLOS video surveillance in metro areas
- Urban area network extension
- Network extension into areas with foliage

Point-to-Point (Backhaul)

The PTP configuration of 450 Platform Family consists of two BH (Backhaul) ODUs. The customer can decide, via software configuration, if this unit is a BHM (Backhaul Master) or a BHS (Backhaul Slave). The radio link operates on a single frequency channel using Time Division Duplex (TDD). [The BHM operates in TDMA mode to service the BHS.](#)

Applications for the PTP Series include:

- Enterprise Access
- nLOS video surveillance
- Leased line replacements and backup solutions
- Network extension

Product variants

The 450 Platform Family is available in the following product variants:

- The ODU is supplied in the following regional variants:
 - FCC, intended for deployment in the USA
 - EU, intended for deployment in countries of the European Union or other countries following ETSI regulations
 - Rest of the World (RoW), intended for deployment in countries other than USA and EU countries.
 - IC, intended for deployment in Canada
- A ruggedized ODU Subscriber Module designed to meet IP-66 and IP-67 standards to withstand harsh environments
- An integrated Dish ODU Subscriber Module in a new, rugged and high gain design for 5 GHz band
- An indoor power supply module providing Power-over-Ethernet (PoE) supply to ODU (AP/SM/BH)
- Antennas and antenna cabling: Connectorized ODUs require external antennas connected using RF cable
- Ethernet cabling: All configurations require a copper Ethernet Cat5e connection from the ODU (Ethernet port) to the PoE
- Lightning protection unit (LPU): LPUs are installed in the ports copper drop cables to provide transient voltage surge suppression
- Surge Suppression: The Gigabit Surge Suppressor provides a path to ground (Protective Earth) that protects connected radio equipment from near-miss lightning strikes.
- Ground cables: ODU, LPUs and outdoor copper Ethernet cables are bonded to the site grounding system using ground cables.

For more information about these components, including interfaces, specifications and Cambium part numbers, refer to [Chapter 2: System hardware](#).

Wireless operation

This section describes how the 450 Platform Family wireless link is operated, including modulation modes, power control and security.

Time division duplexing

The system uses Time Division Duplexing (TDD) – one channel alternately transmits and receives rather than using one channel for transmitting and a second channel for receiving. The radio link operates on a single frequency channel in each direction using TDD. The AP operates in TDMA mode to service multiple SMs. To accomplish TDD, the AP/BHM must provide sync to its SM/BHS.

Furthermore, collocated APs/BHMs must be synced together – an unsynchronized AP/BHM that transmits during the receive cycle of a collocated AP/BHM can prevent a second AP/BHM from being able to decode the signals from its APs/BHSs. In addition, across a geographical area, APs/BHMs that can “hear” each other benefit from using a common sync to further reduce self-interference within the network.

Modules use TDD on a common frequency to divide frames for uplink (orange) and downlink (green) usage, as shown in the figure below.

For more information on synchronization configuration options, see [GPS synchronization](#) on page 2-47.

Figure 2 TDD frame division

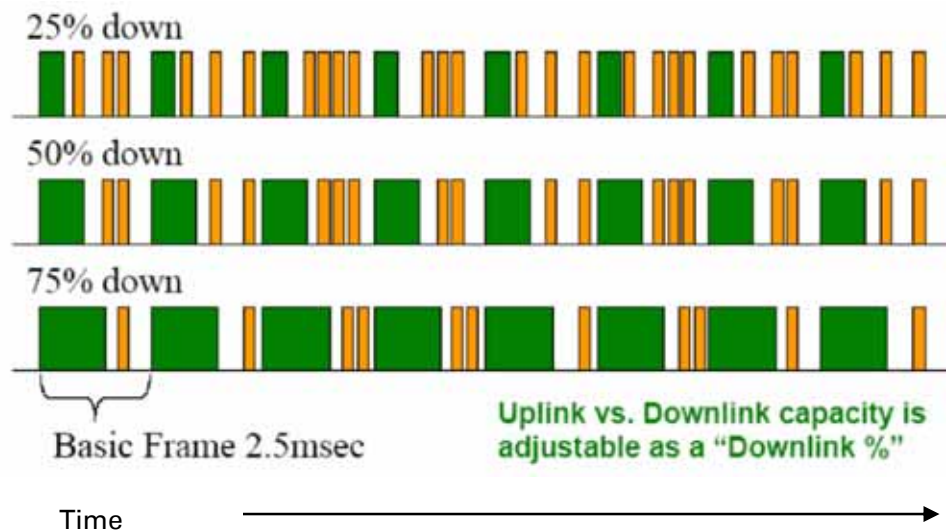

TDD frame parameters

The TDD burst duration varies depending on the following:

- Channel Bandwidth
- Cyclic Prefix
- Frame Period
- Frame configuration - Downlink Data
- Link operation – Dynamic Rate Adaptation

OFDM and channel bandwidth

The PMP/PTP 450 Platform Family transmits using Orthogonal Frequency Division Multiplexing (OFDM). This wideband signal consists of many equally spaced sub-carriers. Although each sub carrier is modulated at a low rate using conventional modulation schemes, the resultant data rate from the sub-carriers is high. OFDM works exceptionally over a Non-Line-of-Sight (NLoS) channel.

The channel bandwidth of the OFDM signal is configurable to one of the following values: 5, 7, 10, 15, 20 and 30 MHz. Higher bandwidths provide greater link capacity at the expense of using more bandwidth. Systems configured for a narrower channel bandwidth provide better receiver sensitivity and can also be an appropriate choice in deployments where the amount of free spectrum is limited.



Note

The channel bandwidth must be configured to the same value at both ends of the link. Not all channel bandwidths are available in all regulatory bands.

Cyclic Prefix

OFDM technology uses a cyclic prefix, where a portion of the end of a symbol (slot) is repeated at the beginning of the symbol (slot) to allow multi-pathing to settle before receiving the desired data. A 1/16 cyclic prefix means that for every 16 bits of throughput data transmitted, an additional bit is used. For your convenience, the 450 Platform Family ODU's have been locked to a 1/16 CP.

Frame Period

The frame period or frame duration is the time between the beginning of a frame and the end of the frame. The 450 Platform Family supports two frame periods: 2.5 ms and 5 ms.



Note

PMP 450m AP supports 2.5 ms Frame Period only.

The 5ms frame period configuration provides higher throughput as a result of reduced frame overhead during transmission. In turn, the 2.5 ms frame period configuration affords reduced latency in the system, half of that introduced by the 5 ms frame configuration.

Frame configuration - Downlink Data

The percentage of frame assigned to transport downlink data. The downlink data specifies the percentage of the aggregate throughput for the downlink (frames transmitted from the AP/BHM to the subscriber). The configurable range is 15% to 85%.



Note

The maximum configurable range is 34% to 66% for 40 MHz with 5 ms frame.

Link operation – Dynamic Rate Adapt

The 450 Platform Family ODUs offer eight levels or speeds of operation – 2X MIMO-B and 1X MIMO-A (QPSK), 4X MIMO-B and 2X MIMO-A (16-QAM), 6x MIMO-B and 3X MIMO-A (64-QAM) and 8X MIMO-B and 4X MIMO-A (265-QAM). If received power varies due to distance between the AP/BHM and the SM/BHS or due to obstructions, or if interference affects the RF environment, the system automatically and dynamically adjusts the links to the best operation level.

The system chooses its modulation rate dynamically, based on an internal ARQ (Automatic Repeat reQuest) error control method. With ARQ, every data slot of every frame sent over the air (except downlink broadcast) is expected to be acknowledged by the receiver, and if acknowledgement is not received, the data is resent. The sending unit monitors these re-sends and adjusts the modulation rate accordingly. It is normal to have links that change levels of operation as the RF environment changes. Furthermore, the uplink or downlink portions of TDD duty cycle operate independently.

The various modulation levels used by 450 Platform Family are shown in [Table 11](#).

Table 11 Modulation levels

Rate	MIMO-B	MIMO-A
QPSK	2X MIMO-B	1X MIMO-A
16-QAM	4X MIMO-B	2X MIMO-A
64-QAM	6X MIMO-B	3X MIMO-A
256-QAM	8X MIMO-B	4X MIMO-A

**Note**

MIMO-A achieves half the throughput of MIMO-B but adds a combining diversity (gain) which enhances the link budget or availability.

Encryption

The 450 Platform Family supports optional encryption for data transmitted over the wireless link. The 450 Platform Family supports the following forms of encryption for security of the wireless link:

- **DES (Data Encryption Standard):** An over-the-air link encryption option that uses secret 56-bit keys and 8 parity bits. DES performs a series of bit permutations, substitutions, and recombination operations on blocks of data. DES encryption does not affect the performance or throughput of the system.
- **AES (Advanced Encryption Standard):** An over-the-air link encryption option that uses the Rijndael algorithm and 128-bit keys and 256-bit key size to establish a higher level of security than DES. AES products are certified as compliant with the Federal Information Processing Standards (FIPS 197) in the U.S.A.

The default setting on an AP is "Disabled".

MIMO

Multiple-Input Multiple-Output (MIMO) techniques provide protection against fading and increase the probability that the receiver decodes a usable signal. When the effects of MIMO are combined with those of OFDM techniques and a high link budget, there is a high probability of a robust connection over a non-line-of-sight path.

The sub-features that comprises the MIMO techniques utilized in the 450 Platform Family ODU are:

- **MIMO-A:** This technique enables 450 Platform Family radio to use a scheme that optimizes coverage by transmitting the same data over both antennas. This redundancy improves the signal to noise ratio at the receiver making it more robust.
- **MIMO-B:** This technique provides the ability to double the throughput of a radio transmission under proper RF conditions. Different data streams are transmitted simultaneously on two different antennas.

MU-MIMO

Multiple-input multiple-output, or MIMO, is a range of technologies used to multiply the capacity of a wireless connection without requiring more spectrum.

Although traditional MIMO techniques are focused on increasing the bandwidth available between two wireless nodes, multi-user MIMO (MU-MIMO) applies these technologies to increase overall wireless network capacity by allowing an access point to communicate wirelessly with more than one wireless node at once.

A MU-MIMO access point features an array of antennas. When the AP decides to communicate with multiple nodes at the same time, it creates multiple simultaneous beams each directed to a specific node.

This is contrast to a traditional wireless system, where two wireless nodes cannot communicate on the same channel to the same access point at the same time, without causing significant self-interference and degrading the overall wireless network performance.

A MU-MIMO access point estimates and measures what a transmission from each wireless node 'sounds like', by applying knowledge of the wireless path characteristics between the access point and node. Known as channel estimation, this process is of vital importance; without it, the access point cannot distinguish properly between wireless nodes, affecting performance.

Channel estimation is achieved by the access point sending a specific signal to a wireless node, which the node then reflects back. By measuring how the signal was received back from the node, the access point can estimate the wireless conditions between itself and the node, and know to expect these same conditions to be applied to other communications from that node. This is known as channel sounding.

Channel estimation and sounding must be regularly repeated to ensure wireless network performance remains high; the speed at which a system is able to accurately estimate the channel has a large impact on performance.

Once channel estimation is completed for a wireless node, the MU-MIMO access point can electrically tune each antenna to provide the highest performance for that node. The access point uses beamforming to create a radio beam to that node which is tuned for optimum performance and avoids beams directed to other nodes, reducing interference and helping to improve overall wireless network capacity.

A MU-MIMO access point can communicate to multiple wireless nodes simultaneously using this process. As the majority of nodes are unable to make full use of the whole access point capacity at once, communicating with several nodes simultaneously can greatly improve the overall capacity achieved in the wireless network.

System management

This section introduces the 450 Platform Family management system, including the web interface, installation, configuration, alerts and upgrades.

Management agent

The 450 Platform Family radios are managed through an embedded management agent.

Management workstations, network management systems or PCs can be connected to this agent using the module's Ethernet port or over-the air (SM/BHS)

The management agent supports the following interfaces:

- Hypertext transfer protocol (HTTP)
- Hypertext transfer protocol secure (HTTPS)
- RADIUS authentication
- Simple network management protocol (SNMP) – v2c and v3
- Network time protocol (NTP)
- System logging (Syslog)
- Wireless Manager (WM) software
- Canopy Network Updater Tool (CNUT) software
- cnMaestro™

Web server

The 450 Platform Family management agent contains a web server. The web server supports access via the HTTP/HTTPS interface.

Web-based management offers a convenient way to manage the 450 Platform Family radios from a locally connected computer or from a network management workstation connected through a management network, without requiring any special management software. The web and SNMP are the interfaces supported for installation of 450 Platform Family radios and for the majority of configuration management tasks.

Web pages

The web-based management interfaces provide comprehensive web-based fault, configuration, performance and security management functions organized into the following groups:

Access Point or Backhaul Master:

- Home
- Configuration
- Statistics
- Tools
- Logs
- Accounts
- Quick Start
- Copyright

Subscriber Module or Backhaul Slave

- Home
- Configuration
- Statistics
- Tools
- Logs
- Accounts
- PDA
- Copyright

Identity-based user accounts

- When identity-based user accounts are configured, a security officer can define from one to four user accounts, each of which may have one of the four possible roles:
- ADMINISTRATOR, who has full read and write permissions. This is the level of the root and admin users, as well as any other administrator accounts that one of them creates.
- INSTALLER, who has permissions identical to those of ADMINISTRATOR except that the installer cannot add or delete users or change the password of any other user.
- TECHNICIAN, who has permissions to modify basic radio parameters and view informational web pages
- GUEST, who has no write permissions and only a limited view of General Status tab
- Admin, Installer and Tech accounts can be configured as READ-ONLY. This will allow the account to only see the items.

See [Managing module access by passwords](#) for detailed information on account permissions.

Remote Authentication Dial-in User Service (RADIUS)

The PMP configuration of 450 Platform Family includes support for RADIUS (Remote Authentication Dial In User Service) protocol functionality including:

- **SM Authentication:** Allows only known SMs onto the network (blocking “rogue” SMs), and can be configured to ensure SMs are connecting to a known network (preventing SMs from connecting to “rogue” APs). RADIUS authentication is used for SMs, but not used for APs.
- **SM Configuration:** Configures authenticated SMs with MIR (Maximum Information Rate), High Priority, and VLAN (Virtual LAN) parameters from the RADIUS server when a SM registers to an AP.
- **User Authentication** allows users to configure a separate User authentication server along with the SM authentication server. If firmware is upgraded while using this functionality and no User authentication servers are configured, then AP continues to use the SM authentication server for User authentication
- **SM Accounting** provides support for RADIUS accounting messages for usage-based billing. This accounting includes indications for subscriber session establishment, subscriber session disconnection, and bandwidth usage per session for each SM that connects to the AP.
- **Centralized AP and SM user name and password management:** Allows AP and SM usernames and access levels (Administrator, Installer, Technician and Read-Only) to be centrally administered in the RADIUS server instead of on each radio and tracks access events (logon/logoff) for each username on the RADIUS server. This accounting does not track and report specific configuration actions performed on radios or pull statistics such as bit counts from the radios. Such functions require an Element Management System (EMS) such as Cambium Wireless Manager. This accounting is not the ability to perform accounting functions on the subscriber/end user/customer account.
- **Framed-IP-Address:** Operators may use a RADIUS server to assign management IP addressing to SM modules. SNMP

The management agent supports fault and performance management by means of an SNMP interface. The management agent is compatible with SNMP v2c and SNMP v3 using Management Information Base (MIB) files which are available for download from the Cambium Networks Support website:

<https://support.cambiumnetworks.com/files/ptp450>

<https://support.cambiumnetworks.com/files/pmp450>

Network Time Protocol (NTP)

The clock supplies accurate date and time information to the system. It can be set to run with or without a connection to a network time server (NTP). It can be configured to display local time by setting the time zone and daylight saving in the Time web page.

If an NTP server connection is available, the clock can be set to synchronize with the server time at regular intervals. The 450 Platform Family radios may receive NTP data from a CMM4 module or an NTP server configured in the system’s management network.

The Time Zone option is configurable on the AP's/BHM's Time Configuration page, and may be used to offset the received NTP time to match the operator's local time zone. When set on the AP/BHM, the offset is set for the entire sector (AP/BHMs are notified of the current Time Zone upon initial registration). If a Time Zone change is applied, the AP/BHMs are notified of the change in a best effort fashion, meaning some AP/BHMs may not pick up the change until the next re-registration. Time Zone changes are noted in the Event Log.

An AP/BHM which is receiving NTP date and time information from an NTP server or from a GPS synchronization source may be used as an NTP server. Any client which has IP connectivity to the BHM may request NTP date and time information from the AP/BHM. No additional configuration (other than the AP/BHM receiving valid NTP data) is required to use the AP/BHM as an NTP server.

Wireless Manager (WM)

Cambium Networks Wireless Manager 4.0 is recommended for managing 450 Platform Family networks. You can achieve better uptime through better visibility of your network with the Cambium Wireless Manager. This network management software tool offers breakthrough map-based visualization capabilities using embedded Google maps, and combined with advanced configuration, provisioning, alerting and reporting features you can control your entire outdoor wireless network including Point-to-Multipoint and Point-to-Point solutions as well as other SNMP enabled devices. With its powerful user interface you can not only be able to control your network's access, distribution and backhaul layers, but can also have visibility to WLAN sites and be able to quickly launch indoor network management systems. Some key features of Wireless Manager are:

- **Template-Based Configuration:** With Wireless Manager's user-defined templates you can accelerate the process for the configuration of the devices you add to your network resulting in quicker and easier deployments. The template-based functionality provides an automated way to configure large numbers of network devices with just a few mouse clicks, and can be scheduled to occur at any time via Wireless Manager's Task Scheduler.
- **Ultralight Thin Client:** With the growing mobile workforce it is important to have access to the status of your network at any time. With Wireless Manager you can view the status and performance of your entire wireless network via a compact web interface accessible by your smart phone.
- **Map-Based Visualization:** Wireless Manager overlays sophisticated real-time information about your network elements onto building layouts and dynamic Google maps. Visuals can be scaled to view an entire city or building or a specific area, floor or link.
- **High Availability Architecture Support:** Wireless Manager offers a high availability option, providing a highly reliable and redundant network management solution that ensures you always have management access to your network.
- **High Scalability:** The enhanced Wireless Manager offers you server scalability with support for up to 10,000 nodes as well as support for distributed server architecture.

Cambium's Wireless Manager 4.0 available for download at:

<http://www.cambiumnetworks.com/support/management-tools/wireless-manager/>

Canopy Network Updater Tool (CNUT)

CNUT (Canopy Network Updater Tool) is the stand-alone software update tool for 450 Platform Family ODU. The CNUT 4.11.2 should be used for 450 Platform Family ODUs.

The Canopy Network Updater Tool has the following features:

- Automatically discovers all network elements
- HTTP and HTTPS
- Executes UDP command that initiates and terminates the Auto-update mode within APs/BHMs. This command is both secure and convenient:
 - For security, the AP/BHM accepts this command from only the IP address that specified in the Configuration page of ODU.
 - For convenience, Network Updater automatically sets this Configuration parameter in the AP/BHM to the IP address of the Network Updater server when the server performs any of the update commands.
- Allows you to choose among updating:
 - Entire network.
 - Only elements that you select.
 - Only network branches that you select.
- Provides a Script Engine that you can use with any script which:
 - The user can define.
 - Cambium supplies.

CNUT is available at:

<http://www.cambiumnetworks.com/support/management-tools/cnut/>

cnMaestro™

cnMaestro™ is a cloud-based or on-premises platform specialized for secure, end-to-end network lifecycle management: inventory management, device onboarding, daily operations, and maintenance. The cnMaestro wireless network manager simplifies device management by offering full network visibility. Network operators can have a real-time view of their complete end-to-end network and perform a full suite of wireless network management functions to optimize system availability, maximize throughput, and meet emerging needs of business and residential customers. In addition, the cnMaestro wireless network manager collects and displays compliance with service level agreements.

To learn about cnMaestro™, please visit <http://www.cambiumnetworks.com/products/software-tools/cnmaestro/>

See [Configuring cnMaestro™ Connectivity on 7-223](#) for details.

Radio recovery mode

The 450 Platform Family recovery mode provides a means to recover from serious configuration errors including lost or forgotten passwords and unknown IP addresses.

The recovery procedure for 450m/450i/450b series and 450 series ODUs differ due to difference in hardwares. This procedure for 450i/450m Series is known as Radio Recovery Console and for 450 Series is known as Default mode (or Default/Override Plug).

Radio Recovery Console – 450i, 450b and 450m Series

The Radio Recovery Console mode supports:

- Restoring factory default IP address 169.254.1.1 and password
- Boot with factory default Canopy system software settings
- Load previously installed SW images

See [Radio Recovery Console– PMP/PTP 450i/450b and PMP 450m](#) on page 9-39.

Default Mode (or Default Plug) – 450 Series

A default plug is available to provide access to a module whose password and/or IP address have been forgotten.

This plug allows the 450 Series ODUs to be accessed using IP address 169.254.1.1 and no password. During the override session, you can assign any new IP address and set either or both user passwords (display-only and/or full access) as well as make other parameter changes.

See [Default Mode \(or Default/Override Plug\) - PMP/PTP 450](#) on page 9-41.

Chapter 2: System hardware

This chapter describes the hardware components of a 450 Platform link.

The following topics are described in this chapter:

- [System Components](#) on page 2-2 describes system components of PTP and PMP including its accessories
- [Cabling](#) on page 2-35 describes about various cables.
- [Lightning protection unit \(LPU\) and grounding kit](#) on page 2-43 describes about lightning protection and grounding kit
- [Antennas and antenna cabling](#) on page 2-45 describes supported antennas and its accessories
- [GPS synchronization](#) on page 2-47 describes UGPS and CMM4.
- [Ordering the components](#) on page 2-62 specifies Cambium part numbers for 450 Platform Family components

System Components

Point-to-Multipoint (PMP)

The PMP radio is a transceiver device. It is a connectorized or radiated outdoor unit containing all the radio, networking, and surge suppression electronics. It can be purchased as:

- Access Point Module (AP)
- Subscriber Module (SM)

PMP 450 Platform Family Integrated or Connectorized ODU

The PMP 450i Series and PMP 450 Series ODUs are supplied in Integrated or Connectorized configurations. The PMP 450m Series AP is supplied in Integrated configuration only.

See [Table 2 PMP 450m Series hardware configurations](#) on page 1-4

See [Table 4 PMP/PTP 450i Series hardware configurations](#) on page 1-6

See [Table 6 PMP 450b Series hardware configurations](#) on page 1-9

See [Table 8 PMP/PTP 450 Series hardware configurations](#) on page 1-12

Product variants

Table 12 PMP 450m Series variants

Variant	Region	Antenna	Frequency Range	Channel Bandwidth	Max EIRP
5 GHz PMP 450m AP	FCC	90° integrated sector array, 14x14 MIMO system,	5150 – 5925 MHz	5, 10, 15, 20, 30, 40 MHz	42 dBm
	RoW				
	EU				
	DES only				
	IC				

Table 13 PMP 450i Series variants

Variant	Region	Antenna	Frequency Range	Channel Bandwidth	Max Tx Power
900 MHz PMP 450i AP	FCC	Connectorized	902 - 928 MHz	5, 7, 10, 15, 20 MHz	25 dBm
3 GHz PMP 450i AP	FCC, RoW, Canada, RoW DES, Europe	Connectorized Integrated 16 dBi	3300 – 3900 MHz	5, 7, 10, 15, 20, 30, 40 MHz	25 dBm
5 GHz PMP 450i AP	FCC, RoW, Canada, RoW DES, Europe	Connectorized Integrated 16 dBi 90 degree	4900 – 5925 MHz	5, 10, 15, 20, 30, 40 MHz	27 dBm

Table 14 PMP 450b Series variants

Variant	Region	Antenna	Frequency Range	Channel Bandwidth	Max Tx Power
5 GHz PMP 450b SM	FCC, RoW, Canada, RoW DES, Europe	Integrated 16 dBi	4900 – 5925 MHz	5, 10, 15, 20, 30, 40 MHz	27 dBm

**Note**

The Transmit power is limited based on regional setting.

Table 15 PMP 450 Series variants

Variant	Region	Antenna	Frequency Range	Channel Bandwidth	Max Tx Power
900 MHz PMP 450 SM	FCC	Connectorized	902 - 928 MHz	5, 7, 10, 15, 20 MHz	25 dBm
2.4 GHz PMP 450 AP	FCC ISM	Connectorized	2400 – 2483.5 MHz	5, 10, 15, 20 MHz	22 dBm
		Integrated 18 dBi			
2.4 GHz PMP 450 SM	FCC ISM	Connectorized	2400 – 2483.5 MHz	5, 10, 15, 20 MHz	22 dBm
		Integrated 7 dBi			
3.5 GHz PMP 450 AP	FCC ISM	Connectorized	3300 – 3600 MHz	5, 7, 10, 15, 20, 30, 40 MHz	25 dBm
		Integrated 16 dBi			
3.5 GHz PMP 450 SM	FCC ISM	Connectorized	3300 – 3600 MHz	5, 7, 10, 15, 20, 30, 40 MHz	25 dBm
		Integrated 8 dBi			
		Integrated 19 dBi			
3.65 GHz PMP 450 AP	FCC ISM	Connectorized	3500 – 3850 MHz	5, 7, 10, 15, 20, 30, 40 MHz	25 dBm
		Integrated 16 dBi			
3.65 GHz PMP 450 SM	FCC ISM	Connectorized	3500 – 3850 MHz	5, 7, 10, 15, 20, 30, 40 MHz	25 dBm
		Integrated 8 dBi			
		Integrated 19 dBi			
5.4/5.8 GHz PMP 450 AP	FCC, RoW, RoW DES	Connectorized	5470 – 5875 MHz	5, 10, 15, 20, 30, 40 MHz (5, 15 and 30 MHz not available in DFS regions)	22 dBm
		Integrated 17 dBi			
5.4/5.8 GHz PMP 450 SM	FCC, ROW, RoW DES	Connectorized	5470 – 5875 MHz	5, 10, 15, 20, 30, 40 MHz (5, 15 and 30 MHz not available in DFS regions)	22 dBm
		Integrated 9 dBi			
		Integrated 25 dBi			

**Note**

The Transmit power is limited based on regional setting.

Backhaul (PTP)

The Backhaul radio is a transceiver device. It is a connectorized or integrated outdoor unit containing all the radio, networking, and surge suppression electronics. It can be configured as:

- Backhaul Master (BHM)
- Backhaul Slave (BHS)

PTP 450 Platform Family Integrated or Connectorized ODU

See [Table 4 PMP/PTP 450i Series hardware configurations](#) on page 1-6

See [Table 8 PMP/PTP 450 Series hardware configurations](#) on page 1-12

Product variants

Table 16 PTP 450i Series variants

Variant	Region	Antenna	Frequency Range	Channel Bandwidth	Max Tx Power	Notes
3 GHz PTP 450i	FCC, RoW, Canada, Row DES, Europe	Connectorized <hr/> Integrated 23 dBi	3300 - 3900 MHz	5, 7, 10, 15, 20, 30, 40 MHz	25 dBm	Transmit power limited based on regional setting
5 GHz PTP 450i	FCC, RoW, Canada, Row DES, Europe	Connectorized <hr/> Integrated 23 dBi	4900 – 5925 MHz	5, 10, 15, 20, 30, 40 MHz	27 dBm	Transmit power limited based on regional setting

Table 17 PTP 450 Series variants

Variant	Region	Antenna	Frequency Range	Channel Bandwidth	Max Tx Power
900 MHz PTP 450 BH	FCC	Connectorized	902 – 928 MHz	5, 7, 10, 15, 20 MHz	25 dBm
3.5 GHz PTP 450 BH	ROW	Connectorized	3300 – 3600 MHz	5, 7, 10, 15, 20, 30, 40 MHz	25 dBm
		Integrated 16 dBi			
		Integrated 19 dBi			
3.65 GHz PTP 450 BH	ROW	Connectorized	3500 – 3850 MHz	5, 7, 10, 15, 20, 30, 40 MHz	25 dBm
		Integrated 16 dBi			
		Integrated 19 dBi			
5.4/5.8 GHz PTP 450 BH	FCC, RoW, RoW DES	Connectorized	5470 – 5875 MHz	5, 10, 15, 20, 30, 40 MHz	22 dBm
		Integrated 9 dBi			
		Integrated 25 dBi			

**Note**

The Transmit power is limited based on regional setting.

450 Platform Family interfaces

PMP 450m Series interfaces – AP

The 450m Series AP interfaces is illustrated below.

Figure 3 PMP 450m Series interfaces

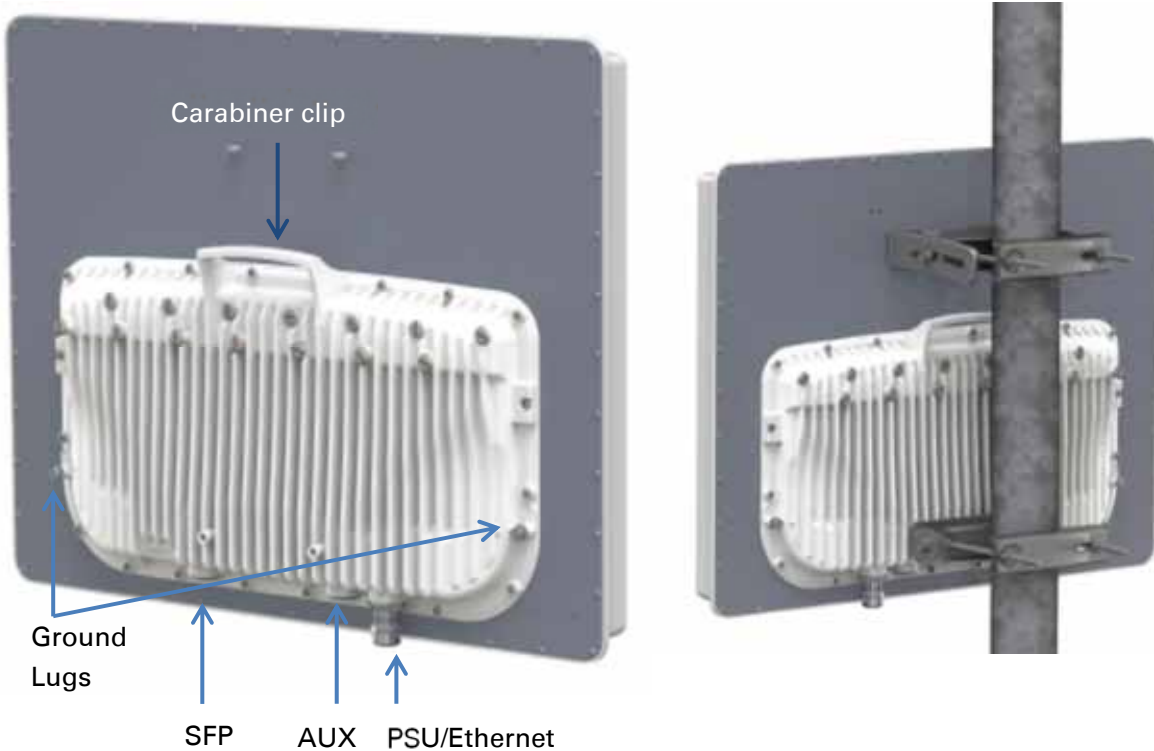

Table 18 PMP 450m Series AP interface descriptions and cabling

Interface	Function	Cabling
PSU/Ethernet	Power-over-Ethernet, Ethernet communications (management and data), CMM5 sync-over-power synchronization input	RJ45 Cable See Table 98 on page 5-12
Aux/Sync	GPS synchronization input and output, UGPS power output	RJ 45 Cable
	Audio tones	See Table 99 on page 5-12
	Data	
SFP	Read Ethernet communications (management and data)	
Ground Lugs	For grounding the unit	10 AWG copper wire

**Note**

For PMP 450m AP, the Sync-Over-Power is supported with CMM5 only.

For PMP 450m AP, the Sync-Over-Power will not work with CMM4 like PMP 450/450i Series.

**Note**

SFP kits (Single Mode Optical SFP Interface per ODU (part number C000065L008A),

Multi-mode Optical SFP Interface per ODU (part number C000065L009A), and

2.5GBASE-T Copper SFP Interface per ODU (part number C000065L011A)) are required for SFP port connectivity.

PMP/PTP 450i Series interfaces – AP/SM/BH

The AP/SM/BH interfaces are illustrated below.

Figure 4 PMP/PTP 450i interfaces

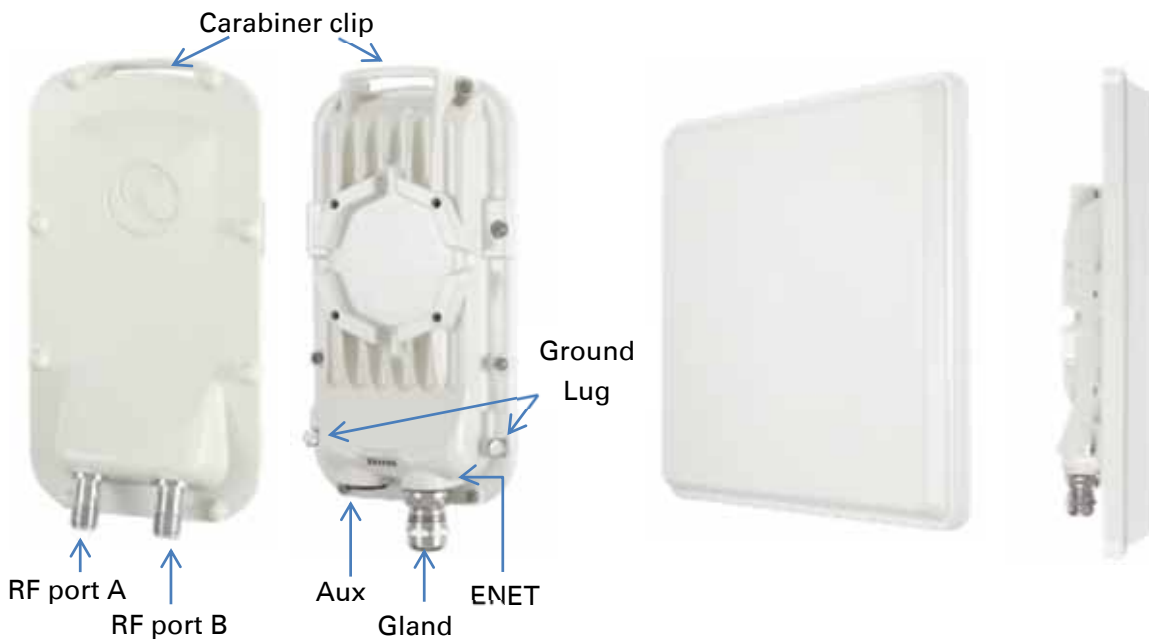

Table 19 PMP/PTP 450i Series - AP/SM/BH interface descriptions and cabling

Interface	Function	Cabling
PSU/Ethernet	Power-over-Ethernet, Ethernet communications (management and data), CMM sync-over-power synchronization input	RJ45 Cable See Table 98 on page 5-12
Aux/Sync	GPS synchronization input and output, UGPS power output	RJ 45 Cable
	Audio tones	See Table 99 on page 5-12
	Data	
RF Port A	Vertical RF connection to antenna	50 ohm RF cable, N-type
RF Port B	Horizontal RF connection to antenna	50 ohm RF cable, N-type
Ground Lugs	For grounding the unit	10 AWG copper wire

**Note**

If the Aux port will be used, a second Ethernet Gland will need to be ordered (Part Number: N000065L033A).

PMP 450b Series interfaces - SM (Mid Gain)

The **PMP 450b Series - SM** interfaces are illustrated below.

Figure 5 PMP 450b Series - SM interfaces

Table 20 PMP 450b Series - SM (Mid Gain) interface descriptions and cabling

Interface	Function	Cabling
PSU/Ethernet	Power-over-Ethernet, Ethernet communications (management and data)	RJ45 Cable
Audio AUX Port	3.5 mm audio jack for alignment tone	Standard 3.5 mm TRRS headphones

PMP 450b Series interfaces - SM (High Gain)

The **PMP 450b Series - SM** interfaces are illustrated below.

Figure 6 PMP 450b Series - SM interfaces (High Gain)**Table 21** PMP 450b Series - SM (High Gain) interface descriptions and cabling

Interface	Function	Cabling
PSU/Ethernet	Power-over-Ethernet, Ethernet communications (management and data)	RJ45 Cable
Audio AUX Port	3.5 mm audio jack for alignment tone	Standard 3.5 mm TRRS headphones

PMP/PTP 450 Series interfaces - AP

The **PMP 450 Series - AP** interfaces are illustrated below.

Figure 7 PMP/PTP 450 Series - AP interfaces

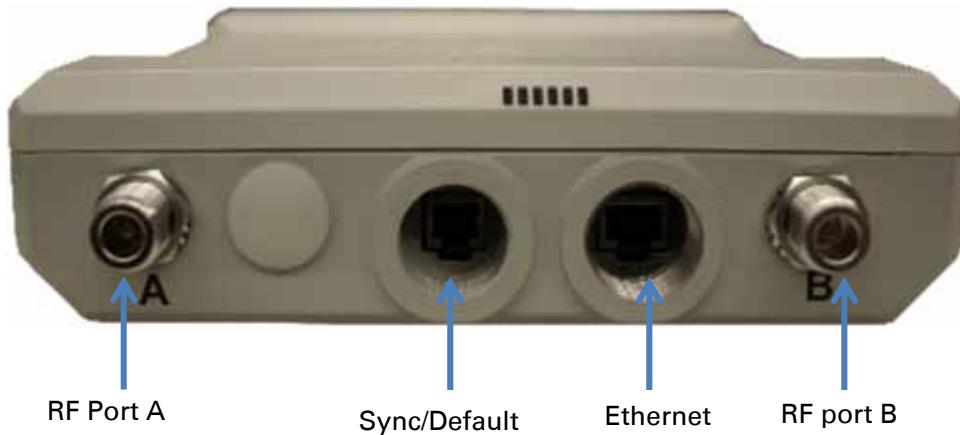

Table 22 PMP/PTP 450 Series - AP interface descriptions and cabling – 2.4 GHz and 5 GHz

Interface	Function	Cabling
PSU/Ethernet	Power-over-Ethernet, Ethernet communications (management and data)	RJ45 Cable
Sync/Default	GPS synchronization signaling, provides power to UGPS module. Default plug port.	RJ11 cable, default plug.
RF Port A	2.4 GHz -45 degree RF connection to AP antenna	50 ohm RF cable, N-type
	5 GHz Vertical RF connection to AP antenna	
RF Port B	2.4 GHz +45 degree RF connection to AP antenna	50 ohm RF cable, N-type
	5 GHz Horizontal RF connection to AP antenna	
Ground Lugs	For grounding the unit	10 AWG copper wire

PMP/PTP 450 Series interfaces – SM/BH

The PMP 450 Series SM/BH interfaces are illustrated below.

Figure 8 PMP/PTP 450 Series – SM/BH interfaces



Figure 9 PMP/PTP 450 Series – SM/BH Connectorized interfaces

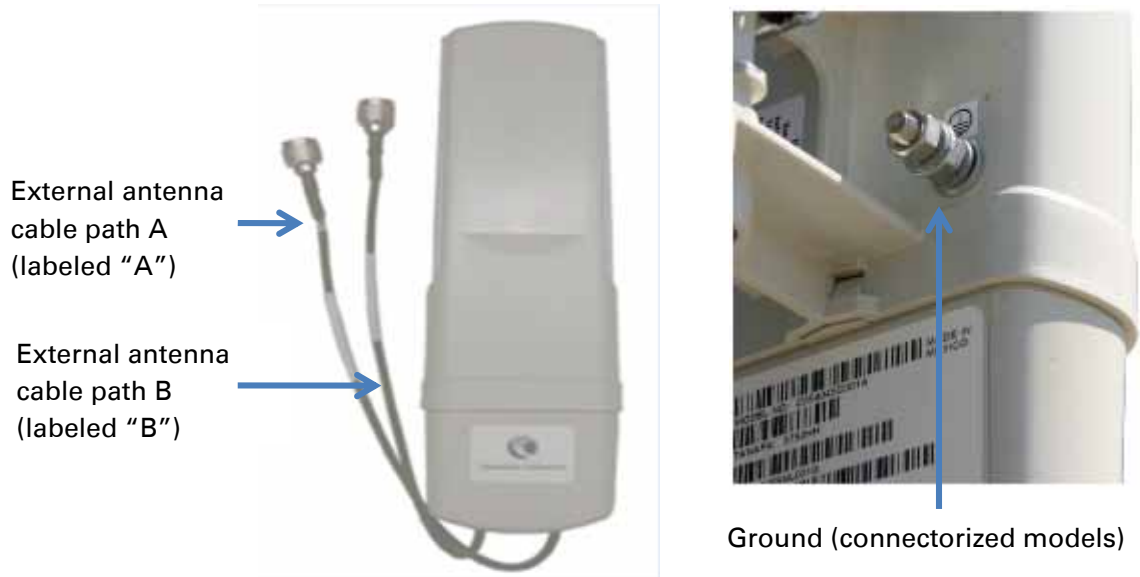

Note

As per Underwriters Laboratory (UL) guidelines, the Ground Lug on the radiated SM is not required.

Figure 10 PMP 450d Series - SM Integrated Dish



Figure 11 PMP 450 Series – SM 3 GHz Integrated



Figure 12 PTP 450 Series – BHM/BHS



ATEX/HAZLOC variants

PTP/PMP 450i series products are available in ATEX/Hazloc variants for operation in locations where explosive gas hazards exist, as defined by Hazloc (USA) and ATEX (Europe). ATEX/HAZLOC variants are similar to the standard product except that:

- ODUs are supplied with the Full capacity license
- The frequency range is restricted to 4940 MHz to 5850 MHz
- The maximum EIRP generated by ODU is restricted to comply with the ATEX and HAZLOC standards

In order to meet specific radio regulations in the USA, Canada and the EU, Cambium supplies products approved for USA, Canada, EU and the rest of the world under different models and part numbers. These models and part numbers are shown in [Table 64](#) and [Table 65](#).

Diagnostic LEDs

The diagnostic LEDs of 450 Platform Family ODUs are as shown below.



Note

The colors shown in the diagram may differ from the actual color displayed by the AP/BHM, depending on its current status.

AP/BHM LEDs

The diagnostic LEDs report the information about the status of the AP/BHM.

Figure 13 AP/BHM diagnostic LEDs, viewed from unit front



ODU LED Display	LED Labels					
PMP 450m Series - AP						
						
	MAIN LNK+ACT/5	AUX LNK+ACT/4	GPS/3	SES/2	SYN/1	PWR
PMP/PTP 450i Series - AP/BHM						
						
	MAIN LNK/5	ACT/4	GPS/3	SES/2	SYN/1	PWR
PMP/PTP 450 Series - AP/BHM						
						
	MAIN LNK/5	ACT/4	GPS/3	SES/2	SYN/1	PWR

Table 23 AP/BHM LED descriptions

LED	Color when active	Status information provided	Notes
PWR	Red	DC power	Always lit after 10-20 seconds of power on.
SYN/1	Yellow	Presence of sync	-
SES/2	Green	Unused	-
GPS/3	Red	Pulse of sync	Lit when the AP/BHM is getting a sync pulse from a GPS source goes along with SYN/1
ACT/4	For 450 and 450i Series Yellow	Presence of data activity on the Ethernet link	Flashes during data transfer. Frequency of flash is not a diagnostic indication.
AUX LNK + ACT/4	For 450m Series Red/ Green (bi-colored for 10/100)	Aux port link speed and activity	Flashes to indicate Ethernet activity on Aux port. Indicates speed based on the following colors: 10Base-T : Red 100Base-T : Green
MAIN LNK/5	For 450i Series Red/ Green/Orange (bi-colored for 10/100/1000)	Activity on Main port link	Continuously lit when link is present. Indicates speed based on the following colors: 10Base-T : Red 100Base-T : Green 1000Base-T : Orange
MAIN LNK/5	For 450 AP Orange/Green/Yellow (10/100/1000)	Ethernet link	Continuously lit when link is present. 10Base-T : Orange 100Base-T : Green 1000Base-T : Yellow
MAIN LNK + ACT/5	For 450 BHM Green		Continuously lit when link is present. 10Base-T : Green 100Base-T : Green
MAIN LNK + ACT/5	For 450m Series Red/ Green/Orange (bi-colored for 10/100/1000)	Main port link speed and activity	Flashes to indicate data transfer speed and activity.

SM/BHS LEDs

The SM/BHS LEDs provide different status of radio based on the operating modes. A SM/BHS in “operating” mode registers and passes traffic normally. A SM/BHS in “aiming” mode does not register or pass the traffic, but displays (via LED panel) the strength of received radio signals (based on radio channel selected via **Tools -> Alignment**).

Figure 14 AP/BH diagnostic LEDs, viewed from unit front



ODU LED Display	LED Labels						
PMP/PTP 450i Series - SM/BHS							
	<table border="1"> <tr> <td style="background-color: #FFA500;">MAIN LNK/5</td> <td style="background-color: #FFFF00;">ACT/4</td> <td style="background-color: #FF0000;">GPS/3</td> <td style="background-color: #90EE90;">SES/2</td> <td style="background-color: #FFFF00;">SYN/1</td> <td style="background-color: #FF0000;">PWR</td> </tr> </table>	MAIN LNK/5	ACT/4	GPS/3	SES/2	SYN/1	PWR
MAIN LNK/5	ACT/4	GPS/3	SES/2	SYN/1	PWR		
PMP 450b Series - SM							
	<table border="1"> <tr> <td style="background-color: #FFA500;">LNK/SPD/ ACT/4</td> <td style="background-color: #FF0000;">GPS/3</td> <td style="background-color: #90EE90;">SES/2</td> <td style="background-color: #FFFF00;">SYN/1</td> <td style="background-color: #0000FF;">STDBY/ PWR</td> </tr> </table>	LNK/SPD/ ACT/4	GPS/3	SES/2	SYN/1	STDBY/ PWR	
LNK/SPD/ ACT/4	GPS/3	SES/2	SYN/1	STDBY/ PWR			
PMP/PTP 450 Series - SM/BHS							
	<table border="1"> <tr> <td style="background-color: #90EE90;">MAIN LNK/5</td> <td style="background-color: #FFFF00;">ACT/4</td> <td style="background-color: #FF4500;">GPS/3</td> <td style="background-color: #90EE90;">SES/2</td> <td style="background-color: #FFFF00;">SYN/1</td> <td style="background-color: #FF4500;">PWR</td> </tr> </table>	MAIN LNK/5	ACT/4	GPS/3	SES/2	SYN/1	PWR
MAIN LNK/5	ACT/4	GPS/3	SES/2	SYN/1	PWR		

Table 24 SM/BHS LED descriptions

Status information provided				
LED	Color when active	SM / BHS in "Operating" Mode	SM / BHS in "Aiming" Mode	Notes
PWR	Red			Always lit after 10-20 seconds of power on.
STDBY/ PWR	Yellow/Blue	DC power	DC power	Flashes Yellow during boot-up. Flashes Blue when operating.
SYN/1	Yellow	Presence of sync	These three LEDs act as a bar graph to indicate the relative quality of alignment. As power level improves during alignment, more of these LEDs are lit.	Lit when SM/BHS is in sync with an AP/BHM.
SES/2	Green	Session Indicator		Lit when SM/BHS is in session.
GPS/3	Red	Unused		Unused
ACT/4	Yellow	Presence of data activity on the Ethernet link	Presence of data activity on the Ethernet link	Flashes during data transfer. Frequency of flash is not a diagnostic indication.
LNK/SP D/ACT/4	For 450b Series Red/Green/Orange (10/100/1000)	Ethernet Link	Ethernet Link	Flashes during data transfer. Frequency of flash is not a diagnostic indication. 10Base-T : Red 100Base-T : Green 1000Base-T : Orange
MAIN LNK/5	For 450i Series Red/ Green/ Orange (bi-colored for 10/100/1000)	Ethernet link	Ethernet link	Flashes during data transfer. 10Base-T : Red 100Base-T : Green 1000Base-T : Orange
	For 450 Series Green	Ethernet link	Ethernet link	Continuously lit when link is present.

Operating Mode

- Scanning: If the SM/BHS is not registered to AP/BHM, then these three LEDs cycle on and off from left to right (SYN/1, SES/2 and GPS/3).
- Ethernet Link:
 - For 450m AP, the MAIN LNK + ACT/5 LED is active when the Main port link is present and the AUX LNK + ACT/4 LED is active when the Aux port link is present.
 - For 450/450i AP/BHM, the MAIN LNK/5 LED is lit continuously when the link is present.
 - For 450/450i SM/BHS, the MAIN LNK/5 LED is lit continuously when the link is present.
- Data Transfer:
 - For 450m AP, the MAIN LNK + ACT/5 LED flashes to indicate data transfer speed and activity on the Main port and the AUX LNK + ACT/4 LED flashes to indicate data transfer speed and activity on the Aux port.
 - For 450/450i AP/BHM, the ACT/4 LED flashes during data transfer.
 - For 450/450i SM/BHS, the ACT/4 LED flashes during data transfer.
 - For 450b SM, the LNK/SPD/ACT/4 LED flashes during data transfer.

Aiming Mode

The 3 LEDs (SYN/1, SES/2, and GPS/3) are turned into a 3-position bar graph. The more LEDs that are lit, the better the received power the module is seeing. The colors of the LEDs have no particular meaning other than to assist in distinguishing one position from the next.

Power supply options

The 450 Platform Family ODUs are powered over its Main Ethernet cable using Power Over Ethernet (POE). The power injector is connected to the ODU and network terminating equipment using Cat5e cable with RJ45 connectors.

Power supply – PMP 450m Series

The PMP 450m Series - AP supports powering from AC+DC Enhanced Power Injector (see [AC+DC Enhanced Power Injector](#) on page 2-23)

- PSU part numbers

Table 25 PSU part numbers for PMP 450m AP

Cambium description	Cambium part number
AC+DC Enhanced Power Injector	C000065L002C

Power supply – PMP/PTP 450i Series

The PMP/PTP 450i Series supports powering from the following powering sources:

- Power Supply, 60 W, 56 V with 1000BASE-T or GigE
- AC+DC Enhanced Power Injector
- Power over Ethernet midspan, 60 W, -48 VDC Input
- CMM4 with external 56 V power supply and CMM4 to 450i Series ODU cable (Dongle)
- IEEE802.3at power injector



Note

The 900 MHz SM is based off of the 450 Series , please see [Power supply – PMP/PTP 450 Series](#) on page 2-27.



Warning

Always use an appropriately rated and approved AC supply cord-set in accordance with the regulations of the country of use.



Warning

The PMP 450 Ruggedized High Gain Integrated Subscriber Module (Cambium part numbers C035045C014A and C036045C014A), while encapsulated in a 450i-type enclosure, contains 450 circuitry which must be powered via 30 VDC. Powering these SMs with a 56 VDC will damage the device.

Please refer to [Cabling](#) on Page 2-35 for details on maximum cable lengths between power injector and PMP/PTP 450i.

○ PSU part numbers

Table 26 PSU part numbers for PMP/PTP 450i Series

Cambium description	Cambium part number
Power supply, 60 W, 56 V with Gbps support	N000065L001B
AC+DC Enhanced Power Injector	C000065L002C
Line Cord, Fig 8 – US	N000065L003A
Line Cord, Fig 8 – UK	N000065L004A
Line Cord, Fig 8 – EU	N000065L005A
Power over Ethernet midspan, 60 W, -48 VDC Input	N000000L036A
Power supply, 30 W, 56 V – Gbps support	N000000L034A

- **AC Power Injector N00065L001B**

The AC Power Injector interfaces are shown in [Figure 15](#) and described in [Table 27](#).

Figure 15 AC Power Injector interfaces



Table 27 AC Power Injector interface functions

Interface	Function
AC power in	AC power input (main supply)
ODU	RJ45 socket for connecting Cat5e cable to ODU
LAN	RJ45 socket for connecting Cat5e cable to network
Power (green) LED	Power supply detection

- AC+DC Enhanced Power Injector C000065L002C

The AC+DC Enhanced Power Injector interfaces are shown in [Figure 16](#) and described in [Table 28](#).

Figure 16 AC+DC Enhanced Power Injector interfaces

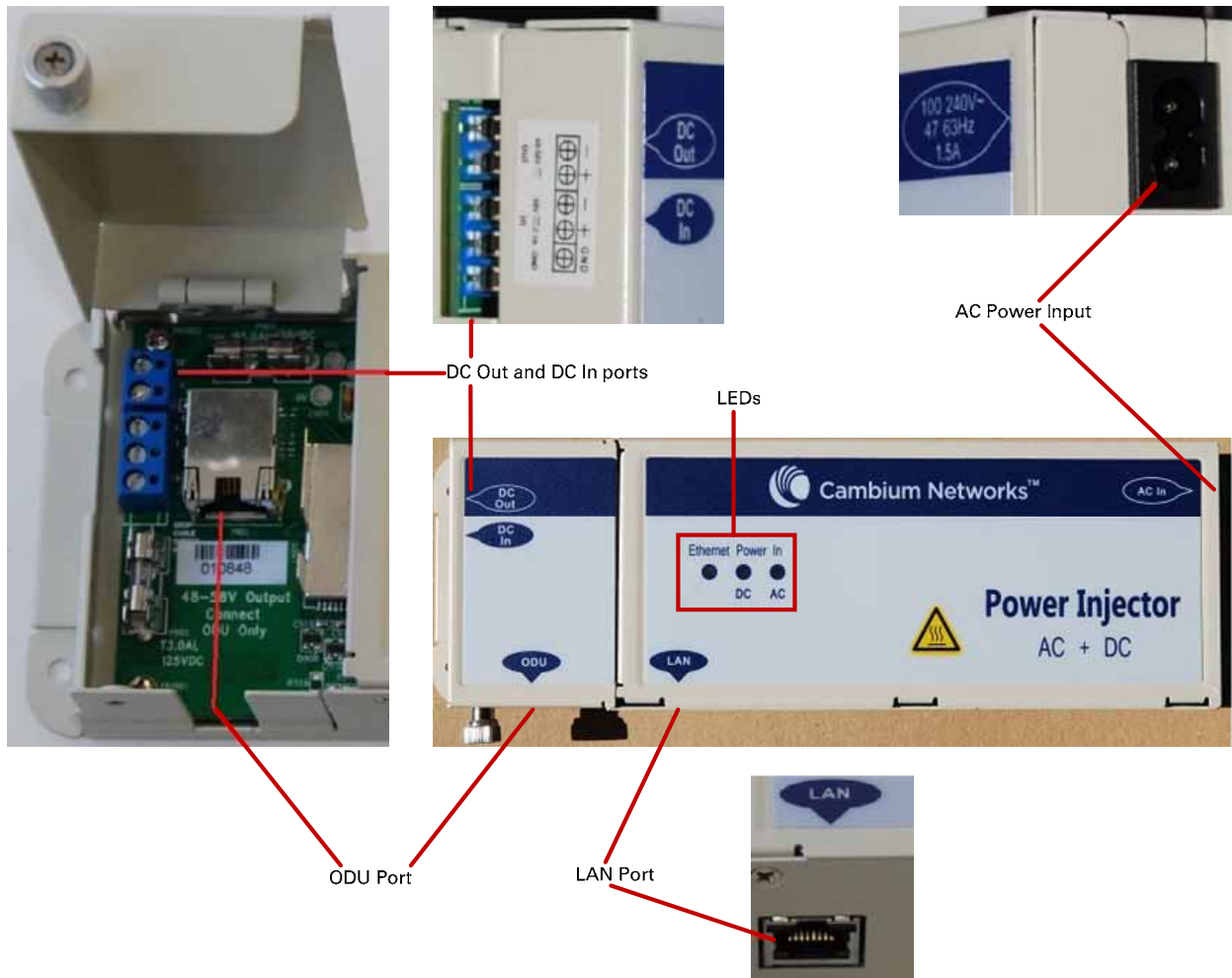

Table 28 AC+DC Enhanced Power Injector interface functions

Interface	Function
100-240V 47-63Hz 1.7A	AC power input (main supply)
DC In	Alternative DC power supply input
DC Out	DC power output to a second PSU (for power supply redundancy) or to a NIDU
ODU	RJ45 socket for connecting Cat5e cable to ODU
LAN	RJ45 socket for connecting Cat5e cable to network
Power - AC (green) LED	Indicates power is applied at the AC power input
Power - DC (green) LED	Indicates power is applied at the DC In port
Ethernet (yellow) LED	Detects Ethernet traffic and it is used with PTP650 and PTP700 families only. It does not operate with the 450 platform products.

**Note**

The earlier power injector models only had a single power LED that combined the AC+DC indications.

- **-48 VDC Power Injector N000000L036A**

The DC Power Injector interfaces are shown in [Figure 17](#) and described in [Table 29](#).

Figure 17 -48 V DC Power Injector interfaces



Table 29 -48V DC Power Injector interfaces

Interface	Function
DC input	36 to 60V, 2A
RJ 45 Sockets	Two (Data In and Data & Power Out)
LEDs	Two (AC and Port)

Power supply – PMP 450b Series

The PMP 450b Series support powering from the following powering sources:

- Gigabit Enet Capable Power Supply – 20 to 32 V DC, 15W
- CMM4 with external 29 V power supply

Figure 18 -20 to 32 VDC Power Injector interfaces



Table 30 -Power Injector interfaces

Interface	Function
PSU/Ethernet	20 to 32 VDC, 2A

○ PSU part numbers

Table 31 PSU part numbers for PMP 450b SM

Cambium description	Cambium part number
Gigabit Enet Capable Power Supply - 20 - 32VDC, 15W	N000900L001C

Power supply – PMP/PTP 450 Series

The PMP/PTP 450 Series support powering from the following powering sources:

- Gigabit Enet Capable Power Supply – 30 VDC, 15W
- CMM4 with external 29 V power supply



Warning

The PMP 450 Ruggedized High Gain Integrated Subscriber Module (Cambium part numbers C035045C014A and C036045C014A), while encapsulated in a 450i-type enclosure, contains 450 circuitry which must be powered via 30VDC. Powering these SMs with a 56 VDC will damage the device.

○ PSU part numbers

Table 32 PSU part numbers for PMP/PTP 450 Series

Cambium description	Cambium part number
Gigabit Enet Capable Power Supply - 30VDC, 15W	N000900L001C
Cable, UL Power Supply Cord Set, US	N000900L007A
Cable, UL Power Supply Cord Set, EU	N000900L008A
Cable, UL Power Supply Cord Set, UK	N000900L009A
Cable, UL Power Supply Cord Set, Brazil	N000900L010A

○ Gigabit Enet Capable Power Supply

The Gigabit Enet Capable power supply interfaces are described in [Table 33](#). This power supply requires procurement of an AC line cord that connects the outlet of the same (using IEC-60320 Type 5 connector). A list of available power supply cord options from Cambium Networks are given in [Table 32](#).

Table 33 –Gigabit Enet Capable power supply

Interface	Function
AC Input	90-264 VAC, 0.5A rms @ 120VAC/ 0.25A rms @ 240VAC, 47 to 63 Hz
DC Output	30.0 Vdc +/-5%, 15W, 500 mA max
RJ 45 Sockets	Two (Data In and Data & Power Out)
LEDs	Green, :LED Intensity determined by Level 5 efficiency

Figure 19 Gigabit Enet Capable power supply



ODU mounting brackets & accessories

The list of supported brackets is provided in [Table 34](#).

- The "Tilt bracket assembly" is the recommended bracket for the AP, SM or BH integrated units.
- The "Mounting Bracket (Connectorized)" can be used where a low profile and ease of assembly of Connectorized AP, SM or BH is required.
- The "Mounting Bracket (Integrated)" provide a wider range of adjustment for AP, SM and BH integrated devices.

Table 34 Accessories part numbers

Cambium description	Cambium part number
Mounting brackets	
Tilt Bracket Assembly	N000045L002A
Mounting Bracket (Integrated)	N000065L031A
Mounting Bracket (Connectorized)	N000065L032A
Miscellaneous	
Ethernet cable adapter for CMM4 (Dongle)	N000045L001A
RJ-45 Gland Spare – PG16 style (QTY 10)	N000065L033A
Blanking Plug Pack (Qty 10)	N000065L036A

Lightning protection

The 450 Platform Family supports the lightning protection units listed in [Table 35](#).

The LPU offers the highest level of protection and is the recommended device. Where low cost deployment is essential, for example for SM in residential application, the Gigabit Surge Suppressor may be used instead.

Table 35 Lightning protection part numbers

Cambium description	Cambium part number
450 Series (Including 450b and 450d)	
Surge Suppressor (30 VDC)	600SSH
450i and 450m Series	
LPU and Grounding Kit (1 kit per ODU)	C000065L007B
Gigabit Surge Suppressor (56 VDC)	C000000L033A

ODU interfaces

PMP 450m Series AP

These interfaces are described in [Table 37](#).

Figure 20 PMP 450m Series - AP rear interfaces



Table 36 PMP 450m Series – AP rear interfaces

Port name	Connector	Interface	Description
PSU (Main)	RJ45	PoE input	Power over Ethernet (PoE).
		10/100/1000 BaseT Ethernet	Data
Aux	RJ45	10/100 BaseT Ethernet	Data
		PoE output	Standard IEEE802.3at PoE.
		Sync input/output	Connection and powering of UGPS Sync input
SFP	SFP	2.5 Gbps Copper and 1 Gbps Fiber Ethernet	Data and Management Services. Plug-in SFP module must be purchased separately.

Ground Lugs	10 AWG copper wire	For grounding the unit
-------------	--------------------	------------------------

PMP/PTP 450i

The Ethernet and Sync/AUX ports are on the rear of the integrated and connectorized ODUs ([Figure 21](#)). These interfaces are described in [Table 37](#).

Figure 21 PMP/PTP 450i Series - ODU rear interfaces



Table 37 PMP/PTP 450i Series – ODU rear interfaces

Port name	Connector	Interface	Description
Main PSU	RJ45	PoE input	Power over Ethernet (PoE).
		10/100/1000BASE-T Ethernet	Data
Sync/AUX	RJ45	10/100/1000BASE-T Ethernet	Data (see Note below)
		PoE output	Standard IEEE802.3at PoE.
		Sync input/output	Connection and powering of UGPS Sync input

The front of the connectorized ODU ([Figure 22 PMP/PTP 450i Series – Connectorized ODU antenna interfaces](#)) provides N type female connectors for RF cable interfaces to antennas with ports A and B for vertical and horizontal polarization respectively.

Figure 22 PMP/PTP 450i Series – Connectorized ODU antenna interfaces



PMP 450b SM (Mid Gain)

The Ethernet and AUX ports are on the rear of the integrated and connectorized ODU's (Figure 23). These interfaces are described in Table 38.

Figure 23 PMP 450b SM (Mid Gain) - ODU rear interfaces



Table 38 PMP 450b SM (Mid Gain) – ODU rear interfaces

Port name	Connector	Interface	Description
PSU/Ethernet Port	RJ45	PoE input	Power over Ethernet (PoE).
		10/100/1000BASE-T Ethernet	Data
Audio AUX Port	Standard 3.5 mm headphones	Alignment tone input	3.5 mm audio jack for alignment tone

PMP 450b SM (High Gain)

The Ethernet and AUX ports are on the rear of the integrated and connectorized ODUs (Figure 23). These interfaces are described in Table 38.

Figure 24 PMP 450b SM (High Gain) - ODU rear interfaces



Table 39 PMP 450b SM (High Gain) – ODU rear interfaces

Port name	Connector	Interface	Description
PSU/Ethernet Port	RJ45	PoE input	Power over Ethernet (PoE).
		10/100/1000BASE-T Ethernet	Data
Audio AUX Port	Standard 3.5 mm headphones	Alignment tone input	3.5 mm audio jack for alignment tone

Cabling

Ethernet standards and cable lengths

All configurations require a copper Ethernet connection from the ODU (Main PSU port) to the Power supply.

Table 40 PSU drop cable length restrictions

System configuration		Maximum cable length (m/ft)	
		From power supply to ODU	From ODU to PoE device on AUX/SYNC port
Power supply (30W)	None	100 m	N/A
	IEEE 802.3at Type 2	Not supported	
AC Power Injector (60W)	None	100 m	N/A
	IEEE 802.3at Type 2	100 m in total	
AC+DC enhanced Power Injector	None	100 m	N/A
	IEEE 802.3at Type 2	100 m in total	
-48 V DC power injector	None	100 m	N/A
	IEEE 802.3at Type 2	100 m in total	
CMM4 with 56 V supply	None	100 m	N/A
	IEEE 802.3at Type 2	Not supported	
IEEE802.3at compliant supply	None	100 m	N/A
	IEEE 802.3at Type 2	Not supported	



Note

The Ethernet connectivity for CMM4 requires the part “Ethernet cable adapter for CMM4 – N000045L001A”.

Outdoor copper Cat5e Ethernet cable

Outdoor Cat5e cable is used for all connections that terminate outside the building. For example, connections between the ODU, surge suppressors (if installed), UGPS receivers (if installed) and the power supply injector. This is known as a “drop cable” (Figure 25).

The following practices are essential to the reliability and longevity of cabled connections:

- Use only shielded cables and connectors to resist interference and corrosion.
- For vertical runs, provide cable support and strain relief.
- Include a 2 ft (0.6 m) service loop on each end of the cable to allow for thermal expansion and contraction and to facilitate terminating the cable again when needed.
- Include a drip loop to shed water so that most of the water does not reach the connector at the device.
- Properly crimp all connectors.
- Use dielectric grease on all connectors to resist corrosion.

Order Superior Essex type BBDGe cable from Cambium Networks (Table 41). Other lengths of this cable are available from Superior Essex.

Figure 25 Outdoor drop cable

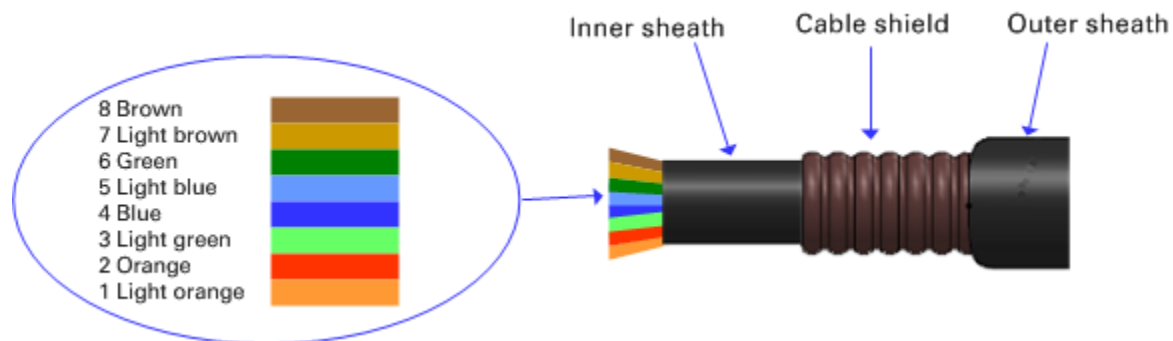

Table 41 Drop cable part numbers

Cambium description	Cambium part number
1000 ft Reel Outdoor Copper Clad CAT5E	WB3175
328 ft (100 m) Reel Outdoor Copper Clad CAT5E	WB3176

SFP module kits

SFP module kits allow connection of a PMP 450 Series ODU to a network over an Optical Gigabit Ethernet interface (1000BASE-LX or 1000BASE-SX) full-duplex mode.



Note

PMP 450m supports Fiber SFPs from system release 15.0.3.

Order SFP module kits from Cambium Networks ([Table 42](#)).

Table 42 SFP module kit part numbers

Cambium description	Cambium part number
Single Mode Optical SFP Interface per ODU	C000065L008A
Multi-mode Optical SFP Interface per ODU	C000065L009A
2.5GBASE-T Copper SFP Interface per ODU	C000065L011A

To compare the capabilities of the two optical SFP modules, refer to [Table 43](#) and [Table 44](#).

Table 43 Single Mode Optical SFP Interface per ODU (part number C000065L008)

Core/ cladding (microns)	Mode	Bandwidth at 1310 nm (MHz/km)	Maximum length of optical interface	Insertion loss (dB)
62.5/125	Multi	500	550 m (1800 ft)	1.67
50/125	Multi	400	550 m (1800 ft)	0.07
50/125	Multi	500	550 m (1800 ft)	1.19
10/125	Single	N/A	5000 m (16400 ft)	0.16

Table 44 Multi-mode Optical SFP Interface per ODU (part number C000065L009)

Core/ cladding (microns)	Mode	Bandwidth at 850 nm (MHz/km)	Maximum length of optical interface	Insertion loss (dB)
62.5/125	Multi	160	220 m (720 ft)	2.38
62.5/125	Multi	200	275 m (900 ft)	2.6
50/125	Multi	400	500 m (1640 ft)	3.37
50/125	Multi	500	550 m (1800 ft)	3.56

The upgrade kits contain the following components:

- Optical SFP transceiver module (Figure 26)
- Long EMC strain relief cable gland (Figure 27)
- The *Ethernet SFP Module Installation Guide*
- License key instructions and an entitlement key

Figure 26 Optical SFP transceiver module



Figure 27 Long cable gland



Main Ethernet port

The PoE cable pinout diagram for Main port is given below.

Table 45 Main port PoE cable pinout

RJ45 pin	Interface	Ethernet description	PoE input description
1	1000 BaseT Ethernet with PoE In	+TxRx0	+Ve or -Ve
2		-TxRx0	
3		+TxRx1	+Ve or -Ve
6		-TxRx1	
4		+TxRx2	+Ve or -Ve
5		-TxRx2	
7		+TxRx3	+Ve or -Ve
8		-TxRx3	



Note

The PoE input on the Main port accepts any polarity.

Aux port

Table 46 Aux port PoE cable pinout

RJ45 pin	Interface	Signal description	PoE output description
1	100 BaseT Ethernet with PoE Out (see note below)	+TxRx0	-Ve
2		-TxRx0	
3		+TxRx1	+Ve
6		-TxRx1	
4	GPS and alignment tone	GPS power out, Alignment tone out, GPS data out	N/A
5		GPS data in	
7		GPS 0v	
8		GPS Sync in	

**Note**

PMP 450m Series - AP Aux port supports only alignment and sync functionalities in current 15.0/15.0.3 release.

**Note**

If the Aux port will be used, a second Ethernet gland will need to be ordered (Part Number: N000065L033A).

Aux port to alignment tone headset wiring

A standard 32 ohms stereo headset can be connected to the AUX port to use the audio alignment tool. The diagrams of the adapters for RJ45 and RJ12 are provided in [Figure 28](#) and [Figure 29](#) respectively. The recommended values for both resistors are 220 ohm, 0.25W. Different resistor values can be used to optimize the level of the audio signal depending on the headset characteristics and the level of ambient noise.

Figure 28 Alignment Tone Cable

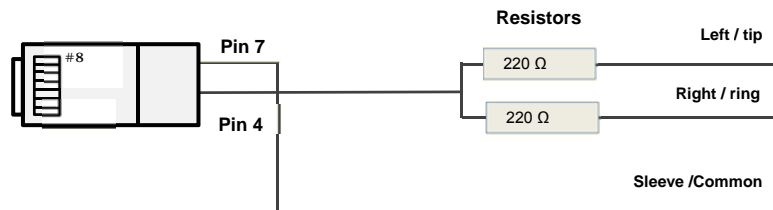

Table 47 Aux port PoE cable pinout

RJ45 pin (AUX port)	Signal description	Serial component	Jack socket (to jack plug of headset)
4	Alignment tone out	220 ohms resistor	Ring
		220 ohm resistor	Tip
7	GPS 0v	None	Sleeve

Figure 29 RJ12 Alignment Tone Cable**Table 48** RJ12 Aux port PoE cable pinout

RJ12 pin (AUX port)	Signal description	Jack socket (to jack plug of headset)
5	Alignment tone out	Tip
6	Alignment tone out	Ring

Alternatively, a readymade headset adapter can be ordered from Best-Tronics (<http://btpa.com/Cambium-Products/>) with the following part number:

Table 49 Alignment tone adapter third party product details

Reference	Product description
BT-1277	Headset alignment cable (RJ-45) for the PMP/PTP 450i Series products
BT-0674	Headset alignment cable (RJ-12) for the PMP/PTP 450 Series products.

RJ45 connectors and spare glands

RJ45 connectors are required for plugging Cat5e cables into ODUs, LPUs, PSUs and other devices. Order RJ45 connectors and crimp tool from Cambium Networks ([Table 50](#)).

The ODU is supplied with one environmental sealing gland for the drop cable. This gland is suitable for cable diameters from 5 mm to 9 mm.

Figure 30 Cable gland (part number #N000065L033)









Table 50 RJ45 connector and spare gland part numbers

Cambium description	Cambium part number
Tyco/AMP, Mod Plug RJ45, 100 pack	WB3177
Tyco/AMP Crimp Tool	WB3211
RJ-45 Spare Grounding Gland - PG16 size (Qty. 10)	N000065L033

Lightning protection unit (LPU) and grounding kit

450i and 450m Series LPUs provide transient voltage surge suppression for ODU installations. Each cable requires two LPUs, one near the ODU and the other near the linked device, usually at the building entry point (Table 51).

Table 51 LPU and grounding kit contents

<p>Lightning protection units (LPUs) LPU grounding point nuts and washers</p> 	<p>ODU to top LPU drop cable (600 mm) EMC strain relief cable glands</p> 
<p>U-bolts, nuts and washers for mounting LPUs</p> 	<p>ODU to top LPU ground cable (M6-M6)</p> 
<p>Bottom LPU ground cable (M6-M10)</p> 	<p>ODU to ground cable (M6-M10)</p> 

One LPU and grounding kit (Table 51) is required for the PSU drop cable connection to the ODU. If the ODU is to be connected to an auxiliary device, one additional LPU and grounding kit is required for the Aux drop cable. Order the kits from Cambium Networks (Table 52).

Table 52 LPU and grounding kit part number

Cambium description	Cambium part number
Aux ports LPU and Grounding Kit (One Kit Per End)	C000065L007B

Cable grounding kit

Copper drop cable shields must be bonded to the grounding system in order to prevent lightning-strike arcing (resulting in fire risk and damage to equipment).

One grounding kit (Figure 31) is required for each grounding point on the cable. Order cable grounding kits from Cambium Networks (Table 53).



Caution

To provide adequate protection, all grounding cables must be a minimum size of 10 mm² csa (8AWG), preferably 16 mm² csa (6AWG), or 25 mm² csa (4AWG).

Figure 31 Cable grounding kit



Table 53 Cable grounding kit part numbers

Cambium description	Cambium part number
Cable Grounding Kits For 1/4" And 3/8" Cable	01010419001

Antennas and antenna cabling

Antenna requirements

Each connectorized ODU requires one external antenna (normally dual-polar).

For connectorized units operating in the USA or Canada 900 MHz, 4.9 GHz, 5.1 GHz, 5.2 GHz, 5.4 GHz or 5.8 GHz bands, choose external antennas which are recommended by Cambium Networks. Do not install any other antennas.

Supported external AP antennas

The recommended AP external antennas are listed in [Table 54](#).

Table 54 List of AP external antennas

Cambium description	Cambium part number
900 MHz 13 dBi 65 degree Sector Antenna (Dual Slant)	N009045D001A
5 GHz Horizontal and Vertical Polarization Antenna for 90 Degree Sector	85009324001
5 GHz Horizontal and Vertical Polarization Antenna for 60 Degree Sector	85009325001



Note

LINKPlanner, Cambium Networks, planning tool, contains an up-to-date, exhaustive list of antennas that can be used with Cambium Products.

Supported external BH/SM antenna

The recommended PTP 450i Series BH or PMP 450/450i Series SM external antenna is listed in [Table 55](#).

Table 55 PTP 450i Series BH or PMP 450/450i Series SM external antenna

Cambium description	Cambium part number
900 MHz 12 dBi gain directional antenna (Dual Slant)	N009045D003A

RF cable and connectors

RF cable of generic type LMR-400 is required for connecting the ODU to the antenna. N type male connectors are required for connecting the RF cables to the connectorized ODU. Two connectors are required per ODU. Use weatherproof connectors, preferably ones that are supplied with adhesive lined heat shrink sleeves that are fitted over the interface between the cable and connector. Order CNT-400 RF cable and N type male connectors from Cambium Networks ([Table 56](#)).

Table 56 RF cable and connector part numbers

Cambium description	Cambium part number
50 Ohm Braided Coaxial Cable - 75 meter	30010194001
50 Ohm Braided Coaxial Cable - 500 meter	30010195001
RF Connector, N, Male, Straight for CNT-400 Cable	09010091001

Antenna accessories

Connectorized ODUs require the following additional components:

- Cable grounding kits: Order one cable grounding kit for each grounding point on the antenna cables. Refer to [Lightning protection unit \(LPU\) and grounding kit on 2-43](#)
- Self-amalgamating and PVC tape: Order these items to weatherproof the RF connectors
- Lightning arrestors: When the connectorized ODU is mounted indoors, lightning arrestors (not LPUs) are required for protecting the antenna RF cables at building entry. One arrestor is required per antenna cable. One example of a compatible lightning arrestor is the Polyphaser LSXL-ME or LSXL (not supplied by Cambium Networks).

GPS synchronization

GPS synchronization description

Cambium offers GPS synchronization to limit the network's own self-interference. The Cluster Management CMM provides Global Positioning System (GPS) synchronization to the Access Point (AP) and all associated Subscriber Modules (SM). Network operators have a choice of UGPS and CMM solutions to select the option that works best for the environment.

Universal GPS (UGPS)

The UGPS provides network synchronization for smaller networks where a CMM may not be cost effective. The UGPS provides synchronization for one or two modules so that even remote areas at the edge of the network can operate with synchronization for improved performance. The UGPS works with all Cambium PMP radios. The UGPS has a small footprint and is easy to deploy.

Figure 32 UGPS

**Note**

PMP 450/450i/450m Series - APs can power up a UGPS via the Aux/Timing port.

**Note**

PMP 450i/450b/450m Series - If two units are to get sync from the UGPS, then an external power supply is required.

If the GPS position information is required to be visible on the web GUI, then the UGPS power must be enabled on the AP; and it is safe to use both AP power and external power for a single UGPS unit.

CMM5

The CMM5 (Cluster Management Module) is the latest generation of solutions for the distribution of TDD Sync signals and “Power-over-Ethernet (PoE)” in the field. The CMM5 is a modular design with individual 4-port power injectors and an optional controller used for remote management.

Key features of the CMM5 include:

- Support for Gigabit Ethernet (1000BaseT)
- Modular and scalable from 4 ports to 32 ports
- Direct +/- 48VDC input (optional AC/DC power supplies are available from Cambium Networks)
- Uses Cambium Networks UGPS for a synchronization source
- Dual resilient power inputs
- Rack mountable
- Secure remote management when used with the optional CMM5 Controller Module
- Support for PMP 450m (cnMedusa™)
- Future support for integration into (cnMedusa™) for cloud or NOC-based management

It consists of four subsystems, described in the following sections:

- CMM5 Controller Module
- CMM5 Injector (29 volt and 56 volt versions)
- Power supply(s) (240/600 watt)
- UGPS

Cluster Management: Scenario 1

The following is a CMM5 Cluster Management scenario using four PMP 450i Access Points.

Table 57 CMM5 Cluster Management Scenario 1

Scenario	Equipment Needed	Features
Four PMP 450i Access Points	56 Volt Injector	<ul style="list-style-type: none"> • Gigabit Ethernet • Local Management Interface • +/- 48VDC Input • Broad Device Support • Rack Mountable
<ul style="list-style-type: none"> • 48 VDC Available • No management or resilience required 	UGPS	-

Figure 33 Cluster Management: Scenario 1

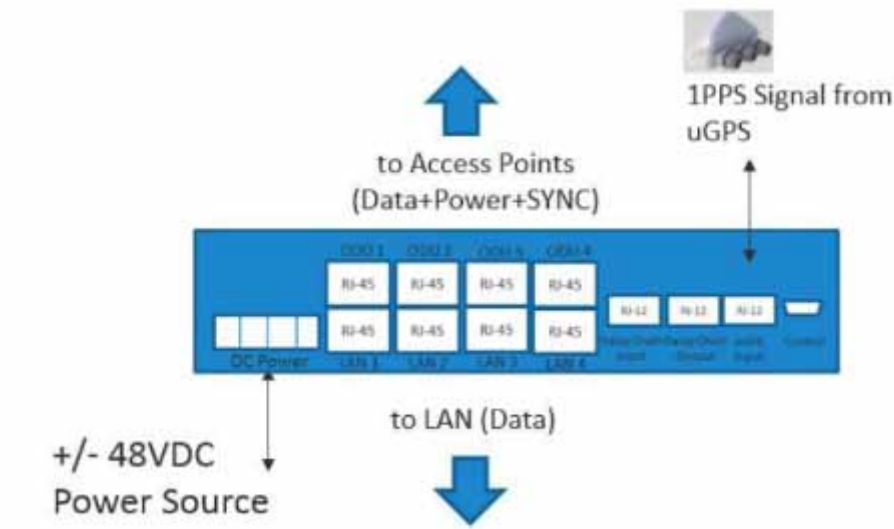

Cluster Management: Scenario 2

The following is a CMM5 Cluster Management scenario using four PMP 450i Access Points and four PMP 450 Access Points.

Table 58 CMM5 Cluster Management Scenario 2

Scenario	Equipment Needed	Features
Four PMP 450i Access Points Four PMP 450 Access Points	<ul style="list-style-type: none"> • 56 Volt Injector • 29 Volt Injector • 1 CMM5 Controller • One UGPS 	<ul style="list-style-type: none"> • Gigabit Ethernet support • Local Management Interface • +/- 48VDC Input • Broad Device Support • Rack Mountable
AC only environments	Two UGPS AC-to-48 VDC Power Supplies	Resilient power sources
Management required Resilience required	-	Secure, Remote Management (https) Scalable to 32 devices

Figure 34 Cluster Management: Scenario 2

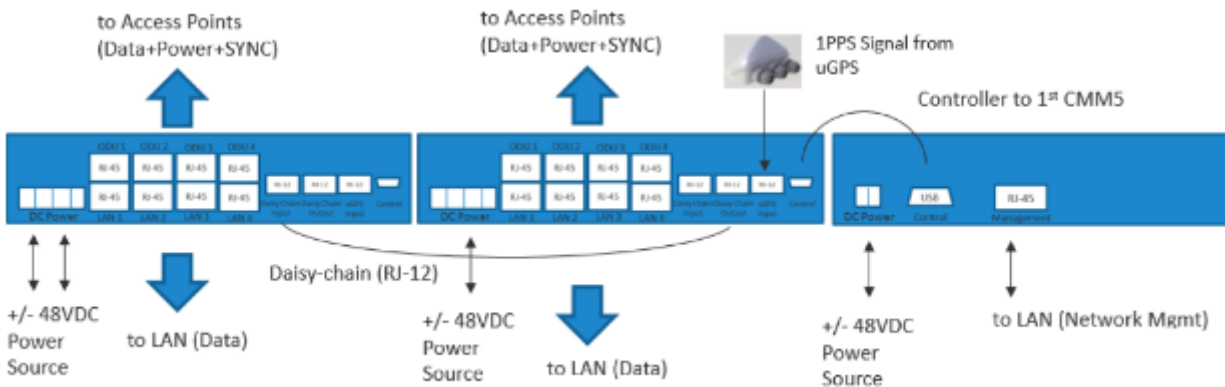

CMM5 Controller Module

The major features of the CMM5 Controller Module are:

- Auto-detect/control up to 8 Power Injectors
- Monitor SYNC/Power/GPS status
- Manage (up/down ports)
- Web (HTTPS) and SNMPv2/v3 management (SNMP on roadmap)
- 1U/ half-width rack-mount

Figure 35 Controller Module



CMM5 Injector Module

The CMM5 Injector Module has the following features:

- Stand-alone mode or used with controller for mgmt.
- +/- 48VDC input with green/amber LED's for status
- Injects SYNC pulse from UGPS
- 2U / half-width rack-mount



Note

There are two different versions of the injector module (56V and 29V). You must select the correct injector for the types of radios that you will be powering. In both cases, the injectors use the same input power supplies or can be powered with +/- 48VDC. The output power is different and the type of SYNC signal used is different between the two types of injectors. Systems can have 29V and 56V injectors deployed alongside each other.

Figure 36 Injector Module



CMM5 Injector Compatibility Matrix

The following table provides the Injector compatibility matrix.

Table 59 Injector Compatibility Matrix

Product	Power/Injector Module	Sync
PMP 450m	Yes/56V	Yes
PMP/PTP 450i	Yes/56V	Yes
PMP 450b	Yes/29V	Yes
PMP 450/PTP 450	Yes/29V	Yes
PMP 100/PTP 100	Yes/29V	Yes

CMM5 Specifications

The following table provides specifications for the CMM5 Power & Sync Injector (56 Volts).

Table 60 CMM5 Specifications

CMM5 Power and Sync Injector 56 Volts	
Model Number	C000000L556A
Data Interface	4 each RJ45 Gigabit Powered output ports "To Radios" 4 each RJ45 Gigabit Data input ports "To Switch Array" 1 each GPS timing port (RJ-12) 1 each CMM5 USB Serial port for local administration 1 each RJ12 Daisy Chain port "IN" 1 each RJ12 Daisy Chain port "OUT"
Surge Suppression	Lightning Suppression for each "To Radios" RJ45 Port
Power	Input Voltage: + or - 48 VDC Input Power Consumption: 400 watts Output Voltage: + or - 55 VDC Output Current: 0 - 1.8A per channel Output Power: 0 - 90 Watts per channel
Cabinet Temperature	-40° C to +55°C (-40° F to +131° F), 90% humidity, condensing
Physical	Max Distance from Managed Radios: 328 cable feet (100m) Max Distance to GPS Antenna: 100 cable feet (30.5m)
Dimensions	8.85" W x 15.75" D x 1.65" H (225mm x 400mm x 42mm)
Unit Weight	6.6 pounds (3kg)
Power Interface Terminals	2 Power input ports for 48 VDC Power (Power supplies sold separately)

CMM4 (Rack Mount)

The Cluster Management Module (CMM) is the heart of the Cambium system's synchronization capability, which allows network operators to reuse frequencies and add capacity while ensuring consistency in the quality of service to customers.

For operators who prefer indoor CMM mounting, Cambium offers the Rack-Mounted Cluster Management Module 4. The unit is designed to be mounted onto a standard 19-inch telecommunications rack and to allow the Cambium CMM4 to be co-located with other telecommunications equipment.

Figure 37 CMM4 (Rack Mount)



The CMM4 has two DC power inputs, one 29 V and one 56V. It can be used to power and synchronize both 29 V legacy products such as the PMP 450 Series and 56V products such as the PMP 450i Series simultaneously.

If the 29 V legacy products are connected to the CMM4, a 29 V power supply needs to be connected.

If the 450i Series is connected to the CMM4, a 56 V power supply needs to be connected. The CMM4 supports having two of the 56 V and two of the 29 V supplies for redundancy.



Warning

PMP 450i Series requires different wiring between the CMM4 and device. If a PMP450 Series ODU is replaced by a PMP 450i Series and the existing drop cable needs to be re-used, the Ethernet cable adapter for CMM4 - N000045L001A" must be used between the CMM4 and the existing drop cable.

Figure 38 CMM4 56 V power adapter (dongle)



CMM4 56 V power adapter cable pinout

Figure 39 CMM4 power adapter cabling diagram

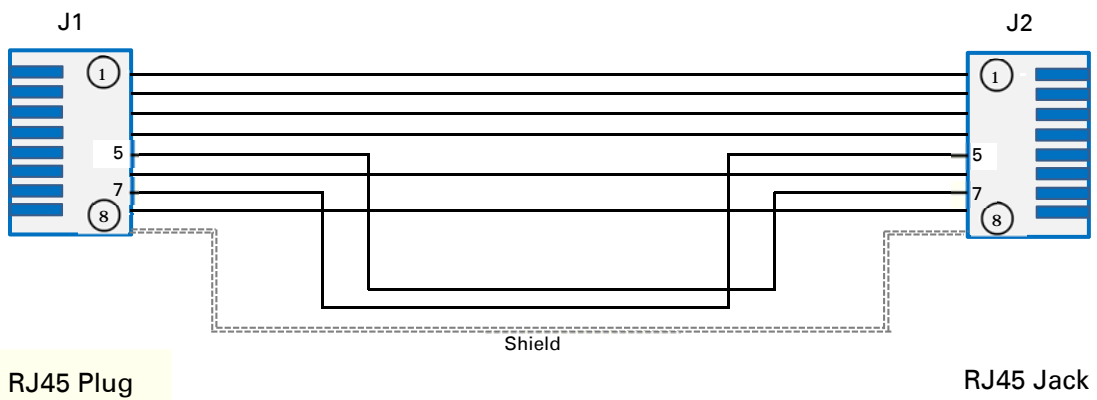

Table 61 CMM4 power adapter cable pinout

Plug J1 pin	Jack J2 pin
1	1
2	2
3	3
4	4
5	7
6	6
7	5
8	8
Screen	Screen



Note

Pins 5 and 7 are wired in a cross-over configuration.

CMM4 (Cabinet with switch)

Designed to deliver consistent and reliable wireless broadband service, the PMP/PTP system gracefully scales to support large deployments. The cluster management module is the heart of the system's synchronization capability which allows network operators to re-use frequencies and add capacity while ensuring consistency in the quality of service to customers. As a result, subscribers can experience carrier-grade service even at the outer edge of the network.

Figure 40 CMM4 (Cabinet with switch)



CMM4 (Cabinet without switch)

This CMM includes all the functionality listed above but there is no switch. This provides the network operator the flexibility to use the switch of their choice with the power and synchronization capabilities of the CMM4.

CMM3/CMMmicro

The CMM3 or CMMmicro (Cluster Management Module micro) provides power, GPS timing, and networking connections for an AP cluster. The CMM3 is configurable through a web interface.

The CMM3 contains an 8-port managed switch that supports Power over Ethernet (PoE – this is Cambium PoE, not the standard PoE) on each port and connects any combination of APs, BHMs, BHSs, or Ethernet feed. The Cambium fixed wireless broadband IP networks PoE *differs from* IEEE Standard 803.3af PoE, and the two should not be intermixed. The CMM3 can auto-negotiate speed to match inputs that are either 100Base-TX or 10Base-T, and either full duplex or half duplex, where the connected device is set to auto-negotiate. Alternatively, these parameters are settable.

A CMM3 requires only one cable, terminating in an RJ-45 connector, for each connected module to distribute

- Ethernet signaling.
- power to as many as 8 co-located modules—APs, BHMs, or BHSs. Through a browser interface to the managed switch, ports can be powered or not.
- sync to APs and BHMs. The CMM3 receives 1-pulse per second timing information from Global Positioning System (GPS) satellites through an antenna (included) and passes the timing pulse embedded in the 24-V power to the connected modules.

GPS status information is available at the CMM3, however

- CMM3 provides time and date information to BHMs and APs if both the CMMmicro is operating on CMMmicro Release 2.1 or later and the AP/BHM is operating on System Release 4.2 or later. See [Configuring time settings](#) on Page 7-18.
- CMM3 *does not* provide time and date information to BHMs and APs if either the CMM3 is operating on a release earlier than CMMmicro Release 2.1 or the AP/BHM is operating on a release earlier than System Release 4.2.

A CMM3/CMMMicro is shown in [Figure 41](#) and [Figure 42](#).

Figure 41 CMM3

Figure 42 Pole mounted CMM3



Note

A CMM3 cannot be used to power up a 450i or 450m Series ODUs.

Installing a GPS receiver

To install a GPS receiver as the timing reference source, use the following procedures:

- [Mounting the GPS receiver](#) on page 2-60
- [Cabling the GPS Antenna](#) on page 2-61
- [Installing and connecting the GPS LPU](#) on page 2-61

**Caution**

Prior to power-up of equipment, ensure that all cables are connected to the correct interfaces of the CMM4 unit and the UGPS receiver module. Failure to do so may result in damage to the equipment.

GPS receiver location

Mount the GPS receiver at a location that meets the following requirements:

- It must be possible to protect the installation as described in [Grounding and lightning protection](#) on page 3-8.
- It must have an un-interrupted view of at least half of the southern (resp. northern) sky in the northern (resp. southern) hemisphere. For a receiver mounted on a wall there must be no other significant obstructions in the view of the sky.
- It must be mounted at least 1 m (3 ft), preferably 2 m (6 ft), away from other GPS receiving equipment.
- It must not be sited in the field of radiation of co-located radio communications equipment and should be positioned at a distance of at least 3 m (10 ft) away.

Mount the UGPS receiver on the wall of the equipment building if there is a suitable location on the wall that can meet these requirements.

**Caution**

The GPS receiver is not approved for operation in locations where gas hazards exist, as defined by HAZLOC (USA) and ATEX (Europe).

Mounting the GPS receiver module on the equipment building

If mounting the GPS receiver on the equipment building ([Figure 47](#)), select a position on the wall that meets the following requirements:

- It must be below the roof height of the equipment building or below the height of any roof-mounted equipment (such as air conditioning plant).
- It must be below the lightning air terminals.
- It must not project more than 600mm (24 inches) from the wall of the building.

If these requirements cannot all be met, then the module must be mounted on a metal tower or mast.

Mounting the GPS receiver module on a metal tower or mast

If mounting the GPS receiver module on a metal tower or mast ([Figure 48](#)), select a position that meets the following requirements:

- It must not be mounted any higher than is necessary to receive an adequate signal from four GPS satellites.
- It must be protected by a nearby lightning air terminal that projects farther out from the tower than the GPS receiver module.

Mounting the GPS receiver

Mount the UGPS receiver (following manufacturer's instructions) upon either an external wall ([Figure 47](#)) or a metal tower or mast ([Figure 48](#)).

Figure 43 GPS antenna mounting



Procedure 1 Mounting the GPS receiver

- 1 Ensure that the mounting position
 - has an unobstructed view of the sky to 20° above the horizon.
 - is not the highest object at the site. (The GPS antenna does not need to be particularly high on a site, which would give it more exposure to lightning. It just needs to have an unobstructed view of the sky.)
 - is not further than 100 feet (30.4 meters) of cable from the CMM.
- 2 Select a pole that has an outside diameter of 1.25 to 1.5 inches (3 to 4 cm) to which the GPS antenna bracket can be mounted.
- 3 Place the U-bolts (provided) around the pole as shown in [Figure 45](#).
- 4 Slide the GPS antenna bracket onto the U-bolts.
- 5 Slide the ring washers (provided) onto the U-bolts.
- 6 Slide the lock washers (provided) onto the U-bolts.
- 7 Use the nuts (provided) to securely fasten the bracket to the U-bolts.

Please refer to the *PMP Synchronization Solutions User Guide* located on the Cambium website (<http://www.cambiumnetworks.com/resources/pmp-synchronization-solutions>).

Cabling the GPS Antenna

Connect the GPS coax cable to the female N-connector on the GPS antenna. Please refer to the *PMP Synchronization Solutions User Guide* located on the Cambium website (<http://www.cambiumnetworks.com/resources/pmp-synchronization-solutions>).

Installing and connecting the GPS LPU

Install and ground the GPS drop cable LPU at the building (or cabinet) entry point, as described in [Install the bottom LPU](#) on page 6-24.

Ordering the components

This section describes how to select components for 450m Series, 450i Series and 450 Series Greenfield network or 450m/450i Series network migration. It specifies Cambium part numbers for 450 Platform Family components.

Order PMP 450m Series, PMP/PTP 450i Series and PMP/PTP 450 Series ODUs from Cambium Networks.

PMP 450m

Table 62 PMP 450m Series ODU part numbers

Cambium description	Cambium part number
PMP 450m AP (Access Point)	
5 GHz PMP 450m Integrated Access Point, 90 Degree (ROW)	C050045A101A
5 GHz PMP 450m Integrated Access Point, 90 Degree (FCC)	C050045A102A
5 GHz PMP 450m Integrated Access Point, 90 Degree (EU)	C050045A103A
5 GHz PMP 450m Integrated Access Point, 90 Degree (DES Only)	C050045A104A
5 GHz PMP 450m Integrated Access Point, 90 Degree (IC)	C050045A105A

PMP 450i

Table 63 PMP 450i Series ODU part numbers

Cambium description	Cambium part number
PMP 450i AP (Access Point)	
900 MHz PMP 450i Connectorized Access Point	C009045A001A
3 GHz PMP 450i Connectorized Access Point	C030045A001A
3 GHz PMP 450i Integrated Access Point, 90 Degree	C030045A002A
3 GHz PMP 450i Connectorized Access Point, DES Only	C030045A003A
3 GHz PMP 450i Integrated Access Point, 90 Degree, DES Only	C030045A004A
5 GHz PMP 450i Connectorized Access Point (RoW)	C050045A001A
5 GHz PMP 450i Connectorized Access Point (FCC)	C050045A002A
5 GHz PMP 450i Connectorized Access Point (EU)	C050045A003A

Cambium description	Cambium part number
5 GHz PMP 450i Connectorized Access Point (DES Only)	C050045A004A
5 GHz PMP 450i Connectorized Access Point (IC)	C050045A015A
5 GHz PMP 450i AP, Integrated 90°sector antenna (RoW)	C050045A005A
5 GHz PMP 450i AP, Integrated 90°sector antenna (FCC)	C050045A006A
5 GHz PMP 450i Integrated Access Point, 90 degree (EU)	C050045A007A
5 GHz PMP 450i AP, Integrated 90°sector antenna (DES only)	C050045A008A
5 GHz PMP 450i AP, Integrated 90°sector antenna (IC)	C050045A016A
PMP 450i SM (Subscriber Module)	
3 GHz PMP 450i Connectorized Subscriber Module	C030045C001A
3 GHz PMP 450i SM, Integrated High Gain Antenna	C030045C002A
5 GHz PMP 450i Connectorized Subscriber Module	C050045C001A
5 GHz PMP 450i SM, Integrated High Gain Antenna	C050045C002A

**Note**

The 450i SM does not have license keys.

Table 64 PMP 450i ATEX/HAZLOC ODU models/part numbers

ODU model / part number	Description
ODU model	
5085CHH	450i Connectorized ATEX/HAZLOC
5085HH	450i Integrated 90 Deg Sector ATEX/HAZLOC
5095HH	450i Integrated High Gain Directional ATEX/HAZLOC
Part Number	
C050045A009A	5 GHz PMP 450i Conn Access Point (ROW), ATEX/HAZLOC
C050045A010A	5 GHz PMP 450i Conn Access Point (FCC), ATEX/HAZLOC
C050045A011A	5 GHz PMP 450i Conn Access Point (EU), ATEX/HAZLOC
C050045A012A	5 GHz PMP 450i Integrated Access Point, 90 degree (ROW), ATEX/HAZLOC
C050045A013A	5 GHz PMP 450i Integrated Access Point, 90 degree (FCC), ATEX/HAZLOC
C050045A014A	5 GHz PMP 450i Integrated Access Point, 90 degree (EU), ATEX/HAZLOC

C050045A017A	5 GHz PMP 450i Conn Access Point (IC), ATEX/HAZLOC
C050045A018A	5 GHz PMP 450i Integrated Access Point, 90 degree (IC), ATEX/HAZLOC
C050045A019A	5 GHz PMP 450i Conn Access Point (DES Only), ATEX/HAZLOC
C050045A020A	5 GHz PMP 450i Integrated Access Point, 90 degree (DES Only), ATEX/HAZLOC
C050045C003A	5 GHz PMP 450i Conn Subscriber Module, ATEX/HAZLOC
C050045C004A	5 GHz PMP 450i Integrated High Gain Antenna, ATEX/HAZLOC

PTP 450i

Table 65 PTP 450i Series ODU part numbers

Cambium description	Cambium part number
3 GHz PTP 450i END, Connectorized	C030045B001A
3 GHz PTP 450i END, Integrated High Gain Antenna	C030045B002A
3 GHz PTP 450i END, Connectorized (DES only)	C030045B003A
3 GHz PTP 450i END, Integrated Access Point, 90 degree (DES only)	C035045B004A
5 GHz PTP 450i END, Connectorized (RoW)	C050045B001A
5 GHz PTP 450i END, Connectorized (FCC)	C050045B003A
5 GHz PTP 450i END, Connectorized (EU)	C050045B005A
5 GHz PTP 450i END, Connectorized (DES only)	C050045B007A
5 GHz PTP 450i END, Connectorized (IC)	C050045B015A
5 GHz PTP 450i END, Integrated High Gain Antenna (RoW)	C050045B002A
5 GHz PTP 450i END, Integrated High Gain Antenna (FCC)	C050045B004A
5 GHz PTP 450i END, Integrated High Gain Antenna (EU)	C050045B006A
5 GHz PTP 450i END, Integrated High Gain Antenna (DES only)	C050045B008A
5 GHz PTP 450i END, Integrated High Gain Antenna (IC)	C050045B016A
Ethernet cable adapter for CMM4	N000045L001A

Table 66 PTP 450i ATEX/HAZLOC ODU models/part numbers

ODU model / part number	Description
ODU model	
5085CHH	450i Connectorized ATEX/HAZLOC
5085HH	450i Integrated 90 Deg Sector ATEX/HAZLOC
5095HH	450i Integrated High Gain Directional ATEX/HAZLOC
C050045B009A	5 GHz PTP 450i END, Connectorized (ROW), ATEX/HAZLOC
C050045B010A	5 GHz PTP 450i END, Integrated High Gain Antenna (ROW), ATEX/HAZLOC
C050045B011A	5 GHz PTP 450i END, Connectorized (FCC), ATEX/HAZLOC
C050045B012A	5 GHz PTP 450i END, Integrated High Gain Antenna (FCC), ATEX/HAZLOC
C050045B013A	5 GHz PTP 450i END, Connectorized (EU), ATEX/HAZLOC
C050045B014A	5 GHz PTP 450i END, Integrated High Gain Antenna (EU), ATEX/HAZLOC
C050045B017A	5 GHz PTP 450i END, Connectorized (IC), ATEX/HAZLOC
C050045B018A	5 GHz PTP 450i END, Integrated High Gain Antenna (IC), ATEX/HAZLOC
C050045B019A	5 GHz PTP 450i END, Connectorized (DES Only), ATEX/HAZLOC
C050045B020A	5 GHz PTP 450i END, Integrated High Gain Antenna (DES Only), ATEX/HAZLOC

PMP 450b

Table 67 PMP 450b Series ODU part numbers

Cambium description	Cambium part number
PMP 450b SM (Subscriber Module)	
5 GHz 450b Mid Gain WB SM	C050045C011A
5 GHz 450b High Gain WB SM	C050045C012A

PMP 450

Table 68 PMP 450 Series ODU part numbers

Cambium description	Cambium part number
PMP 450 AP (Access Point)	
2.4 GHz PMP 450 Connectorized Access Point	C024045A001A
2.4 GHz PMP 450 Connectorized Access Point (DES)	C024045A003A
3.5 GHz PMP 450 Connectorized Access Point	C035045A001A
3.5 GHz PMP 450 Connectorized Access Point (DES)	C035045A003A
3.6 GHz PMP 450 Connectorized Access Point	C036045A001A
3.6 GHz PMP 450 Connectorized Access Point (DES)	C036045A003A
5 GHz PMP 450 Connectorized Access Point	C054045A001A
5 GHz PMP 450 Connectorized Access Point (US only)	C054045A002A
5 GHz PMP 450 Connectorized Access Point (DES)	C054045A003A
PMP 450 AP Lite	
2.4 GHz PMP 450 Connectorized Access Point - Lite	C024045A011A
3.3-3.6 GHz PMP 450 Connectorized Access Point - Lite	C035045A011A
3.55-3.8 GHz PMP 450 Connectorized Access Point - Lite	C036045A011A
5 GHz PMP 450 Connectorized Access Point - Lite	C054045A011A
5 GHz PMP 450 Connectorized Access Point (FCC) - Lite	C054045A012A
PMP 450 SM (Subscriber Module)	
900 MHz PMP 450 Connectorized Subscriber Module	C009045C001A
2.4 GHz PMP 450 Subscriber Module, 4 Mbps	C024045C001A
2.4 GHz PMP 450 Subscriber Module, 10 Mbps	C024045C002A
2.4 GHz PMP 450 Subscriber Module, 20 Mbps	C024045C003A
2.4 GHz PMP 450 Subscriber Module, Uncapped	C024045C004A
2.4 GHz PMP 450 Connectorized Subscriber Module, 4 Mbps	C024045C005A
2.4 GHz PMP 450 Connectorized Subscriber Module, 10 Mbps	C024045C006A
2.4 GHz PMP 450 Connectorized Subscriber Module, 20 Mbps	C024045C007A
2.4 GHz PMP 450 Connectorized Subscriber Module, Uncapped	C024045C008A
3.5 GHz PMP 450 High Gain Directional Integrated Subscriber	C035045C014A
3.5 GHz PMP 450 Subscriber Module, 4 Mbps	C035045C001A

Cambium description	Cambium part number
3.5 GHz PMP 450 Subscriber Module, 10 Mbps	C035045C002A
3.5 GHz PMP 450 Subscriber Module, 20 Mbps	C035045C003A
3.5 GHz PMP 450 Subscriber Module, Uncapped	C035045C004A
3.5 GHz PMP 450 Connectorized Subscriber Module, 4 Mbps	C035045C005A
3.5 GHz PMP 450 Connectorized Subscriber Module, 10 Mbps	C035045C006A
3.5 GHz PMP 450 Connectorized Subscriber Module, 20 Mbps	C035045C007A
3.5 GHz PMP 450 Connectorized Subscriber Module, Uncapped	C035045C008A
3.6 GHz PMP 450 High Gain Directional Integrated Subscriber	C036045C014A
3.6 GHz PMP 450 Subscriber Module, 4 Mbps	C036045C001A
3.6 GHz PMP 450 Subscriber Module, 10 Mbps	C036045C002A
3.6 GHz PMP 450 Subscriber Module, 20 Mbps	C036045C003A
3.6 GHz PMP 450 Subscriber Module, Uncapped	C036045C004A
3.6 GHz PMP 450 Connectorized Subscriber Module, 4 Mbps	C036045C005A
3.6 GHz PMP 450 Connectorized Subscriber Module, 10 Mbps	C036045C006A
3.6 GHz PMP 450 Connectorized Subscriber Module, 20 Mbps	C036045C007A
3.6 GHz PMP 450 Connectorized Subscriber Module, Uncapped	C036045C008A
5 GHz PMP 450 Connectorized Subscriber Module, 4 Mbps	C054045C005A
5 GHz PMP 450 Connectorized Subscriber Module, 10 Mbps	C054045C006A
5 GHz PMP 450 Connectorized Subscriber Module, 20 Mbps	C054045C007A
5 GHz PMP 450 Connectorized Subscriber Module, Uncapped	C054045C008A
5 GHz PMP 450 Integrated Subscriber Module, 4 Mbps	C054045C001B
5 GHz PMP 450 Integrated Subscriber Module, 10 Mbps	C054045C002B
5 GHz PMP 450 Integrated Subscriber Module, 20 Mbps	C054045C003B
5 GHz PMP 450 Integrated Subscriber Module, Uncapped	C054045C004B
5 GHz PMP 450 Connectorized Subscriber Module, 4 Mbps	C054045C005B
5 GHz PMP 450 Connectorized Subscriber Module, 10 Mbps	C054045C006B
5 GHz PMP 450 Connectorized Subscriber Module, 20 Mbps	C054045C007B
5 GHz PMP 450 Connectorized Subscriber Module, Uncapped	C054045C008B
5 GHz PMP 450d Subscriber Module, 20 Mbps – 4-pack	C054045H013B
5 GHz PMP 450d Subscriber Module, Uncapped – 4-pack	C054045H014B

PTP 450

Table 69 PTP 450 Series ODU part numbers

Cambium description	Cambium part number
PTP 450 900 MHz END – Connectorized	C009045B001A
PTP 450 3.5 GHz END – Integrated	C035045B001A
PTP 450 3.5 GHz END – Connectorized	C035045B002A
PTP 450 3.5 GHz END – Integrated – DES Only	C035045B003A
PTP 450 3.5 GHz END – Connectorized – DES Only	C035045B004A
PTP 450 3.65 GHz END – Integrated	C036045B001A
PTP 450 3.65 GHz END – Connectorized	C036045B002A
PTP 450 3.65 GHz END – Integrated – DES Only	C036045B003A
PTP 450 3.65 GHz END – Connectorized – DES Only	C036045B004A
PTP 450 5 GHz END – Integrated (ROW)	C054045B001A
PTP 450 5 GHz END – Connectorized (ROW)	C054045B002A
PTP 450 5 GHz END – Integrated (ROW) – DES Only	C054045B003A
PTP 450 5 GHz END – Connectorized (ROW) – DES Only	C054045B004A
PTP 450 5 GHz END – Integrated (FCC)	C054045B005A
PTP 450 5 GHz END – Connectorized (FCC)	C054045B006A

PMP/PTP 450/450i Series Accessories

Table 70 PMP/PTP 450/450i Series Accessories

Cambium description	Cambium part number
PMP 450 AP Antenna Options	
900 MHz 65 degree Sector Antenna (Dual Slant)	N009045D001A
900 MHz 12 dBi gain directional antenna (Dual Slant)	N009045D003A
2.4 GHz Dual Slant Antenna for 60 Degree Sector	C024045D601A
3.5 GHz and 3.6 GHz Dual Slant Antenna for 90 Degree Sector	C030045D901A
5 GHz Antenna for 60 Degree Sector	85009325001
5 GHz Antenna for 90 Degree Sector	85009324001
N-type to N-type cable (16 inch length)	30009406002

Cambium description	Cambium part number
Power supplies	
Power supply, 60 W, 56 V with Gbps support	N000065L001B
AC+DC Enhanced Power Injector	C000065L002C
Line Cord, Fig 8 – US	N000065L003A
Line Cord, Fig 8 – UK	N000065L004A
Line Cord, Fig 8 – EU	N000065L005A
Power over Ethernet midspan, 60 W, -48 VDC Input	N000000L036A
Power Supply, 30 W, 56 V – Gbps support	N000000L034A
Gigabit Enet Capable Power Supply - 30VDC, 15W	N000900L001A
Cable, UL Power Supply Cord Set, US	N000900L007A
Cable, UL Power Supply Cord Set, EU	N000900L008A
Cable, UL Power Supply Cord Set, UK	N000900L009A
AP Optional Equipment	
CMM MICRO (Outdoor Enclosure) (450 only)	1070CKHH
CMM5 Controller	C000000L500A
CMM5 Power and Sync Injector 56V	C000000L556A
UGPS	1096H
CMM5 Power Supply, AC, 56V 240W	N000000L054B
CMM5 Power Supply AC, 48V, 640W	N000000L101A
CMM5 Spare Controller Cable – 1m	N000000L102A
CMM5 to UGPS Shielded Cable (20 meter)	N000000L103A
CMM5 Spare DC Power Connector (10 pack)	N000000L104A
CMM4 W/RUGGEDIZED Switch and GPS	1090CKHH
CMM4 NO Switch	1091HH
CMM4 Rack Mount Assembly	1092HH
Ethernet cable adapter for CMM4	N000045L001A
Universal GPS Module	1096H
RJ-45 Gland Spare – PG16 style (QTY 10)	N000065L033A
Blanking Plug Pack (Qty 10)	N000065L036A
SM Optional Equipment	

Cambium description	Cambium part number
Power Supply, 30 W, 56 V – Gbps support	N000000L034A
Gigabit Enet Capable Power Supply – 30 VDC, 15 W	N000900L001A
Cable, UL Power Supply Cord Set, US	N000900L007A
Cable, UL Power Supply Cord Set, EU	N000900L008A
Cable, UL Power Supply Cord Set, UK	N000900L009A
53CM Offset, Reflector Dish Kit, 4PK	HK2022A
Alignment Tool Headset	ACATHS-01A
Accessories	
Surge Suppressor (30 VDC)	600SSH
Gigabit Surge Suppressor (56 VDC)	C000000L033A
LPU and Grounding Kit (1 kit per ODU)	C000065L007B
Single Mode Optical SFP Interface per ODU	C000065L008A
Multimode Kit	C000065L009A
50 Ohm Braided Coaxial Cable - 75 meter	30010194001
50 Ohm Braided Coaxial Cable - 500 meter	30010195001
RF Connector, N, Male, Straight for CNT-400 Cable	09010091001
Tyco/AMP, Mod Plug RJ45, 100 pack	WB3177
Tyco/AMP Crimp Tool	WB3211
RJ-45 Spare Grounding Gland - PG16 size (Qty. 10)	N000065L033
Mounting brackets	
Tilt Bracket Assembly	N000045L002A
Mounting Bracket (Integrated)	N000065L031A
Mounting Bracket (Connectorized)	N000065L032A
Upgrade Keys	
PMP 450 4 To 10 Mbps Upgrade Key	C000045K002A
PMP 450 4 To 20 Mbps Upgrade Key	C000045K003A
PMP 450 4 To Uncapped Upgrade Key	C000045K004A
PMP 450 10 To 20 Mbps Upgrade Key	C000045K005A
PMP 450 10 To Uncapped MBPS Upgrade Key	C000045K006A
PMP 450 20 To Uncapped MBPS Upgrade Key	C000045K007A

Cambium description	Cambium part number
PMP 450 Lite AP to Full AP Upgrade Key	C000045K008A
Extended Warranty	
PMP 450 Platform AP Extended Warranty, 1 Additional Year	SG00TS4009A
PMP 450 Platform AP Extended Warranty, 2 Additional Years	SG00TS4017A
PMP 450 Platform AP Extended Warranty, 4 Additional Years	SG00TS4025A
PMP 450 Platform SM Extended Warranty, 1 Additional Year	SG00TS4010A
PMP 450 Platform SM Extended Warranty, 2 Additional Years	SG00TS4018A
PMP 450 Platform SM Extended Warranty, 4 Additional Years	SG00TS4026A

Chapter 3: System planning

This chapter provides information to help the user to plan a PMP/PTP 450 Platform link.

The following topics are described in this chapter:

- [Typical deployment](#) on page [3-2](#) contains diagrams illustrating typical PMP/PTP 450 Platform site deployments.
- [Site planning](#) on page [3-7](#) describes factors to be considered when planning the proposed link end sites, including grounding, lightning protection and equipment location.
- [Radio Frequency planning](#) on page [3-17](#) describes how to plan PMP/PTP 450 Platform links to conform to the regulatory restrictions that apply in the country of operation.
- [Link planning](#) on page [3-27](#) describes factors to be taken into account when planning links, such as range, path loss and throughput.
- [Planning for connectorized units](#) on page [3-30](#) describes factors to be taken into account when planning to use connectorized ODUs with external antennas in PMP/PTP 450 Platform links.
- [Data network planning](#) on page [3-32](#) describes factors to be considered when planning PMP/PTP 450 Platform data networks.
- [Network management planning](#) on page [3-40](#) describes how to plan for PMP/PTP 450 Platform links to be managed remotely using SNMP.
- [Security planning](#) on page [3-41](#) describes how to plan for PMP/PTP 450 Platform links to operate in secure mode.
- Remote AP Deployment on page [3-51](#) describes how to deploy Remote AP.

Typical deployment

This section contains diagrams illustrating typical PMP/PTP 450 Platform site deployments.

ODU with PoE interface to PSU

In the basic configuration, there is only one Ethernet interface, a copper cable for Power over Ethernet (PoE) from the PSU to the ODU (PSU port), as shown in the following diagrams: mast or tower installation (Figure 44), wall installation (Figure 45) and roof installation (Figure 46).

Figure 44 Mast or tower installation

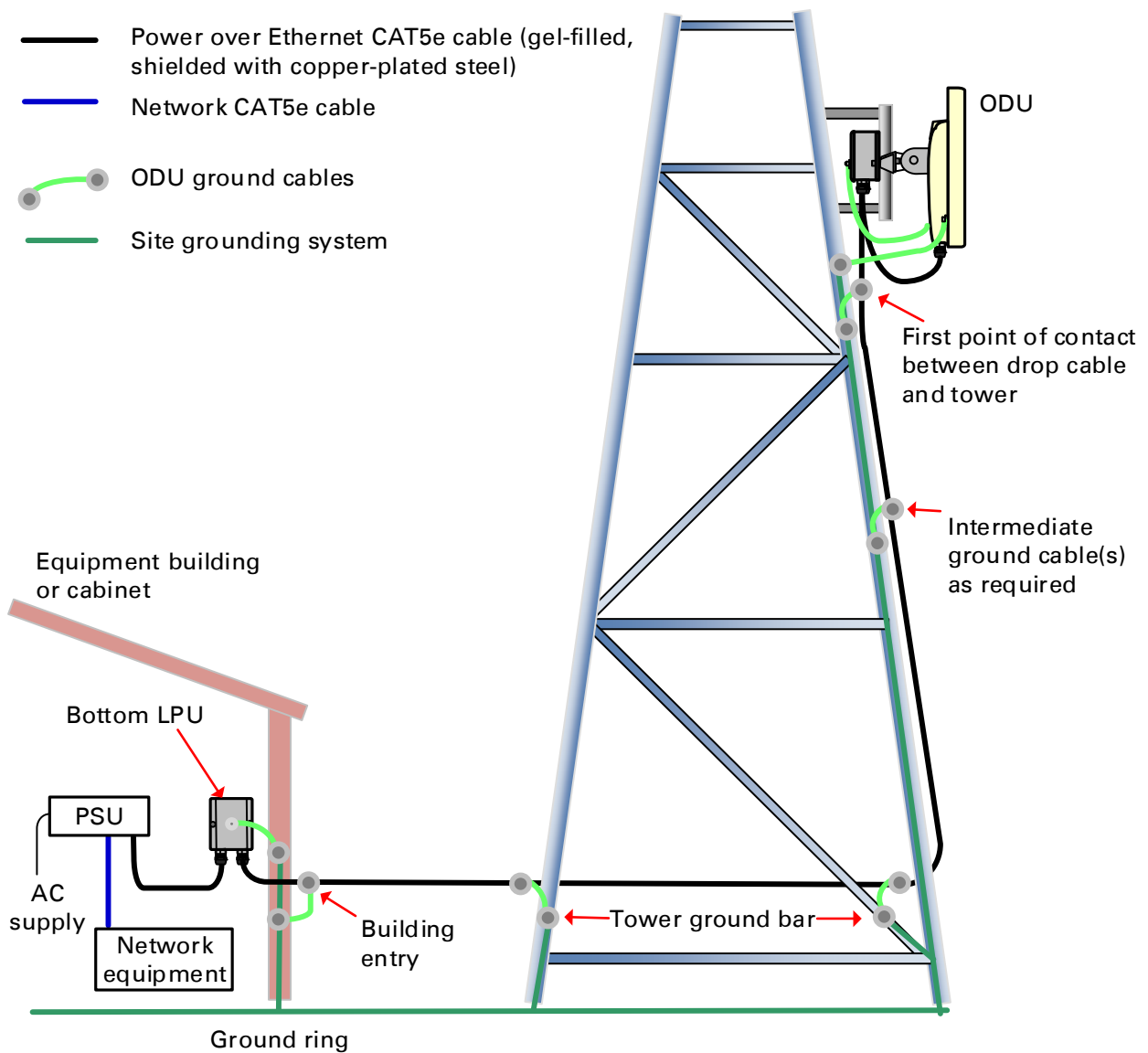

Figure 45 Wall installation

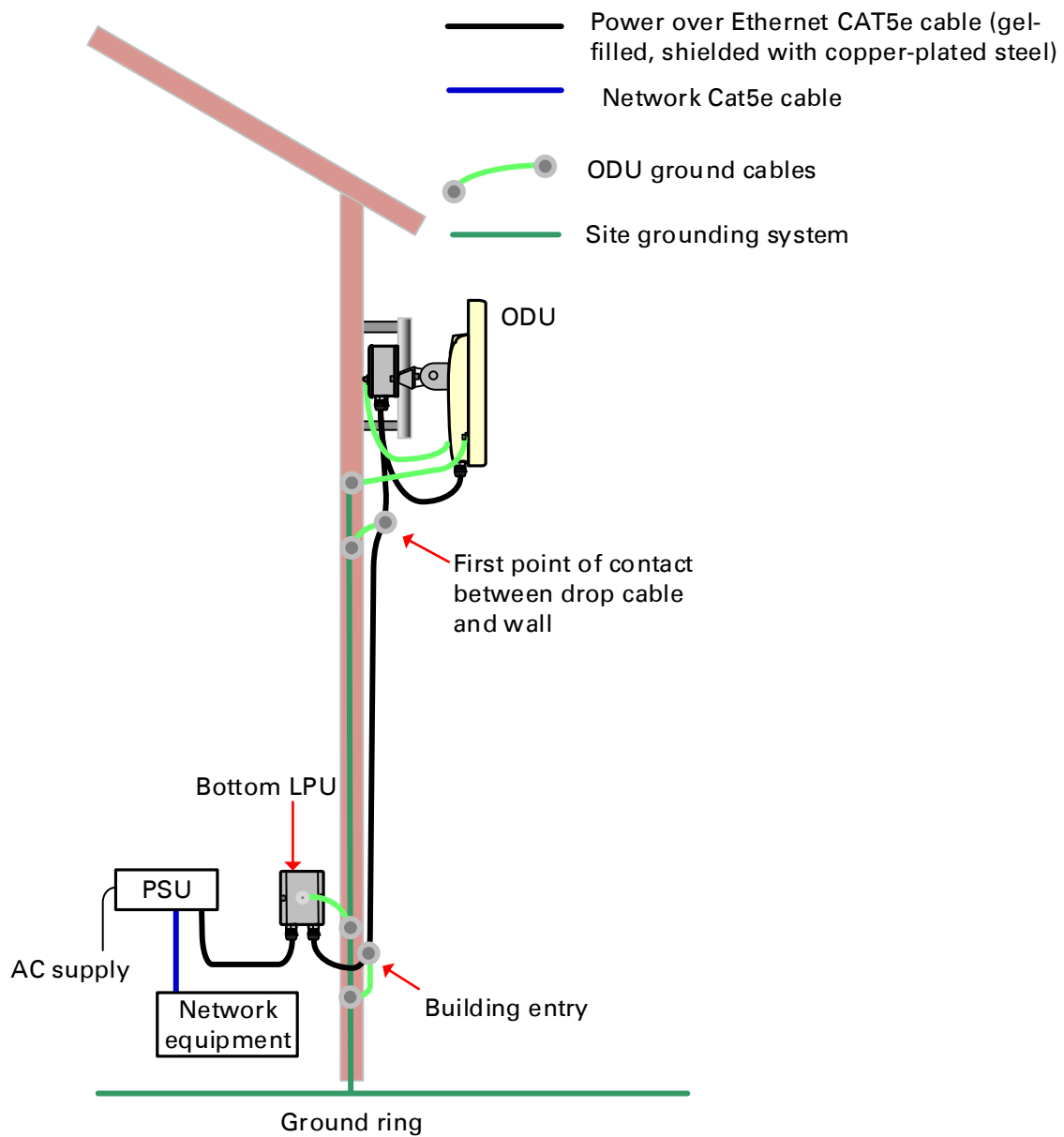

Figure 46 Roof installation

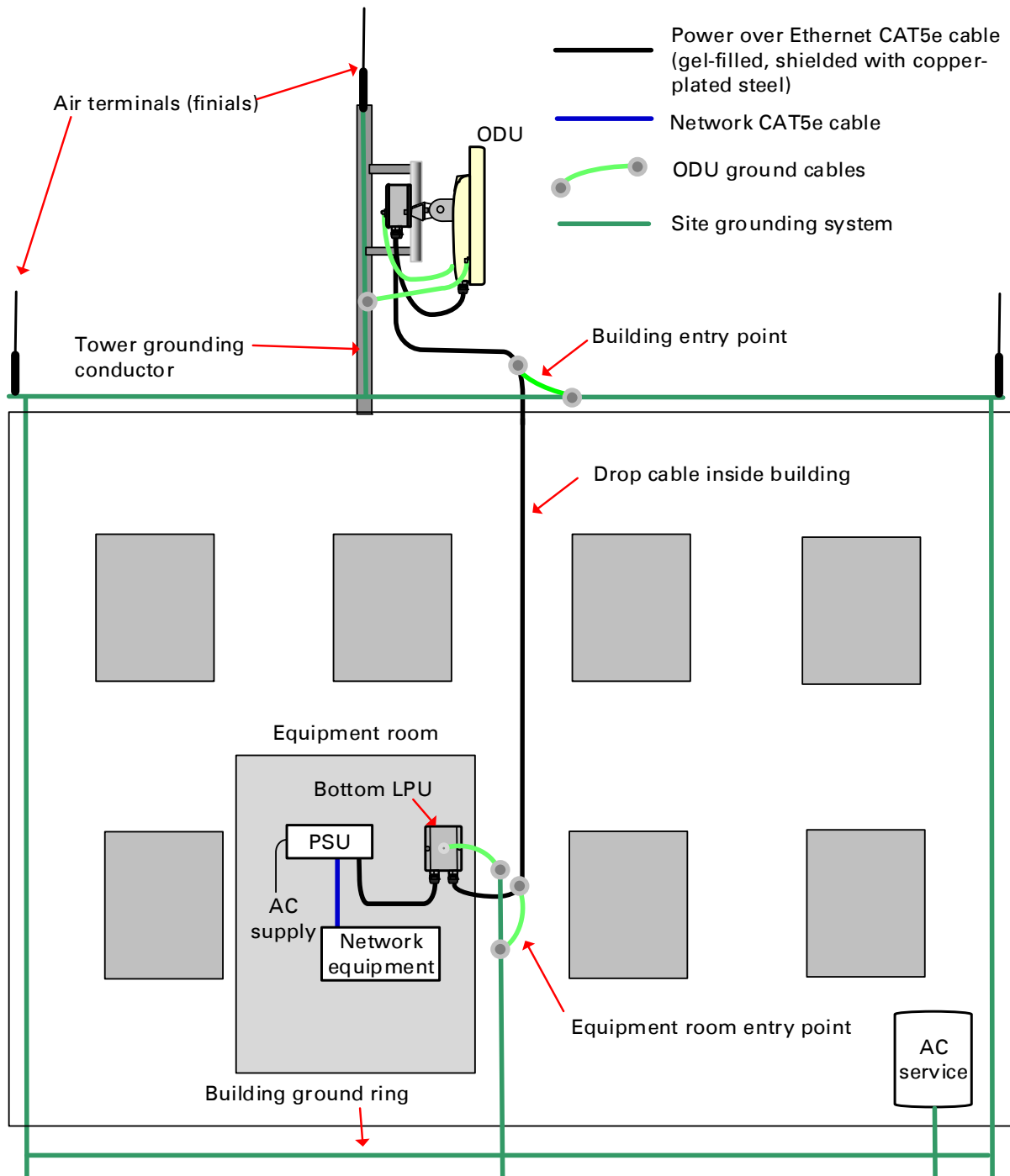

Figure 47 GPS receiver wall installation

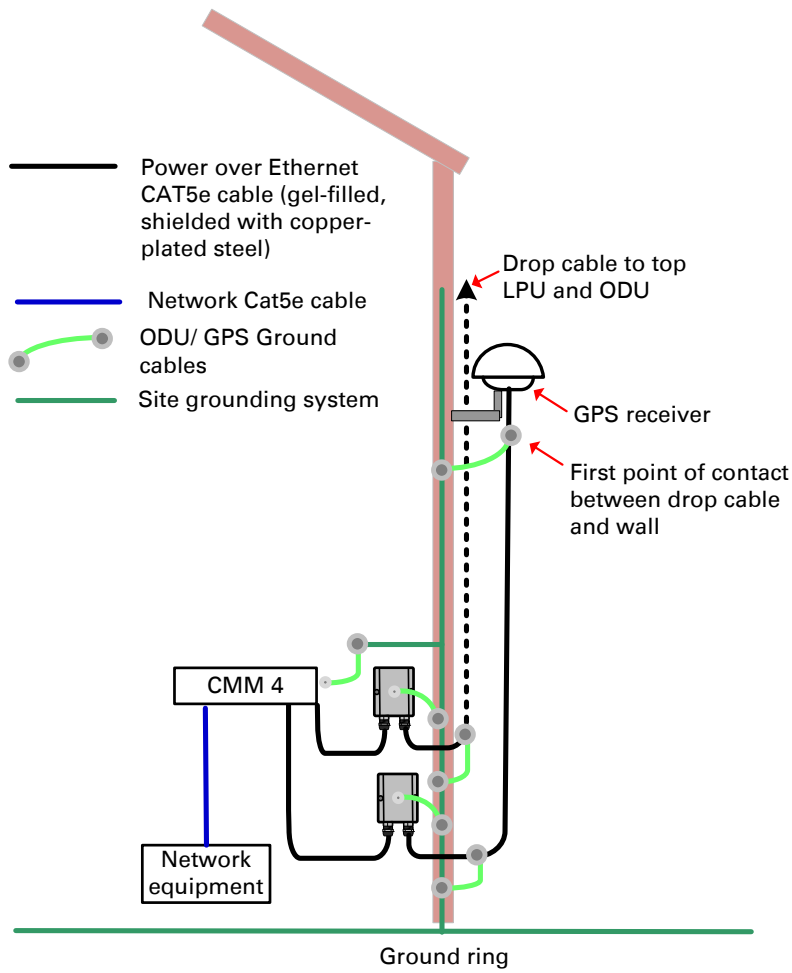
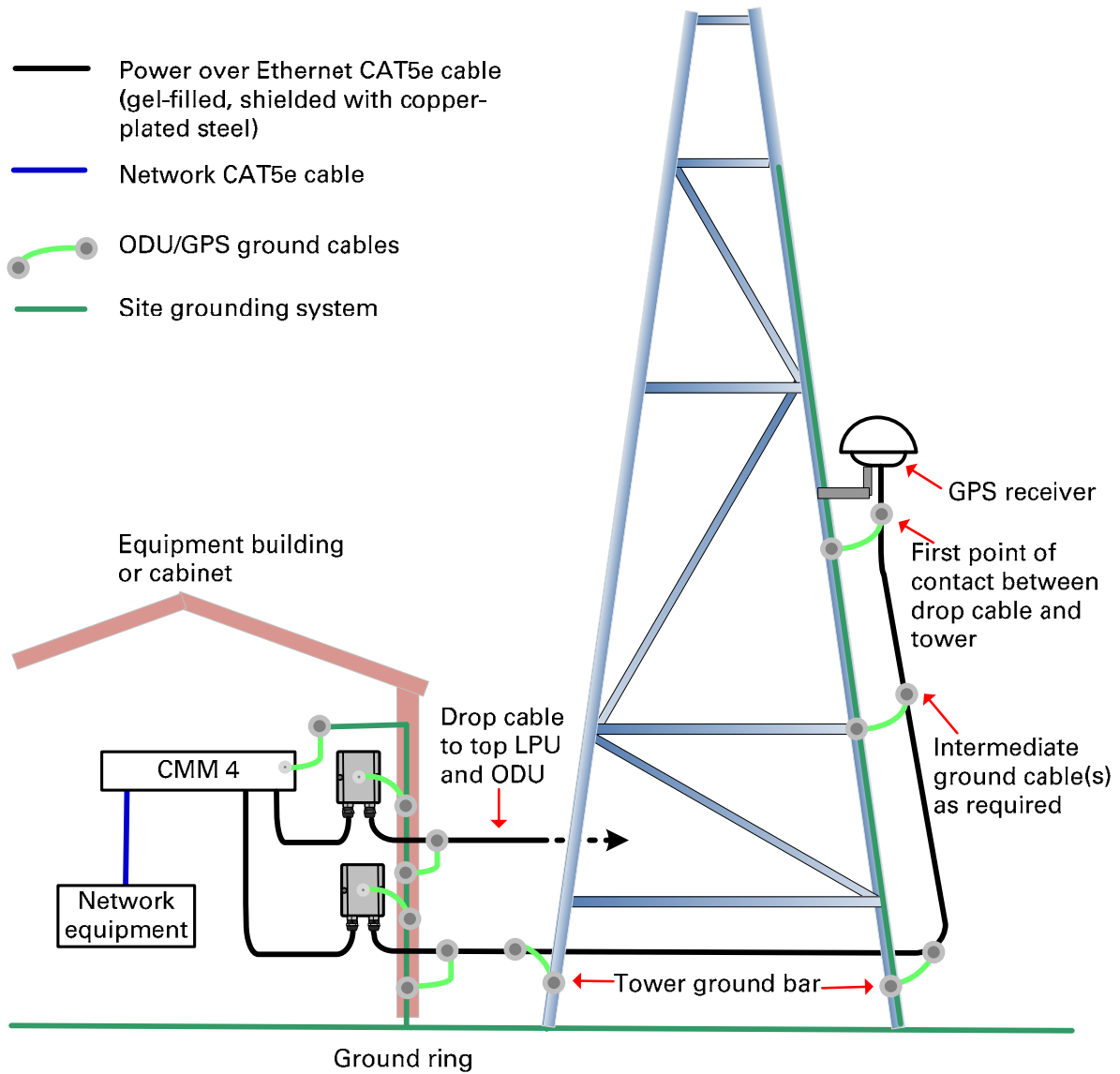

Figure 48 GPS receiver tower or mast installation



Site planning

This section describes factors to be considered when choosing sites for PMP or PTP radios, power supplies, CMM4 (if applicable) and UGPS (if applicable).

Site selection for PMP/PTP radios

When selecting a site for the ODU, consider the following factors:

- Height and location to ensure that people are kept away from the antenna; see [Calculated distances and power compliance margins](#) on page 4-24.
- Height and location to achieve the best radio path.
- Indoor location where the power supply LED indicators will be visible, so the drop cable length will not exceed the maximum recommended length; see [Power supply site selection](#) on page 3-8.
- Ability to meet the requirements specified in [Grounding and lightning protection](#) on page 3-8.
- Aesthetics and planning permission issues.
- Cable lengths; see [Ethernet standards and cable lengths](#) on page 2-35.
- The effect of strong winds on the installation; see [ODU wind loading](#) on page 3-11.

Power supply site selection

When selecting a site for the ODU power supply, consider the following factors:

- Indoor location with no possibility of condensation, flooding or high humidity.
- Availability of a mains electricity supply.
- Located in an environment where it is not likely to exceed its operational temperature rating, allowing for natural convection cooling.
- Accessibility for viewing status indicator LED and connecting Ethernet cables.
- Cable lengths; see [Ethernet standards and cable lengths](#) on page 2-35.

Maximum cable lengths

When installing PMP/PTP 450i Series ODU, the maximum permitted length of the shielded copper Ethernet interface cable is 330 feet (100m) from AP/BHM/SM/BHS to their associated power supplies or CMM4.

When installing PMP 450m Series ODU, the maximum permitted length of the shielded copper Ethernet interface cable is 330 feet (100m) from ODU to the network interface equipment.

Grounding and lightning protection



Warning

Electro-magnetic discharge (lightning) damage is not covered under warranty. The recommendations in this guide, when followed correctly, give the user the best protection from the harmful effects of EMD. However, 100% protection is neither implied nor possible.

Structures, equipment and people must be protected against power surges (typically caused by lightning) by conducting the surge current to ground via a separate preferential solid path. The actual degree of protection required depends on local conditions and applicable local regulations. To adequately protect a PMP/PTP 450 Platform installation, both ground bonding and transient voltage surge suppression are required.

Full details of lightning protection methods and requirements can be found in the international standards IEC 61024-1 and IEC 61312-1, the U.S. National Electric Code ANSI/NFPA No. 70-1984 or section 54 of the Canadian Electric Code.



Warning

International and national standards take precedence over the requirements in this guide.

Lightning protection zones

Use the rolling sphere method (Figure 49) to determine where it is safe to mount equipment. An imaginary sphere, typically 50 meters in radius, is rolled over the structure. Where the sphere rests against the ground and a strike termination device (such as a finial or ground bar), all the space under the sphere is considered to be in the zone of protection (Zone B). Similarly, where the sphere rests on two finials, the space under the sphere is considered to be in the zone of protection.

Figure 49 Rolling sphere method to determine the lightning protection zones

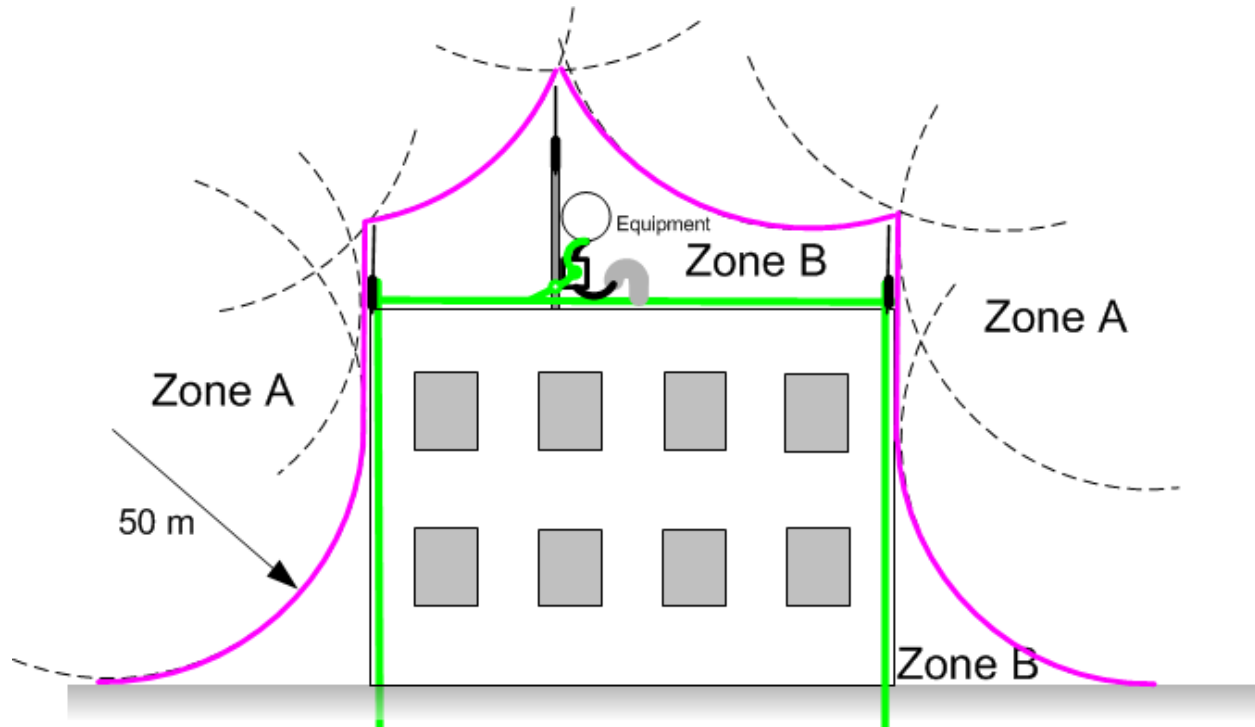

Zone A: In this zone a direct lightning strike is possible. Do not mount equipment in this zone.

Zone B: In this zone, direct EMD (lightning) effects are still possible, but mounting in this zone significantly reduces the possibility of a direct strike. Mount equipment in this zone.



Warning

Never mount equipment in Zone A. Mounting in Zone A may put equipment, structures and life at risk.

Site grounding system

Confirm that the site has a correctly installed grounding system on a common ground ring with access points for grounding the 450 Platform Family ODU.

If the outdoor equipment is to be installed on the roof of a high building ([Figure 46](#)), confirm that the following additional requirements are met:

- A grounding conductor is installed around the roof perimeter to form the main roof perimeter lightning protection ring.
- Air terminals are installed along the length of the main roof perimeter lightning protection ring, typically every 6.1m (20ft).
- The main roof perimeter lightning protection ring contains at least two down conductors connected to the grounding electrode system. The down conductors should be physically separated from one another, as far as practical.

ODU and external antenna location

Find a location for the ODU (and external antenna for connectorized units) that meets the following requirements:

- The equipment is high enough to achieve the best radio path.
- People can be kept a safe distance away from the equipment when it is radiating. The safe separation distances are defined in [Calculated distances and power compliance margins](#) on page 4-24.
- The equipment is lower than the top of the supporting structure (tower, mast or building) or its lightning air terminal.
- If the ODU is connectorized, select a mounting position that gives it maximum protection from the elements, but still allows easy access for connecting and weatherproofing the cables. To minimize cable losses, select a position where the antenna cable lengths can be minimized. If diverse or two external antennas are being deployed, it is not necessary to mount the ODU at the midpoint of the antennas.

ODU ambient temperature limits

Select a location where the ODU can operate within safe ambient temperature limits. The following points need to be considered while selecting a location for the ODU:

- The ODU must be mounted in a Restricted Access Location (as defined in EN 60950-1) if the operating ambient temperature may exceed 40°C, including solar radiation.
- If the ambient temperature never exceeds 40°C, the temperature of the external metal case parts of the ODU will not exceed the touch temperature limit of 70°C.
- If the ambient temperature never exceeds 60°C, the temperature of the external metal case parts of the ODU will not exceed the touch temperature limit of 90°C.

**Note**

A restricted access location is defined (in EN 60950-1) as one where access may only be gained by use of a tool or lock and key, or other means of security, and access is controlled by the authority responsible for the location. Access must only be gained by persons who have been instructed about the reasons for the restrictions applied to the location and about any precautions that must be taken. Examples of permissible restricted access locations are a lockable equipment room or a lockable cabinet.

ODU wind loading

Ensure that the ODU and the structure on which it is mounted are capable of withstanding the prevalent wind speeds at a proposed 450 Platform site. Wind speed statistics are available from national meteorological offices.

The ODU and its mounting bracket are capable of withstanding wind speeds of:

- Up to 200 mph (322 kph) for PMP 450m Series – AP 5 GHz
- Up to 124 mph (Integrated) for PMP/PTP 450i – all models 3 GHz and 5 GHz
- Up to 200 mph (Connectorized) for PMP/PTP 450i – all models 3 GHz and 5 GHz
- Up to 200 mph (322 kph) for PMP/PTP 450 – all models
- Up to 200 mph (322 kph) for PMP 450 – Ruggedized
- Up to 200 mph (322 kph) for PMP 450i – all models 900 MHz
- Up to 118 mph (191 kph) for PMP 450b
- Up to 90 mph (145 kph) for PMP 450d
- Up to 100 mph (161 kph) for 900 MHz antennas

Wind blowing on the ODU will subject the mounting structure to significant lateral force. The magnitude of the force depends on both wind strength and surface area of the ODU. Wind loading is estimated using the following formulae:

- Force (in kilograms) = $0.1045aV^2$
where:
 - “a” is the surface area in square meters, and
 - “V” is the wind speed in meters per second.
- Force (in pounds) = $0.0042Av^2$
where:
 - “A” is the surface area in square feet, and
 - “v” is the wind speed in miles per hour.

Applying these formulae to the 450 platform at different wind speeds, the resulting wind loadings are shown in below tables.

Table 71 PMP 450m Series wind loading (Newton)

Type of ODU	Max surface area (square meters)	Wind speed (kilometer per hour)				
		160	170	180	190	200
Integrated 90° sector antenna	0.331	671	757	849	946	1048

Table 72 PMP/PTP 450i Series wind loading (Newton)

Type of ODU	Max surface area (square meters)	Wind speed (kilometer per hour)				
		160	170	180	190	200
Connectorized	0.035	94	106	119	132	146
Directional Yagi antenna - 900 MHz	0.025	67	76	85	94	105
External 65° sector antenna – 900 MHz	0.253	677	764	857	954	1058
Directional antenna – 3.x GHz	0.1	142	160	180	200	222
Integrated 90° sector antenna -3.x GHz	0.18	83	94	105	117	130
Directional antenna – 5 GHz	0.093	249	281	315	351	389
Integrated 90° sector antenna - 5 GHz	0.126	337	381	427	475	527

Table 73 PMP 450m Series wind loading (lb force)

Type of ODU	Max surface area (square feet)	Wind speed (miles per hour)				
		100	105	110	115	120
Integrated 90° sector antenna	3.565	150	165	181	198	216

Table 74 PMP/PTP 450i Series wind loading (lb force)

Type of ODU	Max surface area (square feet)	Wind speed (miles per hour)				
		100	105	110	115	120
Connectorized	0.377	16	17	19	21	23
Directional antenna – 5 GHz	1.001	42	46	51	56	61
Integrated 90° sector antenna - 5 GHz	1.356	57	63	69	75	82
Directional Yagi antenna - 900 MHz	0.27	11	13	14	15	16
External 65° sector antenna – 900 MHz	2.72	114	126	138	151	165

For a connectorized ODU, add the wind loading of the external antenna to that of the ODU. The antenna manufacturer should be able to quote wind loading.

Table 75 PMP/PTP 450 Series wind loading (Newton)

Type of ODU	Max surface area (square meters)	Wind speed (kilometer per hour)				
		160	170	180	190	200
External 60° sector antenna – 2.4 GHz AP	0.27	722	815	914	1019	1129
External 60° sector antenna – 5 GHz AP	0.066	177	199	223	249	276
External 90° sector antenna – 5 GHz AP	0.083	222	251	281	313	347
SM	0.027	72	82	91	102	113
Integrated High-Gain, Ruggedized	0.093	249	281	315	351	389
Integrated Dish	0.14	375	423	474	528	585

Table 76 PMP/PTP 450 Series wind loading (lb force)

Type of ODU	Max surface area (square feet)	Wind speed (miles per hour)				
		100	105	110	115	120
External 60° sector antenna – 2.4 GHz AP	2.9	122	134	147	161	175
External 60° sector antenna – 5 GHz AP	0.71	29.8	33	37	39	43
External 90° sector antenna – 5 GHz AP	0.89	37	41	45	49	54
SM	0.29	12	13	15	16	18
Integrated High- Gain, Ruggedized	1	42	46	51	56	60
Integrated Dish	1.49	63	69	76	83	90

Hazardous locations

Check that the ODUs will not be exposed to hazardous gases, as defined by HAZLOC (USA) and ATEX (Europe) regulations. If there is a risk of such exposure, then order the PTP/PMP 450i ATEX/Hazloc product variants, as these are intended for operation in locations with gas hazards. The ATEX and HAZLOC standards limit the EIRP as shown in [Table 77](#).

Table 77 EIRP limits from ATEX and HAZLOC standards

ATEX gas group	HAZLOC gas group	Typical gas type	Maximum EIRP (Watt)
IIA	D	Propane	6
IIB	C	Ethylene	3.5
IIC	B	Hydrogen	2
IIC	A	Acetylene	2

Further reading

For information about...	Refer to...
Ordering Connectorized/ Integrated ATEX/HAZLOC ODUs	Table 64 and Table 65 on pages 2-63 and 2-64
ATEX/HAZLOC standards and type approval	Hazardous location compliance on page 4-33
Deployment of ATEX/HAZLOC ODUs	PMP/PTP 450i Hazardous Location Safety Guidance (pmp-1712)

Drop cable grounding points

To estimate how many grounding kits are required for each drop cable, refer to the site installation diagrams ([Figure 44](#), [Figure 45](#), and [Figure 46](#)) and use the following criteria:

- The drop cable shield must be grounded near the ODU at the first point of contact between the drop cable and the mast, tower or building.
- The drop cable shield must be grounded at the building entry point.

For mast or tower installations ([Figure 44](#)), use the following additional criteria:

- The drop cable shield must be grounded at the bottom of the tower, near the vertical to horizontal transition point. This ground cable must be bonded to the tower or tower ground bus bar (TGB), if installed.

- If the tower is greater than 61 m (200 ft) in height, the drop cable shield must be grounded at the tower midpoint, and at additional points as necessary to reduce the distance between ground cables to 61 m (200 ft) or less.
- In high lightning-prone geographical areas, the drop cable shield must be grounded at spacing between 15 to 22 m (50 to 75 ft). This is especially important on towers taller than 45 m (150 ft).

For roof installations ([Figure 46](#)), use the following additional criteria:

- The drop cable shield must be bonded to the building grounding system at its top entry point (usually on the roof).
- The drop cable shield must be bonded to the building grounding system at the entry point to the equipment room.

Lightning Protection Unit (LPU) location

Find a location for the bottom LPU that meets the following requirements:

- The bottom LPU can be connected to the drop cable from the ODU.
- The bottom LPU is within 600 mm (24 in) of the point at which the drop cable enters the building, enclosure or equipment room within a larger building.
- The bottom LPU can be bonded to the grounding system.

Radio Frequency planning

This section describes how to plan 450 Platform Family links to conform to analysis of spectrum and the regulatory restrictions that apply in the country of operation.

Regulatory limits

Many countries impose EIRP limits (Allowed EIRP) on products operating in the bands used by the 450 Platform Family.

Refer to [Equipment Disposal \(Chapter 10: Reference information\)](#) on page 10-54 to determine what the maximum transmitted power and EIRP for PMP/PTP 450 Platform that can be used in each of countries and frequency band.



Caution

It is the responsibility of the user to ensure that the PMP/PTP ODU is operated in accordance with local regulatory limits.



Note

Contact the applicable radio regulator to find out if registration of the PMP/PTP 450 Platform link is required.

Conforming to the limits

Ensure the link is configured to conform to local regulatory requirements by configuring the PMP 450/450i Series AP or PTP 450/450i Series BHM for the correct country. In the following situations, this does not prevent operation outside the regulations:

- When using connectorized ODUs with external antennas, the regulations may require the maximum transmit power to be reduced.

Available spectrum

The available spectrum for operation depends on the regulatory band. When configured appropriately, the unit will only allow operation on those channels which are permitted by the regulations.

Certain regulations have allocated certain channels as unavailable for use:

- FCC has allocated part of the 5.1 & 5.2 GHz
- ETSI has allocated part of the 5.4 GHz band to weather radar.
- UK and some other European countries have allocated part of the 5.8 GHz band to Road Transport and Traffic Telematics (RTTT) systems.

The number and identity of channels barred in a given regulatory band is dependent on the channel bandwidth and channel raster selected.

Analyzing the RF Environment

An essential element in RF network planning is the analysis of spectrum usage and the strength of the signals that occupy the spectrum. Regardless of how these parameters are measured and log or chart the results (through the Spectrum Analyzer feature or by using a spectrum analyzer), ensure measurements are performed:

- At various times of day.
- On various days of the week.
- Periodically into the future.

As new RF neighbors move in or consumer devices proliferate in currently used spectrum, this keeps the user aware of the dynamic possibilities for interference within the network.

Channel bandwidth

Select the required channel bandwidth for the link. The selection depends upon the regulatory band selected.

The wider the channel bandwidth, the greater the capacity. As narrower channel bandwidths take up less spectrum, selecting a narrow channel bandwidth may be a better choice when operating in locations where the spectrum is very busy.

Both ends of the link must be configured to operate on the same channel bandwidth.

Anticipating Reflection of Radio Waves

In the signal path, any object that is larger than the wavelength of the signal can reflect the signal. Such an object can even be the surface of the earth or of a river, bay or lake. The wavelength of the signal is approximately

- 2 inches (or 5 cm) for 5.4 GHz and 5.8 GHz signals.
- 12 inches for 900 MHz signals

A reflected signal can arrive at the antenna of the receiver later than the non-reflected signal arrives. These two or more signals cause the condition known as multipath. Multipath may increase or decrease the signal level, resulting in overall attenuation that may be higher or lower than that caused by the link distance. This is problematic at the margin of the link budget, where the standard operating margin (fade margin) may be compromised.

Obstructions in the Fresnel Zone

The Fresnel (pronounced fre-NEL) Zone is a three-dimensional volume around the line of sight of an antenna transmission. Objects that penetrate this area can cause the received strength of the transmitted signal to fade. Out-of-phase reflections and absorption of the signal result in signal cancellation.

The foliage of trees and plants in the Fresnel Zone can cause signal loss. Seasonal density, moisture content of the foliage, and other factors such as wind may change the amount of loss. Plan to perform frequent and regular link tests if you must transmit through foliage.

Planning for co-location

The first step to avoid interference in wireless systems is to set all AP/BHMs to receive timing from a synchronization source (Cluster Management Module, or Universal Global Positioning System). This ensures that the modules are in sync and start transmitting at the same time each frame.

The second step to avoid interference is to configure parameters on all AP/BHMs of the same frequency band in proximity such that they have compatible transmit/receive ratios (all stop transmitting each frame before any start receiving). This avoids the problem of one AP/BHM attempting to receive the signal from a distant SM/BHS while a nearby AP/BHM transmits, which could overpower that signal.



Note

Refer to Frame Alignment Legacy Mode parameter of Configuration > Radio > Advance tab for legacy product settings (See [Table 146 PMP 450i AP Radio attributes - 5 GHz](#) on page 7-135).

The following parameters on the AP/BHM determine the transmit/receive ratio:

- Downlink Data percentage
- Frame Period
- Max Range
- (reserved) Contention slots

If OFDM (450 Platform Family, PMP/PTP 230) and FSK (PMP/PTP 1x0) APs/BHMs of the same frequency band and channel bandwidth are in proximity, or if you want BHMs set to different parameters then you must use the Frame Calculator to identify compatible settings for APs/BHMs.

The co-location is also supported for 900 MHz PMP 450i Series APs (OFDM) and PMP 100 Series APs (FSK).

The Frame Calculator is available on the web management interface **Tools > Frame Calculator**. To use the Frame Calculator, type into the calculator various configurable parameter values for each proximal AP/BHM and then record the resulting AP/BHM Receive Start value. Next vary the Downlink Data percentage in each calculation and iterate until a calculated AP/BHM Receive Start for all co-located AP/BHMs where the transmit end does not come before the receive start.

Cambium also provides co-location tool which helps in co-location planning:

<https://support.cambiumnetworks.com/files/colocationtool>

For more information on 450 Platform Family co-location, see

<http://www.cambiumnetworks.com/solution-papers>

Multiple OFDM Access Point Clusters

When deploying multiple AP clusters in a dense area, consider aligning the clusters as shown below. However, this is only a recommendation. An installation may dictate a different pattern of channel assignments.

Figure 50 Example layout of 16 Access Point sectors (ABCD), 90-degree sectors

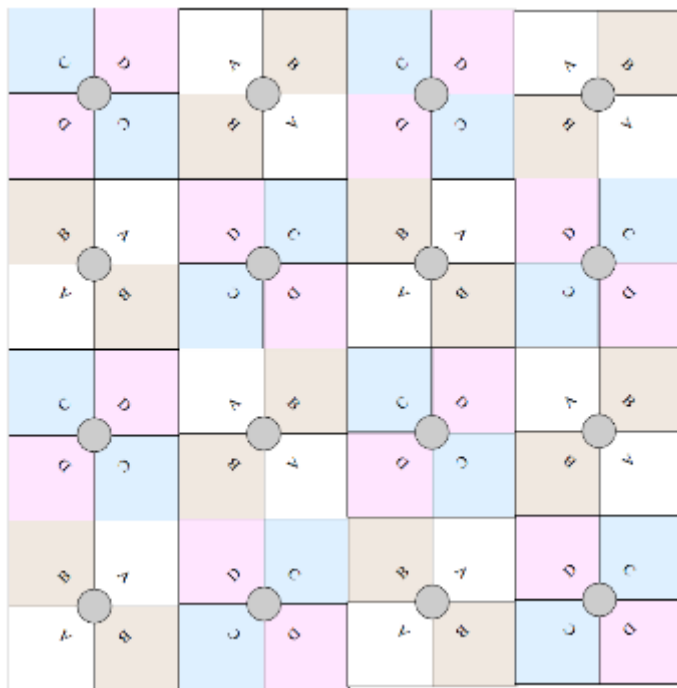

An example for assignment of frequency channels is provided in the following table.

Table 78 Example 5.8 GHz 4-channel assignment by access site

Symbol	Frequency
A	5.740 GHz
B	5.780 GHz
C	5.760 GHz
D	5.800 GHz

Figure 51 Example layout of 6 Access Point sectors (ABC), 60-degree sectors

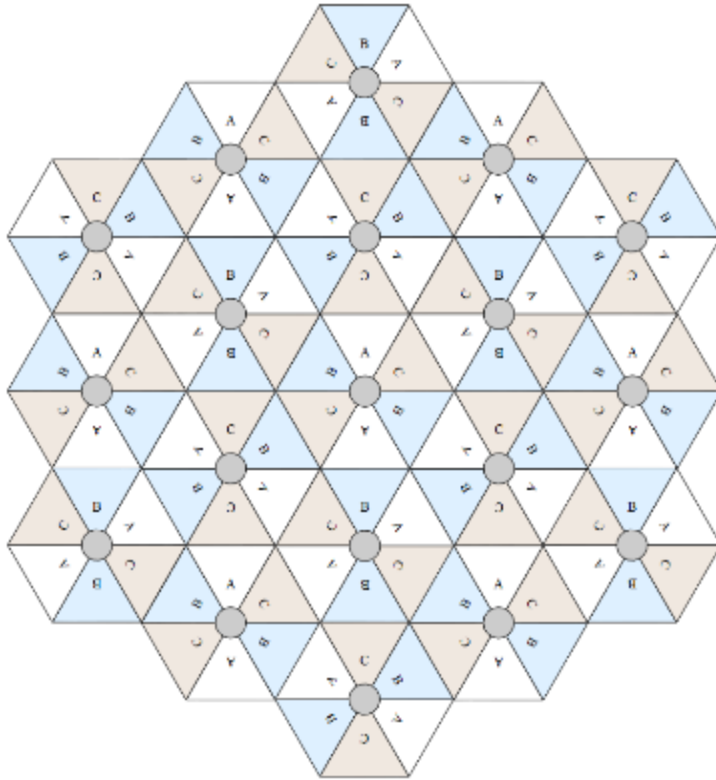

An example for assignment of frequency channels and sector IDs is provided in the following table.

Table 79 Example 5.8 GHz 3-channel assignment by access site

Symbol	Frequency
A	5.740 GHz
B	5.760 GHz
C	5.780 GHz

Considerations on back-to-back frequency reuse

Cambium Networks recommends using back-to-back (ABAB) frequency reuse, as shown in [Figure 50](#). This means that a base site of four sectors can be created using two frequencies, which works very well and helps define networks in situations where high capacity is required in a limited amount of spectrum.

The conditions necessary to implement this plan are:

- GPS synchronization: all the access points transmit at the same time
- Uplink and Downlink timings across APs do not overlap: they can be adjusted using the frame calculators and co-location tools provided by Cambium
- Uplink power control to ensure that all signals are received on the uplink at the same level: this is automatically enabled on all sectors
- There are no reflecting objects which are too large in the exclusion zones defined in this section.
- The SMs do not normally have line-of-sight (LoS) to an interfering base station. The worst-case range ratio in [Figure 50](#) is 5:1 which in LoS only gives 14 dB protection. Greater than 30 dB is required for 256QAM capability. Down tilt can be used to advantage when the elevation beamwidth is low. Also, the range ratio applies to the longest distance SM, shorter distance SMs have a better range ratio. This frequency reuse plan may not always give 256QAM for the longest distance SMs. It is usually a good compromise between using more spectrum and guaranteed modulation rate.

Reflecting objects

[Figure 52](#) shows two diagrams of the same reflecting object. Uplink interference demonstrates the situation when the two SMs are transmitting at the same time. SM2 should be received cleanly by the AP for Sector 3. At the same time interference can arise from SM1 via the reflecting object and cause a lower Signal-to-Interference ratio than required at AP3. This may either cause transmission errors which are corrected by ARQ or cause the selected modulation rate to be lowered. Either may cause a lower throughput from SM2 and therefore sector 3.

Downlink interference shows the situation when AP3 interferes with SM1. Again, the transmission may be reduced by errors or a reduction in modulation rate.

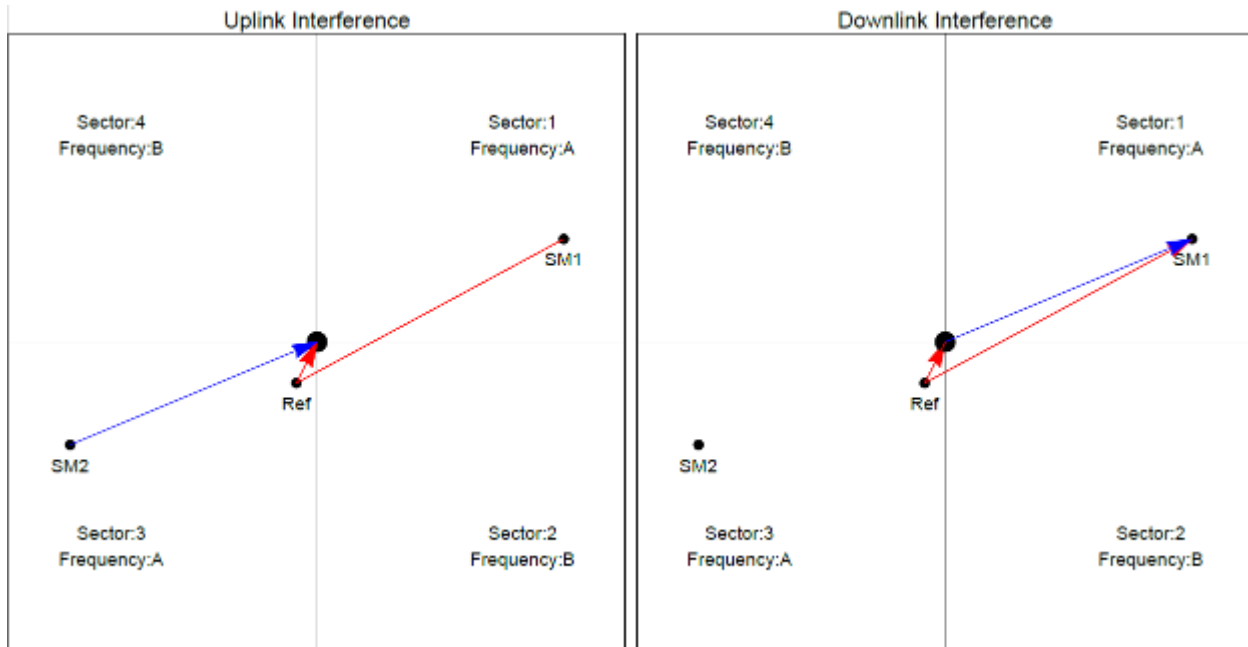
Figure 52 Reflection

Reflection likelihood guidance

As shown in the previous section, reflection can cause a decrease in throughput in an ABAB base site. This section provides guidance on whether a reflection is likely to cause interference. The first condition for whether a reflection can cause the data rate to reduce is that the reflecting object must be in view of the AP and the SM to re-transmit the signal. If this is not the case, then the object cannot cause interference.

Given that the potential reflecting object is seen by the AP and the SM, there are a range of object sizes and a range of zones where we can predict that interference will occur which may reduce the throughput when both sector 1 and sector 3 are carrying traffic.

Figure 53 and Figure 54 show regions enumerated A, B, C, and D. We also need to consider objects of size 1, 2, 3 and 4 and define the areas where the objects may interfere.

- object size 1: a flat building face with a clear reflecting property from sector to AP
- object size 2: random metalwork such as a wireless tower
- object size 3: a 0.5 X 0.5m flat metallic face or tree
- object size 4: a 0.2 X 0.2m random metal structure or 0.5 X 0.5m foliage.

The conditions for no interference are:

- size 2 outside zone B
- size 3 outside zone C
- size 4 outside zone D

The size 1 object can interfere at large distances. It is necessary to look at the geometry by which reflection could occur and cause interference. Typically, this will occur at a restricted range of azimuths and ranges.

Figure 53 Sector Antenna

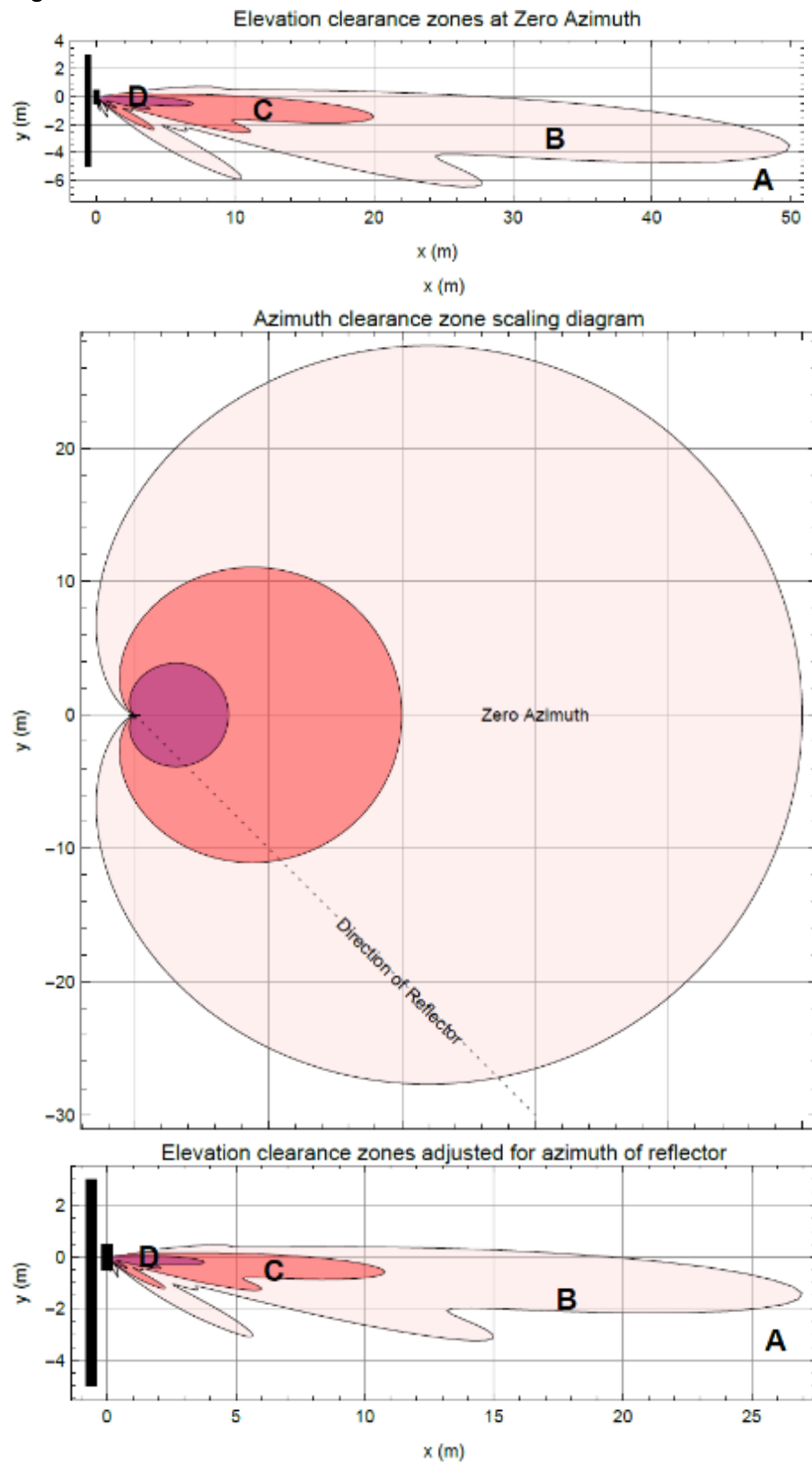

Figure 54 cnMedusa Antenna

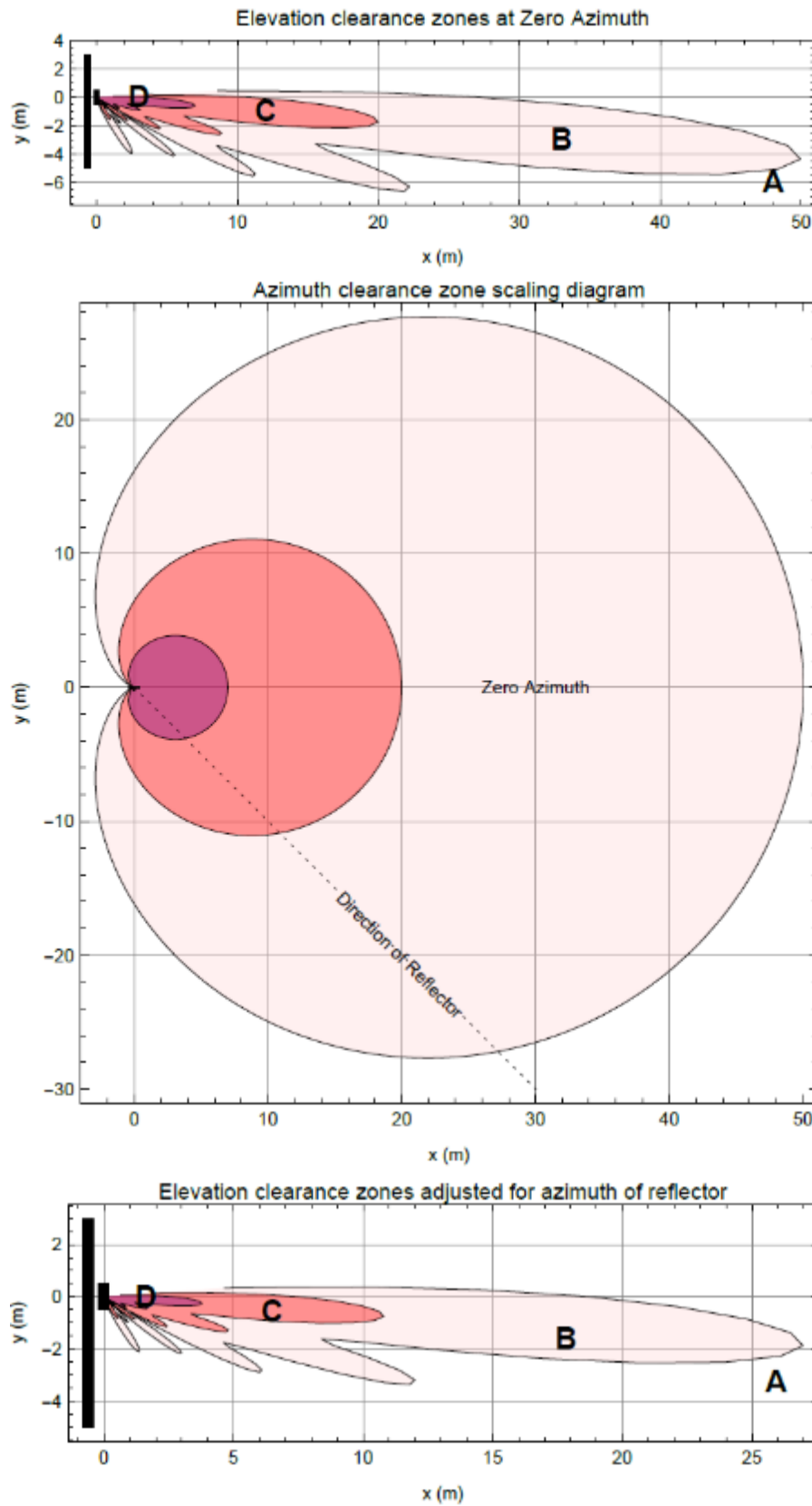

Figure 53 and Figure 54 each have three diagrams scaled in meters where Figure 53 is for the sector antenna and Figure 54 is for cnMedusa. In each figure the distances and heights assume a typical down tilt of 4°.

In each figure the top diagram represents the clearances required at zero azimuth. The middle diagram represents the scaling required to the top diagram to allow for differences in azimuth of the considered reflecting object. The bottom diagram is the scaled version of the top diagram allowing for the dotted azimuth line in the middle diagram.

PMP 450m Series AP is based on Massive **MU-MIMO** technology. It is a 14x14 MIMO system which allows simultaneous communication to up to seven SMs.

Figure 55 PMP 450m Series AP antenna beam



PMP 450m installation recommendations

- For best performance it is recommended to have a clearance zone around the mast. The clearance zone depends on the surrounding environment and the antenna's down tilt. If the mast is surrounded by metal then larger clearance is required compared to an environment where the antenna is surrounded by foliage
- SMs should be spread in azimuth of AP antenna
- 450m is susceptible to movement, for best MU-MIMO performance it is recommended that the 450m AP is mounted/installed on a mast that is extremely rigid (no movement and is 100% vertical).
- LINKPlanner can be used to plan SMs across the AP antenna azimuth

Link planning

This section describes factors to be considered when planning links, such as range, obstacles path loss and throughput. LINKPlanner is recommended.

Range and obstacles

Calculate the range of the link and identify any obstacles that may affect radio performance.

Perform a survey to identify all the obstructions (such as trees or buildings) in the path and to assess the risk of interference. This information is necessary in order to achieve an accurate link feasibility assessment.

The 450 Platform Family is designed to operate in Non-Line-of-Sight (NLoS) and Line-of-Sight (LoS) environments. An NLOS environment is one in which there is no optical line-of-sight, that is, there are obstructions between the antennas.

OFDM technology can often use multi-pathing to an advantage to overcome nLOS, especially in cases where the Fresnel zone is only partially blocked by buildings, “urban canyons”, or foliage. OFDM tends to help especially when obstacles are near the middle of the link, and less so when the obstacles are very near the ODU.

However, attenuation through walls and trees is substantial for any use of the 5.4 GHz and 5.8 GHz frequency bands. The lower frequency radio waves of 900 MHz radios provide greater penetration through walls, trees and other obstacles, making it optimal for most non-line-of-sight applications. Even with OFDM, these products are not expected to penetrate walls or extensive trees and foliage.

Path loss

Path loss is the amount of attenuation the radio signal undergoes between the two ends of the link. The path loss is the sum of the attenuation of the path if there were no obstacles in the way (Free Space Path Loss), the attenuation caused by obstacles (Excess Path Loss) and a margin to allow for possible fading of the radio signal (Fade Margin). The following calculation needs to be performed to judge whether a link can be installed:

$$L_{free_space} + L_{excess} + L_{fade} + L_{seasonal} < L_{capability}$$

Where:

Is:

L_{free_space}

Free Space Path Loss (dB)

$L_{exces.}$

Excess Path Loss (dB)

L_{fade}

Fade Margin Required (dB)

$L_{seasonal}$	Seasonal Fading (dB)
$L_{capability}$	Equipment Capability (dB)

Calculating Link Loss

The link loss is the total attenuation of the wireless signal between two point-to-multipoint units. The link loss calculation is presented below:

$$\begin{aligned} \text{Link Loss (dB)} = & \text{Transmit power of the remote wireless unit (dBm)} - \text{Tx Cable loss (dB)} \\ & - \text{Received power at the local unit (dBm)} - \text{Rx cable loss (dB)} + \\ & \text{Antenna gain at the remote unit (dBi)} + \text{Antenna gain at the local unit (dBi)} \end{aligned}$$

Calculating Rx Signal Level

The determinants in Rx signal level are illustrated in [Figure 56](#).

Figure 56 Determinants in Rx signal level

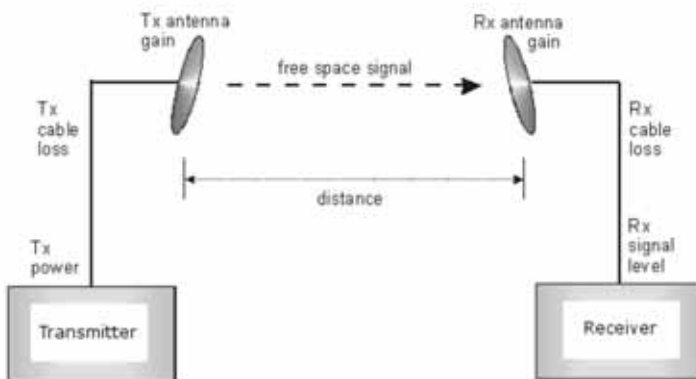

Rx signal level is calculated as follows:

$$\begin{aligned} \text{Rx signal level dB} = & \text{Tx power} - \text{Tx cable loss} + \text{Tx antenna gain} \\ & - \text{free space path loss} + \text{Rx antenna gain} - \text{Rx cable loss} \end{aligned}$$



Note

This Rx signal level calculation presumes that a clear line of sight is established between the transmitter and receiver and that no objects encroach in the Fresnel zone.

Calculating Fade Margin

Free space path loss is a major determinant in Rx (received) signal level. Rx signal level, in turn, is a major factor in the system operating margin (fade margin), which is calculated as follows:

$$\text{System operating margin (fade margin) dB} = \text{Rx signal level dB} - \text{Rx sensitivity dB}$$

Thus, fade margin is the difference between strength of the received signal and the strength that the receiver requires for maintaining a reliable link. A higher fade margin is characteristic of a more reliable link.

Adaptive modulation

Adaptive modulation ensures that the highest throughput that can be achieved instantaneously will be obtained, taking account of propagation and interference. When the link has been installed, web pages provide information about the link loss currently measured by the equipment, both instantaneously and averaged. The averaged value will require maximum seasonal fading to be added, and then the radio reliability of the link can be computed.

For details of the system throughput, link loss and maximum distance for each frequency band in all modulation modes, see [Link](#) on page 10-49.

Planning for connectorized units

This section describes factors to be considered when planning to use connectorized ODUs with external antennas in 450 Platform Family links.

When to install connectorized units

Most of radio links can be successfully deployed with the integrated ODU. However, the integrated units may not be sufficient in some areas, for example:

- Where the path is heavily obscured by dense woodland on an NLOS link.
- Where long LOS links are required.
- Where there are known to be high levels of interference.

In these areas, connectorized ODUs and external antennas should be used.

Choosing external antennas

When selecting external antennas, consider the following factors:

- The required antenna gain.
- Ease of mounting and alignment.
- Use dual-polarization antenna (as the integrated antenna).



Note

Enter the antenna gain and cable loss into the Installation Wizard, if the country selected has an EIRP limit, the corresponding maximum transmit power will be calculated automatically by the unit.

Calculating RF cable length (5.8 GHz FCC only)

The 5.8 GHz band FCC approval for the product is based on tests with a cable loss between the ODU and antenna of not less than 1.2 dB. If cable loss is below 1.2 dB with a 1.3 m (4 ft) diameter external antenna, the connectorized 450 Platform Family may exceed the maximum radiated spurious emissions allowed under FCC 5.8 GHz rules.

Cable loss depends mainly upon cable type and length. To meet or exceed the minimum loss of 1.2 dB, use cables of the type and length specified in [Table 80](#) (source: Times Microwave). This data excludes connector losses.

Table 80 RF cable lengths required to achieve 1.2 dB loss at 5.8 GHz

RF cable type	Minimum cable length
LMR100	0.6 m (1.9 ft)
LMR200	1.4 m (4.6 ft)
LMR300	2.2 m (7.3 ft)
LMR400	3.4 m (11.1 ft)
LMR600	5.0 m (16.5 ft)

Data network planning

This section describes factors to be considered when planning 450 Platform Family data networks.

Understanding addresses

A basic understanding of Internet Protocol (IP) address and subnet mask concepts is required for engineering your IP network.

IP address

The IP address is a 32-bit binary number that has four parts (octets). This set of four octets has two segments, depending on the class of IP address. The first segment identifies the network. The second identifies the hosts or devices on the network. The subnet mask marks a boundary between these two sub-addresses.

Dynamic or static addressing

For any computer to communicate with a module, the computer must be configured to either

- use DHCP (Dynamic Host Configuration Protocol). In this case, when not connected to the network, the computer derives an IP address on the 169.254 network within two minutes.
- have an assigned static IP address (for example, 169.254.1.5) on the 169.254 network.

**Note**

If an IP address that is set in the module is not the 169.254.x.x network address, then the network operator must assign the computer a static IP address in the same subnet.

When a DHCP server is not found

To operate on a network, a computer requires an IP address, a subnet mask, and possibly a gateway address. Either a DHCP server automatically assigns this configuration information to a computer on a network or an operator must input these items.

When a computer is brought on line and a DHCP server is not accessible (such as when the server is down or the computer is not plugged into the network), Microsoft and Apple operating systems default to an IP address of 169.254.x.x and a subnet mask of 255.255.0.0 (169.254/16, where /16 indicates that the first 16 bits of the address range are identical among all members of the subnet).

DNS Client

The DNS Client is used to resolve names of management servers within the operator's management domain (see [Figure 57](#)). This feature allows hostname configuration for NTP servers, Authorization Servers, DHCP relay servers, and SNMP trap servers. Operators may choose to either enter in the FQDN (Fully Qualified Domain Name) for the host name or to manually enter the IP addresses of the servers.

Figure 57 Cambium networks management domain

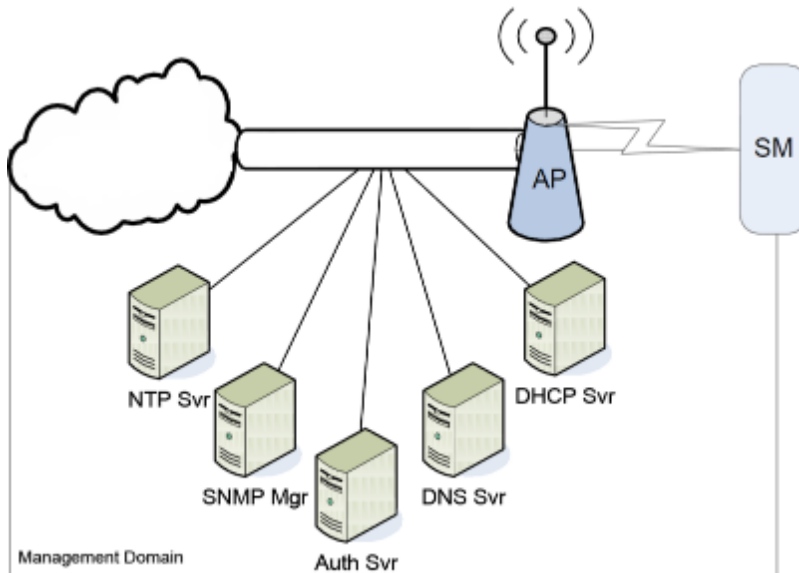

Network Address Translation (NAT)

NAT, DHCP Server, DHCP Client and DMZ in SM

The system provides NAT (network address translation) for SMs in the following combinations of NAT and DHCP (Dynamic Host Configuration Protocol):

- NAT Disabled
- NAT with DHCP Client (**DHCP** selected as the **Connection Type** of the WAN interface) and DHCP Server
- NAT with DHCP Client (**DHCP** selected as the **Connection Type** of the WAN interface)
- NAT with DHCP Server
- NAT without DHCP

NAT

NAT isolates devices connected to the Ethernet/wired side of a SM from being seen directly from the wireless side of the SM. With NAT enabled, the SM has an IP address for transport traffic (separate from its address for management), terminates transport traffic, and allows you to assign a range of IP addresses to devices that are connected to the Ethernet/wired side of the SM.

In the Cambium system, NAT supports many protocols, including HTTP, ICMP (Internet Control Message Protocols), and FTP (File Transfer Protocol). For virtual private network (VPN) implementation, L2TP over IPSec (Level 2 Tunneling Protocol over IP Security) and PPTP (Point to Point Tunneling Protocol) are supported.

DHCP

DHCP enables a device to be assigned a new IP address and TCP/IP parameters, including a default gateway, whenever the device reboots. Thus DHCP reduces configuration time, conserves IP addresses, and allows modules to be moved to a different network within the Cambium system.

In conjunction with the NAT features, each SM provides:

- A DHCP server that assigns IP addresses to computers connected to the SM by Ethernet protocol.
- A DHCP client that receives an IP address for the SM from a network DHCP server.

DMZ

In conjunction with the NAT features, a DMZ (demilitarized zone) allows the assignment of one IP address behind the SM for a device to logically exist outside the firewall and receive network traffic. The first three octets of this IP address must be identical to the first three octets of the NAT private IP address.

Developing an IP addressing scheme

Network elements are accessed through IP Version 4 (IPv4) addressing.

A proper IP addressing method is critical to the operation and security of a network.

Each module requires an IP address on the network. This IP address is for only management purposes. For security, you must either:

- Assign a non-routable IP address.
- Assign a routable IP address only if a firewall is present to protect the module.

You assign an IP addresses to computers and network components by either static or dynamic IP addressing. You will also assign the appropriate subnet mask and network gateway to each module.

Address Resolution Protocol

As previously stated, the MAC address identifies a module in:

- Communications between modules.
- The data that modules store about each other.

The IP address is essential for data delivery through a router interface. Address Resolution Protocol (ARP) correlates MAC addresses to IP addresses.

For communications to outside the network segment, ARP reads the network gateway address of the router and translates it into the MAC address of the router. Then the communication is sent to MAC address (physical network interface card) of the router.

For each router between the sending module and the destination, this sequence applies. The ARP correlation is stored until the ARP cache times out.

Allocating subnets

The subnet mask is a 32-bit binary number that filters the IP address. Where a subnet mask contains a bit set to 1, the corresponding bit in the IP address is part of the network address.

Example IP address and subnet mask

In [Figure 58](#), the first 16 bits of the 32-bit IP address identify the network:

Figure 58 Example of IP address in Class B subnet

	Octet 1	Octet 2	Octet 3	Octet 4
IP address 169.254.1.1	10101001	11111110	00000001	00000001
Subnet mask 255.255.0.0	11111111	11111111	00000000	00000000

In this example, the network address is 169.254 and 2^{16} (65,536) hosts are addressable.

Selecting non-routable IP addresses

The factory default assignments for network elements are:

- Unique MAC address
- IP address of 169.254.1.1
- Subnet mask of 255.255.0.0
- Network gateway address of 169.254.0.0

For each radio and CMM4, assign an IP address that is both consistent with the IP addressing plan for your network and cannot be accessed from the Internet. IP addresses within the following ranges are not routable from the Internet, regardless of whether a firewall is configured:

- 10.0.0.0 – 10.255.255.255
- 172.16.0.0 – 172.31.255.255
- 192.168.0.0 – 192.168.255.255

Also, the subnet mask and network gateway for each CMM4 can be assigned.

Translation bridging

Optionally, the AP can be configured to change the source MAC address in every packet it receives from its SMs to the MAC address of the SM/BHS that bridged the packet, before forwarding the packet toward the public network. In this case:

- Not more than 128 IP devices at any time are valid to send data to the AP from behind the SM.
- SM populates the Translation Table tab of its Statistics web page, displaying the MAC address and IP address of all the valid connected devices.
- Each entry in the Translation Table is associated with the number of minutes that have elapsed since the last packet transfer between the connected device and the SM.
- If 128 are connected, and another attempt to connect:
 - If no Translation Table entry is older than 255 minutes, the attempt is ignored.
 - If an entry is older than 255 minutes, the oldest entry is removed and the attempt is successful.
- The **Send Untranslated ARP** parameter in the General tab of the Configuration page can be:
 - Disabled, so that the AP overwrites the MAC address in ARP packets before forwarding them.
 - Enabled, so that the AP forwards ARP packets regardless of whether it has overwritten the MAC address.

This is the **Translation Bridging** feature, which you can enable in the General page of the Configuration web page in the AP. When this feature is disabled, the setting of the **Send Untranslated ARP** parameter has no effect, because all packets are forwarded untranslated (with the source MAC address intact). See [Address Resolution Protocol](#) on Page 3-34.

Engineering VLANs

The radios support VLAN functionality as defined in the 802.1Q (Virtual LANs) specification, except for the following aspects of that specification:

- Protocols:
 - Generic Attribute Registration Protocol (GARP) GARV
 - Spanning Tree Protocol (STP)
 - Multiple Spanning Tree Protocol (MSTP)
 - GARP Multicast Registration Protocol (GMRP)
- Embedded source routing (ERIF) in the 802.1Q header
- Multicast pruning
- Flooding unknown unicast frames in the downlink

As an additional exception, the AP/BHM does not flood downward the unknown unicast frames to the SM/BHS.

A VLAN configuration in Layer 2 establishes a logical group within the network. Each computer in the VLAN, regardless of initial or eventual physical location, has access to the same data. For the network operator, this provides flexibility in network segmentation, simpler management, and enhanced security.

Special case VLAN numbers

This system handles special case VLAN numbers according to IEEE specifications:

Table 81 Special case VLAN IDs

VLAN Number	Purpose	Usage Constraint
0	These packets have 802.1p priority, but are otherwise handled as untagged.	Must not be used as a management VLAN.
1	Although not noted as special case by IEEE specifications, these packets identify traffic that was untagged upon ingress into the SM and must remain untagged upon egress. This policy is hard-coded in the AP.	Must not be used for system VLAN traffic.
4095	This VLAN is reserved for internal use.	Must not be used at all.

SM membership in VLANs

With the supported VLAN functionality, the radios determine bridge forwarding on the basis of not only the destination MAC address, but also the VLAN ID of the destination. This provides flexibility in how SMs are used:

- Each SM can be a member in its own VLAN.
- Each SM can be in its own broadcast domain, such that only the radios that are members of the VLAN can see broadcast and multicast traffic to and from the SM.
- The network operator can define a work group of SMs, regardless of the AP(s) to which they register.

PMP 450 Platform Family modules provide the VLAN frame filters that are described in [Table 82](#).

Table 82 VLAN filters in point-to-multipoint modules

Where VLAN is active, if this parameter value is selected ...	then a frame is discarded if...		because of this VLAN filter in the software:
	entering the bridge/ NAT switch through...		
	Ethernet...	TCP/IP...	
any combination of VLAN parameter settings	with a VID not in the membership table		Ingress
any combination of VLAN parameter settings		with a VID not in the membership table	Local Ingress
Allow Frame Types: Tagged Frames Only	with no 802.1Q tag		Only Tagged
Allow Frame Types: Untagged Frames Only	with an 802.1Q tag, regardless of VID		Only Untagged
Local SM Management: Disable in the SM, or All Local SM Management: Disable in the AP	with an 802.1Q tag and a VID in the membership table		Local SM Management
	leaving the bridge/ NAT switch through...		
	Ethernet...	TCP/IP...	
any combination of VLAN parameter settings	with a VID not in the membership table		Egress
any combination of VLAN parameter settings		with a VID not in the membership table	Local Egress

Priority on VLANs (802.1p)

The radios can prioritize traffic based on the eight priorities described in the IEEE 802.1p specification. When the high-priority channel is enabled on a SM, regardless of whether VLAN is enabled on the AP for the sector, packets received with a priority of 4 through 7 in the 802.1p field are forwarded onto the high-priority channel.

Operators may configure priority precedence as 802.1p Then Diffserv (Default) or Diffserv Then 802.1p. Since these priority precedence configurations are independent between the AP and SM, this setting must be configured on both the AP and SM to ensure that the precedence is adhered to by both sides of the link.

VLAN settings can also cause the module to convert received non-VLAN packets into VLAN packets. In this case, the 802.1p priority in packets leaving the module is set to the priority established by the DiffServ configuration.

If VLAN is enabled, immediately monitor traffic to ensure that the results are as desired. For example, high-priority traffic may block low-priority.

Q-in-Q DVLAN (Double-VLAN) Tagging (802.1ad)

PMP and PTP modules can be configured with 802.1ad Q-in-Q DVLAN (Double-VLAN) tagging which is a way for an operator to put an 802.1Q VLAN inside of an 802.1ad VLAN. A nested VLAN, which is the original 802.1Q tag and a new second 802.1ad tag, allows for bridging of VLAN traffic across a network and segregates the broadcast domains of 802.1Q VLANs. Q-in-Q can be used with PPPoE and/or NAT.

The 802.1ad standard defines the S-VLAN as the Service Provider VLAN and the C-VLAN as the customer VLAN. The radio software does 2-layer Q-in-Q whereby the C-VLAN is the 802.1Q tag and the S-VLAN is the second layer Q tag as shown in [Table 83](#).

Table 83 Q-in-Q Ethernet frame

Ethernet Header	S-VLAN EthType 0x88a8	C-VLAN EthType 0x8100	IP Data EthType 0x0800
-----------------	--------------------------	--------------------------	------------------------

The 802.1ad S-VLAN is the outer VLAN that is configurable on the **Configuration > VLAN** web page of the AP/BHM. The Q-in-Q EtherType parameter is configured with a default EtherType of 0x88a8 in addition to four alternate EtherTypes that can be configured to aid in interoperability with existing networks that use a different EtherType than the default.

The C-VLAN is the inner VLAN tag, which is the same as 802.1Q. As a top-level concept, this operates on the outermost tag at any given time, either “pushing” a tag on or “popping” a tag off. This means packets will at most transition from an 802.1Q frame to an 801.ad frame (with a tag “pushed” on) or an untagged 802.1 frame (with the tag “popped” off. Similarly, for an 802.1ad frame, this can only transition from an 802.1ad frame to an 802.1Q frame (with the tag “popped” off) since the radio software only supports 2 levels of tags.

Network management planning

This section describes how to plan for 450 Platform Family links to be managed remotely using SNMP.

Planning for SNMP operation

Cambium modules provide the following SNMP traps for automatic notifications to the NMS:

- coldStart, which signals that the SNMPv2c element is reinitializing itself and that its configuration may have been altered.
- warmStart, which signals that the SNMPv2c element is reinitializing such that its configuration is unaltered.
- authenticationFailure, which signals that the SNMPv2c element has received a protocol message that is not properly authenticated (contingent on the snmpEnableAuthenTraps object setting).
- linkDown, as defined in RFC 1573
- linkUp, as defined in RFC 1573
- egpNeighborLoss, as defined in RFC 1213
- whispGPSInSync, which signals a transition from not synchronized to synchronized.
- whispGPSOutSync, which signals a transition from synchronized to not synchronized.
- whispRegComplete, which signals registration completed.
- whispRegLost, which signals registration lost.
- whispRadarDetected, which signals that the one-minute scan has been completed, radar has been detected and the radio will shut down.
- whispRadarEnd, which signals that the one-minute scan has been completed, radar has not been detected and the radio will resume normal operation.

**Note**

The proprietary MIBs are provided in the 450 Platform Family software download files in the support website (see [Contacting Cambium Networks](#) on page 1).

Enabling SNMP

Enable the SNMP interface for use by configuring the following attributes in the SNMP Configuration page:

- SNMP State (default disabled)
- SNMP Version (default SNMPv2c)
- SNMP Port Number (default 161)

Security planning

This section describes how to plan for 450 Platform Family links to operate in secure mode.

- Managing module access by passwords
- Filtering protocols and ports
- Port Configuration

Isolating AP/BHM from the Internet

Ensure that the IP addresses of the AP/BHM in the network:

- are not routable over the Internet.
- do not share the subnet of the IP address of your user.

RFC 1918, Address Allocation for Private Subnets, reserves for private IP networks three blocks of IP addresses that are not routable over the Internet:

- /8 subnets have one reserved network, 10.0.0.0 to 10.255.255.255.
- /16 subnets have 16 reserved networks, 172.16.0.0 to 172.31.255.255.
- /24 subnets have 256 reserved networks, 192.168.0.0 to 192.168.255.255.

Encrypting radio transmissions

Cambium fixed wireless broadband IP systems employ the following form of encryption for security of the wireless link:

- **DES (Data Encryption Standard):** An over-the-air link encryption option that uses secret 56-bit keys and 8 parity bits. DES performs a series of bit permutations, substitutions, and recombination operations on blocks of data. DES encryption does not affect the performance or throughput of the system.
- **AES (Advanced Encryption Standard):** An over-the-air link encryption option that uses the Rijndael algorithm and 128-bit keys to establish a higher level of security than DES. AES products are certified as compliant with the Federal Information Processing Standards (FIPS 197) in the U.S.A.

The default encryption setting for 450 Platform Family ODU is "None".

Planning for HTTPS operation

Before starting to configure HTTPS operation, ensure that the cryptographic material listed in [Table 84](#) is available.

Table 84 HTTPS security material

Item	Description	Quantity required
User Defined Security Banner	The banner provides warnings and notices to be read by the user before logging in to the ODU. Use text that is appropriate to the network security policy.	Normally one per link. This depends upon network policy.
Port numbers for HTTP, HTTPS and Telnet	Port numbers allocated by the network.	As allocated by network.

Planning for SNMPv3 operation

SNMP security mode

Decide how SNMPv3 security will be configured.

MIB-based security management uses standard SNMPv3 MIBs to configure the user-based security model and the view-based access control model. This approach provides considerable flexibility, allowing a network operator to tailor views and security levels appropriate for different types of user. MIB-based security management may allow a network operator to take advantage of built-in security management capabilities of existing network managers.

Web-based security management allows an operator to configure users, security levels, privacy and authentication protocols, and passphrases using the 450 Platform Family web-based management interface. The capabilities supported are somewhat less flexible than those supported using the MIB-based security management, but will be sufficient in many applications. Selection of web-based management for SNMPv3 security disables the MIB-based security management. 450 Platform Family does not support concurrent use of MIB-based and web-based management of SNMPv3 security.

Web-based management of SNMPv3 security

Initial configuration of SNMPv3 security is available only to HTTP or HTTPS user accounts with security role of Security Officer.

Identify the format used for SNMP Engine ID. The following formats are available:

- MAC address (default)
- 5 and 32 hex characters (the hex character input is driven by RFC 3411 recommendations on the Engine ID)

Identify the user names and security roles of initial SNMPv3 users. Two security roles are available:

- Read Only
- System Administrator

Identify the security level for each of the security roles. Three security levels are available:

- (a) No authentication, no privacy
- (b) Authentication, no privacy
- (c) Authentication, privacy

If authentication is required, identify the protocol. The authentication protocol available is MD5.

If privacy will be used, identify the protocol. The privacy protocol available is cbc-des.

Managing module access by passwords

From the factory, each module has a preconfigured administrator-level account in the name `root`, which initially requires no associated password. When you upgrade a module:

- An account is created in the name `admin`.
- Both `admin` and `root` inherit the password that was previously used to access the module, if:
 - **Full Access** password, if one was set.
 - **Display-Only Access** password, if one was set and no Full Access password was set.



Caution

If you use Wireless Manager, do not delete the `root` account from any module. If you use a NMS that communicates with modules through SNMP, do not delete the `root` account from any module unless you first can confirm that the NMS does not rely on the `root` account for access to the modules.

Each module supports four or fewer user accounts, regardless of account levels. The available levels are

- **ADMINISTRATOR**, who has full read and write permissions. This is the level of the `root` and `admin` users, as well as any other administrator accounts that one of them creates.
- **INSTALLER**, who has permissions identical to those of **ADMINISTRATOR** except that the installer cannot add or delete users or change the password of any other user.
- **TECHNICIAN**, who has permissions to modify basic radio parameters and view informational web pages.
- **GUEST**, who has no write permissions and only a limited view of General Status tab.
- Admin, Installer and Tech accounts can be configured as **READ-ONLY**. This will allow the account to only see the items.

The ability to view information of General Status tab can be controlled by the "Site Information Viewable to Guest Users" under the SNMP tab.

From the factory default state, configure passwords for both the `root` and `admin` account at the ADMINISTRATOR permission level, using the **Account > Change Users Password** page. (If you configure only one of these, then the other will still require no password for access into it and thus remain a security risk.) If you are intent on configuring only one of them, delete the `admin` account. The `root` account is the only account that CNUT uses to update the module.

After a password has been set for any ADMINISTRATOR-level account, initial access to the module GUI opens the view of GUEST level.

Planning for RADIUS operation

Configure RADIUS where remote authentication is required for users of the web-based interface. Remote authentication has the following advantages:

- Control of passwords can be centralized.
- Management of user accounts can be more sophisticated. For example; users can be prompted by a network manager to change passwords at regular intervals. As another example, passwords can be checked for inclusion of dictionary words and phrases.
- Passwords can be updated without reconfiguring multiple network elements.
- User accounts can be disabled without reconfiguring multiple network elements.

Remote authentication has one significant disadvantage in a wireless link product such as 450 Platform Family. If the wireless link is down, a unit on the remote side of the broken link may be prevented from contacting a RADIUS Server, with the result that users are unable to access the web-based interface.

One useful strategy would be to combine RADIUS authentication for normal operation with a single locally-authenticated user account for emergency use.

PMP 450 Platform Family SM provides a choice of the following authentication methods:

- Phase 1:
 - EAP-MSCHAPv2
 - EAP-TTLS
 - EAP PEAP
- Phase 2:
 - PAP
 - CHAP
 - MSCHAPv2

Ensure that the authentication method selected in 450 Platform Family is supported by the RADIUS server.

Filtering protocols and ports

Configure filters for specified protocols and ports from leaving the AP/BHM and SM/BHS and entering the network. This protects the network from both intended and inadvertent packet loading or probing by network users. By keeping the specified protocols or ports off the network, this feature also provides a level of protection to users from each other.

Protocol and port filtering is set per AP/SM/BH. Except for filtering of SNMP ports, filtering occurs as packets leave the AP/SM/BH.

For example, if SM is configured to filter SNMP, then SNMP packets are blocked from entering the SM and, thereby, from interacting with the SNMP portion of the protocol stack on the SM.

Port Filtering with NAT Enabled

Where NAT is enabled on the SM/BHS, the filtering can be enabled for only the user-defined ports. The following are examples for situations where the configure port can be filtered where NAT is enabled:

- To block a subscriber from using FTP, you can filter Ports 20 and 21 (the FTP ports) for both the TCP and UDP protocols.
- To block a subscriber from access to SNMP, you can filter Ports 161 and 162 (the SNMP ports) for both the TCP and UDP protocols.



Note

In only the SNMP case, filtering occurs before the packet interacts with the protocol stack.

Protocol and Port Filtering with NAT Disabled

Where NAT is disabled on the SM/BHS, the filtering can be enabled for both protocols and the three user-defined ports. Using the check boxes on the interface, it can be either:

- Allow all protocols except those that user wish to block.
- Block all protocols except those that user wish to allow.

Allow or block any of the following protocols:

- PPPoE (Point to Point Protocol over Ethernet)
- Any or all the following IPv4 (Internet Protocol version 4) protocols:
 - SMB (Network Neighborhood)
 - SNMP
 - Bootp Client
 - Bootp Server
 - Up to 3 user-defined ports
 - All other IPv4 traffic (see [Figure 29](#))
- Any or all of the following IPv6 (Internet Protocol version 6) protocols:
 - SMB (Network Neighborhood)
 - SNMP
 - Bootp Client
 - Bootp Server
 - Up to 3 user-defined ports

- All other IPv6 traffic (see Figure 29)
- Filter Direction – Upstream and Downstream
- ARP (Address Resolution Protocol)

Figure 59 Categorical protocol filtering

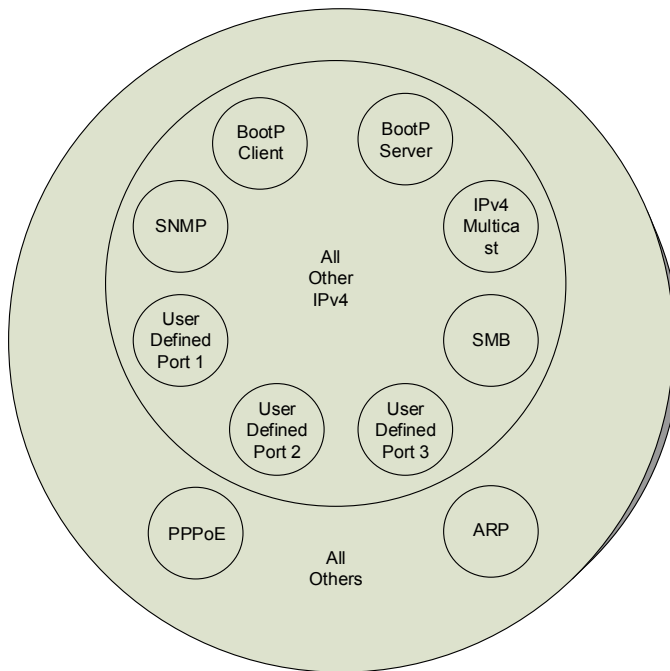

The following are example situations in which the protocol filtering is configured where NAT is disabled:

- If a subscriber is blocked from only PPPoE and SNMP, then the subscriber retains access to all other protocols and all ports.
- If PPPoE, IPv4, and Uplink Broadcast are blocked, and check the **All others** selection, then only Address Resolution Protocol is not filtered.

The ports filtered because of protocol selections in the **Protocol Filtering** tab of the SM/BHS are listed in [Table 85](#).

Table 85 Ports filtered per protocol selections

Protocol Selected	Port Filtered (Blocked)
SMB	Destination Ports UDP: 137, 138, 139, 445, 3702 and 1900 Destination Ports TCP: 137, 138, 139, 445, 2869, 5357 and 5358
SNMP	Destination Ports TCP and UDP: 161 and 162
Bootp Client	Source Port 68 UDP
Bootp Server	Source Port 67 UDP
User Defined Port 1..3	User defined ports for filtering UDP and TCP
IPv4 Multicast	Block IPv4 packet types except other filters defined
IPv6 Multicast	Block IPv6 packet types except other filters defined
ARP	Filter all Ethernet packet type 806
Upstream	Applies packet filtering to traffic coming into the FEC interface
Downstream	Applies packet filtering to traffic destined to exit the FEC interface

Port Configuration

450 Platform Family supports access to various communication protocols and only the ports required for these protocols are available for access by external entities. Operators may change the port numbers for these protocols via the radio GUI or SNMP.

Table 86 Device default port numbers

Port	Usage	Port Usage	Device
21	FTP	Listen Port	AP, SM
80	HTTP	Listen Port	AP, SM
443	HTTPS	Listen Port	AP, SM
161	SNMP port	Listen Port	AP, SM
162	SNMP trap port	Destination Port	AP, SM
514	Syslog Server port	Destination Port	AP, SM
1812	Standard RADIUS port	Destination Port	AP
1813	Standard RADIUS accounting port	Destination Port	AP, SM

Encrypting downlink broadcasts

An AP can be enabled to encrypt downlink broadcast packets such as the following:

- ARP
- NetBIOS
- broadcast packets containing video data on UDP.

The encryption used is DES for a DES-configured module and AES for an AES-configured module. Before the Encrypt Downlink Broadcast feature is enabled on the AP, air link security must be enabled on the AP.

Isolating SMs in PMP

In an AP, SMs in the sector can be prevented from directly communicating with each other. In CMM4, the connected APs can be prevented from directly communicating with each other, which prevents SMs that are in different sectors of a cluster from communicating with each other.

In the AP, the **SM Isolation** parameter is available in the General tab of the Configuration web page. Configure the SM Isolation feature by any of the following selections from drop-down menu:

- **Disable SM Isolation** (the default selection). This allows full communication between SMs.
- **Enable Option 1 - Block SM destined packets from being forwarded**. This prevents both multicast/broadcast and unicast SM-to-SM communication.
- **Enable Option 2 - Forward SM destined packets upstream**. This not only prevents multicast/broadcast and unicast SM-to-SM communication but also sends the packets, which otherwise may have been handled SM to SM, through the Ethernet port of the AP.

In the CMM and the CMM4, SM isolation treatment is the result of how to manage the port-based VLAN feature of the embedded switch, where all traffic can be switched from any AP to a specified uplink port. However, this is not packet level switching. It is not based on VLAN IDs.

Filtering management through Ethernet

Configure the SM to disallow any device that is connected to its Ethernet port from accessing the IP address of the SM. If the **Ethernet Access Control** parameter is set to **Enabled**, then:

- No attempt to access the SM management interface (by http, SNMP, ftp, or tftp) through Ethernet is granted.
- Any attempt to access the SM management interface over the air (by IP address, presuming that **LAN1 Network Interface Configuration, Network Accessibility** is set to **Public**, or by link from the Session Status or Remote Subscribers tab in the AP) is unaffected.

Allowing management from only specified IP addresses

The Security sub-menu of the Configuration web page in the AP/BHM and SM/BHS includes the **IP Access Control** parameter. Specify one, two, or three IP addresses that must be allowed to access the management interface (by HTTP, SNMP, FTP or TFTP).

If the selection is:

- **IP Access Filtering Disabled**, then management access is allowed from any IP address, even if the Allowed Source IP 1 to 3 parameters are populated.
- **IP Access Filtering Enabled**, and specify at least one address in the Allowed Source IP 1 to 3 parameter, then management access is limited to the specified address(es).

Configuring management IP by DHCP

The **Configuration > IP** web page of every radio contains a **LAN1 Network Interface** Configuration, DHCP State parameter that, if enabled, causes the IP configuration (IP address, subnet mask, and gateway IP address) to be obtained through DHCP instead of the values of those individual parameters. The setting of this DHCP state parameter is also viewable, but is not settable, in the Network Interface tab of the Home page.

In the SM/BHS, this parameter is settable

- in the **NAT** tab of the Configuration web page, but only if NAT is enabled.
- in the **IP** tab of the Configuration web page, but only if the Network Accessibility parameter in the IP tab is set to Public.

DHCP option 81

The DHCP server can be used to register and update the pointer (PTR) and host (A) DNS resource records on behalf of its DHCP-enabled clients.

The DHCP option 81 permits the client to provide its fully qualified domain name (FQDN) as well as instructions to the DHCP server on how it would like the server to process DNS dynamic updates (if any) on its behalf. The hostname is populated as SiteName.DomainName depending upon following conditions:

- If SiteName is default i.e. No Site Name, mac address will be used instead.
- The SiteName should only be a-z | A-Z | 0-9 and period(.) and dash (-).
- The domain name part should not start or end with dash (-).
- The underscore or space in domain name part will be converted to dash (-), anything else apart from valid characters will be skipped.

Controlling PPPoE PADI Downlink Forwarding

The AP supports the control of forwarding of PPPoE PADI (PPPoE Active Discovery Initiation) packets. This forwarding is configured on the AP GUI **Configuration > Radio** page by parameter **PPPoE PADI Downlink Forwarding**. When set to “Enabled”, the AP allows downstream and upstream transmission of PPPoE PADI packets. When set to “Disabled”, the AP does NOT allow PPPoE PADI packets to be sent out of the AP RF interface (downstream) but will allow PPPoE PADI packets to enter the RF interface (upstream) and exit the Ethernet interface.

Remote AP Deployment

In cases where the subscriber population is widely distributed, or conditions such as geography restrict network deployment, you can add a Remote AP to:

- provide high-throughput service to near LoS business subscribers.
- reach around obstructions or penetrate foliage with non-LoS throughput.
- reach new, especially widely distributed, residential subscribers with broadband service.
- pass sync to an additional RF hop.

In the remote AP configuration, a remote AP is co-located with an SM. The remote AP distributes the signal to SMs that are logically behind the co-located SM. A remote AP deployment is illustrated in [Figure 60](#).

Figure 60 Remote AP deployment

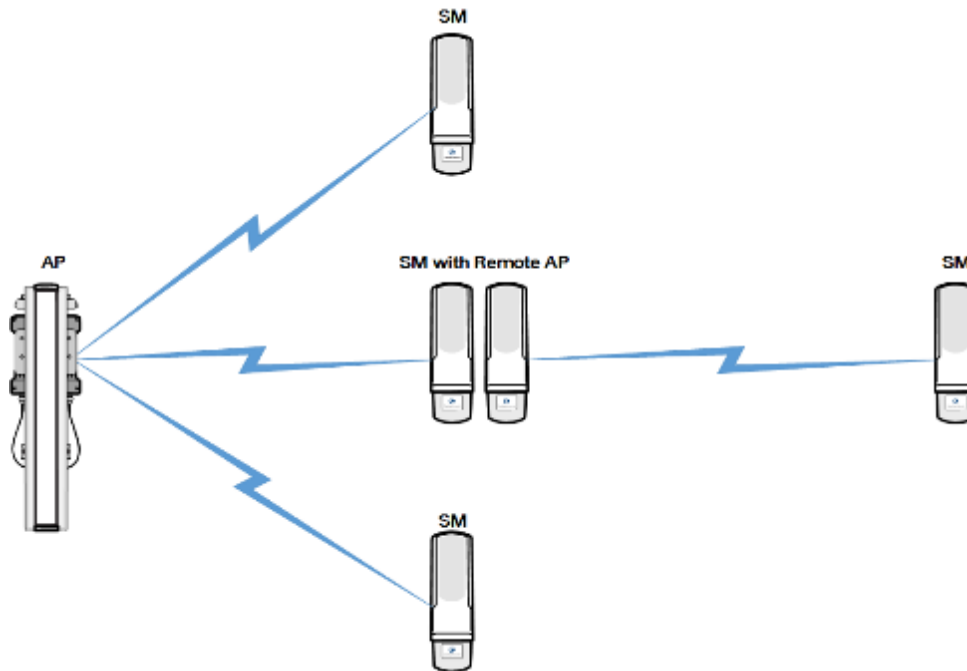

The co-located SM receives data in one channel, and the remote AP must redistribute the data in a different channel. The two channels need to have a frequency gap equal to at least two times the used channel bandwidth.

Base your selection of frequency band ranges on regulatory restrictions, environmental conditions, and throughput requirements.



Note

Each relay hop (additional daisy-chained remote AP) adds approximately 5-7 msec round trip latency.

Remote AP (RAP) Performance

The performance of a remote AP is identical to the AP performance in cluster. Throughputs, ranges, and antenna coverage are identical.

As with all equipment operating in the unlicensed spectrum, Cambium strongly recommends that you perform site surveys before you add network elements. These will indicate that spectrum is available in the area where you want to grow. Keep in mind that:

- non-LoS ranges heavily depend on environmental conditions.
- in most regions, not all frequencies are available.
- your deployments must be consistent with local regulatory restrictions.

Example Use Case for RF Obstructions

A remote AP can be used to provide last-mile access to a community where RF obstructions prevent SMs from communicating with the higher-level AP in cluster. For example, you may be able to use 900 MHz for the last mile between a remote AP and the outlying SMs where these subscribers cannot form good links to a higher-level 5 GHz AP. In this case, the ability of the 900-MHz wavelength to be effective around foliage at short range solves the foliage penetration problem.

An example of this use case is shown in [Figure 61](#).

In this example, the 5 GHz AP is a PMP 450i AP in the 5.8 GHz band operating on a 20 MHz channel with a 2.5 ms frame; the SMs are 5 GHz PMP 450 integrated SMs. The SM connected to the remote AP is a PMP 450i SM.

The remote AP is a PMP 450i AP in the 900 MHz band, also operating in a 20 MHz channel with a 2.5 ms frame; the SMs are 900 MHz PMP 450 connectorized SMs using the Cambium 23 dBi gain antenna.

Figure 61 Example for 900-MHz remote AP behind 5 GHz SM

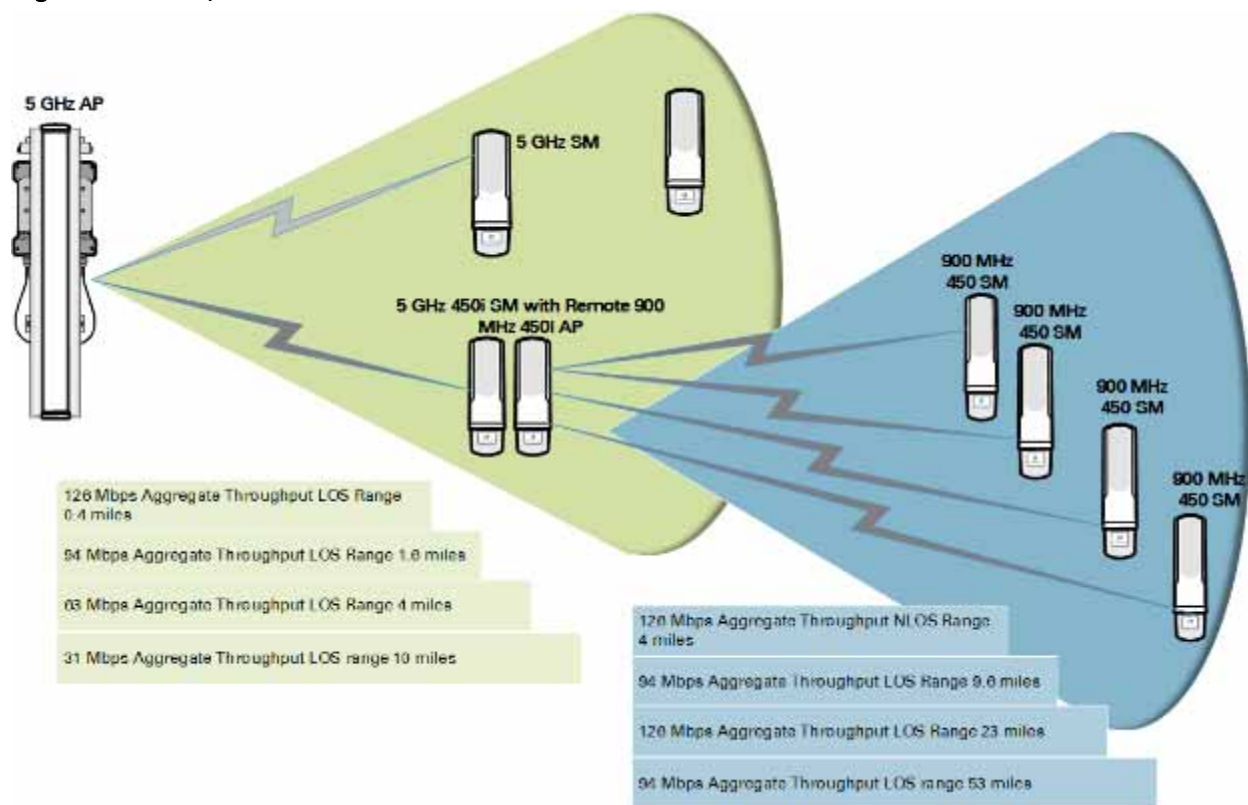

The 5 GHz modules provide a sustained aggregate throughput of up to 126 Mbps to the sector. One of the SMs in the sector is wired to a 900-MHz remote AP, which provides NLoS sustained aggregate throughput² of:

- 126 Mbps to 900-MHz SMs up to 4 miles away in the sector.
- 94 Mbps to 900-MHz SMs between 4 and 10 miles away in the sector.

Example Use Case for Passing Sync

All radios support the remote AP functionality. The BHS and the SM can reliably pass the sync pulse, and the BHM and AP can reliably receive it.

However, not all devices are compatible with all other devices. The following table shows which SMs can be connected to which APs.

Devices	PMP 450 AP/BHM	PMP 450i AP/BHM	PMP 450m AP
PMP 450 SM/BHS	X		
PMP 450i SM/BHS		X	X

² NLoS ranges depend on environmental conditions. Your results may vary from these.

Examples of passing sync over cable are shown under [Passing Sync in an Additional Hop](#) on page 3-56.

For PMP 450, the sync is passed in a cable that connects Pins 1 and 6 of the RJ-11 timing ports of the two modules.

For PMP 450i/450m the sync is passed in a cable that connects Pins 7 and 8 of the RJ-45 timing ports of the two modules.

When connecting modules in this way, make sure the AP and SM are properly configured, as described in the [Wiring to Extend Network Sync](#).

Physical Connections Involving the Remote AP

The SM to which a remote AP is connected to can be either an SM that serves a customer or an SM that simply serves as a relay. If the SM serves a customer, wire the remote AP to the SM as shown in [Figure 62](#).

Figure 62 Remote AP wired to SM that also serves a customer

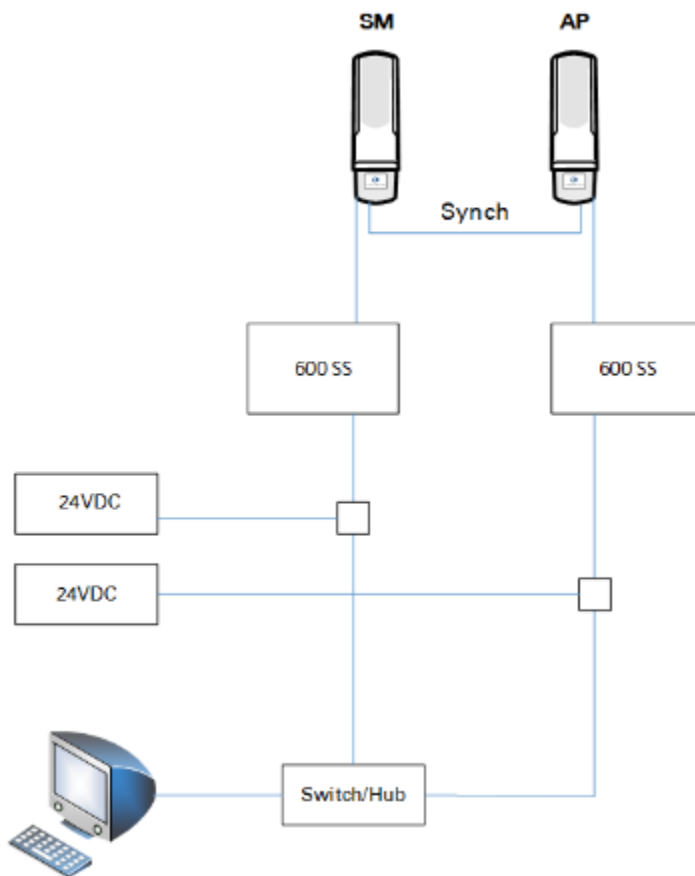

If the SM simply serves as a relay, you must use a straight-through RJ-45 female-to-female coupler and wire the SM to the remote AP as shown in [Figure 63](#).

Figure 63 Remote AP wired to SM that serves as a relay

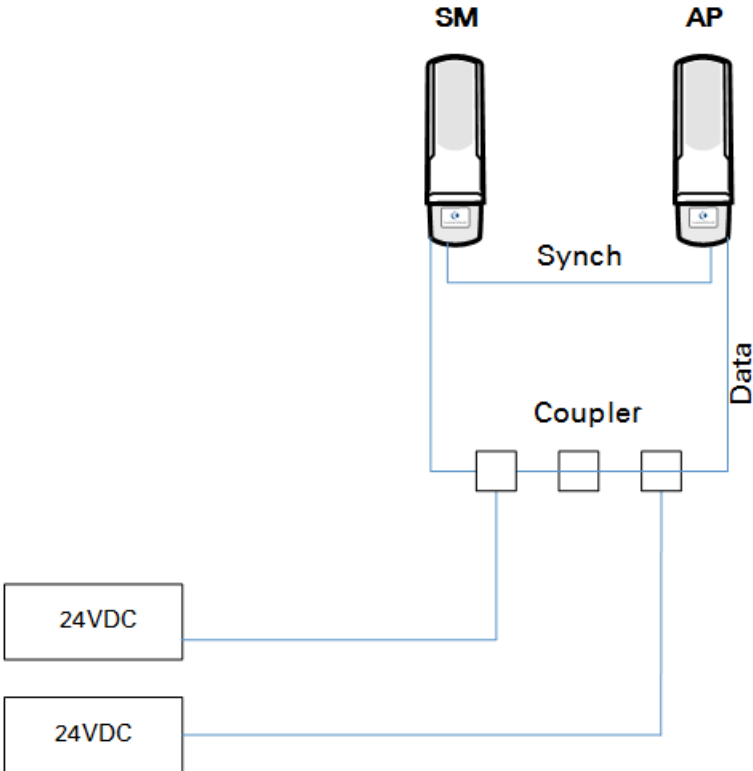

Passing Sync signal

Passing Sync in a Single Hop

Network sync can be passed in a single hop in the following network designs:

- Design 1
 - A CMM provides sync to a co-located AP.
 - This AP sends the sync over the air to SMs.
- Design 2
 - A CMM provides sync to a co-located BH timing master.
 - This BH timing master sends the sync over the air to a BH timing slave.

Passing Sync in an Additional Hop

Network sync can be extended by one additional link in any of the following network designs:



Note

In each of these following designs, Link 2 is not on the same frequency band as Link 4. (For example, Link 2 may be a 5.2 GHz link while Link 4 is a 5.7 or 2.4 GHz link.)

- Design 3
 - A CMM provides sync to a co-located AP.
 - This AP sends the sync over the air to an SM.
 - This SM delivers the sync to a co-located AP.
 - This AP passes the sync in the additional link over the air to SMs.

This design is illustrated in [Figure 64](#).

Figure 64 Additional link to extend network sync, Design 3

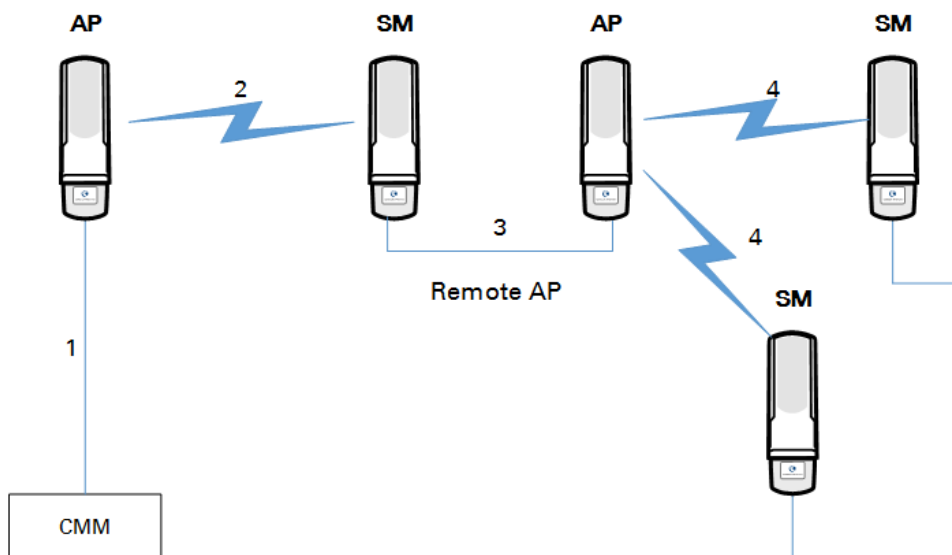

- Design 4
 - A CMM provides sync to a co-located AP.
 - This AP sends the sync over the air to an SM.
 - This SM delivers the sync to a co-located BHM.
 - This BHM passes the sync in the additional link over the air to a BHS.

This design is illustrated in [Figure 65](#).

Figure 65 Additional link to extend network sync, Design 4

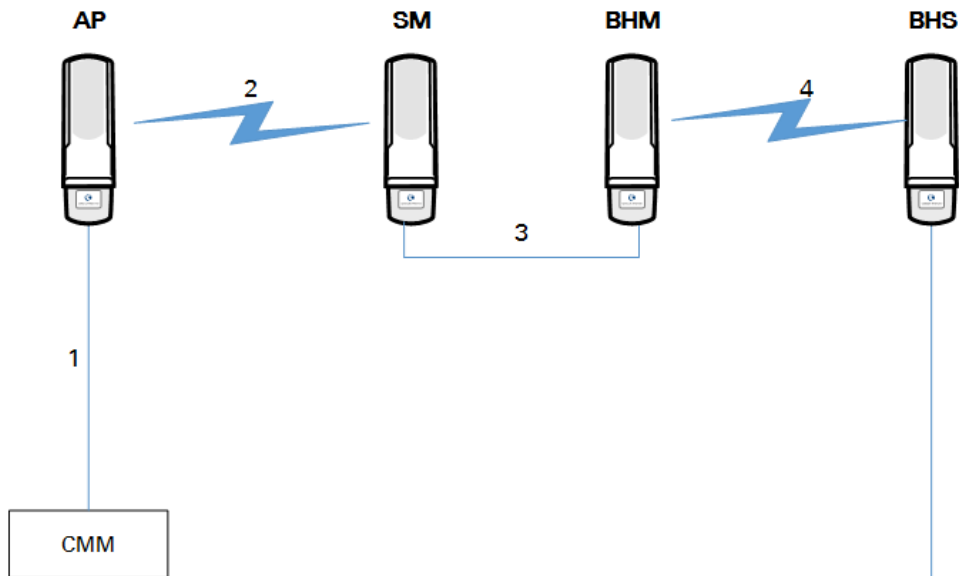

- Design 5
 - A CMM provides sync to a co-located BHM or the BHM generates timing.
 - This BHM sends the sync over the air to a BHS.
 - This BHS delivers the sync to a co-located AP.

This AP passes the sync in the additional link over the air to SMs.

This design is illustrated in [Figure 66](#).

Figure 66 Additional link to extend network sync, Design 5

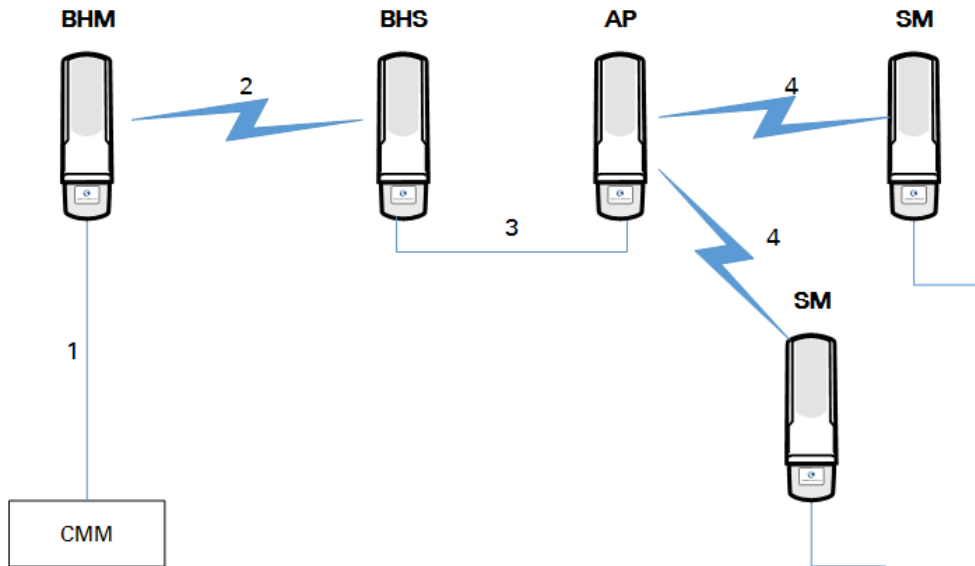

Wiring and configuration information for this sync extension is described under [Wiring to Extend Network Sync](#) on page 3-59.

Wiring to Extend Network Sync

The following procedure can be used to extend network sync by one additional hop, as described under [Passing Sync in an Additional Hop](#) on page 3-56. When a co-located module receives sync over the air, the co-located modules can be wired to pass the sync as follows:

1. Connect the GPS Utility ports of the co-located modules using a sync cable with RJ-11 (for 450) or RJ-45 (for 450i/450m) connectors.
2. Set the Sync Input parameter on the Configuration page of the co-located AP or BH timing master to AutoSync.
3. Set the Device Type parameter on the Configuration page of the co-located AP or BH timing master to Remote.
4. Set the Sync Output to Aux Port parameter on the Configuration page of the co-located AP or BH timing master to Disabled.
5. Set the UGPS Power parameter on the Configuration page of the co-located AP or BH timing master to Disabled.
6. Set the Frame Timing Pulse Gated parameter on the Configuration page of the co-located SM or BH timing slave to Enable.



Note

This setting prevents interference if the SM or BH timing slave loses sync.

Figure 67 Co-located AP or BH timing master Sync Setting configuration

Sync Setting	
Sync Input :	AutoSync ▼
Free Run Before GPS Sync :	<input type="radio"/> Enabled <input checked="" type="radio"/> Disabled
Device Type :	<input type="radio"/> Standard <input checked="" type="radio"/> Remote
Verify GPS Message Checksum :	<input checked="" type="radio"/> Enabled <input type="radio"/> Disabled
Sync Output to Aux Port :	<input type="radio"/> Enabled <input checked="" type="radio"/> Disabled
UGPS Power :	<input type="radio"/> Enabled <input checked="" type="radio"/> Disabled

Chapter 4: Legal and regulatory information

This chapter provides end user license agreements and regulatory notifications.



Caution

Intentional or unintentional changes or modifications to the equipment must not be made unless under the express consent of the party responsible for compliance. Any such modifications could void the user's authority to operate the equipment and will void the manufacturer's warranty.



Attention

Changements ou modifications Intentionnels ou non de l'équipement ne doivent pas être entrepris sans l'autorisation de l'organisme responsable de la déclaration de conformité. Ces modifications ou changements pourraient invalider le droit de l'utilisateur à utiliser cet appareil et annuleraient la garantie du fabricant.

The following topics are described in this chapter:

- [Cambium Networks end user license agreement](#) on page 4-2 contains the Cambium and third-party license agreements for the 450 Platform Family ODUs.
- [Compliance with safety standards](#) on page 4-22 lists the safety specifications against which the 450 Platform Family has been tested and certified. It also describes how to keep RF exposure within safe limits.
- [Compliance with radio regulations](#) on page 4-35 describes how the 450 Platform Family complies with the radio regulations that are in force in various countries, and contains notifications made to regulatory bodies for the 450 Platform Family.

Cambium Networks end user license agreement

Definitions

In this Agreement, the word “Software” refers to the set of instructions for computers, in executable form and in any media, (which may include diskette, CD-ROM, downloadable internet, hardware, or firmware) licensed to you. The word “Documentation” refers to electronic or printed manuals and accompanying instructional aids licensed to you. The word “Product” refers to Cambium Networks’ fixed wireless broadband devices for which the Software and Documentation is licensed for use.

Acceptance of this agreement

In connection with Cambium Networks’ delivery of certain proprietary software or products containing embedded or pre-loaded proprietary software, or both, Cambium Networks is willing to license this certain proprietary software and the accompanying documentation to you only on the condition that you accept all the terms in this End User License Agreement (“Agreement”).

IF YOU DO NOT AGREE TO THE TERMS OF THIS AGREEMENT, DO NOT USE THE PRODUCT OR INSTALL THE SOFTWARE. INSTEAD, YOU MAY, FOR A FULL REFUND, RETURN THIS PRODUCT TO THE LOCATION WHERE YOU ACQUIRED IT OR PROVIDE WRITTEN VERIFICATION OF DELETION OF ALL COPIES OF THE SOFTWARE. ANY USE OF THE SOFTWARE, INCLUDING BUT NOT LIMITED TO USE ON THE PRODUCT, WILL CONSTITUTE YOUR ACCEPTANCE TO THE TERMS OF THIS AGREEMENT.

Grant of license

Cambium Networks Limited (“Cambium”) grants you (“Licensee” or “you”) a personal, nonexclusive, non-transferable license to use the Software and Documentation subject to the Conditions of Use set forth in “**Conditions of use**” and the terms and conditions of this Agreement. Any terms or conditions relating to the Software and Documentation appearing on the face or reverse side of any purchase order, purchase order acknowledgment or other order document that are different from, or in addition to, the terms of this Agreement will not be binding on the parties, even if payment is accepted.

Conditions of use

Any use of the Software and Documentation outside of the conditions set forth in this Agreement is strictly prohibited and will be deemed a breach of this Agreement.

1. Only you, your employees or agents may use the Software and Documentation. You will take all necessary steps to insure that your employees and agents abide by the terms of this Agreement.
2. You will use the Software and Documentation (i) only for your internal business purposes; (ii) only as described in the Software and Documentation; and (iii) in strict accordance with this Agreement.
3. You may use the Software and Documentation, provided that the use is in conformance with the terms set forth in this Agreement.
4. Portions of the Software and Documentation are protected by United States copyright laws, international treaty provisions, and other applicable laws. Therefore, you must treat the Software like any other copyrighted material (for example, a book or musical recording) except that you may either: (i) make 1 copy of the transportable part of the Software (which typically is supplied on diskette, CD-ROM, or downloadable internet), solely for back-up purposes; or (ii) copy the transportable part of the Software to a PC hard disk, provided you keep the original solely for back-up purposes. If the Documentation is in printed form, it may not be copied. If the Documentation is in electronic form, you may print out 1 copy, which then may not be copied. With regard to the copy made for backup or archival purposes, you agree to reproduce any Cambium Networks copyright notice, and other proprietary legends appearing thereon. Such copyright notice(s) may appear in any of several forms, including machine-readable form, and you agree to reproduce such notice in each form in which it appears, to the extent it is physically possible to do so. Unauthorized duplication of the Software or Documentation constitutes copyright infringement, and in the United States is punishable in federal court by fine and imprisonment.
5. You will not transfer, directly or indirectly, any product, technical data or software to any country for which the United States Government requires an export license or other governmental approval without first obtaining such license or approval.

Title and restrictions

If you transfer possession of any copy of the Software and Documentation to another party outside of the terms of this agreement, your license is automatically terminated. Title and copyrights to the Software and Documentation and any copies made by you remain with Cambium Networks and its licensors. You will not, and will not permit others to: (i) modify, translate, decompile, bootleg, reverse engineer, disassemble, or extract the inner workings of the Software or Documentation, (ii) copy the look-and-feel or functionality of the Software or Documentation; (iii) remove any proprietary notices, marks, labels, or logos from the Software or Documentation; (iv) rent or transfer all or some of the Software or Documentation to any other party without Cambium's prior written consent; or (v) utilize any computer software or hardware which is designed to defeat any copy protection device, should the Software and Documentation be equipped with such a protection device. If the Software and Documentation is provided on multiple types of media (such as diskette, CD-ROM, downloadable internet), then you will only use the medium which best meets your specific needs, and will not loan, rent, lease, or transfer the other media contained in the package without Cambium's written consent. Unauthorized copying of the Software or Documentation, or failure to comply with any of the provisions of this Agreement, will result in automatic termination of this license.

Confidentiality

You acknowledge that all Software and Documentation contain valuable proprietary information and trade secrets and that unauthorized or improper use of the Software and Documentation will result in irreparable harm to Cambium Networks for which monetary damages would be inadequate and for which Cambium Networks will be entitled to immediate injunctive relief. If applicable, you will limit access to the Software and Documentation to those of your employees and agents who need to use the Software and Documentation for your internal business purposes, and you will take appropriate action with those employees and agents to preserve the confidentiality of the Software and Documentation, using the same degree of care to avoid unauthorized or improper disclosure as you use for the protection of your own proprietary software, but in no event less than reasonable care.

You have no obligation to preserve the confidentiality of any proprietary information that: (i) was in the public domain at the time of disclosure; (ii) entered the public domain through no fault of yours; (iii) was given to you free of any obligation to keep it confidential; (iv) is independently developed by you; or (v) is disclosed as required by law provided that you notify Cambium Networks prior to such disclosure and provide Cambium Networks with a reasonable opportunity to respond.

Right to use Cambium's name

Except as required in "**Conditions of use**", you will not, during the term of this Agreement or thereafter, use any trademark of Cambium Networks, or any word or symbol likely to be confused with any Cambium Networks trademark, either alone or in any combination with another word or words.

Transfer

The Software and Documentation may not be transferred to another party without the express written consent of Cambium Networks, regardless of whether or not such transfer is accomplished by physical or electronic means. Cambium's consent may be withheld at its discretion and may be conditioned upon transferee paying all applicable license fees and agreeing to be bound by this Agreement.

Updates

During the first 12 months after purchase of a Product, or during the term of any executed Maintenance and Support Agreement for the Product, you are entitled to receive Updates. An "Update" means any code in any form which is a bug fix, patch, error correction, or minor enhancement, but excludes any major feature added to the Software. Updates are available for download at the support website.

Major features may be available from time to time for an additional license fee. If Cambium Networks makes available to your major features and no other end user license agreement is provided, then the terms of this Agreement will apply.

Maintenance

Except as provided above, Cambium Networks is not responsible for maintenance or field service of the Software under this Agreement.

Disclaimer

CAMBIUM NETWORKS DISCLAIMS ALL WARRANTIES OF ANY KIND, WHETHER EXPRESS, IMPLIED, STATUTORY, OR IN ANY COMMUNICATION WITH YOU. CAMBIUM NETWORKS SPECIFICALLY DISCLAIMS ANY WARRANTY INCLUDING THE IMPLIED WARRANTIES OF MERCHANTABILITY, NONINFRINGEMENT, OR FITNESS FOR A PARTICULAR PURPOSE. THE SOFTWARE AND DOCUMENTATION ARE PROVIDED "AS IS." CAMBIUM NETWORKS DOES NOT WARRANT THAT THE SOFTWARE WILL MEET YOUR REQUIREMENTS, OR THAT THE OPERATION OF THE SOFTWARE WILL BE UNINTERRUPTED OR ERROR FREE, OR THAT DEFECTS IN THE SOFTWARE WILL BE CORRECTED. CAMBIUM NETWORKS MAKES NO WARRANTY WITH RESPECT TO THE CORRECTNESS, ACCURACY, OR RELIABILITY OF THE SOFTWARE AND DOCUMENTATION. Some jurisdictions do not allow the exclusion of implied warranties, so the above exclusion may not apply to you.

Limitation of liability

IN NO EVENT SHALL CAMBIUM NETWORKS BE LIABLE TO YOU OR ANY OTHER PARTY FOR ANY DIRECT, INDIRECT, GENERAL, SPECIAL, INCIDENTAL, CONSEQUENTIAL, EXEMPLARY OR OTHER DAMAGE ARISING OUT OF THE USE OR INABILITY TO USE THE PRODUCT (INCLUDING, WITHOUT LIMITATION, DAMAGES FOR LOSS OF BUSINESS PROFITS, BUSINESS INTERRUPTION, LOSS OF BUSINESS INFORMATION OR ANY OTHER PECUNIARY LOSS, OR FROM ANY BREACH OF WARRANTY, EVEN IF CAMBIUM NETWORKS HAS BEEN ADVISED OF THE POSSIBILITY OF SUCH DAMAGES. (Some states do not allow the exclusion or limitation of incidental or consequential damages, so the above exclusion or limitation may not apply to you.) IN NO CASE SHALL CAMBIUM'S LIABILITY EXCEED THE AMOUNT YOU PAID FOR THE PRODUCT.

U.S. government

If you are acquiring the Product on behalf of any unit or agency of the U.S. Government, the following applies. Use, duplication, or disclosure of the Software and Documentation is subject to the restrictions set forth in subparagraphs (c) (1) and (2) of the Commercial Computer Software – Restricted Rights clause at FAR 52.227-19 (JUNE 1987), if applicable, unless being provided to the Department of Defense. If being provided to the Department of Defense, use, duplication, or disclosure of the Products is subject to the restricted rights set forth in subparagraph (c) (1) (ii) of the Rights in Technical Data and Computer Software clause at DFARS 252.227-7013 (OCT 1988), if applicable. Software and Documentation may or may not include a Restricted Rights notice, or other notice referring specifically to the terms and conditions of this Agreement. The terms and conditions of this Agreement will each continue to apply, but only to the extent that such terms and conditions are not inconsistent with the rights provided to you under the aforementioned provisions of the FAR and DFARS, as applicable to the particular procuring agency and procurement transaction.

Term of license

Your right to use the Software will continue in perpetuity unless terminated as follows. Your right to use the Software will terminate immediately without notice upon a breach of this Agreement by you. Within 30 days after termination of this Agreement, you will certify to Cambium Networks in writing that through your best efforts, and to the best of your knowledge, the original and all copies, in whole or in part, in any form, of the Software and all related material and Documentation, have been destroyed, except that, with prior written consent from Cambium Networks, you may retain one copy for archival or backup purposes. You may not sublicense, assign or transfer the license or the Product, except as expressly provided in this Agreement. Any attempt to otherwise sublicense, assign or transfer any of the rights, duties or obligations hereunder is null and void.

Governing law

This Agreement is governed by the laws of the United States of America to the extent that they apply and otherwise by the laws of the State of Illinois.

Assignment

This agreement may not be assigned by you without Cambium's prior written consent.

Survival of provisions

The parties agree that where the context of any provision indicates an intent that it survives the term of this Agreement, then it will survive.

Entire agreement

This agreement contains the parties' entire agreement regarding your use of the Software and may be amended only in writing signed by both parties, except that Cambium Networks may modify this Agreement as necessary to comply with applicable laws.

Third party software

The software may contain one or more items of Third-Party Software supplied by other third-party suppliers. The terms of this Agreement govern your use of any Third-Party Software UNLESS A SEPARATE THIRD-PARTY SOFTWARE LICENSE IS INCLUDED, IN WHICH CASE YOUR USE OF THE THIRD-PARTY SOFTWARE WILL THEN BE GOVERNED BY THE SEPARATE THIRD-PARTY LICENSE.

Net SNMP

Various copyrights apply to this package, listed in various separate parts below. Please make sure that you read all the parts.

---- Part 1: CMU/UCD copyright notice: (BSD like) ----

Copyright 1989, 1991, 1992 by Carnegie Mellon University

Derivative Work - 1996, 1998-2000

Copyright 1996, 1998-2000 The Regents of the University of California

All Rights Reserved

Permission to use, copy, modify and distribute this software and its documentation for any purpose and without fee is hereby granted, provided that the above copyright notice appears in all copies and that both that copyright notice and this permission notice appear in supporting documentation, and that the name of CMU and The Regents of the University of California not be used in advertising or publicity pertaining to distribution of the software without specific written permission.

CMU AND THE REGENTS OF THE UNIVERSITY OF CALIFORNIA DISCLAIM ALL WARRANTIES WITH REGARD TO THIS SOFTWARE, INCLUDING ALL IMPLIED WARRANTIES OF MERCHANTABILITY AND FITNESS. IN NO EVENT SHALL CMU OR THE REGENTS OF THE UNIVERSITY OF CALIFORNIA BE LIABLE FOR ANY SPECIAL, INDIRECT OR CONSEQUENTIAL DAMAGES OR ANY DAMAGES WHATSOEVER RESULTING FROM THE LOSS OF USE, DATA OR PROFITS, WHETHER IN AN ACTION OF CONTRACT, NEGLIGENCE OR OTHER TORTIOUS ACTION, ARISING OUT OF OR IN CONNECTION WITH THE USE OR PERFORMANCE OF THIS SOFTWARE.

---- Part 2: Networks Associates Technology, Inc copyright notice (BSD) ----

Copyright © 2001-2003, Networks Associates Technology, Inc

All rights reserved.

Redistribution and use in source and binary forms, with or without modification, are permitted provided that the following conditions are met:

- Redistributions of source code must retain the above copyright notice, this list of conditions and the following disclaimer.
- Redistributions in binary form must reproduce the above copyright notice, this list of conditions and the following disclaimer in the documentation and/or other materials provided with the distribution.
- Neither the name of the Networks Associates Technology, Inc nor the names of its contributors may be used to endorse or promote products derived from this software without specific prior written permission.

THIS SOFTWARE IS PROVIDED BY THE COPYRIGHT HOLDERS AND CONTRIBUTORS "AS IS" AND ANY EXPRESS OR IMPLIED WARRANTIES, INCLUDING, BUT NOT LIMITED TO, THE IMPLIED WARRANTIES OF MERCHANTABILITY AND FITNESS FOR A PARTICULAR PURPOSE ARE DISCLAIMED. IN NO EVENT SHALL THE COPYRIGHT HOLDERS OR CONTRIBUTORS BE LIABLE FOR ANY DIRECT, INDIRECT, INCIDENTAL, SPECIAL, EXEMPLARY, OR CONSEQUENTIAL DAMAGES (INCLUDING, BUT NOT LIMITED TO, PROCUREMENT OF SUBSTITUTE GOODS OR SERVICES; LOSS OF USE, DATA, OR PROFITS; OR BUSINESS INTERRUPTION) HOWEVER CAUSED AND ON ANY THEORY OF LIABILITY, WHETHER IN CONTRACT, STRICT LIABILITY, OR TORT (INCLUDING NEGLIGENCE OR OTHERWISE) ARISING IN ANY WAY OUT OF THE USE OF THIS SOFTWARE, EVEN IF ADVISED OF THE POSSIBILITY OF SUCH DAMAGE.

---- Part 3: Cambridge Broadband Ltd. copyright notice (BSD) ----

Portions of this code are copyright © 2001-2003, Cambridge Broadband Ltd.

All rights reserved.

Redistribution and use in source and binary forms, with or without modification, are permitted provided that the following conditions are met:

- Redistributions of source code must retain the above copyright notice, this list of conditions and the following disclaimer.
- Redistributions in binary form must reproduce the above copyright notice, this list of conditions and the following disclaimer in the documentation and/or other materials provided with the distribution.
- The name of Cambridge Broadband Ltd. may not be used to endorse or promote products derived from this software without specific prior written permission.

THIS SOFTWARE IS PROVIDED BY THE COPYRIGHT HOLDER "AS IS" AND ANY EXPRESS OR IMPLIED WARRANTIES, INCLUDING, BUT NOT LIMITED TO, THE IMPLIED WARRANTIES OF MERCHANTABILITY AND FITNESS FOR A PARTICULAR PURPOSE ARE DISCLAIMED. IN NO EVENT SHALL THE COPYRIGHT HOLDER BE LIABLE FOR ANY DIRECT, INDIRECT, INCIDENTAL, SPECIAL, EXEMPLARY, OR CONSEQUENTIAL DAMAGES (INCLUDING, BUT NOT LIMITED TO, PROCUREMENT OF SUBSTITUTE GOODS OR SERVICES; LOSS OF USE, DATA, OR PROFITS; OR BUSINESS INTERRUPTION) HOWEVER CAUSED AND ON ANY THEORY OF LIABILITY, WHETHER IN CONTRACT, STRICT LIABILITY, OR TORT (INCLUDING NEGLIGENCE OR OTHERWISE) ARISING IN ANY WAY OUT OF THE USE OF THIS SOFTWARE, EVEN IF ADVISED OF THE POSSIBILITY OF SUCH DAMAGE.

---- Part 4: Sun Microsystems, Inc. copyright notice (BSD) ----

Copyright © 2003 Sun Microsystems, Inc., 4150 Network Circle, Santa Clara, California 95054, U.S.A. All rights reserved.

Use is subject to license terms below.

This distribution may include materials developed by third parties.

Sun, Sun Microsystems, the Sun logo and Solaris are trademarks or registered trademarks of Sun Microsystems, Inc. in the U.S. and other countries.

Redistribution and use in source and binary forms, with or without modification, are permitted provided that the following conditions are met:

- Redistributions of source code must retain the above copyright notice, this list of conditions and the following disclaimer.
- Redistributions in binary form must reproduce the above copyright notice, this list of conditions and the following disclaimer in the documentation and/or other materials provided with the distribution.
- Neither the name of the Sun Microsystems, Inc. nor the names of its contributors may be used to endorse or promote products derived from this software without specific prior written permission.

THIS SOFTWARE IS PROVIDED BY THE COPYRIGHT HOLDERS AND CONTRIBUTORS "AS IS" AND ANY EXPRESS OR IMPLIED WARRANTIES, INCLUDING, BUT NOT LIMITED TO, THE IMPLIED WARRANTIES OF MERCHANTABILITY AND FITNESS FOR A PARTICULAR PURPOSE ARE DISCLAIMED. IN NO EVENT SHALL THE COPYRIGHT HOLDERS OR CONTRIBUTORS BE LIABLE FOR ANY DIRECT, INDIRECT, INCIDENTAL, SPECIAL, EXEMPLARY, OR CONSEQUENTIAL DAMAGES (INCLUDING, BUT NOT LIMITED TO, PROCUREMENT OF SUBSTITUTE GOODS OR SERVICES; LOSS OF USE, DATA, OR PROFITS; OR BUSINESS INTERRUPTION) HOWEVER CAUSED AND ON ANY THEORY OF LIABILITY, WHETHER IN CONTRACT, STRICT LIABILITY, OR TORT (INCLUDING NEGLIGENCE OR OTHERWISE) ARISING IN ANY WAY OUT OF THE USE OF THIS SOFTWARE, EVEN IF ADVISED OF THE POSSIBILITY OF SUCH DAMAGE.

---- Part 5: Sparta, Inc copyright notice (BSD) ----

Copyright © 2003-2008, Sparta, Inc

All rights reserved.

Redistribution and use in source and binary forms, with or without modification, are permitted provided that the following conditions are met:

- Redistributions of source code must retain the above copyright notice, this list of conditions and the following disclaimer.
- Redistributions in binary form must reproduce the above copyright notice, this list of conditions and the following disclaimer in the documentation and/or other materials provided with the distribution.
- Neither the name of Sparta, Inc nor the names of its contributors may be used to endorse or promote products derived from this software without specific prior written permission.

THIS SOFTWARE IS PROVIDED BY THE COPYRIGHT HOLDERS AND CONTRIBUTORS "AS IS" AND ANY EXPRESS OR IMPLIED WARRANTIES, INCLUDING, BUT NOT LIMITED TO, THE IMPLIED WARRANTIES OF MERCHANTABILITY AND FITNESS FOR A PARTICULAR PURPOSE ARE DISCLAIMED. IN NO EVENT SHALL THE COPYRIGHT HOLDERS OR CONTRIBUTORS BE LIABLE FOR ANY DIRECT, INDIRECT, INCIDENTAL, SPECIAL, EXEMPLARY, OR CONSEQUENTIAL DAMAGES (INCLUDING, BUT NOT LIMITED TO, PROCUREMENT OF SUBSTITUTE GOODS OR SERVICES; LOSS OF USE, DATA, OR PROFITS; OR BUSINESS INTERRUPTION) HOWEVER CAUSED AND ON ANY THEORY OF LIABILITY, WHETHER IN CONTRACT, STRICT LIABILITY, OR TORT (INCLUDING NEGLIGENCE OR OTHERWISE) ARISING IN ANY WAY OUT OF THE USE OF THIS SOFTWARE, EVEN IF ADVISED OF THE POSSIBILITY OF SUCH DAMAGE.

---- Part 6: Cisco/BUPTNIC copyright notice (BSD) ----

Copyright © 2004, Cisco, Inc and Information Network

Center of Beijing University of Posts and Telecommunications.

All rights reserved.

Redistribution and use in source and binary forms, with or without modification, are permitted provided that the following conditions are met:

- Redistributions of source code must retain the above copyright notice, this list of conditions and the following disclaimer.
- Redistributions in binary form must reproduce the above copyright notice, this list of conditions and the following disclaimer in the documentation and/or other materials provided with the distribution.
- Neither the name of Cisco, Inc, Beijing University of Posts and Telecommunications, nor the names of their contributors may be used to endorse or promote products derived from this software without specific prior written permission.

THIS SOFTWARE IS PROVIDED BY THE COPYRIGHT HOLDERS AND CONTRIBUTORS "AS IS" AND ANY EXPRESS OR IMPLIED WARRANTIES, INCLUDING, BUT NOT LIMITED TO, THE IMPLIED WARRANTIES OF MERCHANTABILITY AND FITNESS FOR A PARTICULAR PURPOSE ARE DISCLAIMED. IN NO EVENT SHALL THE COPYRIGHT HOLDERS OR CONTRIBUTORS BE LIABLE FOR ANY DIRECT, INDIRECT, INCIDENTAL, SPECIAL, EXEMPLARY, OR CONSEQUENTIAL DAMAGES (INCLUDING, BUT NOT LIMITED TO, PROCUREMENT OF SUBSTITUTE GOODS OR SERVICES; LOSS OF USE, DATA, OR PROFITS; OR BUSINESS INTERRUPTION) HOWEVER CAUSED AND ON ANY THEORY OF LIABILITY, WHETHER IN CONTRACT, STRICT LIABILITY, OR TORT (INCLUDING NEGLIGENCE OR OTHERWISE) ARISING IN ANY WAY OUT OF THE USE OF THIS SOFTWARE, EVEN IF ADVISED OF THE POSSIBILITY OF SUCH DAMAGE.

---- Part 7: Fabasoft R&D Software GmbH & Co KG copyright notice (BSD) ----

Copyright © Fabasoft R&D Software GmbH & Co KG, 2003

oss@fabasoft.com

Author: Bernhard Penz

Redistribution and use in source and binary forms, with or without modification, are permitted provided that the following conditions are met:

- Redistributions of source code must retain the above copyright notice, this list of conditions and the following disclaimer.
- Redistributions in binary form must reproduce the above copyright notice, this list of conditions and the following disclaimer in the documentation and/or other materials provided with the distribution.
- The name of Fabasoft R&D Software GmbH & Co KG or any of its subsidiaries, brand or product names may not be used to endorse or promote products derived from this software without specific prior written permission.

THIS SOFTWARE IS PROVIDED BY THE COPYRIGHT HOLDER "AS IS" AND ANY EXPRESS OR IMPLIED WARRANTIES, INCLUDING, BUT NOT LIMITED TO, THE IMPLIED WARRANTIES OF MERCHANTABILITY AND FITNESS FOR A PARTICULAR PURPOSE ARE DISCLAIMED. IN NO EVENT SHALL THE COPYRIGHT HOLDER BE LIABLE FOR ANY DIRECT, INDIRECT, INCIDENTAL, SPECIAL, EXEMPLARY, OR CONSEQUENTIAL DAMAGES (INCLUDING, BUT NOT LIMITED TO, PROCUREMENT OF SUBSTITUTE GOODS OR SERVICES; LOSS OF USE, DATA, OR PROFITS; OR BUSINESS INTERRUPTION) HOWEVER CAUSED AND ON ANY THEORY OF LIABILITY, WHETHER IN CONTRACT, STRICT LIABILITY, OR TORT (INCLUDING NEGLIGENCE OR OTHERWISE) ARISING IN ANY WAY OUT OF THE USE OF THIS SOFTWARE, EVEN IF ADVISED OF THE POSSIBILITY OF SUCH DAMAGE.

OpenSSL

Copyright (c) 1998-2008 The OpenSSL Project. All rights reserved.

Redistribution and use in source and binary forms, with or without modification, are permitted provided that the following conditions are met:

1. Redistributions of source code must retain the above copyright notice, this list of conditions and the following disclaimer.
2. Redistributions in binary form must reproduce the above copyright notice, this list of conditions and the following disclaimer in the documentation and/or other materials provided with the distribution.

3. All advertising materials mentioning features or use of this software must display the following acknowledgment:

"This product includes software developed by the OpenSSL Project for use in the OpenSSL Toolkit. (<http://www.openssl.org/>)"

4. The names "OpenSSL Toolkit" and "OpenSSL Project" must not be used to endorse or promote products derived from this software without prior written permission. For written permission, please contact openssl-core@openssl.org.

5. Products derived from this software may not be called "OpenSSL" nor may "OpenSSL" appear in their names without prior written permission of the OpenSSL Project.

6. Redistributions of any form whatsoever must retain the following acknowledgment:

"This product includes software developed by the OpenSSL Project for use in the OpenSSL Toolkit (<http://www.openssl.org/>)"

THIS SOFTWARE IS PROVIDED BY THE OpenSSL PROJECT "AS IS" AND ANY EXPRESSED OR IMPLIED WARRANTIES, INCLUDING, BUT NOT LIMITED TO, THE IMPLIED WARRANTIES OF MERCHANTABILITY AND FITNESS FOR A PARTICULAR PURPOSE ARE DISCLAIMED. IN NO EVENT SHALL THE OpenSSL PROJECT OR ITS CONTRIBUTORS BE LIABLE FOR ANY DIRECT, INDIRECT, INCIDENTAL, SPECIAL, EXEMPLARY, OR CONSEQUENTIAL DAMAGES (INCLUDING, BUT NOT LIMITED TO, PROCUREMENT OF SUBSTITUTE GOODS OR SERVICES; LOSS OF USE, DATA, OR PROFITS; OR BUSINESS INTERRUPTION) HOWEVER CAUSED AND ON ANY THEORY OF LIABILITY, WHETHER IN CONTRACT, STRICT LIABILITY, OR TORT (INCLUDING NEGLIGENCE OR OTHERWISE) ARISING IN ANY WAY OUT OF THE USE OF THIS SOFTWARE, EVEN IF ADVISED OF THE POSSIBILITY OF SUCH DAMAGE.

This product includes cryptographic software written by Eric Young (eay@cryptsoft.com). This product includes software written by Tim Hudson (tjh@cryptsoft.com).

Original SSLeay License

Copyright © 1995-1998 Eric Young (eay@cryptsoft.com)

All rights reserved.

This package is an SSL implementation written by Eric Young (eay@cryptsoft.com). The implementation was written so as to conform with Netscapes SSL.

This library is free for commercial and non-commercial use as long as the following conditions are adhered to. The following conditions apply to all code found in this distribution, be it the RC4, RSA, lhash, DES, etc., code; not just the SSL code. The SSL documentation included with this distribution is covered by the same copyright terms except that the holder is Tim Hudson (tjh@cryptsoft.com).

Copyright remains Eric Young's, and as such any Copyright notices in the code are not to be removed.

If this package is used in a product, Eric Young should be given attribution as the author of the parts of the library used. This can be in the form of a textual message at program startup or in documentation (online or textual) provided with the package.

Redistribution and use in source and binary forms, with or without modification, are permitted provided that the following conditions are met:

1. Redistributions of source code must retain the copyright notice, this list of conditions and the following disclaimer.
2. Redistributions in binary form must reproduce the above copyright notice, this list of conditions and the following disclaimer in the documentation and/or other materials provided with the distribution.
3. All advertising materials mentioning features or use of this software must display the following acknowledgement:

"This product includes cryptographic software written by Eric Young (eay@cryptsoft.com)"

The word 'cryptographic' can be left out if the routines from the library being used are not cryptographic related.

4. If you include any Windows specific code (or a derivative thereof) from the apps directory (application code) you must include an acknowledgement:

"This product includes software written by Tim Hudson (tjh@cryptsoft.com)"

THIS SOFTWARE IS PROVIDED BY ERIC YOUNG "AS IS" AND ANY EXPRESS OR IMPLIED WARRANTIES, INCLUDING, BUT NOT LIMITED TO, THE IMPLIED WARRANTIES OF MERCHANTABILITY AND FITNESS FOR A PARTICULAR PURPOSE ARE DISCLAIMED. IN NO EVENT SHALL THE AUTHOR OR CONTRIBUTORS BE LIABLE FOR ANY DIRECT, INDIRECT, INCIDENTAL, SPECIAL, EXEMPLARY, OR CONSEQUENTIAL DAMAGES (INCLUDING, BUT NOT LIMITED TO, PROCUREMENT OF SUBSTITUTE GOODS OR SERVICES; LOSS OF USE, DATA, OR PROFITS; OR BUSINESS INTERRUPTION) HOWEVER CAUSED AND ON ANY THEORY OF LIABILITY, WHETHER IN CONTRACT, STRICT LIABILITY, OR TORT (INCLUDING NEGLIGENCE OR OTHERWISE) ARISING IN ANY WAY OUT OF THE USE OF THIS SOFTWARE, EVEN IF ADVISED OF THE POSSIBILITY OF SUCH DAMAGE.

The license and distribution terms for any publically available version or derivative of this code cannot be changed. i.e. this code cannot simply be copied and put under another distribution license [including the GNU Public License.]

Zlib

Copyright © 1995-2005 Jean-loup Gailly and Mark Adler

This software is provided 'as-is', without any express or implied warranty. In no event will the authors be held liable for any damages arising from the use of this software.

Permission is granted to anyone to use this software for any purpose, including commercial applications, and to alter it and redistribute it freely, subject to the following restrictions:

1. The origin of this software must not be misrepresented; you must not claim that you wrote the original software. If you use this software in a product, an acknowledgment in the product documentation would be appreciated but is not required.
2. Altered source versions must be plainly marked as such, and must not be misrepresented as being the original software.
3. This notice may not be removed or altered from any source distribution.

Jean-loup Gailly jloup@gzip.org

Mark Adler madler@alumni.caltech.edu

Libpng

libpng versions 1.2.6, August 15, 2004, through 1.2.35, February 14, 2009, are Copyright © 2004, 2006-2008 Glenn Randers-Pehrson, and are distributed according to the same disclaimer and license as libpng-1.2.5 with the following individual added to the list of Contributing Authors
Cosmin Truta

libpng versions 1.0.7, July 1, 2000, through 1.2.5 - October 3, 2002, are Copyright © 2000-2002 Glenn Randers-Pehrson, and are distributed according to the same disclaimer and license as libpng-1.0.6 with the following individuals added to the list of Contributing Authors

Simon-Pierre Cadieux

Eric S. Raymond

Gilles Vollant

and with the following additions to the disclaimer:

There is no warranty against interference with your enjoyment of the library or against infringement. There is no warranty that our efforts or the library will fulfil any of your particular purposes or needs. This library is provided with all faults, and the entire risk of satisfactory quality, performance, accuracy, and effort is with the user.

libpng versions 0.97, January 1998, through 1.0.6, March 20, 2000, are Copyright © 1998, 1999 Glenn Randers-Pehrson, and are distributed according to the same disclaimer and license as libpng-0.96, with the following individuals added to the list of Contributing Authors:

Tom Lane

Glenn Randers-Pehrson

Willem van Schaik

libpng versions 0.89, June 1996, through 0.96, May 1997, are Copyright © 1996, 1997 Andreas Dilger

Distributed according to the same disclaimer and license as libpng-0.88, with the following individuals added to the list of Contributing Authors:

John Bowler

Kevin Brace

Sam Bushell

Magnus Holmgren

Greg Roelofs

Tom Tanner

libpng versions 0.5, May 1995, through 0.88, January 1996, are Copyright © 1995, 1996 Guy Eric Schalnat, Group 42, Inc.

For the purposes of this copyright and license, "Contributing Authors" is defined as the following set of individuals:

Andreas Dilger

Dave Martindale

Guy Eric Schalnat

Paul Schmidt

Tim Wegner

The PNG Reference Library is supplied "AS IS". The Contributing Authors and Group 42, Inc. disclaim all warranties, expressed or implied, including, without limitation, the warranties of merchantability and of fitness for any purpose. The Contributing Authors and Group 42, Inc. assume no liability for direct, indirect, incidental, special, exemplary, or consequential damages, which may result from the use of the PNG Reference Library, even if advised of the possibility of such damage.

Permission is hereby granted to use, copy, modify, and distribute this source code, or portions hereof, for any purpose, without fee, subject to the following restrictions:

1. The origin of this source code must not be misrepresented.
2. Altered versions must be plainly marked as such and must not be misrepresented as being the original source.
3. This Copyright notice may not be removed or altered from any source or altered source distribution.

The Contributing Authors and Group 42, Inc. specifically permit, without fee, and encourage the use of this source code as a component to supporting the PNG file format in commercial products. If you use this source code in a product, acknowledgment is not required but would be appreciated.

A "png_get_copyright" function is available, for convenient use in "about" boxes and the like:
`printf("%s",png_get_copyright(NULL));`

Also, the PNG logo (in PNG format, of course) is supplied in the files "pngbar.png" and "pngbar.jpg" (88x31) and "pngnow.png" (98x31).

Libpng is OSI Certified Open Source Software. OSI Certified Open Source is a certification mark of the Open Source Initiative.

Glenn Randers-Pehrson

glennrp at users.sourceforge.net

February 14, 2009

Bzip2

This program, "bzip2", the associated library "libbzip2", and all documentation, are copyright (C) 1996-2007 Julian R Seward. All rights reserved.

Redistribution and use in source and binary forms, with or without modification, are permitted provided that the following conditions are met:

1. Redistributions of source code must retain the above copyright notice, this list of conditions and the following disclaimer.
2. The origin of this software must not be misrepresented; you must not claim that you wrote the original software. If you use this software in a product, an acknowledgment in the product documentation would be appreciated but is not required.
3. Altered source versions must be plainly marked as such, and must not be misrepresented as being the original software.
4. The name of the author may not be used to endorse or promote products derived from this software without specific prior written permission.

THIS SOFTWARE IS PROVIDED BY THE AUTHOR "AS IS" AND ANY EXPRESS OR IMPLIED WARRANTIES, INCLUDING, BUT NOT LIMITED TO, THE IMPLIED WARRANTIES OF MERCHANTABILITY AND FITNESS FOR A PARTICULAR PURPOSE ARE DISCLAIMED. IN NO EVENT SHALL THE AUTHOR BE LIABLE FOR ANY DIRECT, INDIRECT, INCIDENTAL, SPECIAL, EXEMPLARY, OR CONSEQUENTIAL DAMAGES (INCLUDING, BUT NOT LIMITED TO, PROCUREMENT OF SUBSTITUTE GOODS OR SERVICES; LOSS OF USE, DATA, OR PROFITS; OR BUSINESS INTERRUPTION) HOWEVER CAUSED AND ON ANY THEORY OF LIABILITY, WHETHER IN CONTRACT, STRICT LIABILITY, OR TORT (INCLUDING NEGLIGENCE OR OTHERWISE) ARISING IN ANY WAY OUT OF THE USE OF THIS SOFTWARE, EVEN IF ADVISED OF THE POSSIBILITY OF SUCH DAMAGE.

Julian Seward, jseward@bzip.org

USB library functions

Atmel Corporation

2325 Orchard Parkway

San Jose, Ca 95131

Copyright (c) 2004 Atmel

Apache

Apache License
Version 2.0, January 2004
<http://www.apache.org/licenses/>

TERMS AND CONDITIONS FOR USE, REPRODUCTION, AND DISTRIBUTION

1. Definitions.

"License" shall mean the terms and conditions for use, reproduction, and distribution as defined by Sections 1 through 9 of this document.

"Licensor" shall mean the copyright owner or entity authorized by the copyright owner that is granting the License.

"Legal Entity" shall mean the union of the acting entity and all other entities that control, are controlled by, or are under common control with that entity. For the purposes of this definition, "control" means (i) the power, direct or indirect, to cause the direction or management of such entity, whether by contract or otherwise, or (ii) ownership of fifty percent (50%) or more of the outstanding shares, or (iii) beneficial ownership of such entity.

"You" (or "Your") shall mean an individual or Legal Entity exercising permissions granted by this License.

"Source" form shall mean the preferred form for making modifications, including but not limited to software source code, documentation source, and configuration files.

"Object" form shall mean any form resulting from mechanical transformation or translation of a Source form, including but not limited to compiled object code, generated documentation, and conversions to other media types.

"Work" shall mean the work of authorship, whether in Source or Object form, made available under the License, as indicated by a copyright notice that is included in or attached to the work (an example is provided in the Appendix below).

"Derivative Works" shall mean any work, whether in Source or Object form, that is based on (or derived from) the Work and for which the editorial revisions, annotations, elaborations, or other modifications represent, as a whole, an original work of authorship. For the purposes of this License, Derivative Works shall not include works that remain separable from, or merely link (or bind by name) to the interfaces of, the Work and Derivative Works thereof.

"Contribution" shall mean any work of authorship, including the original version of the Work and any modifications or additions to that Work or Derivative Works thereof, that is intentionally submitted to Licensor for inclusion in the Work by the copyright owner or by an individual or Legal Entity authorized to submit on behalf of the copyright owner. For the purposes of this definition, "submitted"

means any form of electronic, verbal, or written communication sent to the Licensor or its representatives, including but not limited to communication on electronic mailing lists, source code control systems, and issue tracking systems that are managed by, or on behalf of, the Licensor for the purpose of discussing and improving the Work, but excluding communication that is conspicuously marked or otherwise designated in writing by the copyright owner as "Not a Contribution."

"Contributor" shall mean Licensor and any individual or Legal Entity on behalf of whom a Contribution has been received by Licensor and subsequently incorporated within the Work.

2. Grant of Copyright License. Subject to the terms and conditions of this License, each Contributor hereby grants to You a perpetual, worldwide, non-exclusive, no-charge, royalty-free, irrevocable copyright license to reproduce, prepare Derivative Works of, publicly display, publicly perform, sublicense, and distribute the Work and such Derivative Works in Source or Object form.
3. Grant of Patent License. Subject to the terms and conditions of this License, each Contributor hereby grants to You a perpetual, worldwide, non-exclusive, no-charge, royalty-free, irrevocable (except as stated in this section) patent license to make, have made, use, offer to sell, sell, import, and otherwise transfer the Work, where such license applies only to those patent claims licensable by such Contributor that are necessarily infringed by their Contribution(s) alone or by combination of their Contribution(s) with the Work to which such Contribution(s) was submitted. If You institute patent litigation against any entity (including a cross-claim or counterclaim in a lawsuit) alleging that the Work or a Contribution incorporated within the Work constitutes direct or contributory patent infringement, then any patent licenses granted to You under this License for that Work shall terminate as of the date such litigation is filed.
4. Redistribution. You may reproduce and distribute copies of the Work or Derivative Works thereof in any medium, with or without modifications, and in Source or Object form, provided that You meet the following conditions:
 - (a) You must give any other recipients of the Work or Derivative Works a copy of this License; and
 - (b) You must cause any modified files to carry prominent notices stating that You changed the files; and
 - (c) You must retain, in the Source form of any Derivative Works that You distribute, all copyright, patent, trademark, and attribution notices from the Source form of the Work, excluding those notices that do not pertain to any part of the Derivative Works; and
 - (d) If the Work includes a "NOTICE" text file as part of its distribution, then any Derivative Works that You distribute must include a readable copy of the attribution notices contained within such NOTICE file, excluding those notices that do not pertain to any part of the Derivative Works, in at least one

of the following places: within a NOTICE text file distributed as part of the Derivative Works; within the Source form or documentation, if provided along with the Derivative Works; or, within a display generated by the Derivative Works, if and wherever such third-party notices normally appear. The contents of the NOTICE file are for informational purposes only and do not modify the License. You may add Your own attribution notices within Derivative Works that You distribute, alongside or as an addendum to the NOTICE text from the Work, provided that such additional attribution notices cannot be construed as modifying the License.

You may add Your own copyright statement to Your modifications and may provide additional or different license terms and conditions for use, reproduction, or distribution of Your modifications, or for any such Derivative Works as a whole, provided Your use, reproduction, and distribution of the Work otherwise complies with the conditions stated in this License.

5. Submission of Contributions. Unless You explicitly state otherwise, any Contribution intentionally submitted for inclusion in the Work by You to the Licensor shall be under the terms and conditions of this License, without any additional terms or conditions. Notwithstanding the above, nothing herein shall supersede or modify the terms of any separate license agreement you may have executed with Licensor regarding such Contributions.
6. Trademarks. This License does not grant permission to use the trade names, trademarks, service marks, or product names of the Licensor, except as required for reasonable and customary use in describing the origin of the Work and reproducing the content of the NOTICE file.
7. Disclaimer of Warranty. Unless required by applicable law or agreed to in writing, Licensor provides the Work (and each Contributor provides its Contributions) on an "AS IS" BASIS, WITHOUT WARRANTIES OR CONDITIONS OF ANY KIND, either express or implied, including, without limitation, any warranties or conditions of TITLE, NON-INFRINGEMENT, MERCHANTABILITY, or FITNESS FOR A PARTICULAR PURPOSE. You are solely responsible for determining the appropriateness of using or redistributing the Work and assume any risks associated with Your exercise of permissions under this License.
8. Limitation of Liability. In no event and under no legal theory, whether in tort (including negligence), contract, or otherwise, unless required by applicable law (such as deliberate and grossly negligent acts) or agreed to in writing, shall any Contributor be liable to You for damages, including any direct, indirect, special, incidental, or consequential damages of any character arising as a result of this License or out of the use or inability to use the Work (including but not limited to damages for loss of goodwill, work stoppage, computer failure or malfunction, or any and all other commercial damages or losses), even if such Contributor has been advised of the possibility of such damages.
9. Accepting Warranty or Additional Liability. While redistributing the Work or Derivative Works thereof, You may choose to offer, and charge a fee for, acceptance of support, warranty, indemnity,

or other liability obligations and/or rights consistent with this License. However, in accepting such obligations, You may act only on Your own behalf and on Your sole responsibility, not on behalf of any other Contributor, and only if You agree to indemnify, defend, and hold each Contributor harmless for any liability incurred by, or claims asserted against, such Contributor by reason of your accepting any such warranty or additional liability.

END OF TERMS AND CONDITIONS

APPENDIX: How to apply the Apache License to your work.

To apply the Apache License to your work, attach the following boilerplate notice, with the fields enclosed by brackets "[]" replaced with your own identifying information. (Don't include the brackets!) The text should be enclosed in the appropriate comment syntax for the file format. We also recommend that a file or class name and description of purpose be included on the same "printed page" as the copyright notice for easier identification within third-party archives.

Copyright [yyyy] [name of copyright owner]

Licensed under the Apache License, Version 2.0 (the "License");
you may not use this file except in compliance with the License.
You may obtain a copy of the License at

<http://www.apache.org/licenses/LICENSE-2.0>

Unless required by applicable law or agreed to in writing, software distributed under the License is distributed on an "AS IS" BASIS, WITHOUT WARRANTIES OR CONDITIONS OF ANY KIND, either express or implied. See the License for the specific language governing permissions and limitations under the License.

D3 JS library

Copyright (c) 2013, Michael Bostock

All rights reserved.

Redistribution and use in source and binary forms, with or without modification, are permitted provided that the following conditions are met:

* Redistributions of source code must retain the above copyright notice, this list of conditions and the following disclaimer.

* Redistributions in binary form must reproduce the above copyright notice, this list of conditions and the following disclaimer in the documentation and/or other materials provided with the distribution.

* The name Michael Bostock may not be used to endorse or promote products derived from this software without specific prior written permission.

THIS SOFTWARE IS PROVIDED BY THE COPYRIGHT HOLDERS AND CONTRIBUTORS "AS IS" AND ANY EXPRESS OR IMPLIED WARRANTIES, INCLUDING, BUT NOT LIMITED TO, THE IMPLIED WARRANTIES OF MERCHANTABILITY AND FITNESS FOR A PARTICULAR PURPOSE ARE DISCLAIMED. IN NO EVENT SHALL MICHAEL BOSTOCK BE LIABLE FOR ANY DIRECT, INDIRECT, INCIDENTAL, SPECIAL, EXEMPLARY, OR CONSEQUENTIAL DAMAGES (INCLUDING, BUT NOT LIMITED TO, PROCUREMENT OF SUBSTITUTE GOODS OR SERVICES; LOSS OF USE, DATA, OR PROFITS; OR BUSINESS INTERRUPTION) HOWEVER CAUSED AND ON ANY THEORY OF LIABILITY, WHETHER IN CONTRACT, STRICT LIABILITY, OR TORT (INCLUDING NEGLIGENCE OR OTHERWISE) ARISING IN ANY WAY OUT OF THE USE OF THIS SOFTWARE, EVEN IF ADVISED OF THE POSSIBILITY OF SUCH DAMAGE.

Compliance with safety standards

This section lists the safety specifications against which the 450 Platform Family has been tested and certified. It also describes how to keep RF exposure within safe limits.

Electrical safety compliance

The 450 Platform Family hardware has been tested for compliance to the electrical safety specifications listed in [Table 87](#).

Table 87 Safety compliance specifications

Region	Specification
USA	UL 60950
Canada	CSA C22.2 No.60950
International	CB certified & certificate to IEC 60950

Electromagnetic compatibility (EMC) compliance

The EMC specification type approvals that have been granted for 450 Platform Family are listed under [Table 88](#).

Table 88 EMC emissions compliance

Region	Specification
USA	FCC Part 15 Class B
Canada	RSS Gen and RSS 210
International	EN 301 489-1 V1.9.2 EN 301 489-17 V2.1.1

Human exposure to radio frequency energy

Relevant standards (USA and EC) applicable when working with RF equipment are:

- ANSI IEEE C95.1-1991, IEEE Standard for Safety Levels with Respect to Human Exposure to Radio Frequency Electromagnetic Fields, 3 kHz to 300 GHz.
- Council recommendation of 12 July 1999 on the limitation of exposure of the general public to electromagnetic fields (0 Hz to 300 GHz) (1999/519/EC) and respective national regulations.

- *Directive 2004/40/EC of the European Parliament and of the Council of 29 April 2004 on the minimum health and safety requirements regarding the exposure of workers to the risks arising from physical agents (electromagnetic fields) (18th individual Directive within the meaning of Article 16(1) of Directive 89/391/EEC).*
- US FCC limits for the general population. See the FCC web site at <http://www.fcc.gov>, and the policies, guidelines, and requirements in Part 1 of Title 47 of the Code of Federal Regulations, as well as the guidelines and suggestions for evaluating compliance in FCC OET Bulletin 65.
- Health Canada limits for the general population. See the Health Canada web site at http://www.hc-sc.gc.ca/ewh-semt/pubs/radiation/99ehd-dhm237/limits-limités_e.html and Safety Code 6.
- EN 50383:2002 to 2010 Basic standard for the calculation and measurement of electromagnetic field strength and SAR related to human exposure from radio base stations and fixed terminal stations for wireless telecommunication systems (110 MHz - 40 GHz).
- BS EN 50385:2002 Product standard to demonstrate the compliances of radio base stations and fixed terminal stations for wireless telecommunication systems with the basic restrictions or the reference levels related to human exposure to radio frequency electromagnetic fields (110 MHz – 40 GHz) – general public.
- ICNIRP (International Commission on Non-Ionizing Radiation Protection) guidelines for the general public. See the ICNIRP web site at <http://www.icnirp.de/> and Guidelines for Limiting Exposure to Time-Varying Electric, Magnetic, and Electromagnetic Fields.

Power density exposure limit

Install the radios for the 450 Platform Family of wireless solutions so as to provide and maintain the minimum separation distances from all persons.

The applicable FCC power density exposure limit for RF energy in the 4.9, 5.4 and 5.8 GHz frequency bands is **10 W/m²** and in 900 MHz frequency band is **6 W/m²**. For more information, see [Human exposure to radio frequency energy](#) on page 4-22.

The applicable ISEDC power density exposure limit for RF energy in unlicensed bands is $0.02619 * (f^{0.6834})$, where f is the lowest frequency of the supported band. For licensed bands, the power density exposure limit is $0.6455 * (f^{0.5})$, where f is the lowest frequency of the supported band.

Calculation of power density

The following calculation is based on the ANSI IEEE C95.1-1991 method, as that provides a worst case analysis. Details of the assessment to EN50383:2002 can be provided, if required.

Peak power density in the far field of a radio frequency point source is calculated as follows:

$$S = \frac{P \cdot G}{4\pi d^2}$$

Where:

Is:

S	power density in W/m ²
P	maximum average transmit power capability of the radio, in W
G	total Tx gain as a factor, converted from dB
d	distance from point source, in m

Rearranging terms to solve for distance yields:

$$d = \sqrt{\frac{P \cdot G}{4\pi \cdot S}}$$

Calculated distances and power compliance margins

[Table 92](#) and [Table 93](#) shows calculated minimum separation distances, recommended distances and resulting margins for each frequency band and antenna combination for the USA and Canada. These are conservative distances that include compliance margins. At these and greater separation distances, the power density from the RF field is below generally accepted limits for the general population.

450 Platform Family ODU adheres to all applicable EIRP limits for transmit power when operating in MIMO mode. Separation distances and compliance margins include compensation for both transmitters.

Explanation of terms used in [Table 92](#) and [Table 93](#):

- P burst – maximum average transmit power during transmit burst (Watt)
- P – maximum average transmit power of the radio (Watt)
- G – total transmit gain as a factor, converted from dB
- S – power density (Watt/m²)
- d – minimum safe separation distance from point source (meters)

Table 89 FCC minimum safe distances – PMP 450m 5.1 GHz, 5.2 GHz, 5.4 GHz and 5.8 GHz

Band (GHz)	Antenna	PG (W)	S (W/ m ²)	d (m)
5.1	90° sector	3.38	10	0.16
5.2	90° sector	0.85	10	0.08
5.4	90° sector	0.85	10	0.08
5.8	90° sector	3.38	10	0.16

Table 90 FCC minimum safe distances – PMP/PTP 450b 4.9 GHz, 5.1 GHz, 5.2 GHz, 5.4 GHz and 5.8 GHz

Band (GHz)	Antenna	P (W)	G (dBi)	S (W/ m ²)	d (m)
4.9	Dish	0.501	24	10	1.00
	Patch Array	0.501	17	10	0.45
	On-board	0.501	0	10	0.06
5.1	Dish	0.501	24	10	1.00
	Patch Array	0.501	17	10	0.45
	On-board	0.501	0	10	0.06
5.2	Dish	0.004	24	10	0.09
	Patch Array	0.020	17	10	0.09
	On-board	0.251	0	10	0.04
5.4	Dish	0.004	24	10	0.09
	Patch Array	0.020	17	10	0.09
	On-board	0.501	0	10	0.06
5.8	Dish	0.501	24	10	1.00
	Patch Array	0.501	17	10	0.45
	On-board	0.501	0	10	0.06

Table 91 ISEDC minimum safe distances – PMP/PTP 450b, 4.9 GHz, 5.1 GHz, 5.2 GHz, 5.4 GHz, and 5.8 GHz

Band (GHz)	Antenna	P (W)	G (dBi)	S (W/ m ²)	d (m)	S @ 20 cm (W/ m ²)
4.9	Dish	0.501	24	8.76	1.07	250.5
	Patch Array	0.501	17	8.76	0.48	50.0
	On-board	0.501	0	8.76	0.07	1.0
5.1	Dish	0.501	24	9.01	1.05	250.5
	Patch Array	0.501	17	9.01	0.47	50.0
	On-board	0.501	0	9.01	0.07	1.0
5.2	Dish	0.004	24	9.13	0.09	2.0
	Patch Array	0.020	17	9.13	0.09	2.0
	On-board	0.251	0	9.13	0.05	0.5
5.4	Dish	0.004	24	9.39	0.09	2.0
	Patch Array	0.020	17	9.39	0.09	2.0
	On-board	0.501	0	9.39	0.07	1.0
5.8	Dish	0.501	24	9.69	1.02	250.5
	Patch Array	0.501	17	9.69	0.45	50.0
	On-board	0.501	0	9.69	0.06	1.0

Table 92 FCC minimum safe distances – PMP/PTP 450i 900 MHz, 3.65 GHz, 4.9 GHz, 5.1 GHz, 5.2 GHz, 5.4 GHz and 5.8 GHz

Band	Antenna	P burst (W)	P (W)	G (dBi)	S (W/ m ²)	d (m)
900 MHz	Sector antenna	-	0.19	22.75 (13 dBi)	6.0	0.27
3.65 GHz	90° sector antenna, integrated	-	0.316	50.0 (17 dBi)	10.0	0.36
	90° sector antenna, connectorized	-	0.316	40.0 (16 dBi)	10.0	0.32
	Panel, integrated	-	0.251	79.0 (19 dBi)	10.0	0.40
4.9 GHz	Omni-directional	0.2138	0.2512	20.0 (13 dBi)	10.0	0.17
	90° sector antenna	0.2138	0.2512	50.0 (17 dBi)	10.0	0.26
	2ft directional flat plate	0.2138	0.2512	631.0 (28 dBi)	10.0	0.93
	4ft directional parabolic	0.851	0.1000	2344.0 (34.9 dBi)	10.0	1.14
	6ft directional parabolic	0.1413	0.1659	5248.0 (37.2 dBi)	10.0	2.19
5.1 GHz	Omni-directional	0.170	0.200	20.0 (13.0 dBi)	10	0.15
	90° sector	0.034	0.040	50.1 (17.0 dBi)	10	0.10
	2ft directional flat plate	0.002	0.002	707.9 (28.5 dBi)	10	0.09
	4ft directional parabolic	0.011	0.013	2818.4 (34.5 dBi)	10	0.44
5.2 GHz	Omni-directional	0.036	0.042	20.0 (13.0 dBi)	10	0.07
	90° sector	0.014	0.017	50.1 (17.0 dBi)	10	0.07
	2ft directional flat plate	0.001	0.001	707.9 (28.5 dBi)	10	0.07
	4ft directional parabolic	0.000	0.000	2818.4 (34.5 dBi)	10	0.06
5.4 GHz	Omni-directional	0.036	0.042	20.0 (13.0 dBi)	10	0.07
	90° sector	0.014	0.017	50.1 (17.0 dBi)	10	0.07
	2ft directional flat plate	0.001	0.001	707.9 (28.5 dBi)	10	0.07
	2ft directional parabolic	0.001	0.001	707.9 (28.5 dBi)	10	0.08
5.8 GHz	Omni-directional	0.24	0.28	20.0 (13 dBi)	10.0	0.18
	90° sector	0.10	0.12	50.0 (17 dBi)	10.0	0.18
	2ft directional flat plate	0.54	0.63	708.0 (28.5 dBi)	10.0	1.57
	4ft directional parabolic	0.54	0.63	3388.0 (35.3 dBi)	10.0	3.43
	6ft directional parabolic	0.54	0.63	6457.0 (38.1 dBi)	10.0	4.74

Table 93 ISED minimum safe distances – PMP/PTP 450i, 900 MHz, 3.5 GHz, 3.65 GHz, 4.9 GHz, 5.2 GHz, 5.4 GHz, and 5.8 GHz

Band	Antenna	P burst (W)	P (W)	G (dBi)	S (W/ m ²)	d (m)
900 MHz	Sector	-	.02	20.0 (13 dBi)	2.74	0.11
	90° sector antenna, integrated	-	0.794	50.0 (17 dBi)	37.10	0.29
3.5 GHz	90° sector antenna, connectorized	-	0.794	40.0 (16 dBi)	37.10	0.23
	Panel, integrated	-	0.794	79.0 (19 dBi)	37.10	0.37
3.65 GHz (Lower Canada)	90° sector antenna, integrated	-	0.794	50.0 (17 dBi)	7.13	0.67
	90° sector antenna, connectorized	-	0.794	40.0 (16 dBi)	7.13	0.59
	Panel, integrated	-	0.794	79.0 (19 dBi)	7.13	0.84
3.65 GHz (Upper Canada)	90° sector antenna, integrated	-	0.316	50.0 (17 dBi)	7.13	0.42
	90° sector antenna, connectorized	-	0.316	40.0 (16 dBi)	7.13	0.37
	Panel, integrated	-	0.251	79.0 (19 dBi)	7.13	0.47
4.9 GHz	Omni-directional	0.214	0.251	20.0 (13 dBi)	8.71	0.20
	90° sector	0.214	0.251	50.1 (17 dBi)	8.71	0.31
	2ft directional flat plate	0.214	0.251	631.0 (28 dBi)	8.71	1.11
	6ft directional parabolic	0.141	0.166	5248.0 (37.2 dBi)	8.71	2.60
5.2 GHz	Omni-directional	0.009	0.011	20.0 (13.0 dBi)	9.13	0.04
	90° sector	0.012	0.014	50.1 (17.0 dBi)	9.13	0.06
	2ft directional flat plate	0.001	0.001	707.9 (28.5 dBi)	9.13	0.07
	2ft directional parabolic	0.001	0.001	707.9 (28.5 dBi)	9.13	0.06

Band	Antenna	P burst (W)	P (W)	G (dBi)	S (W/ m²)	d (m)
5.4 GHz	Omni-directional	0.036	0.042	20.0 (13.0 dBi)	9.39	0.07
	90° sector	0.014	0.017	50.1 (17.0 dBi)	9.39	0.07
	2ft directional flat plate	0.001	0.001	707.9 (28.5 dBi)	9.39	0.07
	2ft directional parabolic	0.001	0.001	707.9 (28.5 dBi)	9.39	0.06
5.8 GHz	Omni-directional	0.24	0.28	20.0 (13 dBi)	9.69	0.20
	90° sector	0.10	0.12	50.1 (17 dBi)	9.69	0.20
	2ft directional flat plate	0.54	0.63	707.9 (28.5 dBi)	9.69	1.67
	4ft directional parabolic	0.54	0.63	3388.4 (35.3 dBi)	9.69	4.82

Table 94 FCC minimum safe distances – PMP/PTP 450 900 MHz, 2.4 GHz, 3.65 GHz and 5 GHz

Band	Antenna	P burst (W)	G (dBi)	S (W/ m ²)	d (m)
900 MHz	Yagi	0.032	13 (11 dBi)	6	0.07
	Sector Antenna	0.079	50 (17 dBi)	10	0.18
2.4 GHz	Integrated	0.158	6 (8 dBi)	10	0.09
	Reflector	0.040	100 (20 dBi)	10	0.18
	Sector Antenna	0.316	32 (15 dBi)	10	0.28
3.65 GHz	Integrated	0.316	6 (8 dBi)	10	0.12
	Reflector	0.25	100 (20 dBi)	10	0.45
	High-gain Ruggedized	0.25	79 (19 dBi)	10	0.40
	Sector	0.025	40 (16 dBi)	10	0.09
5.4 GHz	Integrated	0.126	8 (9 dBi)	10	0.09
	Reflector	0.003	316 (25 dBi)	10	0.09
	CLIP	0.020	50 (17 dBi)	10	0.09
	LENS	0.032	28 (14.5 dBi)	10	0.08
	Integrated Dish (450d)	0.0032	316 (25 dBi)	10	0.09
	Sector	0.079	40 (16 dBi)	10	0.16
5.8 GHz	Integrated	0.158	8 (9 dBi)	10	0.10
	Reflector	0.158	316 (25 dBi)	10	0.63
	CLIP	0.158	50 (17 dBi)	10	0.25
	LENS	0.158	28 (14.5 dBi)	10	0.19
	Integrated Dish (450d)	0.158	316 (25 dBi)	10	0.63

Table 95 ISEDC minimum safe distances – PMP/PTP 450 900 MHz, 2.4 GHz, 3.5/3.65 GHz and 5 GHz

Band	Antenna	P burst (W)	G (dBi)	S (W/ m ²)	d (m)
900 MHz	Yagi	0.316	13 (11 dBi)	2.74	0.35
2.4 GHz	Sector Antenna	0.079	50 (17 dBi)	5.35	0.24
	Integrated	0.158	6 (8 dBi)	5.35	0.12
	Reflector	0.040	100 (20 dBi)	5.35	0.24
3.5 GHz	Sector	0.316	32 (15 dBi)	37.10	0.15
	Integrated	0.316	6 (8 dBi)	37.10	0.06
	Reflector	0.316	100 (20 dBi)	37.10	0.26
	High-gain Ruggedized	0.316	79 (19 dBi)	37.10	0.23
3.65 GHz (lower Canada)	Sector	0.316	32 (15 dBi)	38.20	0.15
	Integrated	0.316	6 (8 dBi)	38.20	0.06
	Reflector	0.316	100 (20 dBi)	38.20	0.26
	High-gain Ruggedized	0.316	79 (19 dBi)	38.20	0.23
3.65 GHz (upper Canada)	Sector	0.316	32 (15 dBi)	38.20	0.14
	Integrated	0.316	6 (8 dBi)	38.20	0.06
	Reflector	0.20	100 (20 dBi)	38.20	0.20
	High-gain Ruggedized	0.003	79 (19 dBi)	38.20	0.23
5.4 GHz	Sector	0.025	40 (16 dBi)	9.39	0.09
	Integrated	0.126	8 (9 dBi)	9.39	0.09
	Reflector	0.003	316 (25 dBi)	9.39	0.09
	CLIP	0.020	50 (17 dBi)	9.39	0.09
	LENS	0.032	28 (14.5 dBi)	9.39	0.09
	Integrated Dish (450d)	0.0032	316 (25 dBi)	9.39	0.09
5.8 GHz	Sector	.079	40 (16 dBi)	9.69	0.16
	Integrated	0.158	8 (9 dBi)	9.69	0.10
	Reflector	0.158	316 (25 dBi)	9.69	0.064
	CLIP	0.158	50 (17 dBi)	9.69	0.25
	LENS	0.158	28 (14.5 dBi)	9.69	0.19
	Integrated Dish (450d)	0.158	316 (25 dBi)	9.69	0.64

- (*1) P: maximum average transmit power capability of the radio including cable loss (Watt)
Capacité de puissance d'émission moyenne maximale de la radio comprenant la perte dans les câble de connexion (W)
- (*2) G: total transmit gain as a factor, converted from dB
Gain total d'émission, converti à partir de la valeur en dB
- (*3) S: power density (W/m^2)
Densité de puissance (W/m^2)
- (*4) d: minimum distance from point source (meters)
Distance minimale de source ponctuelle (en mètres)

**Note**

Gain of antenna in dBi = $10 * \log(G)$.

The regulations require that the power used for the calculations is the maximum power in the transmit burst subject to allowance for source-based time-averaging.

At 5.4 GHz and EU 5.8 GHz, the products are generally limited to a fixed EIRP which can be achieved with the Integrated Antenna. The calculations above assume that the maximum EIRP allowed by the regulations is being transmitted.

**Remarque**

Gain de l'antenne en dBi = $10 * \log(G)$.

Les règlements exigent que la puissance utilisée pour les calculs soit la puissance maximale de la rafale de transmission soumis à une réduction pour prendre en compte le rapport cyclique pour les signaux modulés dans le temps.

Pour une opération dans la CEE dans les bandes 5,4 GHz et 5,8 GHz, les produits sont généralement limités à une PIRE qui peut être atteinte avec l'antenne intégrée. Les calculs ci-dessus supposent que la PIRE maximale autorisée par la réglementation est atteinte.

**Note**

If there are no EIRP limits in the country of deployment, use the distance calculations for FCC 5.8 GHz for all frequency bands.

At FCC 5.8 GHz, for antennas between 0.6m (2ft) and 1.8m (6ft), alter the distance proportionally to the antenna gain.

**Remarque**

Si aucune limite de PIRE existe pour le pays de déploiement, utilisez les calculs de distance pour FCC 5,8 GHz pour toutes les bandes de fréquence.

Pour la band FCC 5,8 GHz et les antennes entre 0,6 m (2 pieds) et 1,8 m (6 pieds), modifier la distance proportionnellement au gain de l'antenne.

Hazardous location compliance

The PMP/PTP 450i series ATEX/HAZLOC ODUs have been certified for operation in the following hazardous locations:

ATEX

The products have been approved under an “Intrinsic Safety” assessment as defined in EN60079-11:2007.

The approval is given by certificate number TRAC09ATEX31224X, issued by TRaC Global, with the specific level of coverage shown below:

- II 3 G Ex ic IIC T4
- II - Equipment group (surface applications)
- 3 - Equipment category (infrequent exposure)

- G - Atmosphere (Gas)
- ic - Protection concept (intrinsic safety)
- IIC - Gas group (up to and including Hydrogen and Acetylene)
- T4 - Temperature class (135°C)

Compliance with radio regulations

This section describes how the 450 Platform Family complies with the radio regulations that are in force in various countries.

**Caution**

Where necessary, the end user is responsible for obtaining any National licenses required to operate this product and these must be obtained before using the product in any country. Contact the appropriate national administrations for details of the conditions of use for the bands in question and any exceptions that might apply.

**Caution**

Changes or modifications not expressly approved by Cambium Networks could void the user's authority to operate the system.

**Caution**

For the connectorized version of the product and in order to reduce potential radio interference to other users, the antenna type and its gain should be so chosen that the Effective Isotropically Radiated Power (EIRP) is not more than that permitted for successful communication.

**Attention**

Le cas échéant, l'utilisateur final est responsable de l'obtention des licences nationales nécessaires pour faire fonctionner ce produit. Celles-ci doivent être obtenus avant d'utiliser le produit dans un pays particulier. Contactez les administrations nationales concernées pour les détails des conditions d'utilisation des bandes en question, et toutes les exceptions qui pourraient s'appliquer

**Attention**

Les changements ou modifications non expressément approuvés par les réseaux de Cambium pourraient annuler l'autorité de l'utilisateur à faire fonctionner le système.

**Attention**

Pour la version du produit avec une antenne externe, et afin de réduire le risque d'interférence avec d'autres utilisateurs, le type d'antenne et son gain doivent être choisis afin que la puissance isotrope rayonnée équivalente (PIRE) ne soit pas supérieure au minimum nécessaire pour établir une liaison de la qualité requise.

Type approvals

This system has achieved Type Approval in various countries around the world. This means that the system has been tested against various local technical regulations and found to comply. The frequency bands in which the system operates may be 'unlicensed' and, in these bands, the system can be used provided it does not cause interference. The system is not guaranteed protection against interference from other products and installations.

The radio specification type approvals that have been granted for 450 Platform Family frequency variants are listed under [Table 96](#).

Table 96 Radio certifications

Region/Country	Band	Specification
Brazil	4.9 GHz	ANATEL, RESOLUÇÃO N° 633, DE 14 DE MARÇO DE 2014
	5.4 GHz	ANATEL, RESOLUTION No. 506, FROM JULY 1, 2008
	5.8 GHz	ANATEL, RESOLUTION No. 506, FROM JULY 1, 2008
Mexico	900 MHz	NOM-121-SCT1-2009
	4.9 GHz	Protocol Between the UNITED STATES OF AMERICA and MEXICO – Use of 4940 to 4990 MHz band.
	5.4 GHz	Acuerdo del 27 de noviembre de 2012
	5.8 GHz	NOM-121-SCT1-2009
USA	900 MHz	FCC Part 15.247
	2.4 GHz	FCC Part 15 Class B
	3.6 GHz	FCC Part 15 Class B
	4.9 GHz	FCC 47 CFR Part 90
	5.1 GHz	FCC 47 CFR Part 15 E
	5.2 GHz	FCC 47 CFR Part 15 E
	5.4 GHz	FCC 47 CFR Part 15 E
	5.8 GHz	FCC 47 CFR Part 15 C
Canada	900 MHz	RSS Gen and RSS 210
	2.4 GHz	RSS Gen and RSS 210
	3.5 /3.6 GHz	RSS Gen and RSS 192
	4.9 GHz	IC RSS-111, Issue 5
	5.8 GHz	IC RSS-247, Issue 1
Europe	3.5 GHz	ETSI EN 302 326-2 V1.2.2

4.9 GHz	ETSI EN302 625; V1.1.1 Broadband Disaster Relief
5.4 GHz	ETSI EN 301 893 V1.8.1
5.8 GHz	ETSI EN 302 502 V2.1.1

Brazil specific information

Brazil notification

For compliant operation in the 5.4 GHz band, the Equivalent Isotropic Radiated Power from the integrated antenna or connectorized antenna shall not exceed 30 dBm (0.5 W).

The operator is responsible for enabling the DFS feature on any Canopy 5.4 GHz radio by setting the Country Code to “Brazil”, including after the module is reset to factory defaults.

Important Note: This equipment operates as a secondary application, so it has no rights against harmful interference, even if generated by similar equipment, and cannot cause harmful interference on systems operating as primary applications.

Brazil certification numbers

The Anatel certification number for Brazil for the PMP/PTP 450i Series is 2426-15-7745.

Australia Notification

900 MHz modules must be set to transmit and receive only on center channels of 920, 922, or 923 MHz to stay within the ACMA approved band of 915 MHz to 928 MHz for the class license and not interfere with other approved users.

After considering antenna gain (in dBi), 900 MHz modules’ transmitter output power (in dBm) must be set to stay within the legal regulatory limit of 30 dBm (1 W) EIRP for this 900 MHz frequency band.

Regulatory Requirements for CEPT Member States (www.cept.org)

When operated in accordance with the instructions for use, Cambium Wireless equipment operating in the 5.1 GHz and 5.4 GHz bands is compliant with CEPT Resolution 229 (REV. WRC-12). Operating the 450 Platform Family in the bands 5150 to 5350 MHz and 5470 to 5725 MHz is granted providing it is not causing interference to the existing primary services allocated to those bands. For compliant operation in the 5250 to 5350 MHz band, the transmit power from the integrated antenna or a connectorized antenna shall be limited to a maximum mean EIRP of 200 mW and a maximum mean EIRP density of 10 mW/MHz in any 1 MHz band.

For compliant operation in the 5470 to 5725 MHz band, the transmit power shall be restricted to a maximum of 250 mW with a maximum mean EIRP of 1 W and a maximum mean EIRP density of 50 mW/MHz in any 1 MHz band.

For compliant operation in the bands 5 250-5 350 MHz and 5 470-5 725 MHz, the 450 Platform Family employs transmitter power control.

For EU member states, RLAN equipment in the 5.4GHz bands is exempt from individual licensing under Commission Recommendation 2003/203/EC. Contact the appropriate national administrations for details on the conditions of use for the bands in question and any exceptions that might apply. Also see www.ero.dk for further information.

Cambium Radio equipment operating in the 5470 to 5725 MHz band are categorized as “Class 1”

devices within the EU in accordance with ECC DEC(04)08 and are “CE” marked  to show compliance with the European Radio & Telecommunications Terminal Equipment (R&TTE) directive 1999/5/EC. The relevant Declaration of Conformity can be found at

http://www.cambiumnetworks.com/support/ec_doc/.

A European Commission decision, implemented by Member States on 31 October 2005, makes the frequency band 5470-5725 MHz available in all EU Member States for wireless access systems. Under this decision, the designation of Canopy 5.4GHz products become “Class 1 devices” and these do not require notification under article 6, section 4 of the R&TTE Directive. Consequently, these 5.4GHz products are only marked with the  symbol and may be used in any member state.

Chapter 5: Preparing for installation

This chapter describes how to stage and test the hardware for a 450 Platform network. This chapter is arranged as follows:

- [Safety](#) on page 5-2: Describes the precautions to be observed and checks to be performed before proceeding with the installation
- [Preparing for installation](#) on page 5-6: Describes the pre-configuration procedure before proceeding with installation.
- [Testing system components](#) on page 5-8: Describes the procedures for unpacking and performing and initial staging of the 450 Platform Family ODU.
- [Configuring Link for Test](#) on page 5-17: Describes the procedures for testing the equipment's radio links.

Safety

**Warning**

To prevent loss of life or physical injury, observe the following safety guidelines. In no event shall Cambium Networks be liable for any injury or damage caused during the installation of the Cambium 450 Platform Family. Ensure that only qualified personnel install a 450 Platform link.

Hazardous locations

**Warning**

When installing the PMP/PTP 450i ATEX/HAZLOC product variants in hazardous locations, follow the instructions contained in the PMP/PTP 450i Series Hazardous Location Guide (supplied in box with the products), in addition to the instructions in this user guide.

Power lines

Exercise extreme care when working near power lines.

Working at heights

Exercise extreme care when working at heights.

Power supply

Always use one of the Cambium 450 Platform Family power supply units (PSU) to power the ODU. Failure to use a Cambium supplied PoE could result in equipment damage and will invalidate the safety certification and may cause a safety hazard.

Grounding and protective earth

The Outdoor Unit (ODU) must be properly grounded to protect against lightning. It is the user's responsibility to install the equipment in accordance with national regulations. In the USA follow the requirements of the National Electrical code NFPA 70-2005 and 780-2004 *Installation of Lightning Protection Systems*. In Canada, follow Section 54 of the *Canadian Electrical Code*. These codes describe correct installation procedures for grounding the outdoor unit, mast, lead-in wire and discharge unit, size of grounding conductors and connection requirements for grounding electrodes. Other regulations may apply in different countries and therefore it is recommended that installation of the outdoor unit be contracted to a professional installer.

Powering down before servicing

Always power down and unplug the equipment before servicing.

Primary disconnect device

The ODU power supply is the primary disconnect device.

External cables

Safety may be compromised if outdoor rated cables are not used for connections that will be exposed to the outdoor environment. For outdoor copper Cat5e Ethernet interfaces, always use Cat5e cable that is gel-filled and shielded with copper-plated steel.

RF exposure near the antenna

Strong radio frequency (RF) fields will be present close to the antenna when the transmitter is on. Always turn off the power to the ODU before undertaking maintenance activities in front of the antenna.

Minimum separation distances

Ensure that personnel are not exposed to unsafe levels of RF energy. The units start to radiate RF energy as soon as they are powered up. Never work in front of the antenna when the ODU is powered. Install the ODUs so as to provide and maintain the minimum separation distances from all persons. For minimum separation distances, see [Calculated distances and power compliance margins](#) on page 4-24.

Grounding and lightning protection requirements

Ensure that the installation meets the requirements defined in [Grounding and lightning protection](#) on page 3-8.

Grounding cable installation methods

To provide effective protection against lightning induced surges, observe these requirements:

- Grounding conductor runs are as short, straight and smooth as possible, with bends and curves kept to a minimum.
- Grounding cables must not be installed with drip loops.
- All bends must have a minimum radius of 200 mm (8 in) and a minimum angle of 90°. A diagonal run is preferable to a bend, even though it does not follow the contour or run parallel to the supporting structure.
- All bends, curves and connections must be routed towards the grounding electrode system, ground rod, or ground bar.
- Grounding conductors must be securely fastened.
- Braided grounding conductors must not be used.
- Approved bonding techniques must be used for the connection of dissimilar metals.

Siting ODUs and antennas

ODUs, external antennas and GPS receivers are not designed to survive direct lightning strikes. For this reason they must be installed in Zone B as defined in [Lightning protection zones](#) on page 3-9. Mounting in Zone A may put equipment, structures and life at risk.

Thermal Safety

The ODU enclosure may be hot to the touch when in operation. The ODU must not be operated in ambient temperatures exceeding 40°C unless mounted in a Restricted Access Location. For more information, see [ODU ambient temperature limits](#) on page 3-10.



Warning

Do not install the ODU in a location where the ambient temperature could exceed 40°C unless this is a Restricted Access Location as defined by EN 60950-1.

**Alerte**

L'unité externe ne doit pas être installée dans un endroit où la température ambiante est supérieure à 40C à moins que l'accès soit limité au personnel autorisé.

Preparing for installation

ODU pre-configuration

It is common practice to pre-configure the units during staging before site installation by performing the following tasks:

- [Connecting to the unit](#)
- [Configuring IP and Ethernet interfaces](#)
- [Upgrading the software version and using CNUT](#)
- [General configuration](#)
- [Configuring security](#)
- [Configuring radio parameters](#)
- [Setting up SNMP agent](#)
- [Configuring syslog](#)
- [Configuring remote access](#)
- [Monitoring the Link](#)
- [Configuring quality of service](#)
- [Zero Touch Configuration Using DHCP Option 66](#)
- [Configuring Radio via config file](#)
- [Configuring a RADIUS server](#)

If the units are to be pre-configured during staging, the safety precautions below **MUST** be observed.

Preparing personnel

In no event shall Cambium Networks be liable for any injury or damage caused during the installation of the Cambium 450 Platform Family ODU.

Ensure that only qualified personnel undertake the installation of a 450 Platform system.

Ensure that all safety precautions are observed.

Preparing inventory

Perform the following inventory checks:

- Check that the correct components are available, as described in [Ordering the components](#) on page 2-62.
- Check the contents of all packages against their packing lists.

Preparing tools

Check that following specific tools are available, in addition to general tools:

- RJ45 crimp tool (it must be the correct tool for the type of RJ45 being used).
- Personal Computer (PC) with 10 or 100 or 1000 BaseT Ethernet port
- Web browser
- Ethernet patch cables

Testing system components

The best practice is to connect all components—AP/BHM, SMs/BHS, GPS antenna (if applicable) and CMM (if applicable)—in a test setting and initially configure and verify them before deploying them to an installation. In this way, any configuration issues are worked out before going on-site, on a tower, in the weather, where the discovery of configuration issues or marginal hardware is more problematic and work-flow affecting.

Unpacking Components

When a delivery arrives, inspect all packages immediately for damages.

Carefully unpack the equipment, verify that all the components have arrived as per order and are in good condition. Save all packaging materials for equipment transportation to the installation site.

Preparing the ODU

After the equipment is unpacked, the units may be configured for staging tests.

Use either of two methods to configure an AP/BHM:

- Use the Quick Start feature of the product (via GUI menu **Quick Start**)
- Manually set each parameter

After changing configuration parameters on a GUI web page:

- Before you leave a web page, click the **Save** button to save the change(s)
- After making change(s) on multiple web pages, click the **Reboot** button to reboot the module and implement the change(s)

Configuring the Computing Device for Test

If the computer is configured for Dynamic Host Configuration Protocol (DHCP), disconnect the computer from the network. If the computer is instead configured for static IP addressing

- Set the static address in the 169.254 network
- Set the subnet mask to 255.255.0.0.

For detailed instructions, see section [Configuring the management PC](#) on page 5-17.

Factory default Configuration

From the factory, the APs/BHMs and SMs/BHSs are all configured to *not transmit* on any frequency. This configuration ensures that equipment operators do not accidentally turn on an unsynchronized module. Site synchronization of modules is required because

- modules:
 - cannot transmit and receive signals at the same time.
 - use TDD (Time Division Duplexing) to distribute signal access of the downlink and uplink frames.
- when one module transmits while an unintended module nearby receives signal, the transmitting module may interfere with or desense the receiving module. In this context, interference is self-interference (within the same network).

ODU interfaces

See section [450 Platform Family interfaces](#) on page 2-7

ODU diagnostic LEDs

See section [AP/BHM LEDs](#) on page 2-16.

See section [SM/BHS LEDs](#) on page 2-18.

Recommended Tools for Installation

The following tools may be needed for installation:

Table 97 Tools for PMP and PTP 450 Platform ODU installation

Equipment to Be Installed	Tools Required
AP or BHM	<ul style="list-style-type: none"> • 3 mm Allen Wrench Used for connecting the antenna mating bracket to the rear of the AP housing • Crescent Wrench Pair Used for tightening cable glands • Self-amalgamating and PVC Tape Used for weatherproofing N-type connections

Equipment to Be Installed	Tools Required
AP or BHM or BHS Antenna	<ul style="list-style-type: none"> • 13 mm Spanner Wrench (or Ratchet Spanner Wrench) Pair Used for connecting the antenna (sector or omni for AP, or directional for BH)base to the pole/mast mounting bracket • Self-amalgamating and PVC Tape Used for weatherproofing N-type connections • N-type Torque Wrench (not required but recommended) Used for assuring proper tightening of N-type connectors terminating the RF cables
SM	<ul style="list-style-type: none"> • Wrench/driver (depending on operator's choice of clamps) Used for tightening clamps to the pole • Alignment tone adapter / headset Used for aligning the SM to the AP
Universal Global Positioning System	<ul style="list-style-type: none"> • Philips Screwdriver Used for attaching the UGPS unit to the pole/mast mounting bracket • 13mm Spanner Wrench (or Ratchet Spanner Wrench) Used for connecting the mounting bracket's U-bolt to the antenna or mast
Cabling	<ul style="list-style-type: none"> • Electrician's Scissors or Wire Cutters Used for cutting wire to length • RJ-11/RJ-45 Crimping Tool Used for stripping RJ-11/RJ-45 cables and for terminating cable ends • Cable Testing Device Used to ensure that cables are properly constructed

Standards for Wiring

Modules automatically sense whether the Ethernet cable in a connection is wired as straight-through or crossover. Operators may use either straight-through or crossover cable to connect a network interface card (NIC), hub, router, or switch to these modules. This guide follows the EIA/TIA-568B colour code standard.

Best Practices for Cabling

The following practices are essential to the reliability and longevity of cabled connections:

- Use only shielded cables to resist interference.
- For vertical runs, provide cable support and strain relief.
- Include a 2-ft (0.6-m) service loop on each end of the cable to allow for thermal expansion and contraction and to facilitate terminating the cable again when needed.
- Include a drip loop to shed water so that most of the water does not reach the connector at the device.
- Properly crimp all connectors.
- Use dielectric grease on all connectors to resist corrosion.
- Use only shielded connectors to resist interference and corrosion.

Wiring Connectors

The following diagrams correlate pins to wire colors and illustrate crossovers where applicable.

Pin 1, relative to the lock tab on the connector of a straight-through cable is located as shown below.

Figure 68 Pin 1 location

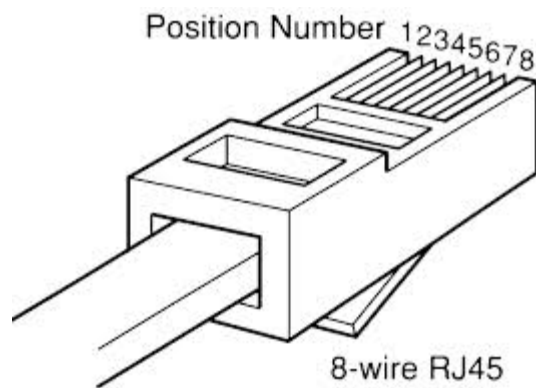

Main port pinout

Table 98 Main port pinout

RJ45 pin	Description
1	+TxRx0
2	-TxRx0
3	+TxRx1
4	+TxRx2
5	-TxRx2
6	-TxRx1
7	+TxRx3
8	-TxRx3

Aux port pinout

Table 99 Aux port pinout

RJ45 pin	Description
1	+TxRx0
2	-TxRx0
3	+TxRx1
4	GPS power out, Alignment tone out, GPS data out
5	GPS data in
6	-TxRx1
7	GPS 0v
8	GPS Sync in

RJ-45 Pinout for Straight-through Ethernet Cable

Figure 69 Straight-through Ethernet Cable

Table 100 RJ-45 pinout for straight-through Ethernet cable

Pin	Signal	Pair	Color
1	TP1+	2	White/orange stripe
2	TP1-	2	Orange solid
3	TP2+	3	White/green stripe
4	TP3+	1	Blue solid
5	TP3-	1	White/blue stripe
6	TP2-	3	Green solid
7	TP4+	4	White/brown stripe
8	TP4-	4	Brown solid

RJ-45 Pinout for Crossover Ethernet Cable

Figure 70 Crossover Ethernet Cable

