

USER GUIDE

cnRanger

System Release 2.1



Accuracy

While reasonable efforts have been made to assure the accuracy of this document, Cambium Networks assumes no liability resulting from any inaccuracies or omissions in this document, or from use of the information obtained herein. Cambium reserves the right to make changes to any products described herein to improve reliability, function, or design, and reserves the right to revise this document and to make changes from time to time in content hereof with no obligation to notify any person of revisions or changes. Cambium does not assume any liability arising out of the application or use of any product, software, or circuit described herein; neither does it convey license under its patent rights or the rights of others. It is possible that this publication may contain references to, or information about Cambium products (machines and programs), programming, or services that are not announced in your country. Such references or information must not be construed to mean that Cambium intends to announce such Cambium products, programming, or services in your country.

Copyrights

This document, Cambium products, and 3rd Party software products described in this document may include or describe copyrighted Cambium and other 3rd Party supplied computer programs stored in semiconductor memories or other media. Laws in the United States and other countries preserve for Cambium, its licensors, and other 3rd Party supplied software certain exclusive rights for copyrighted material, including the exclusive right to copy, reproduce in any form, distribute and make derivative works of the copyrighted material. Accordingly, any copyrighted material of Cambium, its licensors, or the 3rd Party software supplied material contained in the Cambium products described in this document may not be copied, reproduced, reverse engineered, distributed, merged or modified in any manner without the express written permission of Cambium. Furthermore, the purchase of Cambium products shall not be deemed to grant either directly or by implication, estoppel, or otherwise, any license under the copyrights, patents or patent applications of Cambium or other 3rd Party supplied software, except for the normal non-exclusive, royalty free license to use that arises by operation of law in the sale of a product.

Restrictions

Software and documentation are copyrighted materials. Making unauthorized copies is prohibited by law. No part of the software or documentation may be reproduced, transmitted, transcribed, stored in a retrieval system, or translated into any language or computer language, in any form or by any means, without prior written permission of Cambium.

License Agreements

The software described in this document is the property of Cambium and its licensors. It is furnished by express license agreement only and may be used only in accordance with the terms of such an agreement.

High Risk Materials

Cambium and its supplier(s) specifically disclaim any express or implied warranty of fitness for any high-risk activities or uses of its products including, but not limited to, the operation of nuclear facilities, aircraft navigation or aircraft communication systems, air traffic control, life support, or weapons systems (“High Risk Use”).

This product is not restricted in the EU. Any High Risk is unauthorized, is made at your own risk and you shall be responsible for any and all losses, damage or claims arising out of any High-Risk Use.

© 2021 Cambium Networks Limited. All rights reserved

Contents

Contents	3
About this User Guide	11
Purpose	11
Cross references	11
Feedback	11
Important Regulatory Information	12
Application software	12
USA specific information	12
External antennas	12
Canada specific information	12
Renseignements spécifiques au Canada	13
ISED approved antennas	13
Antennas externes	13
Antennes approuvées par ISED	13
EU Declaration of Conformity	13
Specific expertise and training for professional installers	13
Ethernet networking skills	14
Lightning protection	14
Training	14
Problems and Warranty	15
Reporting problems	15
Repair and service	15
Hardware warranty	15
Security advice	15
Warnings, cautions, and notes	15
Warnings	16
Cautions	16
Notes	16
Caring for the environment	16
In EU countries	16
Disposal of Cambium equipment	16

Disposal of surplus packaging	16
In non-EU countries	17
Chapter 1: Product Description	18
cnRanger family overview	18
Features	18
cnRanger 800 BBU	18
2 GHz cnRanger 220 Remote Radio Head (RRH)	18
3 GHz cnRanger 210 RRH	18
2 GHz cnRanger 101 SM	19
2 GHz cnRanger 201 SM	19
3 GHz cnRanger 201 SM	19
System management	19
Management agent	19
Web server	20
Network Time Protocol (NTP)	20
cnMaestro™	20
Device recovery mode	20
Chapter 2: System Hardware	21
System components	21
cnRanger 800 BBU hardware overview	21
Hardware platform variants	21
Region support	21
Interfaces	22
cnRanger 800 BBU LED details	23
Accessories	23
Specifications	24
2 GHz cnRanger 220 RRH hardware overview	24
3 GHz cnRanger 210 RRH hardware overview	25
Interfaces	25
2 GHz/3 GHz cnRanger RRH LED details	26
Hardware platform variants	28
Accessories	28

Specifications	28
cnRanger 101 SM hardware overview	29
Interfaces	29
cnRanger 101 SM LED details	30
Variants	32
Accessories	32
Specifications	32
cnRanger 201 SM hardware overview	32
Power supply units	35
Safety precautions	35
cnRanger 800 BBU and 2 GHz/3 GHz cnRanger RRH PSU	37
PSU description	37
AC power injector interfaces	37
PSU part numbers	37
PSU specifications	38
Subscriber Module premises equipment power supply unit (SM PSU)	38
AC Power Injector interfaces	38
Interfaces	39
PSU part numbers	39
PSU specifications	39
Antennas	40
2 GHz cnRanger 220 RRH Antenna description	40
3 GHz cnRanger 210 RRH Antenna description	40
RF cable and connectors	40
RRH antenna accessories	40
2 GHz cnRanger 220 RRH Antenna part numbers	41
3 GHz cnRanger 210 RRH Antenna part numbers	41
Cabling	41
cnRanger 800 BBU cabling	41
2 GHz/3 GHz cnRanger RRH cabling	42
SFP/SFP+ module kits	42
Optical cables and connectors	43

Lightning protection and grounding kit	44
DC LPU	44
Chapter 3: System Planning	45
Site planning	45
Grounding and lightning protection	45
Lightning protection zones	45
Site grounding system	46
ODU and external antenna location	46
Drop cable grounding points	47
Radio configuration	47
Downlink data and SSF	47
Downlink data, SSF, and co-existence	48
Controlling cnRanger 101 SM cell selection	49
Link planning	49
Path loss	49
Calculating link loss	50
Calculating Rx signal level	51
Calculating fade margin	51
Data network planning	51
IP mode	51
cnRanger 800 BBU network	52
cnRanger 800 BBU router configuration	53
cnRanger 800 BBU proxy ARP configuration	53
Network management planning	55
cnMaestro	55
Security planning	55
Access management	56
SIM credentials	56
Claiming SIM cards	56
SIM credentials file cnMaestro download	57
SIM credential cnRanger 800 BBU upload	58
Chapter 4: Legal and Regulatory Information	60

Compliance standards	60
cnRanger regulatory compliance	60
Federal Communication Commission Interference Statement	61
Human exposure to radio frequency energy	61
Standards	61
Power density exposure limit	62
Calculation of power density	62
Calculated distances and power compliance margins	63
Compliance with radio regulations	63
Notifications	64
2.5 GHz regulatory compliance	64
2.5 GHz FCC notification	65
Chapter 5: Installation	67
Safety	67
Hazardous locations	68
Power lines	68
Working at heights	68
Power supply	68
Grounding and protective earth	68
Powering down before servicing	69
Primary disconnect device	69
External cables	69
Laser safety while using optical SFP modules	69
RF exposure near the antenna	69
Minimum separation distances	69
Grounding and lightning protection requirements	69
Grounding cable installation methods	69
Siting ODUs and antennas	70
Thermal safety	70
Installing cnRanger 800 BBU	70
Mounting	70
Powering up	71

Installing 2 GHz cnRanger 220 RRH	71
Mounting to 2LTE-ANT-90	71
Installing 3 GHz cnRanger 210 RRH	75
Mounting to 3LTE-ANT-90	75
Mounting 2 GHz cnRanger 220 RRH on the pole	79
Powering up	83
Connecting 2 GHz cnRanger 220 RRH power cable to junction box	84
Connecting junction box to 2 GHz cnRanger 220 RRH	85
Installing cnRanger 101 SM	86
Mounting	86
Installing cnRanger 201 SM	87
Powering up	91
Installing SFP/SFP+ modules on BBU	92
Inserting SFP+ module	92
Removing SFP+ module	92
Installing SFP+ modules on 2 GHz cnRanger 220 RRH	93
Installing a GPS antenna on the cnRanger 800 BBU	95
Supported GPS antennas	95
Installing PSU for cnRanger 800 BBU and 2 GHz cnRanger 220 RRH	97
Installing PSU for cnRanger 101 SM	98
Chapter 6: Configuration	100
Management PC network configuration	100
Connecting PC to cnRanger device and powering up	100
cnRanger 800 BBU	100
cnRanger 101 SM	100
Using the web interface	100
cnRanger 800 BBU setup	102
General configuration	102
Radio configuration	103
Network configuration	104
cnMaestro configuration	106
SIM credentials configuration	107

Import/Export configuration	108
Debug configuration	108
CBRS	109
2 GHz/3 GHz cnRanger SM setup	111
General configuration	111
Network configuration	111
Radio configuration	113
Scan results	113
cnMaestro configuration	114
Import/Export configuration	115
Port Mapping configuration	116
CBRS	116
Chapter 7: Tools	119
Common tools	119
Software upgrade	119
cnRanger 101 SM	120
Alignment Tool	120
Technical Support	120
System	120
Chapter 8: Operation	122
System statistics	122
cnRanger 800 BBU	122
Dashboard	122
2 GHz cnRanger 220 RRH	124
SMs	125
GPS	126
Health	126
Process Monitor	127
cnRanger 101 SM	127
Dashboard	127
cnRanger 201 SM	128
Dashboard	128

Wired clients	128
Port Mapping	129
Interface Statistics	129
CBRS	130
Software upgrade	130
Device recovery	130
cnRanger 800 BBU	130
cnRanger 101 SM	130
CBRS	131
Chapter 9: Reference Information	132
Equipment specifications	132
cnRanger 800 BBU specification	132
2 GHz cnRanger 220 RRH specification	134
3 GHz cnRanger 210 RRH specification	135
cnRanger 101 SM Specification	136
2 GHz cnRanger 201 SM Specification	138
3 GHz cnRanger 201 SM Specification	140
Equipment disposal	142
Waste (Disposal) of electronic and electric equipment	142
3GPP band information	142
FCC specific power specification	142
ETSI specification	142
Chapter 10: Glossary	143
Cambium Networks	147

About this User Guide

This guide describes the planning, installation, configuration and operation of the Cambium Networks cnRanger series. It is intended for use by the system designer, system installer, and system administrator.

For radio network design, refer to the following chapters:

- [Product Description](#)
- [System Hardware](#)
- [System Planning](#)
- [Legal and Regulatory Information](#)
- [Installation](#)

For system configuration, tools, and troubleshooting, refer to the following chapters:

- [Configuration](#)
- [Tools](#)
- [Operation](#)
- [Reference Information](#)

Purpose

Cambium Networks cnRanger documents are intended to instruct and assist personnel in the operation, installation and maintenance of the cnRanger equipment and ancillary devices of cnRanger family. It is recommended that all personnel engaged in such activities be properly trained.

Cambium Networks disclaims all liability whatsoever, implied or express, for any risk of damage, loss or reduction in system performance arising directly or indirectly out of the failure of the customer, or anyone acting on the customer's behalf, to abide by the instructions, system parameters, or recommendations made in this document.

Cross references

References to external publications are highlighted. Other cross references, emphasized in blue text in electronic versions, are active links to the references.

This document is divided into numbered chapters that are divided into sections. Sections are not numbered but are individually named at the top of each page and are listed in the table of contents.

Feedback

We appreciate feedback from the users of our documents. This includes feedback on the structure, content, accuracy, or completeness of our documents. To provide feedback, visit our support website <https://support.cambiumnetworks.com>.

Important Regulatory Information

cnRanger family (2 GHz/3 GHz cnRanger RRH and 2 GHz/3 GHz cnRanger SM) operates in license frequency bands, where it is not allowed to cause the interference with other systems.

Application software

Download the latest cnRanger family software and install it in the units before deploying the equipment. Instructions for installing the software are provided in [Installation](#).

USA specific information



Caution

This device complies with Part 15 of the FCC Rules. Operation is subject to the following two conditions:

- This device may not cause harmful interference.
- This device must accept any interference received, including interference that may cause undesired operation.

Manufacturers must ensure that such radio products cannot be configured to operate outside of FCC rules.

Cambium Networks supplies variants of the cnRanger series specifically for operation in the USA to comply with. These variants are only allowed to operate with license keys that comply with FCC rules.

External antennas

When using a connectorized version of the product, the conducted transmit power needs to be reduced to ensure the regulatory limit on transmitter Effective Isotropic Radiated Power (EIRP) is not exceeded. The installer must have an understanding of how to compute the effective antenna gain from the actual antenna gain and the feeder cable losses.

The range of permissible values for maximum antenna gain and feeder cable losses are included in this User Guide together with a sample calculation. The product GUI automatically applies the correct conducted power limit to ensure that it is not possible for the installation to exceed the EIRP limit when the appropriate values for antenna gain and feeder cable losses are entered into the GUI.

Canada specific information



Caution

This device complies with ISED's license-exempt RSSs. Operation is subject to the following two conditions:

- This device may not cause harmful interference; and
- This device must accept any interference, including interference that may cause undesired operation of the device.

Manufacturers must ensure that such radio products cannot be configured to operate outside of ISED rules.

In order to comply with these ISED requirements, Cambium supplies variants of the cnRanger family for operation in Canada. These variants are only allowed to operate with license keys that comply with ISED rules.

Other variants of the cnRanger family are available for use in the rest of the world, but these variants are not supplied to Canada except under strict controls, when they are needed for export and deployment outside Canada.

Renseignements spécifiques au Canada



Attention

Le présent appareil est conforme aux CNR d'Industrie Canada applicables aux appareils radio exempts de licence. L'exploitation est autorisée aux deux conditions suivantes:

- l'appareil ne doit pas produire de brouillage, et
- l'utilisateur de l'appareil doit accepter tout brouillage radioélectrique subi, même si le brouillage est susceptible d'en compromettre le fonctionnement.

Les fabricants doivent s'assurer que les produits de radiocommunications ne peuvent pas être configurés pour fonctionner en dehors des règles ISEDC.

Afin de se conformer à ces exigences de ISEDC, Cambium fournit des variantes du cnRanger Family exclusivement pour le Canada. Ces variantes ne permettent pas à l'équipement de fonctionner en dehors des règles de ISEDC.

ISEDC approved antennas

The list of antennas used to obtain ISEDC approvals is provided in section [Country specific radio regulations](#).

Antennas externes

Lorsque vous utilisez une version du produit sans antenne intégrée, il peut être nécessaire de réduire la puissance d'émission pour garantir que la limite réglementaire de puissance isotrope rayonnée équivalente (PIRE) n'est pas dépassée. L'installateur doit avoir une bonne compréhension de la façon de calculer le gain de l'antenne réelle et les pertes dans les câbles de connections.

La plage de valeurs admissibles pour un gain maximal de l'antenne et des pertes de câbles de connections sont inclus dans ce guide d'utilisation avec un exemple de calcul. L'interface utilisateur du produit applique automatiquement la limite de puissance menée correct afin de s'assurer qu'il ne soit pas possible pour l'installation de dépasser la limite PIRE, lorsque les valeurs appropriées pour le gain d'antenne et les pertes de câbles d'alimentation sont entrées dans l'interface utilisateur.

Antennes approuvées par ISEDC

La liste des antennes approuvées pour l'opération au Canada est fournie dans le chapitre Equipment specifications.

EU Declaration of Conformity

Hereby, Cambium Networks declares that the cnRanger Series complies with the essential requirements and other relevant provisions of Radio Equipment Directive 2014/53/EU. The declaration of conformity may be consulted at:

https://www.cambiumnetworks.com/eu_dofc

Specific expertise and training for professional installers

To ensure that the cnRanger family products are installed and configured in compliance with the requirements of ISEDC and the FCC, installers must have the radio engineering skills and training described

in this section.

The Cambium Networks technical training program details can be accessed from below link:

<https://www.cambiumnetworks.com/training/>

Ethernet networking skills

The installer must have the ability to configure IP addressing on a PC and to set up and control products using a web browser interface.

Lightning protection

To protect outdoor radio installations from the impact of lightning strikes, the installer must be familiar with the normal procedures for site selection, bonding and grounding. Installation guidelines for the cnRanger family can be found in [System hardware](#) and [System planning](#).

Training

The installer needs to have basic competence in radio and IP network installation. The specific requirements applicable to cnRanger series should be gained by reading [Installation](#), [Configuration](#), [Tools](#), and [Operation](#) and by performing sample set ups at base workshop before live deployments.

The Cambium Networks technical training program details can be accessed from below link:

<https://www.cambiumnetworks.com/training/>

Problems and Warranty

Reporting problems

If any problems are encountered when installing or operating this equipment, follow the below procedure to investigate and report:

1. Search this document and the software Release Notes of supported releases.
2. Visit the Support website.
3. Ask for assistance from the Cambium Networks product supplier.
4. Gather information from affected units, such as any available diagnostic downloads.
5. Escalate the problem by emailing or telephoning support.

Repair and service

If unit failure is suspected, obtain details of the Return Material Authorization (RMA) process from the support website (<http://www.cambiumnetworks.com/support>).

Hardware warranty

Cambium Networks standard hardware warranty is for one year from date of shipment from Cambium Networks or a Cambium distributor. Cambium Networks warrants that hardware will conform to the relevant published specifications and will be free from material defects and workmanship under normal use and service. Cambium Networks shall within this time, at its own option, either repair or replace the defective product within 30 days of receipt of the defective product. Repaired or replaced products are subject to the original warranty period but not less than 30 days.

To register cnRanger products or activate warranties, visit the support website. For warranty assistance, contact the reseller or distributor. The removal of the tamper-evident seal will void the warranty.



Caution

Using non-Cambium Networks parts for repair could damage the equipment or void warranty. Contact Cambium Network for service and repair instructions.

Portions of Cambium Network equipment may be damaged from exposure to electrostatic discharge. Use precautions to prevent damage.

Security advice

Cambium Networks systems and equipment provide security parameters that can be configured by the operator based on their particular operating environment. Cambium Network recommends setting and using these parameters following industry recognized security practices. Security aspects to be considered are protecting the confidentiality, integrity, and availability of information and assets. Assets include the ability to communicate, information about the nature of the communications, and information about the parties involved.

In certain instances, Cambium Networks makes specific recommendations regarding security practices, however the implementation of these recommendations and final responsibility for the security of the system lies with the operator of the system.

Warnings, cautions, and notes

The following describes how warnings and cautions are used in all documents of the Cambium Networks document set.

Warnings

Warnings precede instructions that contain potentially hazardous situations. Warnings are used to alert the reader for possible hazards that could cause loss of life or physical injury. A warning has the following format:



Warning
xxx

Cautions

Cautions precede instructions and are used when there is a possibility of damage to systems, software, or individual items of equipment in a system. However, this damage presents no danger to personnel. A caution has the following format:



Attention/Caution
xxx

Notes

A note means that there is a possibility of an undesirable situation or provides additional information to help the reader understand a topic or concept. A note has the following format:



Notes
xxx

Caring for the environment

The following information describes national or regional requirements for the disposal of Cambium Networks supplied equipment and for the approved disposal of surplus packaging.

In EU countries

The following information is provided to enable regulatory compliance with the European Union (EU) directives identified and any amendments made to these directives when using Cambium equipment in EU countries.



Disposal of Cambium equipment

European Union (EU) Directive 2012/19/EU Waste Electrical and Electronic Equipment (WEEE).

Do not dispose of Cambium Networks equipment in landfill sites. For disposal instructions, refer to <https://www.cambiumnetworks.com/support/compliance/>

Disposal of surplus packaging

Do not dispose of surplus packaging in landfill sites. In the EU, it is the individual recipient's responsibility to ensure that packaging materials are collected and recycled according to the requirements of EU environmental law.

In non-EU countries

In non-EU countries, dispose of Cambium Networks equipment and all surplus packaging in accordance with national and regional regulations.

Chapter 1: Product Description

This chapter provides a high-level description of cnRanger family products. It describes in general terms the function of the product, the main product variants and the main hardware components. The following topics are described in this chapter:

- [cnRanger family overview](#) introduces the key features, typical uses, product variants, and components of the cnRanger family.
- [Features](#) describes the LTE features.
- [System management](#) introduces the cnRanger platform family management system, including the web interface, configuration, security, alerts, and recovery.

cnRanger family overview

The cnRanger family products are designed to provide a low operability cost Point-to-Multipoint wireless communications using over LTE radio links. The cnRanger system currently supports operation in 3GPP bands 38, 40, 41, 42, 43, and 48. Users must ensure that local licensing and other governmental operating regulations are followed.

Features

cnRanger 800 BBU

- Embedded EPC resulting in a simplified and less expensive network architecture
- Split cnRanger 800 BBU/ 2 GHz cnRanger 220 RRH/ 3 GHz cnRanger 210 RRH architecture provides easy access to cnRanger 800 BBU during site visits reducing the need for tower climbs
- LTE non line of site performance improvements due to higher power, OFDMA frequency selective scheduling, and air frame design
- 64 SM per sector capacity
- Currently supports one, two or three sectors with one, two or three 2 GHz/3 GHz cnRanger RRH
- 3GPP Release 10+ support
- On-board GPS receiver
- 6x6 Tx/Rx chains, software upgradeable to 8x8.

2 GHz cnRanger 220 Remote Radio Head (RRH)

- 3GPP bands 38, 40, 41 (2.3 – 2.7 GHz)
- 2x2 Tx/Rx chains
- 2W (33 dBm) per chain
- Two 2x2 Tx/Rx chains on separate carriers as support Carrier Aggregation with two carriers on each Tx/Rx chain
- IP67.

3 GHz cnRanger 210 RRH

- 3GPP bands 42, 43 and 48 (CBRS)
- 2x2 Tx/Rx chains
- 1W (30dBm) per chain
- Software upgradeable to support Carrier Aggregation with two carriers on each Tx/Rx chain
- IP67.

2 GHz cnRanger 101 SM

- 3GPP bands 38, 40, 41
- Maximum 0.24W (23 dBm) output power for band 38 and 40
- Maximum 0.4W (26 dBm) output power for band 41
- 15 dBi integrated antenna
- 3GPP CAT4, 64-QAM DL / 16-QAM UL
- 1x2 Tx/Rx chains
- Gigabit Ethernet
- IP55.

2 GHz cnRanger 201 SM

- 3GPP bands 38, 40, 41
- Maximum 0.24W (23 dBm) output power for band 38 and 40
- Maximum 0.4W (26 dBm) output power for band 41
- 17.5 dBi integrated antenna
- 3GPP CAT4, 64-QAM DL / 16-QAM UL
- 1x2 Tx/Rx chains
- Gigabit Ethernet
- IP67

3 GHz cnRanger 201 SM

- 3GPP bands 42, 43 and 48 (CBRS)
- Maximum 0.24W (23dBm) output power for band 42, 43 and 48
- 21 dBi integrated antenna
- 3GPP Category 6 UE (64 QAM DL /64 QAM UL)
- 1x2 Tx/Rx chains
- Gigabit ethernet.
- IP67

System management

cnRanger family management of the system is managed through the system management, including the web interface, installation, configuration, alerts, and upgrades.

Management agent

The cnRanger family radios are managed through a GUI accessed by HTTP or HTTPS and separately there is a cnMaestro agent.

Management workstations, network management systems or PCs can be connected to this agent using the module's Ethernet port or over-the air.

The management agent supports the following interfaces:

- Hypertext Transfer Protocol (HTTP)
- Hypertext Transfer Protocol Secure (HTTPS)
- Network Time Protocol (NTP)
- cnMaestro™

Web server

The cnRanger 800 BBU and cnRanger 201 SM management agent contains a web server. The web server supports access via the HTTP/HTTPS interface.

Web-based management offers a convenient way to manage the cnRanger family radios from a locally connected computer or from a network management workstation connected through a management network, without requiring any special management software. The web is the interface supported for installation of cnRanger Family radios and for the majority of configuration management and performance management tasks.

Network Time Protocol (NTP)

The clock supplies accurate date and time information to the system. It can be set to run with or without a connection to a Network Time Server (NTS). It can be configured to display local time by setting the time zone and daylight saving in the time web page.

If an NTP server connection is available, the clock can be set to synchronize with the server time at regular intervals.

The time zone option is configurable on the cnRanger 800 BBU configuration page and may be used to offset the received NTP time to match the operator's local time zone. When set on the cnRanger 800 BBU, the offset is set for all sector (cnRanger 800 BBU) is notified of the current time zone upon initial registration). If a time zone change is applied, the cnRanger 800 BBUs are notified of the change in a best effort fashion, meaning some cnRanger 800 BBUs may not pick up the change until the next re-registration. Time zone changes are noted in the event log.

A cnRanger 800 BBU which is receiving NTP date and time information from an NTP server or from a GPS synchronization source may be used as an NTP server. No additional configuration (other than the cnRanger 800 BBU receiving valid NTP data) is required to use the cnRanger 800 BBU as an NTP server.

cnMaestro™

cnMaestro™ is a cloud-based or On-Premises platform specialized for secure, end-to-end network lifecycle management: inventory management, device onboarding, daily operations, maintenance and is recommended for managing cnRanger platform family networks. The cnMaestro wireless network manager simplifies device management by offering full network visibility. Network operators can have a real-time view of their complete end-to-end network and perform a full suite of wireless network management functions to optimize system availability, maximize throughput, and meet the emerging needs of business and residential customers. In addition, the cnMaestro wireless network manager collects and displays compliance with service level agreements.

To learn about cnMaestro™, please visit <http://www.cambiumnetworks.com/products/software-tools/cnmaestro/>

Device recovery mode

The cnRanger family recovery mode provides a means to recover from serious configuration errors by resetting configuration parameters to factory default values.

For more information on resetting, refer to [Device recovery](#).

Chapter 2: System Hardware

This chapter describes the hardware components of cnRanger family as follows:

- [System components](#)
- [Power supply units](#)
- [Antennas](#)
- [Cabling](#)
- [SFP/SFP+ Module Kits](#)
- [Optical cables and connectors](#)
- [Lightning protection and grounding kit](#)

System components

This section describes about the cnRanger 800 BBU and 2 GHz cnRanger 220 RRH hardwares.

cnRanger 800 BBU hardware overview

The cnRanger 800 BBU is an indoor mounted unit providing LTE processing for up to three LTE carriers (up to four will be supported in a future software release). The cnRanger 800 BBU unit connects to the network backhaul via Ethernet and to the 2 GHz/3 GHz cnRanger RRH units via CPRI fiber optic cable.



Note

This product meets the UL/cUL 62368/IEC 62368 edition 2 specification, and the radio housings are designed to be rain tight.

Figure 1: cnRanger 800 BBU



Hardware platform variants

LTE BBU unit is available as a single hardware platform.

- cnRanger 800 BBU

Region support

cnRanger 800 BBU hardware platform supports different regions in single platform:

- FCC (USA)
- IC (Canada)
- RoW (non FCC/IC/EU countries)
- EU (European Union)

Interfaces

cnRanger 800 BBU supports the following interfaces.

Figure 2 : cnRanger 800 BBU front view



Figure 3 : cnRanger 800 BBU rear view



Caution

The cnRanger 800 BBU may be hot to touch when in operation. Contact should be avoided to prevent injury.

Table 1 : cnRanger 800 BBU rear interfaces

Port name	Connector	Interface	Description
PSU Port	4-pin Terminal Block	48V DC Input	36V to 60V





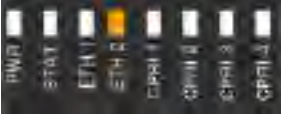

Table 2 : cnRanger 800 BBU front interfaces

Port name	Interface	Description
CPRI [1:4]	4- SFP+ Ports	Optical 2.45Gbps/4.9Gbps Supports CPRI V4.2 and above
ETH1	1-SFP Port	1000-Base SX port
ETH2	1-RJ45 Port	100/1000 Mbps Ethernet Interface over copper
Console	Mini USB Connector	USB to UART Interface (Serial Console)
USB	USB Type-A Connector	External Pen Drive for saving logs.
Reset	Push Button Reset	Power On Reset and Factory Defaults
GPS ANT	SMA Connector	Connect to External GPS Puck Antenna

Port name	Interface	Description
SYNC IN	SMA Connector	Connect to 1PPS from External GPS module or 1PPS from another cnRanger 800 BBU
SYNC OUT	SMA Connector	Connect to 1PPS Output another cnRanger 800 BBU

cnRanger 800 BBU LED details

Table 3 : cnRanger 800 BBU LED details

LED Name	LED	Color	Behaviour	Status Indication
Power		Red	Blinking	When cnRanger 800 BBU is under factory defaults
		Red	Steady ON	Power ON
Status		Green	OFF	Fault
		Green	Steady ON	Operational
		Green	Blinking	Booting/Updating
ETH1		Green	Blinking	Activity
		Green	Steady ON	Link up
ETH2		Yellow/Green	Steady ON	1000mbps link
		Yellow/Green	Blinking	1000mbps Activity
		Yellow/Green	OFF	No Link
		Orange	Steady ON	100mbps link
		Orange	Blinking	100mbps Activity
CPRI [1:4]		Red	Blinking/ON	Fault
		Yellow/Green	Blinking/ Steady ON	Activity

Accessories

Table 4 : cnRanger 800 BBU accessories

Part Number	Description
N000000L129A	XP Power 120W PSU for cnRanger 800 BBU and 2 GHz/3 GHz cnRanger RRH
N000000L111A	Power Supply, AC to 48VDC, 240W, DIN Rail, UL Listed
N000000L112A	Power Supply, AC to 48VDC, 480W, DIN Rail, UL Listed
N000000L132A	9.8Gbps CPRI SFP+ module, Gigalight
N000000L133A	1 Gbps Ethernet SFP Module, Gigalight
N000900L030A	External GPS Antenna

Specifications

The cnRanger 800 BBU conforms to the specifications listed in [cnRanger 800 BBU specifications](#).

Table 5 : cnRanger 800 BBU specifications

Category	Specification
Surge Suppression	Ethernet EN61000-4-5: 8us/20us, 2kV voltage waveform DC Power Port EN61000-4-5: 10us/700us, 2kV voltage waveform
Temperature / Humidity	-40°C to +60°C (-40°F to +140°F), 5-95% non-condensing
Weight	3.2Kg (7.1 lbs)
Dimensions (WxHxD) (including mount)	13" (W) x 2 3/8" (H) x 9" (D) (330 mm x 60 mm x 229 mm)
Power Consumption	90 W nominal, 120 W peak
Recommended Power Supply	P/N: N000000L129A - XP Power 120 W PSU
Input Voltage	48V DC (36V to 60V)

2 GHz cnRanger 220 RRH hardware overview

The 2 GHz cnRanger Remote Radio Head (RRH) is a tower mounted ODU that provides TD-LTE 2Tx 2Rx capability for an LTE carrier (up to two 2Tx 2Rx LTE carriers with future software upgrade). It is managed by the cnRanger 800 BBU product via the CPRI fiber optic cable between the two devices.

Figure 4 : 2 GHz cnRanger 220 RRH front view



3 GHz cnRanger 210 RRH hardware overview

The 3 GHz cnRanger RRH is a tower mounted ODU that provides TD-LTE 2Tx 2Rx capability for an LTE carrier (up to two 2Tx 2Rx LTE carriers with future software upgrade). It is managed by the cnRanger 800 BBU product via the CPRI fiber optic cable between the two devices.

Figure 5 : 3 GHz cnRanger 210 RRH front view







Interfaces





Table 6 : 2 GHz cnRanger 220 RRH front interfaces

Port name	Interface	Description
SFP1	Optical 2.45Gbps/4.9Gbps	Supports CPRI V4.2 and above
PSU (LPS)	Circular 3-pin connector	48V DC Input (36V to 60V) 48V DC Output (1.33A max)
ANT1 ANT2	N-type connector	+/- 45° (Polarization)

2 GHz/3 GHz cnRanger RRH LED details

Table 7 : 2 GHz/3 GHz cnRanger RRH LED details

LED Name	LED	Color	Behaviour	Status Indication
OPT1		Red	Blinking	CPRI optical link to the cnRanger 800 BBU is faulty
		Green	Steady ON	CPRI link to the cnRanger 800 BBU is operational and synchronization with cnRanger 800 BBU achieved
OPT0		Red	Blinking	CPRI optical link to the cnRanger 800 BBU is faulty
		Green	Steady ON	CPRI link to the cnRanger 800 BBU is operational and synchronization with cnRanger 800 BBU achieved

LED Name	LED	Color	Behaviour	Status Indication
VSWR		Red	Blinking/ON	VSWR alarm
		Red	OFF	No VSWR
ACT	 	Green	Blinking	Data activity is ongoing
		Orange	ON	Connection OK
		Green/ Orange	OFF	Connection is faulty
ALM		Green	Blinking	Board booting/updating
		Green	Steady ON	Board is operational
		Green	OFF	Board is faulty
RUN		Red	ON	Power present
		Red	OFF	Power not present

Hardware platform variants

2 GHz/3 GHz cnRanger RRH unit is available as single hardware platform.

Model Name	Model Number
2 GHz cnRanger 220 RRH	2LTE-RRH-220
3 GHz cnRanger 210 RRH	3LTE-RRH-210

Accessories

Part Number	Description
N000000L128A	2 GHz cnRanger 220 RRH Mounting Kit
N000000L129A	XP Power 120W PSU for cnRanger 800 BBU and 2 GHz cnRanger 220 RRH
N000000L130A	2 GHz cnRanger 220 RRHDC power cable (2 meter)
N000000L131A	2 GHz cnRanger 220 RRHCPRI Fiber cable (2 meter)
N000000L132A	9.8Gbps CPRI SFP+ module, Gigalight
C000000L114A	LPU and Grounding Kit

Specifications

Category	Specification
Antenna Connection	2 N-Type
Surge Suppression	EN61000-4-5: 1.2us/50us, 500 V voltage waveform
Temperature / Humidity	-40°C to +55°C (-40°F to +131°F), 5 to 95% non-condensing
Weight	6 kg (13.2 lbs)
Dimensions (HxWxD) (including mount)	10 3/4" (H) x 3 3/16" (H) x 12 1/2" (D) (273 mm x 81 mm x 318 mm)
Wind Survival	200 Km/Hr
Optional Mounting Kit	1.5" to 3.0" (38 to 76 mm) pole N000000L128A
Power Consumption	55 W nominal, 72 W peak
Recommended Power supply	P/N: N000000L129A - XP Power 120 W PSU
Input Voltage	48V DC (36V to 60V)

cnRanger 101 SM hardware overview

The cnRanger 101 SM Fixed LTE wireless platform substantially increases range and coverage, while reducing the cost and complexity typically associated with LTE networks.

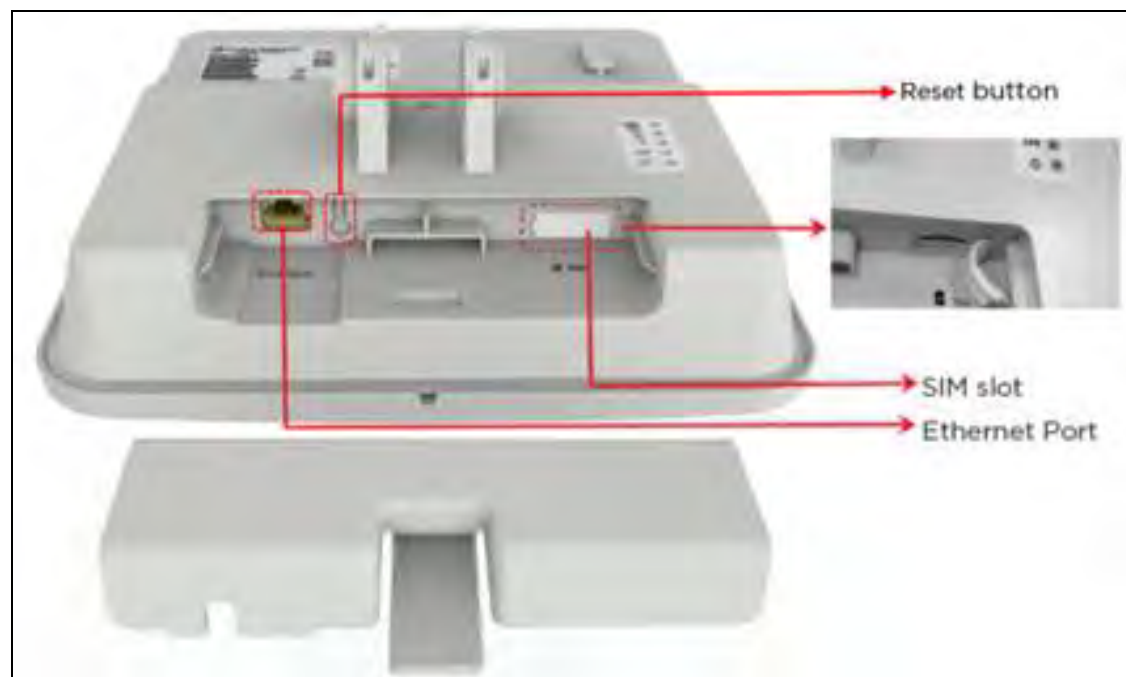
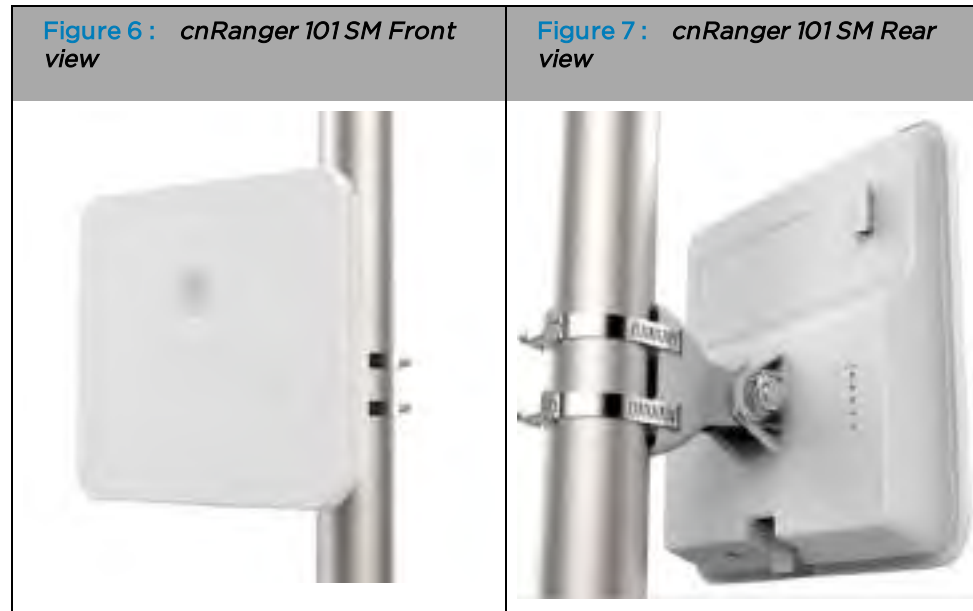

Interfaces

This section describes about the cnRanger 101 SM interfaces as follows:

Table 8 : cnRanger 101 SM interfaces





Port name	Interface	Description
SIM slot	SIM	It is used for inserting SIM card.
Ethernet port	Gigabit ethernet interface	It is used to connect to power and connect to the subscriber Ethernet network.
Reset button	Factory reset	It is used to reset the device to factory reset.



cnRanger 101 SM LED details

Table 9 : cnRanger 101 SM LED details

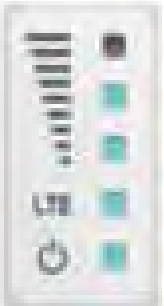
LED Name	LED	Color	Behaviour	Status Indication
Power Status		Blue	Steady ON	Device is ON (AC is plugged in).
		Blue	OFF	Device is OFF (AC is not plugged in or device is faulty).
LTE/SIM		Blue	Steady ON	LTE is attached.
		Blue	Blinking	Searching for LTE network.
		Blue	OFF	Not able to attach to LTE network.
		Orange	Steady ON	SIM issue.
		Orange	Blinking	SIM detection in process.
		Orange	OFF	SIM is detected and working properly. It turns to blue once LTE is attached.
LTE + SINR Status	When CPE connects to Base station, the 3D LEDs become signal quality indicators according to SINR or other pre-defined quality indicator.			

LED Name	LED	Color	Behaviour	Status Indication
LTE SINR-1 + SINR-2 + SINR-3 + SINR-4		Blue	OFF	SINR < 11dB 11dB <= SINR < 18dB
		Blue	Steady ON	
		Blue	Steady ON	18dB <= SINR < 23dB
		Blue	Steady ON	23dB <= SINR

Variants

Model Name	Model Number
cnRanger 101 SM	2LTE-SM-101
	2LTE-SM-101-US
	2LTE-SM-101-UK
	2LTE-SM-101-EU

Accessories

Part Number	Description
LTE-SIM-10	SIM Card for cnRanger 101 SM - 10 pack
N000900L001C	PoE Gigabit DC Injector, 15W Output at 30V, EL 6 Supply
N000900L031A	CABLE, UL POWER SUPPLY CORD SET, 720mm, US
N000900L032A	CABLE, UL POWER SUPPLY CORD SET, 720mm, EU
N000900L033A	CABLE, UL POWER SUPPLY CORD SET, 720mm, UK

Specifications

Category	Specification
RF Transmit Power	26 dBm in Band 41 23 dBm in Band 38 and band 40
Surge Suppression	EN61000-4-5: 1.2us/50us, 500 V voltage waveform
Environmental	IP55
Temperature / Humidity	-40°C to +60°C (-40°F to +140°F), 5-95% non-condensing
Weight (w/included mount)	4.4 lbs (2 kgs)
Dimensions (HxWxD)	10.2" (H) x 10.2" (W) x 3.6" (D) (260 mm x 260 mm x 92 mm)
Wind Survival	190 Km/Hr
Pole Diameter Range (w/included mount)	1.5" to 3.0" (38 to 76 mm)
Power Consumption	7.6 W
Power Supply	30 V PoE

cnRanger 201 SM hardware overview

The cnRanger 201 SM Module Fixed LTE wireless platform substantially increases range and coverage, while reducing the cost and complexity typically associated with LTE networks.

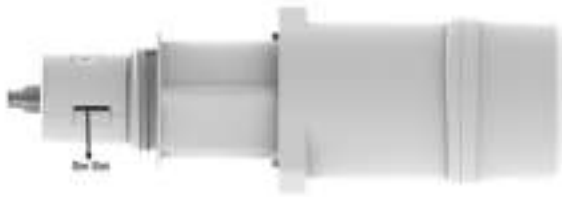

Interfaces

This section describes about the cnRanger 201 SM interfaces as follows:

Table 10 :SM interfaces





Port name	Interface	Description
SIM slot	SIM	It is used for inserting SIM card.
Ethernet port	Gigabit ethernet interface	It is used to connect to power and connect to the subscriber Ethernet network.
Reset button	Factory reset	It is used to reset the device to factory reset



cnRanger 201 SM LED details

Table 11 : cnRanger 201 SM LED details

LED Name	LED	Color	Behaviour	Status Indication
Power Status		Blue	Steady ON	Device is ON (AC is plugged in).
		Blue	OFF	Device is OFF (AC is not plugged in or device is faulty).

LED Name	LED	Color	Behaviour	Status Indication
LTE/SIM		Blue	Steady ON	cnRanger 201 SM attached to LTE network.
		Blue	Blinking	Searching for LTE.
		Blue	OFF	CPE not attached to LTE network.
		Orange	Steady ON	SIM issue.
		Orange	Blinking	SIM detection in process.
LTE + SINR Status	When CPE connects to Base station, the 3D LEDs become signal quality indicators according to SINR.			
LTE SINR-1 + SINR-2 + SINR-3 + SINR-4		Blue	OFF	< 5 dB 5 dB <= CINR < 10 dB
		Blue	Steady ON	
		Blue	Steady ON	10 dB <= CINR < 20 dB
		Blue	Steady ON	20 dB <= CINR

Accessories

Part Number	Description
LTE-SIM-10	SIM Card for cnRanger SM - 10 pack
N000900L001C	PoE Gigabit DC Injector, 15W Output at 30V, EL 6 Supply
N000900L031A	CABLE, UL POWER SUPPLY CORD SET, 720mm, US
N000900L032A	CABLE, UL POWER SUPPLY CORD SET, 720mm, EU
N000900L033A	CABLE, UL POWER SUPPLY CORD SET, 720mm, UK

Specifications

Category	Specification
RF Transmit Power	23 dBm
Surge Suppression	EN61000-4-5: 1.2us/50us, 500 V voltage waveform
Environmental	IP67
Temperature / Humidity	-40°C to +55°C (-40°F to +131°F), 5-95% non-condensing
Weight (w/included mount)	7.0 lbs (3.2 kgs)
Dimensions (HxWxD)	18.6" (H) x 18.6" (W) x 11.5" (D) (472.81 mm x 472.81 mm x 293.7 mm)
Wind Survival	190 Km/Hr
Pole Diameter Range (w/included mount)	1.5" to 3.0" (38 to 76 mm)
Power Consumption	9 W
Power Supply	30 V PoE

Power supply units



Caution

Do not dispose of Electronic and Electric Equipment or Electronic and Electric Accessories with your household waste. In some countries or regions, collection systems have been set up to handle waste of electrical and electronic equipment. In European Union countries, contact your local equipment supplier representative or Cambium Networks Support Centre for information about the waste collection system in your country.

Safety precautions

All national and local safety standards must be followed while configuring the units and aligning the antennas.



Warning

Ensure that personnel are not exposed to unsafe levels of RF energy. The units start to radiate RF energy as soon as they are powered up. Respect the safety standards defined in [Compliance with safety standards](#), in particular the minimum separation distances.

Observe the following guidelines:

- Never work in front of the antenna when the 2 GHz/3 GHz cnRanger RRH or 2 GHz/3 GHz cnRanger SM is powered.
- Always power down the PSU before connecting or disconnecting the drop cable from the PSU, 2 GHz/3 GHz cnRanger RRH, 2 GHz/3 GHz cnRanger SM or LPU.

cnRanger 800 BBU and 2 GHz/3 GHz cnRanger RRH PSU

PSU description

The PSU is a DIN-Rail mountable unit that is connected to the cnRanger 800 BBU using Power cables on the Terminal Block on the rear side and plugged in to AC power using power cables.



Warning

Always use an appropriately rated and approved AC Power cables (AWG 10-18) in accordance with the regulations of the country of use.

AC power injector interfaces

The AC PSU Connections are shown in [AC PSU Connections](#) and described in [AC Power Injector interface functions](#).

Figure 8 : Figure 7 AC PSU Connections



Table 12 :AC Power Injector interface functions

Interface	Function
AC power in	AC power input (3 - terminals L, N, E)
BBU	DC power output (4 - terminals 2- V+, 2- V-)
Grounding	RJ45 socket for connecting Cat5e cable to network
Power (Green) LED	Power supply ok
DC LO (Red) LED	DC output low Voltage (overloading)

PSU part numbers

Order PSUs and (for AC power) line cords from Cambium Networks ([Power supply component part numbers](#)).

Table 13 :Power supply component part numbers

Cambium description	Cambium part number
cnRanger 800 BBU AC Power Supply Unit	N000000L034A

PSU specifications

The cnRanger 800 BBU AC PSU conforms to the specifications listed in [AC Power Supply Unit specifications](#).

Table 14 :AC Power Supply Unit specifications

Category	Specification
Dimensions (H X W X D)	142.0 mm (5.59 in) (H) x 63.5 mm (2.50 in) (W) x 116.0 mm (4.57 in) (D)
Weight	1.36Kg (3.0 lbs)
Temperature	-35°C to + 70°C (cold start supported for cnRanger 800 BBU Load), Derate from +60°C linearly
Humidity	20-95% RH, non-condensing
Cooling	Convection-cooled with 25mm free space all sides
Waterproofing	Not waterproof
Altitude	Sea level to 5000 meters (16000 ft)
AC Input	Min 90 V AC, 57 - 63 Hz, max 264 V AC, 47 - 53 Hz.
DC output voltage to the BBU	48V (Trimmable 45V to 55VDC) +/- 1%
AC connector	3- wire terminal Header
Efficiency	Better than 85%
Over Current Protection	105-145% constant current, auto recovery
Over Voltage Protection	Output clamps at 125-140% Vnom, auto recovery
Hold up time	25/30 ms at 115/230 VAC
DIN Rail	Compatible with TS35/7.5 or TS35/15

Subscriber Module premises equipment power supply unit (SM PSU)

This section describes about AC power injector.

AC Power Injector interfaces

The AC Power Injector interfaces are shown in [AC Power Injector Front and Rear view](#) and described in [AC Power Injector interface](#) functions.

Figure 9 : AC Power Injector Front and Rear view



Interfaces

Table 15 :AC power injector interfaces

Port name	Interface	Description
LAN	Gigabit data	Used to connect the LAN interface or PC
ODU	15W 30V Gigabit data + Power	Used to power ODU
AC power input	AC power input	Used to connect AC power to PoE injector

PSU part numbers

Order PSUs and (for AC power) line cords from Cambium Networks.

Table 16 :Power supply component part numbers

Cambium Part Number	Cambium Description
N000900L001C	PoE Gigabit DC Injector, 15W Output at 30V, EL 6 Supply
N000900L031A	CABLE, UL POWER SUPPLY CORD SET, 720mm, US
N000900L032A	CABLE, UL POWER SUPPLY CORD SET, 720mm, EU
N000900L033A	CABLE, UL POWER SUPPLY CORD SET, 720mm, UK

PSU specifications

The 2 GHz/3 GHz cnRanger SM AC Power Injector conforms to the specifications listed in [AC Power Injector specifications](#).

Table 17 :AC Power Injectorspecifications

Category	Specification
Dimensions	260 mm x 260 mm x 92 mm
Weight	2 Kgs (4.4 lbs)
Temperature	-40°C to + 60°C (-40°F to +140°F)
Humidity	5-95% non-condensing
Wind Survival	190 Km/Hr
Pole Diameter Range (w/included mount)	1.5" to 3.0" (38 to 76 mm)

Category	Specification
Power Consumption	7.6 W
Power Supply	30 V PoE

Antennas

2 GHz cnRanger 220 RRH Antenna description

Each connectorized ODU requires one external antenna (normally dual-polar). These antennas are supplied by Cambium Networks (N02500D001A: 17dBi, 65degree Sector Antenna or 2 LTE-ANT-90:16dBi, 90/120-degree Sector Antenna).



Note

To determine when to install connectorized units and to calculate their impact on link performance and regulatory limits.

3 GHz cnRanger 210 RRH Antenna description

Each connectorized ODU requires one external antenna (normally dual-polar). These antennas are supplied by Cambium Networks (3 LTE-ANT-90:17 dBi, 90/120-degree Sector Antenna).



Note

To determine when to install connectorized units and to calculate their impact on link performance and regulatory limits.

RF cable and connectors

RF cable of generic type LMR-400 is required for connecting the ODU to the antenna. N type male connectors are required for connecting the RF cables to the connectorized ODU. Two connectors are required per ODU. Use weatherproof connectors, preferably ones that are supplied with adhesive lined heat shrink sleeves that are fitted over the interface between the cable and connector. Order CNT-400 RF cable and N type male connectors from Cambium Networks ([RF cable and connector part numbers](#)).

Table 18 : RF cable and connector part numbers

Cambium description	Cambium part number
50 Ohm Braided Coaxial Cable - 75 meter	30010194001
50 Ohm Braided Coaxial Cable - 500 meter	30010195001
RF Connector, N, Male, Straight for CNT-400 Cable	09010091001



Note

To select the correct connectors for the antenna end of the RF cable, refer to the antenna manufacturer's instructions.

RRH antenna accessories

- Connectorized ODUs require the following additional components:
- Self-amalgamating and PVC tape: Order these items to weatherproof the RF connectors. Lightning arrestors: When the connectorized ODU is mounted indoors, lightning arrestors are required for protecting the antenna RF cables at building entry. One arrestor is required per antenna cable. One

example of a compatible lightning arrestor is the Polyphaser LSXL-ME or LSXL (not supplied by Cambium Networks).

2 GHz cnRanger 220 RRH Antenna part numbers

The 2 GHz cnRanger 220 RRH antenna part numbers and descriptions are as follows:

Table 19 : Antenna part options

Product	Cambium Part Number	Antenna Gain/Description
2 GHz cnRanger 220 RRH	N025000D001A	17dBi, 65degree Sector Antenna
	2 LTE-ANT-90	16dBi, 90/120-degree Sector Antenna

3 GHz cnRanger 210 RRH Antenna part numbers

The 3 GHz cnRanger 210 RRH antenna part numbers and descriptions are as follows:

Table 20 : Antenna part options

Product	Cambium Part Number	Antenna Gain/Description
3 GHz cnRanger 210 RRH	3 LTE-ANT-90	17 dBi, 90/120-degree Sector Antenna

Cabling

This section describes about the cnRanger 800 BBU and 2 GHz/3 GHz cnRanger RRH cabling as follows:

cnRanger 800 BBU cabling

Ethernet standards and cable lengths

All configurations require a copper Ethernet connection from the cnRanger 800 BBU (Eth Port) to the Network equipment. Advanced configurations may also require an optical connection from the cnRanger 800 BBU (SFP port) to Network terminating equipment.

[Copper SFP Ethernet standards and cable length restrictions](#) specifies, for copper SFP interfaces, the Ethernet standards supported and the maximum permitted drop cable lengths.



Note

For optical SFP interfaces, refer to SFP module kits for details of the Ethernet standards supported and maximum permitted cable lengths.

Table 21: Copper SFP Ethernet standards and cable length restrictions

Ethernet cable	Power over Ethernet	Ethernet supported	Maximum cable length (*1)
CAT5/CAT5e (copper) - linked device	None	1000BASE-TX	100 m (330 ft)

Maximum length of Ethernet cable from the cnRanger 800 BBU to the Network equipment.

2 GHz/3 GHz cnRanger RRH cabling

2 GHz cnRanger 220 RRH DC power cable

- Use custom DC power cable for powering 2 GHz cnRanger 220 RRH.
- DC power cable allows connection from 2 GHz cnRanger 220 RRH to an LPU (Lightning protection unit) or a DC junction box.

Table 22 : 2 GHz cnRanger 220 RRH cable part number

Cambium description	Cambium part number
2 GHz cnRanger 220 RRH DC power cable (2 meter)	N000000L130A

3 GHz cnRanger 210 RRH DC power cable

Power cord for outdoor application with 2 conductors and drain wire, 16AWG or thicker. Please refer to the connection diagram for polarity.

Figure 10 : 3 GHz cnRanger 210 RRH DC power cable



SFP/SFP+ module kits

SFP+ module kits allow connection of 2 GHz/3 GHz cnRanger RRH from cnRanger 800 BBU over optical fiber cable. Use 2.5Gbps or higher SFP+ module to interface 2 GHz/3 GHz cnRanger RRH. Maximum length of optical fiber cable shall not exceed 300 meters. Use Multimode LC-LC outdoor optical fiber cable between 2 GHz/3 GHz cnRanger RRH and cnRanger 800 BBU.

Cambium Networks CPRI fiber cable part number (N000000L131A) is recommended for use between the 2 GHz/3 GHz cnRanger RRH and junction box in order to provide optimal fit through weather proofing gland. From junction box long length CPRI cables can be extended depending on the lengths.

Cambium does not supply long length optical fiber cables along with SFP+ module kits. Recommended cable lengths and specifications are as shown in Multi-mode Optical SFP Interface per ODU (part number C000065L009). Order SFP module kits as shown in SFP module kit part numbers from Cambium Networks.

Table 23 :Multi-mode Optical SFP Interface per ODU (part number C000065L009)

Core/ cladding (microns)	Mode	Bandwidth at 850 nm (MHz/km)	Maximum length of optical interface	Insertion loss (dB)
62.5/125	Multi	160	220 m (720 ft)	2.38
62.5/125	Multi	200	275 m (900 ft)	2.6

Table 24 :SFP module kit part numbers

Cambium description	Cambium part number
CPRI SFP+ Module (10Gbps)	SFP-10G-SR
RRH CPRI Fiber Cable- 2 meter	N000000L131A

Figure 11 : 10Gbps Optical SFP+ transceiver module



Optical cables and connectors

Order an optical cable with LC connectors from a specialist fabricator, quoting the specification shown in Figure 12. It must be the correct length to connect the ODU to the other device. LC connectors should be supplied with dust caps to prevent dust build up.

Figure 12 : Optical optic cable and connector specification

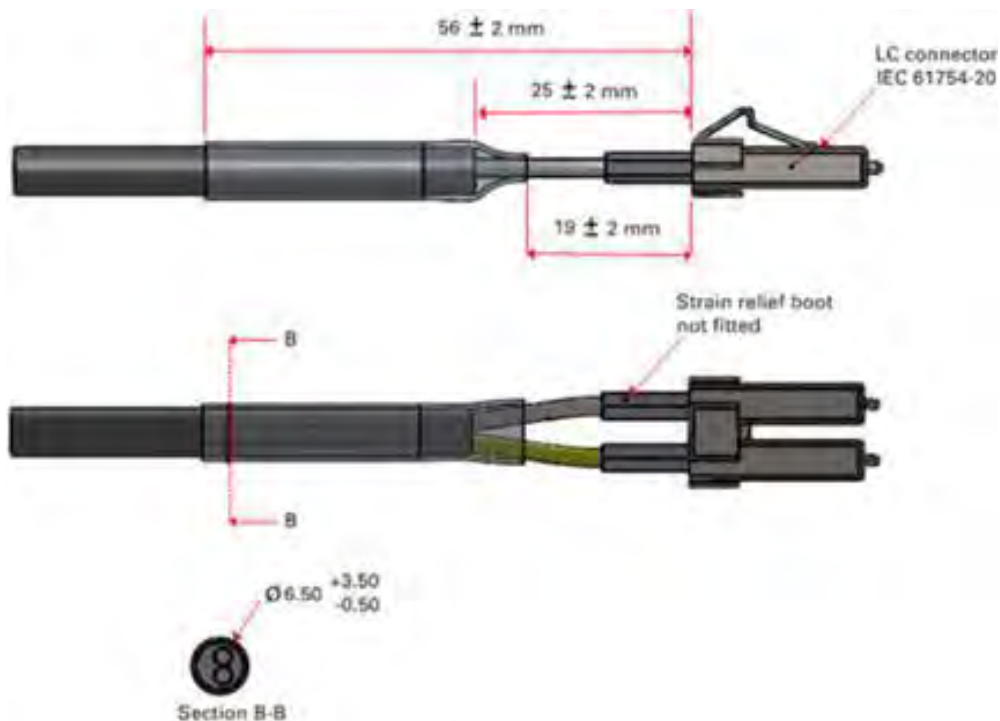

Lightning protection and grounding kit

Structures, equipment and people must be protected against power surges (typically caused by lightning) by conducting the surge current to ground via a separate preferential solid path.

The actual degree of protection required depends on local conditions and applicable local regulations. To adequately protect an installation, both ground bonding and transient voltage surge suppression are required.

Network operators should always follow best practices for grounding and lightning protection. Doing so will minimize network outages and reduce the associated costs of tower climbs and equipment repair/replacement.



Note

Lightning-prone installations can be improved by:

- Installing a surge suppressor near the device (transient surge suppression)
- Grounding the device to the pole (ground bonding)
- Lowering the device such that it is not the highest metallic object on the pole.

DC LPU

The DC- LPU is critical for lightning protection to minimize the potential for damage.

Figure 13: Figure 11 DC LPU



Table 25: DC-LPU part numbers

Cambium description	Cambium part number
LPU and Grounding Kit	C000000L114A

Chapter 3: System Planning

This chapter provides information to help the user for system planning and are describes as follows:

- [Site planning](#) describes factors to be considered when planning the proposed link end sites, including grounding, lightning protection and equipment location.
- [Radio configuration](#) describes factors to be taken into account when planning links, such as range, path loss and throughput.
- [Data network planning](#) describes factors to be considered when planning cnRanger data networks.
- [Network management planning](#) describes how to plan for cnRanger links to be managed remotely using SNMP.
- [Security planning](#) describes how to plan for cnRanger links to operate in secure mode.

Site planning

This section describes factors to be considered when planning the proposed link end sites, including grounding, lightning protection and equipment location for the ODU and PSU.s

Grounding and lightning protection



Warning

Electro-magnetic discharge (lightning) damage is not covered under warranty. The recommendations in this guide, when followed correctly, give the user the best protection from the harmful effects of EMD. However, 100% protection is neither implied nor possible.

Structures, equipment and people must be protected against power surges (typically caused by lightning) by conducting the surge current to ground via a separate preferential solid path. The actual degree of protection required depends on local conditions and applicable local regulations. To adequately protect a PTP 550 installation, both ground bonding and transient voltage surge suppression are required.

Full details of lightning protection methods and requirements can be found in the international standards IEC 61024-1 and IEC 61312-1, the U.S. National Electric Code ANSI/NFPA No. 70-1984 or section 54 of the Canadian Electric Code.



Note

International and national standards take precedence over the requirements in this guide.

Lightning protection zones

Use the rolling sphere method ([Figure 14](#)) to determine where it is safe to mount equipment. An imaginary sphere, typically 50 meters in radius, is rolled over the structure. Where the sphere rests against the ground and a strike termination device (such as a finial or ground bar), all the space under the sphere is considered to be in the zone of protection (Zone B). Similarly, where the sphere rests on two finials, the space under the sphere is considered to be in the zone of protection.

Figure 14 : Rolling sphere method to determine the lightning protection zones

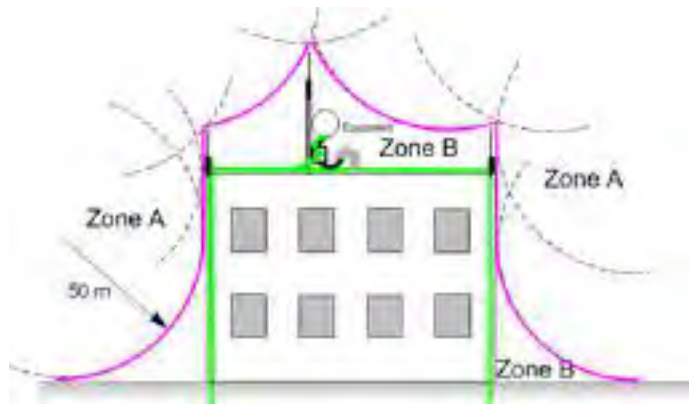

Zone A: In this zone a direct lightning strike is possible. Do not mount equipment in this zone.

Zone B: In this zone, direct EMD (lightning) effects are still possible, but mounting in this zone significantly reduces the possibility of a direct strike. Mount equipment in this zone.



Warning

Never mount equipment in Zone A. Mounting in Zone A may put equipment, structures and life at risk.

Site grounding system

Confirm that the site has a correctly installed grounding system on a common ground ring with access points for grounding ODU.

If the outdoor equipment is to be installed on the roof of a high building refer to [Installation](#), confirm that the following additional requirements are met:

- A grounding conductor is installed around the roof perimeter to form the main roof perimeter lightning protection ring.
- Air terminals are installed along the length of the main roof perimeter lightning protection ring, typically every 6.1m (20ft).
- The main roof perimeter lightning protection ring contains at least two down conductors connected to the grounding electrode system. The down conductors should be physically separated from one another, as far as practical.

ODU and external antenna location

Find a location for the ODU (and external antenna for connectorized units) that meets the following requirements:

- The equipment is high enough to achieve the best radio path.
- People can be kept a safe distance away from the equipment when it is radiating. The safe separation distances are defined in [Legal and regulatory information](#).
- The equipment is lower than the top of the supporting structure (tower, mast or building) or its lightning air terminal.
- If the ODU is connectorized, select a mounting position that gives it maximum protection from the elements, but still allows easy access for connecting and weatherproofing the cables. To minimize cable losses, select a position where the antenna cable lengths can be minimized. If diverse or two external antennas are being deployed, it is not necessary to mount the ODU at the midpoint of the antennas.

Drop cable grounding points

To estimate how many grounding kits are required for each drop cable, refer to the site [installation](#) and use the following criteria:

- The drop cable shield must be grounded near the ODU at the first point of contact between the drop cable and the mast [installation](#), tower or building.
- The drop cable shield must be grounded at the building entry point.

For mast or tower installations [installation](#), use the following additional criteria:

- The drop cable shield must be grounded at the bottom of the tower, near the vertical to horizontal transition point. This ground cable must be bonded to the tower or tower ground bus bar (TGB), if installed.
- If the tower is greater than 61 m (200 ft) in height, the drop cable shield must be grounded at the tower midpoint, and at additional points as necessary to reduce the distance between ground cables to 61 m (200 ft) or less.
- In high lightning-prone geographical areas, the drop cable shield must be grounded at spacing between 15 to 22 m (50 to 75 ft). This is especially important on towers taller than 45 m (150 ft).

For roof installations, use the following additional criteria:

- The drop cable shield must be bonded to the building grounding system at its top entry point (usually on the roof).
- The drop cable shield must be bonded to the building grounding system at the entry point to the equipment room.

Radio configuration

cnRanger Radio configuration is performed exclusively at the cnRanger 800 BBU device. The 2 GHz/3 GHz cnRanger SM provides some controls for managing LTE cell selection, but all radio link settings are controlled by cnRanger 800 BBU and are negotiated with 2 GHz/3 GHz cnRanger SM using standard LTE protocols. In the SM, there is control for selection of country/region and thereby enforcing limits on Maximum transmit power.

The parameters LTE Band, Bandwidth, Frequency, and TX Power are driven by an operator's frequency licensing and system frequency plan. This section has considerations for other Radio Configuration selections.

Downlink data and SSF

The Downlink Data and the advanced Special Subframe (SSF) parameters control the TDD format of the LTE radio physical layer. Downlink Data (referred to in 3GPP as Uplink-downlink configuration) determines which of the 1 msec subframes within the 10 msec frame are configured as Downlink, Uplink or Special. The cnRanger 800 BBU Radio GUI presents these choices in terms of what percentage of the frames are used for Downlink rather than Uplink. The GUI also presents the 3GPP configuration number.



Table 26 : cnRanger supported LTE TDD uplink-downlink configurations

Downlink Data - Uplink-downlink configuration	Switch-point periodicity	Subframe Number									
		0	1	2	3	4	5	6	7	8	9
50% - 1	5 ms	D	S	U	U	D	D	S	U	U	D
75% - 2	5 ms	D	S	U	D	D	D	S	U	D	D
67% - 3	10 ms	D	S	U	U	U	D	D	D	D	D

The Special Subframe format (SSF) parameter may be found in the advanced section of the cnRanger 800 BBU **Configuration > Radio** page. This value determines the number of symbols within the subframe that are allocated to Downlink, Guard Period, and Uplink use. The guard period is needed by the system to facilitate interference free transition due to propagation delay times from downlink subframes to uplink subframes.

Table 27 :Special subframe format configuration details

SSF Config	DwPTS (Symbols)	Guard Period (Symbols)	UpPTS (Symbols)	Max Cell Radius (km)
1	9	4	1	43
5	3	9	2	96
6	9	3	2	32
7	10	2	2	21

Setting of the SSF value allows the user to trade off between slightly more data throughput (due to extra downlink DwPTS and uplink UpPTS symbols) and the expense of maximum cell radius (affected by number of Guard Period symbols). The larger the cell radius the more symbols must be allocated for the SSF Guard Period.

Downlink data, SSF, and co-existence

One major factor when it comes to selecting Downlink Data and SSF parameter values is co-existence with other radio systems operating with carrier frequencies of nearby cnRanger deployment. In these cases, it is important to align Downlink Data and SSF settings to those adjacent systems to prevent interference due to lack of downlink/uplink synchronization. It is also essential to operate your cnRanger system with GPS synchronization in such cases where there is more than a single cnRanger 800 BBU within range of any other TD-LTE system.

Controlling cnRanger 101 SM cell selection

The cnRanger 101 SM GUI provides the means to prioritize which LTE cell it attempts to connect. In the absence of any prioritization the cnRanger 101 SM connects to the LTE cell it hears with the best RSRQ value.

To control cell selection the cnRanger 101 SM may specify a prioritized list of Enhanced Cell ID (ECID) in the **Configuration > Radio** page or the **Configuration > Scan Results** page. During the scan process the cnRanger 101 SM stores information on all of the detected LTE cells in the Scan Result list.

Figure 15: Scan result

Carrier Frequency	ECID	PLMN	SCID	EICID	Bandwidth
4700	51200	00000	0	0	20 MHz
4700	51456	00000	0	0	20 MHz
4700	51200	00000	0	0	20 MHz
0	0	0	0	0	20 MHz
0	0	0	0	0	20 MHz
0	0	0	0	0	20 MHz
0	0	0	0	0	20 MHz
0	0	0	0	0	20 MHz

The user may take the ECID values seen in this list and utilize them to specify a preferred list of target ECID. If any of the ECID in the list appear during the scan process the cell will be chosen in the order presented in the Cell Priority List.

ECID	PLMN	Carrier Frequency	Bandwidth
51200	00000	4700	20 MHz
51456	00000	4700	20 MHz
0	0	0	20 MHz
0	0	0	20 MHz
0	0	0	20 MHz
0	0	0	20 MHz
0	0	0	20 MHz
0	0	0	20 MHz

Add Cell to Priority List

ECID:



Note

In the above example, the cnRanger 101 SM will prefer ECIDs 51200 and 51456 in the order listed if those cells are detected during the scan process.

Link planning

This section describes factors to be considered when planning links, such as range, obstacles path loss and throughput. Use of Cambium Networks LINKPlanner is recommended.

Path loss

Path loss is the amount of attenuation the radio signal undergoes between the two ends of the link. The path loss is the sum of the attenuation of the path if there were no obstacles in the way (Free Space Path Loss), the attenuation caused by obstacles (Excess Path Loss) and a margin to allow for possible fading of the radio signal (Fade Margin). The following calculation needs to be performed to judge whether a link can be installed:

Figure 16 : Path loss

$L_{free_space} + L_{excess} + L_{fade} + L_{seasonal} < L_{capability}$	
Where:	Is:
L_{free_space}	Free Space Path Loss (dB)
L_{excess}	Excess Path Loss (dB)
L_{fade}	Fade Margin Required (dB)
$L_{seasonal}$	Seasonal Fading (dB)
$L_{capability}$	Equipment Capability (dB)

Calculating link loss

The link loss is the total attenuation of the wireless signal between two point-to-multipoint units. The link loss calculation is presented below:

Link Loss (dB) = Transmit power of the remote wireless unit (dBm) – Tx Cable loss (dB) – Received power at the local unit (dBm) – Rx cable loss (dB) + Antenna gain at the remote unit (dBi) + Antenna gain at the local unit (dBi).

Calculating Rx signal level

The determinants in Rx signal level are illustrated in Figure 17.

Figure 17 : Determinants in Rx signal level

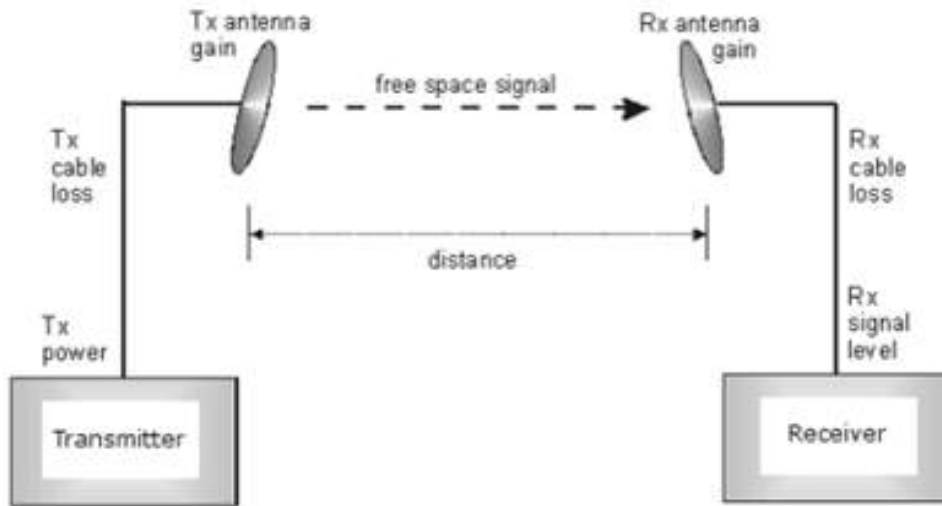

Rx signal level is calculated as follows:

$$\text{Rx signal level dB} = \text{Tx power} - \text{Tx cable loss} + \text{Tx antenna gain} - \text{free space path loss} + \text{Rx antenna gain} - \text{Rx cable loss}$$



Note

This Rx signal level calculation presumes that a clear line of sight is established between the transmitter and receiver and that no objects encroach in the Fresnel zone.

Calculating fade margin

Free space path loss is a major determinant in Rx (received) signal level. Rx signal level, in turn, is a major factor in the system operating margin (fade margin), which is calculated as follows:

$$\text{System operating margin (fade margin) dB} = \text{Rx signal level dB} - \text{Rx sensitivity dB}$$

Thus, fade margin is the difference between strength of the received signal and the strength that the receiver requires for maintaining a reliable link. A higher fade margin is characteristic of a more reliable link.

Data network planning

IP mode

cnRanger 101 SM Ethernet network

The IP Mode cnRanger 101 SM acts as a layer 3 Network Address Translation (NAT) device. The “public” IP address is assigned to the cnRanger 101 SM via the cnRanger LTE network and is used to reach the cnRanger 101 SM from the radio link. The cnRanger 101 SM Ethernet interface however hosts a private IPv4 subnet and is configured via the cnRanger 101 SM **Configuration > Network > LAN IP** and DHCP panels. IP addresses of devices on the cnRanger 101 SM Ethernet subnet are not forwarded over the LTE radio link.

Instead the cnRanger 101 SM LTE assigned IP address is applied via NAT. Because if this it is possible for the operator to not require any modification to the cnRanger 101 SM networking configuration for many subscriber deployments.

The other feature of the cnRanger 101 SM Ethernet network is the cnRanger 101 SM DHCP server. The DHCP server is enabled by default and will forward DNS addressing details from the values received from the LTE network. The operator has the option to override the DNS server addressing distributed by the cnRanger 101 SM DHCP Server as well as to have the cnRanger 101 SM act as a DNS proxy.

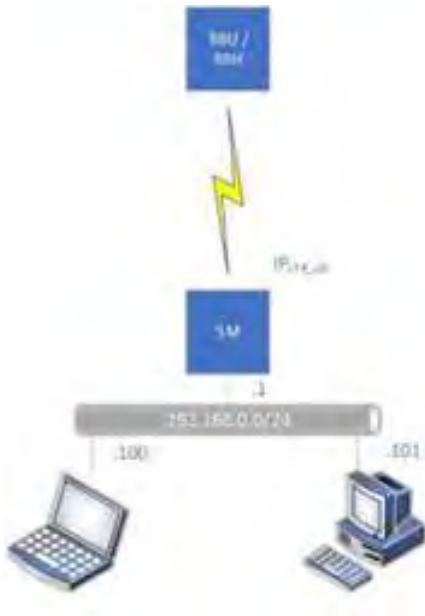

cnRanger 800 BBU network

The cnRanger IP Mode networking is the natural way in which LTE systems operate. Each cnRanger 101 SM or CPE in the system is assigned an IP address by the network and this address becomes the end-user's IP address. This mode of operation allows the possibility of using 3rd party cnRanger 101 SM. Current assumptions for this mode of operation include:

1. The cnRanger system is part of an IPv4 Ethernet based network.
2. cnRanger 800 BBU Data and Management interfaces are members of the same IPv4 subnet.
3. cnRanger 800 BBU Data and Management interfaces are both terminated on the user-selected BBU ETH1 or ETH2 interface
4. cnRanger 800 BBU supports VLANs and it is also capable of passing tagged VLAN traffic.
5. Dynamic 2 GHz/3 GHz cnRanger SM IP addresses are issued, by the serving cnRanger 800 BBU as part of the LTE attach process.
6. Static 2 GHz/3 GHz cnRanger SM IP addresses are provisioned at the serving cnRanger 800 BBU and are delivered to the 2 GHz/3 GHz cnRanger SM during the attach process.
7. 2 GHz/3 GHz cnRanger SM Data and Management operations share the same IP address.

Each cnRanger 800 BBU is part of an Ethernet based IPv4 subnet shared with an operator provisioned edge router (and likely additional cnRanger 800 BBU). This edge router is provisioned as the Default Gateway on the cnRanger 800 BBU.

The cnRanger IP Mode of operation has two significant variants which depend on how the operator defines the cnRanger 101 SM IP addressing scheme. The behavior of the cnRanger 800 BBU depends entirely on the addresses chosen for **Configuration > Network > Subscriber Address Pool** parameters.

cnRanger 800 BBU router configuration

In the cnRanger 800 BBU Router Configuration the network is such that the addresses allocated to the cnRanger 101 SM of a given cnRanger 800 BBU are a distinct routable subnet. In the example below the cnRanger 800 BBU Management and Data interfaces and the Operator Edge Router are part of the 10.140.100.0 subnet. The cnRanger 800 BBU SM Address Pools (the addresses used to allocate addresses to the 2 GHz/3 GHz cnRanger SM during the LTE Attach procedure) are allocated out of different subnets than 10.140.100.0. In this configuration the Edge Router treats the cnRanger 800 BBU as a gateway router to the 2 GHz/3 GHz cnRanger SM subnets and must be configured to route to those subnets as shown in the diagram below.

Figure 18 : cnRanger 800 BBU router configuration

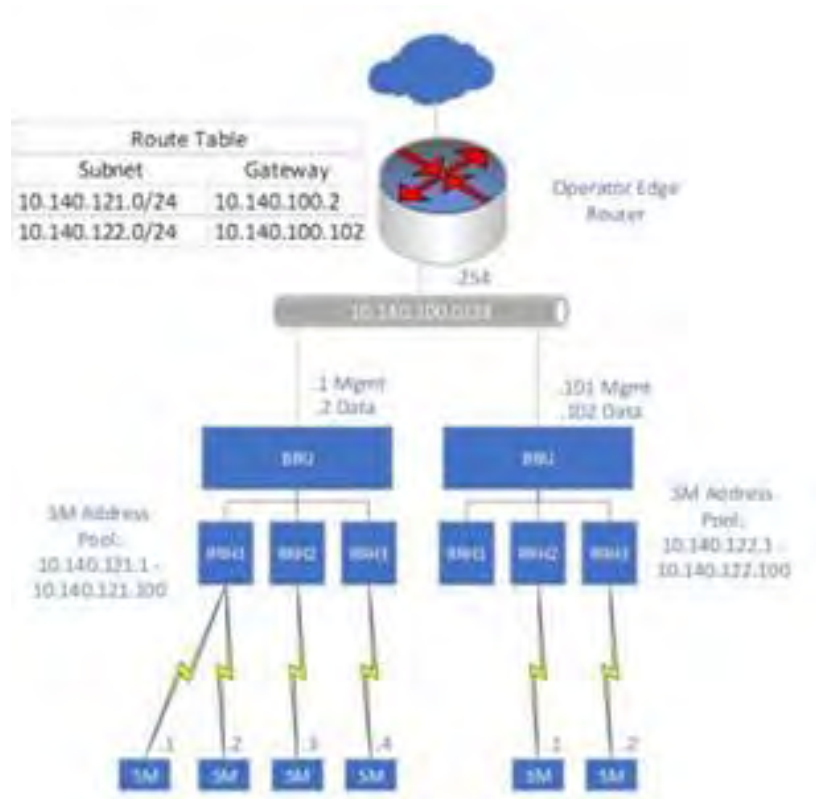

For this setup to work the operator edge router must have its route tables configured to route the specific 2 GHz/3 GHz cnRanger SM subnet to the correct cnRanger 800 BBU Data Interface IP address. Each cnRanger 800 BBU with a distinct subnet and corresponding route table entry at the edge router.

cnRanger 800 BBU proxy ARP configuration

In the cnRanger 800 BBU Proxy ARP configuration, the subscriber address pool addressing is allocated from the same IP subnet as that of the cnRanger 800 BBU Data Interface.

Figure 19 : cnRanger 800 BBU proxy ARP configuration

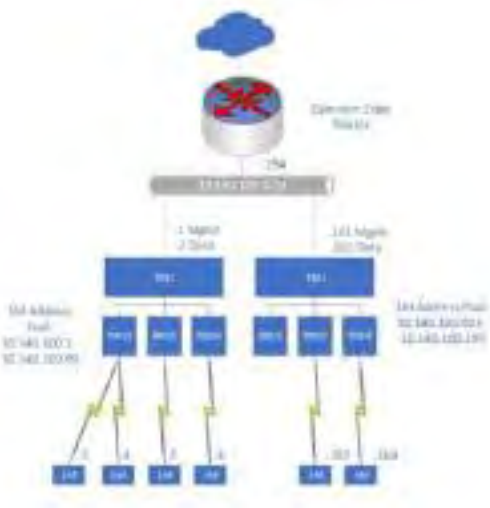

The result is that the operator edge router appears to be on the same broadcast LAN as the 2 GHz/3 GHz cnRanger SM and as such will perform ARP procedures to resolve the 2 GHz/3 GHz cnRanger SM Ethernet address. When this occurs the cnRanger 800 BBU will respond in a proxy ARP manner allowing the edge router to deliver the packet to the correct cnRanger 800 BBU.

Bridging

Bridging feature allows to bridge traffic between network above the cnRanger 800 BBU and network below the SM. Once network is Upgraded to 1.1 (untagged support) or 1.1.1 (tagged/untagged VLAN support) release, user can enable bridging functionality on cnRanger 800 BBU and 2 GHz/3 GHz cnRanger SM.

To enable bridging on cnRanger 800 BBU:

1. Navigate to **Configuration > Network** page.
2. Enable the Bridge check box.
3. Click **Save**.

Reboot is not required to enable this feature.



Note

Reboot is not required to enable bridging on cnRanger 800 BBU and on 2GHz/3GHz cnRanger SM.



To enable bridging on 2 GHz/3 GHz cnRanger SM:

1. Navigate to **Configuration > Network** page.
2. Select operating mode as **Bridge**.
3. Click **Save** to save the settings.

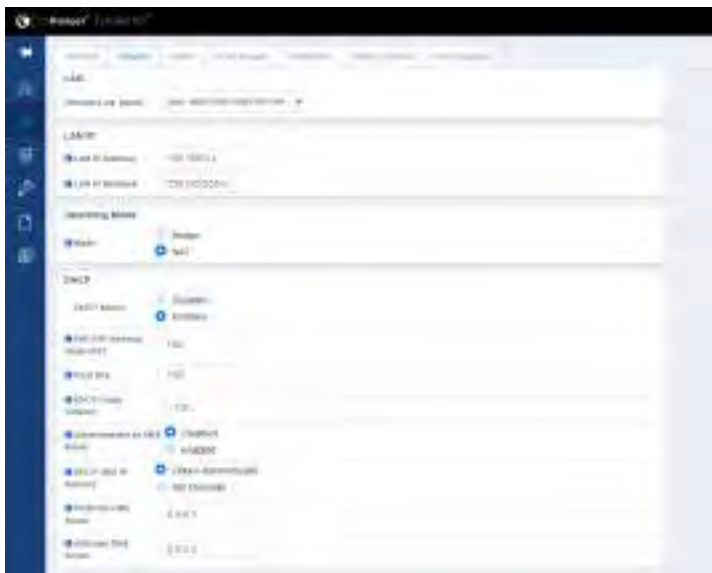

Network management planning

This section describes about device onboarding using cnMaestro.

cnMaestro

cnMaestro page is used for connectivity and onboarding of the device using the Cambium ID. To onboard your device to cnMaestro using Cambium ID refer to [cnMaestro Configuration](#).

Security planning

This section describes about the access management and sim credentials.

Access management

Access management is performed by changing the admin password of the cnRanger 800 BBU or 2 GHz/3 GHz cnRanger SM using the device GUI.

To access the password change screen:

1. Click **Admin** > select **Profile** on the upper right side of the GUI.

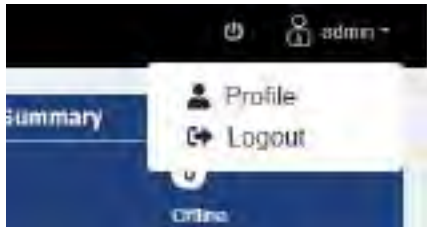

2. Enter current and new password.
3. Click **Change Password**.

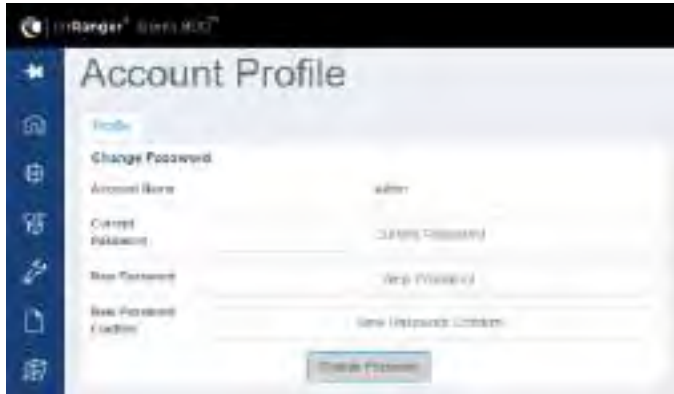

Note

The new admin password must consist of at least eight characters.

SIM credentials

System access in cnRanger is dependent on installation of SIM credentials on every cnRanger 800 BBU in the operator network. To ease the operations aspects of SIM card management cnMaestro provides utilities for the claiming, management, and distribution of Cambium Networks cnRanger SIM card credentials (3rd party SIM cards are not currently supported on cnRanger).

Claiming SIM cards

The MSN value from the packaging and Cloud cnMaestro account information is needed to claim SIM cards.

1. Log into the cnMaestro cloud account.
2. Open the **Services > LTE** page.



3. Click **Add** in the upper right section of the SIM Management panel.

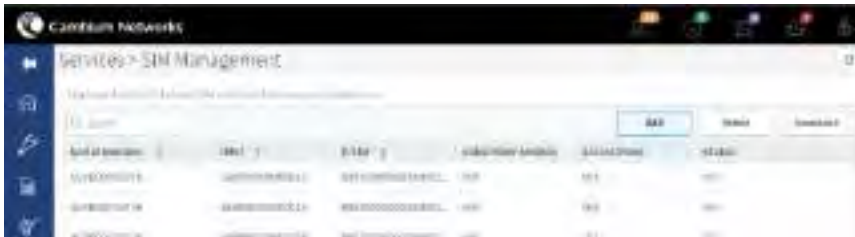

4. Enter the MSN from the SIM package in the **Serial Number** text box.



Your new SIM cards are now claimed and available in cnMaestro.

SIM credentials file cnMaestro download

To use the claimed SIM cards, the cnRanger 800 BBU should have the information loaded into the device. In cases where the data is uploaded via the cnRanger 800 BBU GUI the SIM data must first be downloaded from cnMaestro.

1. From the **SIM Management** page, click **Download** button in the upper right section of the panel.



2. cnMaestro downloads the sim.csv file via web browser.

ACV800018716	88800000000017
ACV800018716	88800000000017
ACV800018718	88800000000020
ACV800018710	88800000000019

SIM credential cnRanger 800 BBU upload

The SIM credentials are uploaded to the cnRanger 800 BBU at the **Configuration > SIM Credentials** screen of the cnRanger 800 BBU GUI.

Figure 20 : SIM credential cnRanger 800 BBU upload



The file may be transferred via URL or through the GUI using the Import File option. Once the File chosen or the URL has been entered, the **Start Import** button adds the SIM credentials into the system.

The newly entered SIM cards may now be found in the SIM Card List portion of the **Configuration > SIM Credentials** page.

Figure 21 : SIM cards lists

SIM Card List

77

IMSI Number	IP Allocation	IP Address	Downlink MBR	Uplink MBR	IMSI Status
310014000027515	Dynamic	0.0.0.0			Enabled
310014000027517	Dynamic	0.0.0.0			Enabled
888900000000101	Dynamic	0.0.0.0			Enabled
888900000000102	Dynamic	0.0.0.0			Enabled
888900000000103	Dynamic	0.0.0.0			Enabled
888900000000104	Dynamic	0.0.0.0			Enabled
888900000000105	Dynamic	0.0.0.0			Enabled
888900000000106	Dynamic	0.0.0.0			Enabled
888900000000107	Dynamic	0.0.0.0			Enabled
888900000000108	Dynamic	0.0.0.0			Enabled
888900000000109	Dynamic	0.0.0.0			Enabled
888900000000110	Dynamic	0.0.0.0			Enabled
90170000013089	Dynamic	0.0.0.0			Enabled

Chapter 4: Legal and Regulatory Information

This chapter provides end user license agreements and regulatory notifications.



Caution

Intentional or unintentional changes or modifications to the equipment must not be made unless under the express consent of the party responsible for compliance. Any such modifications could void the user's authority to operate the equipment and will void the manufacturer's warranty.



Attention

Changements ou modifications Intentionnels ou non de l'équipement ne doivent pas être entrepris sans l'autorisation de l'organisme responsable de la déclaration de conformité. Ces modifications ou changements pourraient invalider le droit de l'utilisateur à utiliser cet appareil et annuleraient la garantie du fabricant.

Compliance standards

This section lists the safety specifications against which cnRanger equipment has been tested and certified. It also describes how to keep RF exposure within safe limits.

cnRanger regulatory compliance

The cnRanger hardware has been tested as follows:

- Compliance to the electrical safety specifications.
- EMC specification type approvals that have been granted.
- Radio regulations that are enforced in various regions.

Regulatory standard that are listed in the [Table 28](#) as follows:

Table 28 : cnRanger compliance specifications

SI No	Product Name	Model	Region	Regulatory Standard's
1	cnRanger 800 BBU	cnRanger 800 BBU	USA	UL 60950-1, FCC part 15 subpart B
			Canada	CAN/CSA C22.2 No. 60950-1-07, RSS-Gen Issue 5
			International	EN 60950-1, IEC 60950-1, EN 303 413, EN301489-1, Draft EN 301489-19
2	SM (Subscriber Station)	cnRanger 101 SM	USA	UL 60950-1, FCC part 15 subpart B, FCC Part 2,27
			Canada	CAN/CSA C22.2 No. 60950-1-07
			International	EN 60950-1, IEC 60950-1, EN301908-1/13, EN301489-1/52
3	RRH (Radio	2 GHz/3 GHz	USA	UL 60950-1, FCC part 15 subpart B, FCC

SI No	Product Name	Model	Region	Regulatory Standard's
	Remote Head)	cnRanger RRH		Part 2,27
			Canada	CAN/CSA C22.2 No. 60950-1-07
			International	EN 60950-1, IEC 60950-1, EN301908-1/14, EN301489-1/50

This device complies with Part 15 of the FCC Rules. Operation is subject to the following two conditions:

- This device may not cause harmful interference.
- This device must accept any interference received, including interference that may cause undesired operation.

Federal Communication Commission Interference Statement

This equipment has been tested and found to comply with the limits for a Class B digital device, pursuant to Part 15 of the FCC Rules. These limits are designed to provide reasonable protection against harmful interference in a residential installation. This equipment generates, uses and can radiate radio frequency energy and, if not installed and used in accordance with the instructions, may cause harmful interference to radio communications. However, there is no guarantee that interference will not occur in a particular installation. If this equipment does cause harmful interference to radio or television reception, which can be determined by turning the equipment off and on, the user is encouraged to try to correct the interference by one of the following measures:

- Reorient or relocate the receiving antenna.
- Increase the separation between the equipment and receiver.
- Connect the equipment into an outlet on a circuit different from that to which the receiver is connected.
- Consult the dealer or an experienced radio/TV technician for help.



NOTE:

FCC Radiation Exposure Statement:

This equipment complies with FCC radiation exposure limits set forth for an uncontrolled environment. This equipment should be installed and operated with minimum distance 60 cm between the radiator & your body.

Human exposure to radio frequency energy

Standards

Relevant standards (USA and EC) applicable when working with RF equipment are:

ANSI IEEE C95.1-2005, IEEE Standard for Safety Levels with Respect to Human Exposure to Radio Frequency Electromagnetic Fields, 3 kHz to 300 GHz.

Council recommendation of 12 July 1999 on the limitation of exposure of the general public to electromagnetic fields (0 Hz to 300 GHz) (1999/519/EC) and respective national regulations.

Directive 2013/35/EU - electromagnetic fields of 26 June 2013 on the minimum health and safety requirements regarding the exposure of workers to the risks arising from physical agents (electromagnetic fields) (20th individual Directive within the meaning of Article 16(1) of Directive 89/391/EEC) and repealing Directive 2004/40/EC.

US FCC limits for the general population. See the FCC web site <http://www.fcc.gov> and the policies, guidelines, and requirements in Part 1 of Title 47 of the Code of Federal Regulations, as well as the guidelines and suggestions for evaluating compliance in FCC OET Bulletin 65.

Health Canada limits for the general population. See the Health Canada web site http://www.hc-sc.gc.ca/ewh-semt/pubs/radiation/99ehd-dhm237/limits-limités_e.html and Safety Code 6.

EN 50383:2002 Basic standard for the calculation and measurement of electromagnetic field strength and SAR related to human exposure from radio base Subscriber Modules and fixed terminal Subscriber Modules for wireless telecommunication systems (110 MHz - 40 GHz).

BS EN 50385:2002 Product standard to demonstrate the compliances of radio base Subscriber Modules and fixed terminal Subscriber Modules for wireless telecommunication systems with the basic restrictions or the reference levels related to human exposure to radio frequency electromagnetic fields (110 MHz - 40 GHz) - general public.

ICNIRP (International Commission on Non-Ionizing Radiation Protection) guidelines for the general public. See the ICNIRP web site <http://www.icnirp.de/> and Guidelines for Limiting Exposure to Time-Varying Electric, Magnetic, and Electromagnetic Fields.

Power density exposure limit

Install the radios for the cnRanger family of wireless solutions so as to provide and maintain the minimum separation distances from all persons as follows:

- For cnRanger 101 SM products deployed in the EU, the minimum safe distance between the equipment and humans is 25cm.
- For 2 GHz cnRanger 220 RRH products deployed in the EU, the minimum safe distance between the equipment and humans is 110cm.
- For cnRanger 800 BBU products deployed in the EU there is no minimum safe distance as the device does not emit radio energy.

The applicable power density exposure limit is 10 W/m² for RF energy in the 2.5 GHz frequency band.

Calculation of power density

Peak power density in the far field of a radio frequency point source is calculated as follows:

The following calculation is based on the ANSI IEEE C95.1-2005 method, as that provides a worst-case analysis. Details of the assessment to EN50383:2002 can be provided, if required.

$$S = \frac{P \cdot G}{4\pi d^2}$$

Where:

S - power density in W/m²

P- maximum average transmit power capability of the radio, in W.

G - total Tx gain as a factor, converted from dB.

d - distance from point source, in m.

Rearranging terms to solve for distance yields:

$$d = \sqrt{\frac{P.G}{4\pi.S}}$$

Calculated distances and power compliance margins

The calculated minimum separation distances, recommended distances and resulting margins for each frequency band and antenna combination is shown in the following tables [Table 29](#) and [Table 30](#). These are conservative distances that includes compliance margins. At these and greater separation distances, the power density from the RF field is below generally accepted limits for the general population.

Explanation of terms used:

Tx burst - maximum average transmit power in burst (Watt)

P - maximum average transmit power capability of the radio (Watt)

G - total transmit gain as a factor, converted from dB

S - power density (W/m²)

d - minimum distance from point source (meters)

The following table lists the power compliance margins for the cnRanger RF device identifiers:

Table 29 : cnRanger radio device identifiers

Device Name	Part Number	FCC ID
cnRanger 101 SM	2LTE-SM-101	Z8H89FT0045
cnRanger 201 SM	3LTE-SM-201	Z8H89FT0060
2 GHz cnRanger 220 RRH	2LTE-RRH-220	Z8H89FT0044
3 GHz cnRanger 210 RRH	3LTE-RRH-210	Z8H89FT0061

Table 30 : cnRanger Power compliance margins, 2.5 GHz, FCC

Device	Channel Bandwidth	Antenna	P (W)	G	S (W/m ²)	d (m)
2 GHz cnRanger 220 RRH	20 MHz	Sector, 17 dBi	3.98	39.8	10	1.12
3 GHz cnRanger 210 RRH	20 MHz	Sector, 17 dBi	3.98	39.8	10	0.6
cnRanger 101 SM	20 MHz	Integrated, 14 dBi	0.398	31.6	10	0.32



Note

Gain of antenna in dBi is $10 \cdot \log(G)$. The regulations requires the power used for the calculations is the maximum power in the transmit burst subject to allowance for source-based time-averaging.

Compliance with radio regulations

The compliance with radio regulations describes about the notifications and the 2.5 GHz regulatory compliance.

Notifications

The notification contains the compliance with the radio regulations that are enforced in various regions.

2.5 GHz regulatory compliance

The cnRanger products comply with the regulations that are enforced in the USA and Europe. The relevant notifications are specified in this section (m).

2.5 GHz FCC notification

End Product Labeling

Figure 22 : cnRanger 800 BBU product labelling

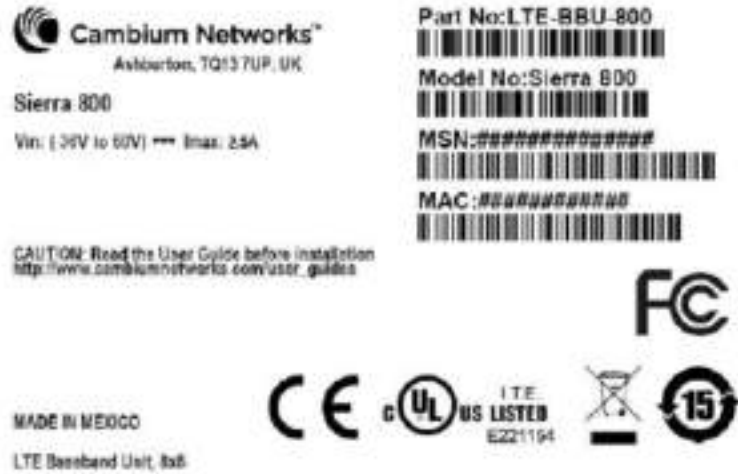

Figure 23 : 2 GHz cnRanger 220 RRH Product Labelling



Figure 24 : cnRanger 101 SM product labelling



Figure 25 : 3 GHz cnRanger 201 SM product labelling



Chapter 5: Installation

This chapter describes how to install and test the hardware for a cnRanger link. It contains the following topics:

- [Safety](#)
- [Installing BBU](#)
- [Installing RRH](#)
- [Installing SM](#)
- [Installing SFP/SFP+ modules on BBU](#)
- [Installing SFP+ modules on RRH](#)
- [Installing a GPS antenna on the BBU](#)
- [Installing PSU for BBU and RRH](#)
- [Installing PSU for SM](#)
- [Installing DC LPU and grounding for RRH](#)

Safety



Warning

To prevent loss of life or physical injury, observe the following safety guidelines. Cambium Networks is not liable for any injury or damage caused during the installation of the cnRanger family. Ensure that only qualified personnel is installing a cnRanger platform link.



Warning :

Hot surface do not touch.



AVERTISSEMENT :

SURFACE CHAUDE. NE PAS TOUCHER.



Warning:

Installation instructions include the following statement or equivalent:

Rack Mount Instructions - The following or similar rack-mount instructions are included with the installation instructions: A) Elevated Operating Ambient - If installed in a closed or multi-unit rack assembly, the operating ambient temperature of the rack environment may be greater than room ambient. Therefore, consideration should be given to installing the equipment in an environment compatible with the maximum ambient temperature (T_{ma}) specified by the manufacturer. B) Reduced Air Flow - Installation of the equipment in a rack should be such that the amount of air flow required for safe operation of the equipment is not compromised. C) Mechanical Loading - Mounting of the equipment in the rack should be such that a hazardous condition is not achieved due to uneven mechanical loading. D) Circuit Overloading - Consideration should be given to the connection of the equipment to the supply circuit and the effect that overloading of the circuits might have on overcurrent protection and supply wiring. Appropriate consideration of equipment nameplate ratings should be used when addressing this concern. E) Reliable Earthing - Reliable earthing of rack-mounted equipment should be maintained. Particular attention should be given to supply connections other than direct connections to the branch circuit (e.g. use of power strips).



AVERTISSEMENT :

Instructions de montage en rack - La déclaration de montage en rack suivante ou des instructions similaires sont fournies avec les instructions d'installation:

A) Fonctionnement à température ambiante élevée - Si ce produit est installé dans un rack fermé ou à plusieurs unités, le fonctionnement à température ambiante de l'environnement du rack peut dépasser la température ambiante de la pièce. Il convient donc d'envisager le montage de l'équipement dans des conditions compatibles avec la température extérieure maximale (T_{ma}) recommandée par le fabricant. B) Diminution du débit d'air - Le matériel doit être installé dans un rack de manière à permettre le débit d'air nécessaire au bon fonctionnement du matériel. C) Charge mécanique - La fixation de l'équipement dans le rack a pour but de ne pas créer de situations dangereuses en raison d'une charge mécanique inégale. D) Suspension des circuits - Le branchement de l'équipement au circuit d'alimentation et les risques de surcharge des circuits sur la détection des surintensités et le câblage électrique doivent être pris en considération. Il faut prendre en compte les valeurs nominales de l'équipement pour aborder cette question. E) Raccordement à la terre fiable - Un raccord à la terre fiable de l'équipement assemblé en rack est à maintenir. Les connexions d'alimentation ne devant pas être directement associées à une dérivation doivent faire l'objet de toute l'attention requise (par exemple, l'utilisation de multiprises).

Hazardous locations



Warning

When installing the cnRanger product variants in hazardous locations, follow the instructions contained in the cnRanger Series Hazardous Location Guide (supplied in box with the products), in addition to the instructions in this user guide.

Power lines

Exercise extreme care to be taken while working near the power lines.

Working at heights

Exercise extreme care to be taken while working at heights.

Power supply

Always use one of the Cambium Networks cnRanger platform family power supply units (PSU) to power the ODU. Failure to use a Cambium Networks supplied PoE results in equipment damage and invalidates the safety certification, this may cause a safety hazard.

Grounding and protective earth

The Outdoor Unit (ODU) must be properly grounded to protect against lightning. It is the user's responsibility to install the equipment in accordance with national regulations. In the USA follow the requirements of the National Electrical code NFPA 70-2005 and 780-2004 installation of lightning protection systems. In Canada, follow Section 54 of the Canadian Electrical Code.

These codes describes correct installation procedures for:

- grounding the outdoor unit
- mast
- lead-in wire
- discharge unit
- size of grounding
- conductors and connection requirements for grounding electrodes

Other regulations may apply in different countries and therefore it is recommended that installation of the outdoor unit must be contracted to a professional installer.

Powering down before servicing

Before servicing cnRanger equipment, always switch off the power supply and unplug it from the PSU.

Do not disconnect the DC power cables connected to ODU while the PSU is connected to the power supply. Always remove the AC or DC input power from the PSU before disconnecting.

Primary disconnect device

The cnRanger power supply is the primary disconnect device.

External cables

Safety may be compromised if outdoor rated cables are not used for connections that will be exposed to the outdoor environment. Use recommended outdoor rated optical and DC cables.

Laser safety while using optical SFP modules

- SFP/SFP+ modules used in cnRanger equipment use Class-1 laser which emit invisible radiation.
- Do not stare into open ports of optical Module or the Cable.
- Always follow precaution as there is risk of serious injury if the eyes are exposed.

RF exposure near the antenna

Strong Radio Frequency (RF) fields is close to the antenna when the transmitter is ON. Always turn off the power to the ODU before undertaking maintenance activities in front of the antenna.

Minimum separation distances

Ensure that personnel are not exposed to unsafe levels of RF energy. The units start to radiate RF energy as soon as they are powered up. Donot work in front of the antenna when the ODU is powered. Install the ODUs so as to provide the minimum separation distances.

Grounding and lightning protection requirements

Ensure that the installation meets the requirements defined in [Installation](#).

Grounding cable installation methods

To provide effective protection against lightning induced surges, follow the below requirements:

- Grounding conductor runs are as short, straight and smooth as possible, with bends and curves kept to a minimum.
- Do not install grounding cables with drip loops.
- All bends must have a minimum radius of 200 mm (8 in) and a minimum angle of 90°. A diagonal run is preferable to a bend, even though it does not follow the contour or run parallel to the supporting structure.
- All bends, curves and connections must be routed towards the grounding electrode system, ground rod/ground bar.
- Securely fasten the grounding conductors.
- Do not use braided grounding conductors.
- Use approved bonding techniques to connect dissimilar metals.

Siting ODUs and antennas

ODUs and external antennas are not designed to survive direct lightning strikes. For this reason they must be installed in Zone B as defined in Lightning protection zones. Mounting in Zone A may put equipment, structures and life at risk.

Thermal safety

The cnRanger 800 BBU and 2 GHz/3 GHz cnRanger RRH may be hot to the touch when in operation. The cnRanger 800 BBU must not be operated in ambient temperatures exceeding 40°C unless mounted in a restricted access location. Select a location where the cnRanger 800 BBU can operate within safe ambient temperature limits.

If a restricted access location is not available, confirm that the ambient temperature never exceeds 40°C. At this ambient temperature, the external metal cases of the cnRanger 800 BBU will not exceed the temperature limit of 70°C. If a restricted access location (as defined in EN 90650-1) is available, confirm that the ambient temperature never exceeds 55°C. At this ambient temperature, the temperature of the external metal case of the cnRanger 800 BBU may exceed the touch temperature limit of 70°C, but will be less than the maximum operating temperature of 95°C.



Note

A restricted access location is defined (in EN 90650-1) as one where access may only be gained by use of a tool or lock and key, or other means of security, and access is controlled by the authority responsible for the location. Access must only be gained by persons who have been instructed about the reasons for the restrictions applied to the location and about any precautions that must be taken. Examples of permissible restricted access locations are a lockable equipment room or a lockable cabinet.

Installing cnRanger 800 BBU

Mounting

Install cnRanger 800 BBU on a rack as follows:

1. Assemble the bracket on both sides (left side and right side) with M4 fastener using torque screwdriver with 3.0Nm of torque.



2. Use universal 19-inch cabinet, snap, and M6 cage nut at three square slots of 1U on both side of the rack, to install the cnRanger 800 BBU.
3. Attach the cnRanger 800 BBU to the rack using the six mounting screws with 3.0Nm of torque.



4. Mounted cnRanger 800 BBU is ready.



Powering up

1. Power the cnRanger 800 BBU unit. Refer to [Installing PSU for BBU and RRH](#) to power up cnRanger 800 BBU unit.
2. Check that the power LED on the cnRanger 800 BBU illuminates.
3. Connect an Ethernet cable from the PC to the ETH2 port on cnRanger 800 BBU and confirm the Ethernet activity LED blinks.

Installing 2 GHz cnRanger 220 RRH

Mounting to 2LTE-ANT-90

Follow the below instructions to mount RRH to 2LTE-ANT-90 antenna:

1. Loosen the M8 bolts and tighten the bolt by applying 1Nm torque.



2. Place the radio mounting clamp to radio holder clamp, insert M8x12mm bolt, and tighten by applying 4Nm torque.



3. Assemble the N type cable to 2 GHz cnRanger 220 RRH.



4. Place the radio mounting clamp to radio holder clamp, insert M8x12mm bolt, and tighten by applying 4 Nm torque.



5. Place 2 GHz cnRanger 220 RRH product to the rear side of antenna.



6. Place M8 nut to the 2 GHz cnRanger 220 RRH product and tighten by applying 5 Nm torque.



7. Connect N type cable of 2 GHz cnRanger 220 RRH product to antenna L-L and R-R.



8. Connect the grounding cable to 2 GHz cnRanger 220 RRH and tighten the screw by applying 2.5Nm torque. Slightly tilt the mounting bracket to fix the 2 GHz cnRanger 220 RRH.



9. Assemble the antenna and the 2 GHz cnRanger 220 RRH integrated product to the pole and tighten by applying 8 Nm torque.



10. The antenna can be adjusted between $+5^{\circ}$ to -10° . The electrical down tilt is 2° .



Installing 3 GHz cnRanger 210 RRH

Mounting to 3LTE-ANT-90

Follow the below instructions to mount RRH to 3LTE-ANT-90 antenna:

1. Loosen the M10 bolts and tighten the bolt by applying 1Nm torque.



2. Place the radio mounting clamp to radio holder clamp and tighten M8 Nuts to a torque of 6Nm..

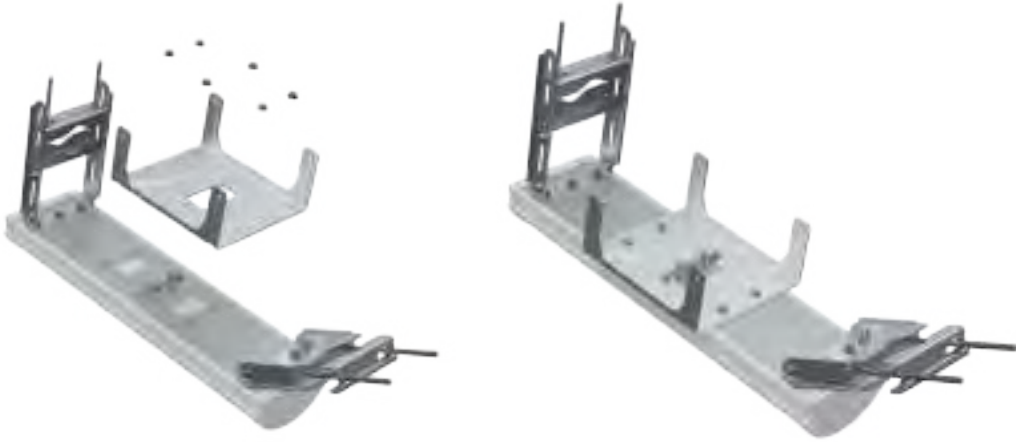

3. Connect N type cable of 3 GHz cnRanger 210 RRH product to antenna L-L and R-R by applying a Coupling torque 135Ncm (12 lbs-in).



4. Place 3 GHz cnRanger 210 RRH to the bracket on the antenna. Hand tighten the M5 bolts to help align all four M5 bolts.



5. Assemble the N type cable to 3 GHz cnRanger 210 RRH by applying a Coupling torque 135Ncm (12 lbs-in).



6. Connect the cable glands.



7. Connect the grounding cable to 3 GHz cnRanger 210 RRH as shown and tighten the screw to 2.5Nm torque.



8. Once the antenna and the 3 GHz cnRanger 210 RRH integrated pole mount units are ready to mount to the pole.



9. Assemble the antenna and the RRH integrated product to the pole and tighten by applying 8Nm torque.



10. The antenna can be adjusted between $+5^\circ$ to -10° . The electrical down tilt is 2° .



Mounting 2 GHz cnRanger 220 RRH on the pole

Mount 2 GHz cnRanger 220 RRH on the pole to connect with N025000D001A antenna as follows:

1. Place sheet metal clamp to 2 GHz cnRanger 220 RRH and tighten with M5 screws by applying 5 Nm torque max.



2. Assemble M8 bolts to aluminum clamp and tighten with M8 nut by applying 3 Nm torque max.



3. Assemble aluminum clamp to 2 GHz cnRanger 220 RRH and tighten with M8 bolt by applying 5 Nm torque max.



4. Assemble pole holder clamp to 2 GHz cnRanger 220 RRH.



5. Assemble 2 GHz cnRanger 220 RRH unit to the pole. Align a pole holder clamp as per the pole size and tighten with M8 nut by applying 8 Nm torque.



6. Assemble 2 GHz cnRanger 220 RRH to the pole as shown in below figure.



Powering up

2 GHz cnRanger 220 RRH is powered through an AC power injector installed at the bottom of the tower. DC LPUs and grounding guidelines need to be followed for powering up 2 GHz cnRanger 220 RRH.

Connect ground at multiple points on the mast is shown in [Figure 26](#).

Instruction for using the Raycap Junction box refer [RKEDC-8465-PF-48 \(320-0627\)](#) and for surge protection refer [RBMDC-1113-BDU-48](#).



Note

The power cable connecting from the **Junction box** to the **DC surge protection box** will not be supplied by Cambium Networks. User needs to procure their own outdoor AWG16 cable with metal braiding.

Figure 26 : Powering up 2 GHz cnRanger 220 RRH

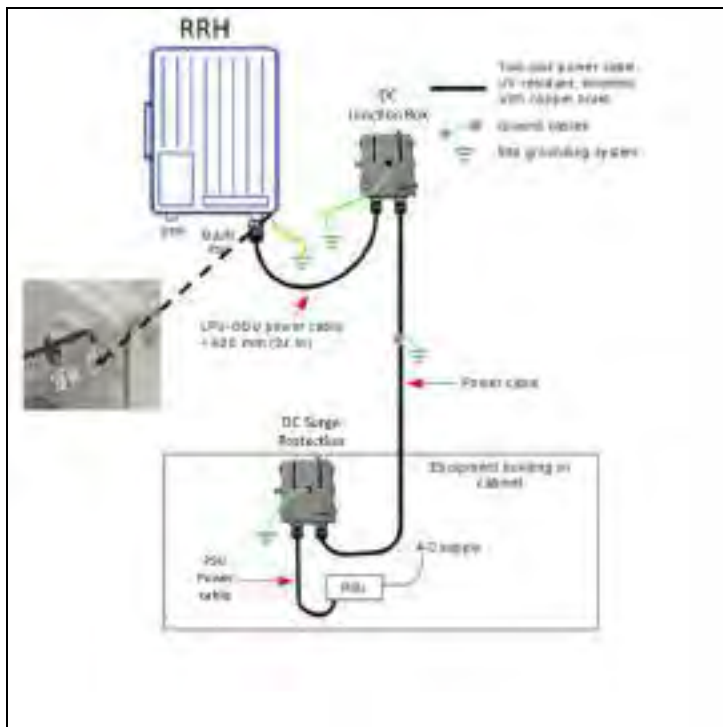

1. Connect the power connector to 2 GHz cnRanger 220 RRH



2. Grounding 2 GHz cnRanger 220 RRH



Connecting 2 GHz cnRanger 220 RRH power cable to junction box

Follow the below instructions to connect 2 GHz cnRanger 220 RRH power cable to the junction box:

1. Connect gray cable (-48V, -) to the -48V connector to the junction box
2. Connect blue cable (-48V_GND, +) to RTN connector to the junction box
3. Connect silver wire (chassis) to GND connector to the junction box

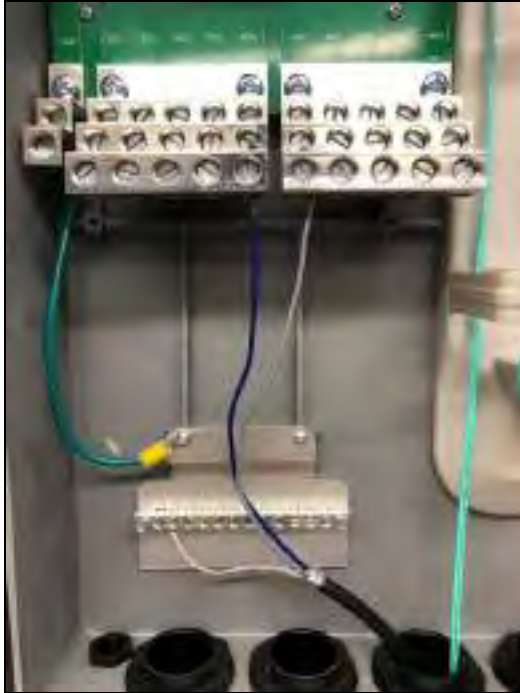

Connecting junction box to 2 GHz cnRanger 220 RRH

Connect Junction Box to 2 GHz cnRanger 220 RRH using DC power cable (N000000L130A) as shown in Figure 27. Cable comes with pre-crimped 3- wire terminal block on one end to connect to Junction Box and 2 GHz cnRanger 220 RRH power connector on the other end.

Figure 27 : DC Power Cable



Table 31 : LPU RRH power Cable

Cambium description	Cambium part number
2 GHz cnRanger 220 RRH DC power cable 2-meter	N000000L130A

Installing cnRanger 101 SM

Mounting

1. Assemble the radio to the pole mounting bracket.



2. Secure pole mounting bracket with M8 nut and bolt by applying 3.0 Nm torque.



3. Insert hose clamps through pole mounting bracket and clamp to pole by applying 3.0 Nm torque.



4. Remove cap and connect RJ 45 cable to the radio.



5. Align radio to required angle by tilting up and down. The maximum radio tilting angle is 34°, with an incremental of 10°. Secure radio by applying 5.0 Nm torque.



Installing cnRanger 201 SM

Assemble the pole mount bracket to the dish mounting bracket as follows:

1. Insert the the two M8 x 120 mm bolts though the pole mounting bracket and tighten the nuts by applying 10 Nm torque.
2. Attach the bracket to the pole mounting with the two M8 screws by applying 5 Nm torque.

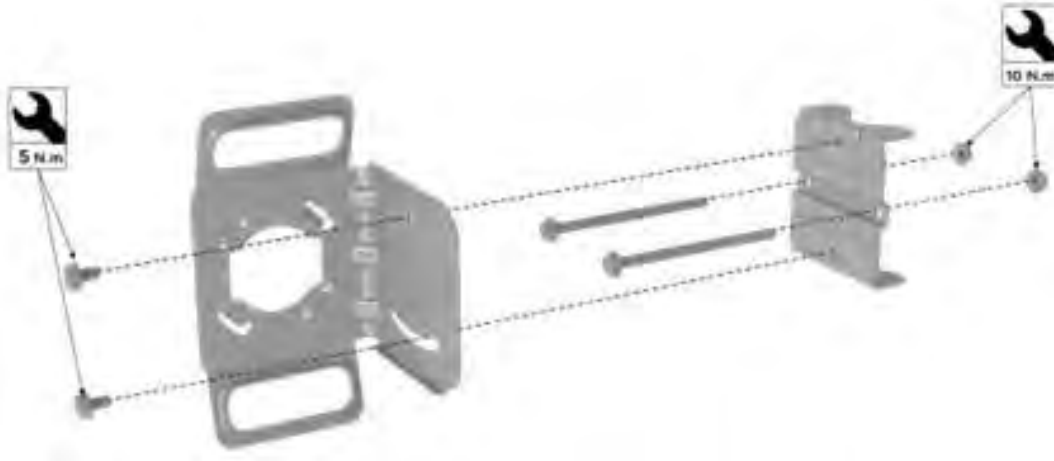

3. Assemble the dish to pole mounting bracket. Rotate and align dish tabs to the pole bracket assembly.



4. Assemble the radio to dish assembly as shown below:
 - a. ■ Insert the the radio (1) through the dish and bracket (2).
 - b. ■ Insert rear housing (3) and secure with two screws (4) by applying 2 Nm torque to lock the assembly together.

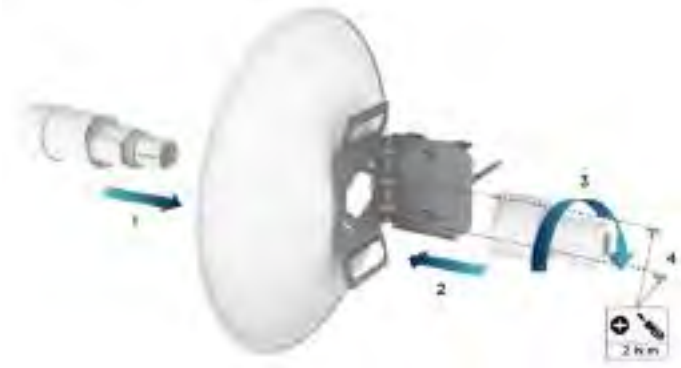

5. Attach Dish assembly to pole mounting and secure with M8 nuts by applying 10 Nm torque.



6. Remove cap and connect RJ45 cable to the radio.



7. Align radio to required angle by tilting up and down. The maximum radio tilting angle is 320° , with an incremental of 10° . Secure radio by applying 8.0 Nm torque.



Powering up

Follow the below procedure to power up the device using PoE adapter as shown in [Installation of Tyndall 101 to PoE adapter](#).

1. Connect the Ethernet cable from Eth1/PoE-IN of cnRanger 101 SM to the PoE port of Gigabit Data + Power.
2. Connect an Ethernet cable from your LAN or computer to the Gigabit data port of the PoE adapter.

Figure 28 : Installation of Tyndall 101 to PoE adapter



3. Connect the power cord to the adapter, and then plug the power cord into a power outlet as shown in Installation of adapter to power outlet. Once powered ON, the Power LED should illuminate continuously on the PoE Adapter.

Figure 29 : Installation of adapter to power outlet



Note

Shielded Category 5 (or above) cabling should be used for all outdoor wired Ethernet connections and should be grounded through the AC ground of the PoE.

Installing SFP/SFP+ modules on BBU

Inserting SFP+ module

1. Slide the module into the CPRI port gently.
2. Press the SFP+ module gently until it is firmly seated in the port.



Removing SFP+ module

1. Pull the bale-clasp latch with index finger towards downward direction and gently pull the SFP+ module from the port.



2. Connect CPRI Fiber optic cables.



Installing SFP+ modules on 2 GHz cnRanger 220 RRH

1. Open the back cover on the 2 GHz cnRanger 220 RRH.

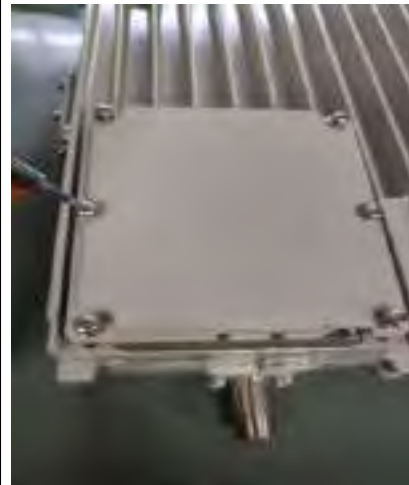

2. Insert SFP+ Module in optical fiber port.



3. Use RRH CPRI optical fiber (N000000L131A) cable to connect from junction box to 2 GHz cnRanger 220 RRH.



4. Open the cap on the weather proofing gland on the external port.



5. Remove LC patch cord connector clip before insertint the fiber optic cable into the weather proofing gland.

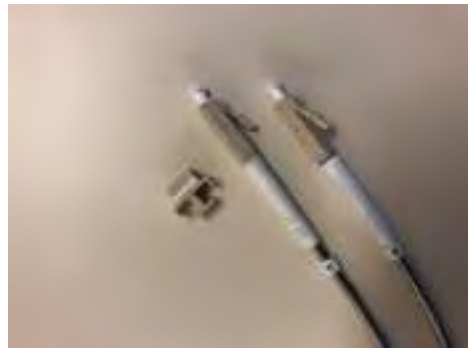

6. Insert the fiber cable into the weather proofing gland one fiber strand at a time.



7. Put LC connector clip back on the cable.



8. Create a service loop on the fiber cable and tighten the weather proofing gland.
9. Make sure 2 GHz cnRanger 220 RRH back plate is installed back on the unit.



Installing a GPS antenna on the cnRanger 800 BBU

The following information describes the recommended tools and procedures to mount the GPS antenna.

Supported GPS antennas

Table 32 :Supported GPS antenna

Description	Part Number
External GPS Antenna	N000900L030A
External GPS Antenna	N000900L005A





- Connect GPS Antenna to GPS_ANT port on the cnRanger 800 BBU.
- Use an extension cable if longer length cable is required.
- Maximum cable length supported is 5 meters.



Installing PSU for cnRanger 800 BBU and 2 GHz cnRanger 220 RRH

1. Connect AC terminals L-N-E on the PSU as shown in AC terminals to PSU connection.
2. Connect DC output to -V, +V terminals on the PSU as shown in FDC output to PSU connections.

<p>Figure 30 : AC terminals to PSU connection</p>	<p>Figure 31 : FDC output to PSU connections</p>
	

3. Connect a 4-pin terminal block (supplied with cnRanger 800 BBU) as per the connectivity. Attach cable cord to the 4-pin terminal block.

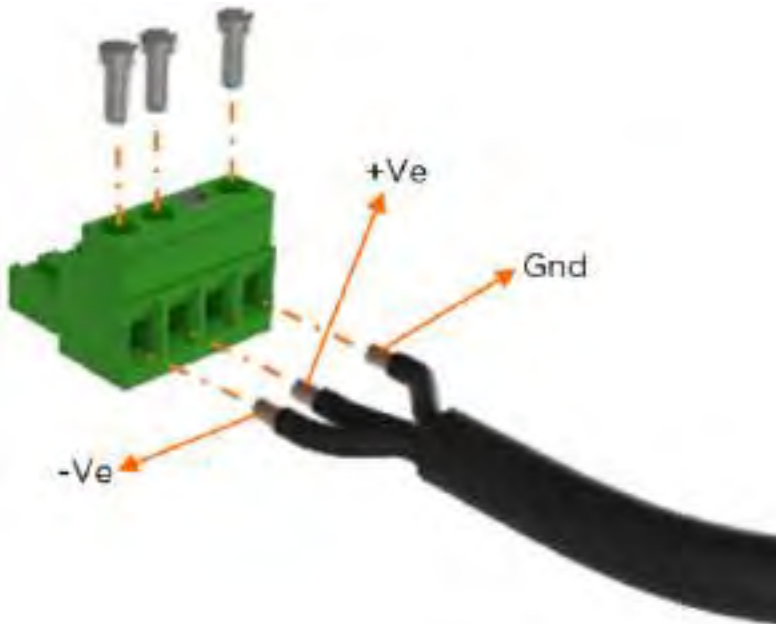

4. Insert 4-pin terminal block into the cnRanger 800 BBU power connector on the rear side.



5. Connect both the cnRanger 800 BBU and PSU ground terminals  to protective earth conductor with an AWG10 -16 wire. All the terminals on the cnRanger 800 BBU and PSU must be connected as per the correct polarity.
6. Turn off the AC mains supply before servicing or disconnecting power conductors from the cnRanger 800 BBU or PSU.



Warning

cnRanger 800 BBU and PSU contain unprotected conductors carrying lethally high voltage and improper handling will result in electric shock or serious burns.

Installing PSU for cnRanger 101 SM

Follow the below procedure to power up cnRanger 101 SM using PoE adapter as shown in [Figure 32](#).

1. Connect the Ethernet cable from Eth1/PoE-IN of cnRanger 101 SM to the PoE port of Gigabit Data + Power.
2. Connect the Ethernet cable from your LAN or computer to the Gigabit Data port of the PoE adapter.

Figure 32 : Installation of 2 GHz cnRanger 220 RRH to PoE adapter



3. Connect the power cord to the adapter, and then plug the power cord into a power outlet as shown in [Installation of adapter to power outlet](#).
4. Once powered ON, the Power LED should illuminate continuously on the PoE Adapter.

Figure 33 : Installation of adapter to power outlet



Note

Use shielded category 5 (or above) cables for all the outdoor wired Ethernet connections and ground through the AC ground of the PoE.

Chapter 6: Configuration

This chapter describes how to use the GUI to configure cnRanger devices. This chapter contains the following topics:

- [Management PC network configuration](#)
- [Using the web interface](#)
- [cnRanger 800 BBU setup](#)
- [Tyndall setup](#)

Management PC network configuration

The cnRanger 800 BBU and 2 GHz/3 GHz cnRanger SM products provide a default address for reliably accessing the management screen from the local Ethernet port. This method is available even after provisioning application specific IP addresses on both the devices.



Note:

2 GHz/3 GHz cnRanger RRH devices do not have a user interface Ethernet port. All Palisade control is performed via the cnRanger 800 BBU.

Configure the management PC wired Ethernet interface with the following IPv4 parameters:

- IP Address: choose an IP address on the 169.254.0.0/16 subnet avoiding 169.254.0.0, 169.254.1.1, and 169.254.255.255. Address 169.254.1.3 is commonly chosen.
- Subnet Mask: 255.255.0.0
- Default gateway and DNS addresses are not required.

Connecting PC to cnRanger device and powering up

cnRanger 800 BBU

1. Check that the cnRanger 800 BBU device is properly connected to the power supply unit. The “Power” light will illuminate red when power is applied.
2. Connect the PC Ethernet port either the ETH2 port or the ETH1 port of the cnRanger 800 BBU front panel. A green ETH2 or ETH1 LED indicates that the cnRanger 800 BBU GUI may now be accessed via that interface.

cnRanger 101 SM

1. Ensure that the cnRanger 101 SM and the PSU are connected.
2. Connect the Ethernet port of the PC to the LAN port of the PSU using a standard Ethernet cable (not crossed).
3. Supply power to the PSU. The green “Power” LED should illuminate continuously.
4. LED indication of bootup and readiness for config.

Using the web interface

1. Open a web browser on the management PC.
2. Go to the URL <http://169.254.1.1>. This will display the login patch for the cnRanger 800 BBU or 2 GHz/3 GHz cnRanger SM device.
3. In the login box enter Username (default: admin) and Password (default: admin).
4. Click **Sign In**.

Figure 34 : cnRanger 800 BBU Login page



The cnRanger 800 BBU and 2 GHz/3 GHz cnRanger SM GUI share a common layout. The main menu is on the top left side of the screen as shown in [cnRanger 800 BBU main menu layout](#).

Figure 35 : cnRanger 800 BBU main menu layout

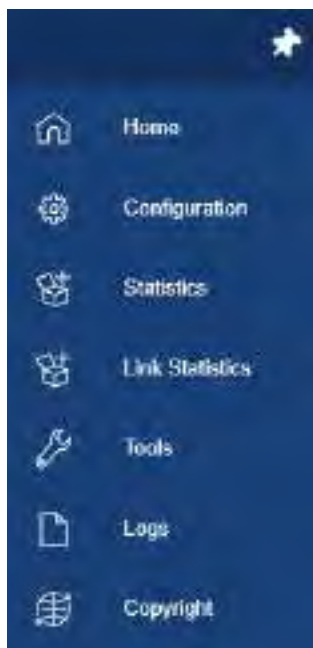

The upper right portion of the GUI contains the system reboot and profile/login controls.



While performing the configuration operations additional **Undo** and **Save** buttons also appear in the upper right portion of the GUI.



cnRanger 800 BBU setup

Configuration of the cnRanger 800 BBU is performed across multiple GUI screens provided by the device. This section provides a detailed description of the screens and parameters accessible on them.

General configuration

The **Configuration > General** page contains basic site definition parameters.

Figure 36 : cnRanger 800 BBU general page

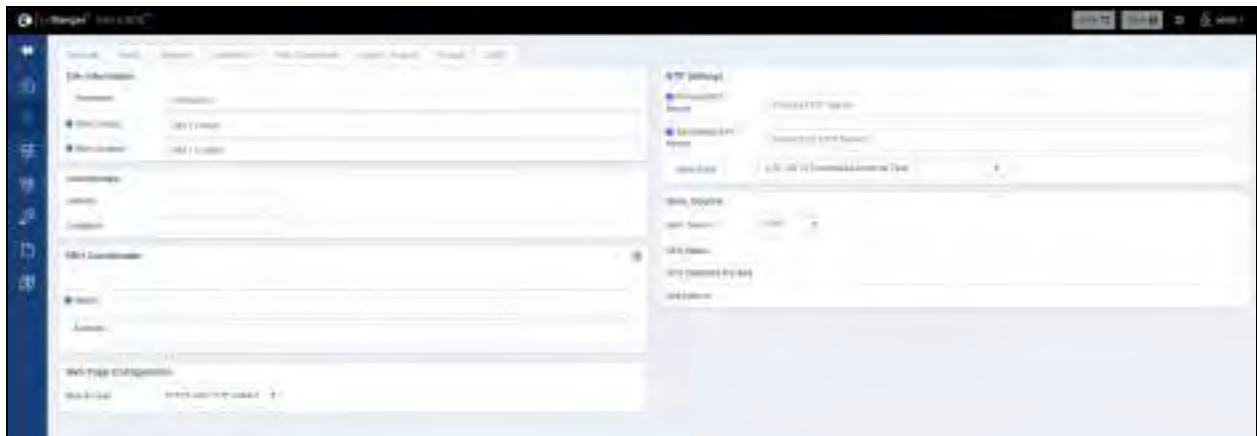

Table 33 : Configuration > General page > Site Information parameters

Parameter	Description
Hostname	Specify a string to associate with the physical module. This value defaults to the product short text name (e.g. S800) followed by the lower three octets of the Ethernet MAC address.
Site Contact	Enter contact information for the device administrator.
Site Location	Enter information about the physical location of the device.

Table 34 : Configuration > General page > Coordinates parameters

Parameter	Description
Latitude	Latitude of the corresponding 2 GHz/3 GHz cnRanger RRH in decimal degrees. If GPS sync is configured and available this field will be populated automatically.
Longitude	Longitude of the corresponding 2 GHz/3 GHz cnRanger RRH in decimal degrees. If GPS sync is configured and available this field will be populated automatically.
Height	Height of the corresponding 2 GHz/3 GHz cnRanger RRH in meters.

Parameter	Description
Azimuth	Azimuth of the corresponding 2 GHz/3 GHz cnRanger RRH in decimal degrees.

Table 35 : Configuration > General page > NTP Settings parameters

Parameter	Description
Primary NTP Server	Provide NTP server hostname or IP address to synchronize time of day to NTP.
Secondary NTP Server	Provide NTP server hostname or IP address to act as a backup for NTP service.
Time Zone	Set time zone for BBU to be used for NTP client operation.

Table 36 : Configuration > General page > Sync Source parameters

Parameter	Description
Sync Source	Set synchronization source to GPS or free run. GPS should be selected for any cnRanger 800 BBU device operating in the vicinity of neighboring LTE eNodeB equipment.
GPS Status	Shows the state of the GPS synchronization (Up or Down).
GPS Satellites Tracked	Shows the number of GPS satellites currently in a tracking state by GPS receiver.

Radio configuration

The cnRanger 800 BBU **Configuration > Radio** page includes parameters of both per-cnRanger 800 BBU site and per 2 GHz cnRanger 220 RRH radio carrier.

- Carrier specific parameters will be found underneath the carrier identifier (e.g. RRH-1).
- The configuration applied to RRH-1 will be used with the cnRanger Palisade RRH plugged into CPRI port 1, RRH-2 with port 2, etc.

Figure 37 : Configuration > Radio page

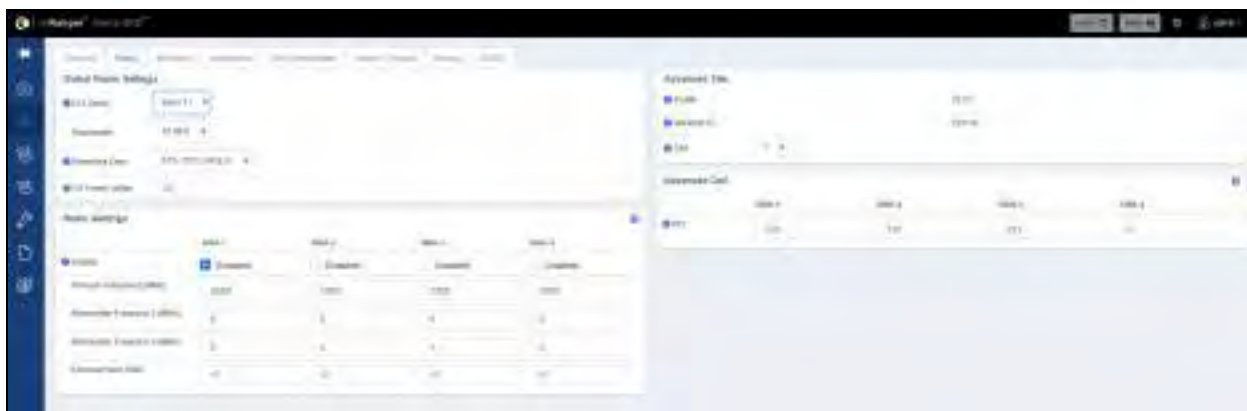

Table 37 : Configuration > Radio page > Global Radio Settings and Radio settings parameters

Parameter	Description
Global Radio Settings	
LTE Band	3GPP band number applied to the LTE carrier band such as 38, 40, 41, 42, 43, and 48.

Parameter	Description
Bandwidth	Carrier bandwidth – 10, 15, or 20 Mhz.
Downlink Data	Selects the LTE frame configuration which determines the number of subframes allocated to downlink and uplink. The ratio is expressed in terms of subframe ratio. It does not take into account any higher downlink throughput capabilities in comparison with the uplink. This maps directly to 3GPP uplink-downlink configuration index.
Radio Settings	
Enable Carrier	If selected the carrier will be switched to an administratively enabled state. This means the carrier will attempt to go into service. If unselected the carrier will not attempt to go into service.
Frequency	Center frequency to apply to LTE carrier, specified in 0.1 MHz increments. The UI displays the minimum and maximum carrier frequency depending on the LTE Band selection.
Transmit Power	Per branch transmit power to be applied in dBm. The UI also displays the minimum and maximum allowable transmit power depending on the type of RRH connected to the BBU port.
External Gain	External gain value (e.g. antenna gain) added after the RRH.

Additional advanced parameters may be revealed by selecting the **Advanced Parameters** button. These only need to be modified in order to support optional network configuration strategies called out in other sections of this User Guide.

Table 38 : Configuration > Radio page > Advanced Site parameters

Parameter	Description
SSF (Special Subframe Format)	Specifies the 3GPP defined special subframe format to be used in the TDD frame configuration. This affects the number of symbols allocated to the downlink, guard period, and uplink during special subframes. This parameter may need to be adjusted due to maximum cell radius size or due to interference compatibility with other nearby LTE TDD systems.
PCI	This parameter selects PCI values to be assigned to each cell on the cnRanger 800 BBU. It affects both the LTE primary and secondary synchronization channel signal formats. Adjacent cells utilizing the same carrier frequency should be configured with different primary and secondary signals. The cnRanger 800 BBU software selects default values based on cnRanger 800 BBU Ethernet MAC address and selects appropriate values to provide proper spacing between cells on this cnRanger 800 BBU. It is possible that these values will need to be modified in order to correct PCI collisions with adjacent cnRanger 800 BBU devices.

Network configuration

The cnRanger 800 BBU **Configuration > Network** page provides system configuration controls over the cnRanger 800 BBU backhaul and the subscriber IP address pool.

Figure 38 : Configuration > Network page

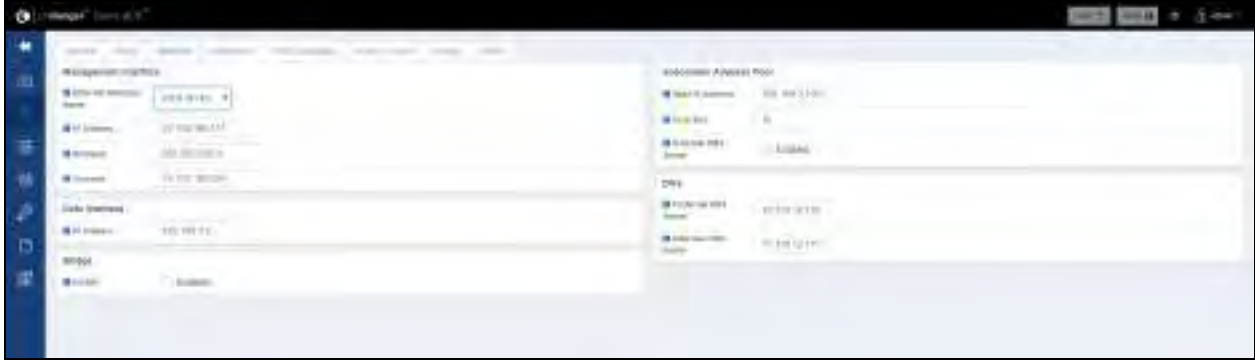

Table 39 : Configuration > Network page > Management Interface parameters

Parameter	Description
Ethernet interface	Ethernet Interfaces exist to allow the separation of log delivery from administrative access from other services.
IP Address	IP address to be used for management traffic allocated separately from the Data Interface IP address to allow for separation of management and data traffic in the network.
Netmask	Netmask of the management interface. This netmask is also applied to the Data Interface.
Gateway	Apply default gateway to the Management Interface. This gateway is also utilized for traffic from the Data Interface.

Table 40 : Configuration > Network page > Data Interface parameters

Parameter	Description
IP Address	IP address of the Data Interface. This allows for separation of data and management traffic passing through the operators network.

Table 41: Configuration> Network page > DNS parameters

Parameter	Description
Preferred DNS Server	IP address of preferred DNS server.
Alternate DNS Server	IP address of DNS server to be used if Preferred DNS Server is not available.

This panel controls the IP address assignment to SMs that attach to this cnRanger 800 BBU. The addresses pool is a part of the Data Interface IP subnet or a distinct subnet.

Table 42 : Subscriber address pool parameters

Parameter	Description
Start IP Address	Beginning of the dynamic SM IP address range.
Pool Size	Number of IP addresses in the dynamic SM IP address range. These will be allocated consecutively from the Start IP address.
Override DNS Server	If enabled the operator may specify a DNS server other than that already assigned to the cnRanger 800 BBU. If disabled, the SM will be assigned the same DNS server settings as the cnRanger 800 BBU is configured with.
Preferred DNS	IP address of preferred DNS server

Parameter	Description
Server	
Alternate DNS Server	IP address of DNS server to be used when Preferred DNS Server is not available.

cnMaestro configuration

The cnRanger 800 BBU **Configuration > cnMaestro** page is used for connectivity and onboarding.

To onboard your cnRanger 800 BBU to cnMaestro using Cambium ID the following steps should be performed.

1. Enable remote management.
2. Set the URL of your cnMaestro service. cnRanger 800 BBU will default to the Cloud cnMaestro service provided by Cambium Networks (<https://cloud.cambiumnetworks.com>).
3. Enter operator Cambium ID and onboarding key.
4. Click **Save**.

Figure 39 : Configuration > cnMaestro page



Table 43 : Configuration > cnMaestro page parameters

Parameter	Description
Remote Management	This field Enables/Disables cnMaestro remote management.
cnMaestro URL	Enter the cloud cnMaestro URL e.g. https://cloud.cambiumnetworks.com Or cnMaestro on premises URL.
Connection Status	This field indicates cnMaestro connectivity status.
Cambium ID	Enter operator Cambium ID used for cnMaestro onboarding.
Onboarding Key	Enter cnMaestro device Onboarding Key.

Parameter	Description
Account ID	Shows operator Account ID.
Device Agent Version	Shows device agent software version.

SIM credentials configuration

The SIM credentials configuration is used to manage the following

- Import and delete SIM security credentials.
- To set and delete static IP addresses on a per-IMSI basis.
- SMs attempting to attach to a cnRanger 800 BBU must have their SIM card credentials provisioned at the cnRanger 800 BBU before the attach process will be successful.

Figure 40 : SIM credentials configuration page



Table 44 : configuration > SIM Credentials > Import and Delete IMSI parameters

Parameter	Description
Import From	Select whether to import from a file (via Choose File button) or via URL.
Import File / Import URL	Select file or specify URL to import.
Start Import	Click to initiate the import process.
IMSI	Specifies the IMSI of the SIM card to delete from the system.
Delete	Deletes the SIM card specified by the IMSI field.
Delete All IMSIs	Clears the SIM card database.

Table 45 : configuration > SIM Credentials > SM List parameters

Parameter	Description
IMSI	IMSI value of the provisioned SIM card
Status	Status of the SIM card (currently always “Enabled”)

Table 46 : configuration > SIM Credentials > Set Static IP and Remove Static IP parameters

Parameter	Description
IMSI	IMSI to which a static IP address is associated

Parameter	Description
IP Address	IP address to statically assign to a IMSI
Add	Associate the specified IP address to the specified IMSI
Remove	Remove all static IP address association from the specified IMSI

Table 47 : configuration > SIM Credentials > Configured Subscribers parameters

Parameter	Description
IMSI	IMSI associated with the static IP address
IP Address	Statically assigned IP address

Import/Export configuration

Navigate to **Configuration > Import/Export** page to import or export cnRanger 800 BBU configuration files. These files are stored in a custom JSON format.

Figure 41 : Configuration > Import / Export page



Table 48 : Configuration > Import/Export page parameters

Parameter	Description
Import From	Specifies to import from a file or URL.
Import File/URL	Choose the File (via Choose File button) or URL containing the configuration.
Import	click to initiate the import process.
Export	Click to initiate the export process resulting in a downloaded file via the web browser.

Debug configuration

Navigate to **Configuration > Debug** for managing the level of debug output for various cnRanger 800 BBU functions. This should only be used in coordination with Cambium Networks customer support.

Figure 42 : Configuration > Debug page



Table 49 : Configuration > Debug page parameters

Parameter	Description
Minimum Severity Level	Pull down containing supported debug log detail levels.
Max Debug File Size	File size limit after which log files will rotate.
Log Rotate Count	The number of log files the system will keep for the given area.

CBRS

Navigate to **Configuration > CBRS** for managing the level of CBRS output for various cnRanger 800 BBU functions. This should only be used in coordination with Cambium Networks customer support.

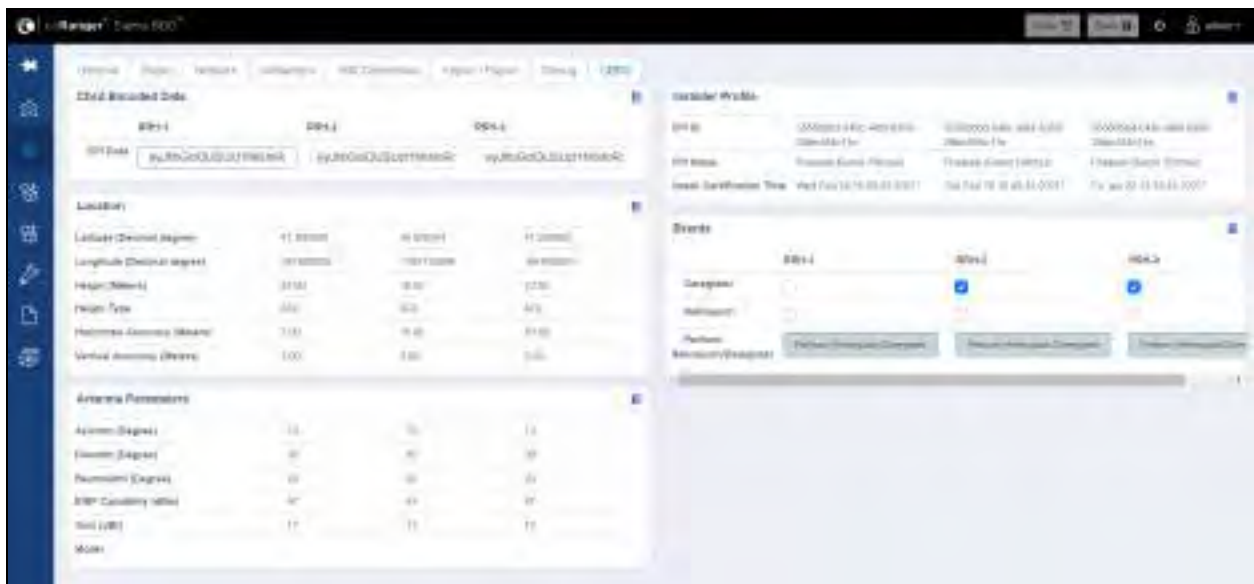

Table 50 : Configuration > CBRS page > Cbsd Encoded Data

Parameter	Description
CPI Data	Displays the details of Certified Professional Installer data.

Table 51 : Configuration > CBRS page > Location

Parameter	Description
Latitude (Decimal degree)	Latitude of the device antenna location in degrees.
Longitude (Decimal degree)	Longitude of the device antenna location in degrees.
Height (Meters)	Device antenna height in meters.
Height Type	Should be AGL or AMSL as follows: <ul style="list-style-type: none"> • AGL height is measured relative to the ground level. • AMSL height is measured relative to the mean sea level.
Horizontal Accuracy (Meters)	A positive number in meters to indicate the accuracy of the device antenna horizontal location.
Vertical Accuracy (Meters)	A positive number in meters to indicate the accuracy of the device antenna vertical location.

Table 52 : Configuration > CBRS page > Antenna Parameters

Parameter	Description
Azimuth (Degree)	Boresight direction of the horizontal plane of the antenna in degrees with respect to true north.
Downtilt (Degree)	Antenna down tilt in degrees.
Beamwidth (Degree)	3-dB antenna beam width of the antenna in the horizontal-plane in degrees.
EIRP Capability (dBm)	Equivalent, Isotropically Radiated Power (EIRP) the maximum amount of power that could be radiated from an antenna in dBm.
Gain (dBi)	Peak gain of integrated antenna in dBi.

Table 53 : Configuration > CBRS page > Installer Profile

Parameter	Description
CPI ID	CPI's (Certified Professional Installer) ID.
CPI Name	CPI's Registered Name.
Install Certification Time	Displays the time and date of certificate installation.

Table 54 : Configuration > CBRS page > Events

Parameter	Description
Deregister	Allows to deregister device (single or multiple)
Relinquish	Allows to re-start the CBRS procedure from UNREGISTERED state.
Perform Relinquish/Deregister	Allows to Deregister/Relinquish the device.

2 GHz/3 GHz cnRanger SM setup

General configuration

The **Configuration > General** page contains basic site definition parameters.

Figure 43: Configuration > General page

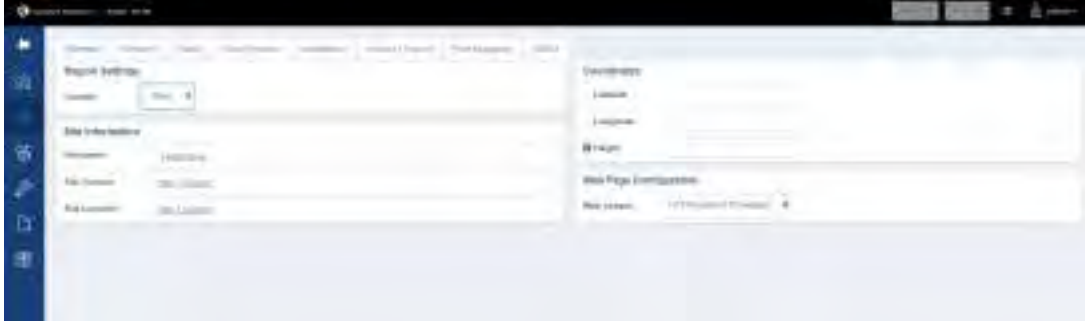

Table 55: Configuration > General page parameters

Parameter	Description
Site Name	Specify a string to associate with the physical module. This value defaults to the product short text name (e.g. T100) followed by the lower three octets of the Ethernet MAC address.
Site Contact	Enter contact information for the device administrator.
Site Location	Enter information about the physical location of the device.
Latitude	Latitude of the device in decimal degrees.
Longitude	Longitude of the device in decimal degrees.
Height	Height of the device in meters.

Network configuration

Navigate to **Configuration > Network** to control the 2 GHz/3 GHz cnRanger SM network layer operation over on the local Ethernet interface.

Figure 44: Configuration > Network page



Table 56 : Configuration > Network page parameters

Parameter	Description
Ethernet Link Speed	From the drop-down list of options, select the type of link speed for the Ethernet connection. The Auto settings allow the two ends of the link to automatically negotiate with each other the best possible speed and check whether the Ethernet traffic is full duplex or half duplex.
LAN IP Address	IPv4 address of the cnRanger 101 SM device on the Ethernet interface.
LAN Subnet Mask	Subnet mask of the cnRanger 101 SM device on the Ethernet interface.
DHCP Server	Enable or disable the DHCP Server running on the cnRanger 101 SM device serving addresses to devices connected to the Ethernet network. Addresses distributed will be based on the IP subnet associated with the LAN IP address and LAN subnet mask parameters.
DHCP IP address range start	Specifies the last octet of the first IP address in the DHCP server pool (e.g. if LAN IP address is 192.168.1.1 then a DHCP Start IP = 11 will start the DHCP server address pool at 192.168.1.11).
Pool Size	Specifies the number of IP addresses in the DHCP server pool. The last octet of the DHCP server pool will be equal to DHCP Start IP + DHCP Pool Size.
DHCP Lease Timeout	Sets DHCP lease timeout time. May be specified in hours (e.g. 12h) or minutes (e.g. 30m).
Advertisement as DNS Server	This parameter enables or disables advertisement of the cnRanger 101 SM as the DNS server. Upon initial boot the cnRanger 101 SM will not have DNS information immediately. With DNS Server Proxy disabled, the clients will renew their lease about every minute until the cnRanger 101 SM has the DNS information to give out. At this point the cnRanger 101 SM will go to the full configured lease time period which is 30 days by default. With DNS Server Proxy enabled, the cnRanger 101 SM will give out full term leases with its NAT LAN IP as the DNS server.
DHCP DNS IP Address	When enabled cnRanger 101 SM NAT will send the specified DNS server addresses to DHCP clients. If not set the cnRanger 101 SM will send DHCP clients the DNS server received from the LTE network.
Preferred DNS Server	Enter the preferred DNS IP address to use.

Parameter	Description
Alternate DNS Server	Enter the DNS IP address to use when no response is received from the preferred DNS IP address.

Radio configuration

Navigate to **Configuration > Radio** to customize the cnRanger 101 SMradio operation. No configuration is required in order to connect the cnRanger 101 SM to a cnRanger network in which the cnRanger 101 SM SIM credentials have been provisioned and where the network PLMN has not been customized. However settings on this page allow for optimal scanning performance.

Figure 45 : Configuration > Radio page

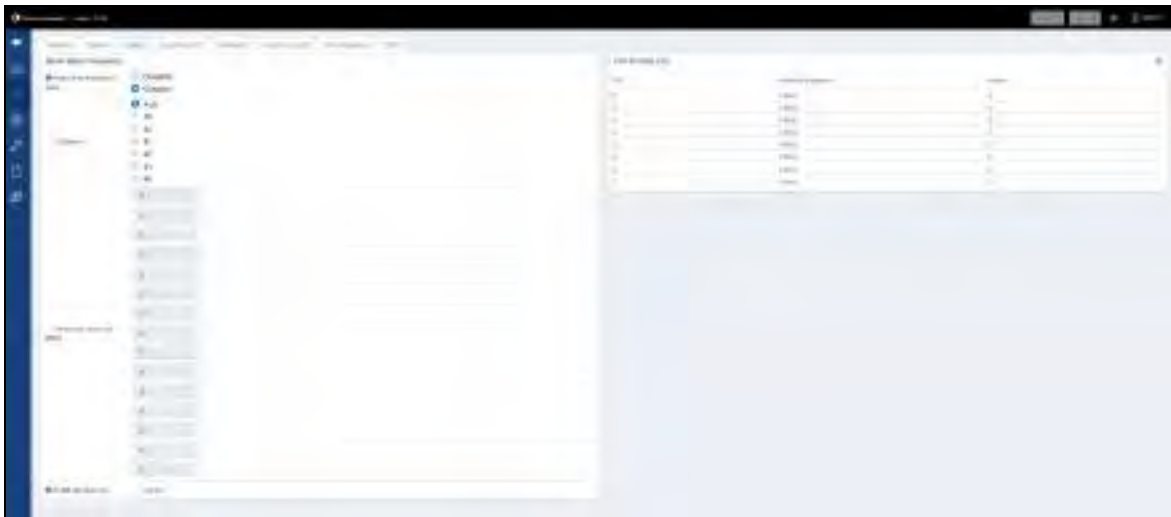

Table 57 : Configuration > Radio page parameters

Parameter	Description
Radio Administrative State	Selecting this checkbox enables the cnRanger 101 SM radio operation. The device will attempt to establish a connection to the network based on the current configuration. This setting is Enabled by default.
LTE Band	Radio buttons allowing user to specify an LTE Band that it should use for its cell search operation. If set to Any the device will search across all bands supported by the hardware.
Scan All Configured Bands	If enabled the device will not restrict cell search to configured bands. Disabling this checkbox will cause the appearance of text boxes that the operator may use to enter center frequencies to restrict its cell search.
Frequency	Used to lock the cnRanger 101 SM to a specific center frequency.

Scan results

Navigate to **Configuration > Scan** to view the results of the most recent cell scan and force a new cell scan to be executed.

Figure 46 : Configuration > Scan Results page

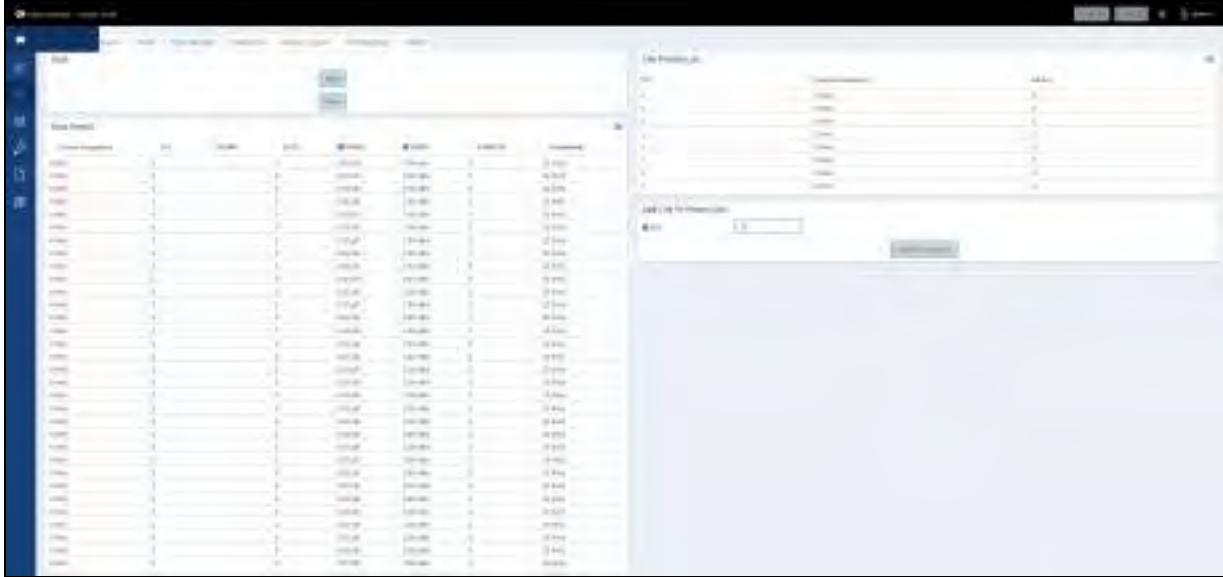

Table 58 : Configuration > Scan Results page parameters

Parameter	Description
Scan Start / Stop	Click start/stop the scan.
Carrier Frequency	Frequency of the LTE carrier in MHz
EARFCN	EARFCN of the LTE carrier
PCI	Physical Cell Identity of the LTE carrier
PLMN	Public Land Mobile Network identity. Default cnRanger PLMN is 888900.
ECID	E-UTRAN Cell Identifier of the LTE carrier. The first portion of the ECID is the eNodeB ID and the second portion is the Cell ID. If BBU eNodeB ID is provisioned to be unique each cnRanger LTE carrier in a network will have a unique ECID.
RSRQ	Reference Symbol Received Quality in dB
RSRP	Reference Symbol Received Power in dBm.
Bandwidth	Carrier Bandwidth

cnMaestro configuration

The cnRanger 101 SM **Configuration > Network Management** page is used for cnMaestro connectivity and onboarding.

To onboard the cnRanger 101 SM to cnMaestro using Cambium ID the following steps should be performed.

1. Enable remote management.
2. Set the URL of your cnMaestro service. cnRanger 101 SM will default to the Cloud cnMaestro service provided by Cambium Networks (<https://cloud.cambiumnetworks.com>).
3. Enter operator Cambium ID and onboarding key.
4. Click Save.

Figure 47 : Configuration > cnMaestro



Table 59 : Configuration > cnMaestro parameters

Parameter	Description
Remote Management	This field enables/disables cnMaestro remote management.
cnMaestro URL	Enter the cloud cnMaestro URL e.g. https://cloud.cambiumnetworks.com Or cnMaestro on premises URL.
Connection Status	This field indicates cnMaestro connectivity status.
Cambium ID	Enter operator Cambium ID used for cnMaestro onboarding.
Onboarding Key	Enter cnMaestro device Onboarding Key.
Account ID	Shows Account ID of the operator.
Device Agent Version	Shows software version of the device agent.

Import/Export configuration

Navigate to **Configuration > Import/Export** to import/export the cnRanger 101 SM configuration.

Figure 48 : Figure 48 Configuration > Import/Export



Parameter	Description
Import From	Specifies to import from a file or URL
Import File / URL	Choose the File (via Choose File button) or URL containing the configuration.
Import	click to initiate the import process.
Export	Click to initiate the export process resulting in a downloaded file via the web

Parameter	Description
	browser.

Port Mapping configuration

Navigate to **Configuration > Port Mapping** to map the port of cnRanger 101 SM configuration.

Figure 49 : Configuration > Port Mapping

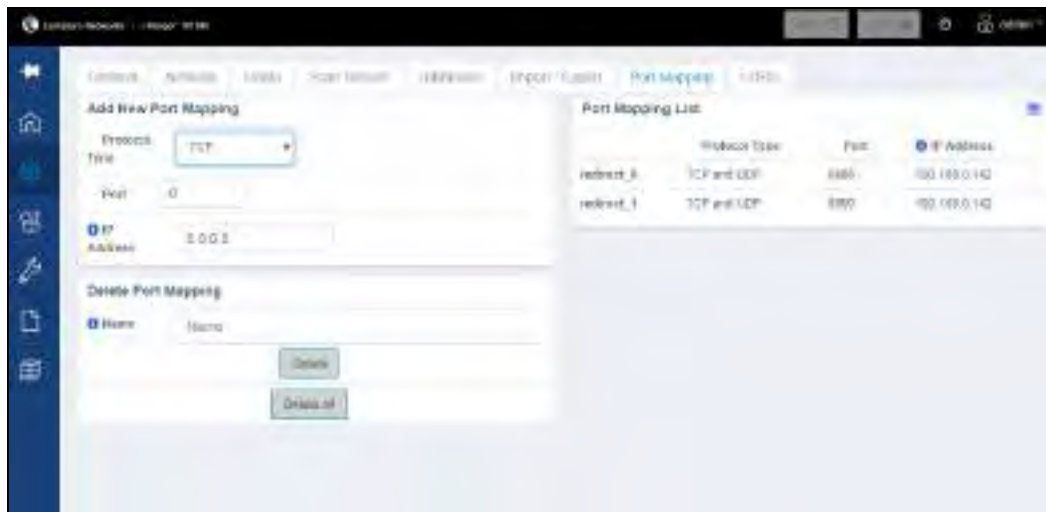

Table 60 :Configuration > Port Mapping

Parameter	Description
Protocol Type	Select type of the protocol from the Protocol list.
IP Address	IPv4 address of the cnRanger 101 SM device on the Ethernet interface.
Delete Port Mappings	Allows to delete the port mapping names in the list.
Port Mapping List	Displays the protocol mapping names with protocol type, port with the IP address.

CBRS

Navigate to **Configuration > CBRS** to map the CBRS of cnRanger 101 SM configuration.

Figure 50 : Configuration > CBRS

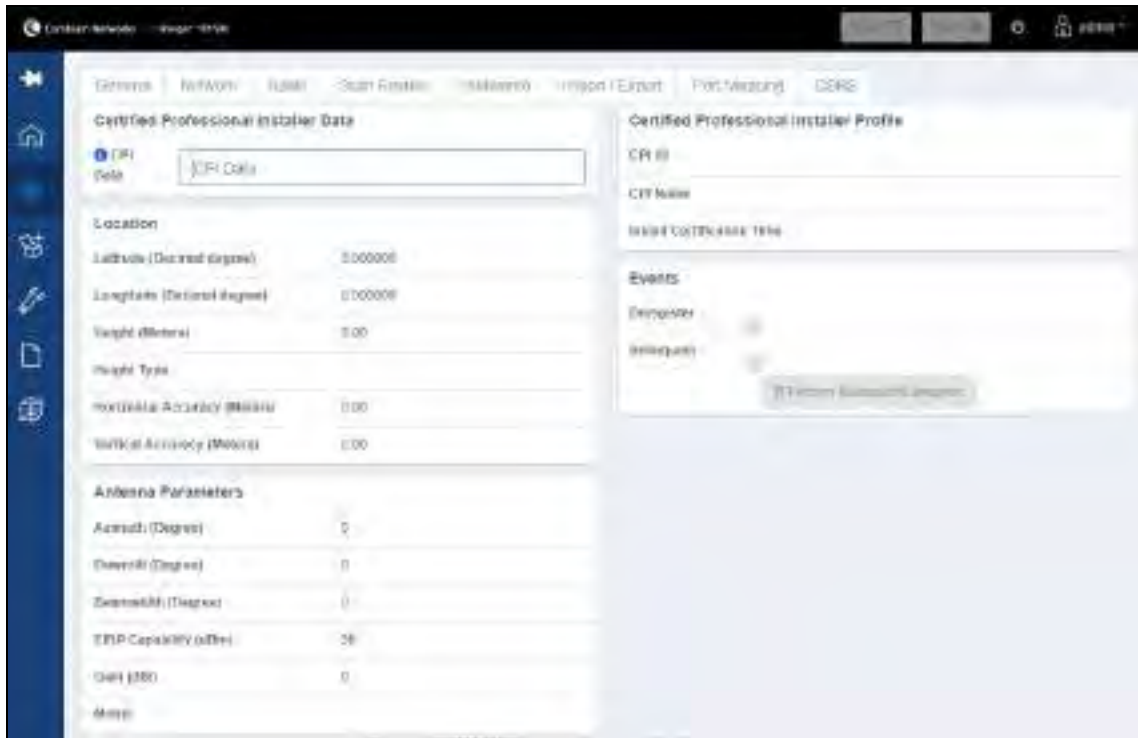

Table 61 : Configuration > CBRS page > Certified Professional Installer Data

Parameter	Description
CPI Data	Displays the details of Certified Professional Installer data.

Table 62 : Configuration > CBRS page > Location

Parameter	Description
Latitude (Decimal degree)	Latitude of the device antenna location in degrees.
Longitude (Decimal degree)	Longitude of the device antenna location in degrees.
Height (Meters)	Device antenna height in meters.
Height Type	Should be AGL or AMSL as follows: <ul style="list-style-type: none"> • AGL height is measured relative to the ground level. • AMSL height is measured relative to the mean sea level.
Horizontal Accuracy (Meters)	A positive number in meters to indicate the accuracy of the device antenna horizontal location.
Vertical Accuracy (Meters)	A positive number in meters to indicate the accuracy of the device antenna vertical location.

Table 63 : Configuration > CBRS page > Antenna Parameters

Parameter	Description
Azimuth	Boresight direction of the horizontal plane of the antenna in degrees with respect to

Parameter	Description
(Degree)	true north.
Downtilt (Degree)	Antenna down tilt in degrees.
Beamwidth (Degree)	3-dB antenna beam width of the antenna in the horizontal-plane in degrees.
EIRP Capability (dBm)	Equivalent, Isotropically Radiated Power (EIRP) the maximum amount of power that could be radiated from an antenna in dBm.
Gain (dBi)	Peak gain of integrated antenna in dBi.
Model	Displays the model of the device.

Table 64 : Configuration > CBRS page > Installer Profile

Parameter	Description
CPI ID	CPI's (Certified Professional Installer) ID.
CPI Name	CPI's Registered Name.
Install Certification Time	Displays the time and date of certificate installation.

Table 65 : Configuration > CBRS page > Events

Parameter	Description
Deregister	Allows to deregister device (single or multiple)
Relinquish	Allows to re-start the CBRS procedure from UNREGISTERED state.

Chapter 7: Tools

The cnRanger family GUIs provide tools to analyze the operating environment, system performance, and networking, including:

- [Common tools](#)
- [2 GHz/3 GHz cnRanger SM](#)

Common tools

This section describes about the cnRanger 800 BBU and 2 GHz/3 GHz cnRanger SM software upgrade pages.

Software upgrade

The cnRanger 800 BBU and 2 GHz/3 GHz cnRanger SM software upgrade pages allow the users to upgrade the device software via either web browser file upload or via URL.

When using the URL based upgrade the URL format is:

scheme://[user[:password]@]host[:port]/path

where user, password and port are all optional parameters. Valid scheme values are ftp, tftp, http and https.

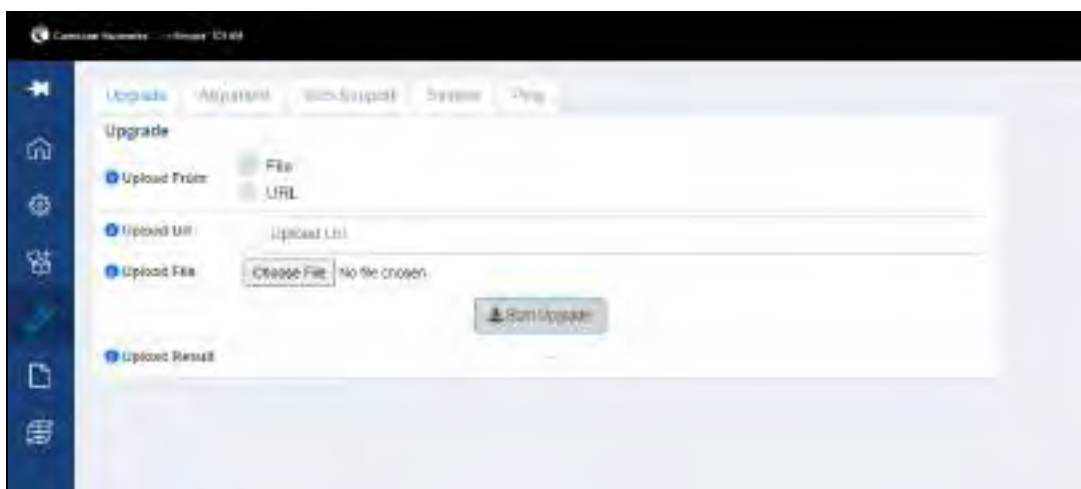

cnRanger 101 SM

Alignment Tool

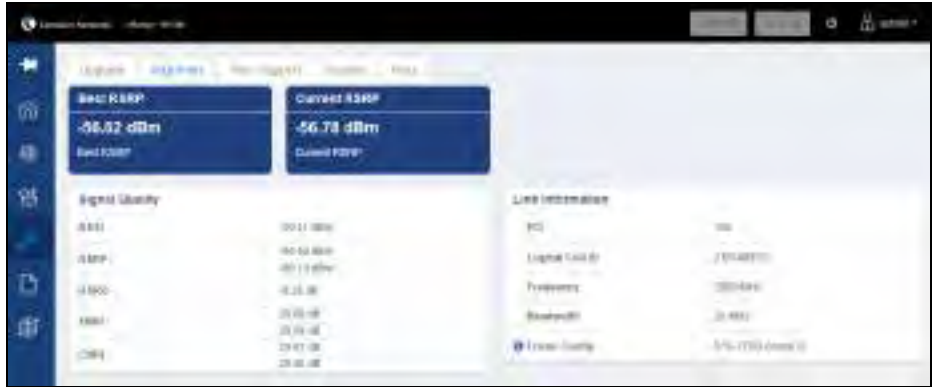

The cnRanger 101 SM alignment tool provides a real time radio statistics to aid the installer in optimally aiming the directional antenna. The signal quality and link information displayed are specific to the current LTE carrier to which the cnRanger 101 SM is connected to.

To use this tool first verify using the link information tab to which the cnRanger 101 SM is actually connected LTE carrier (frequency, Logical Cell ID, PCI should all match that of the cnRanger 101 SM provisioned on the cnRanger 800 BBU). Then the cnRanger 101 SM antenna carefully aims until the optimal RSRP result is acquired using the best RSRP and current RSRP fields at the top of the page.

Technical Support

Click the cnRanger 101 SM Tech Support button to download a Tech Support debug package to the user's device via the web browser. This file will be used by Cambium Networks technical support to diagnose system issues.



System

Click the **Factory Reset** button to restore all device configuration to the system default values.

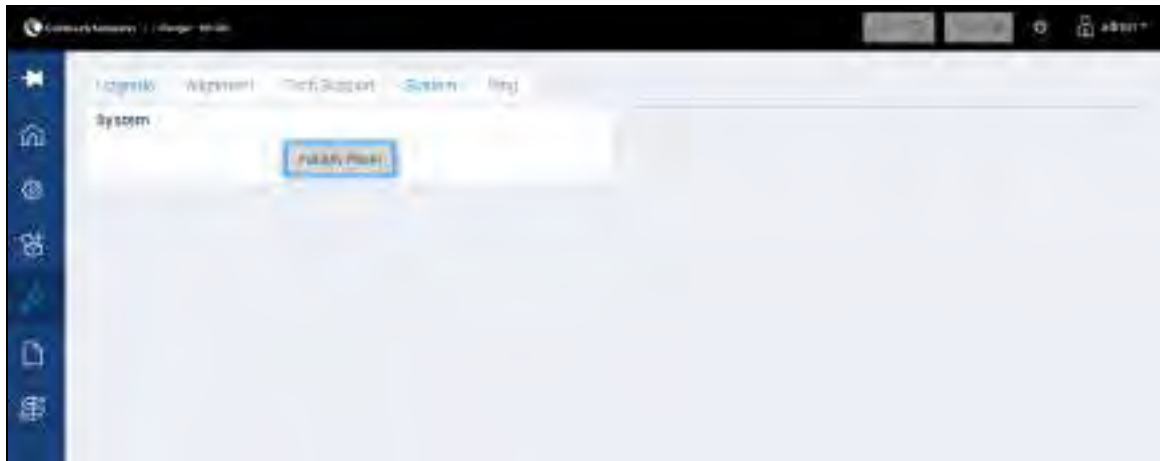

Chapter 8: Operation

This chapter provides instructions for operators of the cnRanger series devices. The following topics are described in this chapter:

- [System statistics](#)
- [Software upgrade](#)
- [Device recovery](#)

System statistics

This section describes about the cnRanger 800 BBU and 2 GHz/3 GHz cnRanger SM dashboards.

cnRanger 800 BBU

Dashboard

Figure 51: cnRanger 800 BBU dashboard

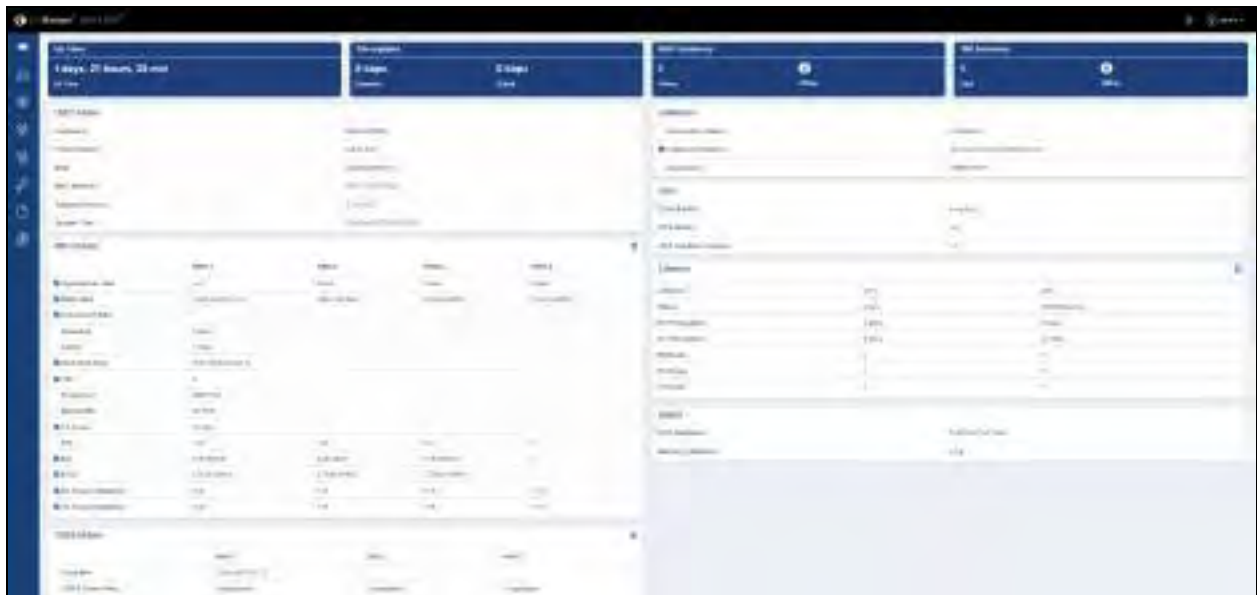

The cnRanger 800 BBU Dashboard page provides access to key information in understanding the current configuration and status of the cnRanger 800 BBU and 2 GHz/3 GHz cnRanger RRH.

Table 66 : cnRanger 800 BBU Dashboard parameters

Status or Statistic	Description
Up Time	Time since the last device reset.
Throughput	Current aggregate downlink and uplink throughput across all 2 GHz/3 GHz cnRanger RRH.
2 GHz/3 GHz cnRanger RRH Summary	Number of online and offline 2 GHz/3 GHz cnRanger RRH among all 2 GHz/3 GHz cnRanger RRH in an enabled admin state.

Status or Statistic	Description
SM Summary	Number of online and offline SMs across all 2 GHz/3 GHz cnRanger RRH. An 2 GHz/3 GHz cnRanger SM considers to be in an offline state if it was previously connected to any of the 2 GHz/3 GHz cnRanger RRH but is no longer in service.
Hostname	Configured hostname of the cnRanger 800 BBU.
Product Name	Product name of the cnRanger 800 BBU.
MSN	cnRanger 800 BBU MSN - used for claiming the cnRanger 800 BBU with cnMaestro.
MAC Address	MAC (Media Access Control) Layer of the 2 GHz/3 GHz cnRanger SM.
Software Version	Current version of the cnRanger 800 BBU and 2 GHz/3 GHz cnRanger RRH software.
System Time	Current cnRanger 800 BBU time as retrieved via NTP.
Admin State	Administrative state of the 2 GHz/3 GHz cnRanger RRH. If enabled the 2 GHz/3 GHz cnRanger RRH and the corresponding LTE cell is permitted to come into service. If disabled, the 2 GHz/3 GHz cnRanger RRH will be kept offline.
RRH	If Up the 2 GHz/3 GHz cnRanger RRH is providing service to the LTE cell. If Down the cell is not providing service.
Connected SMs	The number of SMs currently serviced by the 2 GHz/3 GHz cnRanger RRH LTE cell.
Downlink	Current downlink throughput of the 2 GHz/3 GHz cnRanger RRH LTE cell.
Uplink	Current uplink throughput of the 2 GHz/3 GHz cnRanger RRH LTE cell.
Downlink Data	Current TDD downlink uplink ratio configured for the 2 GHz/3 GHz cnRanger RRH.
SSF	Current LTE special subframe format configured for the 2 GHz/3 GHz cnRanger RRH.
Frequency	Current carrier center frequency in MHz configured for the 2 GHz/3 GHz cnRanger RRH.
Bandwidth	Current carrier bandwidth configured for the 2 GHz/3 GHz cnRanger RRH.
Tx Power	Current per-branch transmit power configured for the 2 GHz/3 GHz cnRanger RRH.
Connection Status	Current state of the connection between cnRanger 800 BBU and cnMaestro
CAMBIUM_ID	Cambium ID currently utilized for cnMaestro management of cnRanger 800 BBU.
Sync Source	Indicates if cnRanger 800 BBU is receiving Sync from GPS or is configured to Free Run
GPS Status	Current GPS operation state
GPS Satellites Tracked	Current number of satellites tracked by GPS receiver.
Ethernet Status	Operating mode of the Ethernet interface
RX Throughput	Current receive traffic throughput at the Ethernet interface
TX Throughput	Current transmit traffic throughput at the Ethernet interface

Status or Statistic	Description
CPU Utilization	Aggregate CPU utilization of the cnRanger 800 BBU Linux cores
Memory Utilization	The amount of main memory used during software execution.

2 GHz cnRanger 220 RRH

Figure 52 : 2 GHz cnRanger 220 RRH



Table 67 : 2 GHz cnRanger 220 RRH statistics

Status or Statistic	Description
Admin State	If Up, the 2 GHz cnRanger 220 RRH has been configured to allow going in service. If Down, the 2 GHz cnRanger 220 RRH will not try and go in service.
RRH State	If Up the 2 GHz cnRanger 220 RRH is providing LTE service.
OAM State	Status of the OAM software connection.
Cell State	If Up the LTE cell is in service.
Connected SMs	The number of SM sessions currently connected at an LTE eNodeB level. Note that there may be sessions that appear in the Statistics SM tab that do not appear here.
Downlink	Current Downlink throughput of the LTE cell measured at the eNodeB.
Uplink	Current Uplink throughput of the LTE cell measured at the eNodeB.
LTE Band	Current LTE frequency band.
FPGA Version	Software version info for the 2 GHz cnRanger 220 RRH FPGA.

Status or Statistic	Description
App Version	Application version information for the 2 GHz cnRanger 220 RRH software.
SW Version	Overall 2 GHz cnRanger 220 RRH software version.
VSWR	Voltage Standing Wave Ratio - measures efficiency of energy delivery to the antenna. If this value gets too high it is indicative of an antenna connection issue and the 2 GHz cnRanger 220 RRH will shut down to protect the transmitter.
TSSI Ant 1, TSSI Ant 2	Antenna 1 and 2 Transmit Signal Strength Indication.

SMs



GPS



Health



Process Monitor



cnRanger 101 SM Dashboard

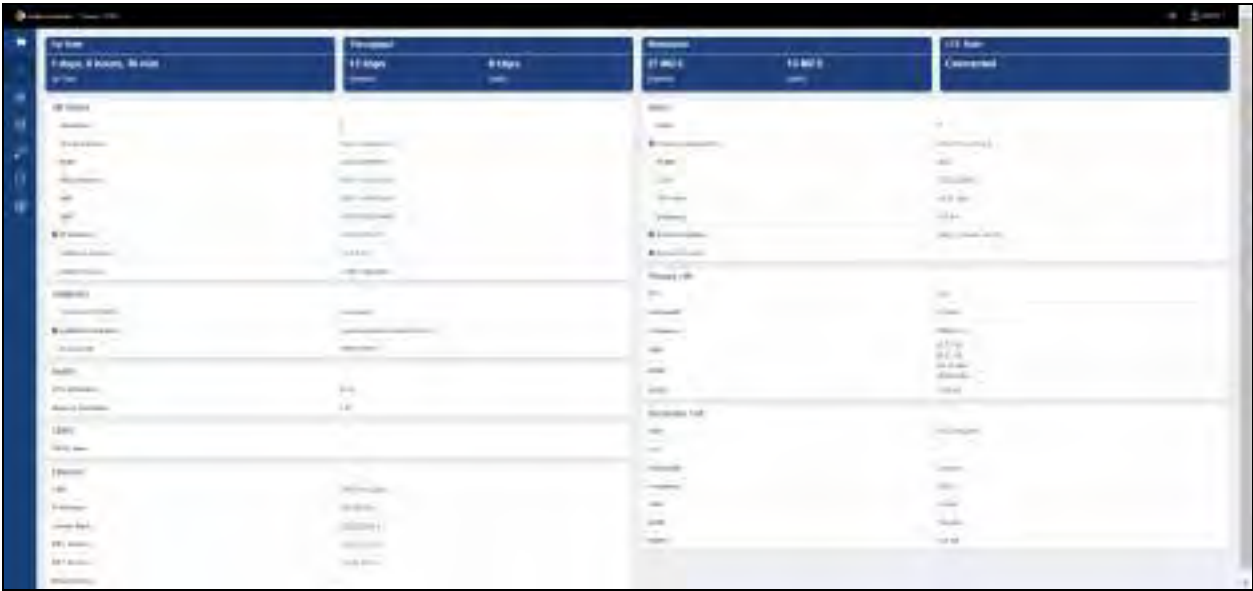

The cnRanger 101 SM Dashboard contains a summary of critical information for the cnRanger 101 SM device.

cnRanger 201 SM

Dashboard



The cnRanger 201 SM Dashboard contains a summary of critical information for the cnRanger 201 SM device.

Wired clients

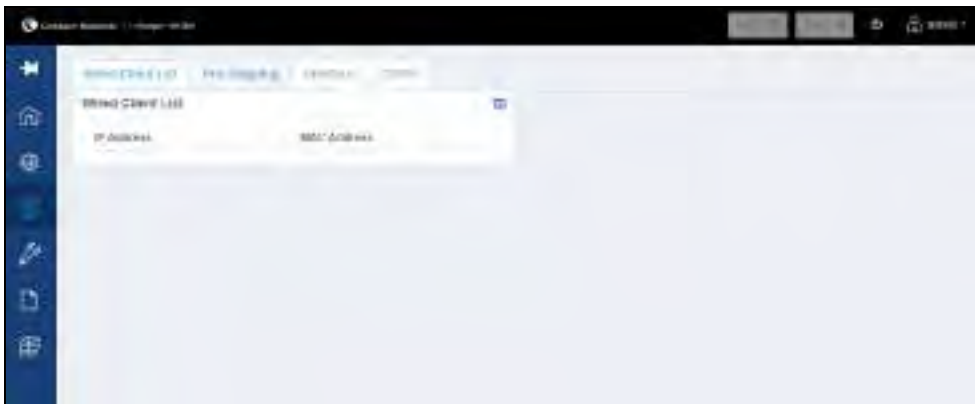

Port Mapping

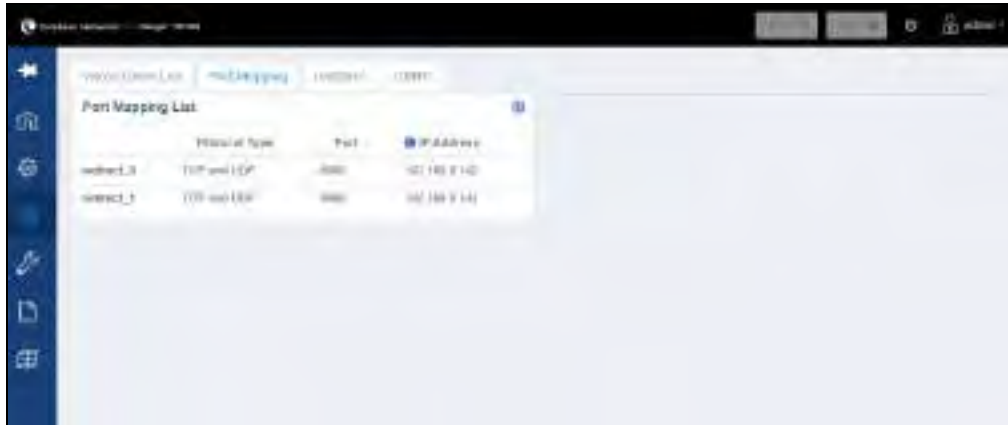

The screenshot shows the 'Port Mapping List' window in the network management interface. It contains a table with the following data:

Interface	Physical Type	Port	IP Address
swdnet1_3	10G SFP	3000	10.140.1.10
swdnet1_1	10G SFP	3000	10.140.1.14

Interface Statistics

The Wired Clients statistics page shows the IP address and Ethernet MAC address of all clients currently being served by the cnRanger 101 SM.



The screenshot shows the 'Interface Statistics' window in the network management interface. It displays a table with the following data:

Interface	ETH	MAC
IF Status	UP	Up
IP Address	10.140.1.1	82:15:00:00:00:01
RX Packets	12150	1096
TX Packets	12150	1097
RX Bytes	1508711	1511054
TX Bytes	1508711	1511054
RX Errors	0	0
TX Errors	0	0
RX Drops	0	0
TX Drops	0	0

CBRS

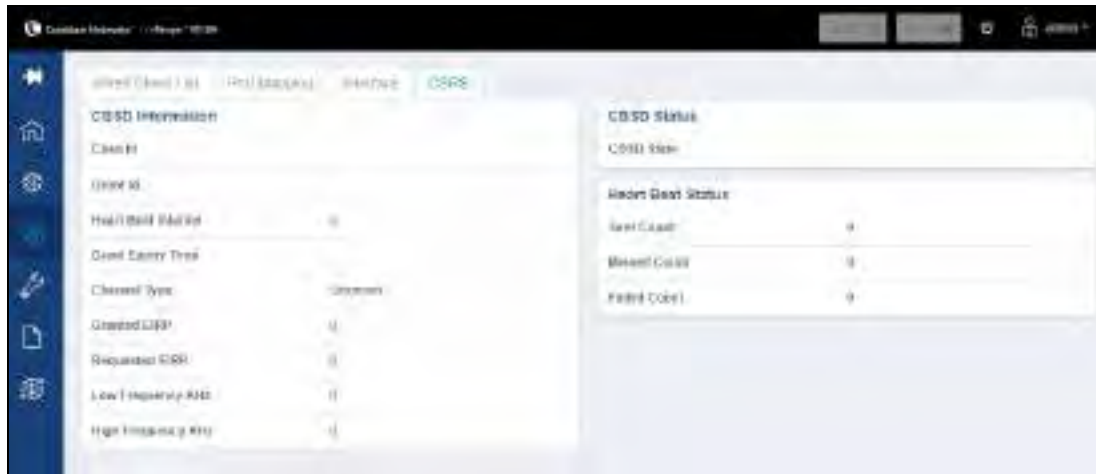

Software upgrade

It is recommended to use cnMaestro to conduct upgrades of cnRanger products. Alternately software releases may be retrieved using your Cambium Networks support login at .

From here a cnMaestro deployable file can be retrieved (e.g. lte-1.0.0.0-b20.tar.gz) containing:

- sierra_upgrade.tar.gz (BBU upgrade file)
- upgrade.img (SM upgrade file)

These files can be used to upgrade devices via the Tools > Upgrade section of the GUI (see Tools Software upgrade section).

Device recovery

cnRanger 800 BBU

To initiate the cnRanger 800 BBU factory reset perform as follows:

1. Hold down the reset button.
2. The Power LED will begin slowly flashing.
3. When the Power LED is solid again release the reset button and the cnRanger 800 BBU will perform a factory reset.
4. Releasing the reset button prior to the solid Power LED will result in a normal reset.

Upon completing factory reset most parameters including admin password information will be reset to their default values. The software image revision is not affected.

Some key default parameter values include:

- Always ON IP address: 169.254.1.1 / 16
- Admin account password: admin

cnRanger 101 SM

Perform the cnRanger 101 SM factory reset using the GUI as follows:

1. Navigate to **Tools > System**.
2. Click Factory Reset.

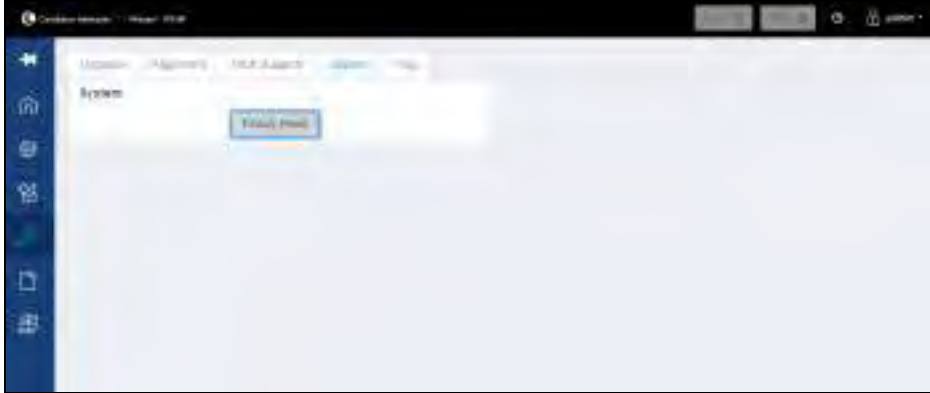

3. click **Reboot Device** in the top-right corner of GUI.

The cnRanger 101 SM restores it's configuration to factory default values and boots using the values. It includes all network and admin account settings. But the software image remains unchanged.

CBRS

This section describes configuration and operation of Cambium Networks CBRS solution for LTE SM's. It covers procedural steps for both the radio and cnMaestro. It is similar to Cambium Networks PMP CBRS procedures guide. However, the majority of PMP CBRS deployments were migrations from Part 90 FCC setups. Cambium 3.6 GHz LTE CBRS deployments are expected to be new installations. For further information refer to [CBRS LTE](#) guide.

Chapter 9: Reference Information

This chapter contains reference information and regulatory notices that apply to the cnRanger platform family ODUs.

The following topics are described in this chapter:

- [Equipment specifications](#) contains specifications of the cnRanger platform family, ODU specifications including RF bands, channel width, and link loss.
- [Equipment disposal](#) describes the Equipment Disposal system for Electronic and Electric Equipment.
- [3GPP band information](#) describe about the FCC specific power specification and ETSI specification.

Equipment specifications

This section contains specifications of the cnRanger 800 BBU, 2 GHz/3 GHz cnRanger RRH, and 2 GHz/3 GHz cnRanger SM associated supplies required for cnRanger platform family installations.

cnRanger 800 BBU specification

The cnRanger 800 BBU confirms to the specifications listed below:

Category	Specification
Model Numbers	LTE-BBU-800
Spectrum	
Channel Spacing	Configurable on 1 MHz increments
Frequency Range	2300 - 2700 MHz, Bands 38, 40, 41, 42, 43 and 48 software upgradeable to any TD-LTE band
Channel Width	10 MHz, 15 MHz, 20 MHz
INTERFACE	
2GHz/3 GHz cnRanger RRH Interface	Four SFP+ / CPRI v7.0
Ethernet Interface (Copper)	10/100/1000BaseT, full duplex, rate auto negotiated, 802.3 compliant
Ethernet Interface (Optical)	1000Base -SX
Console Interface	Mini USB Serial
Display Interface	1.77 inch LCD Display
Protocols Used	IPv4, UDP, TCP, ICMP
Network Management	HTTP, HTTPS, SSH, cnMaestro
MTU	1500 bytes

Category		Specification	
SECURITY			
Encryption		AES-128 and SNOW 3G	
PERFORMANCE			
Subscribers per Sector		64	
PPS		TBD	
HARQ		Yes	
Maximum Deployment Range		up to 20 miles (32 km)	
Latency		<30 msec typical	
Throughput		Config 1: 68 Mbps DL / 20 Mbps UL Config 3: 95 Mbps DL / 13 Mbps UL. Config 2: 104 Mbps DL/ 6.5 Mbps UL	
GPS Synchronization		On-board GPS and GPS antenna via SMA connector, 1PPS SYNC IN via SMA connector, 1PPS SYNC OUT via SMA connector	
Adaptive Modulation Levels (MCS)		Signal to Noise Required (SNR, in dB) Uplink Signal to Noise Ratio (in, dB)	
MCS	SNR	MCS	SNR
0-QPSK	-3	10-QPSK	6
1-QPSK	-3	11-16QAM	7
2-QPSK	-1	12-16QAM	8
3-QPSK	0	13-16QAM	9
4-QPSK	1	14-16QAM	10
5-QPSK	2	15-16QAM	10
6-QPSK	2	16-16QAM	11
7-QPSK	3	17-16QAM	12
8-QPSK	4	18-16QAM	13
9-QPSK	5	19-16QAM	13
MCS		MCS	SNR
		20-16QAM	14
		11-16QAM	15
		12-16QAM	16
		13-16QAM	17
		14-16QAM	
		15-16QAM	
		16-16QAM	
		17-16QAM	
		18-16QAM	
		19-16QAM	
PHYSICAL			
Surge Suppression		Ethernet EN61000-4-5: 8us/20us, 2kV voltage waveform	

Category	Specification
	DC Power Port EN61000-4-5: 10us/700us, 2kV voltage waveform
Temperature / Humidity	-40°C to +55°C (-40°F to +131°F), 5-95% non-condensing
Weight	3.2Kg (7.1 lbs)
Dimensions (WxHxD) (including mount)	13" (W) x 2 3/8" (H) x 9" (D) (330 mm x 60 mm x 229 mm)
Power Consumption	90 W nominal, 120 W peak
Recommended Power Supply	P/N: N000000L129A - XP Power 120 W PSU
Input Voltage	3 48V DC (36V to 60V)
CERTIFICATIONS	
ETSI	EN 301 489-1 v2.2.0 Draft EN 301 489-19 v2.1.0
FEATURES	
LTE Configurations Supported	1, 2, and 3
Evolved Packet Core	Fully embedded, virtualized EPC

2 GHz cnRanger 220 RRH specification

The 2 GHz cnRanger 220 RRH confirms to the specifications listed below:

Category	Specification
Model Numbers	2LTE-RRH-220
Spectrum	
Frequency Range	2300 - 2700 MHz, Bands 38, 40, 41
Channel Width	5 MHz, 10 MHz, 15 MHz and 20 MHz
INTERFACE	
Physical Layer	2x2 MIMO OFDMA, SC-FDMA
BBU Interface	SFP+ / CPRI v7.0 Fiber cable: N000000L131A, pre-terminated, 2m cable
DC Power	Power cable N000000L130A, two conductor plus ground
PHYSICAL	
Antenna Connection	2 N-Type

Category	Specification
Surge Suppression	EN61000-4-5: 1.2us/50us, 500 V voltage waveform
Temperature / Humidity	-40°C to +60°C (-40°F to +140°F), 5-95% non-condensing
Weight	6 kg (13.2 lbs)
Dimensions (WxHxD) (including mount)	10 3/4" (H) x 3 3/16" (H) x 12 1/2" (D) (273 mm x 81 mm x 318 mm)
Wind Survival	200 Km/Hr
Optional Mounting Kit	1.5" to 3.0" (38 to 76 mm) pole N000000L128A
Power Consumption	55 W nominal, 72 W peak
Recommended Power Supply	P/N: N000000L129A - XP Power 120 W PSU (LPS)
Input Voltage	3 48V DC (36V to 60V)
CERTIFICATIONS	
ETSI	EN 301 908-1 v11.1 EN 50385 / EN 62311 Draft EN 301 489-50 v2.1.0
LINK BUDGET	
Transmit Power Range	42 dB dynamic range (1 dB step)
Maximum Transmit Power	33 dBm per chain, 36 dBm combined

3 GHz cnRanger 210 RRH specification

Category	Specification
Model Numbers	3LTE-RRH-210
Spectrum	
Frequency Range	3550MHz to 3700MHz, Bands 48 (CBRS)
Channel Width	10 MHz and 20 MHz
INTERFACE	
Physical Layer	2x2 MIMO OFDMA, SC-FDMA
BBU Interface	SFP+ / CPRI v7.0 Fiber cable: N000000L131A, pre-terminated, 2m cable
DC Power	Power cable N000000L130A, two conductor plus ground
PHYSICAL	
Antenna Connection	2 N-Type
Surge Suppression	EN61000-4-5: 1.2us/50us, 500 V voltage waveform
Temperature / Humidity	-40°C to +55°C (-40°F to +131°F),

Category	Specification
	5-95% non-condensing
Weight	6 kg (13.2 lbs)
Dimensions (WxHxD) (including mount)	10 3/4" (H) x 3 3/16" (H) x 12 1/2" (D) (273 mm x 81 mm x 318 mm)
Wind Survival	200 Km/Hr
Optional Mounting Kit	1.5" to 3.0" (38 to 76 mm) pole N000000L128A
Power Consumption	55 W nominal, 72 W peak
Recommended Power Supply	P/N: N000000L129A - XP Power 120 W PSU (LPS)
Input Voltage	3 48V DC (36V to 60V)
CERTIFICATIONS	
ETSI	EN 301 908-1 v11.1.1 EN 50385 / EN 62311 Draft EN 301 489-50 v2.1.0
LINK BUDGET	
Transmit Power Range	30 dB dynamic range (1 dB step)
Maximum Transmit Power	30 dBm per chain, 33 dBm combined

cnRanger 101 SM Specification

The cnRanger 101 SM confirms to the specifications listed below:

Category	Specification
Model Numbers	2LTE-SM-401 2LTE-SM-401-US 2LTE-SM-401-UK 2LTE-SM-401-EU
Spectrum	
Channel Spacing	1 MHz as specified in the BBU
Frequency Range	LTE Band 38: 2570 - 2620 MHz, LTE Band 40: 2300 - 2400 MHz, LTE Band 41: 2496 - 2690 MHz
Channel Width	5 MHz, 10 MHz, 15 MHz, and 20 MHz
INTERFACE	
MAC (Media Access Control) Layer	TDD-LTE Advanced Release 10
Protocols Used	IPv4, UDP, TCP, IP, ICMP
Network Management	HTTP, HTTPS, SSH, cnMaestro

Category		Specification	
MTU		1500 bytes	
SECURITY			
Authentication		SIM authentication via cnRanger 800 BBU, cnMaestro or GUI provisions cnRanger 800 BBU with SIM information	
Encryption		AES-128 and SNOW 3G	
PERFORMANCE			
PPS		TBD	
HARQ		Yes	
Ultimate Sensitivity		-98 dBm	
Adaptive Modulation Levels (MCS)		Signal to Noise Required (SNR, in dB)	
MCS	SNR	MCS	SNR
0-QPSK	3	10-16QAM	11
1-QPSK	3	11-16QAM	11
2-QPSK	4	12-16QAM	11
3-QPSK	5	13-16QAM	13
4-QPSK	6	14-16QAM	14
5-QPSK	7	15-16QAM	14
6-QPSK	7	16-16QAM	15
7-QPSK	8	17-16QAM	16
8-QPSK	9	18-16QAM	16
9-QPSK	10	19-16QAM	17
MCS		MCS	SNR
		20-64QAM	18
		20-64QAM	18
		22-64QAM	19
		23-64QAM	21
		24-64QAM	21
		25-64QAM	22
		26-64QAM	23
		27-64QAM	24
		28-64QAM	28
PHYSICAL			
Surge Suppression		EN61000-4-5: 1.2us/50us, 500 V voltage waveform	
Environmental		IP55	
Temperature / Humidity		-40°C to +60°C (-40°F to +140°F), 5-95% non-condensing	
Weight		4.4 lbs (2 kgs)	
Dimensions (WxHxD)		10.2" (H) x 10.2" (W) x 3.6" (D) (260 mm x 260 mm x 92 mm)	
Wind Survival		190 Km/Hr	
Pole Diameter Range (w/included mount)		1.5" to 3.0" (38 to 76 mm)	
Power Consumption		7.6 W	
Power Supply		30 V PoE	

Category	Specification
CERTIFICATIONS	
ETSI	EN 301 908-1 v11.1.1, EN 50385 EN 62311, Draft EN 301 489-52 v1.1.0
ANTENNA	
Integrated Antenna Peak Gain	15 dBi
3 dB Beamwidth - Azimuth	30°
3 dB Beamwidth - Elevation	30°
Polarization	Slant, +/- 45 Degrees
Front-to-Back Isolation	>25 dB
Cross Polarization	>23 dB
FEATURES	
LTE Standard for EPC and eNB	3GPP Release 10, category 4
Default Configuration Reset	Supported

2 GHz cnRanger 201 SM Specification

The cnRanger 101 SM confirms to the specifications listed below:

Category	Specification
Model Numbers	2LTE-SM-201 2LTE-SM-201-US 2LTE-SM-201-UK 2LTE-SM-201-EU
Spectrum	
Channel Spacing	1 MHz as specified in the BBU
Frequency Range	LTE Band 38: 2570 - 2620 MHz, LTE Band 40: 2300 - 2400 MHz, LTE Band 41: 2496 - 2690 MHz
Channel Width	5 MHz, 10 MHz, 15 MHz, and 20 MHz
INTERFACE	
MAC (Media Access Control) Layer	TDD-LTE Advanced Release 10
Protocols Used	IPv4, IPv6, UDP, TCP, IP, ICMP
Network Management	HTTP, HTTPS, SSH, cnMaestro
MTU	1500 bytes
SECURITY	
Authentication	SIM authentication via cnRanger 800 BBU, cnMaestro or GUI provisions cnRanger 800 BBU with SIM information

Category		Specification	
Encryption		AES-128 and SNOW 3G	
PERFORMANCE			
PPS		TBD	
HARQ		Yes	
Ultimate Sensitivity		-98 dBm	
Adaptive Modulation Levels (MCS)		Signal to Noise Required (SNR, in dB)	
MCS	SNR	MCS	SNR
0-QPSK	3	10-16QAM	11
1-QPSK	3	11-16QAM	11
2-QPSK	4	12-16QAM	11
3-QPSK	5	13-16QAM	13
4-QPSK	6	14-16QAM	14
5-QPSK	7	15-16QAM	14
6-QPSK	7	16-16QAM	15
7-QPSK	8	17-16QAM	16
8-QPSK	9	18-16QAM	16
9-QPSK	10	19-16QAM	17
MCS		MCS	SNR
		20-64QAM	18
		20-64QAM	18
		22-64QAM	19
		23-64QAM	21
		24-64QAM	21
		25-64QAM	22
		26-64QAM	23
		27-64QAM	24
		28-64QAM	28
PHYSICAL			
Surge Suppression		IEC/EN 61000-4-5, 4kV @ (1.2/50us(8/20us), 10/700us)	
Environmental		IP67	
Temperature / Humidity		-40°C to +55°C (-40°F to +131°F), 0-95% non-condensing	
Weight		3.2 kg (7 lbs)	
Dimensions (WxHxD)		450 mm dia x 300 mm (17.7 in. dia x 11.8 in.)	
Wind Survival		200 kph (124 mph)	
Pole Diameter Range (w/included mount)		38 mm to 76 mm (1.5 in to 3 in)	
Power Consumption		9 W	
Power Supply		30 V PoE	
CERTIFICATIONS			
ETSI		EN 301 908-1 v11.1.1, EN 50385 EN 62311, Draft EN 301 489-52 v1.1.0	

Category	Specification
ANTENNA	
Integrated Antenna Peak Gain	17.5 dBi
3 dB Beamwidth - Azimuth	18°
3 dB Beamwidth - Elevation	16°
Polarization	Slant, +/- 45 Degrees
Front-to-Back Isolation	>30 dB
Cross Polarization	>20 dB
FEATURES	
LTE Standard for EPC and eNB	3GPP Release 10, category 4
Default Configuration Reset	Supported

3 GHz cnRanger 201 SM Specification

Category	Specification
Model Numbers	3LTE-SM-201 3LTE-SM-201-US 3LTE-SM-201-UK 3LTE-SM-201-EU
Spectrum	
Channel Spacing	1 MHz as specified in the BBU
Frequency Range	LTE Band 42: 3400-3600 MHz LTE Band 43: 3600-3800 MHz LTE Band 48: 3550-3700 MHz
Channel Width	5 MHz, 10 MHz, 15 MHz, and 20 MHz
INTERFACE	
MAC (Media Access Control) Layer	TDD-LTE Advanced Release 10
Protocols Used	IPv4, IPv6, UDP, TCP or IP, ICMP
Network Management	HTTP, HTTPS, SSH, cnMaestro
MTU	1516 bytes
SECURITY	
Authentication	SIM authentication via cnRanger 800 BBU, cnMaestro or GUI provisions cnRanger 800 BBU with SIM information
Encryption	AES-128 and SNOW 3G
PERFORMANCE	
PPS	TBD

Category				Specification	
HARQ				Yes	
Ultimate Sensitivity				-98 dBm	
Adaptive Modulation Levels (MCS)				Signal to Noise Required (SNR, in dB)	
MCS	SNR	MCS	SNR	MCS	SNR
0-QPSK	3	10-16QAM	11	20-64QAM	18
1-QPSK	3	11-16QAM	11	20-64QAM	18
2-QPSK	4	12-16QAM	11	22-64QAM	19
3-QPSK	5	13-16QAM	13	23-64QAM	21
4-QPSK	6	14-16QAM	14	24-64QAM	21
5-QPSK	7	15-16QAM	14	25-64QAM	22
6-QPSK	7	16-16QAM	15	26-64QAM	23
7-QPSK	8	17-16QAM	16	27-64QAM	24
8-QPSK	9	18-16QAM	16	28-64QAM	28
9-QPSK	10	19-16QAM	17		
PHYSICAL					
Surge Suppression				IEC/EN 61000-4-5, 4kV @ (1.2/50us(8/20us), 10/700us)	
Environmental				IP67	
Temperature / Humidity				-40°C to 55°C (-40°F to 131°F), 0-95% non-condensing	
Weight				3.2 kg (7 lbs)	
Dimensions (WxHxD)				450 mm dia x 300 mm (17.7 in. dia x 11.8 in.)	
Wind Survival				200 kph (124 mph)	
Pole Diameter Range (w/included mount)				38 mm to 76 mm (1.5 in to 3 in)	
Power Consumption				9 W	
Power Supply				30 V PoE	
CERTIFICATIONS					
ETSI				EN 301 908-1 v11.1.1, EN 50385 EN 62311, Draft EN 301 489-52 v1.1.0	
ANTENNA					
Integrated Antenna Peak Gain				21 dBi	

Category	Specification
3 dB Beamwidth - Azimuth	12°
3 dB Beamwidth - Elevation	12°
Polarization	Slant, +/- 45 Degrees
Front-to-Back Isolation	>30 dB
Cross Polarization	>20 dB
Transmit Power Range (to EIRP limit by region)	66 dB dynamic range
Maximum Transmit Power	23 dbm
FEATURES	
LTE Standard for EPC and eNB	3GPP Release 10, category 4
Default Configuration Reset	Supported
Certifications	
ISED Canada	TBD
FCC ID	Z8H89FT0060
ETSI	TBD

Equipment disposal

Waste (Disposal) of electronic and electric equipment

	Waste (Disposal) of Electronic and Electric Equipment	<p>Do not dispose of Electronic and Electric Equipment or Electronic and Electric Accessories with your household waste. In some countries or regions, collection systems have been set up to handle waste of electrical and electronic equipment. In European Union countries, contact your local equipment supplier representative or service center for information about the waste collection system in your country.</p>
---	--	---

3GPP band information

This section describe about the FCC specific power specification and ETSI specification.

FCC specific power specification

cnRanger supports duplex mode TDD Band 41 with Uplink & Downlink frequency as 2496-2690MHz, which operates with 5,10,15 & 20MHz bandwidth channels & QPSK, 16QAM, 64QAM modulation types. For Filed Subscriber Station Module, Max Power of 2Watts/33dBm (Conducted Power).

ETSI specification

cnRanger supports duplex mode TDD Band 38 with Uplink & Downlink frequency as 2570MHz - 2620MHz, which operates with 5,10,15 & 20MHz bandwidth channels & QPSK, 16QAM, 64QAM modulation types. For Filed Subscriber Station Module, Max Power of 23dBm (Conducted Power).

Chapter 10: Glossary

Term	Definition
802.3	An IEEE standard that defines the contents of frames that are transferred through Ethernet connections. Each of these frames contains a preamble, the address to which the frame is sent, the address that sends the frame, the length of the data and a checksum to validate that no contents were lost.
Attenuation	Reduction of signal strength caused by the travel from the transmitter to the receiver and caused by any object between. In the absence of objects between, a signal that has a short wave length experiences a high degree of attenuation nevertheless.
BER	Bit Error Rate. The ratio of incorrect data received to correct data received.
Bit Error Rate	Ratio of incorrect data received to correct the received data.
Connectorized	The cnRanger platform family connectorized radio solution provide RF port to connect external antenna. It gives the flexibility to connect various external antennas.
CRC Error Field	This field displays how many CRC errors occurred on the Ethernet controller.
DES	Data Encryption Standard. An over-the-air link option that uses secret 56-bit keys and 8 parity bits. DES performs a series of bit permutations, substitutions, and recombination operations on blocks of data.
DHCP	Dynamic Host Configuration Protocol defined in RFC 2131. Protocol that enables a device to assign a new IP address and TCP/IP parameters, including a default gateway, whenever the device reboots. Thus DHCP reduces configuration time, conserves IP addresses, and allows modules to move to a different network within the system. See http://www.faqs.org/rfcs/rfc2131.html . See also Static IP address assignment.
Ethernet Protocol	Any of several IEEE standards that define the contents of frames that are transferred from one network element to another through Ethernet connections.
ETSI	European Telecommunications Standards Institute
Fade Margin	The difference between strength of the received signal and the strength that the receiver requires for maintaining a reliable link. A higher fade margin is characteristic of a more reliable link. Standard operating margin.
FCC	Federal Communications Commission of the U.S.A.
File Transfer Protocol	Utility that transfers files through TCP (Transport Control Protocol) between computing devices that do not operate on the same platform. Defined in RFC 959. See http://www.faqs.org/rfcs/rfc959.html .
Free Space Path Loss	Signal attenuation that is naturally caused by atmospheric conditions and the distance between the antenna and the receiver.
Fresnel Zone	Space in which no object should exist that can attenuate, diffract, or reflect a transmitted signal before the signal reaches the target receiver.
FTP	File Transfer Protocol defined in RFC 959. Utility that transfers of files through TCP (Transport Control Protocol) between computing devices that do not operate on the same platform. See http://www.faqs.org/rfcs/rfc959.html .
Global Positioning System	Network of satellites that provides absolute time to networks on earth, which use the time signal to synchronize transmission and reception cycles (to avoid interference) and to provide reference for troubleshooting activities.
GPS	Global Positioning System. A network of satellites that provides absolute time to networks on earth, which use the time signal to synchronize transmission and reception

Term	Definition
	cycles (to avoid interference) and to provide reference for troubleshooting activities.
GUI	Graphical user interface.
HTTP	Hypertext Transfer Protocol used to make the Internet resources available on the World Wide Web. Defined in RFC 2068. See http://www.faqs.org/rfcs/rfc2068.html .
HTTPS	Hypertext Transfer Protocol Secure (HTTPS)
ICMP	Internet Control Message Protocols defined in RFC 792, used to identify Internet Protocol (IP)- level problems and to allow IP links to be tested. See http://www.faqs.org/rfcs/rfc792.html .
IP	Internet Protocol defined in RFC 791. The Network Layer in the TCP/IP protocol stack. This protocol is applied to addressing, routing, and delivering, and re-assembling data packets into the Data Link layer of the protocol stack. See http://www.faqs.org/rfcs/rfc791.html .
IP Address	32-bit binary number that identifies a network element by both network and host. See also Subnet Mask.
IPv4	Traditional version of Internet Protocol, which defines 32- bit fields for data transmission.
Line of Sight	Wireless path (not simply visual path) direct from module to module. The path that results provides both ideal aim and an ideal Fresnel zone.
LOS	Line of sight. The wireless path (not simply visual path) direct from module to module. The path that results provides both ideal aim and an ideal fresnel zone.
MAC Address	Media Access Control address. The hardware address that the factory assigns to the module for identification in the Data Link layer interface of the Open Systems Interconnection system. This address serves as an electronic serial number.
NAT	Network Address Translation defined in RFC 1631. A scheme that isolates Subscriber Modules from the Internet. See http://www.faqs.org/rfcs/rfc1631.html .
NEC	National Electrical Code. The set of national wiring standards that are enforced in the U.S.A.
Network Address Translation	Scheme that defines the Access Point Module as a proxy server to isolate registered Subscriber Modules from the Internet. Defined in RFC 1631. See http://www.faqs.org/rfcs/rfc1631.html .
PPS	Packet Per Second
Protective Earth	Connection to earth (which has a charge of 0 volts). Also known as ground.
Radio Signal Strength Indicator	Relative measure of the strength of a received signal. An acceptable link displays a Radio Signal Strength Indicator (RSSI) value of greater than 700.
Reflection	Change of direction and reduction of amplitude of a signal that encounters an object larger than the wavelength. Reflection may cause an additional copy of the wavelength to arrive after the original, unobstructed wavelength arrives. This causes partial cancellation of the signal and may render the link unacceptable. However, in some instances where the direct signal cannot be received, the reflected copy may be received and render an otherwise unacceptable link acceptable.
RF	Radio frequency. How many times each second a cycle in the antenna occurs, from positive to negative and back to positive amplitude.

Term	Definition
RJ-45	Standard cable that is typically used for Ethernet connection. This cable may be wired as straight-through or as crossover. Later modules auto-sense whether the cable is straight-through or crossover.
Router	Network element that uses the logical (IP) address of another to pass data to only the intended recipient. Compare to Switch and Bridge.
RSSI	Radio Signal Strength Indicator. A relative measure of the strength of a received signal. An acceptable link displays an RSSI value of greater than 700.
Self-interference	Interference with a module from another module in the same network.
SFP	Small Form-factor Pluggable
SM	Customer premises equipment (CPE) device that extends network or Internet services by communication with an Access Point Module or an Access Point cluster.
SNMP	See Simple Network Management Protocol, defined in RFC 1157.
SNMPv3	SNMP version 3
SNMP Trap	Capture of information that informs the network monitor through Simple Network Management Protocol of a monitored occurrence in the module.
Spatial Frequency	Spatial Frequency is associated with an LUID or SM registered with an AP and it is visible on both AP and SM GUIs. It is grouped into bins where each bin includes 32 consecutive spatial frequency values.
Static IP Address Assignment	Assignment of Internet Protocol address that can be changed only manually. Thus, static IP address assignment requires more configuration time and consumes more of the available IP addresses than DHCP address assignment does. RFC 2050 provides guidelines for the static allocation of IP addresses. See http://www.faqs.org/rfcs/rfc2050.html . See also DHCP.
Subnet Mask	32-bit binary number that filters an IP address to reveal what part identifies the network and what part identifies the host. The number of subnet mask bits that are set to 1 indicates how many leading bits of the IP address identify the network. The number of subnet mask bits that are set 0 indicate how many trailing bits of the IP address identify the host.
Subscriber Module	Customer premises equipment (CPE) device that extends network or Internet services by communication with an Access Point Module or an Access Point cluster.
Sustained Data Rate	Preset rate limit of data transfer.
Switch	Network element that uses the port that is associated with the physical address of another to pass data to only the intended recipient. Compare to Bridge and Router.
Sync	GPS (Global Positioning System) absolute time, which is passed from one module to another. Sync enables timing that prevents modules from transmitting or receiving interference. Sync also provides correlative time stamps for troubleshooting efforts.
TCP	Alternatively known as Transmission Control Protocol or Transport Control Protocol. The Transport Layer in the TCP/IP protocol stack. This protocol is applied to assure that data packets arrive at the target network element and to control the flow of data through the Internet. Defined in RFC 793. See http://www.faqs.org/rfcs/rfc793.html .
TDD	Time Division Duplexing. Synchronized data transmission with some time slots allocated to devices transmitting on the uplink and some to the device transmitting on the downlink.

Term	Definition
telnet	Utility that allows a client computer to update a server. A firewall can prevent the use of the telnet utility to breach the security of the server. See http://www.faqs.org/rfcs/rfc818.html , http://www.faqs.org/rfcs/rfc854.html , and http://www.faqs.org/rfcs/rfc855.html .
Tokens	Theoretical amounts of data. See also Buckets.
TxUnderrun Field	This field displays how many transmission-underrun errors occurred on the Ethernet controller.
UDP	User Datagram Protocol. A set of Network, Transport, and Session Layer protocols that RFC 768 defines. These protocols include checksum and address information but does not retransmit data or process any errors. See http://www.faqs.org/rfcs/rfc768.html .
udp	User-defined type of port.
LTE	Long-Term Evolution [cnRanger RRH & SM supports LTE licensed Band 38 (2570-2620 MHz) for Europe & LTE band 41 (2496 - 2690 MHz) for USA]
VID	VLAN identifier. See also VLAN.
VLAN	Virtual local area network. An association of devices through software that contains broadcast traffic, as routers would, but in the switch-level protocol.
VPN	Virtual private network for communication over a public network. One typical use is to connect remote employees, who are at home or in a different city, to their corporate network over the Internet. Any of several VPN implementation schemes is possible. SMS support L2TP over IPSec (Level 2 Tunneling Protocol over IP Security) VPNs and PPTP (Point to Point Tunneling Protocol) VPNs, regardless of whether the Network Address Translation (NAT) feature enabled.

Cambium Networks

Cambium Networks provides professional grade fixed wireless broadband and microwave solutions for customers around the world. Our solutions are deployed in thousands of networks in over 153 countries, with our innovative technologies providing reliable, secure, cost-effective connectivity that's easy to deploy and proven to deliver outstanding performance.

Our award-winning Point to Point (PTP) radio solutions operate in licensed, unlicensed and defined use frequency bands including specific FIPS 140-2 solutions for the U.S. Federal market. Ruggedized for 99.999% availability, our PTP solutions have an impeccable track record for delivering reliable high-speed backhaul connectivity even in the most challenging non-line-of-sight RF environments.

Our flexible Point-to-Multipoint (PMP) solutions operate in the licensed, unlicensed and federal frequency bands, providing reliable, secure, cost-effective access networks. With more than three million modules deployed in networks around the world, our PMP access network solutions prove themselves day-in and day-out in residential access, leased line replacement, video surveillance and smart grid infrastructure applications.

Cambium Networks solutions are proven, respected leaders in the wireless broadband industry. We design, deploy and deliver innovative data, voice and video connectivity solutions that enable and ensure the communications of life, empowering personal, commercial and community growth virtually everywhere in the world.

User Guides	http://www.cambiumnetworks.com/guides
Technical training	https://learning.cambiumnetworks.com
Support website	https://support.cambiumnetworks.com
Main website	http://www.cambiumnetworks.com
Sales enquiries	solutions@cambiumnetworks.com
Support enquiries	https://support.cambiumnetworks.com
Telephone number list	http://www.cambiumnetworks.com/contact-us/
Address	Cambium Networks Limited, Linhay Business Park, Eastern Road, Ashburton, Devon, TQ13 7UP United Kingdom



Cambium Networks and the stylized circular logo are trademarks of Cambium Networks, Ltd. All other trademarks are the property of their respective owners.

© Copyright 2021 Cambium Networks, Ltd. All rights reserved.