

Quick Installation Guide

For XD4 Models

XD4 Series High Density Access Points (APs) are a new class of zero touch APs within the Xirrus wireless portfolio. With four directional 802.11ac radios, a powerful integrated controller, application-level intelligence, automated provisioning, and optional cloud management, the APs deliver robust wireless connectivity in areas of medium to high user density. The XD4-130 has four 3x3 Wave 1 802.11ac radios, while the XD4-240 has four 4x4 Wave 2 802.11ac radios.



This Guide covers the steps required to install and start the AP. For detailed configuration information, see the *Xirrus Wireless AP User's Guide*.

1

You Need the Following Items

- ◆ Power and Ethernet connection(s) to your wired network using Cat 5e or Cat 6 cables. The AP has two Ethernet ports:
 - ◆ **GIG1/PoE**—This Gigabit port powers the AP via Power over Ethernet (PoE) using a Cat 5e or Cat 6 cable that also carries data traffic. See below for Power details. On the XD4-130, this is a one gigabit port. On the XD4-240, this is a 2.5 gigabit port.
 - ◆ (Optional) **GIG2**—Connection to this second, data-only one-gigabit port provides additional bandwidth. Use Cat 5E or Cat 6 cable.

AP must be connected to PoE networks without routing cabling to the outside plant. This ensures that cabling is not exposed to lightning strikes or possible crossover from high voltage lines. AP, PoE+ Injectors, or Switches must be installed and used indoors. The total Cat 5e or Cat 6 cable length from the switch to the AP must be no more than 100 m, including all cable segments.

- ◆ Power— See the matrix below to select a compatible PoE+ (IEEE802.3at) switch or Xirrus-supplied injector for your AP. If using an injector, you must provide a data connection from the switch to the injector as well as another cable from the injector's OUT port to the AP's GIGABIT1/PoE+ port. PoE+ injectors require an AC outlet.

AP Model	PoE+ Switch (802.3at) Generic	PoE+ Switch (802.3at) Xirrus	XP1-MSI-30	XP1-MSI-75M	XP1-MSI-75 (POE-75U-1UP-X)	XP8-MSI-70M	XP2-MSI-95M
XD4-130, XD4-240	✓	✓	✓	✓	✓	✓	✓

- ◆ Apply power to GIG1/POE port only—other AP Gigabit ports will not draw power if connected to a powered switch port, and AP LEDs will not light.
- ◆ If you are using an 802.3at PoE+ enabled switch, it is imperative that you know that the switch has sufficient power budget to power all connected devices.
- ◆ All Xirrus XD4 APs are Type 2, Class 4 PoE-802.3at devices. If your switch vendor provides a setting for the type of powered-device detection with options such as Legacy, 4-Point, or BOTH, set the port to BOTH or 4-Point. Do not use settings intended for legacy devices.

XD Series High Density Access Points

- ◆ Workstation with a Web browser to configure the AP via the Xirrus Management System or directly via the AP's Windows Management Interface (WMI).
- ◆ A 7/16" nut driver to attach the mounting plate to the bracket or clips. (See "Install Mounting Hardware and AP" on page 3.) Note that you cannot use old T-bar clips from XN or XS APs with the XD4 Series.
- ◆ For a locked installation, supply a zip-tie, small lock, or other locking hardware.

NOTE: Leave protective plastic film on the AP until installation is complete, to avoid leaving marks on the AP.

Mounting Options

- ◆ Direct Ceiling Mount—for a more secure mount, use the furnished mounting plate with four user-supplied screws. Or you may mount directly to a ceiling with two user-supplied screws (we recommend max screw size #8, Pan Head type). You must use screws that are that are appropriate for the construction type of the mounting site.

AP Mounting Plate (front, mounted)

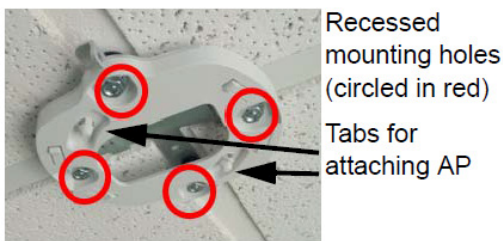

- ◆ Suspended Ceiling Grid Mount—See photos above and on [page 4](#). Use the mounting plate with the T-Bar Bracket for 15/16" ceiling grid or with T-Bar clips (for 15/16" ceiling grid).

2

Choose a Suitable Location

- ◆ Choose an indoor location that is central to your users, and that is away from heat sources.
- ◆ The AP should be installed parallel to the ground (i.e., in a horizontal position, not tilted on its side). The AP should not be more than 30 feet above the ground (or the level at which receiving devices will be used). For atypical installations, please verify the resulting signal coverage.
- ◆ The location must be capable of supporting the weight of the AP and the mounting bracket (about 3 lb total).
- ◆ For optimal placement, we recommend that a predictive survey be performed by a qualified Xirrus partner.
- ◆ Maintain a distance of at least 50 feet between additional APs.
- ◆ Keep the unit away from electrical devices or appliances that generate RF noise—at least 3 to 6 ft (1m - 2m).
- ◆ To ensure good air flow, it is essential that the AP's vents are not blocked.
- ◆ XD4 radios are directional as indicated below.

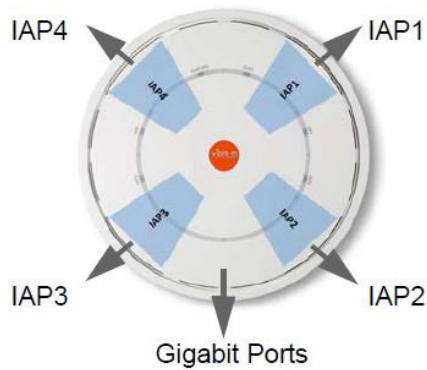

ORIENTATION OF RADIOS

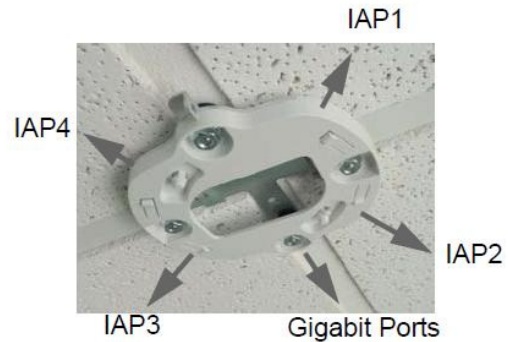

3

Install Mounting Hardware and AP

- ♦ 3A—Ceiling Mount with Mounting Plate
- ♦ 3B—Direct Ceiling Mount without Mounting Plate
- ♦ 3C—Ceiling Grid Mount with Mounting Plate

3A—Ceiling Mount with Mounting Plate

The following steps use a mounting plate, which offers a more secure mount, ease of dismount, and a locking option for the AP.

1. Use the four holes on the AP mounting plate to mark the placement of four user-supplied screws to install in the ceiling.
2. Drill and prepare holes for the screws as appropriate.
3. Cut an access hole for the cable(s) in the ceiling and draw enough cable through to attach to the AP after it is installed.
4. Align the AP mounting plate over the prepared holes. Secure the plate with the screws. Do not over-tighten.
5. Proceed to “Connect Cables and Install AP” on page 5.



3B—Direct Ceiling Mount without Mounting Plate

To attach the AP directly to the ceiling, use the mounting holes on the back of the AP, indicated in red in the photo.

You need two screws of an appropriate type for the construction type at the mounting site. We suggest screw size #8, Pan Head.

NOTE: The AP must not be disassembled - do not remove the back of the AP to tighten the screws after mounting.

1. If the mounting plate is attached to the back of the AP, remove it by pushing it down and rotating it to the left. Remove the locking slug, if any, from the



XD Series High Density Access Points

back of the AP. (See photo for Step 4 on page 5. If you ever need to reinstall the slug, push it in with the small protruding bump facing towards the nearer mounting slot.)

2. Mark the locations for the two mounting screws on the ceiling—the centers are 3.5" (8.9 cm) apart. You may use the "Direct Mounting Template" on page 7.
3. Cut an access hole for the cable(s) in the ceiling and draw enough cable through to attach to the AP after it is installed.
4. Install two screws in the ceiling so that they protrude 1/8" (.3 cm) between the mounting surface and the head of the screw.
5. Proceed to "Connect Cables and Install AP" on page 5.

3C—Ceiling Grid Mount with Mounting Plate

1. If using the T-Bar bracket for a standard 15/16" ceiling grid, just twist its built-in clips onto the grid with the bracket's bolts facing down. For a slotted grid, slide the heads of the T-bolts into the grid's slot (easiest to do at an intersection), position them for the two holes in the T-Bar Bracket, and twist bolts till snug in the slot. Secure bracket with nuts, with the bracket's bolts pointing down. Skip to Step 3 below.

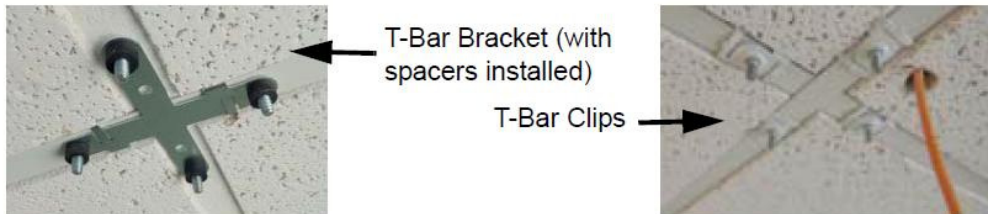

2. If using T-Bar clips, use the four holes on the AP mounting plate to mark the placement of the four T-bar clips on the metal ceiling support grid.

NOTE: You MUST use the mounting studs furnished with the T-BAR clips. You cannot use old T-bar clips from XN or XS APs with the XR or XD Series. Old clips and studs will damage the AP case.

Twist the four T-bar clips onto the metal ceiling grid at the marked locations and tighten the screw posts to 10-12 lbf.ft (1.38-1.66 kgf.m). Do not over-tighten the screw posts.

3. Cut an access hole in the ceiling tile and draw the cable(s) through.
4. Align the AP mounting plate over the screw posts of the T-Bar bracket or clips and secure it to the four posts using the nuts provided. Tighten the nuts to 10-12 lbf.ft (1.38-1.66 kgf.m), but do not over-tighten.
5. Proceed to "Connect Cables and Install AP" on page 5.



4

Connect Cables and Install AP

1. Connect the cable that carries power and data to GIG1/PoE (shown in red). If you use a Xirrus-supplied injector, its CONNECT LED should light (for 70W and higher injectors, it is OK if it blinks). If power is being properly supplied, the AP's LEDs will light and then commence blinking in their rotating boot pattern. A second data connection may be plugged into GIG2 (optional).
2. Align the two slots on the back of the AP chassis with the corresponding tabs on the AP mounting plate, shown here. If using a mounting plate with a locking tab, make sure that the AP's locking slug (see photo in Step 4 below) will line up with the matching hole on the mounting plate's locking tab.
3. Push the AP chassis up on the mounting plate tabs (or the screw heads, if attaching directly to ceiling) and rotate the AP to the right until it snaps in place.
4. To secure the AP to the mounting plate for tamper evidence or to deter removal, feed a customer-provided zip tie or other locking hardware through the hole in the top of the locking slug (circled at right) and the matching locking tab on the mounting plate.
5. Remove the protective plastic film from the unit.

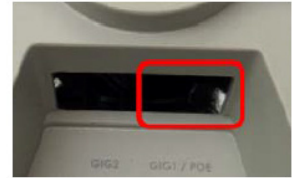

5

Zero-Touch Provisioning and Ongoing Management

Most customers employ the Xirrus Management System (XMS) for the initial setup and continuing management of Xirrus devices. XMS users can readily set up their new devices for zero-touch provisioning and ongoing maintenance via the following platforms. Wait five minutes after powering up the AP to automatically discover it, then use XMS to view and manage it. Newly discovered APs are automatically assigned to the XMS “default” profile, and will receive the configuration defined for that profile.

- ◆ XMS-Cloud—performs zero-touch provisioning. Your new APs appear in XMS even before you receive your equipment. When the email arrives with your login information, use XMS-Cloud to specify the initial settings for your APs. A Guided Tour will walk you through the basic steps of creating a profile containing configuration settings, including creating SSIDs and firewall/application control rules. Once the installed AP has Internet connectivity, it will automatically contact Xirrus for cloud-based zero-touch provisioning per your settings, install the latest applicable license, and upgrade the AP to the latest software version as appropriate.
- ◆ XMS-Enterprise—detects and provisions new Xirrus devices deployed in your network. Create and configure a default profile for newly added APs, then set up discovery for the APs’ subnetwork. New devices will automatically receive the configuration defined in the default profile.

If you are not using XMS, please see the *Xirrus Wireless AP User’s Guide* to configure your AP manually via the Express Setup menu option. The User Guide is available from <http://support.xirrus.com> (login required). Select the Libraries tab and click the ArrayOS - XR Platform Latest Release link.

6

Using the Reset Button

The reset button returns the AP to factory default settings while rebooting. It is located on the bottom of the unit. Use the reset button as follows:

- ◆ Unplug the cable from the GIG1/PoE port.
- ◆ Press the reset button all the way (there should be a faint click) and hold it.
- ◆ Plug the cable back in and continue to keep the button pressed for 10 seconds. This triggers the factory default reset during the boot process.



7

Specifications and Drawings

Physical/Environmental Specifications

- ◆ Dimensions (WxDxH): 10 x 10 x 2.5 in / 25.4 x 25.4 x 6.4 cm
- ◆ Weight: 2 lb / 0.9 kg
- ◆ Operating Temperature: 0-50°C / 32-131°F, 0-90% humidity, non-condensing.

XD4 Mounting Bracket

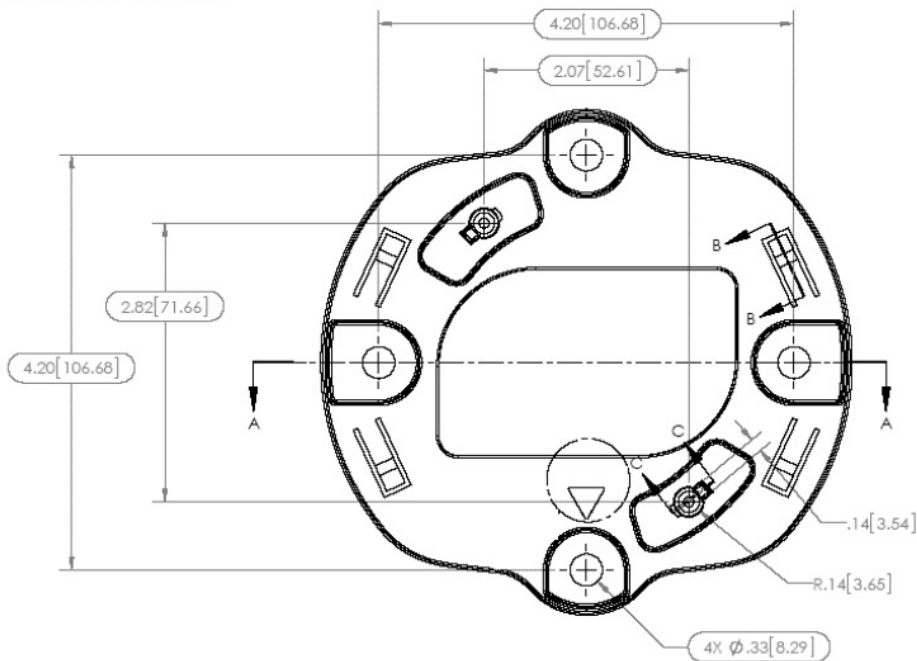

Direct Mounting Template

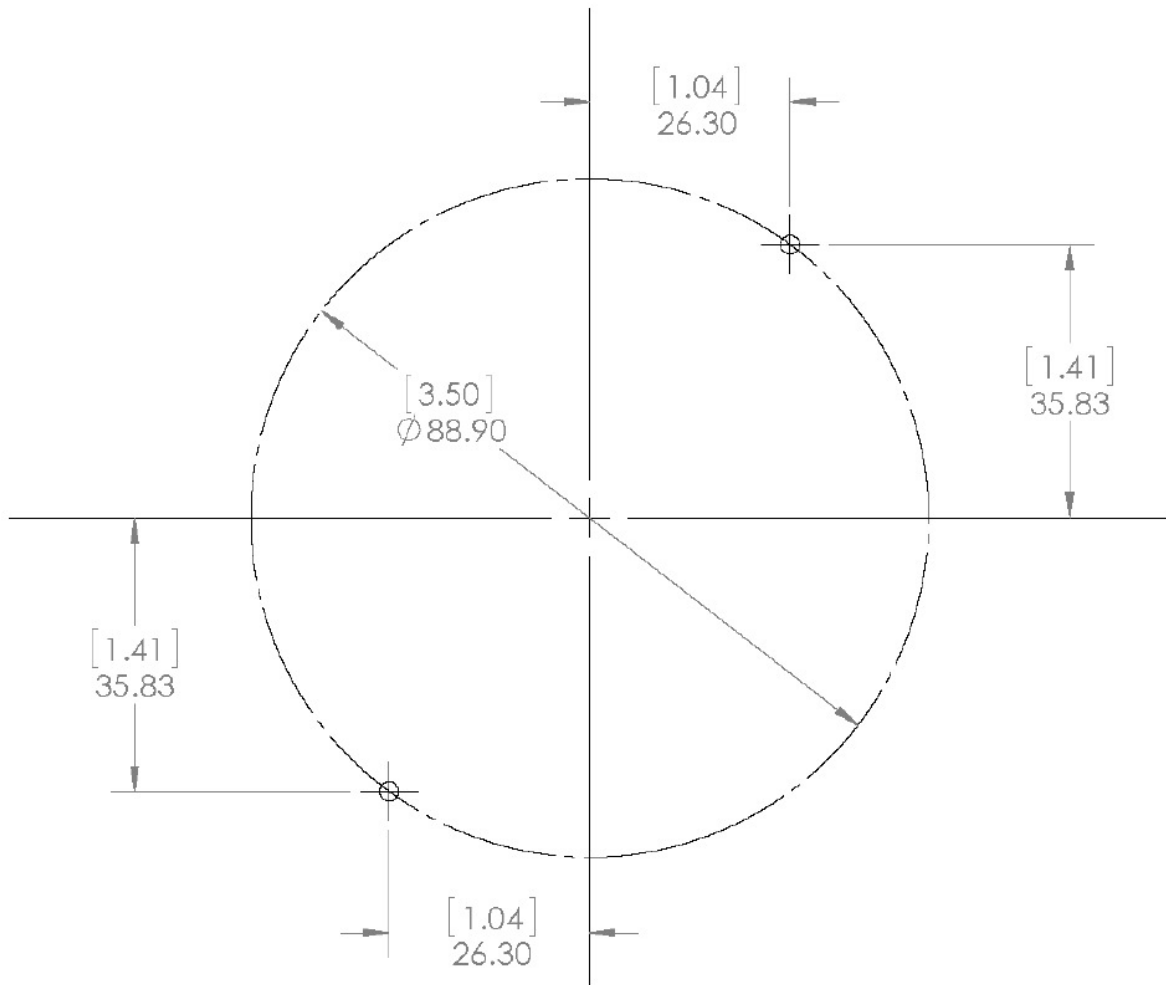

1.800.947.7871 Toll Free in the US
+1.805.262.1600 Sales
+1.805.262.1601 Fax
2101 Corporate Center Drive
Thousand Oaks, CA 91320, USA

To learn more visit:
xirus.com or
email info@xirus.com

Appendix C: Notices (XD and XR500/600 Series Only)



This Appendix contains Notices, Warnings, and Compliance information for the XD and XR500/600 Series only.

For Notices, Warnings, and Compliance information for outdoor products, please see the Quick Installation Guide for that product.

For Notices, Warnings, and Compliance information for all other APs, please see “Notices (XR-1000 to XR-6000 Indoor Models)” on page 559.

This appendix contains the following information:

- “Notices” on page 541
- “EU Directive 1999/5/EC Compliance Information” on page 546
- “Compliance Information (Non-EU)” on page 553
- “Safety Warnings” on page 554
- “Translated Safety Warnings” on page 555
- “Software License and Product Warranty Agreement” on page 556
- “Hardware Warranty Agreement” on page 556

Notices

Wi-Fi Alliance Certification



www.wi-fi.org

FCC Notice

This equipment has been tested and found to comply with the limits for a Class A digital device, pursuant to Part 15 of the FCC rules. These limits are designed to provide reasonable protection against harmful interference in a residential installation. This equipment generates, uses and can radiate RF energy and, if not

installed and used in accordance with the instructions, may cause harmful interference to radio communications. However, there is no guarantee that interference will not occur in a particular installation. If this equipment does cause harmful interference to radio or television reception, which can be determined by turning the equipment off and on, the user is encouraged to try to correct the interference by one or more of the following safety measures:

- Reorient or relocate the receiving antenna.
- Increase the separation between the equipment and the receiver.
- Connect the equipment into an outlet on a circuit different from that to which the receiver is connected.
- Consult the dealer or an experienced wireless technician for help.

! *FCC Caution: Any changes or modifications not expressly approved by the party responsible for compliance could void the user's authority to operate this equipment.*

This device complies with Part 15 of the FCC Rules, with operation subject to the following two conditions: (1) This device may not cause harmful interference, and (2) this device must accept any interference received, including interference that may cause unwanted operation.

For XD2 models available in the USA/Canada market, only channels 1~11 can be operated in the 2.4GHz band. Selection of other channels is not possible.

This device and its antenna(s) must not be co-located or operating in conjunction with any other antenna or transmitter except in accordance with FCC multi-transmitter product procedures.

This device is restricted for indoor use.

Use of a shielded twisted pair (STP) cable must be used for all Ethernet connections in order to comply with EMC requirements.

Operations in the 5.15-5.25GHz band are restricted to indoor usage only.

IMPORTANT NOTE: FCC Radiation Exposure Statement

This equipment complies with FCC radiation exposure limits set forth for an uncontrolled environment. To ensure compliance with FCC and Industry Canada

RF exposure requirements, this device must be installed in a location where the antennas of the device will have a minimum distance of at least 30 cm (12 inches) from all persons, except that XD2 models must have a minimum distance of at least 20 cm (8 inches) from all persons. Using higher gain antennas and types of antennas not certified for use with this product is not allowed. The device shall not be co-located with another transmitter.

High Power Radars

High power radars are allocated as primary users (meaning they have priority) in the 5250MHz to 5350MHz and 5650MHz to 5850MHz bands. These radars could cause interference and/or damage to LE-LAN devices.

Non-Modification Statement

Unauthorized changes or modifications to the device are not permitted. Use only the supplied internal antenna, or external antennas supplied by the manufacturer. Modifications to the device will void the warranty and may violate FCC regulations.

Cable Runs for Power over Ethernet (PoE)

If using PoE, the AP must be connected to PoE networks without routing cabling to the outside plant—this ensures that cabling is not exposed to lightning strikes or possible cross over from high voltage.

Battery Warning

- ! *Caution! The AP contains a battery which is not to be replaced by the customer. Danger of Explosion exists if the battery is incorrectly replaced. Replace only with the same or equivalent type recommended by the manufacturer. Dispose of used batteries according to the manufacturer's instructions.*

UL Statement

Use only with listed ITE product.

Industry Canada Statement (XD Series)

This device complies with Industry Canada license-exempt RSS standards (RSS 247), and standards for Digital Transmission Systems (DTSs), Frequency Hopping Systems (FHSs) and License-Exempt Local Area Network (LE-LAN) Devices. Operation is subject to the following two conditions: (1) this device may not cause interference, and (2) this device must accept any interference, including interference that may cause undesired operation of the device.

Le présent appareil est conforme aux CNR d'Industrie Canada applicables aux appareils radio exempts de licence. L'exploitation est autorisée aux deux conditions suivantes: (1) l'appareil ne doit pas produire de brouillage, et (2) l'utilisateur de l'appareil doit accepter tout brouillage radioélectrique subi, même si le brouillage est susceptible d'en compromettre le fonctionnement.

For product available in the USA/Canada market, only channel 1~11 can be operated. Selection of other channels is not possible.

Pour les produits disponibles aux États-Unis / Canada du marché, seul le canal 1 à 11 peuvent être exploités. Sélection d'autres canaux n'est pas possible.

This device and its antenna(s) must not be co-located or operating in conjunction with any other antenna or transmitter except in accordance with IC multi-transmitter product procedures.

Cet appareil et son antenne (s) ne doit pas être co-localisés ou fonctionnement en association avec une autre antenne ou transmetteur.

Dynamic Frequency Selection (DFS) for devices operating in the bands 5250- 5350 MHz, 5470-5600 MHz and 5650-5725 MHz

Sélection dynamique de fréquences (DFS) pour les dispositifs fonctionnant dans les bandes 5250-5350 MHz, 5470-5600 MHz et 5650-5725 MHz

The device for operation in the band 5150-5250 MHz is only for indoor use to reduce the potential for harmful interference to co-channel mobile satellite systems.

Les dispositifs fonctionnant dans la bande 5150-5250 MHz sont réservés uniquement pour une utilisation à l'intérieur afin de réduire les risques de brouillage préjudiciable aux systèmes de satellites mobiles utilisant les mêmes canaux.

Users should also be advised that high-power radars are allocated as primary users (i.e. priority users) of the bands 5250-5350 MHz and 5650-5850 MHz and that these radars could cause interference and/or damage to LE-LAN devices.

De plus, les utilisateurs devraient aussi être avisés que les utilisateurs de radars de haute puissance sont désignés utilisateurs principaux (c.-à-d., qu'ils ont la priorité) pour les bandes 5250-5350 MHz et 5650-5850 MHz et que ces radars pourraient causer du brouillage et/ou des dommages aux dispositifs LAN-EL.

For indoor use only.

Pour une utilisation en intérieur uniquement.

IMPORTANT NOTE:

IC Radiation Exposure Statement:

This equipment complies with IC RSS-102 radiation exposure limits set forth for an uncontrolled environment. This equipment should be installed and operated with minimum distance 20 cm between the radiator and your body.

Cet équipement est conforme aux limites d'exposition aux rayonnements IC établies pour un environnement non contrôlé. Cet équipement doit être installé et utilisé avec un minimum de 20 cm de distance entre la source de rayonnement et votre corps.



EU Directive 1999/5/EC Compliance Information



This Appendix contains Notices, Warnings, and Compliance information for the XD and XR500/600 Series only. For other models, see the notes at the beginning of this appendix.

This section contains compliance information for the Xirrus Wireless AP family of products. The compliance information contained in this section is relevant to the European Union and other countries that have implemented the EU Directive 1999/5/EC.

Declaration of Conformity

- Cesky [Czech]** Toto zařízení je v souladu se základními požadavky a ostatními odpovídajícími ustanoveními Směrnice 1999/5/EC.
- Dansk [Danish]** Dette udstyr er i overensstemmelse med de væsentlige krav og andre relevante bestemmelser i Direktiv 1999/5/EF.
- Deutsch [German]** Dieses Gerät entspricht den grundlegenden Anforderungen und den weiteren entsprechenden Vorgaben der Richtlinie 1999/5/EU.
- Eesti [Estonian]** See seande vastab direktiivi 1999/5/EU oluliste nõuetele ja teistele asjakohastele sätetele.
- English** This equipment is in compliance with the essential requirements and other relevant provisions of Directive 1999/5/EC.
- Español [Spain]** Este equipo cumple con los requisitos esenciales así como con otras disposiciones de la Directiva 1999/5/CE.
- Ελληνική [Greek]** Αυτό το εξοπλισμός είναι σε συμμόρφωση με τις ουσιαστικές απαιτήσεις και άλλες σχετικές διατάξεις της Οδηγίας 1999/5/EC.

- Français [French]** Cet appareil est conforme aux exigences essentielles et aux autres dispositions pertinentes de la Directive 1999/5/EC.
- Íslenska [Icelandic]** Þetta tæki er samkvæmt grunnkröfum og öðrum viðeigandi ákvæðum Tilskipunar 1999/5/EC.
- Italiano [Italian]** Questo apparato é conforme ai requisiti essenziali ed agli altri principi sanciti dalla Direttiva 1999/5/CE.
- Latviski [Latvian]** Šī iekārta atbilst Direktīvas 1999/5/EK būtiskajā prasībām un citiem ar to saistītajiem noteikumiem.
- Lietuvių [Lithuanian]** Šis įrenginys tenkina 1995/5/EB Direktyvos esminius reikalavimus ir kitas šios direktyvos nuostatas.
- Nederlands [Dutch]** Dit apparant voldoet aan de essentiële eisen en andere van toepassing zijnde bepalingen van de Richtlijn 1995/5/EC.
- Malti [Maltese]** Dan l-apparant huwa konformi mal-htigiet essenzjali u l-provedimenti l-oħra rilevanti tad-Direttiva 1999/5/EC.
- Margyar [Hungarian]** Ez a készülék teljesíti az alapvető követelményeket és más 1999/5/EK irányelvben meghatározott vonatkozó rendelkezéseket.
- Norsk [Norwegian]** Dette utstyret er i samsvar med de grunnleggende krav og andre relevante bestemmelser i EU-direktiv 1999/5/EF.
- Polski [Polish]** Urządzenie jest zgodne z ogólnymi wymaganiami oraz szczególnymi mi warunkami określony mi Dyrektywą. UE:1999/5/EC.
- Português [Portuguese]** Este equipamento está em conformidade com os requisitos essenciais e outras provisões relevantes da Directiva 1999/5/EC.

- Slovensko [Slovenian]** Ta naprava je skladna z bistvenimi zahtevami in ostalimi relevantnimi popoji Direktive 1999/5/EC.
- Slovensky [Slovak]** Toto zariadenie je v zhode so základnými požiadavkami a inými príslušnými nariadeniami direktiv: 1999/5/EC.
- Suomi [Finnish]** Tämä laite täyttää direktiivin 1999/5//EY olennaiset vaatimukset ja on siinä asetettujen muiden laitetta koskevien määräysten mukainen.
- Svenska [Swedish]** Denna utrustning är i överensstämmelse med de väsentliga kraven och andra relevanta bestämmelser i Direktiv 1999/5/EC.

Assessment Criteria

The following standards were applied during the assessment of the product against the requirements of the Directive 1999/5/EC:

- Radio: EN 301 893 and EN 300 328 (if applicable)
- EMC: EN 301 489-1 and EN 301 489-17
- Safety: EN 60950, EN 62311 and EN 50385

CE Marking

For the Xirrus Wireless AP, the CE mark and Class-2 identifier opposite are affixed to the equipment and its packaging:



Russian Certification Marking

For the Xirrus XR-500, XR-520H, XR-2000, and XR-4000 Series Wireless APs, the approval mark is affixed to the equipment:



WEEE Compliance



- Natural resources were used in the production of this equipment.
- This equipment may contain hazardous substances that could impact the health of the environment.
- In order to avoid harm to the environment and consumption of natural resources, we encourage you to use appropriate take-back systems when disposing of this equipment.
- The appropriate take-back systems will reuse or recycle most of the materials of this equipment in a way that will not harm the environment.
- The crossed-out wheeled bin symbol (in accordance with European Standard EN 50419) invites you to use those take-back systems and advises you not to combine the material with refuse destined for a land fill.
- If you need more information on collection, re-use and recycling systems, please contact your local or regional waste administration.
- Please contact Xirrus for specific information on the environmental performance of our products.



National Restrictions

In the majority of the EU and other European countries, the 2.4 GHz and 5 GHz bands have been made available for the use of Wireless LANs. The following table provides an overview of the regulatory requirements in general that are applicable for the 2.4 GHz and 5 GHz bands.

Frequency Band (MHz)	Max Power Level (EIRP) (mW)	Indoor	Outdoor
2400–2483.5	100	X	X **
5250–5350 *	200	X	N/A
5470–5725*	1000	X	X

**Dynamic frequency selection and Transmit Power Control is required in these frequency bands.*

***France is indoor use only in the upper end of the band.*

The requirements for any country may change at any time. Xirrus recommends that you check with local authorities for the current status of their national regulations for both 2.4 GHz and 5 GHz wireless LANs.

The following countries have additional requirements or restrictions than those listed in the above table:

Belgium

The Belgian Institute for Postal Services and Telecommunications (BIPT) must be notified of any outdoor wireless link having a range exceeding 300 meters. Xirrus recommends checking at www.bipt.be for more details.

Draadloze verbindingen voor buitengebruik en met een reikwijdte van meer dan 300 meter dienen aangemeld te worden bij het Belgisch Instituut voor postdiensten en telecommunicatie (BIPT). Zie www.bipt.be voor meer gegevens.

Les liaisons sans fil pour une utilisation en extérieur d'une distance supérieure à 300 mètres doivent être notifiées à l'Institut Belge des services Postaux et des Télécommunications (IBPT). Visitez www.bipt.be pour de plus amples détails.

Greece

A license from EETT is required for the outdoor operation in the 5470 MHz to 5725 MHz band. Xirrus recommends checking www.eett.gr for more details.

Η δη ιουρυβάικτ ωνεξωτερικου ρουστη ζ νησν νοτ των 5470–5725 MHz ε ιτρ ετάιωνο ετάά όάδειά της EETT, ον ορηγεβτάι στερά ά ό σ φωνη γν η του ΓΕΕΘΑ. ερισσότερες λε τομ ρειεωστο www.eett.gr

Italy

This product meets the National Radio Interface and the requirements specified in the National Frequency Allocation Table for Italy. Unless this wireless LAN product is operating within the boundaries of the owner's property, its use requires a "general authorization." Please check with www.comunicazioni.it/it/ for more details.

Questo prodotto é conforme alla specifiche di Interfaccia Radio Nazionali e rispetta il Piano Nazionale di ripartizione delle frequenze in Italia. Se non viene installato all'interno del proprio fondo, l'utilizzo di prodotti wireless LAN richiede una "autorizzazione Generale." Consultare www.comunicazioni.it/it/ per maggiori dettagli.

Norway, Switzerland and Liechtenstein

Although Norway, Switzerland and Liechtenstein are not EU member states, the EU Directive 1999/5/EC has also been implemented in those countries.

Calculating the Maximum Output Power

The regulatory limits for maximum output power are specified in EIRP (radiated power). The EIRP level of a device can be calculated by adding the gain of the antenna used (specified in dBi) to the output power available at the connector (specified in dBm).

Antennas

The Xirrus Wireless AP employs integrated antennas that cannot be removed and which are not user accessible. Nevertheless, as regulatory limits are not the same throughout the EU, users may need to adjust the conducted power setting for the radio to meet the EIRP limits applicable in their country or region. Adjustments can be made from the product's management interface—either Web Management Interface (WMI) or Command Line Interface (CLI).

Operating Frequency

The operating frequency in a wireless LAN is determined by the access point. As such, it is important that the access point is correctly configured to meet the local regulations. See [National Restrictions](#) in this section for more information.

If you still have questions regarding the compliance of Xirrus products or you cannot find the information you are looking for, please contact us at:

Xirrus, Inc.
2101 Corporate Center Drive
Thousand Oaks, CA 91320
USA
Tel: 1.805.262.1600
1.800.947.7871 Toll Free in the US
Fax: 1.866.462.3980
www.xirrus.com

Compliance Information (Non-EU)



This Appendix contains Notices, Warnings, and Compliance information for the XD and XR500/600 Series only. For other models, see the notes at the beginning of this appendix.

This section contains compliance information for the Xirrus Wireless AP family of products. The compliance information contained in this section is relevant to the listed countries (outside of the European Union and other countries that have implemented the EU Directive 1999/5/EC).

Declaration of Conformity—Brazil

For XR-500 Only



Declaration of Conformity

Mexico XR-520: Dictamen #: 1402D00742
XR-600: Dictamen #: 1402CE08098



XR-520: Cofetel Cert #: RCPXIXR13-1003

Thailand This telecommunication equipment conforms to NTC technical requirement.

Safety Warnings



This Appendix contains Notices, Warnings, and Compliance information for the XD and XR500/600 Series only. For other models, see the notes at the beginning of this appendix.



Safety Warnings

Read all user documentation before powering this device. All Xirrus interconnected equipment should be contained indoors. This product is not suitable for outdoor operation. Please verify the integrity of the system ground prior to installing Xirrus equipment. Additionally, verify that the ambient operating temperature does not exceed 50°C (40°C for the XR500/600 Series).



Circuit Breaker Warning

The XR Series Wireless AP relies on the building's installation for over current protection. Ensure that a fuse or circuit breaker no larger than 120 VAC, 15A (U.S.) or 240 VAC, 10A (International) is used on all current-carrying conductors.

- ! **Explosive Device Proximity Warning**
Do not operate the XR Series Wireless AP near unshielded blasting caps or in an explosive environment unless the device has been modified to be especially qualified for such use.
- ! **Lightning Activity Warning**
Do not work on the XR Series Wireless AP or connect or disconnect cables during periods of lightning activity.

Translated safety warnings appear below.

Translated Safety Warnings



This Appendix contains Notices, Warnings, and Compliance information for the XD and XR500/600 Series only. For other models, see the notes at the beginning of this appendix.

Avertissements de Sécurité

- ! **Sécurité**
Lisez l'ensemble de la documentation utilisateur avant de mettre cet appareil sous tension. Tous les équipements Xirrus interconnectés doivent être installés en intérieur. Ce produit n'est pas conçu pour être utilisé en extérieur. Veuillez vérifier l'intégrité de la terre du système avant d'installer des équipements Xirrus. Vérifiez également que la température de fonctionnement ambiante n'excède pas 50°C (40°C pour XR-520).
- ! **Proximité d'appareils explosifs**
N'utilisez pas l'unité XR Wireless AP à proximité d'amorces non blindées ou dans un environnement explosif, à moins que l'appareil n'ait été spécifiquement modifié pour un tel usage.

-  **Foudre**
N'utilisez pas l'unité XR Wireless AP et ne branchez pas ou ne débranchez pas de câbles en cas de foudre.

-  **Disjoncteur**
L'unité XR Wireless AP dépend de l'installation du bâtiment pour ce qui est de la protection contre les surintensités. Assurez-vous qu'un fusible ou qu'un disjoncteur de 120 Vca, 15 A (États-Unis) ou de 240 Vca, 10 A (International) maximum est utilisé sur tous les conducteurs de courant.

Software License and Product Warranty Agreement

For Software License and Product Warranty information, please see <http://www.xirrus.com/support/eula/>.

Hardware Warranty Agreement

For Hardware Warranty information, please see <http://www.xirrus.com/support/eula/>.

