



## Wi-Fi Arrays

**DRAFT**

December 17, 2010  
Release 5.0





# Wi-Fi Array™

XR4420, XR4430, XR4820, XR4830

XN16, XN12, XN8, XN4

XS16, XS8, XS4

All rights reserved. This document may not be reproduced or disclosed in whole or in part by any means without the written consent of Xirrus, Inc.

**Part Number: 800-0xxx-001**  
(Revision A)



## Trademarks

**XIRRUS** is a registered trademark of Xirrus, Inc. All other trademarks and brand names are marks of their respective holders.

Please see Legal Notices, Warnings, Compliance Statements, and Warranty and License Agreements in “Appendix F: Notices” on page 467.

Xirrus, Inc.

2101 Corporate Center Drive

Thousand Oaks, CA 91320

USA

Tel: 1.805.262.1600

1.800.947.7871 Toll Free in the US

Fax: 1.866.462.3980

*[www.xirrus.com](http://www.xirrus.com)*

# Table of Contents

<b>List of Figures</b> .....	<b>xi</b>
<b>Introduction</b> .....	<b>1</b>
The Xirrus Family of Products .....	2
Nomenclature .....	4
About this User’s Guide .....	5
Organization .....	5
Notes and Cautions .....	7
Screen Images .....	7
Your User’s Guide as a PDF Document .....	7
Hyperlinks .....	7
Window or Page? .....	7
Why Choose the Xirrus Wi-Fi Array? .....	8
Wi-Fi Array Product Overview .....	9
Enterprise Class Security .....	9
Wi-Fi Array Product Family .....	10
XR4000 Family of Arrays .....	10
XN Family of Arrays .....	11
XS Family of Arrays .....	12
Deployment Flexibility .....	13
Power over Gigabit Ethernet (PoGE) .....	14
Enterprise Class Management .....	14
Key Features and Benefits .....	17
High Capacity and High Performance .....	17
Extended Coverage .....	18
Flexible Coverage Schemes .....	19
Non-Overlapping Channels .....	19
SDMA Optimization .....	20
Fast Roaming .....	20
Easy Deployment .....	20
Secure Wireless Access .....	20
Applications Enablement .....	20
Advanced Feature Sets .....	20

---

Xirrus Advanced RF Performance Manager (RPM)	21
Xirrus Advanced RF Security Manager (RSM)	22
Xirrus Advanced RF Analysis Manager (RAM)	22
Product Specifications—XR4400 and XR4800 Series	23
Product Specifications—XN16, XN12, and XN8	31
Product Specifications—XN4	38
Product Specifications—XS16 and XS8	45
Product Specifications—XS4	51
<b>Installing the Wi-Fi Array</b>	<b>57</b>
Installation Prerequisites	57
Optional Network Components	59
Client Requirements	59
Planning Your Installation	60
General Deployment Considerations	60
Coverage and Capacity Planning	62
Placement	62
RF Patterns	63
Capacity and Cell Sizes	65
Fine Tuning Cell Sizes	66
Roaming Considerations	67
Allocating Channels	67
Deployment Examples	70
IEEE 802.11n Deployment Considerations	72
MIMO (Multiple-In Multiple-Out)	73
Multiple Data Streams—Spatial Multiplexing	75
Channel Bonding	76
Improved MAC Throughput	77
Short Guard Interval	77
Obtaining Higher Data Rates	78
802.11n Capacity	79
Failover Planning	80
Port Failover Protection	80
Switch Failover Protection	81
Power Planning	82
AC Power	82
Power over Gigabit Ethernet	82

---

Security Planning .....	83
Wireless Encryption .....	83
Authentication .....	83
Meeting PCI DSS Standards .....	84
Meeting FIPS Standards .....	84
Port Requirements .....	86
Network Management Planning .....	89
WDS Planning .....	90
Common Deployment Options .....	93
Installation Workflow .....	94
Installing Your Wi-Fi Array .....	96
Choosing a Location .....	96
Wiring Considerations .....	97
Mounting the Array .....	99
Dismounting the Array .....	99
Powering Up the Wi-Fi Array .....	100
Array LED Operating Sequences .....	101
LED Boot Sequence .....	101
LED Operation when Array is Running .....	102
Establishing Communication with the Array .....	103
Using the Serial Port .....	103
Using the Ethernet Ports .....	103
Logging In .....	104
Entering the License .....	104
Performing the Express Setup Procedure .....	106
Procedure for Performing an Express Setup .....	107
<b>The Web Management Interface .....</b>	<b>113</b>
An Overview .....	114
Structure of the WMI .....	115
User Interface .....	117
Utility Buttons .....	119
Logging In .....	121
Applying Configuration Changes .....	121
Character Restrictions .....	121

---

<b>Viewing Status on the Wi-Fi Array</b> .....	<b>123</b>
Array Status Windows .....	123
Array Summary .....	124
Content of the Array Summary Window .....	124
Array Information .....	127
Array Configuration .....	128
Admin History .....	129
Network Status Windows .....	129
Network .....	130
Network Map .....	131
Content of the Network Map Window .....	131
Spanning Tree Status .....	133
Routing Table .....	135
ARP Table .....	135
DHCP Leases .....	136
Connection Tracking/NAT .....	136
CDP Neighbors .....	137
Network Assurance .....	138
RF Monitor Windows .....	139
IAPs .....	140
Spectrum Analyzer .....	141
Intrusion Detection .....	145
Station Status Windows .....	147
Stations .....	148
Location Map .....	149
RSSI .....	153
Signal-to-Noise Ratio (SNR) .....	155
Noise Floor .....	157
Max by IAP .....	159
Statistics Windows .....	160
IAP Statistics Summary .....	160
Per-IAP Statistics .....	161
Network Statistics .....	163
VLAN Statistics .....	164
WDS Statistics .....	165
Filter Statistics .....	166
Station Statistics .....	166



---

Per-Station Statistics .....	167
System Log Window .....	168
<b>Configuring the Wi-Fi Array .....</b>	<b>171</b>
Express Setup .....	173
Network .....	179
Network Interfaces .....	180
Network Interface Ports .....	181
DNS Settings .....	187
CDP Settings .....	189
Services .....	191
Time Settings (NTP) .....	192
NetFlow .....	194
Wi-Fi Tag .....	195
System Log .....	196
SNMP .....	199
DHCP Server .....	202
VLANs .....	205
Understanding Virtual Tunnels .....	205
VLAN Management .....	207
Security .....	209
Understanding Security .....	210
Certificates and Connecting Securely to the WMI .....	213
Using the Array’s Default Certificate .....	214
Using an External Certificate Authority .....	215
Admin Management .....	215
Admin Privileges .....	216
Admin RADIUS .....	218
About Creating Admin Accounts on the RADIUS Server .....	219
Management Control .....	222
Access Control List .....	229
Global Settings .....	231
External Radius .....	234
About Creating User Accounts on the RADIUS Server .....	235
Internal Radius .....	238
Rogue Control List .....	241
SSIDs .....	243

---

Understanding SSIDs .....	244
Understanding QoS Priority on the Wi-Fi Array .....	245
SSID Management .....	248
SSID List (top of page) .....	249
SSID Limits .....	253
Web Page Redirect Configuration Settings .....	254
WPA Configuration Settings .....	258
RADIUS Configuration Settings .....	258
Active IAPs .....	259
Per-SSID Access Control List .....	260
Groups .....	262
Understanding Groups .....	262
Using Groups .....	263
Group Management .....	264
Group Limits .....	266
IAPs .....	268
Understanding Fast Roaming .....	270
IAP Settings .....	271
Global Settings (IAP) .....	277
Beacon Configuration .....	279
Station Management .....	279
Advanced Traffic Optimization .....	280
Global Settings .11a .....	284
Global Settings .11bg .....	287
Global Settings .11n .....	291
Advanced RF Settings .....	294
About Standby Mode .....	294
About Blocking Rogue APs .....	295
RF Intrusion Detection .....	296
RF Resilience .....	297
RF Power & Sensitivity .....	298
RF Spectrum Management .....	299
LED Settings .....	303
WDS .....	305
About Configuring WDS Links .....	305
WDS Client Links .....	307
Filters .....	310

---

Filter Lists .....	311
Filter Management .....	313
Clusters .....	316
Cluster Definition .....	317
Cluster Management .....	318
Cluster Operation .....	319
<b>Using Tools on the Wi-Fi Array .....</b>	<b>323</b>
System Tools .....	324
About Licensing and Upgrades .....	325
System .....	326
Automatic Updates from Remote Image or Configuration File ....	327
Configuration .....	328
Diagnostics .....	330
Web Page Redirect .....	332
Network Tools .....	333
Progress and Status Frames .....	335
CLI .....	336
Options .....	337
Logout .....	340
<b>The Command Line Interface .....</b>	<b>341</b>
Establishing a Secure Shell (SSH) Connection .....	341
Getting Started with the CLI .....	343
Inputting Commands .....	343
Getting Help .....	343
Top Level Commands .....	346
Root Command Prompt .....	346
configure Commands .....	347
show Commands .....	350
statistics Commands .....	353
Configuration Commands .....	355
acl .....	355
admin .....	356
cdp .....	357
clear .....	358
cluster .....	359

---

contact-info .....	360
date-time .....	361
dhcp-server .....	362
dns .....	363
file .....	364
filter .....	367
group .....	369
hostname .....	369
interface .....	370
load .....	371
location .....	371
management .....	372
more .....	373
netflow .....	374
no .....	375
quit .....	377
radius-server .....	377
reboot .....	378
reset .....	378
restore .....	379
run-tests .....	380
security .....	382
snmp .....	383
ssid .....	384
syslog .....	385
uptime .....	386
vlan .....	387
wifi-tag .....	388
Sample Configuration Tasks .....	389
Configuring a Simple Open Global SSID .....	390
Configuring a Global SSID using WPA-PEAP .....	391
Configuring an SSID-Specific SSID using WPA-PEAP .....	392
Enabling Global IAPs .....	393
Disabling Global IAPs .....	394
Enabling a Specific IAP .....	395
Disabling a Specific IAP .....	396
Setting Cell Size Auto-Configuration for All IAPs .....	397

---

Setting the Cell Size for All IAPs .....	398
Setting the Cell Size for a Specific IAP .....	399
Configuring VLANs on an Open SSID .....	400
Configuring Radio Assurance Mode (Loopback Tests) .....	401
<b>Appendices .....</b>	<b>403</b>
<b>Appendix A: Servicing the Wi-Fi Array .....</b>	<b>405</b>
Removing the Access Panel .....	407
Reinstalling the Access Panel .....	410
Replacing the FLASH Memory Module .....	412
Replacing the Main System Memory .....	414
Replacing the Integrated Access Point Radio Module .....	416
Replacing the Power Supply Module .....	419
<b>Appendix B: Quick Reference Guide .....</b>	<b>421</b>
Factory Default Settings .....	421
Host Name .....	421
Network Interfaces .....	421
Serial .....	421
Gigabit 1 and Gigabit 2 .....	422
Fast Ethernet .....	422
Integrated Access Points (IAPs) .....	423
Server Settings .....	424
NTP .....	424
Syslog .....	424
SNMP .....	424
DHCP .....	425
Default SSID .....	425
Security .....	426
Global Settings - Encryption .....	426
External RADIUS (Global) .....	426
Internal RADIUS .....	427
Administrator Account and Password .....	428
Management .....	428
Keyboard Shortcuts .....	428
<b>Appendix C: Technical Support .....</b>	<b>431</b>
General Hints and Tips .....	431

---

Frequently Asked Questions .....	432
Multiple SSIDs .....	432
Security .....	434
VLAN Support .....	438
Array Monitor and Radio Assurance Capabilities .....	440
Enabling Monitoring on the Array .....	440
How Monitoring Works .....	440
Radio Assurance .....	441
Radio Assurance Options .....	442
RADIUS Vendor Specific Attributes (VSAs) for Xirrus .....	443
Upgrading the Array via CLI .....	446
Sample Output for the Upgrade Procedure: .....	447
Power over Gigabit Ethernet Compatibility Matrix .....	451
Contact Information .....	453
<b>Appendix D: Implementing PCI DSS .....</b>	<b>455</b>
Payment Card Industry Data Security Standard Overview .....	455
PCI DSS and Wireless .....	456
The Xirrus Array PCI Compliance Configuration .....	457
The pci-audit Command .....	458
Additional Resources .....	459
<b>Appendix E: Implementing FIPS Security .....</b>	<b>461</b>
<b>Appendix F: Notices .....</b>	<b>467</b>
Notices .....	467
EU Directive 1999/5/EC Compliance Information .....	470
Compliance Information (Non-EU) .....	477
Safety Warnings .....	478
Translated Safety Warnings .....	479
Software License and Product Warranty Agreement .....	480
Hardware Warranty Agreement .....	486
<b>Glossary of Terms.....</b>	<b>489</b>
<b>Index.....</b>	<b>501</b>

# List of Figures

Figure 1.	Xirrus Arrays.....	2
Figure 2.	The Xirrus Management System .....	3
Figure 3.	Wi-Fi Array (XN16) .....	9
Figure 4.	Wireless Coverage Patterns .....	13
Figure 5.	XP8 - Power over Ethernet Usage .....	14
Figure 6.	WMI: Array Status.....	15
Figure 7.	Layout of IAPs (XN16).....	17
Figure 8.	Naming of IAPs (XS16).....	18
Figure 9.	Coverage Schemes (XS16 shown).....	19
Figure 10.	Wall Thickness Considerations .....	61
Figure 11.	Unit Placement.....	62
Figure 12.	Full (Normal) Coverage.....	63
Figure 13.	Adjusting RF Patterns .....	64
Figure 14.	Custom Coverage .....	64
Figure 15.	Connection Rate vs. Distance.....	65
Figure 16.	Transmit Power.....	66
Figure 17.	Overlapping Cells.....	67
Figure 18.	Allocating Channels Manually .....	69
Figure 19.	Deployment Scenario (54 Mbps)—Per Sector .....	70
Figure 20.	Deployment Scenario (36 Mbps)—Per Sector .....	70
Figure 21.	Deployment Scenario (18 Mbps)—Per Sector .....	71
Figure 22.	Classic 802.11 Signal Transmission .....	73
Figure 23.	MIMO Signal Processing .....	74
Figure 24.	Spatial Multiplexing .....	75
Figure 25.	Channel Bonding .....	76
Figure 26.	MAC Throughput Improvements.....	77
Figure 27.	Computing 802.11n Data Rates .....	78
Figure 28.	802.11n Increases Capacity .....	79
Figure 29.	Port Failover Protection .....	80
Figure 30.	Switch Failover Protection .....	81
Figure 31.	Port Requirements for XMS .....	86
Figure 32.	WDS Link.....	90
Figure 33.	A Multiple Hop WDS Connection .....	91
Figure 34.	WDS Failover Protection .....	91

Figure 35.	Installation Workflow .....	94
Figure 36.	Array Placement .....	96
Figure 37.	LED Locations (XN16) .....	100
Figure 38.	Network Interface Ports.....	103
Figure 39.	Express Setup .....	106
Figure 40.	LEDs are Switched On .....	111
Figure 41.	Web Management Interface .....	114
Figure 42.	WMI: Frames .....	117
Figure 43.	WMI: Utility Buttons.....	119
Figure 44.	Feedback Form.....	120
Figure 45.	Logging In to the Wi-Fi Array .....	121
Figure 46.	Array Summary .....	124
Figure 47.	Disabled IAP (Partial View).....	125
Figure 48.	IAP Cells .....	126
Figure 49.	Array Information .....	127
Figure 50.	Show Configuration .....	128
Figure 51.	Admin Login History .....	129
Figure 52.	Network Settings .....	130
Figure 53.	Network Map .....	131
Figure 54.	Spanning Tree Status.....	134
Figure 55.	Routing Table .....	135
Figure 56.	ARP Table .....	135
Figure 57.	DHCP Leases.....	136
Figure 58.	Connection Tracking .....	136
Figure 59.	CDP Neighbors .....	137
Figure 60.	Network Assurance.....	138
Figure 61.	RF Monitor—IAPs .....	140
Figure 62.	RF Spectrum Analyzer .....	142
Figure 63.	Intrusion Detection/Rogue AP List.....	145
Figure 64.	Stations .....	148
Figure 65.	Location Map.....	149
Figure 66.	Controls for Location Map .....	150
Figure 67.	Minimizing stations.....	151
Figure 68.	Station RSSI Values .....	153
Figure 69.	Station RSSI Values—Colorized Graphical View .....	154
Figure 70.	Station Signal-to-Noise Ratio Values.....	155
Figure 71.	Station SNR Values—Colorized Graphical View.....	156



Figure 72.	Station Noise Floor Values .....	157
Figure 73.	Station Noise Floor Values—Colorized Graphical View .....	158
Figure 74.	Max by IAP .....	159
Figure 75.	IAP Statistics Summary Page .....	161
Figure 76.	Individual IAP Statistics Page (for IAP abg(n)1) .....	162
Figure 77.	Network Statistics .....	163
Figure 78.	VLAN Statistics .....	164
Figure 79.	WDS Statistics .....	165
Figure 80.	Filter Statistics .....	166
Figure 81.	Station Statistics .....	166
Figure 82.	Individual Station Statistics Page .....	167
Figure 83.	System Log .....	168
Figure 84.	WMI: Express Setup .....	173
Figure 85.	LEDs are Switched On .....	178
Figure 86.	Network Interfaces .....	179
Figure 87.	Network Settings .....	180
Figure 88.	Network Interface Ports .....	181
Figure 89.	Port Modes (a-b) .....	183
Figure 90.	Port Modes (c-d) .....	184
Figure 91.	Port Modes (e-f) .....	185
Figure 92.	DNS Settings .....	187
Figure 93.	CDP Settings .....	189
Figure 94.	Services .....	191
Figure 95.	Time Settings (Manual Time) .....	192
Figure 96.	Time Settings (NTP Time Enabled) .....	193
Figure 97.	NetFlow .....	194
Figure 98.	Wi-Fi Tag .....	195
Figure 99.	System Log .....	196
Figure 100.	SNMP .....	199
Figure 101.	DHCP Management .....	202
Figure 102.	VLANs .....	205
Figure 103.	VLAN Management .....	207
Figure 104.	Security .....	209
Figure 105.	Import Xirrus Certificate Authority .....	214
Figure 106.	Admin Management .....	215
Figure 107.	Admin Privileges .....	217
Figure 108.	Admin RADIUS .....	220

---

Figure 109. Management Control .....	222
Figure 110. Pre-login Banner .....	223
Figure 111. Access Control List .....	229
Figure 112. Global Settings (Security) .....	231
Figure 113. External RADIUS Server .....	234
Figure 114. Internal RADIUS Server .....	238
Figure 115. Rogue Control List .....	241
Figure 116. SSIDs.....	243
Figure 117. Four Traffic Classes .....	245
Figure 118. SSID Management .....	248
Figure 119. SSID Management .....	252
Figure 120. WPR Internal Splash Page Fields (SSID Management).....	254
Figure 121. Customizing an Internal Login or Splash Page.....	257
Figure 122. Setting Active IAPs per SSID .....	259
Figure 123. Per-SSID Access Control List .....	260
Figure 124. Groups.....	262
Figure 125. Group Management .....	264
Figure 126. IAPs.....	268
Figure 127. Source of Channel Setting .....	269
Figure 128. IAP Settings .....	271
Figure 129. Global Settings (IAPs) .....	277
Figure 130. Global Settings .11a .....	284
Figure 131. Global Settings .11bg.....	287
Figure 132. Global Settings .11n.....	291
Figure 133. Advanced RF Settings.....	294
Figure 134. LED Settings .....	303
Figure 135. WDS.....	305
Figure 136. .Configuring a WDS Link.....	306
Figure 137. WDS Client Links .....	307
Figure 138. Filters .....	310
Figure 139. Filter Lists .....	311
Figure 140. Filter Management .....	313
Figure 141. Clusters .....	316
Figure 142. Cluster Definition .....	317
Figure 143. Cluster Management.....	318
Figure 144. Cluster Mode Operation.....	319
Figure 145. Cluster Mode Activation .....	319

Figure 146. Viewing Statistics in Cluster Mode.....	320
Figure 147. Status Display in Cluster Mode.....	321
Figure 148. System Tools.....	324
Figure 149. Saving the Diagnostic Log.....	331
Figure 150. Managing WPR Splash/Login page files.....	332
Figure 151. System Command (Ping).....	333
Figure 152. Radius Ping Command.....	333
Figure 153. Radius Ping Output.....	334
Figure 154. CLI Window .....	336
Figure 155. WMI Display Options .....	337
Figure 156. iPhone Style Option.....	338
Figure 157. Login Window .....	340
Figure 158. Logging In.....	342
Figure 159. Help Window.....	344
Figure 160. Full Help .....	345
Figure 161. Partial Help.....	345
Figure 162. Configuring a Simple Open Global SSID.....	390
Figure 163. Configuring a Global SSID using WPA-PEAP .....	391
Figure 164. Configuring an SSID-Specific SSID using WPA-PEAP .....	392
Figure 165. Enabling Global IAPs.....	393
Figure 166. Disabling Global IAPs.....	394
Figure 167. Enabling a Specific IAP.....	395
Figure 168. Disabling a Specific IAP.....	396
Figure 169. Setting the Cell Size for All IAPs.....	397
Figure 170. Setting the Cell Size for All IAPs.....	398
Figure 171. Setting the Cell Size for a Specific IAP .....	399
Figure 172. Configuring VLANs on an Open SSID.....	400
Figure 173. Configuring Radio Assurance Mode (Loopback Testing).....	402
Figure 174. Disconnecting Power from the Array.....	405
Figure 175. Removing the Access Panel Screws .....	407
Figure 176. Removing the Access Panel .....	408
Figure 177. Disconnecting the Power Supply and Fan.....	408
Figure 178. Reconnecting the Fan and Power Supply .....	410
Figure 179. Reinstalling the Access Panel.....	410
Figure 180. Removing the FLASH Memory Module.....	412
Figure 181. Removing the DIMM Memory Module .....	414
Figure 182. Removing the Chassis Cover Screws.....	416

Figure 183. Removing the Chassis Cover .....	416
Figure 184. Lifting the Integrated Access Point Module .....	417
Figure 185. Disconnect the Integrated Access Point Module .....	417
Figure 186. Installing a New Access Panel (with Power Supply) .....	419
Figure 187. Sample output of pci-audit command.....	459
Figure 188. Applying Three Seals to XS16/XS8.....	462
Figure 189. Applying Two Tamper-evident seals to the XS4 or XN4 .....	463
Figure 190. Security - Management Control Window .....	464

# Introduction

These topics introduce the Xirrus Wi-Fi Array, including an overview of its key features and benefits, and a detailed listing of the product's physical, environmental, technology and regulatory specifications.

- **"The Xirrus Family of Products" on page 2.**
- **"About this User's Guide" on page 5.**
- **"Why Choose the Xirrus Wi-Fi Array?" on page 8.**
- **"Wi-Fi Array Product Overview" on page 9.**
- **"Key Features and Benefits" on page 17.**
- **"Advanced Feature Sets" on page 20.**
- **"Product Specifications—XR4400 and XR4800 Series" on page 23.**
- **"Product Specifications—XN16, XN12, and XN8" on page 31.**
- **"Product Specifications—XN4" on page 38.**
- **"Product Specifications—XS16 and XS8" on page 45.**
- **"Product Specifications—XS4" on page 51.**

## The Xirrus Family of Products



Figure 1. Xirrus Arrays

The Xirrus family of products includes the following:

- **The XS Series of Xirrus Wi-Fi Arrays (XS16 / XS8 / XS4)**

XS Arrays integrate multiple Integrated Access Points—radios with high-gain directional antennas for increased range and coverage. The Array also incorporates an onboard multi-gigabit switch, Wi-Fi controller, and firewall into a single device, along with a dedicated Wi-Fi threat sensor and an embedded spectrum analyzer. The Wi-Fi Array provides more than enough bandwidth, security, and control to replace switched Ethernet to the desktop as the primary network connection. The XS16 has 16 IAPs, the XS8 has 8 IAPs, and the XS4 has 4 IAPs.

- **The XN Series of Xirrus Wi-Fi Arrays (XN16 / XN12 / XN8 / XN4)**

The XN series of Wi-Fi Arrays add the speed and reach of IEEE 802.11n technology to the XS series of Arrays. The XN Series of Arrays feature the capacity and performance needed to replace switched Ethernet to the desktop. The XN16 has 16 IAPs, the XN12 has 12 IAPs, the XN8 has 8 IAPs, and the XN4 has 4 IAPs.

- The XR 4000 Series of Xirrus Wi-Fi Arrays**

The newest Xirrus Wi-Fi Arrays have been completely redesigned to optimize the speed and reach of IEEE 802.11n technology. The XR4000 Series of Arrays have increased the capacity and performance needed to replace switched Ethernet to the desktop. 8-radio and 4-radio models are available
- Xirrus Management System (XMS)**

XMS is used for managing large Array deployments from a centralized Web-based interface. The XMS server is available pre-installed on the Xirrus XM-33xx-CC Management Appliance series, or as a software package (XA-3300-CC) to be installed on your own server hardware.

Figure 2 illustrates the elements of the Xirrus Management System. Users start the XMS client simply by entering the URL of the XMS server on a web browser. The XMS server manages a number of Wi-Fi Arrays via SNMP.

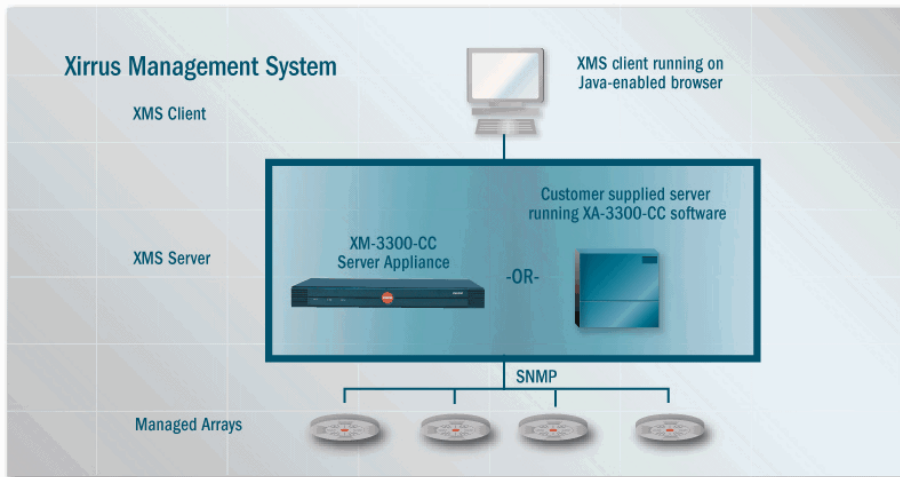

Figure 2. The Xirrus Management System

If you need detailed information about this product, refer to the XMS User's Guide, part number 800-0007-001.

- **Xirrus Power over Gigabit Ethernet (PoGE)**

The PoGE modules eliminate the need for running separate power cabling. Additionally, an eight port module provides distributed power to multiple Arrays, facilitating backup power when connected via a UPS.

### Nomenclature

Throughout this User's Guide, the Xirrus Wi-Fi Array is also referred to as simply the **Array**. In some instances, the terms **product** and **unit** are also used. When discussing specific products from the Xirrus family, the product name is used (for example, XN16 or XS8). The Wi-Fi Array's operating system is referred to as the **ArrayOS**. The Web Management Interface for browser-based management of the Array is referred to as **WMI**.

The XS series of Arrays have two types of radios—the 5 GHz 802.11a radios are named **a1** to **a12** (for 16-port models). The 802.11a/b/g radios are named **abg1** to **abg4**, and they support both 2.4GHz and 5 GHz. The XN and XR4000 series of Arrays also have two types of radios—the 5 GHz 802.11a/n radios are named **an1** through **an12** (for 16-port models). The 802.11a/b/g/n radios are named **abgn1** to **abgn4**, and they also support both 2.4GHz and 5 GHz. When referring to a port that may be on either an XR4000, XN or XS model, the nomenclature **abg(n)** and **a(n)** will be used, e.g., **abg(n)2** or **a(n)6**.

The Xirrus Management System is referred to as **XMS**. The Power over Gigabit Ethernet system may be referred to as **PoGE**.



## About this User's Guide

This User's Guide provides detailed information and procedures that will enable wireless network administrators to install, configure and manage the Wi-Fi Array so that end users can take full advantage of the product's features and functionality without technical assistance.

## Organization

Topics and procedures are organized by function under the following chapter headings:

- **Introduction**  
Provides a brief introduction to wireless technology, an overview of the product, including its key features and benefits, and presents the product specifications.
- **Installing the Wi-Fi Array**  
Defines prerequisites for deploying and installing the Array and provides instructions to help you plan and complete a successful installation.
- **The Web Management Interface**  
Offers an overview of the product's embedded Web Management Interface, including its content and structure. It emphasizes what you need to do to ensure that any configuration changes you make are applied, and provides a list of restricted characters. It also includes instructions for logging in to the Array with your Web browser.
- **Viewing Status on the Wi-Fi Array**  
Describes the status and statistics displays available on the Array using its embedded Web Management Interface.
- **Configuring the Wi-Fi Array**  
Contains procedures for configuring the Array using its embedded Web Management Interface.
- **Using Tools on the Wi-Fi Array**  
Contains procedures for using utility tools provided in the Web Management Interface. It includes procedures for upgrading the system

firmware, uploading and downloading configurations and other files, using diagnostic tools, and resetting the Array to its factory defaults.

- [The Command Line Interface](#)

Includes the commands and the command structure used by the Wi-Fi Array's Command Line Interface (CLI), and provides a procedure for establishing a Telnet connection to the Array. This chapter also includes some sample key configuration tasks using the CLI.

- [Appendix A: Servicing the Wi-Fi Array](#)

Contains procedures for servicing the Array, including the removal and reinstallation of major hardware components.

- [Appendix B: Quick Reference Guide](#)

Contains the product's factory default settings.

- [Appendix C: Technical Support](#)

Offers guidance to resolve technical issues, including general hints and tips to enhance your product experience, and a procedure for isolating problems within an Array-enabled wireless network. Also includes Frequently Asked Questions (FAQs) and Xirrus contact information.

- [Appendix D: Implementing PCI DSS](#)

Discusses meeting security standards with the Array, including FIPS and PCI DSS.

- [Appendix F: Notices](#)

Contains the legal notices, licensing, and compliance statements for the Array. Please read this section carefully.

- [Glossary of Terms](#)

Provides an explanation of terms directly related to Xirrus product technology, organized alphabetically.

- [Index](#)

The index is a valuable information search tool. Use the index to locate specific topics discussed in this User's Guide. Simply click on any page number in the index to jump to the referenced topic.

## Notes and Cautions

The following symbols are used throughout this User's Guide:



*This symbol is used for general notes that provide useful supplemental information.*



*This symbol is used for cautions. Cautions provide critical information that may adversely affect the performance of the product.*

## Screen Images

Some screen images of the Web Management Interface have been modified for clarity. For example, an image may have been cropped to highlight a specific area of the screen, and/or sample data may be included in some fields.

## Your User's Guide as a PDF Document

This User's Guide is also made available as a secure PDF (Portable Document Format) file and can be viewed using the Adobe® Acrobat Reader® product. It cannot be edited or modified. If you don't have Acrobat Reader, you can download it free-of-charge from: <http://www.adobe.com>.

## Hyperlinks

If you click on body text that appears in the color **TEAL** (with the exception of headings or notes) the embedded hyperlink within the text will immediately take you to the referenced destination. All internal and external cross-references, including page numbers within the [List of Figures](#) and the [Index](#), have associated hyperlinks. After "jumping" to a referenced topic, if you want to return to the previous page (reference source), simply click on Acrobat's **previous page** button.

## Window or Page?

Is a window a page, or is a page a window? There seems to be some dispute as to what the correct term should be. For the sake of consistency, this document uses the term **Window** when referring to how the Wi-Fi Array's Web Management Interface is displayed on your monitor.

## Why Choose the Xirrus Wi-Fi Array?

The deployment of wireless LANs is becoming increasingly common as businesses strive for greater flexibility in the workplace and the need for employee mobility rises. The only requirements for an effective wireless deployment are a power source, a couple of screws, and a little imagination.

Wireless LAN is also fully compatible with standard Ethernet protocols, so connectivity with existing wired infrastructures is transparent to users—they can still access and use the same applications and network services that they use when plugged into the company's wired LAN infrastructure (it's only the plug that no longer exists).

Wireless LAN has come a long way in the past few years and now offers the performance, reliability and security that Enterprise customers have come to expect from their networks. The technology is being driven by four major IEEE standards:

- **802.11a**  
Operates in the 5 GHz range with a maximum speed of 54 Mbps.
- **802.11b**  
Operates in the 2.4 GHz range with a maximum speed of 11 Mbps.
- **802.11g**  
Supports a higher transmission speed of 54 Mbps in the 2.4 GHz range and is backwards compatible with 802.11b.
- **802.11n**  
Uses multiple antennas per radio to boost transmission speed as high as 300 Mbps, increasing throughput, range, and maximum number of users. 802.11n is backwards compatible with 802.11a/b/g.

Whether you have just a handful of users or thousands of users, wireless has the scalability and flexibility to serve your needs.

## Wi-Fi Array Product Overview

Part of the family of Xirrus products, the Wi-Fi Array is a high capacity, multi-mode device designed for the Enterprise market, with twice the range and up to eight times the capacity of competitive wireless products.



Figure 3. Wi-Fi Array (XN16)

The Wi-Fi Array (regardless of the product model) is Wi-Fi® compliant and simultaneously supports 802.11a, 802.11b and 802.11g clients. XR and XN model arrays add the enhanced abilities of 802.11n to this combination. Active Enterprise class features such as VLAN support and multiple SSID capability enable robust network compatibility and a high level of scalability and system control. The optional Xirrus Management System (XMS) allows global management of hundreds of Arrays from a central location.

Multiple versions of the Array with different numbers of Integrated Access Points (IAPs) support a variety of deployment applications: 16 IAPs (XN16, XS16), 12 IAPs (XN12), 8 IAPs (XR4820, XR4830, XN8, XS8), and 4 IAPs (XR4420, XR4430, XN4, XS4).

### Enterprise Class Security

The latest and most effective wireless encryption security standards, including WPA (Wi-Fi Protected Access) and WPA2 with 802.11i AES (Advanced Encryption Standard) are available on the Wi-Fi Array. In addition, the use of an embedded RADIUS server (or 802.1x with an external RADIUS server) ensures user authentication—multiple Arrays can authenticate to the optional XMS, ensuring only authorized Arrays become part of the wireless network. With the

Xirrus [Advanced Feature Sets](#), rogue AP detection, site monitoring, and RF spectrum analysis are performed in the background by the Array automatically.

### Wi-Fi Array Product Family

The following tables provide an overview of the main features supported by the Wi-Fi Array product family.

#### XR4000 Family of Arrays

Feature	XR4820	XN4420
Number of 802.11a/b/g/n radios	4	4
Number of 802.11a/n radios	4	0
<b>Total radios</b>	<b>8</b>	<b>4</b>
Number of integrated antennas	24	12
Integrated Wi-Fi switch ports	8	4
Integrated RF spectrum analyzer, threat sensors	Yes	Yes
Uplink Ports	2	2
Wi-Fi bandwidth	2.4 Gbps	1.2 Gbps
Users supported	768	384

### XN Family of Arrays

Feature	XN16	XN12	XN8	XN4
Number of 802.11a/b/g/n radios	4	4	4	4
Number of 802.11a/n radios	12	8	4	0
<b>Total radios</b>	<b>16</b>	<b>12</b>	<b>8</b>	<b>4</b>
Number of integrated antennas	48	36	24	12
Integrated Wi-Fi switch ports	16	12	8	4
Integrated RF spectrum analyzer, threat sensors	Yes	Yes	Yes	Yes
Uplink Ports	2	2	2	1
Wi-Fi bandwidth	4.8 Gbps	3.6 Gbps	2.4 Gbps	1.2 Gbps
Users supported	1536	1152	768	384

### XS Family of Arrays

Feature	XS16	XS8	XS4
Number of 802.11a/b/g radios	4	4	4
Number of 802.11a radios	12	4	0
<b>Total radios</b>	<b>16</b>	<b>8</b>	<b>4</b>
Integrated Wi-Fi switch ports	16	8	4
Integrated RF spectrum analyzer and threat sensors	Yes	Yes	Yes
Uplink Ports	2	2	1
Wi-Fi bandwidth	864 Mb	432 Mb	216 Mb
Users supported	1,024	512	256



## Deployment Flexibility

Xirrus' unique multi-radio architecture generates 360 degrees of sectored high-gain 802.11a/b/g/n or 802.11a/b/g coverage that provides extended range and the highest possible data rates for a large volume of clients. Each sector can be controlled automatically or manually, creating a pattern of wireless coverage perfectly tailored to individual customer needs. For example:

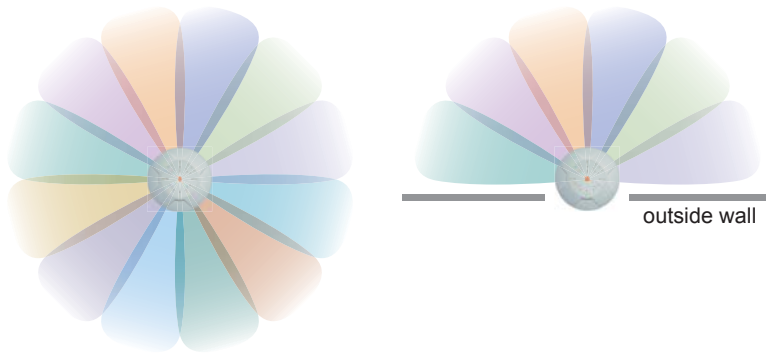

Figure 4. Wireless Coverage Patterns

Figure 4 depicts the following two scenarios:

- **Full pattern coverage**  
All radios are activated with coverage spanning 360 degrees. If within range, clients will always receive coverage regardless of their geographic position relative to the Array.
- **Partial pattern coverage**  
If desired, the Wi-Fi Array can be deployed close to an exterior wall. In this case, half of all available radios have been deactivated to prevent redundant signals from “bleeding” beyond the site’s perimeter wall. This configuration may also be used in those cases where you want to restrict wireless coverage to selected areas of the building’s interior.

See also, “Flexible Coverage Schemes” on page 19.

### Power over Gigabit Ethernet (PoGE)

The Xirrus XP1, XP2, and XP8 Power over Gigabit Ethernet modules provide power to your Arrays over the same Cat 5e or Cat 6 cable used for data, eliminating the need to run power cables and provide an AC power outlet in proximity to each unit. Managed modules provide the ability to control power using XMS.

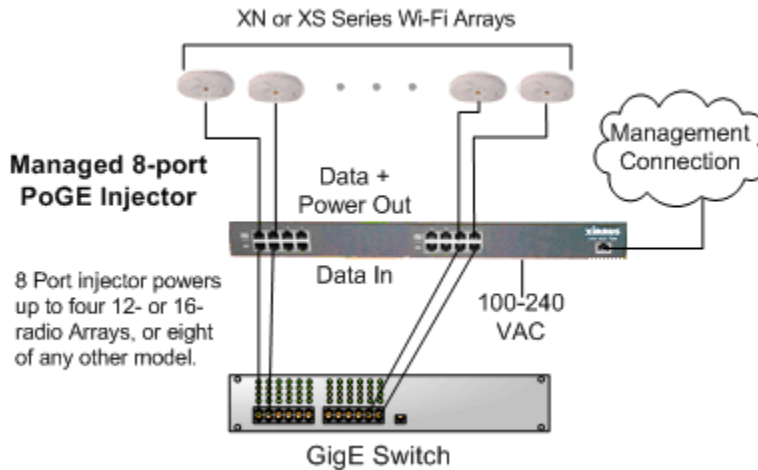

Figure 5. XP8 - Power over Ethernet Usage

Specific models of the Array are compatible with specific PoGE modules. For details, please see [“Power over Gigabit Ethernet Compatibility Matrix”](#) on page 451.

### Enterprise Class Management

The Wi-Fi Array can be configured with its default RF settings, or the RF settings can be customized using the Array’s embedded Web Management Interface

(WMI). The WMI enables easy configuration and control from a graphical console, along with a full compliment of troubleshooting tools and statistics.



Figure 6. WMI: Array Status

In addition, a fully featured Command Line Interface (CLI) offers IT professionals a familiar management and control environment. SNMP (Simple Network Management Protocol) is also supported to allow management from an SNMP compliant management tool, such as the optional Xirus Management System.



*For deployments of more than five Arrays, we recommend that you use the Xirrus Management System (XMS). The XMS offers a rich set of features for fine control over large deployments.*

## Key Features and Benefits

This section describes some of the key product features and the benefits you can expect when deploying the Wi-Fi Array (the XN16 product is highlighted in this section).

### High Capacity and High Performance

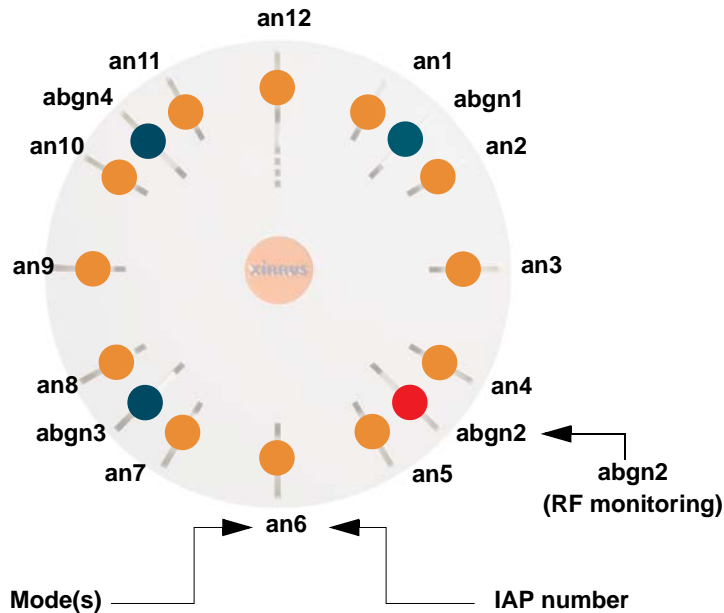

Figure 7. Layout of IAPs (XN16)

The XN16 version of the Wi-Fi Array (Figure 7) easily handles time-sensitive traffic such as voice, and can enable wireless connectivity for 1,024 users. The unit includes two Gigabit uplink ports for connection to the wired network. A total of sixteen IAPs provides a maximum wireless capacity of 4.8 Gbps, which offers ample reserves for the high demands of current and future applications. Of the sixteen IAPs, twelve operate as 802.11a/n radios (5 GHz band), and four operate as 802.11a/b/g/n radios (5 GHz or 2.4 GHz bands), providing backwards compatibility with 802.11b and 802.11g.

In the recommended configuration, IAP (radio) **abg(n)2** is configured in RF monitoring and rogue AP detection mode.

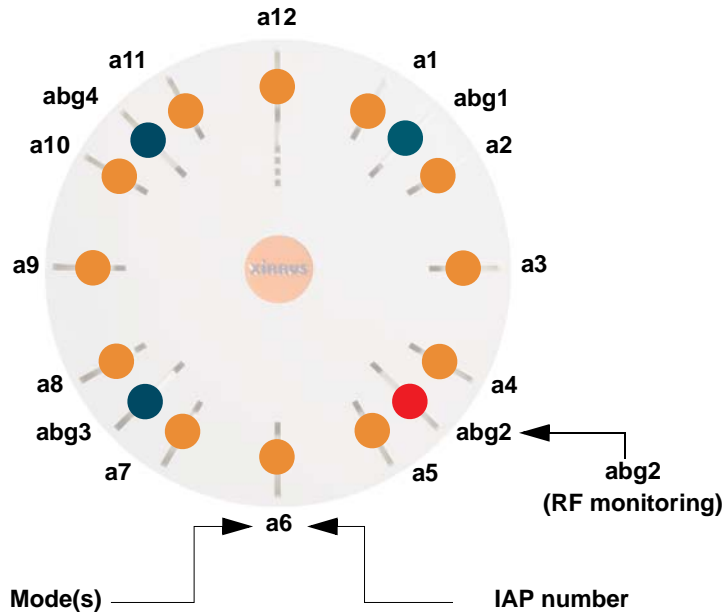

Figure 8. Naming of IAPs (XN16)

### Extended Coverage

One XN16 solution enables you to replace up to sixteen access points (includes one omnidirectional IAP for monitoring the network). Fifteen IAP radios with integrated directional antennas provide increased wireless range and enhanced data rates in all directions. With a Wi-Fi Array deployed, far fewer access points are needed and wired-like resiliency is delivered throughout your wireless network. Your Wi-Fi Array deployment ensures:

- Continuous connectivity if an IAP (radio) fails.
- Continuous connectivity if an Array fails.
- Continuous connectivity if a WDS link or switch fails.
- Continuous connectivity if a Gigabit uplink or switch fails.

## Flexible Coverage Schemes

Your Wi-Fi Array offers flexible coverage schemes for each wireless technology.

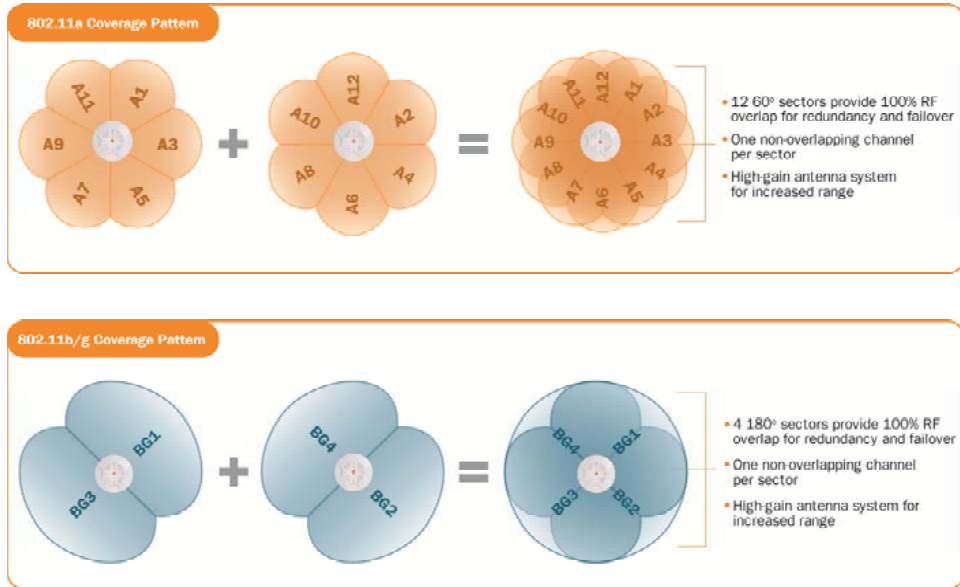

Figure 9. Coverage Schemes (XS16 shown)

- **802.11a/n, 802.11a**  
Delivers 60° wireless coverage per IAP, with 6 dBi of gain.
- **802.11b/g/n, 802.11b/g**  
Delivers 180° wireless coverage, with 3 dBi of gain.
- **802.11a/b/g/n, 802.11a/b/g (monitor only)**  
Delivers 360° wireless coverage, with 2 dBi of gain.

## Non-Overlapping Channels

Complete use of non-overlapping channels limits interference and delivers maximum capacity. On the XN16, up to 16 non-overlapping channels are fully utilized across the 5GHz and 2.4GHz spectrums (up to 12 across the 5GHz spectrum plus up to 3 across the 2.4 GHz spectrum—typically, one additional radio is used as a dedicated RF monitor).

### **SDMA Optimization**

SDMA (Spatial Division Multiple Access) technology provides full 360° coverage while allowing independent channel and power output customization. Also supports fast inter-zone handoffs for time-sensitive applications and roaming.

### **Fast Roaming**

Utilizes the Xirrus Roaming Protocol (XRP) ensuring fast and seamless roaming capabilities between IAPs or Arrays at both Layer 2 and Layer 3.

### **Easy Deployment**

The Xirrus Management System (XMS) offers real time monitoring and management capabilities for the wireless network—ideal for the Enterprise market. It also allows you to import floor plans to help you plan your deployment. The Xirrus Wi-Fi Array chassis has a plenum rated, lockable and tamper resistant case.

### **Secure Wireless Access**

Multiple layers of authentication and encryption ensure secure data transmissions. The Wi-Fi Array is 802.11i compliant with line-rate encryption support for 40 and 128 bit WEP, WPA and WPA2 with TKIP and AES encryption. Authentication is provided via 802.1x, including PEAP, EAP-TLS, EAP-TTLS, and LEAP (Lightweight Extensible Authentication Protocol) passthrough.

### **Applications Enablement**

The Wi-Fi Array's QoS (Quality of Service) functionality combined with true switch capabilities enable high density video and Voice over Wireless LAN deployments. Compliant with 802.1p and 802.1Q standards.

### **Advanced Feature Sets**

The Wi-Fi Array offers a family of powerful functionality packages, including the RF Performance Manager (RPM), RF Security Manager (RSM), and RF Analysis Manager (RAM). These packages are separately licensed for operation on your Array.



### **Xirrus Advanced RF Performance Manager (RPM)**

The Xirrus RPM optimizes the bandwidth usage and station performance of 802.11n Wi-Fi networks. Leveraging the multiple integrated access point (multi-radio) design of the Xirrus Wi-Fi Array, RPM manages the allocation of wireless bandwidth to wireless stations across multiple RF channels. The result maximizes overall network performance with superior flexibility and capacity.

Today's wireless infrastructure is faced with ever increasing numbers and variations of Wi-Fi enabled clients, whether in the form of notebooks, netbooks, smart phones, IP phones, printers, projectors, cameras, RFID tags, etc. The advent of higher speed 802.11n Wi-Fi and its increased use of the 5GHz spectrum adds to the number of variables today's wireless networks must accommodate. Backwards compatibility with older clients is crucial, however their operation in a Wi-Fi network can significantly hinder the performance of faster clients. As an example, 802.11b Wi-Fi stations communicate more than 10 times slower than 802.11n stations.

With each of the Array's multiple radios operating on a different channel, RPM selects the ideal radio for each station. High-speed stations are grouped together on radios with other high speed stations, while lower speed stations are combined with other lower speed stations. This ensures optimal performance for high-speed 802.11n stations without compromise.

The complete feature set of the RPM package includes:

- WDS (Wireless Distribution System) for point-to-point communication
- Wi-Fi Mode per IAP
- Sharp Cell technology
- Wireless Data Rate Optimization
- Wireless Traffic Shaping
- Wireless Voice Call Admission Control
- Fast Layer 2 and 3 Roaming
- Standby Mode

### **Xirrus Advanced RF Security Manager (RSM)**

The Xirrus RSM improves security and minimizes the risk in deploying 802.11n wireless networks. Leveraging an integrated 24/7 threat sensor and hardware-based encryption/decryption in each Array, RSM secures the Wi-Fi network from multiple types of threats. The result delivers uncompromised overall network security with superior flexibility and performance.

Today's Wi-Fi networks face a number of potential security threats in the form of rogue access points, ad-hoc clients, unauthorized clients, wireless-based attacks, eavesdropping, etc. As 802.11n is increasingly adopted in enterprise networks, defending against these threats becomes more critical. With the Array's dedicated threat sensor radio scanning all channels in the 2.4GHz and 5GHz spectrums, RSM searches for security threats and automatically mitigates them.

High performance encryption/decryption in the enterprise Wi-Fi network is a must. The Wi-Fi network needs to support each client using the highest level of encryption (WPA2 Enterprise/128 bit AES) and without degrading the overall performance of the network. Xirrus incorporates hardware-based encryption/decryption into each Array, delivering line-rate encryption at the edge of the network instead of at a choke point within a centralized controller.

The complete feature set of the RSM package includes:

- Wireless IDS/IPS (Intrusion Detection/Prevention System)
- Wireless stateful firewall
- User group policies
- Authenticated guest access gateway
- NAC integration
- PCI audit compliance enforcement

### **Xirrus Advanced RF Analysis Manager (RAM)**

The RF Advanced Analysis Manager (RAM) tests and troubleshoots 802.11n wireless networks. The deployment of 802.11n presents a set of unique challenges based on technology differences with legacy 802.11a/b/g networks, both on the wireless infrastructure and client side. Xirrus' RAM equips each Wi-Fi Array with a powerful set of tools and features to optimally tune and verify an 802.11n

installation, as well as give IT administrators the ability to troubleshoot issues that may occur within the wireless environment.

The 802.11n standard will continue to evolve over the next several years with additional performance and optional functions, along with ongoing stream of IEEE 802.11 amendments. This changing wireless landscape mandates that appropriate tools are available to the user to analyze, optimize, and troubleshoot their changing environments.

The distributed architecture of the Array enables the execution of powerful wireless and networking analysis at the edge of the network where packets traverse the wireless-to-wired boundary. The Array includes an embedded Wi-Fi Controller with the necessary computing and memory resources to provide these functions securely at the network's edge.

The key elements of the RAM package include:

- RF Analysis – An embedded Spectrum Analyzer leverages the dedicated threat sensor radio in each Wi-Fi Array to provide a continual view of utilization, interference, and errors across all available Wi-Fi channels.
- Packet Analysis – Integrated packet capture provides filterable views of all traffic traversing on the wired and wireless interfaces of the Array.
- Performance Analysis – Embedded traffic generation enables the throughput of the Array's wireless or wired interfaces to be analyzed.
- Failure Recovery – Radio Assurance provides an automatic self-test and self healing mechanism that ensures continuous system operation.
- Netflow Support
- Network Tools: ping, RADIUS ping, traceroute

## Product Specifications—XR4400 and XR4800 Series

??xxx Please review VERRRRRY carefully!!

Element	XR4000 Series Specifications
<b>Number of Users</b>	Maximum of 96 associated users per radio XR48xx: 768 users per Array XR44xx: 384 users per Array
<b>Physical</b>	Diameter: 12.58 inches (31.95 cm) Height: 2.58 inches (6.55 cm) Weight: 4lbs (1.81 kg)
<b>Environmental</b>	<b>Operating Temperature:</b> 0°C to 55°C 0% to 90% relative humidity (non-condensing) <b>Storage Temperature:</b> -20°C to 60°C 5% to 95% relative humidity (non-condensing)
<b>System</b>	700 MHz CPU 1 GB RAM 1 GB system flash
<b>Integrated Switch</b>	2.1 Gbps integrated wireless switch
<b>Chassis</b>	Lockable mounting plate, Kensington lock slot
<b>Electrical</b>	PoGE (DC) Input Power: Power over Gigabit Ethernet—no splitter required, 48VDC, Maximum 2A <b>Nominal Power:</b> XR48xx: 60W XR44xx: 35W See “Power over Gigabit Ethernet Compatibility Matrix” on page 451.

Element	XR4000 Series Specifications
<p><b>Interfaces</b></p>	<p><b>Serial Console Port:</b> 1 x RS232 – RJ45 connector, for local configuration</p> <p><b>Ethernet Interfaces:</b> 2 x Gigabit 100/1000 Mbps uplink ports for link aggregation, redundancy, or bridging 1 x Fast Ethernet 10/100 Mbps, for out of band management</p> <p><b>Status LEDs:</b> System status, Ethernet, Radio</p>
<p><b>Networking</b></p>	<p>DHCP client, DHCP server (multiple DHCP pools), DNS Client, NTP client, NAT</p>
<p><b>Management</b></p>	<p>Xirrus Management System (XMS)—Layer 3 Element Management System</p> <p>HTTPS Web Management Interface (WMI)</p> <p>CLI via SSHv2, Telnet, local serial Console</p> <p>Enable/disable management for any interface</p> <p>Read-write and read-only admin accounts may be authenticated via RADIUS</p> <p>SNMP v2c, v3</p> <p>Configuration Files—text-based files may be imported, exported, or compared</p> <p>NetFlow—IP flow information (traffic statistics may be sent to an external Collector)</p> <p>FTP, TFTP</p> <p>Syslog reporting for alerts/alarms—messages may be stored on internal Syslog server or sent to up to three external syslog servers.</p> <p>Cisco Discovery Protocol (CDP)—obtain protocol addresses and platform information for neighboring devices</p>

Element	XR4000 Series Specifications
<b>Quality of Service (QoS) Support</b>	<p><b>Multiple SSIDs:</b>                      16 unique SSIDs per Array                      Each SSID beacons a unique BSSID per radio                      VLAN and QoS settings for each SSID</p> <p><b>VLANs:</b>                      Up to 16 VLANs, 802.1Q, 802.1p</p> <p><b>Prioritization:</b>                      802.11e wireless prioritization                      802.1p wired prioritization                      Fair queuing of downstream traffic                      Wireless Voice Support</p>

Element	XR4000 Series Specifications
<p><b>Security</b></p>	<p><b>Wireless Encryption</b>                      Line speed, hardware-accelerated encryption modes:                      WPA TKIP                      WPA2 AES                      WEP 40/64                      WEP 104/128</p> <p><b>Wireless Authentication:</b>                      Open                      Pre-shared Key                      802.1X EAP                      PEAP                      EAP-TLS                      EAP-TTLS                      EAP-LEAP Pass-through                      Web Page Redirect (Captive Portal)                      MAC Address Access Control List (ACL)                      CHAP, PAP</p> <p><b>Firewall:</b>                      Integrated stateful-inspection, rules-based firewall</p> <p><b>Rogue AP detection and blocking:</b>                      Integrated Rogue AP detection and alerting via dedicated internal RF Threat Sensor. Rogue AP can be shielded</p> <p><b>Integrated RADIUS Server:</b>                      Integrated 802.1x Authentication Server supporting EAP-PEAP</p>

Element	XR4000 Series Specifications
<b>Security (continued)</b>	<b>Time of Day Access:</b> Specify when access is allowed, per SSID or User Group  <b>Station-Station Blocking:</b> Station-to-Station traffic blocking option
<b>Wireless</b>	<b>Wireless Standards:</b> 802.11a 802.11b 802.11d 802.11g 802.11e 802.11h 802.11i 802.11j 802.11n  <b>Number of Radios: ??OK??</b> XR48xx: <del>4 x 802.11a/n radios</del> <del>4 x 802.11a/b/g/n radios</del> Advanced RF design includes 36 integrated antennas  XR44xx: <del>4 x 802.11a/b/g/n radios</del> <del>Advanced RF design includes 20 integrated antennas</del>  <b>Spectrum Analyzer:</b> 1 integrated into Array



Element	XR4000 Series Specifications
<p><b>Wireless (continued)</b></p>	<p><b>Frequency Bands:</b>                      11a/n: 4.945 – 4.985 (restricted Public Safety band)                      11a/n: 5.15-5.25 GHz (UNII 1)                      11a/n: 5.15-5.25 GHz (TELEC)                      11a/n: 5.25-5.35 GHz (UNII 2)                      11a/n: 5.470-5.725 (ETSI)                      11a/n: 5.725-5.825 GHz (UNII 3)                      11b/g/n: 2.412-2.462 GHz (FCC)                      11b/g/n: 2.412-2.472 GHz (ETSI)                      11b/g/n: 2.412-2.484 GHz (TELEC)</p> <p><b>Channel Selection:</b>                      Manual and Automatic</p> <p><b>802.11a/n Antennas</b>                      Integrated 6dBi sectorized</p> <p><b>802.11b/g/n Antennas</b>                      Integrated 3dBi sectorized</p> <p><b>Wi-Fi Monitoring:</b>                      1 Integrated Access Point can be set as a dedicated Wi-Fi Threat Sensor                      2 dBi 360° omni-directional antenna</p> <p><del>802.11a/b/g/n External Antenna Connectors:                      3 RP-TNC connectors (NOTE: TNC antenna connection is not for outside plant connection.)</del></p>
<p><b>Performance</b></p>	<p><b>Client Load Balancing</b>                      Automatic load balancing between system radios</p>

Element	XR4000 Series Specifications
<b>Compliance</b>	<p><b>Electromagnetic:</b> ICES-003 (Canada) EN 301.893 (Europe) EN 301.489-1 and -17 (Europe)</p> <p><b>Safety:</b> EN 60950 EN 50371 to 50385 CE Mark</p> <p>Additional information in “Appendix F: Notices” on page 467.</p>
<b>Certifications</b>	<p><b>Wi-Fi Alliance:</b> 802.11a/b/g/n, WPA, WPA2, and extended EAP types. <a href="#">Our certifications may be viewed here.</a></p> <p>Additional information in “Appendix F: Notices” on page 467.</p>
<b>Warranty</b>	<p><b>Hardware:</b> Five Year Standard (extendable)</p> <p><b>Software:</b> 90 Days Standard (extendable)</p>

## Product Specifications—XN16, XN12, and XN8

Element	XN16/XN12/XN8 Specifications
<b>Number of Users</b>	Maximum of 96 associated users per radio XN16: 1536 users per Array XN12: 1152 users per Array XN8: 768 users per Array
<b>Physical</b>	Diameter: 18.65 inches (47.37 cm) Height: 3.87 inches (9.83 cm) Weight: 10 lbs (3.63 kg)
<b>Environmental</b>	<b>Operating Temperature:</b> 0°C to 55°C 0% to 90% relative humidity (non-condensing) <b>Storage Temperature:</b> -20°C to 60°C 5% to 95% relative humidity (non-condensing)
<b>System</b>	1 GHz CPU 1 GB RAM 1 GB system flash
<b>Integrated Switch</b>	2.1 Gbps integrated wireless switch
<b>Chassis</b>	Lockable mounting plate, Kensington lock slot

Element	XN16/XN12/XN8 Specifications
<b>Electrical</b>	<p>XN8, XN12, XN16 powered by PoGE only</p> <p>PoGE (DC) Input Power: Power over Gigabit Ethernet—no splitter required, 48VDC, Maximum 2A</p> <p><b>Nominal Power:</b></p> <p>XN16: 90W</p> <p>XN12: 75W</p> <p>XN8: 60W</p> <p><b>All Models:</b></p> <p>For PoGE, see “Power over Gigabit Ethernet Compatibility Matrix” on page 451.</p>
<b>Interfaces</b>	<p><b>Serial Console Port:</b></p> <p>1 x RS232 – RJ45 connector, for local configuration</p> <p><b>Ethernet Interfaces:</b></p> <p>2 x Gigabit 100/1000 Mbps uplink ports for link aggregation, redundancy, or bridging</p> <p>1 x Fast Ethernet 10/100 Mbps, for out of band management</p> <p><b>Status LEDs:</b></p> <p>System status, Ethernet, Radio</p>
<b>Networking</b>	<p>DHCP client, DHCP server (multiple DHCP pools), DNS Client, NTP client, NAT</p>

Element	XN16/XN12/XN8 Specifications
<p><b>Management</b></p>	<p>Xirrus Management System (XMS)—Layer 3 Element Management System</p> <p>HTTPS Web Management Interface (WMI)</p> <p>CLI via SSHv2, Telnet, local serial Console</p> <p>Enable/disable management for any interface</p> <p>Read-write and read-only admin accounts may be authenticated via RADIUS</p> <p>SNMP v2c, v3</p> <p>Configuration Files—text-based files may be imported, exported, or compared</p> <p>NetFlow—IP flow information (traffic statistics may be sent to an external Collector</p> <p>FTP, TFTP</p> <p>Syslog reporting for alerts/alarms—messages may be stored on internal Syslog server or sent to up to three external syslog servers.</p> <p>Cisco Discovery Protocol (CDP)—obtain protocol addresses and platform information for neighboring devices</p>
<p><b>Quality of Service (QoS) Support</b></p>	<p><b>Multiple SSIDs:</b></p> <p>16 unique SSIDs per Array</p> <p>Each SSID beacons a unique BSSID per radio</p> <p>VLAN and QoS settings for each SSID</p> <p><b>VLANs:</b></p> <p>Up to 16 VLANs, 802.1Q, 802.1p</p> <p><b>Prioritization:</b></p> <p>802.11e wireless prioritization</p> <p>802.1p wired prioritization</p> <p>Fair queuing of downstream traffic</p> <p>Wireless Voice Support</p>

Element	XN16/XN12/XN8 Specifications
<b>Security</b>	<p><b>Wireless Encryption</b></p> <p>Line speed, hardware-accelerated encryption modes:</p> <ul style="list-style-type: none"> <li>WPA TKIP</li> <li>WPA2 AES</li> <li>WEP 40/64</li> <li>WEP 104/128</li> </ul> <p><b>Wireless Authentication:</b></p> <ul style="list-style-type: none"> <li>Open</li> <li>Pre-shared Key</li> <li>802.1X EAP</li> <li>PEAP</li> <li>EAP-TLS</li> <li>EAP-TTLS</li> <li>EAP-LEAP Pass-through</li> <li>Web Page Redirect (Captive Portal)</li> <li>MAC Address Access Control List (ACL)</li> <li>CHAP, PAP</li> </ul> <p><b>Firewall:</b></p> <p>Integrated stateful-inspection, rules-based firewall</p> <p><b>Rogue AP detection and blocking:</b></p> <p>Integrated Rogue AP detection and alerting via dedicated internal RF Threat Sensor. Rogue AP can be shielded</p> <p><b>Integrated RADIUS Server:</b></p> <p>Integrated 802.1x Authentication Server supporting EAP-PEAP</p>

Element	XN16/XN12/XN8 Specifications
<p><b>Security (continued)</b></p>	<p><b>Time of Day Access:</b> Specify when access is allowed, per SSID or User Group</p> <p><b>Station-Station Blocking:</b> Station-to-Station traffic blocking option</p>
<p><b>Wireless</b></p>	<p><b>Wireless Standards:</b> 802.11a 802.11b 802.11d 802.11g 802.11e 802.11h 802.11i 802.11j 802.11n</p> <p><b>Number of Radios:</b></p> <p><b>XN16:</b> 12 x 802.11a/n radios 4 x 802.11a/b/g/n radios Only 12 radios should be used as 802.11a/n radios (i.e., 5 GHz band) concurrently. 48 integrated antennas</p> <p><b>XN12:</b> 8 x 802.11a/n radios 4 x 802.11a/b/g/n radios 36 integrated antennas</p> <p><b>XN8:</b> 4 x 802.11a/n radios 4 x 802.11a/b/g/n radios Advanced RF design includes 36 integrated antennas</p> <p><b>Spectrum Analyzer:</b> 1 integrated into Array</p>

Element	XN16/XN12/XN8 Specifications
<b>Wireless (continued)</b>	<p><b>Frequency Bands:</b></p> <p>11a/n: 4.945 – 4.985 (restricted Public Safety band)</p> <p>11a/n: 5.15-5.25 GHz (UNII 1)</p> <p>11a/n: 5.15-5.25 GHz (TELEC)</p> <p>11a/n: 5.25-5.35 GHz (UNII 2)</p> <p>11a/n: 5.470-5.725 (ETSI)</p> <p>11a/n: 5.725-5.825 GHz (UNII 3)</p> <p>11b/g/n: 2.412-2.462 GHz (FCC)</p> <p>11b/g/n: 2.412-2.472 GHz (ETSI)</p> <p>11b/g/n: 2.412-2.484 GHz (TELEC)</p> <p><b>Channel Selection:</b></p> <p>Manual and Automatic</p> <p><b>802.11a/n Antennas</b></p> <p>Integrated 6dBi, sectorized</p> <p><b>802.11b/g/n Antennas</b></p> <p>Integrated 3dBi, sectorized</p> <p><b>Wi-Fi Monitoring:</b></p> <p>1 Integrated Access Point can be set as a dedicated Wi-Fi Threat Sensor</p> <p>2 dBi 360° omni-directional antenna</p> <p><b>802.11a/b/g/n External Antenna Connectors:</b></p> <p>3 RP-TNC connectors (<b>NOTE:</b> TNC antenna connection is not for outside plant connection.)</p>
<b>Performance</b>	<p><b>Client Load Balancing</b></p> <p>Automatic load balancing between system radios</p>



Element	XN16/XN12/XN8 Specifications
<b>Compliance</b>	<p><b>Electromagnetic:</b>                      ICES-003 (Canada)                      EN 301.893 (Europe)                      EN 301.489-1 and -17 (Europe)</p> <p><b>Safety:</b>                      EN 60950                      EN 50371 to 50385                      CE Mark</p> <p>Additional information in “Appendix F: Notices” on page 467.</p>
<b>Certifications</b>	<p><b>Wi-Fi Alliance:</b> 802.11a/b/g/n, WPA, WPA2, and extended EAP types. <a href="#">Our certifications may be viewed here.</a></p> <p>Additional information in “Appendix F: Notices” on page 467.</p>
<b>Warranty</b>	<p><b>Hardware:</b>                      Five Year Standard (extendable)</p> <p><b>Software:</b>                      90 Days Standard (extendable)</p>

## Product Specifications—XN4

Element	XN4 Specifications
<b>Number of Users</b>	Maximum of 96 associated users per radio, 384 users per XN4
<b>Physical</b>	Diameter: 12.58 inches (31.95 cm) Height: 2.58 inches (6.55 cm) Weight: 4lbs (1.81 kg)
<b>Environmental</b>	<b>Operating Temperature:</b> 0°C to 55°C 0% to 90% relative humidity (non-condensing) <b>Storage Temperature:</b> -20°C to 60°C 5% to 95% relative humidity (non-condensing)
<b>System</b>	825 MHz CPU 512 MB RAM 1 GB system flash
<b>Integrated Switch</b>	2.1 Gbps integrated wireless switch
<b>Chassis</b>	Lockable mounting plate, Kensington lock slot
<b>Electrical</b>	XN4 supports Power over Gigabit Ethernet (PoGE) only, no splitter required PoGE (DC) Input Power: 48VDC, Maximum 2A Nominal Power: 35W For PoGE, see “Power over Gigabit Ethernet Compatibility Matrix” on page 451.

Element	XN4 Specifications
<b>Interfaces</b>	<p><b>Serial Console Port:</b> 1 x RS232 – RJ45 connector, for local configuration</p> <p><b>Ethernet Interfaces:</b> 1 x Gigabit 100/1000 Mbps uplink port</p> <p><b>Status LEDs:</b> System status, Ethernet, Radio</p>
<b>Networking</b>	<p>DHCP client, DHCP server (multiple DHCP pools), DNS Client, NTP client, NAT</p>
<b>Management</b>	<p>Xirrus Management System (XMS)—Layer 3 Element Management System</p> <p>HTTPS Web Management Interface (WMI)</p> <p>CLI via SSHv2, Telnet, local serial Console</p> <p>Enable/disable management for any interface</p> <p>Read-write and read-only admin accounts may be authenticated via RADIUS</p> <p>SNMP v2c, v3</p> <p>Configuration Files—text-based files may be imported, exported, or compared</p> <p>NetFlow—IP flow information (traffic statistics may be sent to an external Collector)</p> <p>FTP, TFTP</p> <p>Syslog reporting for alerts/alarms—messages may be stored on internal Syslog server or sent to up to three external syslog servers.</p> <p>Cisco Discovery Protocol (CDP)—obtain protocol addresses and platform information for neighboring devices</p>

Element	XN4 Specifications
<b>Quality of Service (QoS) Support</b>	<b>Multiple SSIDs:</b> 16 unique SSIDs per Array Each SSID beacons a unique BSSID per radio VLAN and QoS settings for each SSID <b>VLANs:</b> Up to 16 VLANs, 802.1Q, 802.1p <b>Prioritization:</b> 802.11e wireless prioritization 802.1p wired prioritization Fair queuing of downstream traffic Wireless Voice Support

Element	XN4 Specifications
<p><b>Security</b></p>	<p><b>Wireless Encryption</b>                      Line speed, hardware-accelerated encryption modes:                      WPA TKIP                      WPA2 AES                      WEP 40/64                      WEP 104/128</p> <p><b>Wireless Authentication:</b>                      Open                      Pre-shared Key                      802.1X EAP                      PEAP                      EAP-TLS                      EAP-TTLS                      EAP-LEAP Pass-through                      Web Page Redirect (Captive Portal)                      MAC Address Access Control List (ACL)                      CHAP, PAP</p> <p><b>Firewall:</b>                      Integrated stateful-inspection, rules-based firewall</p> <p><b>Rogue AP detection and blocking:</b>                      Integrated Rogue AP detection and alerting via dedicated internal RF Threat Sensor. Rogue AP can be shielded</p> <p><b>Integrated RADIUS Server:</b>                      Integrated 802.1x Authentication Server supporting EAP-PEAP</p>

Element	XN4 Specifications
<b>Security (continued)</b>	<p><b>Time of Day Access:</b> Specify when access is allowed, per SSID or User Group</p> <p><b>Station-Station Blocking:</b> Station-to-Station traffic blocking option</p>
<b>Wireless</b>	<p><b>Wireless Standards:</b> 802.11a 802.11b 802.11d 802.11g 802.11e 802.11h 802.11i 802.11j 802.11n</p> <p><b>Number of Radios:</b> 4 x 802.11a/b/g/n radios Advanced RF design includes 20 integrated antennas</p> <p><b>Spectrum Analyzer:</b> 1 integrated into Array</p>

Element	XN4 Specifications
<p><b>Wireless (continued)</b></p>	<p><b>Frequency Bands:</b>                      11a/n: 4.945 – 4.985 (restricted Public Safety band)                      11a/n: 5.15-5.25 GHz (UNII 1)                      11a/n: 5.15-5.25 GHz (TELEC)                      11a/n: 5.25-5.35 GHz (UNII 2)                      11a/n: 5.470-5.725 (ETSI)                      11a/n: 5.725-5.825 GHz (UNII 3)                      11b/g/n: 2.412-2.462 GHz (FCC)                      11b/g/n: 2.412-2.472 GHz (ETSI)                      11b/g/n: 2.412-2.484 GHz (TELEC)</p> <p><b>Channel Selection:</b>                      Manual and Automatic</p> <p><b>802.11a/n Antennas</b>                      Integrated 3dBi, sectorized</p> <p><b>802.11b/g/n Antennas</b>                      Integrated 1dBi, sectorized</p> <p><b>Wi-Fi Monitoring:</b>                      1 Integrated Access Point can be set as a dedicated Wi-Fi Threat Sensor                      2 dBi 360° omni-directional antenna</p> <p><b>802.11a/b/g/n External Antenna Connectors:</b>                      1 RP-TNC connector (<b>NOTE:</b> TNC antenna connection is not for outside plant connection.)</p>
<p><b>Performance</b></p>	<p><b>Client Load Balancing</b>                      Automatic load balancing between system radios</p>

Element	XN4 Specifications
<b>Compliance</b>	<p><b>Electromagnetic:</b> ICES-003 (Canada) EN 301.893 (Europe) EN 301.489-1 and -17 (Europe)</p> <p><b>Safety:</b> EN 60950 EN 50371 to 50385 CE Mark</p> <p>Additional information in “Appendix F: Notices” on page 467.</p>
<b>Certifications</b>	<p><b>Wi-Fi Alliance:</b> 802.11a/b/g/n, WPA, WPA2, and extended EAP types. <a href="#">Our certifications may be viewed here.</a></p> <p>Additional information in “Appendix F: Notices” on page 467.</p>
<b>Warranty</b>	<p><b>Hardware:</b> Five Year Standard (extendable)</p> <p><b>Software:</b> 90 Days Standard (extendable)</p>



## Product Specifications—XS16 and XS8

Element	XS16/XS8 Specifications
<b>Number of Users</b>	Maximum of 64 associated users per radio 1024 users per Array (XS16) 512 users per Array (XS8)
<b>Physical</b>	Diameter: 18.65 inches (47.37 cm) Height: 3.87 inches (9.83 cm) Weight: 8lbs (3.63 kg)
<b>Environmental</b>	<b>Operating Temperature:</b> -10°C to 50°C 0% to 90% relative humidity (non-condensing) <b>Storage Temperature:</b> -20°C to 60°C 5% to 95% relative humidity (non-condensing)
<b>System</b>	1 GHz CPU 1 GB RAM 1 GB system flash Expansion slot for future options
<b>Interfaces</b>	<b>Serial:</b> 1 x RS232 – RJ45 connector <b>Ethernet Interfaces:</b> 2 x Gigabit 100/1000 Mbps w/ failover 1 x Fast Ethernet 10/100 Mbps <b>Status LEDs:</b> System status, Ethernet, Radio

Element	XS16/XS8 Specifications
<b>Electrical</b>	<p><b>XS16/XS8:</b></p> <p>Each Array supports both AC and PoGE</p> <p>AC Input Power: 90-265VAC at 47-63Hz</p> <p>PoGE Input Power: Power over Gigabit Ethernet—no splitter required, 48VDC</p> <p>Nominal Power:</p> <p>    XS16: 70W</p> <p>    XS8: 45W</p> <p>For PoGE, see “Power over Gigabit Ethernet Compatibility Matrix” on page 451.</p>
<b>Networking</b>	DHCP client, DHCP server, NTP client, NAT
<b>VLAN Support</b>	802.1Q, 802.1p VLAN Supports up to 16 VLANs
<b>Multiple SSID Support</b>	Allows up to 16 separate SSIDs to be defined with map security, VLAN and QoS settings for each SSID
<b>Performance</b>	<p><b>Client Load Balancing</b></p> <p>Automatic load balancing between system radios</p> <p><b>Quality of Service:</b></p> <p>802.1p wired traffic prioritization</p> <p>Wireless packet prioritization</p> <p>MAP CoS to TCID</p> <p>Fair queuing of downstream traffic</p>

Element	XS16/XS8 Specifications
<b>Security</b>	<p><b>Wireless Security:</b>                      WEP 40bit/128bit encryption                      WPA and WPA2 with TKIP and AES encryption                      Rogue AP detection, with alerts and classification</p> <p><b>User and System Authentication:</b>                      WPA and WPA2 Pre-Shared Key authentication                      Internal RADIUS Server, supports EAP-PEAP only                      802.1x EAP-TLS                      802.1x EAP-TTLS/MSCHAPv2                      802.1x PEAPv0/EAP-MSCHAPv2                      802.1x PEAPv1/EAP-GTC                      802.1x EAP-SIM                      802.1x EAP-LEAP Passthrough                      External RADIUS servers                      Authentication of Wi-Fi Arrays to the Xirrus Management System (XMS)</p>

Element	XS16/XS8 Specifications
<b>Wireless</b>	<p><b>Number of Radios:</b></p> <p><b>XS16:</b>                12 x 802.11a radios                                        4 x 802.11a/b/g radios          Only 12 radios should be used as 802.11a radios concurrently.</p> <p><b>XS8:</b>                    4 x 802.11a radios                                        4 x 802.11a/b/g radios</p> <p><b>Wireless Standards:</b>          802.11a/b/g and g-only mode          802.11e, 802.11i</p> <p><b>Channel Selection:</b>          Manual and Automatic</p> <p><b>Frequency Bands:</b>          11a: 4.945 – 4.985 (restricted Public Safety band)          11a: 5.15-5.25 GHz (UNII 1)          11a: 5.15-5.25 GHz (TELECOM)          11a: 5.25-5.35 GHz (UNII 2)          11a: 5.470-5.725 (ETSI)          11a: 5.725-5.825 GHz (UNII 3)          11b/g: 2.412-2.462 GHz (FCC)          11b/g: 2.412-2.472 GHz (ETSI)          11b/g: 2.412-2.484 GHz (TELECOM)</p> <p><b>Antennas (XS16):</b>          12 x internal 6 dBi 60° 802.11a sectorized          4 x internal 3 dBi 180° 802.11b/g sectorized          1 x internal 2 dBi 360° omni-directional (for RF monitoring)          3 x external RP-TNC connectors for three 802.11a/b/g radios *</p>

Element	XS16/XS8 Specifications
<p><b>Wireless (continued)</b></p>	<p><b>Antennas (XS8):</b>                      4 x internal 6 dBi 60° 802.11a sectorized                      4x internal 3 dBi 180° 802.11b/g sectorized                      1 x internal 2 dBi 360° omni-directional (for RF monitoring)                      3 x external RP-TNC connectors for three 802.11a/b/g radios *</p> <p><b>Radio Approvals:</b>                      FCC (United States) and EN 301.893 (Europe)</p> <p>* Note: External RP-TNC antenna connectors are not for outside plant connection.</p>
<p><b>Management</b></p>	<p>Web-based HTTPS                      SNMP v2c, v3                      CLI via SSHv2 or Telnet                      FTP                      TFTP                      Serial                      Xirrus Management System (XMS)                      Syslog reporting for alerts/alarms</p>
<p><b>Compliance</b></p>	<p>UL / cUL 60950 and EN 60950                      FCC Part 15.107 and 15109, Class A                      EN 301.489 (Europe)                      EN60601 EU medical equipment directive for EMC                      Additional information in “Appendix F: Notices” on page 467.</p>

Element	XS16/XS8 Specifications
<b>Certifications</b>	<p>Wi-Fi Alliance: 802.11a/b/g, WPA, WPA2, and extended EAP types. Our certifications may be viewed <a href="#">here</a>.</p> <p>Federal Information Processing Standard (FIPS) Publication 140 -2, Level 2.</p> <p>Payment Card Industry Data Security Standard (PCI DSS) verified by VeriSign</p> <p>Additional information in “Appendix F: Notices” on page 467.</p>
<b>Warranty</b>	One year (hardware and software)

## Product Specifications—XS4

Element	XS4 Specifications
<b>Number of Users</b>	Maximum of 64 associated users per radio (256 users per Array)
<b>Physical</b>	Diameter: 12.58 inches (31.95 cm) Height: 2.58 inches (6.55 cm) Weight: 4lbs (1.81 kg)
<b>Environmental</b>	<p><b>Operating Temperature:</b> -10°C to 50°C 0% to 90% relative humidity (non-condensing)</p> <p><b>Storage Temperature:</b> -20°C to 60°C 5% to 95% relative humidity (non-condensing)</p>
<b>System</b>	825 MHz CPU (XS4) 512 MB RAM, expandable (XS4) 512 MB system flash, expandable Expansion slot for future options
<b>Electrical</b>	<p><b>XS4:</b>                      Each Array supports both AC and PoGE                      AC Input Power: 90-265VAC at 47-63Hz                      Nominal power usage: 27W                      Power over Gigabit Ethernet (PoGE): all 4-port models work with all Xirrus PoGE modules, splitter required, 48VDC                      See “Power over Gigabit Ethernet Compatibility Matrix” on page 451.</p>

Element	XS4 Specifications
<b>Interfaces</b>	<b>Serial:</b> 1 x RS232 – RJ45 connector <b>Ethernet Interfaces:</b> 1 x Gigabit 100/1000 Mbps <b>Status LEDs:</b> System status, Ethernet, Radio
<b>Management</b>	Web-based HTTPS SNMP v2c, v3 CLI via SSHv2 or Telnet FTP TFTP Serial Xirrus Management System (XMS) Syslog reporting for alerts/alarms
<b>Networking</b>	DHCP client, DHCP server, NTP client, NAT
<b>VLAN Support</b>	802.1Q, 802.1p VLAN Supports up to 16 VLANs
<b>Multiple SSID Support</b>	Allows up to 16 separate SSIDs to be defined with map security, VLAN and QoS settings for each SSID
<b>Performance</b>	<b>Client Load Balancing</b> Automatic load balancing between system radios <b>Quality of Service:</b> 802.1p wired traffic prioritization Wireless packet prioritization MAP CoS to TCID Fair queuing of downstream traffic



Element	XS4 Specifications
<p><b>Security</b></p>	<p><b>Wireless Security:</b>                      WEP 40bit/128bit encryption                      WPA and WPA2 with TKIP and AES encryption                      Rogue AP detection, with alerts and classification</p> <p><b>User and System Authentication:</b>                      WPA Pre-Shared Key authentication                      Internal RADIUS Server, supports EAP-PEAP only                      802.1x EAP-TLS                      802.1x EAP-TTLS/MSCHAPv2                      802.1x PEAPv0/EAP-MSCHAPv2                      802.1x PEAPv1/EAP-GTC                      802.1x EAP-SIM                      802.1x EAP-LEAP Passthrough                      External RADIUS servers                      Authentication of Wi-Fi Arrays to the Xirrus Management System (XMS)</p>

Element	XS4 Specifications
<b>Wireless</b>	<p><b>Number of Radios:</b> 4 x 802.11a/b/g radios</p> <p><b>Wireless Standards:</b> 802.11a/b/g and g-only mode 802.11e, 802.11i</p> <p><b>Channel Selection:</b> Manual and Automatic</p> <p><b>Frequency Bands:</b> 11a: 4.945 – 4.985 (restricted Public Safety band) 11a: 5.15-5.25 GHz (UNII 1) 11a: 5.15-5.25 GHz (TELEC) 11a: 5.25-5.35 GHz (UNII 2) 11a: 5.470-5.725 (ETSI) 11a: 5.725-5.825 GHz (UNII 3) 11b/g: 2.412-2.462 GHz (FCC) 11b/g: 2.412-2.472 GHz (ETSI) 11b/g: 2.412-2.484 GHz (TELEC)</p> <p><b>Radio Approvals:</b> FCC (United States) and EN 301.893 (Europe)</p>
<b>Compliance</b>	<p>UL / cUL 60950 and EN 60950 FCC Part 15.107 and 15109, Class A EN 301.489 (Europe) EN60601 EU medical equipment directive for EMC Additional information in <a href="#">“Appendix F: Notices”</a> on page 467.</p>

Element	XS4 Specifications
<p><b>Certifications</b></p>	<p>Wi-Fi Alliance: 802.11a/b/g, WPA, WPA2, and extended EAP types. Our certifications may be viewed <a href="#">here</a>.</p> <p>Federal Information Processing Standard (FIPS) Publication 140 -2, Level 2.</p> <p>Payment Card Industry Data Security Standard (PCI DSS) verified by VeriSign</p> <p>Additional information in “Appendix F: Notices” on page 467.</p>
<p><b>Warranty</b></p>	<p>One year (hardware and software)</p>



# Installing the Wi-Fi Array

The instructions for completing a successful installation include the following topics:

- [“Installation Prerequisites” on page 57.](#)
- [“Planning Your Installation” on page 60.](#)
- [“Installation Workflow” on page 94.](#)
- [“Installing Your Wi-Fi Array” on page 96.](#)
- [“Powering Up the Wi-Fi Array” on page 100.](#)
- [“Establishing Communication with the Array” on page 103.](#)
- [“Performing the Express Setup Procedure” on page 106.](#)

## Installation Prerequisites

Your Wi-Fi Array deployment requires the presence of hardware and services in the host wired/wireless network, including:

- **Power Source**

Most Arrays are powered via Xirrus Power over Gigabit Ethernet. PoGE supplies power over the same Cat 5e or Cat 6 cable used for data, thus reducing cabling and installation effort. PoGE power injector modules are available in 1-, 2-, and 8-port configurations and are typically placed near your Gigabit Ethernet switch. An AC outlet is required for each injector module. Current Array models have integrated splitters, so no separate splitter is required.

Specific models of the Array are compatible with specific PoGE modules. For details, please see [“Power over Gigabit Ethernet Compatibility Matrix” on page 451.](#)

If your Arrays are equipped to accept AC power (and you are not using PoGE), you need a dedicated power outlet to supply AC power to each unit deployed at the site.

- **Ethernet port**

You need at least one 100/1000 BaseT port to establish wired Gigabit Ethernet connectivity (via the product's **Gigabit 1** or **Gigabit 2** port) and one 10/100 BaseT port (if desired) for product management.

! *The Array's Ethernet ports should be connected to an Ethernet switch, not an Ethernet hub—if a hub is used, we recommend that you connect only one Ethernet port.*

! *The Gigabit1 Ethernet interface is the primary port for both data and management traffic. If a single Ethernet connection is used, it must be connected to the Gigabit1 Ethernet interface. See also, "Port Failover Protection" on page 80.*

*The 10/100 Ethernet Port may be used for managing the Array out of band from the Gigabit Ethernet ports. The 10/100 port will route only management traffic, using a static route that may be configured for this interface. See "interface" on page 370.*

- **Secure Shell (SSH) utility**

To establish secure remote command line access to the Array, you need a Secure Shell (SSH) utility, such as PuTTY. The utility **must** be configured to use SSH-2, since the Array will only allow SSH-2 connections.

- **Secure Web browser**

Either Internet Explorer (version 6.0 or higher), Netscape Navigator (version 7.0 or higher), or Mozilla Firefox (version 1.01 or higher). A secure Web browser is required for Web-based management of the Array. The browser must be on the same subnet as the Array, or you must set a static route for management as described in the warning above.

- **Serial connection capability**

To connect directly to the console port on the Array, your computer must be equipped with a male 9-pin serial port and terminal emulation software (for example, HyperTerminal). The Xirrus Array only supports serial cable lengths up to 25' per the RS-232 specification.

Use the following settings when establishing a serial connection:

Bits per second	115,200
Data bits	8
Parity	None
Stop bits	1
Flow control	None

### Optional Network Components

The following network components are optional.

- **Xirrus Management System (XMS)**  
The optional XMS offers powerful management features for small or large Wi-Fi Array deployments.
- **External RADIUS server**  
Although your Array comes with an embedded [RADIUS](#) server, for 802.1x authentication in large deployments you may want to add an external RADIUS server.

### Client Requirements

The Wi-Fi Array should only be used with Wi-Fi certified client devices.

#### *See Also*

[Coverage and Capacity Planning](#)

[Deployment Examples](#)

[Failover Planning](#)

[Planning Your Installation](#)

## Planning Your Installation

This section provides guidelines and examples to help you plan your Xirrus Wi-Fi Array deployment to achieve the best overall coverage and performance. We recommend you conduct a site survey to determine the best location and settings for each Array you install.

The following topics are discussed:

- “General Deployment Considerations” on page 60
- “Coverage and Capacity Planning” on page 62
- “IEEE 802.11n Deployment Considerations” on page 72
- “Failover Planning” on page 80
- “Power Planning” on page 82
- “Security Planning” on page 83
- “Port Requirements” on page 86
- “Network Management Planning” on page 89
- “WDS Planning” on page 90
- “Common Deployment Options” on page 93



*For a complete discussion of implementing Voice over Wi-Fi on the Array, see the [Xirrus Voice over Wi-Fi Application Note](#) in the [Xirrus Library](#).*

### General Deployment Considerations

The Wi-Fi Array’s unique multi-radio architecture generates 360 degrees of sectored high-gain 802.11a/b/g/n or 802.11a/b/g coverage that provides extended range. However, the number, thickness and location of walls, ceilings or other objects that the wireless signals must pass through may affect the range. Typical ranges vary depending on the types of materials and background RF (radio frequency) noise at your location. To maximize wireless range, follow these basic guidelines:

1. Keep the number of walls and ceilings between the Array and your receiving devices to a minimum—each wall or ceiling can reduce the



wireless range from between 3 and 90 feet (1 to 30 meters). Position your devices so that the number of walls or ceilings is minimized.

2. Be aware of the direct line between each device. For example, a wall that is 1.5 feet thick (half a meter) at  $90^\circ$  is actually almost 3 feet thick (or 1 meter) when viewed at a  $45^\circ$  angle. At an acute  $2^\circ$  degree angle the same wall is over 42 feet (or 14 meters) thick! For best reception, try to ensure that your wireless devices are positioned so that signals will travel straight through a wall or ceiling.

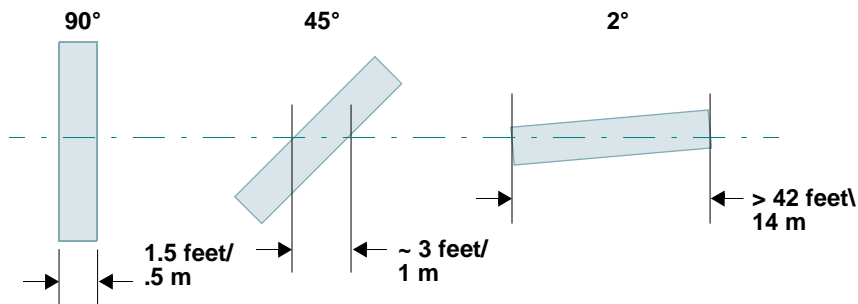

Figure 10. Wall Thickness Considerations

3. Try to position wireless client devices so that the signal passes through drywall (between studs) or open doorways and not other materials that can adversely affect the wireless signal.

### See Also

[Coverage and Capacity Planning](#)

[Deployment Examples](#)

[Common Deployment Options](#)

[Installation Prerequisites](#)

## Coverage and Capacity Planning

This section considers coverage and capacity for your deployment(s), including placement options, RF patterns and cell sizes, area calculations, roaming considerations, and channel allocations.



*Note that several advanced features in this section are part of the Xirrus Advanced RF Performance Manager (RPM). They require the license installed on the Array to include support for RPM. Please see “About Licensing and Upgrades” on page 325.*

## Placement

Use the following guidelines when considering placement options:

1. The best placement option for the Array is ceiling-mounted within an open plan environment (cubicles rather than fixed walls).
2. Keep the Array away from electrical devices or appliances that generate RF noise. Because the Array is generally mounted on ceilings, be aware of its position relative to lighting (especially fluorescent lighting)—we recommend maintaining a distance of at least 3 to 6 feet (1 to 2 meters).

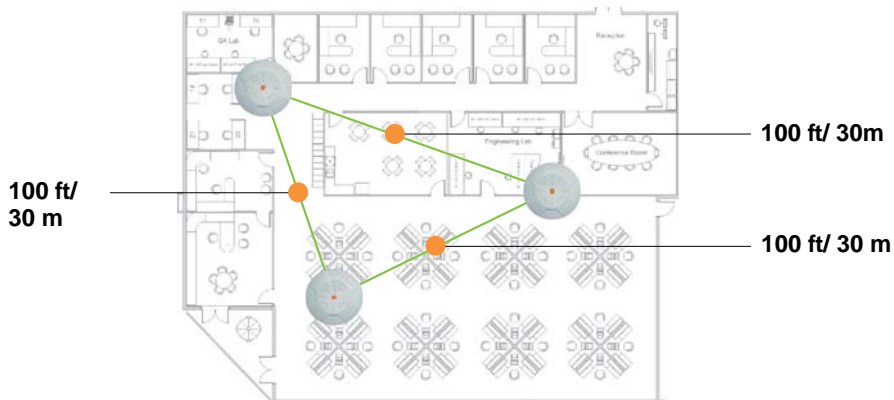

Figure 11. Unit Placement

3. If using multiple Arrays in the same area, maintain a distance of at least 100ft/30m between Arrays if there is direct line-of-sight between units, or at least 50ft/15m if a wall or other barrier exists between units.

### **RF Patterns**

The Wi-Fi Array allows you to control—automatically or manually—the pattern of wireless coverage that best suits your deployment needs. You can choose to operate with full coverage, half coverage, or custom coverage (by enabling or disabling individual sectors).

#### ***Full (Normal) Coverage***

In normal operation, the Array provides a full 360 degrees of coverage.

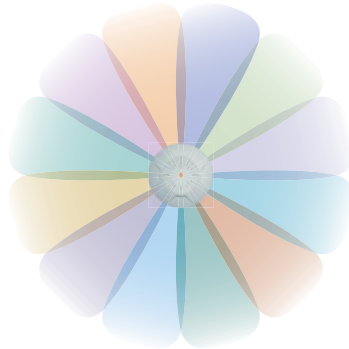

Figure 12. Full (Normal) Coverage

#### ***Half Coverage***

If installing a unit close to an exterior wall, you can deactivate half of the radios to prevent redundant signals from “bleeding” beyond the wall and extending

service into public areas. The same principle applies if you want to restrict service to an adjacent room within the site.

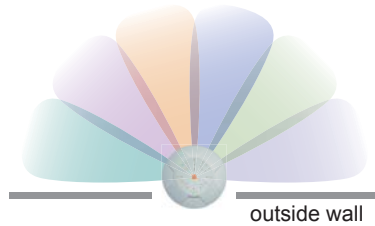

Figure 13. Adjusting RF Patterns

### *Custom Coverage*

Where there are highly reflective objects in proximity to the Array, you can turn off specific radios to avoid interference and feedback.

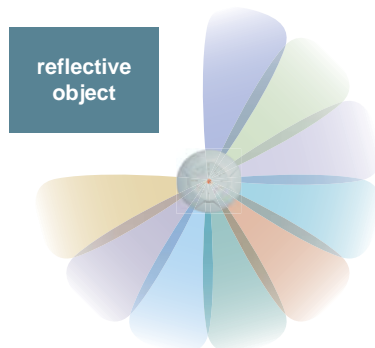

Figure 14. Custom Coverage

### Capacity and Cell Sizes

Cell sizes should be estimated based on the number of users, the applications being used (for example, data/video/voice), and the number of Arrays available at the location. The capacity of a cell is defined as the minimum data rate desired for each sector multiplied by the total number of sectors being used.

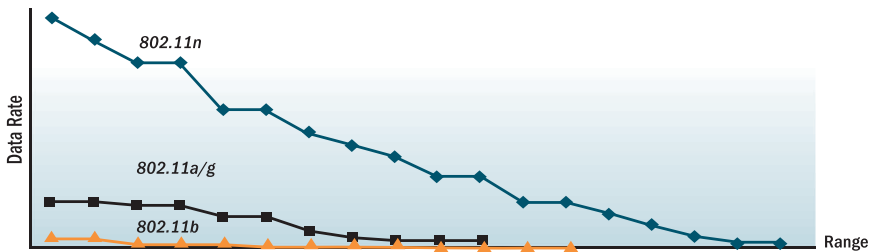

Figure 15. Connection Rate vs. Distance

Figure 15 shows relative connection rates for 802.11n vs. 802.11a/g and 802.11b, and the effect of distance on the connection rates. Wireless environments can vary greatly so the actual rates may be different depending on the specific network deployment.



*The XS4 and XN4 have a smaller range than the larger Arrays.*

### Fine Tuning Cell Sizes

Adjusting the [transmit power](#) allows you to fine tune cell sizes. There are four standard sizes—Small, Medium, Large, or Max (the default is **Max**). There is also an Auto setting that automatically determines the best cell size, and a Manual setting that allows you to choose your power settings directly.

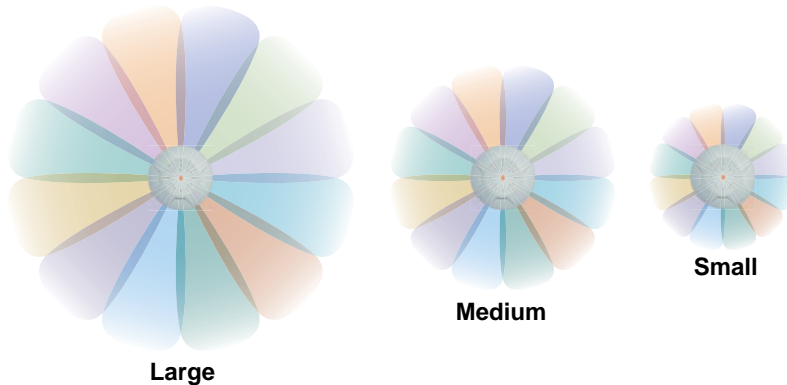

Figure 16. Transmit Power

Auto Cell Size is an automatic, self-tuning mechanism that balances cell size between Arrays to guarantee coverage while limiting the RF energy that could extend beyond the organizational boundary. Auto Cell uses communication between Arrays to dynamically set radio power so that complete coverage is provided to all areas, yet at the minimum power level required. This helps to minimize potential interference with neighboring networks. Additionally, Arrays running Auto Cell automatically detect and compensate for coverage gaps caused by system interruptions. To enable the Auto Cell Size feature, go to “[RF Power & Sensitivity](#)” on page 298. For a complete discussion of the Auto Cell size feature, see the *Xirrus Auto Cell Application Note* in the [Xirrus Library](#).

If you are installing many units in proximity to each other, we recommend that you use Auto Cell Size; otherwise, reduce the transmit power using manual settings to avoid excessive interference with other Arrays or installed APs. See also, “[Coverage and Capacity Planning](#)” on page 62.

### *Sharp Cell*

This patented Xirrus RF management option automatically creates more intelligently defined cells and improves performance by creating smaller, high-throughput cells. By dynamically limiting each cell to a defined boundary (cell size), the trailing edge bleed of RF energy is reduced, thus minimizing interference between neighboring Wi-Fi Arrays or other Access Points. To enable the Sharp Cell feature, go to “[RF Power & Sensitivity](#)” on page 298. For more information about this feature, see the *Xirrus Sharp Cell Application Note* in the [Xirrus Library](#).

### **Roaming Considerations**

Cells should overlap approximately 10 - 15% to accommodate client roaming.

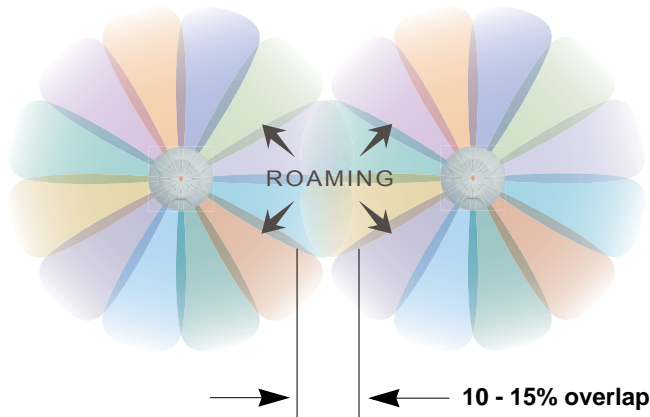

Figure 17. Overlapping Cells

### **Allocating Channels**

Because the Wi-Fi Array is a multi-channel device, allocating the best channels to radios is important if peak performance is to be maintained.

### *Automatic Channel Selection*

We recommend that you allow the Array to make intelligent channel allocation decisions automatically. In the automatic mode, channels are allocated dynamically, driven by changes in the environment. Auto Channel assignment is

performed by scanning the surrounding area for RF activity on all channels, then automatically selecting and setting channels on the Array to the best channels available. This function is typically executed when initially installing Arrays in a new location and may optionally be configured to execute periodically to account for changes in the RF environment over time. Auto Channel selection has significant advantages, including:

- Allows the Array to come up for the first time and not interfere with existing equipment that may be already running, thereby limiting co-channel interference.
- More accurately tunes the RF characteristics of a Wi-Fi installation than manual configuration since the radios themselves are scanning the environment from their physical location.
- May be configured to run periodically.

To set up the automatic channel selection feature, go to “[Advanced RF Settings](#)” on [page 294](#). For more information about this feature, see the *Xirrus Auto Channel Application Note* in the [Xirrus Library](#).



**Manual Channel Selection**

You can manually assign channels on a per radio basis, though manual selection is not recommended (and not necessary).



*To avoid co-channel interference, do not select adjacent channels for radios that are physically next to each other.*

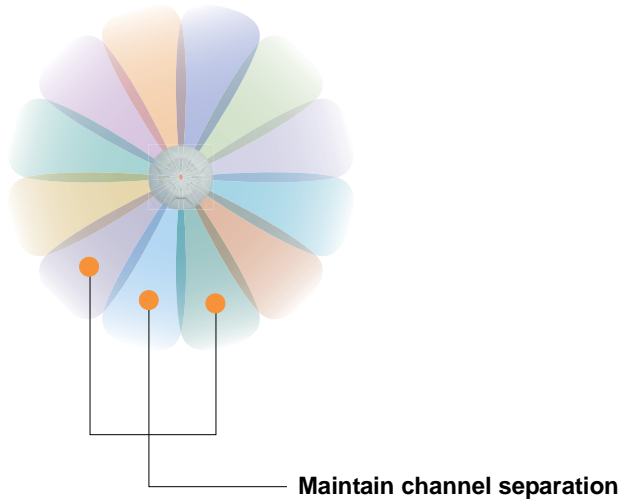

Figure 18. Allocating Channels Manually

**See Also**

- Deployment Examples
- Failover Planning
- Installation Prerequisites

### Deployment Examples

The following examples employ 802.11a cells, each offering minimum throughputs of 54 Mbps, 36 Mbps, and 18 Mbps per sector respectively, and assume a floor plan covering a total area of about 60,000 square feet (5574 sq m).

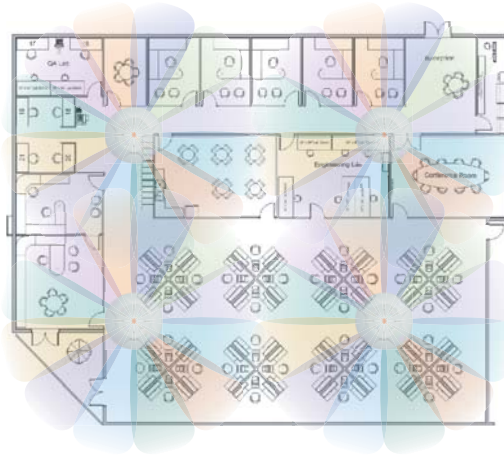

Figure 19. Deployment Scenario (54 Mbps)—Per Sector



Figure 20. Deployment Scenario (36 Mbps)—Per Sector



Figure 21. Deployment Scenario (18 Mbps)—Per Sector

*See Also*

Coverage and Capacity Planning

Failover Planning

Planning Your Installation

## IEEE 802.11n Deployment Considerations



*IEEE 802.11n features are supported only on XR and XN Array models, and this section applies only to those Arrays. Note that the license installed on the Array must include support for 802.11n. Please see “**About Licensing and Upgrades**” on page 325.*

The Xirrus XR and XN Arrays support IEEE 802.11n on all IAPs, in both 2.4 GHz and 5 GHz bands. Use of 802.11n offers significant benefits:

- Higher data rates
- Higher throughput
- Supports more users
- More robust connections
- Increased coverage area
- More secure connections—supports WPA2 (Wi-Fi Protected Access 2)

These benefits result in better support for a wide range of applications such as voice and video, intensive usage such as CAD/CAM and backups, dense user environments, and for manufacturing and warehousing environments.



*While 802.11n increases coverage area by almost doubling the reach, you must consider the legacy wireless devices in your network. Wireless stations connecting using 802.11a/b/g will still be subject to a reach of up to 100 feet, depending on the environment.*

The techniques that 802.11n uses to realize these performance improvements, and the results that can be expected are discussed in:

- “MIMO (Multiple-In Multiple-Out)” on page 73
- “Multiple Data Streams—Spatial Multiplexing” on page 75
- “Channel Bonding” on page 76
- “Improved MAC Throughput” on page 77
- “Short Guard Interval” on page 77
- “Obtaining Higher Data Rates” on page 78
- “802.11n Capacity” on page 79

Two very important techniques to consider are [Channel Bonding](#) and [Multiple Data Streams—Spatial Multiplexing](#) because they contribute a large portion of 802.11n’s speed improvements and because they are optional and configurable, as opposed to the parts of 802.11n that are fixed. While the settings for 802.11n IAPs come pre-configured on the Array for robust performance in typical usage, you should review the settings for your deployment, especially channel bonding. A global setting is provided to enable or disable 802.11n mode. See “[Global Settings .11n](#)” on page 291 to configure 802.11n operation.

### MIMO (Multiple-In Multiple-Out)

MIMO (Multiple-In Multiple-Out) signal processing is one of the core technologies of 802.11n. It mitigates interference and maintains broadband performance even with weak signals.

Prior to 802.11n, a data stream was transmitted via one antenna. At the receiving end, the antenna with the best signal was selected to receive data. ([Figure 22](#))

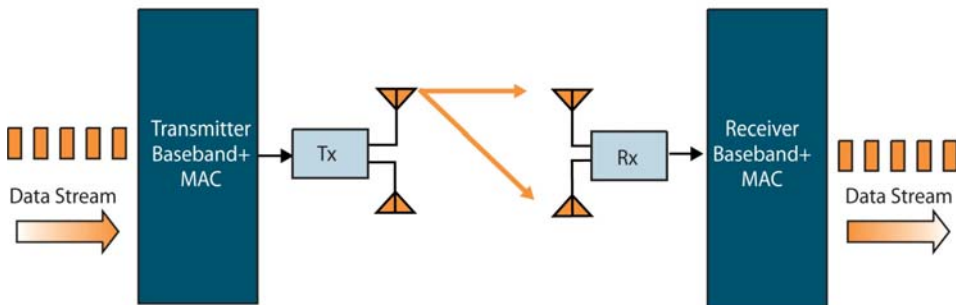

Figure 22. Classic 802.11 Signal Transmission

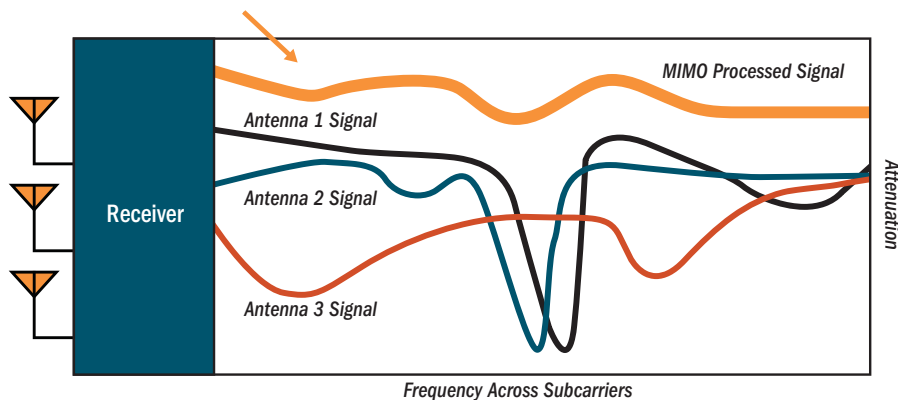

Figure 23. MIMO Signal Processing

MIMO signal processing uses multiple antennas to send and receive data. It takes advantage of multipath reflections to improve signal coherence and greatly increase receiver sensitivity (Figure 23). Multipath signals were considered to be interference by 802.11a/b/g radios, and degraded performance. In 802.11n, these signals are used to enhance performance. This extra sensitivity can be used for greater range or higher data rates. The enhanced signal is the processed sum of individual antennas. Signal processing eliminates nulls and fading that any one antenna would see. MIMO signal processing is sophisticated enough to discern multiple spatial streams (see [Multiple Data Streams—Spatial Multiplexing](#)). There are no settings to configure for MIMO.

### Multiple Data Streams—Spatial Multiplexing

Spatial Multiplexing transmits completely separate data streams on different antennas (in the same channel) that are recombined to produce new 802.11n data rates. Higher data rates are achieved by splitting the original data stream into separate data streams. Each separate stream is transmitted on a different antenna (using its own RF chain). MIMO signal processing at the receiver can detect and recover each stream. Streams are then recombined, yielding higher data rates.

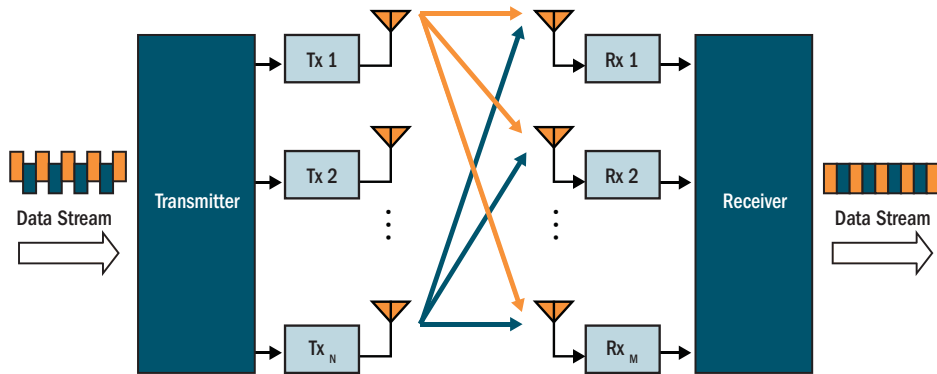

Figure 24. Spatial Multiplexing

Spatial multiplexing can double, triple, or quadruple the data rate, depending on the number of transmit antennas used. You can configure the number of chains (i.e., streams) separately for transmitting and receiving. By default, the Array uses three chains for transmitting and receiving (see “Global Settings .11n” on page 291).

## Channel Bonding

Channel bonding increases data rates by combining two adjacent 20 MHz channels into one 40 MHz channel. This increases the data rate to slightly more than double.

A bonded 40 MHz channel is specified in terms of the Primary channel and the adjacent channel to Bond. The Bond channel is represented by **+1** to use the channel above the Primary channel, or **-1** to use the channel below. In the example shown, Channel 40 is the Primary channel and it is bonded to Channel 36, the channel below it, by specifying **-1**. Be aware that Channel Bonding can make channel planning more difficult, since you are using two channels for an IAP. We recommend the use of the 5 GHz band, since it has many more channels than the 2.4 GHz band, and thus more channels are available for bonding.

The Array provides an Automatic Channel Bonding setting that will automatically select the best channel for bonding on each IAP. If you enable this option, you may select whether bonding will be dynamic (the bonded channel changes in response to environmental conditions) or static (the bonded channel will not be changed). See “Global Settings .11n” on page 291. To configure channel bonding manually, on a per-IAP basis, see “IAP Settings” on page 271.

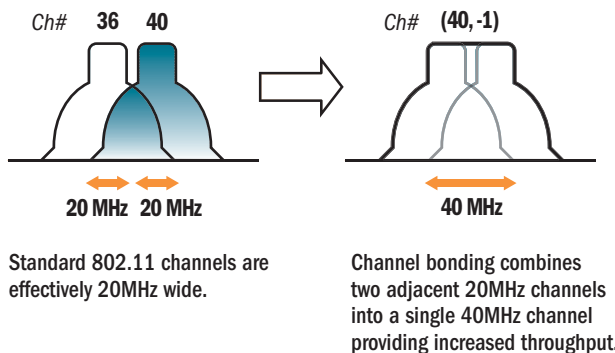

Figure 25. Channel Bonding



### Improved MAC Throughput

These changes make 802.11n transmission of MAC frames 40% more efficient than legacy transmission:

- MAC data frames are combined and given a single PHY header.
- Implicit Block ACK acknowledges all data frames within a combined frame.
- Spacing between frames is reduced.

#### Frame Aggregation

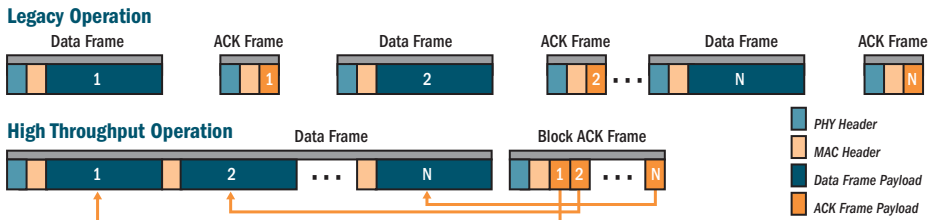

#### RIFS Usage (Reduced Inter-Frame Spacing)

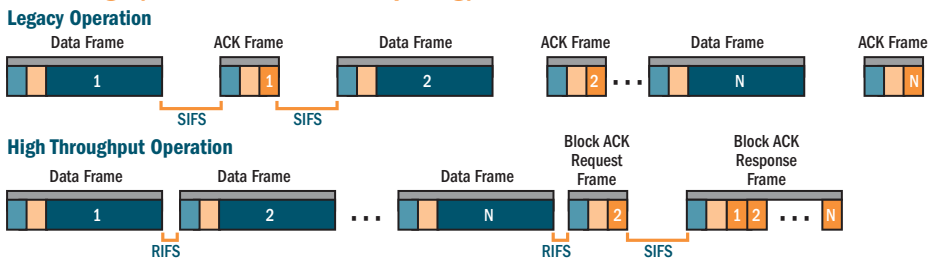

Figure 26. MAC Throughput Improvements

### Short Guard Interval

This option reduces the wait time between signals that are being sent out over the air. The guard interval provides immunity to propagation delays and reflections, and is normally 800 ns (long). By using a short guard interval (400 ns), the data rate is increased by approximately 11%. The short interval may be used in many environments (especially indoors). If the short guard interval is used in an

inappropriate environment, the signal quality will suffer and throughput will decrease. See “Global Settings .11n” on page 291 to configure the guard interval.

### Obtaining Higher Data Rates

The data rate increase obtained by using 802.11n on an Array is incremental, based on the technologies that are applied and the options that you select:

- Higher encoding rates (Mandatory in 802.11n)
- Spatial Streams (Mandatory, but multiplier varies directly with number of streams selected.)
- Channel Bonding (Mandatory in 802.11n, apply multiplier to IAP if it is bonded.)
- Short Guard Interval (Optional)

See Figure 27 to compute your 802.11n data rate increase for an IAP. Apply this increase to the 802.11 a, b or g data rates selected for the Array.

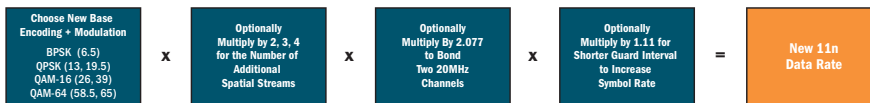

### Expected 802.11n Data Rates

802.11a 802.11g Rates	Expected First Generation Device Data Rates					
	11n Mandatory Data Rates	One Spatial Stream		Two Spatial Streams		
		With Channel Bonding (40MHz)	With Short Guard Interval		With Channel Bonding (40MHz)	With Short Guard Interval
6	6.5	13.5	15	13	27	30
9	13	27	30	26	54	60
12	19.5	40.5	45	39	81	90
18	26	54	60	52	108	120
24	39	81	90	78	162	180
36	52	108	120	104	216	240
48	58.5	121.5	135	117	243	270
54	65	135	150	130	270	300

Figure 27. Computing 802.11n Data Rates

### 802.11n Capacity

802.11n offers major increases in capacity over previous 802.11 standards, as shown in Figure 28. Note that this chart shows figures for 802.11n (with one spatial stream and channel bonding).

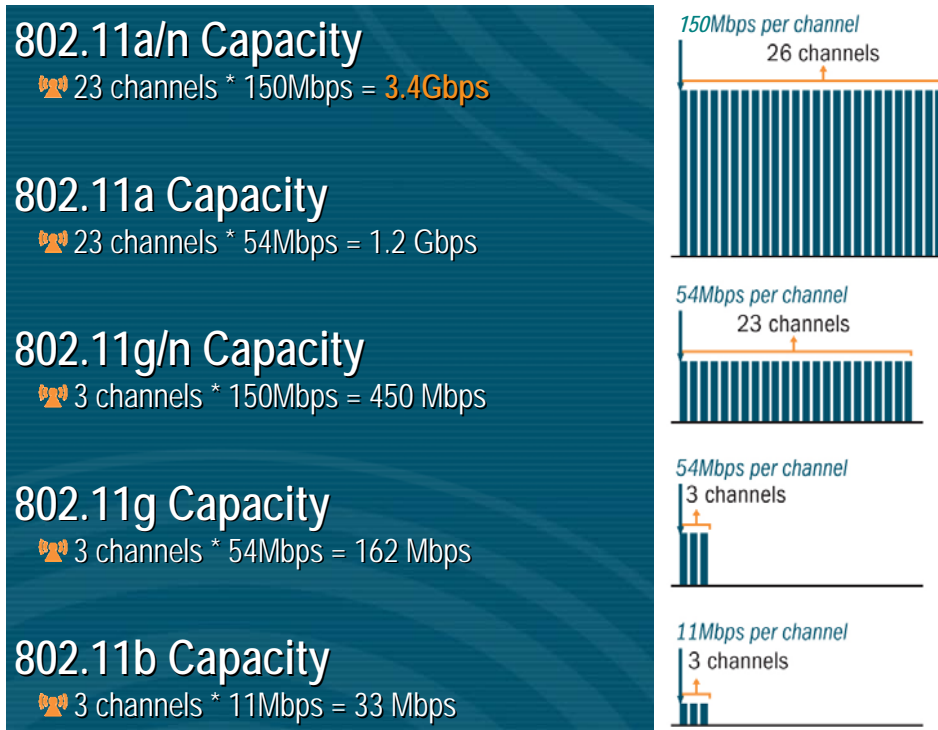

Figure 28. 802.11n Increases Capacity

**Failover Planning**

This section discusses failover protection at the unit and port levels.

**Port Failover Protection**

To ensure that service is continued in the event of a port failure, you can utilize the Gigabit 1 and Gigabit 2 ports simultaneously.

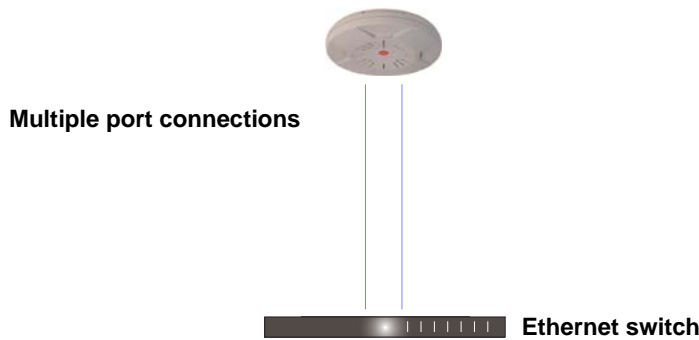

Figure 29. Port Failover Protection

In addition, the Array has full failover protection between the Gigabit 1 and Gigabit 2 Ethernet ports (see following table).

Interface	Bridges Data?	Bridges Management Traffic?	Fails Over To:	IP address
Fast Ethernet	No	Yes	None	DHCP or static
Gigabit 1	Yes	Yes	Gigabit 2	DHCP or static
Gigabit 2	Yes	Yes	Gigabit 1	Assumes the IP address of Gigabit 1

The Wi-Fi Array Gigabit Ethernet ports actually support a number of modes:

- 802.3ad Link Aggregation

- Load Balancing
- Broadcast
- Link Backup
- Bridged
- Mirrored

For more details on Gigabit port modes and their configuration, please see [“Network Interface Ports”](#) on page 181.

### Switch Failover Protection

To ensure that service is continued in the event of a switch failure, you can connect Arrays to more than one Ethernet switch (not a hub).



Figure 30. Switch Failover Protection



*Gigabit Ethernet connections must be on the same subnet.*

### See Also

- Coverage and Capacity Planning
- Deployment Examples
- Installation Prerequisites
- Network Management Planning
- Planning Your Installation
- Power Planning
- Security Planning

## Power Planning

All XR and XN Series Array models and XS16/8/4 Arrays support Power over Gigabit Ethernet (PoGE) with an integrated splitter. AC power is also supported on some versions of the XS8 and XS16. [? True??](#)

This section discusses the AC and PoGE power options.

### *AC Power*

The AC power option requires a direct connection between the Array and a dedicated AC power outlet. The power cord is provided with the unit.

### **Power over Gigabit Ethernet**

To deliver power to the Array, you may use the optional XP1, XP2, or XP8 Power over Gigabit Ethernet (PoGE) modules. They provide power over Cat 5e or Cat 6 cables to the Array without running power cables—see [Figure 5 on page 14](#).

Specific models of the Array are compatible with specific PoGE modules. For details, please see **“Power over Gigabit Ethernet Compatibility Matrix” on page 451**.



*When using Cat 5e or Cat 6 cable, power can be provided up to a distance of 100m.*

### *See Also*

Coverage and Capacity Planning

Deployment Examples

Failover Planning

Network Management Planning

Security Planning

## Security Planning

This section offers some useful guidelines for defining your preferred encryption and authentication method. For additional information, see “Understanding Security” on page 210 and the Security section of “Frequently Asked Questions” on page 432.



*Note that several advanced features in this section are part of the Xirrus Advanced RF Security Manager (RSM). They require the license installed on the Array to include support for RSM. Please see “About Licensing and Upgrades” on page 325.*

## Wireless Encryption

Encryption ensures that no user can decipher another user’s data transmitted over the airwaves. There are three encryption options available to you, including:

- **WEP-40bit or WEP-128bit**  
Because WEP is vulnerable to cracks, we recommend that you only use this for legacy devices that cannot support a stronger encryption type.
- **Wi-Fi Protected Access (WPA)**  
This is much more secure than WEP and uses TKIP for encryption.
- **Wi-Fi Protected Access (WPA2) with AES**  
This is government-grade encryption—available on most new client adapters—and uses the AES-CCM encryption mode (Advanced Encryption Standard-Counter Mode).

## Authentication

Authentication ensures users are who they say they are, and occurs when users attempt to join the wireless network and periodically thereafter. The following authentication methods are available with the Wi-Fi Array:

- **RADIUS 802.1x**  
802.1x uses a remote RADIUS server to authenticate large numbers of clients, and can handle different authentication methods (EAP-TLS, EAP-TTLS, EAP-PEAP, and EAP-LEAP Passthrough). Administrators may

also be authenticated via RADIUS when preferred, or to meet particular security standards.

- **Xirrus Internal RADIUS server**  
Recommended for smaller numbers of users (about 100 or less). Supports EAP-PEAP only
- **Pre-Shared Key**  
Uses a pass-phrase or key that is manually distributed to all authorized users. The same passphrase is given to client devices and entered into each Array.
- **MAC Access Control Lists (ACLs)**  
MAC access control lists provide a list of client adapter MAC addresses that are allowed or denied access to the wireless network, and can be used in addition to any of the above authentication methods. ACLs are good for embedded devices, like printers and bar-code scanners (though MAC addresses can be spoofed). The Array supports 1,000 ACL entries.

### Meeting PCI DSS Standards

The Payment Card Industry (PCI) Data Security Standard (DSS) was developed by major credit card companies. It lays out a set of requirements that must be met in order to provide adequate security for sensitive data. The Wi-Fi Array may be configured to satisfy PCI DSS standards. For details, please see [Appendix D: Implementing PCI DSS](#). Note that the license installed on the Array must include the [Xirrus Advanced RF Security Manager \(RSM\)](#) to support PCI audit compliance enforcement. Please see “About Licensing and Upgrades” on page 325.

### Meeting FIPS Standards

The Federal Information Processing Standard (FIPS) Publication 140-2 establishes a computer security standard used to accredit cryptographic modules. The standard is a joint effort by the U.S. and Canadian governments. To implement Level 2 security requirements of FIPS Level 2 on the Wi-Fi Array, see [Appendix E: Implementing FIPS Security](#).



*See Also*

Failover Planning

Network Management Planning

Power Planning

### Port Requirements

A number of ports are used by various Array features and by the Xirrus Management System (XMS). The [Port Requirements table on page 87](#) lists ports and the features that require them (XMS port requirements are included in the table for your convenience). If you are using a feature, please make sure that the ports that it requires are not blocked by firewalls or other policies, and that they do not conflict with any other port assignments.

As an example, XMS port requirements are illustrated in [Figure 31](#). XMS requires ports 161, 162, and 443 to be passed between Arrays and the XMS server. Similarly, ports 9090 and 9091 are required for communication between the XMS server and XMS clients, and port 25 is typically used by the XMS server to access an SMTP server to send email notifications.

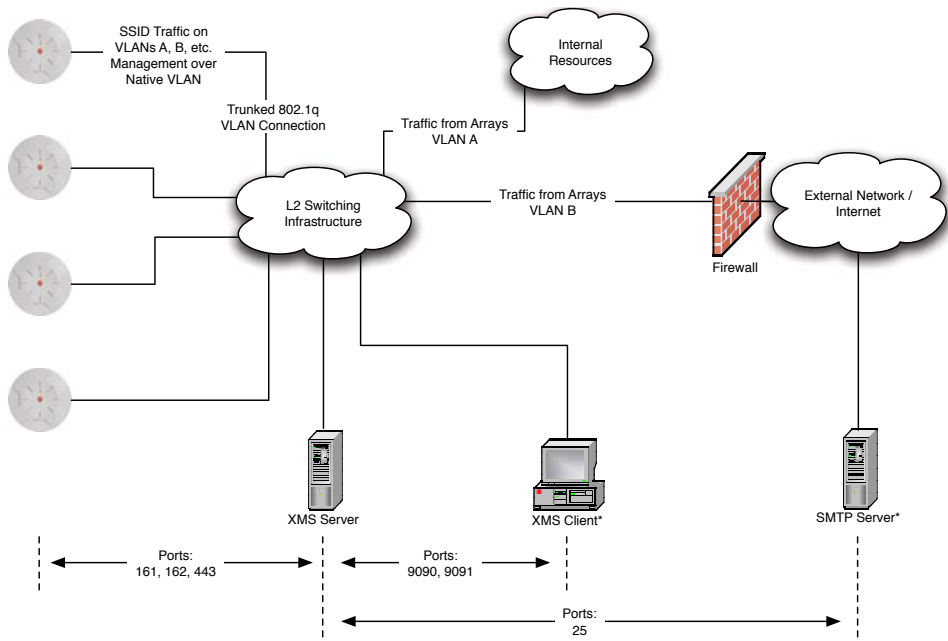

\* XMS Client and SMTP Server may be internal or external resources.

Figure 31. Port Requirements for XMS

The following table lists port requirements for the Array and for XMS, how they are used, and whether they may be changed.

Port	Application	Peer	Configurable
<b>Array</b>			
20 tcp 21 udp	FTP	Client	Yes
22 tcp	SSH	Client	Yes
23 tcp	Telnet	Client	Yes
25 tcp	SMTP	Mail Server	No
69 tcp	TFTP	TFTP Server	No
161 tcp/udp	SNMP	XMS Server	No
162 tcp/udp	SNMP Traphost Note - Up to four Traphosts may be configured.	XMS Server	Yes - but required by XMS
443 tcp	HTTPS (WMI,WPR)	Client	Yes
514 udp	Syslog	Syslog Server	No
1812, 1645 udp	RADIUS (some servers use 1645)	RADIUS Server	Yes
1813, 1646 udp	RADIUS Accounting (some servers still use 1646)	RADIUS Accounting Server	Yes
2055 udp	Netflow	Client	Yes
5000 tcp	Virtual Tunnel	VTUN Server	Yes

Port	Application	Peer	Configurable
<b>XMS</b>			
25 tcp	SMTP	Mail Server	Yes
161 udp	SNMP	Arrays	No
162 udp	SNMP Traphost 1	Arrays	Via XMS config file
443 tcp	HTTPS	Arrays	No
514 udp	Resident Syslog server	Internal*	Via XMS config file
1099 tcp	RMI Registry	Internal*	No
2000 tcp	XMS Back-end Server	Internal*	No
3306 tcp	MySQL Database	Internal*	No
8001 tcp	Status Viewer	Internal*	No
8007 tcp	Tomcat Shutdown	Internal*	During installation
8009 tcp	Web Container	Internal*	During installation
9090 tcp	XMS Webserver	XMS client	During installation
9091 tcp	XMS Client Server	XMS client	Via XMS config file
* Internal to XMS Server, no ports need to be unblocked on other network devices			

*See Also*

Management Control

External Radius

Services

VLAN Management

## Network Management Planning

Network management can be performed using any of the following methods:

- Command Line Interface, using an SSH (Secure Shell) utility, like PuTTY. The utility **must** be set up to use SSH-2, since the Array will only allow SSH-2 connections.
- Web-based management, using the Array's embedded Web Management Interface (WMI). This method provides configuration and basic monitoring tools, and is good for small deployments (one or two units).
- Centralized Web-based management, using the optional Xirrus Management System (XMS), which can be run on a dedicated Xirrus appliance (XM-3300) or your own server. The XMS is used for managing large Wi-Fi Array deployments from a centralized Web-based interface and offers the following features:
  - ◆ Globally manage large numbers of Arrays (up to 500)
  - ◆ Seamless view of the entire wireless network
  - ◆ Easily configure large numbers of Arrays
  - ◆ Rogue AP monitoring
  - ◆ Easily manage system-wide firmware updates
  - ◆ Monitor performance and trends
  - ◆ Aggregation of alerts and alarms

### *See Also*

[Failover Planning](#)

[Power Planning](#)

[Security Planning](#)

## WDS Planning

WDS (Wireless Distribution System) creates wireless backhauls between arrays, allowing your wireless network to be expanded using multiple Arrays without the need for a wired backbone to link them (see [Figure 32](#)). WDS features include:

- One to three IAPs may be used to form a single WDS link, yielding up to 900 Mbps bandwidth per link (up to 162 Mbps for XS model Arrays). Up to three different WDS links may be created on a single Array.
- Automatic IAP Load Balancing
- If desired, you may allow clients to associate to a BSS on the same radio interface used for a WDS Host Link. This will take bandwidth from the WDS link.

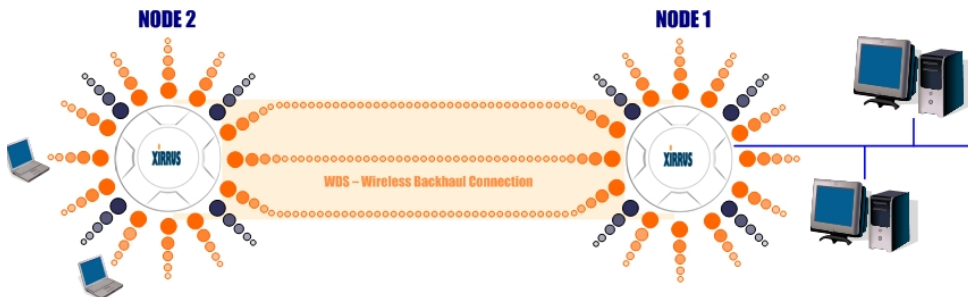

Figure 32. WDS Link

- Multiple links per Array allow you to configure multi-hop connections.

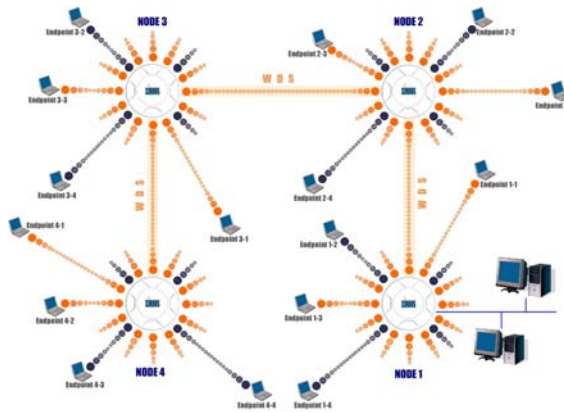

Figure 33. A Multiple Hop WDS Connection

- Multiple WDS links can provide link redundancy (failover capability - see Figure 34). A network protocol (Spanning Tree Protocol—STP) prevents Arrays from forming network loops.

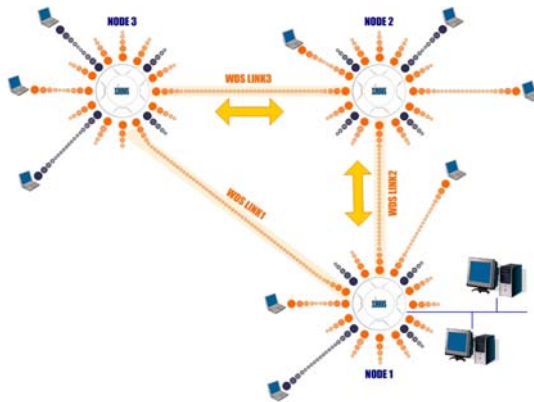

Figure 34. WDS Failover Protection

WDS links have a Host/Client relationship similar to the usual IAP/station pattern for Arrays:

- A *WDS Client Link* associates/authenticates to a host (target) Array in the same way that a station associates to an IAP. The client side of the link must be configured with the root MAC address of the target (host) Array.
- A *WDS Host Link* acts like an IAP by allowing one WDS Client Link to associate to it. An Array may have both client and host links.

WDS configuration is performed only on the client-side Array. See “WDS” on [page 305](#). Note that both Arrays must be configured with the same SSID name.



## Common Deployment Options

The following table lists some typical and recommended deployment options for a number of the features that have been discussed in this chapter.

Function	Number of Wi-Fi Arrays	
	One or Two	Three or More
Power	AC (some Array models) Power over Gigabit Ethernet	AC (some Array models) Power over Gigabit Ethernet UPS backup (recommended)
Failover	Recommended	Highly recommended
VLANs	Optional	Optional use, Can be used to put all APs on one VLAN or map to existing VLAN scheme
Encryption	WPA2 with AES (recommended) PSK or 802.1x	WPA2 with AES (recommended) 802.1x keying
Authentication	Internal RADIUS server EAP-PEAP Pre-Shared Key	External RADIUS server
Management	Internal WMI Internal CLI (via SSHv2)	XMS (SNMP)

### *See Also*

Coverage and Capacity Planning

Deployment Examples

Network Management Planning

Planning Your Installation

Power Planning

Security Planning

## Installation Workflow

This workflow illustrates the steps that are required to install and configure your Wi-Fi Array successfully. Review this flowchart before attempting to install the unit on a customer's network.

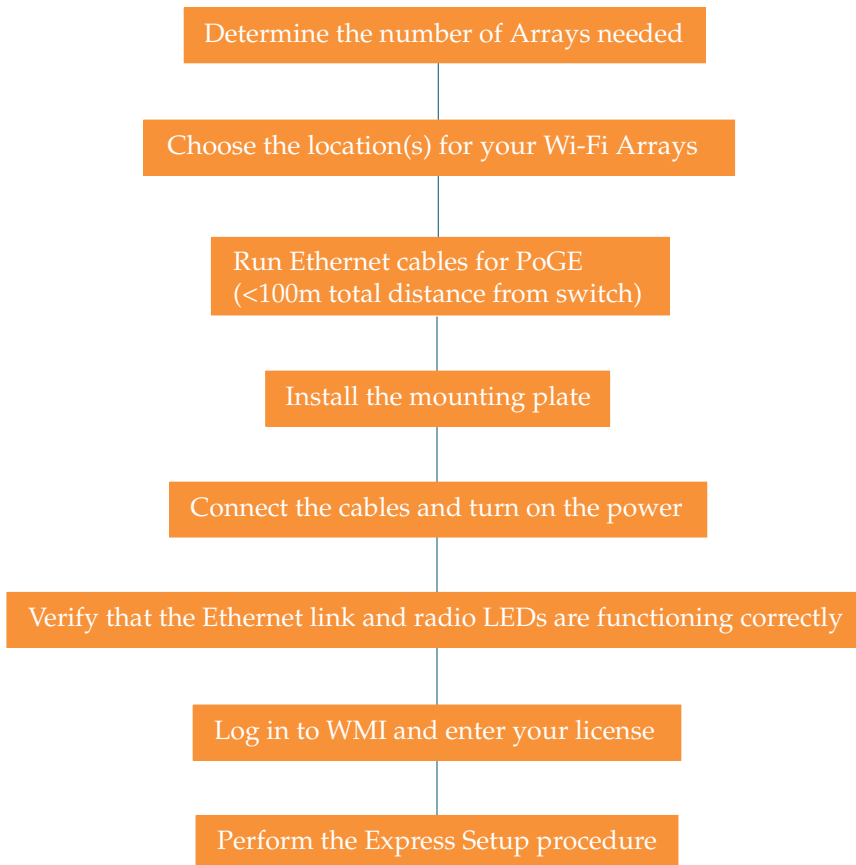

Figure 35. Installation Workflow

### *See Also*

Coverage and Capacity Planning  
Deployment Examples

Common Deployment Options

Failover Planning

Installation Prerequisites

Planning Your Installation

Power Planning

Wi-Fi Array Product Overview

Product Specifications—XN16, XN12, and XN8

Product Specifications—XS16 and XS8

Product Specifications—XS4

Security Planning

## Installing Your Wi-Fi Array

This section provides instructions for completing a physical installation of your Xirrus Wi-Fi Array.

### Choosing a Location

Based on coverage, capacity and deployment examples previously discussed, choose a location for the Array that will provide the best results for your needs. The Wi-Fi Array was designed to be mounted on a ceiling where the unit is unobtrusive and wireless transmissions can travel unimpeded throughout open plan areas.

You also have the option of mounting the Array on a wall, using the optional wall mount assembly kit.

Choose a location that is central to your users (see the following diagram for correct placement).

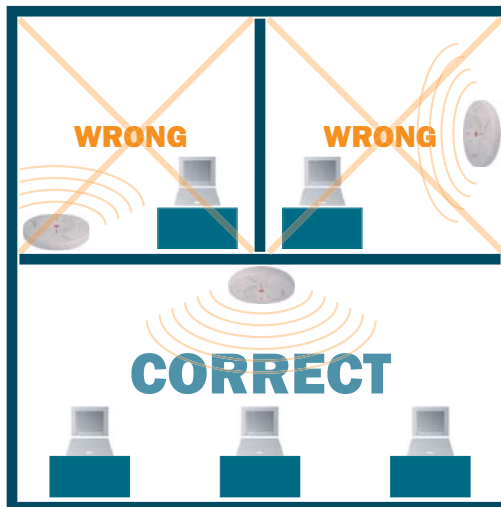

Figure 36. Array Placement

## Wiring Considerations

If you are using the Xirrus Power over Gigabit Ethernet modules (PoGE) to distribute power, see “Power over Gigabit Ethernet (PoGE)” on page 14. If you prefer to use AC power and you have an Array that supports AC, an AC power outlet must be available to the Array.

Once you have determined the best location for your Wi-Fi Array, you must run cables to the location for the following services:

### Power

One of the following options:

- No power cable to the Array is required if using PoGE modules. The PoGE module requires a dedicated AC power outlet (100 - 240 VAC).
- Dedicated AC power if PoGE is not in use. A UL-approved cord is shipped with all AC-equipped Arrays. You must use a UL-approved cord if using AC power.

### Network

- Gigabit 1—If using PoGE modules, the total of all Cat 5e or Cat 6 cable segments from the Gigabit Ethernet switch to the Array must be less than 100m long. The Array must be connected to PoGE networks without routing cabling to the outside plant, to ensure that cabling is not exposed to lightning strikes or possible high voltage crossover.
- Gigabit 2 (optional, not available on the four-port Arrays)
- Fast Ethernet (optional, not available on the four-port Arrays)
- Serial cable (optional) — cable lengths up to 25’ per the RS-232 specification.

### ***Important Notes About Network Connections***

Read the following notes before making any network connections.



*When the unit's IP address is unknown or a network connection has not been established, the serial cable is used for connecting directly with the Command Line Interface (CLI) via HyperTerminal. When a network connection is established, the Array can be managed from any of the available network connections, either Fast Ethernet, Gigabit 1 or Gigabit 2.*



*The Array's Ethernet ports should be plugged into an Ethernet switch, not an Ethernet hub—if a hub is used, we recommend that you connect only one Ethernet port.*



*The Gigabit1 Ethernet interface is the primary port for both data and management traffic. If a single Ethernet connection is used, it must be connected to the Gigabit1 Ethernet interface. See also, "Port Failover Protection" on page 80.*

*The 10/100 Ethernet Port may be used for managing the Array out of band from the Gigabit Ethernet ports. The 10/100 port will route only management traffic, using a static route that may be configured for this interface. See "interface" on page 370.*

#### ***See Also***

Failover Planning  
Installation Prerequisites  
Installation Workflow  
Mounting the Array  
Power over Gigabit Ethernet (PoGE)

---

## Mounting the Array

A number of options are available for mounting Arrays:

- Ceiling mount
- Wall mount
- Secure mount in a locking indoor enclosure
- Outdoor enclosure
- I-Beam mount in a protective enclosure (gymnasium mount)
- Factory enclosure

A detailed Quick Installation Guide is provided with the mounting option that you selected when ordering your Array. Please follow the provided instructions carefully.

## Dismounting the Array

### *To dismount any other Array model*

For all Array models other than the XS-3700/3900, push up on the Array (i.e., push it against the mounting plate). Then turn the Array to the left to remove it. This is similar to dismounting a smoke detector.

## Powering Up the Wi-Fi Array

When powering up, the Array follows a specific sequence of LED patterns showing the boot progress, and following a successful boot will provide extensive status information.

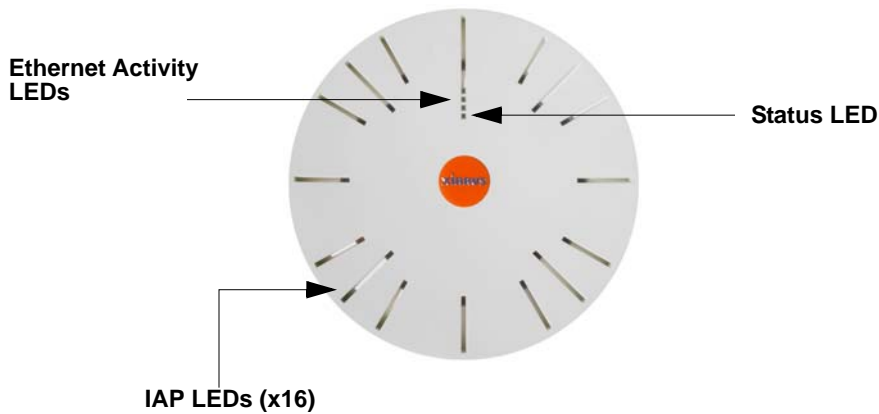

Figure 37. LED Locations (XN16)

Array LED settings may be altered or disabled entirely for diagnostic purposes or for personal preference. Changes are made via the Array's Command Line Interface or the Web Management Interface—refer to “LED Settings” on page 303.



## Array LED Operating Sequences

Use the following tables to review the operating sequences of the Array's LEDs.

- "LED Boot Sequence" on page 101
- "LED Operation when Array is Running" on page 102

### LED Boot Sequence

The normal boot LED sequence is as follows:

Array Activity	Status LED	IAP LEDs
<b>Power ON</b>	Blinking GREEN	All OFF
<b>Boot loader power ON self-test</b>	Blinking GREEN	All ON
<b>Image load from compact FLASH</b>	Blinking GREEN	Spinning pattern (rotate all to ON, then all to OFF)
<b>Image load failure</b>	Blinking ORANGE	All OFF
<b>Hand off to ArrayOS</b>	Solid GREEN	All OFF
<b>System software initialization</b>	Solid GREEN	Walking pattern—(LED rotating one position per second)
<b>Up and running</b>	Solid GREEN	ON for IAPs that are up: OFF for IAPs that are down. Behavior may be changed using "LED Settings" on page 303.

### LED Operation when Array is Running

The normal LED operation when the Array is running is shown in the table below. Note that behavior may be modified using “LED Settings” on page 303 or via the CLI.

LED Status	Reason
<b>IAP LED is OFF</b>	IAP is down
<b>IAP LED is solid ON</b>	IAP is up, but no associations and no traffic
<b>IAP LED heartbeat</b>	IAP is up, with stations associated but no traffic
<b>IAP LED flashing</b> Flashing at 10 Hz Flashing at 5 Hz Flashing at 2.5 Hz	IAP is up, passing traffic Traffic > 1500 packets/sec Traffic > 150 packets/sec Traffic > 1 packet/sec
<b>IAP LED is GREEN</b>	IAP is operating in the 2.4 GHz band
<b>IAP LED is ORANGE</b>	IAP is operating in the 5 GHz band
<b>IAP LED flashing ORANGE to GREEN at 1 Hz</b>	IAP <b>abg(n)2</b> is in monitor mode (standard intrude detect)
Ethernet LEDs are dual color <b>Ethernet LED is ORANGE</b> <b>Ethernet LED is GREEN</b>	Transferring data at 1 Gbps Transferring data at 10/100 Mbps

#### See Also

[Installation Prerequisites](#)  
[Installation Workflow](#)  
[Installing Your Wi-Fi Array](#)  
[LED Settings](#)

## Establishing Communication with the Array

The Array can be configured through the Command Line Interface (CLI) or the graphical Web Management Interface (WMI). You can use the CLI via the serial management port, the Fast Ethernet port, or either of the Gigabit Ethernet ports. You can use the WMI via any of the Array's Ethernet ports.

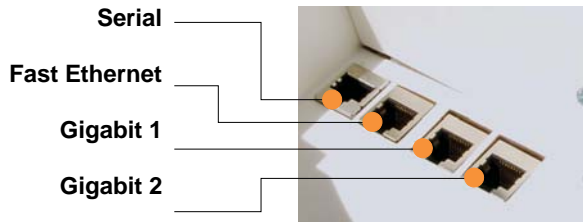

Figure 38. Network Interface Ports

### Using the Serial Port

If using the serial port to make your connection, use serial settings of 8 bits, no parity, no flow control, 1 stop bit (8N1) and a speed setting of 115200 baud. Use the communication package of your choice.

### Using the Ethernet Ports

By default, the Array's Ethernet interfaces use DHCP to obtain an IP address. If the Array is booted and does not receive DHCP addresses on either the Fast Ethernet or Gigabit Ethernet ports, the Fast Ethernet port will default to an IP address of 10.0.1.1 and both Gigabit Ethernet ports will default to 10.0.2.1. If the Array is connected to a network that provides DHCP addresses, the IP address can be determined by the following two methods:

1. Examine the DHCP tables on the server and find the addresses assigned to the Array (Xirrus MAC addresses begin with 000F7D).
2. Query the Array using the CLI via the serial port. Use the **show ethernet** command to view the IP addresses assigned to each port.

## Logging In

When logging in to the Array, use the default user name and password—the default user name is **admin**, and the default password is **admin**.

### *See Also*

Installation Workflow

Performing the Express Setup Procedure

Powering Up the Wi-Fi Array

## Entering the License

A license is needed to operate the Wi-Fi Array at full functionality. Without a license, the Array may only be powered up and have a basic network configuration.

The Array's license determines many of the features that are available on the Array. For example, automatic cell sizing and channel allocation require a license supporting the RF Performance Manager (RPM). Also, IEEE 802.11n operation on XR and XN model Arrays requires a license.

The Array's license is not installed at the factory. **You must enter your license before proceeding to the next step, [Performing the Express Setup Procedure](#).**

The procedure below describes entering the license key using the WMI. If you are using the Xirrus Management System (XMS), you may use it to easily manage and upgrade large numbers of licenses for the wireless network.

1. This procedure assumes that you have pointed a browser to the Array's IP address to start WMI, and that you have logged in with the default username and password above.
2. In the left hand frame, in the **Tools** section, click **System Tools**.
3. **License Key:** Enter the key that was provided for the Array. The key was provided to you in an email as an attachment in the form of an Excel file (.xls). Enter the key exactly as it appears in the file. Click the **Upgrade** button to apply the key.

4. Now you may verify the features provided by the key. In the **Status** section of the left hand frame, click **Array** and then click **Information**. Check the items listed in the **License Features** row.



*If you are installing a large number of licenses and do not have XMS, a Xirrus Licensing Tool may be acquired from Xirrus Support to help push licenses to large number of Arrays.*

## Performing the Express Setup Procedure

The Express Setup procedure establishes global configuration settings that enable basic Array functionality. Changes made in this window will affect all radios.

### XN8 Wi-Fi Array

<b>Status</b>		<b>Name: Bruces-XN8-Array</b>	
▶ Array	Host Name:	Bruces	
▶ Network	Location Information:	SE Co	
▶ RF Monitor	Admin Contact:	J Smith	
▶ Stations	Admin Email:	jsmith@	
▶ Statistics	Admin Phone:	805-55	
System Log	<b>SNMPv2 Settings</b>		
<b>Configuration</b>		Enable SNMPv2:	<input checked="" type="radio"/> Yes
Express Setup	Read-Only Community String:	●●●●●	
▶ Network	Read-Write Community String:	●●●●●	
▶ Services	<b>10/100 Ethernet Settings</b>		
▶ VLANs	Enable Interface:	<input checked="" type="radio"/> Yes	
▶ Security	Allow Management On Interface:	<input checked="" type="radio"/> Yes	
▶ SSIDs	Configuration Server Protocol:	<input checked="" type="radio"/> DHCP	
▶ Groups	IP Address:	10.0.1.1	
▶ IAPs	IP Subnet Mask:	255.255	
▶ WDS	Default Gateway:	255.255	
▶ Filters	<b>Gigabit Ethernet 1 Settings</b>		
▶ Clusters			

Figure 39. Express Setup

## Procedure for Performing an Express Setup

1. **Host Name:** Specify a unique **host name** for this Array. The host name is used to identify the Array on the network. Use a name that will be meaningful within your network environment, up to 64 alphanumeric characters. The default is **Xirrus-WiFi-Array**.
2. **Location Information:** Enter a brief but meaningful description that accurately defines the physical location of the Array. In an environment where multiple units are installed, clear definitions for their locations are important if you want to identify a specific unit.
3. **Admin Contact:** Enter the name and contact information of the person who is responsible for administering the Array at the designated location.
4. **Admin Email:** Enter the email address of the admin contact you entered in Step 3.
5. **Admin Phone:** Enter the telephone number of the admin contact you entered in Step 3.
6. **Configure SNMPv2:** Select whether to **Enable** SNMPv2 on the Array, and change the **SNMP Community Strings** if desired. If you are using the Xirrus Management System (XMS), these strings must match the values used by XMS. The default values for the Array match the defaults in XMS. For more details, including SNMPv3, see “SNMP” on page 199.
7. **Configure the Fast Ethernet (10/100 Megabit), Gigabit 1 and Gigabit 2 network interfaces.** The fields for each of these interfaces are the same, and include:
  - a. **Enable Interface:** Choose **Yes** to enable this network interface, or choose **No** to disable the interface.
  - b. **Allow Management on Interface:** Choose **Yes** to allow management of the Array via this network interface, or choose **No** to deny all management privileges for this interface.
  - c. **Configuration Server Protocol:** Choose **DHCP** to instruct the Array to use **DHCP** to assign IP addresses to the Array’s Ethernet interfaces,

or choose **Static** if you intend to enter IP addresses manually. If you choose the Static IP option, you must enter the following information:

- **IP Address:** Enter a valid IP address for this Array. To use any of the remote connections (Web, [SNMP](#), or [SSH](#)), a valid IP address must be used.
- **IP Subnet Mask:** Enter a valid IP address for the [subnet mask](#) (the default is 255.255.255.0). The subnet mask defines the number of IP addresses that are available on the routed subnet where the Array is located.
- **Default Gateway:** Enter a valid IP address for the [default gateway](#). This is the IP address of the router that the Array uses to forward data to other networks.

8. **SSID Settings:** This section specifies the wireless network name and security settings.

- a. **SSID (Wireless Network Name):** The SSID (Service Set Identifier) is a unique name that identifies a wireless network. All devices attempting to connect to a specific WLAN must use the same SSID. The default for this field is “**xirrus**.”

For additional information about SSIDs, go to the [Multiple SSIDs](#) section of “[Frequently Asked Questions](#)” on page 432.

- b. **Wireless Security:** Select the desired wireless security scheme (Open, [WEP](#), [WPA](#), [WPA2](#), or WPA-Both). WPA2 is recommended for the best Wi-Fi security.

- **Open**—This option offers no data encryption and is not recommended, though you might choose this option if clients are required to use a VPN connection through a secure SSH utility, like PuTTY.
- **WEP (Wired Equivalent Privacy)**—An optional IEEE 802.11 function that offers frame transmission privacy similar to a wired network. WEP generates secret shared encryption keys that both source and destination stations can use to alter frame bits to avoid disclosure to eavesdroppers.



- **WPA** (Wi-Fi Protected Access)—A Wi-Fi Alliance standard that contains a subset of the IEEE 802.11i standard, using TKIP or AES as an encryption method and 802.1x for authentication.
- **WPA2** (Wi-Fi Protected Access 2)—WPA2 is the follow-on security method to WPA for wireless networks and provides stronger data protection and network access control. It offers Enterprise and consumer Wi-Fi users with a high level of assurance that only authorized users can access their wireless networks. Like WPA, WPA2 is designed to secure all versions of 802.11 devices, including 802.11a, 802.11b, 802.11g, and 802.11n, multi-band and multi-mode.
- **WPA-Both** (WPA and WPA2)—This option makes use of both WPA and WPA2.

For more information about security, including a full review of all security options and settings, go to [“Understanding Security” on page 210](#).

- c. **Wireless Key/Passphrase:** Depending on the wireless security scheme you selected, enter a unique WEP key or WPA passphrase.
  - d. **Confirm Key/Passphrase:** If you entered a WEP key or WPA passphrase, confirm it here.
9. **Admin Settings:** This section allows you to change the default password for the Array. Note that the Array also offers the option of authenticating administrators using a RADIUS server (see [“Admin Management” on page 215](#)).
  - a. **New Admin Password:** If desired, enter a new administration password for managing this Array. Choose a password that is not obvious, and one that you can remember. If you forget your password, you must reset the Array to its factory defaults so that the password is reset to **admin** (its default setting).
  - b. **Confirm Admin Password:** If you entered a new administration password, confirm the new password here.

- 10. Time and Date Settings:** This section specifies an optional time (NTP - Network Time Protocol) server or modifies the system time if you're not using a server.
- a. Time Zone:** Select your time zone from the choices available in the pull-down list.
  - b. Use Network Time Protocol:** Check this box if you want to use an NTP server to synchronize the Array's clock. This ensures that Syslog time-stamping is maintained across all units. Without an NTP server assigned (no universal clock), each Array will use its own internal clock and stamp times accordingly, which may result in discrepancies. If you check **Yes**, the NTP server fields are displayed. If you don't want to use an NTP server, leave this box unchecked (default) and set the system time on the Array manually.
  - c. NTP Primary Server:** If you are using NTP, enter the IP address or domain name of the NTP server.
  - d. NTP Secondary Server:** Enter the IP address or domain name of an optional secondary NTP server to be used in case the Array is unable to contact the primary server.
  - e. Set Time (hrs:min:sec):** If you are not using NTP, check this box if you want to adjust the current system time. When the box is checked, the time fields become active. Enter the revised time (hours, minutes, seconds, am/pm) in the corresponding fields. If you don't want to adjust the current time, this box should be left unchecked (default).
  - f. Set Date (month/day/year):** If you are not using NTP, check this box if you want to adjust the current system date. When the box is checked, the date fields become active. Enter the revised date (month, day and year) in the corresponding fields. If you don't want to adjust the current date, this box should be left unchecked (default).
  - g. Auto Adjust Daylight Savings:** If you are not using NTP, check this box if you want the system to adjust for daylight savings automatically, otherwise leave this box unchecked (default).

## 11. IAP Settings:

**Enable/Configure All IAPs:** Click on the **Execute** button to enable and auto configure all IAPs (a message displays the countdown time—in seconds—to complete the auto-configuration task). When an IAP is enabled, its LED is switched on. (Figure 40, see also “Array LED Operating Sequences” on page 101.)



Figure 40. LEDs are Switched On

12. Click on the **Apply** button to apply the new settings to this session
13. Click on the **Save** button to save your changes (otherwise your new settings will not take effect).

This ends the Express Setup procedure.

### *See Also*

[Establishing Communication with the Array](#)

[Installation Prerequisites](#)

[Installation Workflow](#)

[Logging In](#)

[Multiple SSIDs](#)

[Security](#)



---

# The Web Management Interface

This topic provides an overview of the Xirrus Wi-Fi Array's embedded Web Management Interface (WMI), used for establishing your network's configuration settings and wireless operating parameters. It also includes login instructions. The following topics are discussed:

- An Overview
- Structure of the WMI
- User Interface
- Logging In
- Applying Configuration Changes

## An Overview

The WMI is an easy-to-use graphical interface to your Wi-Fi Array. It allows you to configure the product to suit your individual requirements and ensure that the unit functions efficiently and effectively.

The screenshot displays the XIRRUS XN4 Wi-Fi Array WMI. At the top, it shows the device name 'XN04290910207 (10.100.47.12)' and location 'SS Desk'. The 'Status' section indicates an uptime of 6 days, 5 hours, and 23 minutes.

The main configuration area is divided into several sections:

- RADIUS Server Mode:** Radio buttons for 'Internal' and 'External'.
- WPA Settings:**
  - TKIP Enabled:** Radio buttons for 'Yes' (selected) and 'No'.
  - AES Enabled:** Radio buttons for 'Yes' (selected) and 'No'.
  - WPA Group Rekey Time (seconds):** A text input field with 'Never' selected via a radio button.
  - WPA Authentication:** Radio buttons for 'EAP' (selected) and 'PSK'.
  - WPA Preshared Key / Verify Key:** A text input field with radio buttons for 'ASCII' and 'Hexadecimal'.
- WEP Settings:**
  - Encryption Key 1 / Verify Key 1:** A text input field with radio buttons for 'ASCII' and 'Hexadecimal', and a dropdown for '40 bit (WEP-64)', '104 bit (WEP-128)', and '128 bit (WEP-128)'.
  - Encryption Key 2 / Verify Key 2:** Similar to Key 1.
  - Encryption Key 3 / Verify Key 3:** Similar to Key 1.
  - Encryption Key 4 / Verify Key 4:** Similar to Key 1.
  - Default Key:** A dropdown menu currently set to 'Key 1'.

The sidebar on the left includes sections for 'Configuration' (Express Setup, Network, Services, VLANs, Security), 'Global Settings' (External Radius, Internal Radius, Rogue Control List), 'Tools' (Help, System Tools, CLI, Options, Logout), and 'Log Messages' (Critical: 1, Warning: 1, Information: 789).

At the bottom left, there is a network diagram showing a central node connected to four peripheral nodes labeled AB02N4, AB02N1, AB02N3, and AB02N2.

At the bottom right, there are icons for help, search, and a question mark, along with the copyright notice: 'Copyright © 2005-2010 by Xirus, Inc'.

Figure 41. Web Management Interface

## Structure of the WMI

The content of the WMI is organized by function and hierarchy, shown in the following table. Click on any item below to jump to the referenced destination.

<b>Status Windows</b> <ul style="list-style-type: none"><li>Array Status Windows<ul style="list-style-type: none"><li>Array Summary</li><li>Array Information</li><li>Array Configuration</li><li>Admin History</li></ul></li><li>Network Status Windows<ul style="list-style-type: none"><li>Network Map</li><li>Spanning Tree Status</li><li>Routing Table</li><li>ARP Table</li><li>DHCP Leases</li><li>Connection Tracking/NAT</li><li>CDP Neighbors</li><li>Network Assurance</li></ul></li><li>RF Monitor Windows<ul style="list-style-type: none"><li>IAPs</li><li>Spectrum Analyzer</li><li>Intrusion Detection</li></ul></li><li>Station Status Windows<ul style="list-style-type: none"><li>Stations</li><li>Location Map</li><li>RSSI</li><li>Signal-to-Noise Ratio (SNR)</li><li>Noise Floor</li><li>Max by IAP</li></ul></li></ul>	<b>Statistics Windows</b> <ul style="list-style-type: none"><li>IAP Statistics Summary</li><li>Per-IAP Statistics</li><li>Network Statistics</li><li>VLAN Statistics</li><li>WDS Statistics</li><li>Filter Statistics</li><li>Station Statistics</li><li>Per-Station Statistics</li></ul> <b>System Log Window</b>
---	---

<b>Configuration Windows</b> <ul style="list-style-type: none"><li>Express Setup</li><li>Network<ul style="list-style-type: none"><li>Network Interfaces</li><li>DNS Settings</li><li>CDP Settings</li></ul></li><li>Services<ul style="list-style-type: none"><li>Time Settings (NTP)</li><li>NetFlow</li><li>Wi-Fi Tag</li><li>System Log</li><li>SNMP</li><li>DHCP Server</li></ul></li><li>VLANs<ul style="list-style-type: none"><li>VLAN Management</li></ul></li><li>Security<ul style="list-style-type: none"><li>Admin Management</li><li>Admin Privileges</li><li>Admin RADIUS</li><li>Management Control</li><li>Access Control List</li><li>Global Settings</li><li>External Radius</li><li>Internal Radius</li><li>Rogue Control List</li></ul></li><li>SSIDs<ul style="list-style-type: none"><li>SSID Management</li><li>Active IAPs</li></ul></li><li>Groups<ul style="list-style-type: none"><li>Group Management</li></ul></li></ul>	<b>Configuration Windows (cont'd)</b> <ul style="list-style-type: none"><li>IAPs<ul style="list-style-type: none"><li>IAP Settings</li><li>Global Settings (IAP)</li><li>Global Settings .11a</li><li>Global Settings .11b</li><li>Global Settings .11n</li><li>Advanced RF Settings</li><li>LED Settings</li></ul></li><li>WDS<ul style="list-style-type: none"><li>WDS Client Links</li></ul></li><li>Filters<ul style="list-style-type: none"><li>Filter Lists</li><li>Filter Management</li></ul></li><li>Clusters<ul style="list-style-type: none"><li>Cluster Definition</li><li>Cluster Management</li><li>Cluster Operation</li></ul></li><li><b>Tool Windows</b><ul style="list-style-type: none"><li>System Tools</li><li>CLI</li><li>Options</li><li>Logout</li></ul></li></ul>
--	--





The left frame contains three main elements:

- Configuration menu organized by function (for example, radio interfaces, security, etc.). Click the heading to display a summary of its current configuration, as well as an associated pull-down menu.
- Three **Log Messages** counters are located at the bottom of the menu. They provide a running total of messages generated by the ArrayOS Syslog subsystem during your session—organized into **Critical**, **Warning**, and **General** messages. Click on a counter to display the associated Syslog messages. Messages at the selected level or higher will be shown. For more information, please see “[System Log Window](#)” on page 168.
- The Array representation contains shortcut links. Click a radio to view statistics for it. Click the center of the Array to display the [IAP Settings](#) window, which allows you to configure the Array’s radios.

The right frame displays the status information or configuration parameters for the Wi-Fi Array. This is where you review the Array’s current status and activity or input data (if you want to make changes). The green Array information bar at the top of the frame describes the Array—the Name and IP address allow you to quickly confirm that WMI is connected to the correct Array. The current Uptime since the last reboot is also shown.



*Some settings are only available if the Array’s license includes appropriate Xirrus **Advanced Feature Sets**. If a setting is unavailable (grayed out), then your license does not support the feature. See “[About Licensing and Upgrades](#)” on page 325.*

Note that WMI provides options which allow you to change its appearance and behavior. You may change:

- **Style**—changes the colors and appearance of WMI (i.e., its “skin”).
- **Refresh Interval**—the refresh time when automatic refresh is selected.
- **Close menu section when deselected**—changes the behavior of the menu in the left frame.
- **Clear screen when loading new page.**

See “[Options](#)” on page 337 for more information.

## Utility Buttons

At the bottom of each window you will find a set of useful buttons—a **Feedback** button, a **Print** button and a **Help** button.

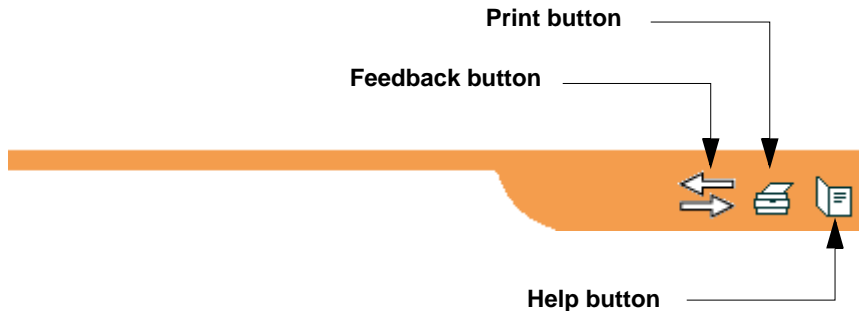

Figure 43. WMI: Utility Buttons

- Click on the **Feedback** button to generate a Web page that allows you to submit your comments to Xirrus, Inc. You can also access the feedback page at <http://www.xirrus.com/public/feedback/>. Refer to [Figure 44](#) on [page 120](#) to see a sample of the feedback form.
- Click on the **Print** button to send a print file of the active window to your local printer.
- Click on the **Help** button to access the Array's online help system.

### *Submitting Your Comments*

When submitting comments via the Feedback button ([Figure 44](#)), ensure that you provide as much detail as possible, including your contact information, the product model number that the comment relates to, and the ArrayOS software version (if known). When finished, click on the **Submit** button to submit your comment.

Products Deployments Design Guides Support Events About Us [Request a Site Survey](#)  
1.800.947.7871

### Feedback

Customer Information

First Name:*	<input type="text"/>	Company:	<input type="text"/>
Last Name:*	<input type="text"/>	Address:	<input type="text"/>
Title:	<input type="text"/>	City:	<input type="text"/>
Phone:	<input type="text"/>	State/Province:	<input type="text"/>
Mobile Phone:	<input type="text"/>	Zip/Postal Code:	<input type="text"/>
Email:*	<input type="text"/>	County:	<input type="text"/>
Company:	<input type="text"/>	Region:	<input type="text" value="-Select One-"/>
URL:	<input type="text"/>		
Model Number:	<input type="text" value="Select One"/>	System Software version (if known):	<input type="text"/>

Please enter your Feedback or suggestions:

Please have someone contact me

- [Wi-Fi Products](#)
- [Applications](#)
- [Strengths](#)
- [Case Studies](#)
- [Library](#)
- [Contact Us](#)

Figure 44. Feedback Form

## Logging In

Use this procedure to log in to the WMI via your Web browser.

1. Establish a network connection and open your Web browser.
2. Connect to the Wi-Fi Array via its default IP address (10.0.2.1 for both Gigabit 1 and Gigabit 2 Ethernet ports) or via a DHCP assigned IP address.
3. To log in to the Array's Web Management Interface, enter **admin** when prompted for a user name and password.

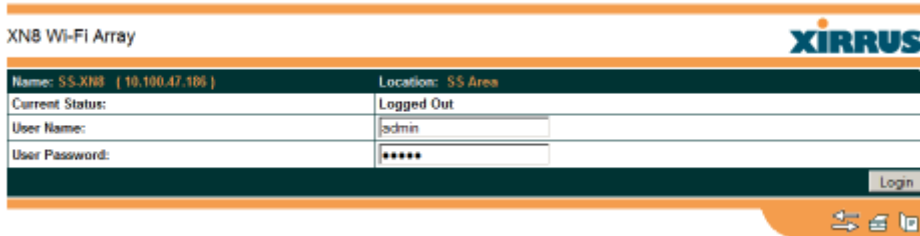

Figure 45. Logging In to the Wi-Fi Array

## Applying Configuration Changes

When you have defined all your settings in any WMI configuration window, you must click on the **Apply** button for the changes to take effect in the current session, or click on the **Save** button to apply changes to this session and write your changes, so they will be preserved after a reboot.

### Character Restrictions

When inputting strings in the WMI (for example, assigning SSIDs, host name, password, etc.), use common alphanumeric characters. Some of the fields in the WMI will not accept special characters, so use of the following characters should typically be avoided:

&   <   >   '   "   /   \



# Viewing Status on the Wi-Fi Array

These windows provide status information and statistics for your Array using the product's embedded Web Management Interface (WMI). You cannot make [configuration changes](#) to your Array from these windows. The following topics have been organized into functional areas that reflect the [flow and content](#) of the Status section of the navigation tree in the left frame of the WMI.

- [“Array Status Windows” on page 123](#)
- [“Network Status Windows” on page 129](#)
- [“RF Monitor Windows” on page 139](#)
- [“Station Status Windows” on page 147](#)
- [“Statistics Windows” on page 160](#)
- [“System Log Window” on page 168](#)

Configuration and Tools windows are not discussed here. For information on these windows, please see:

- [“Configuring the Wi-Fi Array” on page 171](#)
- [“Using Tools on the Wi-Fi Array” on page 323](#)

## Array Status Windows

The following Array Status windows are available:

- **Array Summary**—displays information on the configuration of all Array interfaces, including IAPs.
- **Array Information**—provides version/serial number information for all Array components.
- **Array Configuration**—shows all configuration information for the Array in text format.
- **Admin History**—shows all current and past logins since the last reboot.

## Array Summary

This is a status only window that provides a snapshot of the global configuration settings for all Wi-Fi Array network interfaces and IAPs. You must go to the appropriate configuration window to make changes to any of the settings displayed here—[configuration changes](#) cannot be made from this window. Clicking on an interface or IAP will take you to the proper window for making configuration changes.

Status		Name: SS.XN8 (10.100.47.186)		Location: SS Area		Uptime: 0 days, 0 hours, 36 minutes				
<b>Ethernet Interfaces</b>										
Interface	Status	Link	Port Mode	DHCP	IP Address	Subnet Mask	Gateway			
10/100 Ethernet 0	Enabled	down		Disabled	10.100.47.21	255.255.255.0	10.100.47.1			
Gigabit Ethernet 1	Enabled	up	link-backup	Disabled	10.100.47.186	255.255.255.0	10.100.47.1			
Gigabit Ethernet 2	Enabled	down	link-backup	Disabled	10.100.47.186	255.255.255.0	10.100.47.1			
<b>Integrated Access Points</b>										
IAP	State	Channel	Antenna	Cell Size	TX Power	RX Threshold	Stations	WDS Link	MAC Address / BSSID	Description
abgn1	down	1	int-dir	max	20	-90	0		00:0f:7d:0b:b3:9d-91	
abgn2	up	monitor	int-omni	monitor	20	-95	0		00:0f:7d:0b:b3:b0-b1	
abgn3	down	11	int-dir	max	20	-90	0		00:0f:7d:0b:b3:d0-d1	
abgn4	up	6	int-dir	medium	12	-81	1		00:0f:7d:0b:b3:f0-f1	
an1	down	40	int-dir	medium	12	-81	0		00:0f:7d:0b:b3:a0-a1	
an2	down	56	int-dir	max	20	-90	0		00:0f:7d:0b:b3:c0-c1	
an3	down	48	int-dir	max	20	-90	0		00:0f:7d:0b:b3:e0-e1	
an4	down	64	int-dir	max	20	-90	0		00:0f:7d:0b:b3:80-81	

Figure 46. Array Summary

## Content of the Array Summary Window

The Array Summary window is sub-divided into the **Ethernet Interfaces** section and the **Integrated Access Points** (radio) section, providing you with the following information:

- **Ethernet Interfaces Section**

This section provides information about network interface devices. To make configuration changes to these devices, go to [“Network Interfaces”](#) on page 180.

- **Interface:** Lists the network interfaces that are available on the Array (10/100 Ethernet 0, Gigabit Ethernet 1 and Gigabit Ethernet 2).
- **Status:** Shows the current state of each interface, either enabled or disabled.



- **Link:** Shows whether the link on this interface is up or down.
- **DHCP:** Shows whether DHCP on this port is enabled or disabled.
- **IP Address:** Shows the current IP address assigned to each network interface device.
- **Subnet Mask:** Shows the subnet mask, which defines the number of IP addresses that are available on the routed subnet where the Array is located.
- **Gateway:** Shows the IP address of the router that the Array uses to transmit data to other networks.

• **Integrated Access Points Section**

This section provides information about the Integrated Access Points (IAPs) that are contained within the Array. How many IAPs are listed depends on which product model you are using (16 IAPs for the XN16 or XS16; 12 IAPs for the XN12; 8 IAPs for the XR 48xx or XN8 or XS8; and 4 IAPs for the XR 44xx or XN4 or XS4). To make configuration changes to these IAPs, go to “IAP Settings” on page 271.

- **IAP:** Lists the IAPs that are available on the Array.
- **State:** Shows the current state of each IAP, either up or down. IAPs that are down are shown in RED. Figure 47 shows an example where IAP a3 is down.

Integrated Access Points										
IAP	State	Channel	Antenna	Cell Size	TX Power	RX Threshold	Stations	WDS Link	MAC Address / BSSID	Description
abgn1	up	1	int-dir	max	20	-90	0		00:0f:7d:0b:b3:90-9f	
abgn2	up	monitor	int-omni	monitor	20	-95	0		00:0f:7d:0b:b3:b0-b1	
abgn3	down	11	int-dir	max	20	-90	0		00:0f:7d:0b:b3:d0-d1	
abgn4	up	6	int-dir	medium	12	-81	1		00:0f:7d:0b:b3:f0-f1	
an1	up	40	int-dir	medium	12	-81	0		00:0f:7d:0b:b3:a0-a1	
an2	up	56	int-dir	max	20	-90	0		00:0f:7d:0b:b3:c0-c1	
an3	up	48	int-dir	max	20	-90	0		00:0f:7d:0b:b3:e0-e1	
an4	down	64	int-dir	max	20	-90	0		00:0f:7d:0b:b3:80-81	

Figure 47. Disabled IAP (Partial View)

- **Channel:** Shows which channel each IAP is using, and the channel setting. To avoid co-channel interference, adjacent radios should not

be using adjacent channels. To make channel selections for a specific IAP, go to “IAP Settings” on page 271.

- **Antenna:** Shows which antenna is being used by each IAP.
- **Cell Size:** Indicates which cell size setting is currently active for each IAP—small, medium, large, max, automatic, or manually defined by you. The cell size of an IAP is a function of its transmit power and determines the IAP’s overall coverage. To define cell sizes, go to “IAP Settings” on page 271. For additional information about cell sizes and the importance of planning for and defining the optimum cell sizes for your Array, go to “Coverage and Capacity Planning” on page 62.

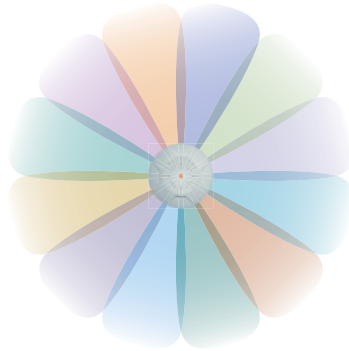

Figure 48. IAP Cells

- **Tx Power:** Shows the transmit power for each IAP.
- **Rx Threshold:** Shows the receive threshold for each IAP.
- **Stations:** Informs you how many client stations are currently associated with each IAP. XR and XN Arrays can handle up to 96 concurrent users per individual IAP, thus 16-port XN models can handle 1536 users per Array.
- **WDS Link:** The WDS Link on this radio (if any). See “WDS” on page 305.
- **MAC Address/BSSID:** Shows the MAC address for each IAP.
- **Description:** The description (if any) that you set for this IAP.

### Array Information

This is a status only window that shows you the current firmware versions utilized by the Array, serial numbers assigned to each module, MAC addresses, licensing information, recent boot timestamps, and current internal temperatures.

Note that the **License Features** row lists the features that are supported by your Array’s license. See “About Licensing and Upgrades” on page 325 and “Advanced Feature Sets” on page 20 for more information.

XN4 Wi-Fi Array		XIRRUS		
Status	Name: SS-XN0429091D207 (10.100.47.19)		Uptime: 0 days, 0 hours, 13 mins	
Array	Hardware Configuration			
Summary	Model	XN4, 512MB-ECC (825MHz)		
Information	Component	Part Number	Serial Number	Date
Configuration	Array	1B0-0035-001	XN0429091D207	2009-Jul-14 22:38
Admin History	Controller	100-0092-002.A	0000047117	2009-Jul-07 19:24
Network	IAP Module 1	100-0089-001.C	0000050577	2009-Jul-14 6:07
RF Monitor	IAP Module 2	100-0089-001.C	0000050570	2009-Jul-14 6:03
Stations	IAP Module 3	100-0089-001.C	0000050489	2009-Jul-14 7:12
Statistics	IAP Module 4	100-0089-001.C	0000050364	2009-Jul-13 19:07
System Log	FPGA Status	Boot Version	S/W Version	
Configuration	Switching Engine	2000-02 022	2000-02 028	
Express Setup	Queue Processing	2002-02 037	2002-02 047	
Network	Interface	MAC Address(es)		
Services	IAPs	00:0E:7d:14:cb:80-14:cb:bf		
VLANs	Gigabit 1	00:0f7d:00:b8:0d		
Security	Software Configuration			
SSIDs	Component	Version		
Groups	SCD Firmware	2.21 (Aug 27 2008), Build: 3157		
IAPs	Boot Loader	1.0.0 (Dec 17 2008), Build: 3090		
WDS	IAP Driver	1.5.0 (Dec 31 2009), Build: 2115		
Filters	System Software	4.0.7 (Dec 31 2009), Build: 1192		
Tools	License Key	0X4GF-PU3EV-8GGAF-MJJC7		
System Tools	License Features	Basic ArrayOS + Advanced RF Management + 802.11n		
CLI	Operating Status			
Logout	Time This Boot	Tue 2010-Jan-05 23:06:31 GMT		
Log Messages	Time Last Boot	Wed 2009-Dec-30 22:38:44 GMT		
Critical 1	Component	Temperature (C/F)		
Warning 1	Controller	32/89		
Information 13	IAP Module 1	34/93		
	IAP Module 2	29/84		
	IAP Module 3	31/87		
	IAP Module 4	37/98		

Figure 49. Array Information

You cannot make [configuration changes](#) in this window, but if you are experiencing issues with network services, you may want to print the content of this window for your records.

## Array Configuration

This is a status only window that allows you to display the configuration settings assigned to the Array, based on the following filter options:

- **Running**—displays the current configuration (the one running now).
- **Saved**—displays the saved configuration from this session.
- **Lastboot**—displays the configuration as it was after the last reboot.
- **Factory**—displays the configuration established at the factory.

The screenshot shows the 'XN8 Wi-Fi Array' configuration page. The left sidebar contains a navigation menu with categories like Summary, Information, Configuration, Admin History, Network, RF Monitor, Stations, Statistics, System Log, Express Setup, Services, VLANs, Security, SSIDs, Groups, IAPs, WDS, Filters, Tools, System Tools, CLI, and Logout. The main content area displays the configuration for 'Name: SS-XN8 (10.100.47.186)' and 'Location: SS Area' with an uptime of '0 days, 2 hours, 2 minutes'. The configuration is shown in a text-based format with a 'Select Config' dropdown set to 'Running' and a 'Select Diff' dropdown set to 'None'. The configuration output includes fields for hostname, location, contact information, hardware configuration, and a table of components.

```

!
configure
!
description
hostname SS-XN8
location "SS Area"
exit
!
contact-info
name "J Smith"
phone "805-555-1212"
email "jss@xyzcorp.com"
exit
!
array-info
! hardware-configuration
! =====
! model: XN8, 1.0GB (1.0GHz)
!
! component      part number      serial number     date
! -----
! array          180-0036-001     XN0839081AD18    2008-Sep-23 21:08
! controller    100-0030-012.G1  0000017991        2008-Sep-16  0:50
! iap module 1  100-0091-002.B2  0000022947        2008-Sep-16 11:00
! iap module 2  100-0091-002.B2  0000022933        2008-Sep-16 11:14
! iap module 3  100-0091-002.B2  0000022932        2008-Sep-16 12:37
! iap module 4  100-0091-002.B2  0000023089        2008-Sep-23  9:57
!
! fpga status      boot version      s/w version
! -----
    
```

Figure 50. Show Configuration

If you want to see just the differences between the Running, Saved, Lastboot, and Factory configurations, you can do this by choosing a configuration option from the **Select Config** pull-down menu then selecting an alternative configuration option from the **Select Diff** pull-down menu.

To also include the default configuration settings in the output, choose your configuration then click in the **Include Defaults** check box. If **Include Defaults** is disabled, then only the changes from the default configuration are shown.

## Admin History

It is useful to know who else is currently logged in to an array while you're configuring it. It's also nice to see who has logged in since the array booted. This status-only window shows you all administrator logins to the Array that have occurred since the last reboot. To determine who is currently logged in, check which entries say **active** in the **Logout Time** column.

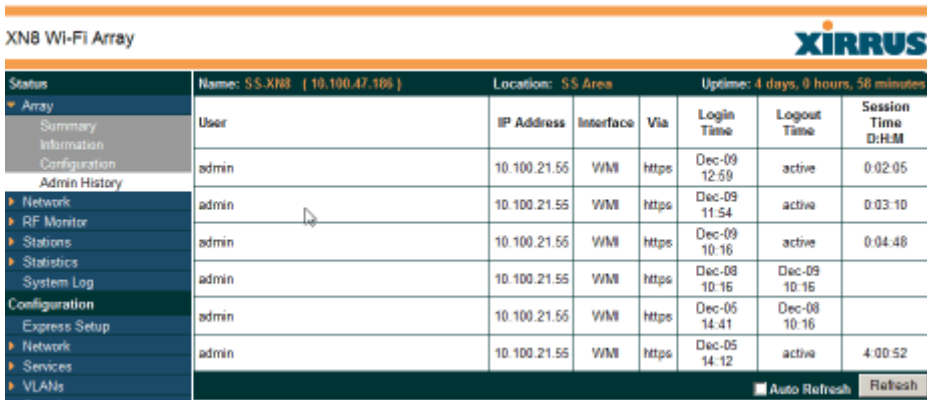

User	IP Address	Interface	Via	Login Time	Logout Time	Session Time D:H:M
admin	10.100.21.55	WIFI	https	Dec-09 12:59	active	0:02:05
admin	10.100.21.55	WIFI	https	Dec-09 11:54	active	0:03:10
admin	10.100.21.55	WIFI	https	Dec-09 10:16	active	0:04:48
admin	10.100.21.55	WIFI	https	Dec-08 10:16	Dec-09 10:16	
admin	10.100.21.55	WIFI	https	Dec-05 14:41	Dec-08 10:16	
admin	10.100.21.55	WIFI	https	Dec-05 14:12	active	4:00:52

Figure 51. Admin Login History

## Network Status Windows

The following Network Status windows are available:

- **Network**—displays a summary of network interface settings.
- **Network Map**—displays information about this Array and neighboring Arrays that have been detected.
- **Spanning Tree Status**—displays the spanning tree status of network links on this Array.
- **Routing Table**—displays information about routing on this Array.

- **ARP Table**—displays information about Address Resolution Protocol on this Array.
- **DHCP Leases**—displays information about IP addresses (leases) that the Array has allocated to client stations.
- **Connection Tracking/NAT**—lists connections that have been established for client stations.
- **CDP Neighbors**—lists neighboring network devices using Cisco Discovery Protocol.
- **Network Assurance**—shows results of connectivity tests for network servers.

## Network

This window provides a snapshot of the configuration settings currently established for Array’s wired interfaces. Depending on the model, this may include the 10/100 Ethernet 0 interface and the **Gigabit 1** and **Gigabit 2** interfaces. **DNS Settings** are summarized as well. You can click on any item in the **Interface** column to go to the associated configuration window.

XN4 WI-Fi Array															
Status		Name: XN0429091D207 ( 10.100.47.12 )				Location: SS Desk			Uptime: 25 days, 22 hours, 51 mins						
Array	Interface Settings Summary														
Network	Interface	State	Mgmt	Auto Neg	LED	Link	Duplex	Speed (Mbps)	MTU Size	Port Mode	DHCP	IP Address	Subnet Mask	Gateway	
RF Monitor	gig1	enabled	on	on	on	up	full	1000	1500		enabled	10.100.47.12	255.255.255.0	10.100.47.1	
Stations	DNS Settings Summary														
Statistics	Hostname			Domain			DNS Server 1			DNS Server 2			DNS Server 3		
System Log	XN0429091D207			xirus.com			10.100.1.10			10.100.2.10					
Configuration															

Figure 52. Network Settings

WMI windows that allow you to change or view configuration settings associated with the network interfaces include:

- **“Network Interfaces” on page 180**
- **“DNS Settings” on page 187**
- **“CDP Settings” on page 189**

## Network Map

This window offers detailed information about this Array and all neighboring Arrays, including how the Arrays have been set up within your network.

XN16 Wi-Fi Array

Status		Name: BrianXN16 ( 10.100.47.33 )		Uptime: 0 days, 0 hours, 29 mins	
<input type="checkbox"/> Hardware <input type="checkbox"/> License <input checked="" type="checkbox"/> Software <input type="checkbox"/> Firmware <input type="checkbox"/> IAP Info <input type="checkbox"/> Stations <input type="checkbox"/> Default <input type="checkbox"/> Auto Refresh <input type="button" value="Refresh"/>					
Array Name	IP Address	Location	Array OS		
Network Map	SS-XN0429091D207	10.100.47.16			
Spanning Tree Status	BrianXN16	10.100.47.33	XS-4.1.0-1269		
Routing Table	Adrians-XN8	10.100.47.12	Behind the hot water pipes, 3rd washroom on left		
ARP Table	XN0820091C8A6	10.100.46.151	XS-4.0.7-1195		
DHCP Leases	XN0823091CADC	10.100.46.66	XS-4.0.7-1192		
Connection Tracking	XN0803091BF2E	10.100.46.152	XS-4.0.7-1192		
CDP Neighbors	Sheyda-XN8	10.100.47.38	XS-4.0.7-1192		
Network Assurance	Sams-X-N-4	10.100.46.31	XS-4.0.7-1192		
RF Monitor	Bruces-XN8-Array	10.100.47.10	Desk		
Stations	Jose-XS16	10.100.46.223	XS-3.5-0724		
Statistics	Bruces-XS3900-Array	10.100.47.13	Office		
	adrians-3900	10.100.47.11	XS-3.5-0724		

Figure 53. Network Map

The Network Map has a number of options at the top of the page that allow you to customize your output by selecting from a variety of information that may be displayed. You may sort the rows based on any column that has an active column header, indicated when the mouse pointer changes to the hand icon . Click **Refresh** to update the information at any time. Click **Auto Refresh** to instruct the Array to refresh this window automatically.

### Content of the Network Map Window

By default, the network map shows the following status information for each Array:

- **Array Name:** The host name assigned to the Array. To establish the host name, go to “Express Setup” on page 173. You may click the host name to access WMI for this Array.
- **IP Address:** The Array’s IP address. You may click the address to access WMI for this Array. If DHCP is enabled, the Array’s IP address is assigned by the DHCP server. If DHCP is disabled, you must assign a

static IP address. To enable DHCP or to assign a static IP address for the Array, go to “Express Setup” on page 173.

- **Location:** The location assigned to the Array. To establish the location information, go to “Express Setup” on page 173.
- **Array OS:** The software version running on the Array.
- **IAP:** The number of IAPs on the Array.
- **(IAP) Up:** Informs you how many IAPs are currently up and running. To enable or disable all IAPs, go to “Express Setup” on page 173. To enable or disable individual IAPs, go to “IAP Settings” on page 271.
- **SSID:** Informs you how many SSIDs have been assigned for the Array. To assign an SSID, go to “SSID Management” on page 248.
- **(SSID) On:** Informs you how many SSIDs are enabled. To enable or disable SSIDs, go to “SSID Management” on page 248.
- **In Range:** Informs you whether the Array is within wireless range of another Wi-Fi Array.
- **Fast Roam:** Informs you whether or not the Xirrus fast roaming feature is enabled. This feature utilizes the Xirrus Roaming Protocol (XRP) ensuring fast and seamless roaming capabilities between IAPs or Arrays at both Layer 2 and Layer 3. To enable or disable fast roaming, go to “Global Settings (IAP)” on page 277.
- **Uptime (D:H:M):** Informs you how long the Array has been up and running (in Days, Hours and Minutes).

To see additional information, select from the following checkboxes at the bottom of the page. This will show the columns described below.

#### *Hardware*

- **Model:** The model number of each Array (XN16, XS4, etc.), plus the amount of RAM memory and the speed of the processor.
- **Serial:** Displays the serial number of each Array.

#### *License*

- **License Key:** The license key of each Array.



- **Licensed Features:** Lists the optional features enabled by the key, if any.

#### *Software (enabled by default)*

- Enable/disable display of the Array OS column.

#### *Firmware*

- **Boot Loader:** The software version number of the boot loader on each Array.
- **SCD Firmware:** The software version number of the SCD firmware on each Array.

#### *IAP Info (enabled by default)*

- Enable/disable display of the IAP/Up columns.

#### *Stations*

- **Stations:** Tells you how many stations are currently associated to each Array. To deauthenticate a station, go to [“Stations” on page 148](#).

The columns to the right (**H**, **D**, **W**, and **M**) show the highest number of stations that have been associated over various periods of time: the previous hour, day, week, and month.

#### *Default*

- Sets the columns displayed to the default settings. By default, only Software and IAP Info are selected.

### **Spanning Tree Status**

Multiple active paths between stations can cause loops in the network. If a loop exists in the network topology, the potential exists for the duplication of messages. The spanning tree protocol is a link management protocol that provides path redundancy while preventing undesirable loops. For a wireless network to function properly, only one active path can exist between two stations.

To facilitate path redundancy, the spanning tree protocol defines a tree that spans all stations in the network and forces certain redundant data paths into a standby (blocked) state. If one segment in the spanning tree becomes unreachable, the

spanning tree algorithm reconfigures the network topology and reestablishes the link by activating the standby path. The spanning tree function is transparent to client stations.

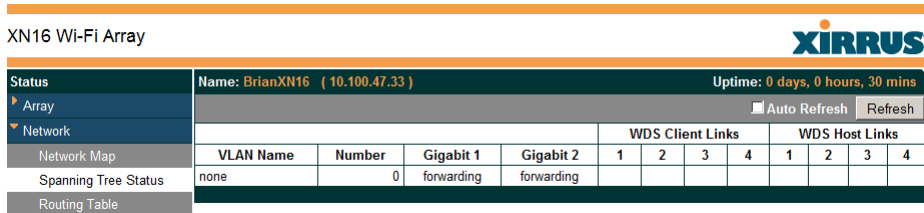

Status	Name: BrianXN16 ( 10.100.47.33 )		Uptime: 0 days, 0 hours, 30 mins									
	<input type="checkbox"/> Auto Refresh    Refresh											
Network					WDS Client Links				WDS Host Links			
Spanning Tree Status	VLAN Name	Number	Gigabit 1	Gigabit 2	1	2	3	4	1	2	3	4
Spanning Tree Status	none	0	forwarding	forwarding								

Figure 54. Spanning Tree Status

This window shows the spanning tree status (forwarding or blocked) for path segments that terminate on the gigabit ports and WDS links of this Array. You may sort the rows based on the **VLAN Name** or **Number** columns by clicking the column header. Click **Refresh** to update the information at any time. Click **Auto Refresh** to instruct the Array to refresh this window automatically.

*See Also*

[Network](#)

[Network Interfaces](#)

[Network Status Windows](#)

[VLANs](#)

[WDS](#)

### Routing Table

This status-only window lists the entries in the Array’s routing table. The table provides the Array with instructions for sending each packet to its next hop on its route across the network.

The screenshot shows the XN16 Wi-Fi Array interface with the Routing Table selected. The main header displays the device name 'BrianXN16 (10.100.47.33)' and the uptime '0 days, 0 hours, 31 mins'. A sidebar on the left lists navigation options: Status, Array, Network, Network Map, Spanning Tree Status, Routing Table, and ARP Table. The main content area contains a table with the following data:

Destination	Mask	Gateway	Interface
255.255.255.255	255.255.255.255	0.0.0.0	eth0
10.100.47.0	255.255.255.0	0.0.0.0	gig1/2
10.0.1.0	255.255.255.0	0.0.0.0	eth0
0.0.0.0	0.0.0.0	10.100.47.1	gig1/2

Figure 55. Routing Table

*See Also*

VLANs  
 Configuring VLANs on an Open SSID

### ARP Table

This status-only window lists the entries in the Array’s ARP table. For a device with a given IP address, this table lists the device’s MAC address. It also shows the Array interface through which this device may be reached. The table typically includes devices that are on the same local area network segment as the Array.

The screenshot shows the XN16 Wi-Fi Array interface with the ARP Table selected. The main header displays the device name 'BrianXN16 (10.100.47.33)' and the uptime '0 days, 0 hours, 32 mins'. A sidebar on the left lists navigation options: Status, Array, Network, Network Map, Spanning Tree Status, Routing Table, ARP Table, and DHCP Leases. The main content area contains a table with the following data:

IP Address	MAC Address	Interface
10.100.47.13	00:0F:7D:00:43:0A	gig1/2
10.100.47.1	00:10:DB:FF:20:A0	gig1/2
10.100.47.38	00:0F:7D:01:1C:1F	gig1/2
10.100.47.10	00:0F:7D:00:45:F1	gig1/2
10.100.47.16	00:0F:7D:00:B8:0D	gig1/2

Figure 56. ARP Table

*See Also*

Routing Table  
 ARP Filtering

## DHCP Leases

This status-only window lists the IP addresses (leases) that the Array has allocated to client stations. For each, it shows the IP address assigned from one of the defined DHCP pools, and the MAC address and host name of the client station. The start and end time of the lease show how long the allocation is valid. The same IP address is normally renewed at the expiration of the current lease.

IP Address	MAC Address	Start Time	End Time	Time Left	Host Name
192.168.1.254	00:21:00:5e:ab:8b	Dec-09 15:50:11	Dec-09 15:55:11	0 days 0:03:20	Shelly-PC

Figure 57. DHCP Leases

*See Also*

DHCP Server

## Connection Tracking/NAT

This status-only window lists the session connections that have been created on behalf of clients. This table may also be used to view information about current NAT sessions.

Show Netbios															
Outbound Traffic							Return Traffic								
Type	State	Source IP	Destination IP	Src Port	Dst Port	Packets	Bytes	State	Source IP	Destination IP	Src Port	Dst Port	Packets	Bytes	Use
udp		10.100.47.10	255.255.255.255	39127	22610	1	220	Unreplied	255.255.255.255	10.100.47.10	22610	39127	0	0	1
udp		10.100.47.16	10.100.40.137	60161	22610	1	214	Unreplied	10.100.40.137	10.100.47.16	22610	60161	0	0	1
udp		10.100.47.16	10.100.47.33	15004	15003	995	87688	Assured	10.100.47.33	10.100.47.16	15003	15004	995	87688	1
udp		10.100.46.16	10.100.47.16	41319	161	211873	74205993	Assured	10.100.47.16	10.100.46.16	161	41319	211873	87025111	1
udp		10.100.47.16	10.110.37.8	60161	22610	1	214	Unreplied	10.110.37.8	10.100.47.16	22610	60161	0	0	1
udp		10.100.47.16	10.100.1.13	48391	162	1	229	Unreplied	10.100.1.13	10.100.47.16	162	48391	0	0	1
udp		10.100.47.16	255.255.255.255	60161	22610	1	214	Unreplied	255.255.255.255	10.100.47.16	22610	60161	0	0	1

Figure 58. Connection Tracking

Click the **Show Netbios** checkbox at the bottom of the page to display NetBIOS name information for the source and destination location of the connection. The Netbios columns will replace traffic statistics columns.

You may sort the rows based on any column that has an active column header, indicated when the mouse pointer changes to the hand icon . Click **Refresh** to update the information at any time. Click **Auto Refresh** to instruct the Array to refresh this window automatically.

*See Also*

Filters

### CDP Neighbors

This status-only window lists devices on the Array’s network that support the Cisco Discovery Protocol (CDP).

Status		Name: SS-XN0429091D207 ( 10.100.47.16 )						Uptime: 0 days, 23 hours, 51 mins	
<ul style="list-style-type: none"> <li>▸ Array</li> <li>▾ Network                             <ul style="list-style-type: none"> <li>Network Map</li> <li>Spanning Tree Status</li> <li>Routing Table</li> <li>ARP Table</li> <li>DHCP Leases</li> <li>Connection Tracking</li> <li>CDP Neighbors</li> <li>Network Assurance</li> </ul> </li> <li>▸ RF Monitor</li> <li>▸ Stations</li> <li>▸ Statistics</li> <li>System Log</li> </ul>								<input type="checkbox"/> Auto Refresh <input type="button" value="Refresh"/>	
Hostname	IP Address	Model	Interface	Native VLAN	Capabilities	Software			
Adrians-XN8	10.100.47.12	Xirrus XN8, 1.0GB-ECC (1.0GHz)	Gig1/2	none	L2SW (switch)	Xirrus ArrayOS Version 4.0.8 (Feb 17 2010), Build: 1201			
BrianXN16	10.100.47.33	Xirrus XN16, 1.0GB-ECC (1.0GHz)	Gig1/2	none	L2SW (switch)	Xirrus ArrayOS Version 4.1.0 (Mar 24 2010), Build: 1269			
Bruces-XN8-Array	10.100.47.10	Xirrus XN8, 1.0GB-ECC (1.0GHz)	Gig1/2	none	L2SW (switch)	Xirrus ArrayOS Version 4.0.7 (Dec 31 2009), Build: 1192			
Bruces-XS3900-Array	10.100.47.13	Xirrus XS-3900, 512MB (825MHz)	Gig1/2	none	L2SW (switch)	Xirrus ArrayOS Version 3.5 (May 20 2009), Build: 0724			
SS-XN0429091D207	10.100.47.16	Xirrus XN4, 512MB-ECC (825MHz)	Gig1	none	L2SW (switch)	Xirrus ArrayOS Version 4.1.0 (Mar 24 2010), Build: 1269			
Sheyda-XN8	10.100.47.38	Xirrus XN8, 1.0GB-ECC (1.0GHz)	Gig1/2	none	L2SW (switch)	Xirrus ArrayOS Version 4.0.7 (Dec 31 2009), Build: 1192			
adrians-3900	10.100.47.11	Xirrus XS-3900, 512MB (825MHz)	Gig1/2	none	L2SW (switch)	Xirrus ArrayOS Version 3.5 (May 20 2009), Build: 0724			

Figure 59. CDP Neighbors

The Array performs discovery on the network on an ongoing basis. This list shows the devices that have been discovered—Cisco devices and other devices on the network that have CDP running. For each, it shows the device’s host name, IP address, manufacturer and model name, the device interface that is connected to the network (i.e., the port that was discovered), and the network capabilities of the device (switch, router, supported protocols, etc.).

CDP must be enabled on the Array in order to gather and display this information. See “CDP Settings” on page 189.

## Network Assurance

This status-only window shows the results of ongoing network assurance testing.

XN16 Wi-Fi Array

Status Name: BrianXN16 ( 10.100.47.33 ) Uptime: 0 days, 0 hours, 29 mins

Array
 Auto Refresh Refresh

Network

Setting	Hostname	IP Address	Status
DNS server 1		10.100.1.10	Connectivity OK
DNS server 2		10.100.2.10	Connectivity OK
NTP primary server	ntp.xirrus.com	72.18.205.156	Connectivity OK
SNMP trap host 1	Xirrus-XMS	10.100.1.13	Connectivity OK
gig1 IP gateway		10.100.47.1	Connectivity OK
gig2 IP gateway		10.100.47.1	Connectivity OK

Network Map
Spanning Tree Status
Routing Table
ARP Table
DHCP Leases
Connection Tracking
CDP Neighbors
Network Assurance

Figure 60. Network Assurance

The Array checks connectivity to network servers that you have configured (for example, DNS and NTP servers) on an ongoing basis. For each server, this list shows the server's host name (if any), IP address, and status.

Network assurance must be enabled on the Array in order to perform these connectivity tests and display this information. See [“Management Control” on page 222](#).

*See Also*

[Management Control](#)

## RF Monitor Windows

Every Wi-Fi Array includes an integrated RF spectrum analyzer as a standard feature. The spectrum analyzer allows you to characterize the RF environment by monitoring throughput, signal, noise, errors, and interference levels continually per channel. This capability uses the built-in threat-sensor radio **abg(n)2**. The associated software is part of the ArrayOS.

The following RF Status windows are available:

- **IAPs**—displays current statistics and RF measurements for each of the Array’s IAPs.
- **Spectrum Analyzer**—displays current statistics and RF measurements for each of the Array’s channels.
- **Intrusion Detection**—displays rogue APs that have been detected by the Array.



*Some status information is only available if the Array’s license includes **Advanced Feature Sets**. For example, the Spectrum Analyzer requires the **Xirrus Advanced RF Analysis Manager (RAM)**. If a feature is unavailable, then your license does not support the feature and you will get an error message if you try to set the feature. See “**About Licensing and Upgrades**” on page 325.*

## IAPs

The RF Monitor—IAPs window displays traffic statistics and RF readings observed by each Array IAP (radio). Note that the data is an instantaneous snapshot for the IAP—it is not an average or a cumulative total.

Status		Uptime - 5 days, 23 hours, 24 minutes														
<ul style="list-style-type: none"> <li>▶ Array</li> <li>▶ Network</li> <li>▶ RF Monitor</li> </ul>		IAP	Channel	Packets/Sec	Bytes/Sec	802.11 Busy	Other Busy	Signal to Noise	Noise Floor	Error Rate	Average RSSI	Average Data Rate				
<b>IAPs</b>				0	0K 0	0K 0%	100% 0%	100% 0	-20	-70	0%	100%	95	36	1M	Scale
Spectrum Analyzer		abg1	1	<div style="width: 100%; height: 10px; background-color: blue;"></div>	<div style="width: 100%; height: 10px; background-color: blue;"></div>	<div style="width: 100%; height: 10px; background-color: red;"></div>	<div style="width: 100%; height: 10px; background-color: black;"></div>	<div style="width: 100%; height: 10px; background-color: green;"></div>	<div style="width: 100%; height: 10px; background-color: yellow;"></div>	<div style="width: 100%; height: 10px; background-color: red;"></div>	<div style="width: 100%; height: 10px; background-color: yellow;"></div>	<div style="width: 100%; height: 10px; background-color: green;"></div>	<div style="width: 100%; height: 10px; background-color: yellow;"></div>	<div style="width: 100%; height: 10px; background-color: green;"></div>	<div style="width: 100%; height: 10px; background-color: green;"></div>	<div style="width: 100%; height: 10px; background-color: green;"></div>
Intrusion Detection		abg2	-													
Stations		abg3	11	<div style="width: 100%; height: 10px; background-color: blue;"></div>	<div style="width: 100%; height: 10px; background-color: blue;"></div>	<div style="width: 100%; height: 10px; background-color: red;"></div>	<div style="width: 100%; height: 10px; background-color: black;"></div>	<div style="width: 100%; height: 10px; background-color: green;"></div>	<div style="width: 100%; height: 10px; background-color: yellow;"></div>	<div style="width: 100%; height: 10px; background-color: red;"></div>	<div style="width: 100%; height: 10px; background-color: yellow;"></div>	<div style="width: 100%; height: 10px; background-color: green;"></div>	<div style="width: 100%; height: 10px; background-color: yellow;"></div>	<div style="width: 100%; height: 10px; background-color: green;"></div>	<div style="width: 100%; height: 10px; background-color: green;"></div>	<div style="width: 100%; height: 10px; background-color: green;"></div>
Statistics		abg4	6	<div style="width: 100%; height: 10px; background-color: blue;"></div>	<div style="width: 100%; height: 10px; background-color: blue;"></div>	<div style="width: 100%; height: 10px; background-color: red;"></div>	<div style="width: 100%; height: 10px; background-color: black;"></div>	<div style="width: 100%; height: 10px; background-color: green;"></div>	<div style="width: 100%; height: 10px; background-color: yellow;"></div>	<div style="width: 100%; height: 10px; background-color: red;"></div>	<div style="width: 100%; height: 10px; background-color: yellow;"></div>	<div style="width: 100%; height: 10px; background-color: green;"></div>	<div style="width: 100%; height: 10px; background-color: yellow;"></div>	<div style="width: 100%; height: 10px; background-color: green;"></div>	<div style="width: 100%; height: 10px; background-color: green;"></div>	<div style="width: 100%; height: 10px; background-color: green;"></div>
Event Log		a1	36	<div style="width: 100%; height: 10px; background-color: blue;"></div>	<div style="width: 100%; height: 10px; background-color: blue;"></div>	<div style="width: 100%; height: 10px; background-color: red;"></div>	<div style="width: 100%; height: 10px; background-color: black;"></div>	<div style="width: 100%; height: 10px; background-color: green;"></div>	<div style="width: 100%; height: 10px; background-color: yellow;"></div>	<div style="width: 100%; height: 10px; background-color: red;"></div>	<div style="width: 100%; height: 10px; background-color: yellow;"></div>	<div style="width: 100%; height: 10px; background-color: green;"></div>	<div style="width: 100%; height: 10px; background-color: yellow;"></div>	<div style="width: 100%; height: 10px; background-color: green;"></div>	<div style="width: 100%; height: 10px; background-color: green;"></div>	<div style="width: 100%; height: 10px; background-color: green;"></div>
Configuration		a2	52	<div style="width: 100%; height: 10px; background-color: blue;"></div>	<div style="width: 100%; height: 10px; background-color: blue;"></div>	<div style="width: 100%; height: 10px; background-color: red;"></div>	<div style="width: 100%; height: 10px; background-color: black;"></div>	<div style="width: 100%; height: 10px; background-color: green;"></div>	<div style="width: 100%; height: 10px; background-color: yellow;"></div>	<div style="width: 100%; height: 10px; background-color: red;"></div>	<div style="width: 100%; height: 10px; background-color: yellow;"></div>	<div style="width: 100%; height: 10px; background-color: green;"></div>	<div style="width: 100%; height: 10px; background-color: yellow;"></div>	<div style="width: 100%; height: 10px; background-color: green;"></div>	<div style="width: 100%; height: 10px; background-color: green;"></div>	<div style="width: 100%; height: 10px; background-color: green;"></div>
Express Setup		a3	149	<div style="width: 100%; height: 10px; background-color: blue;"></div>	<div style="width: 100%; height: 10px; background-color: blue;"></div>	<div style="width: 100%; height: 10px; background-color: red;"></div>	<div style="width: 100%; height: 10px; background-color: black;"></div>	<div style="width: 100%; height: 10px; background-color: green;"></div>	<div style="width: 100%; height: 10px; background-color: yellow;"></div>	<div style="width: 100%; height: 10px; background-color: red;"></div>	<div style="width: 100%; height: 10px; background-color: yellow;"></div>	<div style="width: 100%; height: 10px; background-color: green;"></div>	<div style="width: 100%; height: 10px; background-color: yellow;"></div>	<div style="width: 100%; height: 10px; background-color: green;"></div>	<div style="width: 100%; height: 10px; background-color: green;"></div>	<div style="width: 100%; height: 10px; background-color: green;"></div>
Network		a4	40	<div style="width: 100%; height: 10px; background-color: blue;"></div>	<div style="width: 100%; height: 10px; background-color: blue;"></div>	<div style="width: 100%; height: 10px; background-color: red;"></div>	<div style="width: 100%; height: 10px; background-color: black;"></div>	<div style="width: 100%; height: 10px; background-color: green;"></div>	<div style="width: 100%; height: 10px; background-color: yellow;"></div>	<div style="width: 100%; height: 10px; background-color: red;"></div>	<div style="width: 100%; height: 10px; background-color: yellow;"></div>	<div style="width: 100%; height: 10px; background-color: green;"></div>	<div style="width: 100%; height: 10px; background-color: yellow;"></div>	<div style="width: 100%; height: 10px; background-color: green;"></div>	<div style="width: 100%; height: 10px; background-color: green;"></div>	<div style="width: 100%; height: 10px; background-color: green;"></div>

Figure 61. RF Monitor—IAPs

Figure 61 presents the data as a graphical display, enabled by selecting the **Graph** checkbox on the lower left. If this option is not selected, data is presented as a numerical table. You may sort the rows based on any column that has an active column header, indicated when the mouse pointer changes to the hand icon . Click **Refresh** to update the information at any time. Click **Auto Refresh** to instruct the Array to refresh this window automatically.



## Spectrum Analyzer



*The RF measurements for this feature are obtained by IAP **abg(n)2**, which **must** be set to **monitor** mode for any data to be available. See “IAP Settings” on page 271.*

Spectrum analysis on Wi-Fi Arrays is a distributed capability that automatically covers the entire Wi-Fi network, since a sensor is present in every unit. Arrays monitor the network 24/7 and analyze interference anywhere in the network from your desk. There’s no need to walk around with a device as with traditional spectrum analyzers, thus you don’t have to be in the right place to find outside sources that may cause network problems or pose a security threat. The Array monitors all 802.11 radio bands (a/b/g/n), not just those currently used for data transmission.

The RF Spectrum Analyzer window displays instantaneous traffic statistics and RF readings for all channels, as measured by the Array’s **abg(n)2** radio. This differs from the RF Monitor-IAPs window, which displays values measured by each IAP radio for its current assigned channel. For the spectrum analyzer, the **abg(n)2** radio is in a listen-only mode, scanning across all Wi-Fi channels. Each channel is scanned in sequence, for a 250 millisecond interval per channel. The spectrum analyzer window presents the data as a graphical display of vertical bar graphs for each statistic as shown in [Figure 62](#) (the default presentation), or horizontally as bar graphs or numerical RF measurements. The measurements displayed are explained in “[Spectrum Analyzer Measurements](#)” on page 143.

As an aid to viewing data for a particular channel, click the channel number. The channel will be highlighted down the page (or across the page for a rotated view, in both text and graph modes). Click additional channels to highlight them for easy comparison. To remove the highlighting from a channel, click the channel number again. Click **Refresh** to update the information at any time. Click **Auto Refresh** to instruct the Array to refresh this window automatically.

Click Channel number to highlight

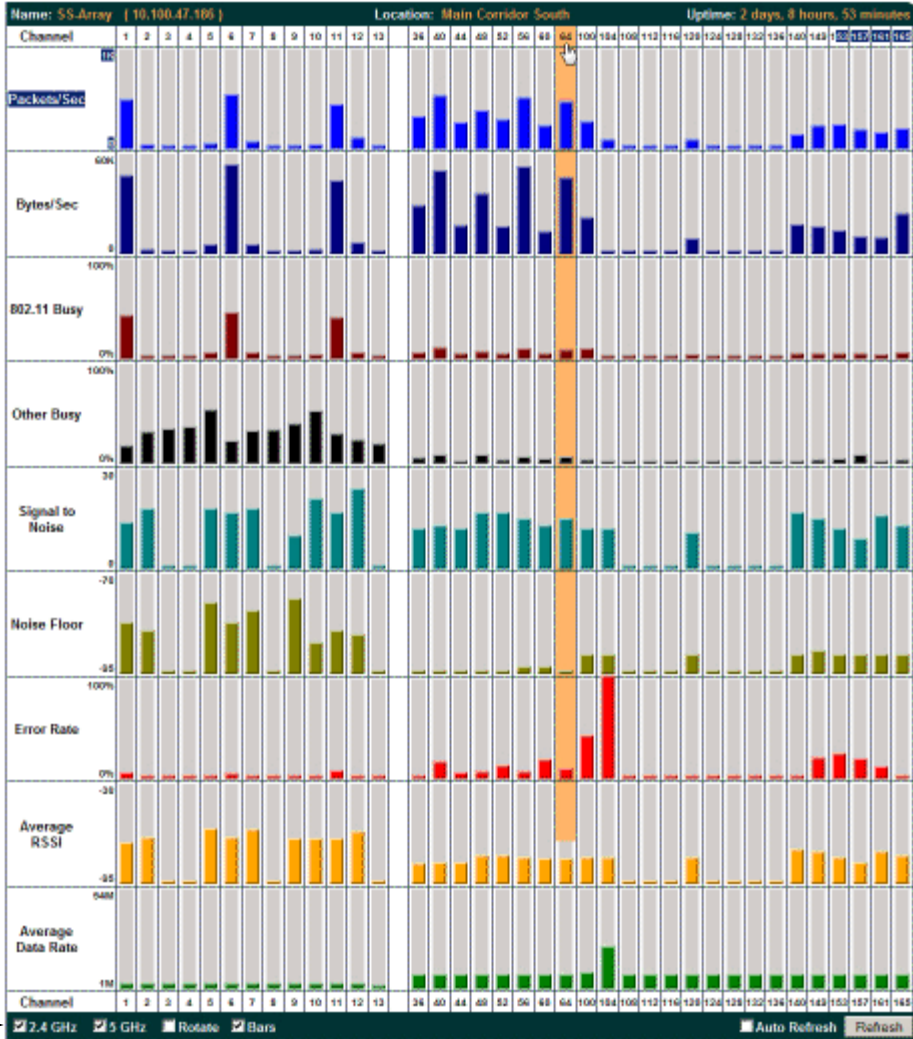

Select Display Options

Figure 62. RF Spectrum Analyzer

The Spectrum Analyzer offers several display options:

- To display horizontal bar graphs, click the **Rotate** checkbox at the bottom of the data window.
- In the rotated view, if you wish to view data as a numerical table, click the **Text** checkbox. Click again to return to a graphical display. The text option is only available in the rotated view.
- When viewing a graphical display, click **Bars** to have the bar graphs displayed against a gray background—you may find this easier on the eyes. This operation is not available when Text is selected.
- You may sort the rows based on any column that has an active column header, indicated when the mouse pointer changes to the hand icon . Sorting is only available in the rotated view.
- At the bottom left of the frame, you may select whether to display only 2.4 GHz channels, 5 GHz channels, or both (the default is both). Note that the data is an instantaneous snapshot—it is not an average or a cumulative total.

### *Spectrum Analyzer Measurements*

The spectrum analyzer displays the following information:

- **Packets/Sec:** Total number of Wi-Fi packets per second on the channel, both valid and errored packets.
- **Bytes/Sec:** Total number of Wi-Fi bytes per second on the channel, valid packets only.
- **802.11 Busy:** Percentage of time that 802.11 activity is seen on the channel.
- **Other Busy:** Percentage of time that the channel is unavailable due to non-802.11 activity.

The total busy time (802.11 Busy plus Other Busy) will never total more than 100%. The remaining time (100% minus total busy time) is quiet time—the time that no activity was seen on the channel.

- **Signal to Noise:** Average SNR (signal to noise ratio) seen on the channel, calculated from the signal seen on valid 802.11 packets less the noise floor level. A dash value “-” means no SNR data was available for the interval.

- **Noise Floor:** Average noise floor reading seen on the channel (ambient noise). A dash value “-” means no noise data was available for the interval.
- **Error Rate:** Percentage of the total number of Wi-Fi packets seen on the channel that have CRC errors. The Error rate percentage may be high on some channels since the monitor radio is set to receive at a very sensitive level, enabling it to hear packets from devices at far distances.
- **Average RSSI:** Average RSSI level seen on 802.11 packets received on the channel. A dash value “-” means no RSSI data was available for the interval.
- **Average Data Rate:** Average data rate over time (per byte, not per packet) seen on 802.11 packets received on the channel. A dash value “-” means no data rate information was available for the interval. A higher data rate (above 6 Mbps) typically indicates user data traffic on the channel. Otherwise, the data rate reflects control packets at the lower basic rates.

### Intrusion Detection

This window displays all detected access points, according to the category you select from the drop-down list at the top—either Unknown, Known or Approved. This includes ad hoc access points (station-to-station connections). You can sort the results based on the following parameters by clicking the desired column header:

- SSID
- BSSID
- Manufacturer
- Channel
- RSSI
- Security
- Type
- Discovered
- Last Active

XN8 Wi-Fi Array

<div style="font-size: 10px; padding: 2px;">                 Status                  ▶ Array                  ▶ Network                  ▼ RF Monitor                    IAPs                    Spectrum Analyzer                    Intrusion Detection                  ▶ Stations                  ▶ Statistics                  ▶ System Log                  Configuration                    ▶ Express Setup                    ▶ Network                    ▶ Services                    ▶ VLANs             </div>	Name: SS-XN8 ( 10.100.47.186 )		Location: SS Area		Uptime: 4 days, 2 hours, 40 minutes				
Select List <span style="border: 1px solid #ccc; padding: 2px;">Unknown</span>									
Select	BSSID	SSID	Manufacturer	Channel	RSSI	Security	Type	Discovered	Last Active
<input type="checkbox"/>	00:0b:6b:e0:00:f7	wlan-ng	Wistron Neweb	6	-51	none	ESS	Dec-05 14:06	active
<input type="checkbox"/>	00:0f:34:c0:46:30	tsunami	Cisco	11	-63	none	ESS	Dec-05 14:06	active
<input type="checkbox"/>	00:19:33:00:18:98	Giuseppe	Strix	165	-76	TKIP+PSK	ESS	Dec-05 14:06	active
<input type="checkbox"/>	00:0e:84:e4:19:9e	tsunami	Cisco	56	-87	none	ESS	Dec-05 14:06	active
<input type="checkbox"/>	00:11:20:ee:dc:83	LinkFloor3	Cisco	60	-61	none	ESS	Dec-08 16:13	active
<input type="button" value="Set Approved"/> <input type="button" value="Set Known"/> <input type="button" value="Set Blocked"/>			<input checked="" type="checkbox"/> Auto Refresh			<input type="button" value="Refresh"/>	<input type="button" value="Save"/>		

**Select the type of AP to display**

Figure 63. Intrusion Detection/Rogue AP List

The Intrusion Detection window provides the easiest method for designating rogue APs as Known, Approved, or Unknown. Choose one or more APs using the checkbox in the **Select** column, then set whether they are Approved, Known, or Unknown using the buttons on the lower left.

You can refresh the list at any time by clicking on the **Refresh** button, or click in the **Auto Refresh** check box to instruct the Array to refresh the list automatically.

*See Also*

[Network Map](#)

[Rogue Control List](#)

[SSIDs](#)

[SSID Management](#)

## Station Status Windows

The following Station Status windows are available:

- **Stations**—this list describes all stations associated to the Array.
- **Location Map**—displays a map showing the approximate locations of all stations associated to the array.
- **RSSI**—for each associated station, this displays the Received Signal Strength Indicator at each of the Array’s IAPs.
- **Signal-to-Noise Ratio (SNR)**—for each associated station, this displays the SNR at each of the Array’s IAPs.
- **Noise Floor**—for each associated station, this displays the ambient noise (silence) value at each of the Array’s IAPs.
- **Max by IAP**—for each IAP, this shows the historical maximum number of stations that have been associated to it over various periods of time.



*Some status information is only available if the Array’s license includes the Xirrus Advanced RF Analysis Manager (RAM). If a feature is unavailable, then your license does not support the feature and you will get an error message if you try to set the feature. See “About Licensing and Upgrades” on page 325.*





### Location Map

The Location Map shows the approximate locations of stations relative to this Array. The location of each station is computed based on the RSSI of its signal as received by the Array. The distance is adjusted based on the environment setting that you selected. You may display just the stations associated to this Array, unassociated stations (shown in gray), or both. The station count is shown on the right, above the map. You may also choose to display only 5 GHz stations (shown in orange) or 2.4 GHz stations (shown in green), or both.

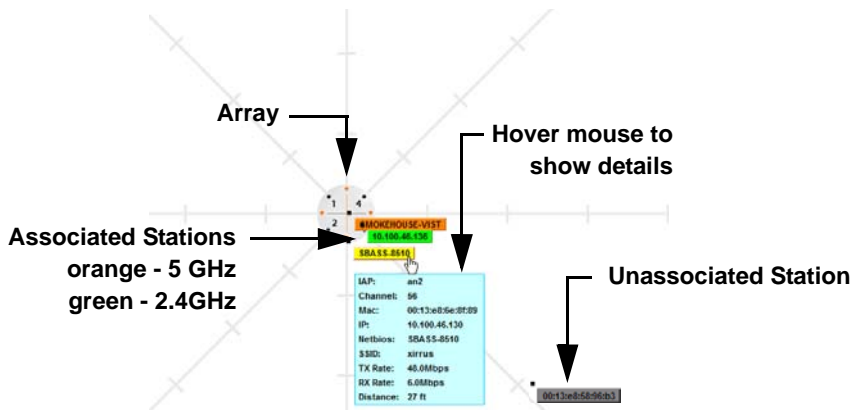

Figure 65. Location Map

The map and Array are shown as if you were looking down on the Array from above, say from a skylight on the roof. Thus the positions of the radios **abg(n)1** to **abg(n)4** are a mirror image of the way they are typically drawn when looking at the face of the Array. Radios **abg(n)1** to **abg(n)4** are marked (1 to 4) on the map to show the orientation of the Array.

A station is identified by the type of **Preferred Label** that you select: **Netbios Name**, **IP Address**, **MAC Address**, or **Manufacturer**. If multiple stations are near each other, they will be displayed slightly offset so that one station does not completely obscure another. You may minimize a station that is not of interest by clicking it. There is also a **Minimize All** button.

You may replace the range-finder background image above with your own custom image of the floorplan of the area served by the Array—see “Working with the Custom Image” on page 153

Hover the mouse over a station to show detailed information. (Figure 65) For a station that is associated to this Array, the details include:

- The **IAP**, **Channel**, and **SSID** to which the station is associated.
- The **MAC** and **IP** address and **Netbios** name of the station.
- The **TX Rate** and **RX Rate** of this connection.
- The approximate **Distance** of this station from the Array. The distance is estimated using the received signal strength and your environment setting. The environment determines the typical signal attenuation due to walls and other construction that affect signal reception.

**Controls and items displayed on the Location Map window**



*The Location Map has its own scroll bars in addition to the browser’s scroll bars. If you narrow the browser window, the map’s scroll bar may be hidden. Use the browser’s bottom scroll bar if you need to move it into view.*

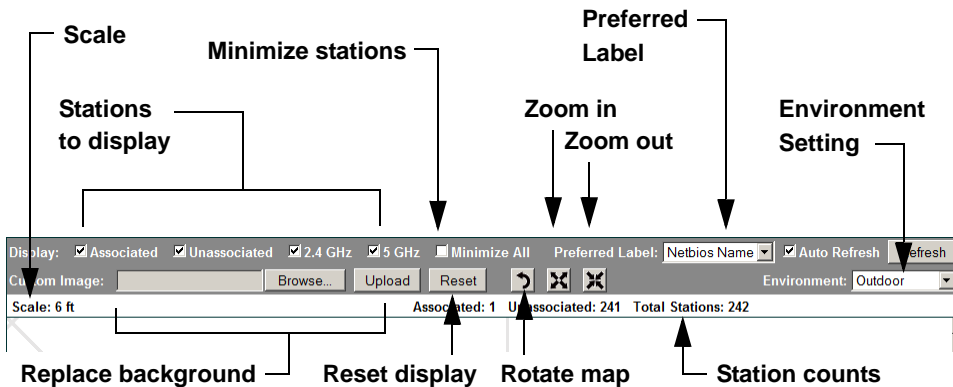

Figure 66. Controls for Location Map

- **Display Associated/Unassociated:** Select whether to display stations that are associated to the Array, stations that are not associated, or both.

- **Display 2.4 GHz/5 GHz:** Select whether to display 802.11b(g)(n) stations, or 802.11a(n) stations, or both.
- **Minimize All:** All stations are shown by default with their NetBIOS name or IP or MAC address. If the map is too cluttered, you can reduce the display for each station to a small rectangle. (Figure 67) You may still display detailed information for the station by hovering over it. To enlarge all rectangles, clear the Minimize All checkbox.
- **Preferred Label:** This field is located on the top of the window towards the right. It selects the type of label to be displayed for stations: **Netbios Name**, **IP Address**, **MAC Address**, or **Manufacturer**. If you select NetBIOS (this is the default), then that name, if known, will be used to label each Array. Else, its IP or MAC address will be used, in that order.
- **Auto Refresh:** Instructs the Array to refresh this window automatically.
- **Refresh:** Updates the stations displayed.

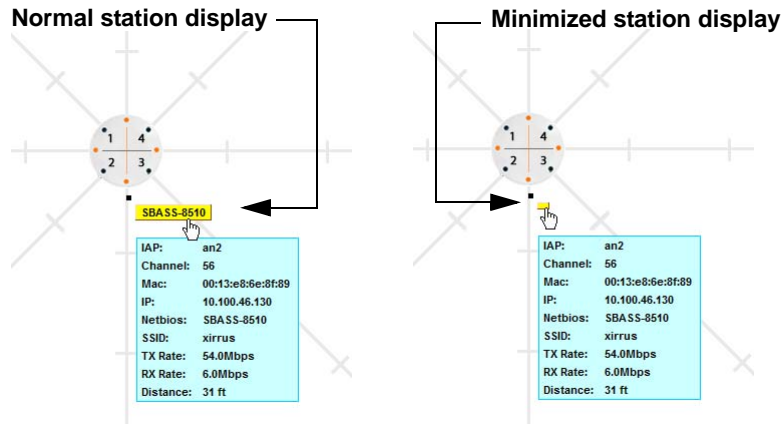





Figure 67. Minimizing stations

- **Custom Image:** Use this feature to replace the default background image with your own image of the floor plan of your location. Click the **Browse** button and browse to the desired file on your computer. This may be a .gif, .jpg, .jpeg, .png, .htm, or .html file. **??OK??** The scale of the file should be 100 feet per inch. Then click **Upload** (see below). For more

information on using the custom, image, see “Working with the Custom Image” on page 153.

- **Upload:** After browsing to the desired custom image, click the **Upload** button to install it. The map is redisplayed with your new background. No hash marks (for the map scale) are added to the image display.
- **Reset:** Click this button to restore the map display to the factory settings. All attributes are restored—including the stations selected for display, the scale, the rotation, and the background map.
-  **Rotate:** Click this button to rotate the orientation of the entire map. It rotates the map 45° counter-clockwise.
-  **Enlarge:** Click this button to enlarge (zoom in on) the map. The displayed **Scale** is updated with the new scale for the map.
-  **Reduce:** Click this button to reduce (zoom out on) the map. The displayed **Scale** is updated with the new scale for the map.
- **Environment:** This field is located on the top right of the window. Select the type of environment for this Array’s deployment: **Outdoor**, **Indoor open** (few walls or obstructions), **Indoor walled** (typical wall or cubicle construction), or **Indoor dense** (many walls or obstructions, or unusually dense walls).
- **Scale:** This view-only value shows the approximate distance represented by each hashmark on the default map background.
- **Associated, Unassociated, Total Stations:** These view-only values show the station counts observed by the Array.

*See Also*

[Station Status Windows](#)

### Working with the Custom Image

After you have uploaded a custom image (see **Custom Image** and **Upload** in “Controls and items displayed on the Location Map window” on page 150), you should move the display of the Array on your map to correspond with its actual location at your site.

To move the Array on the map, simply click it, then drag and drop it to the desired location. The Array will continue to follow the mouse pointer to allow you to make further changes to its location. When you are satisfied with its location, click the Array again to return to normal operation.

### RSSI

For each station that is associated to the Array, the RSSI (Received Signal Strength Indicator) window shows the station’s RSSI value as measured by each IAP. In other words, the window shows the strength of the station’s signal at each radio. You may choose to display **Unassociated Stations** as well with a checkbox at the bottom of the window.

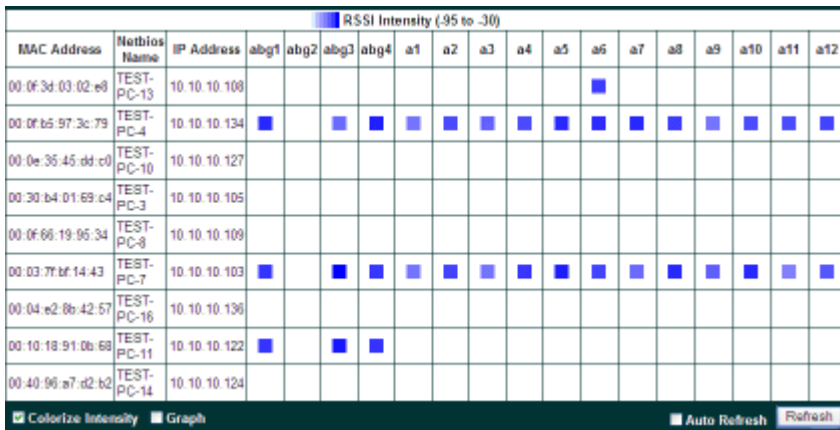

Figure 68. Station RSSI Values

By default, the RSSI is displayed numerically. You may display the relative strength using color if you select **Colorize Intensity**, with the strongest signals indicated by the most intense color. (Figure 68) If you select **Graph**, then the RSSI is shown on a representation of the Array, either colorized or numerically based

on your selection. (Figure 69) The stations are listed to the left of the Array—click on a station to show its RSSI values on the Array.

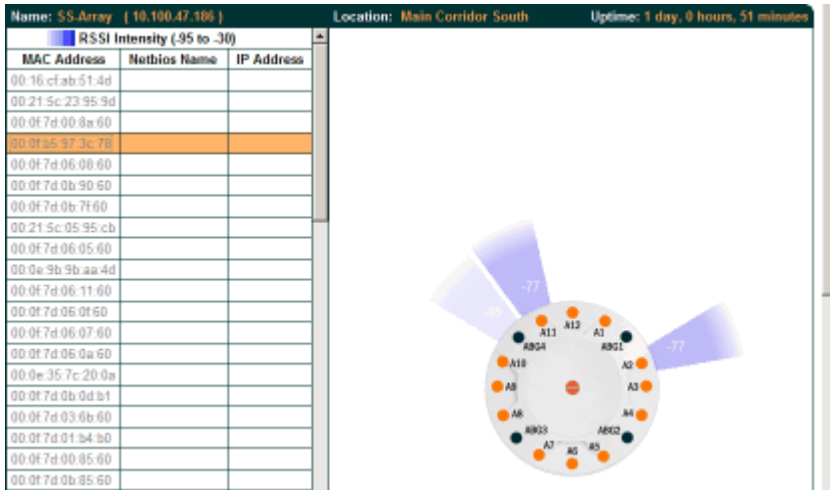

Figure 69. Station RSSI Values—Colorized Graphical View

In either graphical or tabular view, you may sort the rows based on any column that has an active column header, indicated when the mouse pointer changes to the hand icon . Click on the **Refresh** button to refresh the station list, or click in the **Auto Refresh** check box to instruct the Array to refresh this window automatically.

### See Also

- Station Status Windows
- RF Monitor Windows

### Signal-to-Noise Ratio (SNR)

For each station that is associated to the Array, the Signal-to-Noise Ratio (SNR) window shows the station’s SNR value as measured by each IAP. In other words, the window shows the SNR of the station’s signal at each IAP radio. The signal-to-noise ratio can be very useful for determining the cause of poor performance at a station. A low value means that action may need to be taken to reduce sources of noise in the environment and/or improve the signal from the station.

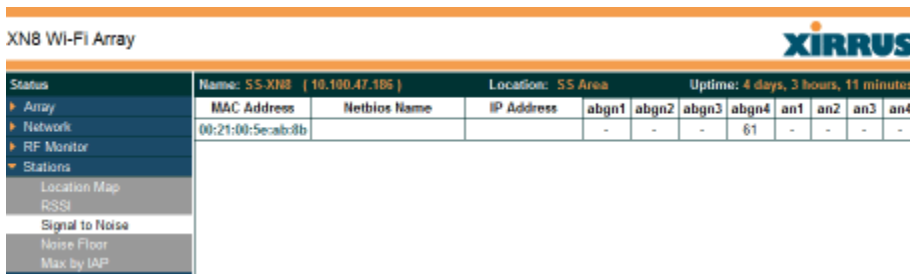

Figure 70. Station Signal-to-Noise Ratio Values

You may choose to display **Unassociated Stations** as well with a checkbox at the bottom of the window.

By default, the SNR is displayed numerically. (Figure 70) You may display the relative value using color if you select **Colorize Intensity**, with the highest SNR indicated by the most intense color. (Figure 71) If you select **Graph**, then the SNR is shown on a representation of the Array, either colorized or numerically based on your selection. The stations are listed to the left of the Array—click on a station to show its SNR values on the Array.

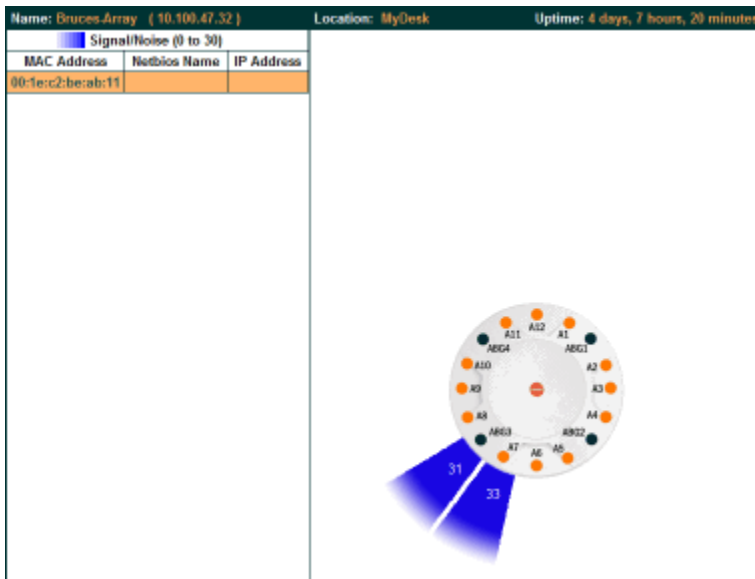



Figure 71. Station SNR Values—Colorized Graphical View

In either graphical or tabular view, you may sort the rows based on any column that has an active column header, indicated when the mouse pointer changes to the hand icon . Click on the **Refresh** button to refresh the station list, or click in the **Auto Refresh** check box to instruct the Array to refresh this window automatically.

*See Also*

- Station Status Windows
- RF Monitor Windows



### Noise Floor

For each station that is associated to the Array, the Noise Floor window shows the ambient noise affecting a station’s signal as measured by each IAP. The noise floor is the RSSI value when the station is not transmitting, sometimes called a Silence value. In other words, the window shows the noise floor of the station’s signal at each IAP radio. The noise floor value can be very useful for characterizing the environment of a station to determine the cause of poor performance. A relatively high value means that action may need to be taken to reduce sources of noise in the environment.

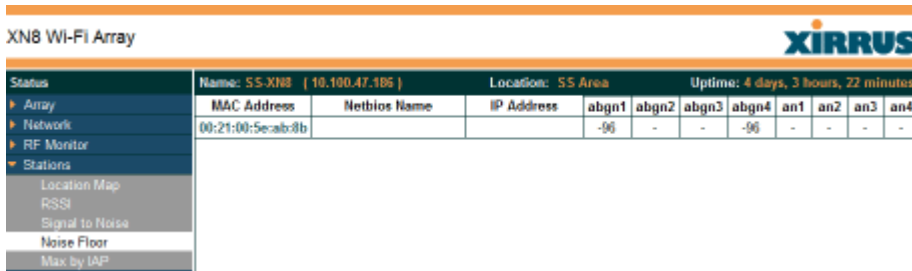

Figure 72. Station Noise Floor Values

You may choose to display **Unassociated Stations** as well with a checkbox at the bottom of the window.

By default, the noise floor is displayed numerically. (Figure 72) You may display the relative value using color if you select **Colorize Intensity**, with the highest noise indicated by the most intense color. If you select **Graph**, then the ambient noise is shown on a representation of the Array, either colorized or numerically based on your selection.(Figure 73) The stations are listed to the left of the Array—click on a station to show its values on the Array.

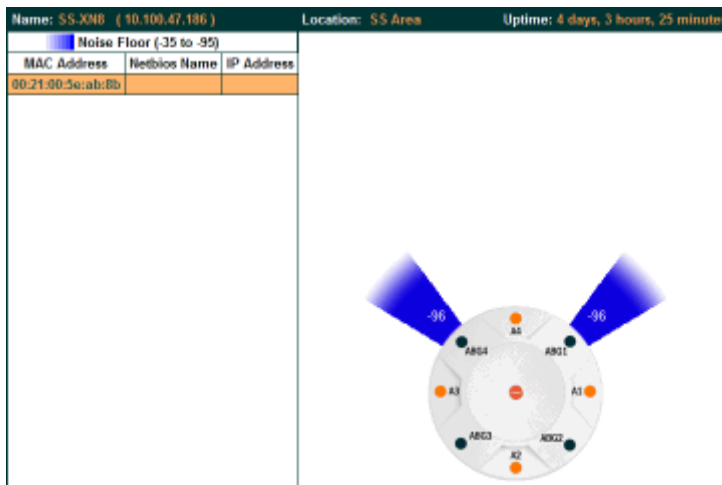

Figure 73. Station Noise Floor Values—Colorized Graphical View

In either graphical or tabular view, you may sort the rows based on any column that has an active column header, indicated when the mouse pointer changes to the hand icon . Click on the **Refresh** button to refresh the station list, or click in the **Auto Refresh** check box to instruct the Array to refresh this window automatically.

*See Also*

Station Status Windows

RF Monitor Windows

### Max by IAP

This status-only window shows the maximum number of client stations that have historically been associated to the Array. For each IAP, the list shows the IAP’s state and channel number, the current number of stations associated, and the highest number of stations that have been associated over various periods of time: hour, day, week, month, and year. In other words, the Max Station Count shows the “high water mark” over the selected period of time—the maximum count of stations for the selected period, rather than a cumulative count of all stations that have associated. This information aids in network administration and in planning for additional capacity.

XS8 Wi-Fi Array		Name: XS8.CMU (172.16.1.8)		Uptime: 0 days, 1 hour, 29 minutes					
				Max station count					
	IAP	State	Channel	Current Stations	Hour	Day	Week	Month	Year
▸ Array	abg1	up	1 manual	0	0	0	0	0	0
▸ Network	abg2	up	monitor	0	0	0	0	0	0
▸ RF Monitor	abg3	up	11 manual	2	3	3	3	3	3
▸ Stations	abg4	up	6 manual	0	1	2	2	2	2
Location Map	a1	up	36 manual	0	2	2	2	2	2
RSSI	a2	up	153 manual	2	4	4	4	4	4
Signal to Noise	a3	up	56 manual	0	0	0	0	0	0
Noise Floor	a4	up	165 manual	1	1	1	1	1	1
Max by IAP									
▸ Statistics									
System Log									

Figure 74. Max by IAP

You may click an IAP to go to the [IAP Settings](#) window. Click on the **Refresh** button to refresh the station list, or click **Auto Refresh** to instruct the Array to refresh this window automatically.

*See Also*

[IAPs](#)

[Station Status Windows](#)

## Statistics Windows

The following Array Statistics windows are available:

- **IAP Statistics Summary**—provides an overview of the statistical data associated with all IAPs. Expands to show links for displaying detailed statistics for individual IAPs.
- **Per-IAP Statistics**—provides detailed statistics for an individual IAP.
- **Network Statistics**—displays statistical data associated with each network (Ethernet) interface.
- **VLAN Statistics**—provides statistical data associated with your assigned VLANs.
- **WDS Statistics**—provides statistical data for all WDS client and host links.
- **Filter Statistics**—provides statistical data for all configured filters.
- **Station Statistics**—provides statistical data associated with each station.

### IAP Statistics Summary

This is a status only window that provides an overview of the statistical data associated with all IAPs. It also shows the channel used by each IAP. For detailed statistics for a specific IAP, see “Per-IAP Statistics” on page 161. Click the **Unicast Stats Only** checkbox on the lower left to filter the results, or clear the checkbox to show statistics for all wireless traffic.

You can **Refresh** the data (update the window with the latest information) or **Clear** the data (reset all content to zero and begin counting again) at any time by clicking on the appropriate button. You can also click in the **Auto Refresh** checkbox to instruct the Array to refresh this window automatically.

XN8 Wi-Fi Array **XIRRUS**

Status Name: SS-XN8 ( 10.100.47.186 ) Location: SS Area Uptime: 4 days, 3 hours, 34 minutes

Array Network RF Monitor Stations Statistics

Statistics for IAP All

IAP	Channel	Receive Statistics by IAP				Transmit Statistics by IAP			
		Bytes	Packets	Errors	Retries	Bytes	Packets	Errors	Retries
abgn1	1	5216920126	197823478	6327909	6597613	1785545569	6479993	17015352	0
abgn2	monitor	5514057421	110730414	2084140	46805	52598282	0	31687	0
abgn3	11	2525483	59570	2122	2298	722066	2242	3958	0
abgn4	6	8841010558	197057914	3711009	5814195	1974668688	7027414	14003973	0
an1	40	449765044	10002740	52483	5488440	2031371868	6487438	0	0
an2	56	1227961769	8591220	215648	3993583	2189924337	6489420	0	0
an3	48	433997191	9498186	55132	4554583	2055255364	6487917	0	0
an4	64	531168	2809	113	1494	722957	2259	0	0

Unicast Stats Only  Auto Refresh

Figure 75. IAP Statistics Summary Page

*See Also*

- System Log Window
- Global Settings (IAP)
- Global Settings .11a
- Global Settings .11bg
- IAPs

**Per-IAP Statistics**

This is a status only window that provides detailed statistics for the selected IAP. If you click the link for **IAP All** in the left frame, each detailed statistic field will show the sum of that statistic for all IAPs. For a summary of statistics for all IAPs, see “IAP Statistics Summary” on page 160. Use the **Display Percentages** checkbox at the lower left to select the output format—check this option to express each statistic as a percentage of the total at the top of the column, or leave it blank to display raw numbers.

A quick way to display the statistics for a particular IAP is by clicking the Array graphic at the bottom left of the WMI window. Click the desired IAP, and the selected statistics will be displayed. See “User Interface” on page 117.

Name: SS-X188 [ 10.100.47.186 ]		Location: SS Area		Uptime: 4 days, 3 hours, 39 minutes	
Statistics for IAP abg4					
Receive Statistics			Transmit Statistics		
Total Bytes	8848640898	Total Bytes	1976503120		
Total Packets	197226805	Total Packets	7034604		
Unicasts	25841	Unicasts	106		
Multicasts	0	Multicasts	15180		
Broadcasts	102409705	Broadcasts	42755		
Mgmt Packets	0	Mgmt Packets	7225222		
Beacons	94791259	Beacons	6976563		
Fragments	0	Fragments	0		
RTS Count	0	RTS Count	0		
CTS Count	0	CTS Count	0		
Receive Errors & Retries			Transmit Errors & Retries		
Total Errors	9533147	Total Errors	14015458		
Total Retries	5820027	Total Retries	0		
Dropped Packets	24	Dropped	8212136		
Unassociated	0	Unassociated	0		
CRC	3711363	ACK Failures	6803322		
Fragment Errors	0	RTS Failures	0		
Encryption Errors	1484	RTS Retries	0		
Duplicates	249	Single Retries	0		
Overruns	0	Multiple Retries	6804862		
<input type="checkbox"/> Display Percentages		<input type="checkbox"/> Auto Refresh		Refresh	Clear

Figure 76. Individual IAP Statistics Page (for IAP abg(n)1)

You can **Refresh** the data (update the window with the latest information) or **Clear** the data (reset all content to zero and begin counting again) at any time by clicking on the appropriate button. You can also click in the **Auto Refresh** check box to instruct the Array to refresh this window automatically.

*See Also*

- System Log Window
- Global Settings (IAP)
- Global Settings .11a
- Global Settings .11bg
- IAPs

### Network Statistics

This is a status only window that allows you to review statistical data associated with each network (Ethernet) interface and its activity. You can **Refresh** the data (update the window with the latest information) or **Clear** the data (reset all content to zero and begin counting again) at any time by clicking on the appropriate button. You can also click in the **Auto Refresh** check box to instruct the Array to refresh this window automatically. If you are experiencing problems on the Array, you may also want to print this window for your records.

Status	Name: SS-XNB (10.100.47.186)	Location: SS Area	Uptime: 4 days, 3 hours, 51 minutes	
Array	Fast Ethernet Statistics <span style="float:right">enabled, link down, 100Mbps, full duplex</span>			
Network	Receive Bytes	0	Transmit Bytes	0
RF Monitor	Receive Packets	0	Transmit Packets	0
Stations	Receive Compressed	0	Transmit Compressed	0
Statistics	Receive Multicast	0	Transmit Carrier Errors	0
IAP	Receive Dropped	0	Transmit Dropped	0
Network	Receive FIFO Errors	0	Transmit FIFO Errors	0
VLAN	Receive Frame Errors	0	Transmit Collisions	0
WDS	Receive Total Errors	0	Transmit Total Errors	0
Filter	Gigabit 1 Statistics <span style="float:right">enabled, link up, 1000Mbps, full duplex</span>			
Stations	Receive Bytes	246021597	Transmit Bytes	202395623
System Log	Receive Packets	1745005	Transmit Packets	859020
Configuration	Receive Compressed	0	Transmit Compressed	0
Express Setup	Receive Multicast	0	Transmit Carrier Errors	0
Network	Receive Dropped	0	Transmit Dropped	0
Services	Receive FIFO Errors	0	Transmit FIFO Errors	0
VLANs	Receive Frame Errors	0	Transmit Collisions	0
Security	Receive Total Errors	0	Transmit Total Errors	0
SSIDs	Gigabit 2 Statistics <span style="float:right">enabled, link down, 1000Mbps, half duplex</span>			
Groups	Receive Bytes	0	Transmit Bytes	0
IAPs	Receive Packets	0	Transmit Packets	0
WDS	Receive Compressed	0	Transmit Compressed	0
Filters	Receive Multicast	0	Transmit Carrier Errors	0
Tools	Receive Dropped	0	Transmit Dropped	0
System Tools	Receive FIFO Errors	0	Transmit FIFO Errors	0
CLI	Receive Frame Errors	0	Transmit Collisions	0
Logint	Receive Total Errors	0	Transmit Total Errors	0
Log Messages	<input type="checkbox"/> Auto Refresh    Refresh    Clear			

Figure 77. Network Statistics

*See Also*

- DHCP Server
- DNS Settings
- Network
- Network Interfaces

## VLAN Statistics

This is a status only window that allows you to review statistical data associated with your assigned VLANs. You can refresh the information that is displayed on this page at any time by clicking on the **Refresh** button, or select the **Auto Refresh** option for this window to refresh automatically. The **Clear All** button at the lower left allows you to clear (zero out) all VLAN statistics.

**XNB Wi-Fi Array**

Status Name: SS-XNB (10.100.47.186) Location: SS Area Uptime: 4 days, 3 hours, 59 minutes

VoIP (12) Statistics <span style="float: right;">Clear</span>			
Receive Bytes	0	Transmit Bytes	0
Receive Packets	0	Transmit Packets	0
Receive Compressed	0	Transmit Compressed	0
Receive Multicast	0	Transmit Carrier Errors	0
Receive Dropped	0	Transmit Dropped	0
Receive FIFO Errors	0	Transmit FIFO Errors	0
Receive Frame Errors	0	Transmit Collisions	0
Receive Total Errors	0	Transmit Total Errors	0
Finance (5) Statistics <span style="float: right;">Clear</span>			
Receive Bytes	0	Transmit Bytes	3313440
Receive Packets	0	Transmit Packets	5616
Receive Compressed	0	Transmit Compressed	0
Receive Multicast	0	Transmit Carrier Errors	0
Receive Dropped	0	Transmit Dropped	0
Receive FIFO Errors	0	Transmit FIFO Errors	0
Receive Frame Errors	0	Transmit Collisions	0
Receive Total Errors	0	Transmit Total Errors	0

Auto Refresh

Figure 78. VLAN Statistics

*See Also*

VLAN Management  
VLANs



### WDS Statistics

The main WDS Statistics window provides statistical data for all WDS client and host links. To access data about a specific WDS client or host link, simply click on the desired link in the left frame to access the appropriate window. You may also choose to view a sum of the statistics for all client links, all host links, or all links (both client and host links).

Status		Name: SS-XN8 (10.100.47.186)	Location: SS Area	Uptime: 4 days, 4 hours, 4 minutes																																																																																																																								
<ul style="list-style-type: none"> <li>Array</li> <li>Network</li> <li>RF Monitor</li> <li>Stations</li> <li>Statistics</li> <li>IAP</li> <li>Network</li> <li>VLAN</li> <li>WDS                             <ul style="list-style-type: none"> <li>Client Link 1</li> <li>Client Link 2</li> <li>Client Link 3</li> <li>Client Link 4</li> <li>Host Link 1</li> <li>Host Link 2</li> <li>Host Link 3</li> </ul> </li> </ul>	<table border="1"> <thead> <tr> <th colspan="2"></th> <th colspan="4">Receive Statistics</th> <th colspan="4">Transmit Statistics</th> </tr> <tr> <th>Client Link</th> <th></th> <th>Bytes</th> <th>Packets</th> <th>Errors</th> <th>Retries</th> <th>Bytes</th> <th>Packets</th> <th>Errors</th> <th>Retries</th> </tr> </thead> <tbody> <tr><td>1</td><td></td><td></td><td></td><td></td><td></td><td></td><td></td><td></td><td></td></tr> <tr><td>2</td><td></td><td></td><td></td><td></td><td></td><td></td><td></td><td></td><td></td></tr> <tr><td>3</td><td></td><td></td><td></td><td></td><td></td><td></td><td></td><td></td><td></td></tr> <tr><td>4</td><td></td><td></td><td></td><td></td><td></td><td></td><td></td><td></td><td></td></tr> </tbody> </table> <table border="1"> <thead> <tr> <th colspan="2"></th> <th colspan="4">Receive Statistics</th> <th colspan="4">Transmit Statistics</th> </tr> <tr> <th>Host Link</th> <th></th> <th>Bytes</th> <th>Packets</th> <th>Errors</th> <th>Retries</th> <th>Bytes</th> <th>Packets</th> <th>Errors</th> <th>Retries</th> </tr> </thead> <tbody> <tr><td>1</td><td></td><td></td><td></td><td></td><td></td><td></td><td></td><td></td><td></td></tr> <tr><td>2</td><td></td><td></td><td></td><td></td><td></td><td></td><td></td><td></td><td></td></tr> <tr><td>3</td><td></td><td></td><td></td><td></td><td></td><td></td><td></td><td></td><td></td></tr> <tr><td>4</td><td></td><td></td><td></td><td></td><td></td><td></td><td></td><td></td><td></td></tr> </tbody> </table>						Receive Statistics				Transmit Statistics				Client Link		Bytes	Packets	Errors	Retries	Bytes	Packets	Errors	Retries	1										2										3										4												Receive Statistics				Transmit Statistics				Host Link		Bytes	Packets	Errors	Retries	Bytes	Packets	Errors	Retries	1										2										3										4									
		Receive Statistics				Transmit Statistics																																																																																																																						
Client Link		Bytes	Packets	Errors	Retries	Bytes	Packets	Errors	Retries																																																																																																																			
1																																																																																																																												
2																																																																																																																												
3																																																																																																																												
4																																																																																																																												
		Receive Statistics				Transmit Statistics																																																																																																																						
Host Link		Bytes	Packets	Errors	Retries	Bytes	Packets	Errors	Retries																																																																																																																			
1																																																																																																																												
2																																																																																																																												
3																																																																																																																												
4																																																																																																																												

Figure 79. WDS Statistics

*See Also*

SSID Management

WDS

### Filter Statistics

The Filter Statistics window provides statistical data for all configured filters. The name, state (enabled—on or off), and type (allow or deny) of each filter is shown. For enabled filters, this window shows the number of packets and bytes that met the filter criteria. Click on a column header to sort the rows based on that column. Click on a filter name to edit the filter settings.

Name	Type	State	Packets	Bytes
Global	Filter1	allow on	1991	268436

Figure 80. Filter Statistics

*See Also*  
Filters

### Station Statistics

This status-only window provides an overview of statistical data for all stations. Stations are listed by MAC address, and Receive and Transmit statistics are summarized for each. For detailed statistics for a specific station, click the desired MAC address in the **Station** column and see “Per-Station Statistics” on page 167.

Station	Receive Statistics by Station				Transmit Statistics by Station			
	Bytes	Packets	Errors	Retries	Bytes	Packets	Errors	Retries
00:0E:3d:03:02:a8	693119	2043	0	223	2368	12	0	1
00:0E:b5:07:3c:79	51442645153	52791337	0	5371975	65480578303	65515091	26764	118569632
00:0e:35:45:d8:e0	1691913717	24210701	0	8748417	168562071943	164832863	112870	104185667
00:30:b4:01:69:c4	1004756270	10171896	0	0	265914094203	259348067	10303	48599772
00:0E:66:19:95:34	1550292533	5009662	0	1202533	36006965880	36032055	309651	41933995
00:03:7E:b6:14:43	197116974748	195875363	0	32942200	277967033447	2668865001	45170	60729663
00:04:a2:8b:42:57	323018216404	312187936	0	29556244	507270199576	492647649	12040	39468662
00:10:18:91:0e:66	181652416042	177651569	0	18383672	264062154829	263394451	170454	36038464
00:40:96:a7:82:b2	24909023768	247980426	0	22610375	276050170214	270423992	18482	127696107

Figure 81. Station Statistics

Note that you can clear the data for an individual station (see *Per-Station Statistics*), but you cannot clear the data for all stations using this window.

You can **Refresh** the data (update the window with the latest information) at any time by clicking on the appropriate button. You can also click in the **Auto Refresh** check box to instruct the Array to refresh this window automatically.

*See Also*

Per-Station Statistics

### Per-Station Statistics

This window provides detailed statistics for the selected station. This window is accessed from the [Station Statistics](#) window—click the MAC address of the desired entry in the **Station** column to display its Per-Station Statistics window.

Receive and Transmit statistics are listed by **Rate**—this is the data rate in Mbps. For a summary of statistics for all stations, see “[Station Statistics](#)” on page 166.

You can **Refresh** the data (update the window with the latest information) or **Clear** the data (reset all content to zero and begin counting again) at any time by clicking on the appropriate button. You can also click in the **Auto Refresh** check box to instruct the Array to refresh this window automatically.

Station Statistics for 00:0f:3d:03:02:e8

Rate	Receive Statistics				Transmit Statistics				
	Bytes	Packets	Errors	Retries	Bytes	Packets	Errors	Retries	
1	1015465	18726	0	0	0	0	0	0	0
2	0	0	0	0	0	0	0	0	0
5.5	0	0	0	0	0	0	0	0	0
11	0	0	0	0	0	0	0	0	0
6	3728543	77325	0	15	0	0	0	0	0
9	0	0	0	0	0	0	0	0	0
12	1710	5	0	3	0	0	0	0	0
18	1726	5	0	2	0	0	0	0	0
24	0	0	0	0	0	0	0	0	0
36	5959	22	0	2	0	0	0	0	0
48	73724	228	0	29	0	0	0	0	0
54	693119	2043	0	223	2358	12	0	1	1
<b>Total</b>	6520246	98354	0	274	2358	12	0	1	1

Clear  Auto Refresh Refresh

Figure 82. Individual Station Statistics Page

*See Also*

Station Statistics

## System Log Window

This is a status only window that allows you to review the system log, where system alerts and messages are displayed. Although there are no configuration options available in this window, you do have the usual choice of deciding how the event messages are sorted by clicking in the column header for the desired field (Time Stamp, Priority, or Message).

- **Time Stamp**—sorts the list based on the time the event occurred.
- **Priority**—sorts the list based on the priority assigned to the message.
- **Message**—sorts the list based on the message category

The displayed messages may be filtered by using the **Filter Priority** option, which allows control of the minimum priority level displayed. For example, you may choose (under **Services >System Log**) to log messages at or above Debug level but use **Filter Priority** to display only those at Information level and above.

Status		Name: SS-XN04290910207 (40.100.47.16)		Uptime: 13 days, 5 hours, 25 mins	
		Clear	Filter Priority: information	Highlight Priority: alert	Auto Refresh Refresh
		Time Stamp	Priority	Message	
Array		Mar 23 21:26:00	alert	Rogue AP detected. SSID: zora1cisco, BSSID: 00:0e:38:28:1d:ab, Manufacturer: Cisco, Channel: 60, RSSI: -68, Security: TKIP+PSK	
Network		Mar 23 21:16:39	alert	Rogue AP detected. SSID: @BSS-Test, BSSID: 00:1e:e5:da:97:3b, Manufacturer: Cisco-Linksys, Channel: 11, RSSI: -60, Security: none	
RF Monitor		Mar 23 20:59:52	alert	Rogue AP detected. SSID: @BSS-Test, BSSID: 00:1f:3b:57:44:7b, Manufacturer: Intel, Channel: 11, RSSI: -63, Security: none	
Stations		Mar 23 18:35:35	alert	129 days left on temporary license key.	
Statistics		Mar 23 17:02:04	alert	Rogue AP detected. SSID: JDI76, BSSID: 00:1f:90:de:8c:6c, Manufacturer: Actiontec, Channel: 1, RSSI: -56, Security: WEP	
System Log		Mar 23 17:00:23	alert	Connectivity reestablished to NTP primary server (72.167.54.201)	
Configuration		Mar 23 16:55:19	alert	Unable to resolve hostname for NTP primary server (ntp.xirus.com)	
Express Setup		Mar 23 13:44:09	alert	Rogue AP detected. SSID: Coastal Express Free Internet, BSSID: 00:1d:7e:2f:6e:b1, Manufacturer: Cisco-Linksys, Channel: 6, RSSI: -48, Security: none	
Network		Mar 22 23:47:11	alert	Rogue AP detected. SSID: CAR01, BSSID: 00:13:10:bc:bd:6a, Manufacturer: Cisco-Linksys, Channel: 1, RSSI: -53, Security: AES+TKIP+PSK	
Services		Mar 22 23:18:30	alert	Connectivity reestablished to NTP primary server (75.144.70.35)	
VLANs		Mar 22 23:13:30	alert	Connectivity lost to NTP primary server (173.8.198.243)	
Security		Mar 22 23:11:04	alert	Rogue AP detected. SSID: CAR01b, BSSID: 00:16:b6:f5:24:1b, Manufacturer: Cisco-Linksys, Channel: 6, RSSI: -50, Security: AES+PSK	
SSIDs		Mar 22 18:35:35	alert	130 days left on temporary license key.	
Groups		Mar 21 18:35:35	alert	131 days left on temporary license key.	
IAPs		Mar 20 18:35:35	alert	132 days left on temporary license key.	
WDS		Mar 19 18:35:35	alert	133 days left on temporary license key.	
Filters		Mar 18 23:05:44	alert	Connectivity reestablished to NTP primary server (76.115.74.67)	
Clusters		Mar 18 23:00:44	alert	Connectivity lost to NTP primary server (63.240.161.99)	
Tools		Mar 23 19:47:34	information	Station 00:26:ba:8b:29:e3, IAP abgn4: association timed out	
System Tools		Mar 23 19:47:34	information	Station 00:26:ba:8b:29:e3, IAP abgn4: deauthenticated, reason: Authentication no longer valid	
CLI		Mar 23 19:42:09	information	Station 00:26:ba:8b:29:e3, IAP abgn4: associated, SSID: xirus	
Options					
Logout					
Log Messages					

Figure 83. System Log

Use the **Highlight Priority** field if you wish to highlight messages at the selected priority level. Click on the **Refresh** button to refresh the message list, or click on the **Clear** button at the upper left to delete all messages. You can also click in the **Auto Refresh** check box to instruct the Array to refresh this window automatically.

Note that there is a shortcut way to view system log messages. If you click **Log Messages** near the bottom of the left hand frame, WMI displays counts of log messages at different severity levels. Click a count to display just those messages in the System Log window. See [Figure 42 on page 117](#) for more information.

