



Wi-Fi Arrays

June 10, 2008



Wi-Fi Array™

XN16, XN8, XN4

All rights reserved. This document may not be reproduced or disclosed in whole or in part by any means without the written consent of Xirrus, Inc.



Trademarks

XIRRUS is a registered trademark of Xirrus, Inc. All other trademarks and brand names are marks of their respective holders.

Notices

FCC Notice

This equipment has been tested and found to comply with the limits for a Class B digital device, pursuant to part 15 of the FCC Rules. These limits are designed to provide reasonable protection against harmful interference in a residential installation. This equipment generates, uses, and can radiate radio frequency energy and if not installed and used in accordance with the instructions, may cause harmful interference to radio communications. However, there is no guarantee that interference will not occur in a particular installation.

If this equipment does cause harmful interference to radio or television reception, which can be determined by turning the equipment off and on, you are encouraged to try to correct the interference by one or more of the following measures:

- Reorient or relocate the receiving antenna.
- Increase the separation between the equipment and the receiver.
- Consult the dealer or an experienced wireless technician for help.

Use of a shielded twisted pair (STP) cable must be used for all Ethernet connections in order to comply with EMC requirements.

RF Radiation Hazard Warning

To ensure compliance with FCC RF exposure requirements, this device must be installed in a location where the antennas of the device will have a minimum distance of at least 25 cm (9.84 inches) from all persons. Using higher gain antennas and types of antennas not certified for use with this product is not allowed. The device shall not be co-located with another transmitter.

Non-Modification Statement

Unauthorized changes or modifications to the device are not permitted. Use only the supplied internal antenna, or external antennas supplied by the manufacturer. Modifications to the device will void the warranty and may violate FCC regulations. Please go to the Xirrus Web site for a list of all approved antennas.

Indoor Use

This product has been designed for indoor use. Operation of channels in the 5150MHz to 5250MHz band is permitted indoors only to reduce the potential for harmful interference to co-channel mobile satellite systems.

Cable Runs for Power over Gigabit Ethernet (PoGE)

If using PoGE, the Array must be connected to PoGE networks without routing cabling to the outside plant—this ensures that cabling is not exposed to lightning strikes or possible cross over from high voltage.

Battery Warning

Caution! The Array contains a battery which is not to be replaced by the customer. Danger of Explosion exists if the battery is incorrectly replaced. Replace only with the same or equivalent type recommended by the manufacturer. Dispose of used batteries according to the manufacturer's instructions.

Power Cord

If you will be using the Array with a power cord, you must use a UL-Approved cord. Order the power cord from the Xirrus product list—Xirrus supplies only UL-approved power cords.

Maximum Antenna Gain

Currently, the maximum antenna gain for external antennas is limited to 2.5dBi for operation in the 5150MHz to 5250MHz and 5725MHz to 5825MHz bands. The antenna gains must not exceed maximum EIRP limits set by the FCC / Industry Canada.

High Power Radars

High power radars are allocated as primary users (meaning they have priority) in the 5150MHz to 5250MHz and 5725 MHz to 5825MHz bands. These radars could cause interference and/or damage to LELAN devices used in Canada.

Industry Canada Notice and Marking

This Class A digital apparatus complies with Canadian ICES-003.

Cet appareil numérique de la classe A est conforme à la norme NMB-003 du Canada.

The term "IC:" before the radio certification number only signifies that Industry Canada technical specifications were met.

To reduce potential radio interference to other users, the antenna type and its gain should be so chosen that the equivalent isotropically radiated power (EIRP) is not more than that required for successful communication.

EU Directive 1999/5/EC Compliance Information

This section contains compliance information for the Xirrus Wi-Fi Array family of products, which includes the XN16, XN8, and XN4. The compliance information contained in this section is relevant to the European Union and other countries that have implemented the EU Directive 1999/5/EC.

Declaration of Conformity

- Cesky [Czech]** Toto zahzení je v souladu se základními požadavky a ostatními odpovídajícími ustanoveními Směrnice 1999/5/EC.
- Dansk [Danish]** Dette udstyr er i overensstemmelse med de væsentlige krav og andre relevante bestemmelser i Direktiv 1999/5/EF.
- Deutsch [German]** Dieses Gerät entspricht den grundlegenden Anforderungen und den weiteren entsprechenden Vorgaben der Richtlinie 1999/5/EU.
- Eesti [Estonian]** See seande vastab direktiivi 1999/5/EU olulistele nõuetele ja teistele asjakohastele sätetele.
- English** This equipment is in compliance with the essential requirements and other relevant provisions of Directive 1999/5/EC.
- Español [Spain]** Este equipo cumple con los requisitos esenciales así como con otras disposiciones de la Directiva 1999/5/CE.
- Ελληνικη [Greek]** Αυτός ο εξοπλισμός είναι σε συμμόρφωση με τις ουσιώδεις απαιτήσεις και ύλλες σχετικές διατάξεις της Οδηγίας 1999/5/EC.
- Français [French]** Cet appareil est conforme aux exigences essentielles et aux autres dispositions pertinentes de la Directive 1999/5/EC.
- Íslenska [Icelandic]** Þetta tæki er samkvæmt grunnkröfum og öðrum viðeigandi ákvæðum Tilskipunar 1999/5/EC.

- Italiano [Italian]** Questo apparato é conforme ai requisiti essenziali ed agli altri principi sanciti dalla Direttiva 1999/5/CE.
- Latviski [Latvian]** Šī iekārta atbilst Direktīvas 1999/5/EK būtiskajā prasībām un citiem ar to saistītajiem noteikumiem.
- Lietuvių [Lithuanian]** Šis įrenginys tenkina 1995/5/EB Direktyvos esminius reikalavimus ir kitas šios direktyvos nuostatas.
- Nederlands [Dutch]** Dit apparant voldoet aan de essentiële eisen en andere van toepassing zijnde bepalingen van de Richtlijn 1995/5/EC.
- Malti [Maltese]** Dan l-apparant huwa konformi mal-htigiet essenzjali u l-provedimenti l-oħra rilevanti tad-Direttiva 1999/5/EC.
- Magyar [Hungarian]** Ez a készülék teljesíti az alapvető követelményeket és más 1999/5/EK irányelvben meghatározott vonatkozó rendelkezéseket.
- Norsk [Norwegian]** Dette utstyret er i samsvar med de grunnleggende krav og andre relevante bestemmelser i EU-direktiv 1999/5/EF.
- Polski [Polish]** Urządzenie jest zgodne z ogólnymi wymaganiami oraz szczególnymi mi warunkami określony mi Dyrektywą. UE:1999/5/EC.
- Português [Portugese]** Este equipamento está em conformidade com os requisitos essenciais e outras provisões relevantes da Directiva 1999/5/EC.
- Slovensko [Slovenian]** Ta naprava je skladna z bistvenimi zahtevami in ostalimi relevantnimi popoji Direktive 1999/5/EC.
- Slovensky [Slovak]** Toto zariadenie je v zhode so základnými požiadavkami a inými príslušnými nariadeniami direktiv: 1999/5/EC.

Suomi [Finnish] Tämä laite täyttää direktiivin 1999/5//EY olennaiset vaatimukset ja on siinä asetettujen muiden laitetta koskevien määräysten mukainen.

Svenska [Swedish] Denna utrustning är i överensstämmelse med de väsentliga kraven och andra relevanta bestämmelser i Direktiv 1999/5/EC.

Assessment Criteria

The following standards were applied during the assessment of the product against the requirements of the Directive 1999/5/EC:

- Radio: EN 301 893 and EN 300 328 (if applicable)
- EMC: EN 301 489-1 and EN 301 489-17
- Safety: EN 50371 to EN 50385 and EN 60601

CE Marking

For the Xirrus Wi-Fi Array (XN16, XN8, XN4), the CE mark and Class-2 identifier opposite are affixed to the equipment and its packaging:



WEEE Compliance



- Natural resources were used in the production of this equipment.
- This equipment may contain hazardous substances that could impact the health of the environment.
- In order to avoid harm to the environment and consumption of natural resources, we encourage you to use appropriate take-back systems when disposing of this equipment.
- The appropriate take-back systems will reuse or recycle most of the materials of this equipment in a way that will not harm the environment.
- The crossed-out wheeled bin symbol (in accordance with European Standard EN 50419) invites you to use those take-back systems and advises you not to combine the material with refuse destined for a land fill.
- If you need more information on collection, re-use and recycling systems, please contact your local or regional waste administration.
- Please contact Xirrus for specific information on the environmental performance of our

National Restrictions

In the majority of the EU and other European countries, the 2.4 GHz and 5 GHz bands have been made available for the use of Wireless LANs. The following table provides an overview of the regulatory requirements in general that are applicable for the 2.4 GHz and 5 GHz bands.

Frequency Band (MHz)	Max Power Level (EIRP) (mW)	Indoor	Outdoor
2400–2483.5	100	X	X**
5150–5250*	200	X	N/A
5470–5725*	1000	X	X

**Dynamic frequency selection and Transmit Power Control is required in these frequency bands.*

***France is indoor use only in the upper end of the band.*

The requirements for any country may change at any time. Xirrus recommends that you check with local authorities for the current status of their national regulations for both 2.4 GHz and 5 GHz wireless LANs.

The following countries have additional requirements or restrictions than those listed in the above table:

Belgium

The Belgian Institute for Postal Services and Telecommunications (BIPT) must be notified of any outdoor wireless link having a range exceeding 300 meters. Xirrus recommends checking at www.bipt.be for more details.

Draadloze verbindingen voor buitengebruik en met een reikwijdte van meer dan 300 meter dienen aangemeld te worden bij het Belgisch Instituut voor postdiensten en telecommunicatie (BIPT). Zie www.bipt.be voor meer gegevens.

Les liaisons sans fil pour une utilisation en extérieur d'une distance supérieure à 300 mètres doivent être notifiées à l'Institut Belge des services Postaux et des Télécommunications (IBPT). Visitez www.bipt.be pour de plus amples détails.

Greece

A license from EETT is required for the outdoor operation in the 5470 MHz to 5725 MHz band. Xirrus recommends checking www.eett.gr for more details.

Η δη ιοργβιάκτ ωνεζωτερικο ρουστη ζ νησν νοτ των 5470–5725 MHz ε ιτρ ετάιωνο ετάά όάδειά της EETT, ου ορηγεβτάι στερά ά ό σ φωνη γν η του ΓΕΕΘΑ. ερισσότερες λε τομ ρειεωστο www.eett.gr

Italy

This product meets the National Radio Interface and the requirements specified in the National Frequency Allocation Table for Italy. Unless this wireless LAN product is operating within the boundaries of the owner's property, its use requires a "general authorization." Please check with www.comunicazioni.it/it/ for more details.

Questo prodotto é conforme alla specifiche di Interfaccia Radio Nazionali e rispetta il Piano Nazionale di ripartizione delle frequenze in Italia. Se non viene installato all'interno del proprio fondo, l'utilizzo di prodotti wireless LAN richiede una "autorizzazione Generale." Consultare www.comunicazioni.it/it/ per maggiori dettagli.

Norway, Switzerland and Liechtenstein

Although Norway, Switzerland and Liechtenstein are not EU member states, the EU Directive 1999/5/EC has also been implemented in those countries.

Calculating the Maximum Output Power

The regulatory limits for maximum output power are specified in EIRP (radiated power). The EIRP level of a device can be calculated by adding the gain of the antenna used (specified in dBi) to the output power available at the connector (specified in dBm).

Antennas

The Xirrus Wi-Fi Array employs integrated antennas that cannot be removed and which are not user accessible. Nevertheless, as regulatory limits are not the same throughout the EU, users may need to adjust the conducted power setting for the radio to meet the EIRP limits applicable in their country or region. Adjustments can be made from the product's management interface—either Web Management Interface (WMI) or Command Line Interface (CLI).

Operating Frequency

The operating frequency in a wireless LAN is determined by the access point. As such, it is important that the access point is correctly configured to meet the local regulations. See [National Restrictions](#) in this section for more information.

If you still have questions regarding the compliance of Xirrus products or you cannot find the information you are looking for, please contact us at:

Xirrus, Inc.
370 North Westlake Blvd, Suite 200
Westlake Village, CA 91362
USA

Tel: 1.805.497.0955

Fax: 1.805.449.1180

www.xirrus.com

Safety Warnings

- ! **Safety Warnings**
Read all user documentation before powering this device. All Xirrus interconnected equipment should be contained indoors. This product is not suitable for outdoor operation. Please verify the integrity of the system ground prior to installing Xirrus equipment. Additionally, verify that the ambient operating temperature does not exceed 50°C.
- ! **Explosive Device Proximity Warning**
Do not operate the XN16/XN8/XN4 unit near unshielded blasting caps or in an explosive environment unless the device has been modified to be especially qualified for such use.
- ! **Lightning Activity Warning**
Do not work on the XN16/XN8/XN4 or connect or disconnect cables during periods of lightning activity.
- ! **Circuit Breaker Warning**
The XN16/XN8/XN4 relies on the building's installation for over current protection. Ensure that a fuse or circuit breaker no larger than 120 VAC, 15A (U.S.) or 240 VAC, 10A (International) is used on all current-carrying conductors.

Translated safety warnings appear on the following page.

Translated Safety Warnings

Avertissements de Sécurité

Sécurité

- Lisez l'ensemble de la documentation utilisateur avant de mettre cet appareil sous tension. Tous les équipements Xirrus interconnectés doivent être installés en intérieur. Ce produit n'est pas conçu pour être utilisé en extérieur. Veuillez vérifier l'intégrité de la terre du système avant d'installer des équipements Xirrus. Vérifiez également que la température de fonctionnement ambiante n'excède pas 50°C.

Proximité d'appareils explosifs

- N'utilisez pas l'unité XN16/XN8/XN4 à proximité d'amorces non blindées ou dans un environnement explosif, à moins que l'appareil n'ait été spécifiquement modifié pour un tel usage.

Foudre

- N'utilisez pas l'unité XN16/XN8/XN4 et ne branchez pas ou ne débranchez pas de câbles en cas de foudre.

Disjoncteur

- L'unité XN16/XN8/XN4 dépend de l'installation du bâtiment pour ce qui est de la protection contre les surintensités. Assurez-vous qu'un fusible ou qu'un disjoncteur de 120 Vca, 15 A (États-Unis) ou de 240 Vca, 10 A (International) maximum est utilisé sur tous les conducteurs de courant.

Software Warranty and License Agreement

THIS SOFTWARE LICENSE AGREEMENT (THE "AGREEMENT") IS A LEGAL AGREEMENT BETWEEN YOU ("CUSTOMER") AND LICENSOR (AS DEFINED BELOW) AND GOVERNS THE USE OF THE SOFTWARE INSTALLED ON THE PRODUCT (AS DEFINED BELOW). IF YOU ARE AN EMPLOYEE OR AGENT OF CUSTOMER, YOU HEREBY REPRESENT AND WARRANT TO LICENSOR THAT YOU HAVE THE POWER AND AUTHORITY TO ACCEPT AND TO BIND CUSTOMER TO THE TERMS AND CONDITIONS OF THIS AGREEMENT (INCLUDING ANY THIRD PARTY TERMS SET FORTH HEREIN). IF YOU DO NOT AGREE TO ALL OF THE TERMS OF THIS AGREEMENT RETURN THE PRODUCT AND ALL ACCOMPANYING MATERIALS (INCLUDING ALL DOCUMENTATION) TO THE RELEVANT VENDOR FOR A FULL REFUND OF THE PURCHASE PRICE THEREFOR.

CUSTOMER UNDERSTANDS AND AGREES THAT USE OF THE SOFTWARE SHALL BE DEEMED AN AGREEMENT TO THE TERMS AND CONDITIONS GOVERNING SUCH SOFTWARE AND THAT CUSTOMER IS BOUND BY AND BECOMES A PARTY TO THIS AGREEMENT.

1. Definitions

- 1.1 "Documentation" means the user manuals and all other all documentation, instructions or other similar materials accompanying the Software covering the installation, application, and use thereof.
- 1.2 "Licensor" means XIRRUS and its suppliers.
- 1.3 "Product" means a multi-radio access point containing four or more distinct radios capable of simultaneous operation on four or more non-overlapping channels.
- 1.4 "Software" means, collectively, each of the application and embedded software programs delivered to Customer in connection with this Agreement. For purposes of this Agreement, the term Software shall be deemed to include any and all Documentation and Updates provided with or for the Software.
- 1.5 "Updates" means any bug-fix, maintenance or version release to the Software that may be provided to Customer from Licensor pursuant to this Agreement or pursuant to any separate maintenance and support agreement entered into by and between Licensor and Customer.

2. Grant of Rights

- 2.1 **Software.** Subject to the terms and conditions of this Agreement, Licensor hereby grants to Customer a perpetual, non-exclusive, non-sublicenseable, non-transferable right and license to use the Software solely as installed on the Product in accordance with the accompanying Documentation and for no other purpose.
- 2.2 **Ownership.** The license granted under Sections 2.1 above with respect to the Software does not constitute a transfer or sale of Licensor's or its suppliers' ownership interest in or to the Software, which is solely licensed to Customer. The Software is protected by both national and international intellectual property laws and treaties. Except for the express licenses granted to the Software, Licensor and its suppliers retain all rights, title and interest in and to the Software, including (i) any and all trade secrets, copyrights, patents and other proprietary rights therein or thereto or (ii) any Marks (as defined in Section 2.3 below) used in connection therewith. In no event shall Customer remove, efface or otherwise obscure any Marks contained on or in the Software. All rights not expressly granted herein are reserved by Licensor.
- 2.3 **Copies.** Customer shall not make any copies of the Software but shall be permitted to make a reasonable number of copies of the related Documentation. Whenever Customer copies or reproduces all or any part of the Documentation, Customer shall reproduce all and not efface any titles, trademark symbols, copyright symbols and legends, and other proprietary markings or similar indicia of origin ("Marks") on or in the Documentation.

2.4 **Restrictions.** Customer shall not itself, or through any parent, subsidiary, affiliate, agent or other third party (i) sell, rent, lease, license or sublicense, assign or otherwise transfer the Software, or any of Customer's rights and obligations under this Agreement except as expressly permitted herein; (ii) decompile, disassemble, or reverse engineer the Software, in whole or in part, provided that in those jurisdictions in which a total prohibition on any reverse engineering is prohibited as a matter of law and such prohibition is not cured by the fact that this Agreement is subject to the laws of the State of California, Licensor agrees to grant Customer, upon Customer's written request to Licensor, a limited reverse engineering license to permit interoperability of the Software with other software or code used by Customer; (iii) allow access to the Software by any user other than by Customer's employees and contractors who are bound in writing to confidentiality and non-use restrictions at least as protective as those set forth herein; (iv) except as expressly set forth herein, write or develop any derivative software or any other software program based upon the Software; or (v) use any computer software or hardware which is designated to defeat any copy protection or other use limiting device, including any device intended to limit the number of users or devices accessing the Product.

3. **Limited Warranty and Limitation of Liability**

3.1 **Limited Warranty & Exclusions.** Licensor warrants that the Software will perform in substantial accordance with the specifications therefor set forth in the Documentation for a period of ninety [90] days after Customer's acceptance of the terms of this Agreement with respect to the Software ("Warranty Period"). If during the Warranty Period the Software does not perform as warranted, Licensor shall, at its option, correct the relevant Software giving rise to such breach of performance or replace such Software free of charge. THE FOREGOING ARE CUSTOMER'S SOLE AND EXCLUSIVE REMEDIES FOR BREACH OF THE FOREGOING WARRANTY. THE WARRANTY SET FORTH ABOVE IS MADE TO AND FOR THE BENEFIT OF CUSTOMER ONLY. The warranty will apply only if (i) the Software has been used at all times and in accordance with the instructions for use set forth in the Documentation and this Agreement; (ii) no modification, alteration or addition has been made to the Software by persons other than Licensor or Licensor's authorized representative; and (iii) the Software or Product on which the Software is installed has not been subject to any unusual electrical charge.

3.2 **DISCLAIMER.** EXCEPT AS EXPRESSLY STATED IN THIS SECTION 3, ALL ADDITIONAL CONDITIONS, REPRESENTATIONS, AND WARRANTIES, WHETHER IMPLIED, STATUTORY OR OTHERWISE, INCLUDING, WITHOUT LIMITATION, ANY IMPLIED WARRANTIES OR CONDITIONS OF MERCHANTABILITY, FITNESS FOR A PARTICULAR PURPOSE, SATISFACTORY QUALITY, ACCURACY, AGAINST INFRINGEMENT OR ARISING FROM A COURSE OF DEALING, USAGE, OR TRADE PRACTICE, ARE HEREBY DISCLAIMED BY LICENSOR AND ITS SUPPLIERS. THIS DISCLAIMER SHALL APPLY EVEN IF ANY EXPRESS WARRANTY AND LIMITED REMEDY OFFERED BY LICENSOR FAILS OF ITS ESSENTIAL PURPOSE. ALL WARRANTIES PROVIDED BY LICENSOR ARE SUBJECT TO THE LIMITATIONS OF LIABILITY SET FORTH IN THIS AGREEMENT.

3.3 **HAZARDOUS APPLICATIONS.** THE SOFTWARE IS NOT DESIGNED OR INTENDED FOR USE IN HAZARDOUS ENVIRONMENTS REQUIRING FAIL SAFE PERFORMANCE, SUCH AS IN THE OPERATION OF A NUCLEAR FACILITY, AIRCRAFT NAVIGATION OR COMMUNICATIONS SYSTEMS, AIR TRAFFIC CONTROLS OR OTHER DEVICES OR SYSTEMS IN WHICH A MALFUNCTION OF THE SOFTWARE WOULD RESULT IN FORESEEABLE RISK OF INJURY OR DEATH TO THE OPERATOR OF THE DEVICE OR SYSTEM OR TO OTHERS ("HAZARDOUS APPLICATIONS"). CUSTOMER ASSUMES ANY AND ALL RISKS, INJURIES, LOSSES, CLAIMS AND ANY OTHER LIABILITIES ARISING OUT OF THE USE OF THE SOFTWARE IN ANY HAZARDOUS APPLICATIONS.

3.4 **Limitation of Liability.**

(a) **TOTAL LIABILITY.** NOTWITHSTANDING ANYTHING ELSE HEREIN, ALL LIABILITY OF LICENSOR AND ITS SUPPLIERS UNDER THIS AGREEMENT SHALL BE LIMITED TO THE AMOUNT PAID BY CUSTOMER FOR THE RELEVANT SOFTWARE, OR PORTION THEREOF, THAT GAVE RISE TO SUCH LIABILITY OR ONE HUNDRED UNITED STATES DOLLARS (US\$100), WHICHEVER IS GREATER. THE LIABILITY OF LICENSOR AND ITS SUPPLIERS UNDER THIS SECTION SHALL BE CUMULATIVE AND NOT PER INCIDENT.

(b) **DAMAGES.** IN NO EVENT SHALL LICENSOR, ITS SUPPLIERS OR THEIR RELEVANT SUBCONTRACTORS BE LIABLE FOR (A) ANY INCIDENTAL, SPECIAL, PUNITIVE OR CONSEQUENTIAL DAMAGES, LOST PROFITS OR LOST OR DAMAGED DATA, OR ANY INDIRECT DAMAGES, WHETHER ARISING IN CONTRACT, TORT (INCLUDING NEGLIGENCE AND STRICT LIABILITY) OR OTHERWISE OR (B) ANY COSTS OR EXPENSES FOR THE PROCUREMENT OF SUBSTITUTE GOODS OR SERVICES IN EACH CASE, EVEN IF LICENSOR OR ITS SUPPLIERS HAVE BEEN INFORMED OF THE POSSIBILITY OF SUCH DAMAGES.

3.5 **Exclusions.** SOME JURISDICTIONS DO NOT PERMIT THE LIMITATIONS OF LIABILITY AND LIMITED WARRANTIES SET FORTH UNDER THIS AGREEMENT. IN THE EVENT YOU ARE LOCATED IN ANY SUCH JURISDICTION, THE FOREGOING LIMITATIONS SHALL APPLY ONLY TO THE MAXIMUM EXTENT PERMITTED IN SUCH JURISDICTIONS. IN NO EVENT SHALL THE FOREGOING EXCLUSIONS AND LIMITATIONS ON DAMAGES BE DEEMED TO APPLY TO ANY LIABILITY BASED ON FRAUD, WILLFUL MISCONDUCT, GROSS NEGLIGENCE OR PERSONAL INJURY OR DEATH.

4. Confidential Information

4.1 **Generally.** The Software (and its accompanying Documentation) constitutes Licensor's and its suppliers' proprietary and confidential information and contains valuable trade secrets of Licensor and its suppliers ("Confidential Information"). Customer shall protect the secrecy of the Confidential Information to the same extent it protects its other valuable, proprietary and confidential information of a similar nature but in no event shall Customer use less than reasonable care to maintain the secrecy of the Confidential Information. Customer shall not use the Confidential Information except to exercise its rights or perform its obligations as set forth under this Agreement. Customer shall not disclose such Confidential Information to any third party other than subject to non-use and non-disclosure obligations at least as protective of a party's right in such Confidential Information as those set forth herein.

4.2 **Return of Materials.** Customer agrees to (i) destroy all Confidential Information (including deleting any and all copies contained on any of Customer's Designated Hardware or the Product) within fifteen (15) days of the date of termination of this Agreement or (ii) if requested by Licensor, return, any Confidential Information to Licensor within thirty (30) days of Licensor's written request.

5. Term and Termination

5.1 **Term.** Subject to Section 5.2 below, this Agreement will take effect on the Effective Date and will remain in force until terminated in accordance with this Agreement.

5.2 **Termination Events.** This Agreement may be terminated immediately upon written notice by either party under any of the following conditions:

- (a) If the other party has failed to cure a breach of any material term or condition under the Agreement within thirty (30) days after receipt of notice from the other party; or
- (b) Either party ceases to carry on business as a going concern, either party becomes the object of the institution of voluntary or involuntary proceedings in bankruptcy or liquidation, which proceeding is not dismissed within ninety (90) days, or a receiver is appointed with respect to a substantial part of its assets.

5.3 **Effect of Termination.**

- (a) Upon termination of this Agreement, in whole or in part, Customer shall pay Licensor for all amounts owed up to the effective date of termination. Termination of this Agreement shall not constitute a waiver for any amounts due.
- (b) The following Sections shall survive the termination of this Agreement for any reason: Sections 1, 2.2, 2.4, 3, 4, 5.3, and 6.
- (c) No later than thirty (30) days after the date of termination of this Agreement by Licensor, Customer shall upon Licensor's instructions either return the Software and all copies thereof; all Documentation relating thereto in its possession that is in tangible form or destroy the same (including any copies thereof contained on Customer's Designated Hardware). Customer shall furnish Licensor with a certificate signed by an executive officer of Customer verifying that the same has been done.

6. Miscellaneous

If Customer is a corporation, partnership or similar entity, then the license to the Software and Documentation that is granted under this Agreement is expressly conditioned upon and Customer represents and warrants to Licensor that the person accepting the terms of this Agreement is authorized to bind such entity to the terms and conditions herein. If any provision of this Agreement is held to be invalid or unenforceable, it will be enforced to the extent permissible and the remainder of this Agreement will remain in full force and effect. During the course of use of the Software, Licensor may collect information on your use thereof; you hereby authorize Licensor to use such information to improve its products and services, and to disclose the same to third parties provided it does not contain any personally identifiable information. The express waiver by either party of any provision, condition or requirement of this Agreement does not constitute a waiver of any future obligation to comply with such provision, condition or requirement. Customer and Licensor are independent parties. Customer may not export or re-export the Software or Documentation (or other materials) without appropriate United States, European Union and foreign government licenses or in violation of the United State's Export Administration Act or foreign equivalents and Customer shall comply with all national and international laws governing the Software. This Agreement will be governed by and construed under the laws of the State of California and the United States as applied to agreements entered into and to be performed entirely within California, without regard to conflicts of laws provisions thereof and the parties expressly exclude the application of the United Nations Convention on Contracts for the International Sales of Goods and the Uniform Computer Information Transactions Act (as promulgated by any State) to this Agreement. Suits or enforcement actions must be brought within, and each party irrevocably commits to the exclusive jurisdiction of, the state and federal courts located in Ventura County, California. Customer may not assign this Agreement by operation of law or otherwise, without the prior written consent of Licensor and any attempted assignment in violation of the foregoing shall be null and void. This Agreement cancels and supersedes all prior agreements between the parties. This Agreement may not be varied except through a document agreed to and signed by both parties. Any printed terms and conditions contained in any Customer purchase order or in any Licensor acknowledgment, invoice or other documentation relating to the Software shall be deemed deleted and of no force or effect and any additional typed and/or written terms and conditions contained shall be for administrative purposes only, i.e. to identify the types and quantities of Software to be supplied, line item prices and total price, delivery schedule, and other similar ordering data, all in accordance with the provisions of this Agreement.

Hardware Warranty Agreement

PLEASE READ THIS AGREEMENT CAREFULLY BEFORE USING THIS PRODUCT

BY USING THIS PRODUCT, YOU ACKNOWLEDGE THAT YOU HAVE READ AND UNDERSTOOD ALL THE TERMS AND CONDITIONS OF THIS AGREEMENT AND THAT YOU ARE CONSENTING TO BE BOUND BY THIS AGREEMENT. IF YOU DO NOT AGREE TO ALL OF THE TERMS OF THIS AGREEMENT, RETURN THE UNUSED PRODUCT TO THE PLACE OF PURCHASE FOR A FULL REFUND.

LIMITED WARRANTY. Xirrus warrants that for a period of one year from the date of purchase by the original purchaser ("Customer"): (i) the Xirrus Equipment ("Equipment") will be free of defects in materials and workmanship under normal use; and (ii) the Equipment substantially conforms to its published specifications. Except for the foregoing, the Equipment is provided AS IS. This limited warranty extends only to Customer as the original purchaser. Customer's exclusive remedy and the entire liability of Xirrus and its suppliers under this limited warranty will be, at Xirrus' option, repair, replacement, or refund of the Equipment if reported (or, upon request, returned) to the party supplying the Equipment to Customer. In no event does Xirrus warrant that the Equipment is error free or that Customer will be able to operate the Equipment without problems or interruptions.

This warranty does not apply if the Equipment (a) has been altered, except by Xirrus, (b) has not been installed, operated, repaired, or maintained in accordance with instructions supplied by Xirrus, (c) has been subjected to abnormal physical or electrical stress, misuse, negligence, or accident, or (d) is used in ultra-hazardous activities.

DISCLAIMER. EXCEPT AS SPECIFIED IN THIS WARRANTY, ALL EXPRESS OR IMPLIED CONDITIONS, REPRESENTATIONS, AND WARRANTIES INCLUDING, WITHOUT LIMITATION, ANY IMPLIED WARRANTY OF MERCHANTABILITY, FITNESS FOR A PARTICULAR PURPOSE, NONINFRINGEMENT OR ARISING FROM A COURSE OF DEALING, USAGE, OR TRADE PRACTICE, ARE HEREBY EXCLUDED TO THE EXTENT ALLOWED BY APPLICABLE LAW.

IN NO EVENT WILL XIRRUS OR ITS SUPPLIERS BE LIABLE FOR ANY LOST REVENUE, PROFIT, OR DATA, OR FOR SPECIAL, INDIRECT, CONSEQUENTIAL, INCIDENTAL, OR PUNITIVE DAMAGES HOWEVER CAUSED AND REGARDLESS OF THE THEORY OF LIABILITY ARISING OUT OF THE USE OF OR INABILITY TO USE THE EQUIPMENT EVEN IF XIRRUS OR ITS SUPPLIERS HAVE BEEN ADVISED OF THE POSSIBILITY OF SUCH DAMAGES. In no event shall Xirrus' or its suppliers' liability to Customer, whether in contract, tort (including negligence), or otherwise, exceed the price paid by Customer.

The foregoing limitations shall apply even if the above-stated warranty fails of its essential purpose. SOME STATES DO NOT ALLOW LIMITATION OR EXCLUSION OF LIABILITY FOR CONSEQUENTIAL OR INCIDENTAL DAMAGES.

The above warranty DOES NOT apply to any evaluation Equipment made available for testing or demonstration purposes. All such Equipment is provided AS IS without any warranty whatsoever.

Customer agrees the Equipment and related documentation shall not be used in life support systems, human implantation, nuclear facilities or systems or any other application where failure could lead to a loss of life or catastrophic property damage, or cause or permit any third party to do any of the foregoing.

All information or feedback provided by Customer to Xirrus with respect to the Product shall be Xirrus' property and deemed confidential information of Xirrus.

Equipment including technical data, is subject to U.S. export control laws, including the U.S. Export Administration Act and its associated regulations, and may be subject to export or import regulations in other countries. Customer agrees to comply strictly with all such regulations and acknowledges that it has the responsibility to obtain licenses to export, re-export, or import Equipment.

This Agreement shall be governed by and construed in accordance with the laws of the State of California, United States of America, as if performed wholly within the state and without giving effect to the principles of conflict of law. If any portion hereof is found to be void or unenforceable, the remaining provisions of this Warranty shall remain in full force and effect. This Warranty constitutes the entire agreement between the parties with respect to the use of the Equipment.

Manufacturer is Xirrus, Inc. 370 North Westlake Blvd #200 Westlake Village, CA 91362.

Table of Contents

All topics listed in this Table of Contents are clickable, which means you can instantly jump to any selected topic with a click of your mouse button. Items that do not appear in the TOC list—they are part of the Front Matter, prior to this Table of Contents—include the following:

- **Trademarks**
- **Notices**
- **EU Directive 1999/5/EC Compliance Information**
- **Safety Warnings**
- **Translated Safety Warnings**
- **Software Warranty and License Agreement**
- **Hardware Warranty Agreement**

List of Figures	xi
Introduction	1
The Xirrus Family of Products	1
Nomenclature	3
About this User’s Guide	3
Organization	3
Notes and Cautions	5
Screen Images	5
Your User’s Guide as a PDF Document	5
Hyperlinks	5
Window or Page?	5
Why Choose the Xirrus Wi-Fi Array?	6
Wi-Fi Array Product Overview	7
Enterprise Class Security	7
Wi-Fi Array Product Family	8
Deployment Flexibility	9
Power over Gigabit Ethernet (PoGE) (Optional)	10
Enterprise Class Management	11

Key Features and Benefits	13
High Capacity and High Performance	13
Extended Coverage	14
Flexible Coverage Schemes	14
Non-Overlapping Channels	15
Secure Wireless Access	15
Applications Enablement	15
SDMA Optimization	15
Fast Roaming	15
Easy Deployment	15
Product Specifications (XN16 and XN8)	16
Product Specifications (XN4)	21
Installing the Wi-Fi Array	27
Installation Prerequisites	27
Optional Network Components	29
Client Requirements	29
Planning Your Installation	30
General Deployment Considerations	30
Coverage and Capacity Planning	32
Placement	32
RF Patterns	33
Capacity and Cell Sizes	34
Fine Tuning Cell Sizes	35
Roaming Considerations	36
Allocating Channels	36
Deployment Examples	38
Failover Planning	40
Port Failover Protection	40
Switch Failover Protection	41
Power Planning	42
AC Power	42
Power over Gigabit Ethernet	42
Security Planning	42
Wireless Encryption	42
Authentication	43
Network Management Planning	45

WDS Planning	46
Deployment Summary	48
Installation Workflow	49
Unpacking the Wi-Fi Array	50
Installing Your Wi-Fi Array	52
Choosing a Location	52
Wiring Considerations	53
Mounting the Array on a Ceiling	54
Attaching the T-Bar Clips to the Template	55
Secure the T-Bar Clips to the Ceiling Support Grid	55
Installing the Mounting Plate	57
Connecting the Cables	58
Attaching the Array to the Mounting Plate (XN16/XN8/XN4)	59
Securing the Array	60
Dismounting the Array	61
Mounting the Array on a Wall (XN16/XN8)	62
Kit Contents (Wall Mount Assembly - XN16 and XN8)	62
Tools Required	62
Mark the Wall Position	63
Install the SNAPTOGGLE™ Toggle Bolts	64
Attach the Mounting Plate to the Wall Mounting Bracket	65
Attach the Wall Mounting Bracket/Plate Assembly to the Wall	65
Mount the Array	66
Mounting the Wi-Fi Array on a Wall (XN4)	67
Kit Contents (Wall Mount Assembly)	67
Tools Required	67
Mark the Wall Position	68
Install the SNAPTOGGLE™ Toggle Bolts	68
Attach the Mounting Plate to the Wall Mounting Bracket	70
Attach the Wall Mounting Bracket/Plate Assembly to the Wall	71
Mount the Array	72
Removing the Array	73
Powering Up the Wi-Fi Array	73
Array LED Operating Sequences	74
LED Boot Sequence	74
LED Operation when Array is Running	75
Establishing Communication with the Array	76

Using the Serial Port	76
Using the Ethernet Ports	76
Logging In	76
Performing the Express Setup Procedure	77
Procedure for Performing an Express Setup	78
The Web Management Interface	83
An Overview	84
Structure of the WMI	84
User Interface	86
Status Bar	87
Logging In	89
Applying Configuration Changes	89
Character Restrictions	89
Viewing Status on the Wi-Fi Array	91
Array Status Windows	91
Array Summary	92
Content of the Array Summary Window	93
Array Information	96
Array Configuration	96
Network Status Windows	98
Network Map	98
Content of the Network Map Window	99
Spanning Tree Status	100
Routing Table	101
DHCP Leases	102
Connection Tracking/NAT	102
CDP Neighbors	103
RF Monitor Windows	104
IAPs	105
Spectrum Analyzer	106
Intrusion Detection	109
Station Status Windows	111
Stations	112
Location Map	113
RSSI	118

Signal-to-Noise Ratio (SNR)	120
Noise Floor	122
Statistics Windows	124
IAP Statistics Summary	124
Per-IAP Statistics	125
Network Statistics	127
VLAN Statistics	128
WDS Statistics	129
Filter Statistics	130
Station Statistics	130
Per-Station Statistics	131
System Log Window	132
Configuring the Wi-Fi Array	133
Express Setup	134
Network	140
Network Interfaces	141
Network Interface Ports	142
DNS Settings	148
CDP Settings	149
Services	151
Time Settings (NTP)	152
System Log	154
SNMP	157
DHCP Server	158
VLANs	161
VLAN Management	162
Security	164
Understanding Security	165
Admin Management	168
Management Control	169
Access Control List	172
Global Settings	174
External Radius	177
Internal Radius	180
Rogue Control List	182
SSIDs	184

Understanding SSIDs	185
Understanding QoS Priority on the Wi-Fi Array	186
SSID Management	189
SSID List (top of page)	189
SSID Limits	192
Web Page Redirect Configuration Settings	193
Groups	196
Understanding Groups	196
Using Groups	197
Group Management	198
Group Limits	200
IAPs	202
Understanding Fast Roaming	203
IAP Settings	204
Global Settings (IAP)	209
Beacon Configuration	210
Station Management	211
Advanced Traffic Optimization	212
Global Settings .11an	214
Global Settings .11bgn	217
Advanced RF Settings	221
About Standby Mode	221
About Blocking Rogue APs	222
RF Intrusion Detection	222
RF Resilience	223
RF Power & Sensitivity	224
RF Spectrum Management	225
LED Settings	227
WDS	229
About Configuring WDS Links	229
WDS Client Links	231
Filters	233
Filter Lists	234
Filter Management	235
Using Tools on the Wi-Fi Array.....	239
System Tools	240

CLI	246
Logout	248
The Command Line Interface	249
Establishing a Secure Shell (SSH) Connection	249
Getting Started with the CLI	250
Inputting Commands	250
Getting Help	250
Top Level Commands	252
Root Command Prompt	252
configure Commands	253
show Commands	256
statistics Commands	259
Configuration Commands	260
acl	260
admin	261
cdp	262
clear	263
contact-info	264
date-time	265
dhcp-server	266
dns	267
file	268
filter	269
group	271
hostname	271
https	272
interface	273
load	274
location	274
management	275
more	275
no	276
quit	278
radius-server	278
reboot	279
reset	279

run-tests	280
security	282
snmp	283
ssh	284
ssid	285
standby	285
syslog	286
telnet	287
uptime	289
vlan	289
Sample Configuration Tasks	291
Configuring a Simple Open Global SSID	292
Configuring a Global SSID using WPA-PEAP	293
Configuring an SSID-Specific SSID using WPA-PEAP	294
Enabling Global IAPs	295
Disabling Global IAPs	296
Enabling a Specific IAP	297
Disabling a Specific IAP	298
Setting Cell Size Auto-Configuration for All IAPs	299
Setting the Cell Size for All IAPs	300
Setting the Cell Size for a Specific IAP	301
Configuring VLANs on an Open SSID	302
Configuring Self-Monitoring Mode (Loopback Tests)	303
Appendices	305
Appendix A: Servicing the Wi-Fi Array	307
Removing the Access Panel	309
Reinstalling the Access Panel	312
Replacing the FLASH Memory Module	314
Replacing the Main System Memory	316
Replacing the Integrated Access Point Radio Module	318
Replacing the Power Supply Module	321
Appendix B: Quick Reference Guide	323
Factory Default Settings	323
Host Name	323
Network Interfaces	323

Serial	323
Gigabit 1 and Gigabit 2	323
Fast Ethernet	324
Integrated Access Points (IAPs)	325
Server Settings	325
NTP	325
Syslog	326
SNMP	326
DHCP	326
Default SSID	327
Security	327
Global Settings - Encryption	327
External RADIUS (Global)	328
Internal RADIUS	329
Administrator Account and Password	329
Management	329
Keyboard Shortcuts	330
Appendix C: Technical Support	333
General Hints and Tips	333
Frequently Asked Questions	334
Multiple SSIDs	334
Security	336
VLAN Support	339
Array Monitor and Loopback Testing Capabilities	341
Enabling Monitoring on the Array	341
How Monitoring Works	341
Loopback Testing	342
Loopback Mode Options	343
Upgrading the Array via CLI	344
Sample Output for the Upgrade Procedure:	345
Contact Information	349
Glossary of Terms.....	351
Index.....	363

List of Figures

Figure 1.	The Xirrus Management System	2
Figure 2.	Wi-Fi Array (XN16)	7
Figure 3.	Wireless Coverage Patterns	9
Figure 4.	XP1 - Power over Ethernet Usage	10
Figure 5.	WMI: Array Status	11
Figure 6.	Layout of IAPs (XN16)	13
Figure 7.	Coverage Schemes	14
Figure 8.	Wall Thickness Considerations	30
Figure 9.	Unit Placement	32
Figure 10.	Full (Normal) Coverage	33
Figure 11.	Adjusting RF Patterns	33
Figure 12.	Custom Coverage	34
Figure 13.	Connection Rate vs. Distance (relatively unobstructed area)	34
Figure 14.	Transmit Power	35
Figure 15.	Overlapping Cells	36
Figure 16.	Allocating Channels Manually	37
Figure 17.	Deployment Scenario (54 Mbps)—Per Sector	38
Figure 18.	Deployment Scenario (36 Mbps)—Per Sector	38
Figure 19.	Deployment Scenario (18 Mbps)—Per Sector	39
Figure 20.	Port Failover Protection	40
Figure 21.	Switch Failover Protection	41
Figure 22.	WDS Link	46
Figure 23.	A Multiple Hop WDS Connection	46
Figure 24.	WDS Failover Protection	47
Figure 25.	Installation Workflow	49
Figure 26.	Array Placement	52
Figure 27.	Attaching the T-Bar Clips to the Template	55
Figure 28.	Attaching the T-Bar Clips to the Ceiling Grid	56
Figure 29.	Installing the Mounting Plate	57
Figure 30.	Connecting the Cables	58
Figure 31.	Attaching the Unit (XN4)	59
Figure 32.	Securing the Array	60
Figure 33.	IAP Positions (XN16)	61
Figure 34.	Wall Mount—Marking the Holes	63

Figure 35.	Installing the Toggle Bolts.....	64
Figure 36.	Attaching the Wall Mounting Plate.....	65
Figure 37.	Mounting the Array on a Wall.....	66
Figure 38.	Wall Mount—Marking the Holes.....	68
Figure 39.	Installing the Toggle Bolts.....	69
Figure 40.	Attaching the Array Mounting Plate.....	70
Figure 41.	Attaching the Wall Mounting Bracket to the Wall.....	71
Figure 42.	Mounting the Array on a Wall.....	72
Figure 43.	LED Locations (XN16).....	73
Figure 44.	Network Interface Ports.....	76
Figure 45.	Express Setup.....	77
Figure 46.	LEDs are Switched On.....	82
Figure 47.	Web Management Interface.....	84
Figure 48.	WMI: Frames.....	86
Figure 49.	WMI: Status Bar.....	87
Figure 50.	Feedback Form.....	88
Figure 51.	Logging In to the Wi-Fi Array.....	89
Figure 52.	Array Summary.....	92
Figure 53.	Disabled IAP (Partial View).....	94
Figure 54.	IAP Cells.....	95
Figure 55.	Array Information.....	96
Figure 56.	Show Configuration.....	97
Figure 57.	Network Map.....	98
Figure 58.	Spanning Tree Status.....	100
Figure 59.	Routing Table.....	101
Figure 60.	DHCP Leases.....	102
Figure 61.	Connection Tracking.....	102
Figure 62.	CDP Neighbors.....	103
Figure 63.	RF Monitor—IAPs.....	105
Figure 64.	RF Spectrum Analyzer.....	107
Figure 65.	Intrusion Detection/Rogue AP List.....	109
Figure 66.	Categorizing APs.....	110
Figure 67.	Stations.....	112
Figure 68.	Location Map.....	113
Figure 69.	Controls for Location Map.....	114
Figure 70.	Minimizing stations.....	115
Figure 71.	Setting Array location on a Custom Image.....	117

Figure 72.	Station RSSI Values	118
Figure 73.	Station RSSI Values—Colorized Graphical View	119
Figure 74.	Station Signal-to-Noise Ratio Values	120
Figure 75.	Station SNR Values—Colorized Graphical View	121
Figure 76.	Station Noise Floor Values	122
Figure 77.	Station Noise Floor Values—Colorized Graphical View	123
Figure 78.	IAP Statistics Summary Page.....	125
Figure 79.	Individual IAP Statistics Page (for IAP abg1)	126
Figure 80.	Network Statistics.....	127
Figure 81.	VLAN Statistics.....	128
Figure 82.	WDS Statistics	129
Figure 83.	Filter Statistics	130
Figure 84.	Station Statistics	130
Figure 85.	Individual Station Statistics Page.....	131
Figure 86.	System Log (modified for clarity)	132
Figure 87.	WMI: Express Setup	134
Figure 88.	LEDs are Switched On	139
Figure 89.	Network Interfaces	140
Figure 90.	Network Settings	141
Figure 91.	Network Interface Ports.....	142
Figure 92.	Port Modes (a-b)	144
Figure 93.	Port Modes (c-d)	145
Figure 94.	Port Modes (e-f)	146
Figure 95.	DNS Settings.....	148
Figure 96.	CDP Settings.....	149
Figure 97.	Services.....	151
Figure 98.	Time Settings (Manual Time).....	152
Figure 99.	Time Settings (NTP Time Enabled).....	153
Figure 100.	System Log	154
Figure 101.	SNMP	157
Figure 102.	DHCP Management	158
Figure 103.	VLANs.....	161
Figure 104.	VLAN Management	162
Figure 105.	Security.....	164
Figure 106.	Admin Management	168
Figure 107.	Management Control	169
Figure 108.	Access Control List.....	172

Figure 109. Global Settings (Security)	174
Figure 110. External RADIUS Server	177
Figure 111. Internal RADIUS Server	180
Figure 112. Rogue Control List	182
Figure 113. SSIDs.....	184
Figure 114. Four Traffic Classes	186
Figure 115. SSID Management	189
Figure 116. WPR Internal Splash Page Fields (SSID Management).....	194
Figure 117. Groups.....	196
Figure 118. Group Management	198
Figure 119. IAPs.....	202
Figure 120. IAP Settings	204
Figure 121. Global Settings (IAPs)	209
Figure 122. Global Settings .11an.....	214
Figure 123. Global Settings .11bgn	217
Figure 124. Advanced RF Settings.....	221
Figure 125. LED Settings	227
Figure 126. WDS.....	229
Figure 127. .Configuring a WDS Link.....	230
Figure 128. WDS Client Links	231
Figure 129. Filters	233
Figure 130. Filter Lists	234
Figure 131. Filter Management	235
Figure 132. System Tools.....	240
Figure 133. Saving the Diagnostic Log.....	243
Figure 134. Managing WPR Splash/Login page files.....	244
Figure 135. System Command (Ping).....	245
Figure 136. CLI Window	246
Figure 137. Login Window	248
Figure 138. Logging In.....	249
Figure 139. Help Window	250
Figure 140. Full Help	251
Figure 141. Partial Help.....	251
Figure 142. Configuring a Simple Open Global SSID.....	292
Figure 143. Configuring a Global SSID using WPA-PEAP.....	293
Figure 144. Configuring an SSID-Specific SSID using WPA-PEAP.....	294
Figure 145. Enabling Global IAPs.....	295

Figure 146. Disabling Global IAPs.....	296
Figure 147. Enabling a Specific IAP.....	297
Figure 148. Disabling a Specific IAP.....	298
Figure 149. Setting the Cell Size for All IAPs.....	299
Figure 150. Setting the Cell Size for All IAPs.....	300
Figure 151. Setting the Cell Size for a Specific IAP.....	301
Figure 152. Configuring VLANs on an Open SSID.....	302
Figure 153. Configuring a Loopback Test.....	304
Figure 154. Disconnecting Power from the Array.....	307
Figure 155. Removing the Access Panel Screws.....	309
Figure 156. Removing the Access Panel.....	310
Figure 157. Disconnecting the Power Supply and Fan.....	310
Figure 158. Reconnecting the Fan and Power Supply.....	312
Figure 159. Reinstalling the Access Panel.....	312
Figure 160. Removing the FLASH Memory Module.....	314
Figure 161. Removing the DIMM Memory Module.....	316
Figure 162. Removing the Chassis Cover Screws.....	318
Figure 163. Removing the Chassis Cover.....	318
Figure 164. Lifting the Integrated Access Point Module.....	319
Figure 165. Disconnect the Integrated Access Point Module.....	319
Figure 166. Installing a New Access Panel (with Power Supply).....	321

Introduction

These topics introduce the Xirrus Wi-Fi Array, including an overview of its key features and benefits, and a detailed listing of the product's physical, environmental, technology and regulatory specifications.

- **"The Xirrus Family of Products" on page 1.**
- **"About this User's Guide" on page 3.**
- **"Why Choose the Xirrus Wi-Fi Array?" on page 6.**
- **"Wi-Fi Array Product Overview" on page 7.**
- **"Key Features and Benefits" on page 13.**
- **"Product Specifications (XN16 and XN8)" on page 16.**
- **"Product Specifications (XN4)" on page 21.**

The Xirrus Family of Products

The Xirrus family of products includes the following items:

- **Xirrus Wi-Fi Array (XN16 / XN8 / XN4)**
The newest Xirrus Wi-Fi Arrays feature additional capabilities to support the Enterprise market. The XN16 has 16 IAPs (Integrated Access Points—radios), the XN8 has 8 IAPs, and the XN4 has 4 IAPs.
- **Xirrus Management System (XMS)**
XMS is used for managing large Wi-Fi Array deployments from a centralized Web-based interface. The XMS server is available pre-installed on the Xirrus XM-3300-CC Management Platform, or as a software package (XA-3300-CC) to be installed on your own server hardware.

Figure 1 illustrates the elements of the Xirrus Management System. Users start the XMS client simply by entering the URL of the XMS server on a web browser. The XMS server manages a number of Wi-Fi Arrays via SNMP.

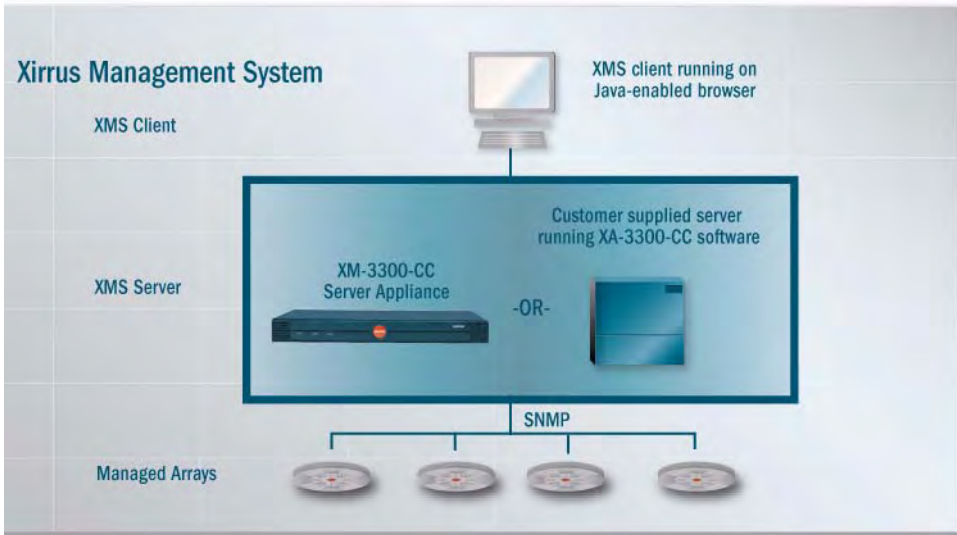

Figure 1. The Xirrus Management System

If you need detailed information about this product, refer to the XMS User’s Guide, part number 800-0007-001.

- **Xirrus Power over Gigabit Ethernet (PoGE)**

The PoGE modules eliminate the need for running separate power cabling. Additionally, an eight port module provides distributed power to multiple Arrays, facilitating backup power when connected via a UPS.

Nomenclature

Throughout this User's Guide, the Xirrus Wi-Fi Array is also referred to as simply the **Array**. In some instances, the terms **product** and **unit** are also used. When discussing specific products from the Xirrus family, the product name is used (for example, XN16, XN8, XN4). The Wi-Fi Array's operating system is referred to as the **ArrayOS**. The Web Management Interface for browser-based management of the Array is referred to as **WMI**.

The Xirrus Management System is referred to as **XMS**. The Power over Gigabit Ethernet system may be referred to as **PoGE**.

About this User's Guide

This User's Guide provides detailed information and procedures that will enable wireless network administrators to install, configure and manage the Wi-Fi Array so that end users can take full advantage of the product's features and functionality without technical assistance.

Organization

Topics and procedures are organized by function under the following chapter headings:

- **Introduction**
Provides a brief introduction to wireless technology, an overview of the product, including its key features and benefits, and presents the product specifications.
- **Installing the Wi-Fi Array**
Defines the prerequisites for deploying and installing the Array and provides instructions to help you plan and complete a successful installation.
- **The Web Management Interface**
Offers an overview of the product's embedded Web Management Interface, including its content and structure. It emphasizes what you need to do to ensure that any configuration changes you make are

applied, and provides a list of restricted characters. It also includes instructions for logging in to the Array with your Web browser.

- [Viewing Status on the Wi-Fi Array](#)
Describes the status and statistics displays available on the Array using its embedded Web Management Interface.
- [Configuring the Wi-Fi Array](#)
Contains procedures for configuring the Array using its embedded Web Management Interface.
- [Using Tools on the Wi-Fi Array](#)
Contains procedures for using utility tools provided in the Web Management Interface. It includes procedures for upgrading the system firmware, uploading and downloading configurations and other files, using diagnostic tools, and resetting the Array to its factory defaults.
- [The Command Line Interface](#)
Includes the commands and the command structure used by the Wi-Fi Array's Command Line Interface (CLI), and provides a procedure for establishing a Telnet connection to the Array. This chapter also includes some sample key configuration tasks using the CLI.
- [Appendix A: Servicing the Wi-Fi Array](#)
Contains procedures for servicing the Array, including the removal and reinstallation of major hardware components.
- [Appendix B: Quick Reference Guide](#)
Contains the product's factory default settings.
- [Appendix C: Technical Support](#)
Offers guidance to resolve technical issues, including general hints and tips to enhance your product experience, and a procedure for isolating problems within an Array-enabled wireless network. Also includes Frequently Asked Questions (FAQs) and Xirrus contact information.
- [Glossary of Terms](#)
Provides an explanation of terms directly related to Xirrus product technology, organized alphabetically.

- **Index**

The index is a valuable information search tool. Use the index to locate specific topics discussed in this User's Guide. Simply click on any page number in the index to jump to the referenced topic.

Notes and Cautions

The following symbols are used throughout this User's Guide:



This symbol is used for general notes that provide useful supplemental information.



This symbol is used for cautions. Cautions provide critical information that may adversely affect the performance of the product.

Screen Images

Some screen images of the Web Management Interface have been modified for clarity. For example, an image may have been cropped to highlight a specific area of the screen, and/or sample data may be included in some fields.

Your User's Guide as a PDF Document

This User's Guide is also made available as a secure PDF (Portable Document Format) file and can be viewed using the Adobe® Acrobat Reader® product. It cannot be edited or modified. If you don't have Acrobat Reader, you can download it free-of-charge from: <http://www.adobe.com>.

Hyperlinks

If you click on body text that appears in the color **TEAL** (with the exception of headings or notes) the embedded hyperlink within the text will immediately take you to the referenced destination. All internal and external cross-references, including page numbers within the **List of Figures** and the **Index**, have associated hyperlinks. After "jumping" to a referenced topic, if you want to return to the previous page (reference source), simply click on Acrobat's **previous page** button.

Window or Page?

Is a window a page, or is a page a window? There seems to be some dispute as to what the correct term should be. For the sake of consistency, this document uses

the term **Window** when referring to how the Wi-Fi Array's Web Management Interface is displayed on your monitor.

Why Choose the Xirrus Wi-Fi Array?

The deployment of wireless LANs is becoming increasingly common as businesses strive for greater flexibility in the workplace and the need for employee mobility rises. The only requirements for an effective wireless deployment are a power source, a couple of screws, and a little imagination.

Wireless LAN is also fully compatible with standard Ethernet protocols, so connectivity with existing wired infrastructures is transparent to users—they can still access and use the same applications and network services that they use when plugged into the company's wired LAN infrastructure (it's only the plug that no longer exists).

Wireless LAN has come a long way in the past few years and now offers the performance, reliability and security that Enterprise customers have come to expect from their networks. The technology is being driven by three major IEEE standards:

- **802.11a**
Operates in the 5 GHz range with a maximum speed of 54 Mbps.
- **802.11b**
Operates in the 2.4 GHz range with a maximum speed of 11 Mbps.
- **802.11g**
Supports a transmission speed of 54 Mbps in the 2.4 GHz range and is backwards compatible with 802.11b.
- **802.11n**
Supports a higher transmission speed of up to 300 Mbps in the 5 GHz range and is backwards compatible with 802.11a/b/g.

Whether you're a small company with just a handful of employees, or a large corporation with thousands, wireless has the scalability and flexibility to serve your needs.

See Also

- Key Features and Benefits
- Wi-Fi Array Product Overview
- Product Specifications (XN4)
- Product Specifications (XN16 and XN8)
- The Xirrus Family of Products

Wi-Fi Array Product Overview

Part of the family of Xirrus products, the Wi-Fi Array is a high capacity, multi-mode device designed for the Enterprise market, with twice the range and up to sixteen times the capacity of competitive wireless products.



Figure 2. Wi-Fi Array (XN16)

The Wi-Fi Array (regardless of the product model) is Wi-Fi® compliant and simultaneously supports 802.11a, 802.11b, 802.11g, and 802.11n clients. Enterprise class features such as **VLAN** support and multiple **SSID** capability enable robust network compatibility and a high level of scalability and system control. The optional Xirrus Management System (XMS) allows global management of hundreds of Arrays from a central location.

Multiple versions of the Array with different numbers of Integrated Access Points (IAPs) support a variety of deployment applications: 16 IAPs (XN16), 8 IAPs (XN8), and 4 IAPs (XN4).

Enterprise Class Security

The latest and most effective wireless encryption security standards, including WPA (Wi-Fi Protected Access) and WPA2 with 802.11i AES (Advanced Encryption Standard) are provided with the Wi-Fi Array. In addition, the use of an embedded RADIUS server (or 802.1x with an external RADIUS server) ensures user authentication—multiple Arrays can authenticate to the optional XMS, ensuring only authorized Arrays become part of the wireless network. Rogue AP detection, site monitoring, and RF spectrum analysis are performed in the background by the Array automatically.

Wi-Fi Array Product Family

The following table provides an overview of the main features supported by the Wi-Fi Array product family.

Feature	XN16	XN8,	XN4
Number of 802.11 a/b/g/n radios	4 ¹	4	4
Number of 802.11a/n radios	12	4	0
Total radios	16	8	4
Integrated Wi-Fi switch ports	16	8	4
Integrated RF spectrum analyzer and threat sensors	Yes	Yes	Yes
Uplink Ports	2	2	1
Wi-Fi bandwidth	864	432	216
Users supported	1,024	512	256

¹bgm using internal antennas, abg for 3 radios using external antennas

See Also

[Key Features and Benefits](#)

[Wi-Fi Array Product Overview](#)

Product Specifications (XN4)
Product Specifications (XN16 and XN8)
Power over Gigabit Ethernet (PoGE) (Optional)
Why Choose the Xirrus Wi-Fi Array?

Deployment Flexibility

Xirrus' unique multi-radio architecture generates 360 degrees of sectored high-gain 802.11a/b/g/n coverage that provides extended range and the highest possible data rates for a large volume of clients. Each sector can be controlled automatically or manually, creating a pattern of wireless coverage perfectly tailored to individual customer needs. For example:

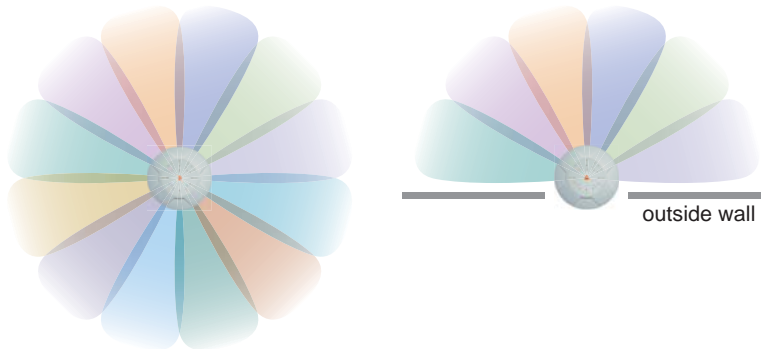

Figure 3. Wireless Coverage Patterns

Figure 3 depicts the following two scenarios:

- **Full pattern coverage**
All radios are activated with coverage spanning 360 degrees. If within range, clients will always receive coverage regardless of their geographic position relative to the Array.
- **Partial pattern coverage**
If desired, the Wi-Fi Array can be deployed close to an exterior wall. In this case, half of all available radios have been deactivated to prevent redundant signals from “bleeding” beyond the site’s perimeter wall. This

configuration may also be used in those cases where you want to restrict wireless coverage to selected areas of the building's interior.

See also, “Flexible Coverage Schemes” on page 14.

Power over Gigabit Ethernet (PoGE) (Optional)

The Xirrus XP1 and XP8 Power over Gigabit Ethernet modules provide power to your Arrays over the same Cat 5e or Cat 6 cable used for data, eliminating the need to run power cables and provide an AC power outlet in close proximity to each unit.

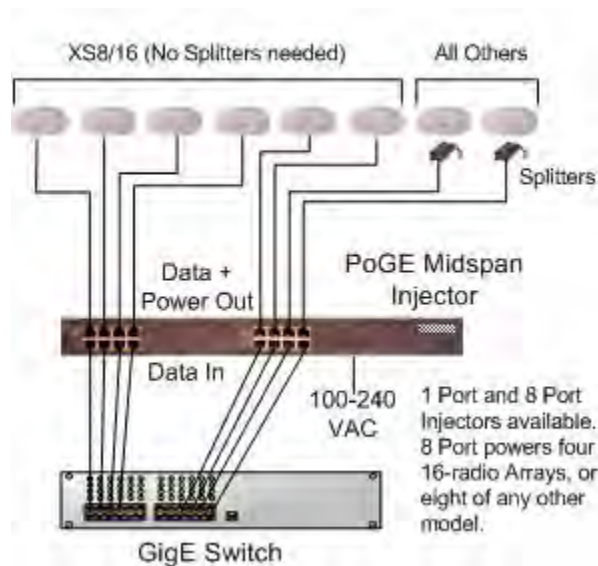

Figure 4. XP1 - Power over Ethernet Usage

Specific models of the Array are compatible with specific PoGE modules. For details, please see “**Contact Information**” on page 349.

See Also

Key Features and Benefits
 Wi-Fi Array Product Overview
 Product Specifications (XN4)

Product Specifications (XN16 and XN8)

The Xirrus Family of Products

Why Choose the Xirrus Wi-Fi Array?

Enterprise Class Management

The Wi-Fi Array can be configured with its default RF settings, or the RF settings can be customized using the Array’s embedded Web Management Interface (WMI). The WMI enables easy configuration and control from a graphical console, along with a full compliment of troubleshooting tools and statistics.



Figure 5. WMI: Array Status

In addition, a fully featured Command Line Interface (CLI) offers IT professionals a familiar management and control environment. [SNMP](#) (Simple Network Management Protocol) is also supported to allow management from an SNMP compliant management tool, such as the optional Xirrus Management System.



For deployments of more than five Arrays, we recommend that you use the Xirrus Management System (XMS). The XMS offers a rich set of features for fine control over large deployments.

See Also

[Key Features and Benefits](#)

[Product Specifications \(XN4\)](#)

[Product Specifications \(XN16 and XN8\)](#)

[Power over Gigabit Ethernet \(PoGE\) \(Optional\)](#)

[The Xirrus Family of Products](#)

[Why Choose the Xirrus Wi-Fi Array?](#)

Key Features and Benefits

This section describes some of the key product features and the benefits you can expect when deploying the Wi-Fi Array (the XN16 product is highlighted in this section).

High Capacity and High Performance

The XN16 version of the Wi-Fi Array easily handles time-sensitive traffic, such as voice, and can enable wireless connectivity for 1,024 users. The unit includes two Gigabit uplink ports for connection to the wired network. A total of sixteen IAPs provides a maximum wireless capacity of 864 Mbps, which offers ample reserves for the high demands of current and future applications. Of the sixteen IAPs, twelve operate in the 802.11a/n mode and four provide backwards compatibility with 802.11b and 802.11g.

If desired, IAP (radio) **abg2** can also be configured in RF monitoring and rogue AP detection mode.

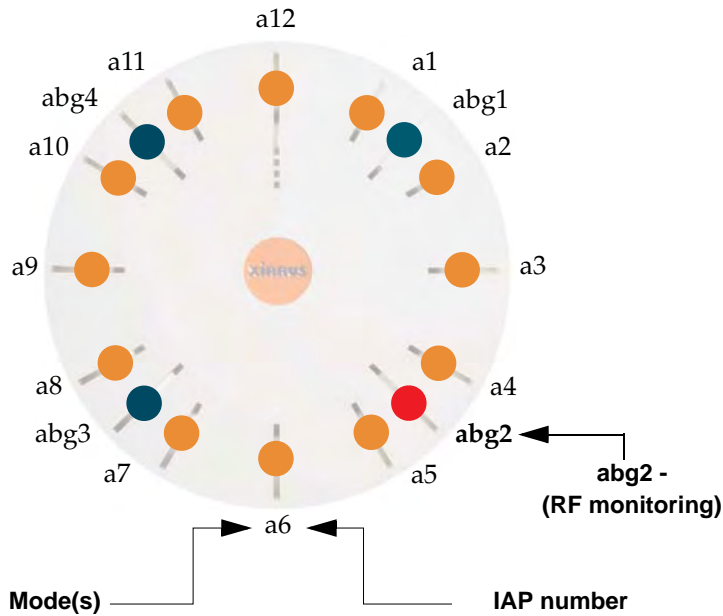

Figure 6. Layout of IAPs (XN16)

Extended Coverage

One XN16 solution enables you to replace up to sixteen access points (includes one omnidirectional IAP for monitoring the network). Fifteen IAP radios with integrated directional antennas provide increased wireless range and enhanced data rates in all directions. With a Wi-Fi Array deployed, far fewer access points are needed and wired-like resiliency is delivered throughout your wireless network. Your Wi-Fi Array deployment ensures:

- Continuous connectivity if an IAP (radio) fails.
- Continuous connectivity if an Array fails.
- Continuous connectivity if a WDS link or switch fails.
- Continuous connectivity if a Gigabit uplink or switch fails.

Flexible Coverage Schemes

Your Wi-Fi Array offers flexible coverage schemes for each wireless technology.

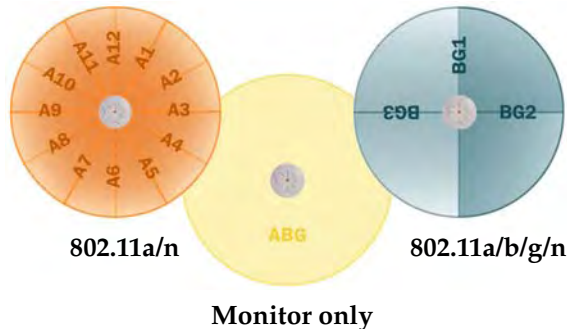

Figure 7. Coverage Schemes

- **802.11a/n**
Delivers 60° wireless coverage per IAP, with 6 dBi of gain.
- **802.11a/b/g/n**
Delivers 180° wireless coverage, with 4 dBi of gain.
- **802.11a/b/g/n (monitor only)**
Delivers 360° wireless coverage, with 2 dBi of gain.

Non-Overlapping Channels

Complete use of non-overlapping channels limits interference and delivers maximum capacity. On the XN16, up to 16 non-overlapping channels are fully utilized across the 5GHz and 2.4GHz spectrums (up to 12 across the 5GHz spectrum plus up to 3 across the 2.4 GHz spectrum—typically, one additional radio is used as a dedicated RF monitor).

Secure Wireless Access

Multiple layers of authentication and encryption ensure secure data transmissions. The Wi-Fi Array is 802.11i compliant with encryption support for 40 bit and 128 bit WEP, WPA and WPA2 with TKIP and AES encryption. Authentication support is provided via 802.1x, including PEAP, EAP-TLS, EAP-TTLS, and LEAP (Lightweight Extensible Authentication Protocol) passthrough.

Applications Enablement

QoS (Quality of Service) functionality combined with true switch capabilities enable high density video and Voice over Wireless LAN deployments. Compliant with 802.1p and 802.1Q standards.

SDMA Optimization

SDMA (Spatial Division Multiple Access) technology provides full 360° coverage while allowing independent channel and power output customization. Also supports fast inter-zone handoffs for time-sensitive applications and roaming support.

Fast Roaming

Utilizes the Xirrus Roaming Protocol (XRP) ensuring fast and seamless roaming capabilities between IAPs or Arrays at both Layer 2 and Layer 3.

Easy Deployment

The Xirrus Management System (XMS) offers real time monitoring and management capabilities of the wireless network—ideal for the Enterprise market. It also allows you to import floor plans to help you plan your deployment. The Xirrus Wi-Fi Array chassis has a plenum rated, lockable and tamper resistant case.

See Also

- Wi-Fi Array Product Overview
- Product Specifications (XN4))
- Product Specifications (XN16 and XN8)
- Power over Gigabit Ethernet (PoGE) (Optional)
- The Xirrus Family of Products
- Why Choose the Xirrus Wi-Fi Array?

Product Specifications (XN16 and XN8)

Element	Specifications
Number of Users	Maximum of 64 associated users per radio 1024 users per Array (XN16) 512 users per Array (XN8)
Physical	Diameter: 18.65 inches (47.37 cm) Height: 3.87 inches (9.83 cm) Weight: 8lbs (3.63 kg)
Environmental	Operating Temperature: -10°C to 50°C 0% to 90% relative humidity (non-condensing) Storage Temperature: -20°C to 60°C 5% to 95% relative humidity (non-condensing)
System	1 GHz CPU (XN16/XN8) 1 GB RAM (XN16/XN8) 512 MB system flash Expansion slot for future options

Element	Specifications
Electrical	XN16/XN8: Each Array supports both AC and PoGE AC Input Power: 90-265VAC at 47-63Hz PoGE Input Power: Power over Gigabit Ethernet—no splitter required, 48VDC
Interfaces	Serial: 1 x RS232 – RJ45 connector Ethernet Interfaces: 2 x Gigabit 100/1000 Mbps w/failover 1 x Fast Ethernet 10/100 Mbps Status LEDs: System status, Ethernet, Radio
Management	Web-based HTTPS SNMP v2 CLI via SSHv2 or Telnet FTP TFTP Serial Xirrus Management System (XMS) Syslog reporting for alerts/alarms
Networking	DHCP client, DHCP server, NTP client, NAT
VLAN Support	802.1Q, 802.1p VLAN Supports up to 16 VLANs
Multiple SSID Support	Allows up to 16 separate SSIDs to be defined with map security, VLAN and QoS settings for each SSID

Element	Specifications
Performance	<p>Client Load Balancing Automatic load balancing between system radios</p> <p>Quality of Service: 802.1p wired traffic prioritization Wireless packet prioritization MAP CoS to TCID Fair queuing of downstream traffic</p>
Security	<p>Wireless Security: WEP 40bit/128bit encryption WPA and WPA2 with TKIP and AES encryption Rogue AP detection, with alerts and classification</p> <p>User and System Authentication: WPA and WPA2 Pre-Shared Key authentication Internal RADIUS Server, supports EAP-PEAP only 802.1x EAP-TLS 802.1x EAP-TTLS/MSCHAPv2 802.1x PEAPv0/EAP-MSCHAPv2 802.1x PEAPv1/EAP-GTC 802.1x EAP-SIM 802.1x EAP-LEAP Passthrough External RADIUS servers Authentication of Wi-Fi Arrays to the Xirrus Management System (XMS)</p>

Element	Specifications
<p>Wireless</p>	<p>Number of Radios:</p> <p>XN16: 12 x 802.11a/n radios 4 x 802.11a/b/g/n radios Only 12 radios should be used as 802.11a/n radios concurrently.</p> <p>XN8: 4 x 802.11a/n radios 4 x 802.11a/b/g/n radios</p> <p>Wireless Standards: 802.11a/b/g /n and g-only mode 802.11e, 802.11i</p> <p>Channel Selection: Manual and Automatic</p> <p>Frequency Bands: 11a: 4.945 – 4.985 (restricted Public Safety band) 11a: 5.15-5.25 GHz (UNII 1) 11a: 5.725-5825 GHz (UNII 3) 11b/g: 2.412-2.462 GHz (FCC)</p> <p>Antennas (XN16): 36 x internal 6 dBi 60° 802.11a/n sectorized 12 x internal 3 dBi 180° 802.11b/g/n sectorized 1 x internal 2 dBi 360° omni-directional (for RF monitoring) 3 x external RP-TNC connectors for three 802.11a/b/g/n radios</p>

Element	Specifications
	<p>Antennas (XN8): 24 x internal 6 dBi 60° 802.11a sectorized 12 x internal 3 dBi 180° 802.11b/g sectorized 1 x internal 2 dBi 360° omni-directional (for RF monitoring) 3 x external RP-TNC connectors for three 802.11a/b/g/n radios</p> <p>Radio Approvals: FCC (United States)</p>
Compliance	FCC Part 15.107 and 15109, Class B
Warranty	One year (hardware and software)

See Also

[Key Features and Benefits](#)

[Wi-Fi Array Product Overview](#)

[Product Specifications \(XN4\)](#)

[Power over Gigabit Ethernet \(PoGE\) \(Optional\)](#)

[The Xirrus Family of Products](#)

[Why Choose the Xirrus Wi-Fi Array?](#)

Product Specifications (XN4)

Element	Specifications
Number of Users	Maximum of 64 associated users per radio (256 users per Array)
Physical	Diameter: 12.58 inches (31.95 cm) Height: 2.58 inches (6.55 cm) Weight: 4lbs (1.81 kg)
Environmental	Operating Temperature: -10°C to 50°C 0% to 90% relative humidity (non-condensing) Storage Temperature: -20°C to 60°C 5% to 95% relative humidity (non-condensing)
System	825 MHz CPU (XN4) 512 MB RAM, expandable (XN4) 512 MB system flash, expandable Expansion slot for future options
Electrical	XN4: Each Array supports both AC and PoGE AC Input Power: 90-265VAC at 47-63Hz Power over Gigabit Ethernet (PoGE): all 4-port models work with all Xirrus PoGE modules, splitter required, 48VDC
Interfaces	Serial: 1 x RS232 – RJ45 connector Ethernet Interfaces: 1 x Gigabit 100/1000 Mbps Status LEDs: System status, Ethernet, Radio

Element	Specifications
Management	Web-based HTTPS SNMP v2 CLI via SSHv2 or Telnet FTP TFTP Serial Xirrus Management System (XMS) Syslog reporting for alerts/alarms
Networking	DHCP client, DHCP server, NTP client, NAT
VLAN Support	802.1Q, 802.1p VLAN Supports up to 16 VLANs
Multiple SSID Support	Allows up to 16 separate SSIDs to be defined with map security, VLAN and QoS settings for each SSID
Performance	Client Load Balancing Automatic load balancing between system radios Quality of Service: 802.1p wired traffic prioritization Wireless packet prioritization MAP CoS to TCID Fair queuing of downstream traffic

Element	Specifications
<p>Security</p>	<p>Wireless Security: WEP 40bit/128bit encryption WPA and WPA2 with TKIP and AES encryption Rogue AP detection, with alerts and classification</p> <p>User and System Authentication: WPA Pre-Shared Key authentication Internal RADIUS Server, supports EAP-PEAP only 802.1x EAP-TLS 802.1x EAP-TTLS/MSCHAPv2 802.1x PEAPv0/EAP-MSCHAPv2 802.1x PEAPv1/EAP-GTC 802.1x EAP-SIM 802.1x EAP-LEAP Passthrough External RADIUS servers Authentication of Wi-Fi Arrays to the Xirrus Management System (XMS)</p>

Element	Specifications
Wireless	<p>Number of Radios: 4 x 802.11a/b/g/n radios</p> <p>Wireless Standards: 802.11a/b/g/n and g-only mode 802.11e, 802.11i</p> <p>Channel Selection: Manual and Automatic</p> <p>Frequency Bands: 11a: 4.945 – 4.985 (restricted Public Safety band) 11a: 5.15-5.25 GHz (UNII 1) 11a: 5.725-5.825 GHz (UNII 3) 11b/g: 2.412-2.462 GHz (FCC)</p> <p>Antennas: 12 x internal 6 dBi 60° 802.11a sectorized 12 x internal 3 dBi 180° 802.11b/g sectorized 1 x internal 2 dBi 360° omni-directional (for RF monitoring) 3 x external RP-TNC connectors for three 802.11a/b/g/n radios</p> <p>Radio Approvals: FCC (United States)</p>
Compliance	FCC Part 15.107 and 15109, Class B
Warranty	One year (hardware and software)

See Also

[Key Features and Benefits](#)

[Wi-Fi Array Product Overview](#)

[Product Specifications \(XN16 and XN8\)](#)

[Power over Gigabit Ethernet \(PoGE\) \(Optional\)](#)

[The Xirrus Family of Products](#)

[Why Choose the Xirrus Wi-Fi Array?](#)





Installing the Wi-Fi Array

The instructions for completing a successful installation include the following topics:

- [“Installation Prerequisites” on page 27.](#)
- [“Planning Your Installation” on page 30.](#)
- [“Installation Workflow” on page 49.](#)
- [“Unpacking the Wi-Fi Array” on page 50.](#)
- [“Installing Your Wi-Fi Array” on page 52.](#)
- [“Powering Up the Wi-Fi Array” on page 73.](#)
- [“Establishing Communication with the Array” on page 76.](#)
- [“Performing the Express Setup Procedure” on page 77.](#)

Installation Prerequisites

Your Wi-Fi Array deployment requires the presence of hardware and services in the host wired/wireless network, including:

- **Dedicated AC power outlet**
Unless you are using Xirrus PoGE, you need a dedicated power outlet to supply AC power to each unit deployed at the site. If you are using the optional PoGE, then power is supplied over the same Cat 5e or Cat 6 cable used for data. PoGE power injector modules are available in 1 port and 8 port configurations and are typically placed near your Gigabit Ethernet switch. An AC outlet is required for each injector module.
- **Ethernet port**
You need at least one 100/1000 BaseT port to establish wired Gigabit Ethernet connectivity (via the product’s [Gigabit 1](#) or [Gigabit 2](#) port) and one 10/100 BaseT port (if desired) for product management.

! *The Array’s Ethernet ports should be connected to an Ethernet switch, not an Ethernet hub—if a hub is used, we recommend that you connect only one Ethernet port.*

! *The Gigabit1 Ethernet interface is the primary port for both data and management traffic. If a single Ethernet connection is used, it must be connected to the Gigabit1 Ethernet interface. See also, “Port Failover Protection” on page 40.*

The 10/100 Ethernet Port may be used for managing the Array out of band from the Gigabit Ethernet ports. The 10/100 port will route only management traffic, using a static route that may be configured for this interface. See “interface” on page 273.

- **Secure Shell (SSH) utility**

To establish secure remote command line access to the Array, you need a Secure Shell (SSH) utility, such as PuTTY.

- **Secure Web browser**

Either Internet Explorer (version 6.0 or higher), Netscape Navigator (version 7.0 or higher), or Mozilla Firefox (version 1.01 or higher). A secure Web browser is required for Web-based management of the Array. The browser must be on the same subnet as the Array, or you must set a static route for management as described in the warning above.

- **Serial connection capability**

To connect directly to the console port on the Array, your computer must be equipped with a male 9-pin serial port and terminal emulation software (for example, HyperTerminal). The Xirrus Array only supports serial cable lengths up to 25' per the RS-232 specification.

Use the following settings when establishing a serial connection:

Bits per second	115,200
Data bits	8
Parity	None
Stop bits	1
Flow control	None

Optional Network Components

The following network components are optional.

- **Xirrus Management System (XMS)**
The optional XMS offers powerful management features for small or large Wi-Fi Array deployments.
- **Xirrus Power over Gigabit Ethernet (PoGE)**
The optional Power over Gigabit Ethernet (PoGE) modules allow you to provide power the Array without running power cables. The 8 Port Injector provides distributed power to multiple Arrays, eliminating the need to run dedicated AC power to each unit and facilitating backup power when connected via a UPS.

Specific models of the Array are compatible with specific PoGE modules. For details, please see **“Contact Information” on page 349.**
- **External RADIUS server**
Although your Array comes with an embedded RADIUS server, for 802.1x authentication in large deployments you may want to add an external RADIUS server.

Client Requirements

The Wi-Fi Array should only be used with Wi-Fi certified client devices.

See Also

Coverage and Capacity Planning

Deployment Examples

Failover Planning

Planning Your Installation

Planning Your Installation

This section provides guidelines and examples to help you plan your Xirrus Wi-Fi Array deployment to achieve the best overall coverage and performance. We recommend you conduct a site survey to determine the best location and settings for each Array you install.

General Deployment Considerations

The Wi-Fi Array's unique multi-radio architecture generates 360 degrees of sectorized high-gain 802.11a/b/g/n coverage that provides extended range. However, the number, thickness and location of walls, ceilings or other objects that the wireless signals must pass through may affect the range. Typical ranges vary depending on the types of materials and background RF (radio frequency) noise at your location. To maximize wireless range, follow these basic guidelines:

1. Keep the number of walls and ceilings between the Array and your receiving devices to a minimum—each wall or ceiling can reduce the wireless range from between 3 and 90 feet (1 to 30 meters). Position your devices so that the number of walls or ceilings is minimized.
2. Be aware of the direct line between each device. For example, a wall that is 1.5 feet thick (half a meter) at 90° is actually almost 3 feet thick (or 1 meter) when viewed at a 45° angle. At an acute 2° degree angle the same wall is over 42 feet (or 14 meters) thick! For best reception, try to ensure that your wireless devices are positioned so that signals will travel straight through a wall or ceiling.

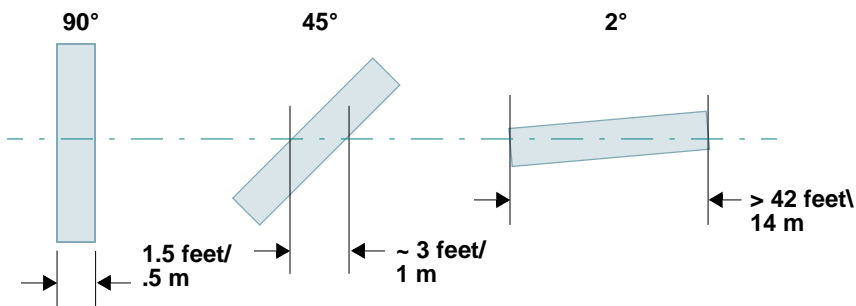

Figure 8. Wall Thickness Considerations

3. Try to position wireless client devices so that the signal passes through drywall (between studs) or open doorways and not other materials that can adversely affect the wireless signal.

See Also

Coverage and Capacity Planning

Deployment Examples

Deployment Summary

Installation Prerequisites

Coverage and Capacity Planning

This section considers coverage and capacity for your deployment(s), including placement options, RF patterns and cell sizes, area calculations, roaming considerations, and channel allocations.

Placement

Use the following guidelines when considering placement options:

1. The best placement option for the Array is ceiling-mounted within an open plan environment (cubicles rather than fixed walls).
2. Keep the Array away from electrical devices or appliances that generate RF noise. Because the Array is generally mounted on ceilings, be aware of its position relative to lighting (especially fluorescent lighting)—we recommend maintaining a distance of at least 3 to 6 feet (1 to 2 meters).
3. If using multiple Arrays in the same area, maintain a distance of at least 100 ft/30m between Arrays if there is direct line-of-sight between the units, or at least 50 ft/15m if a wall or other barrier exists between the units.

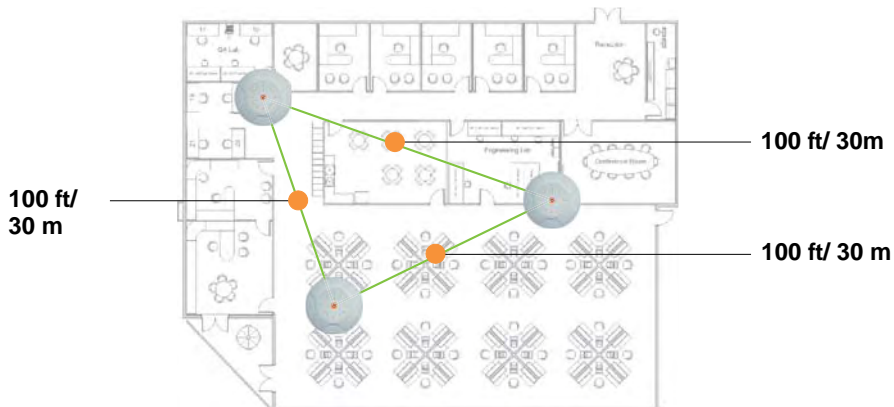

Figure 9. Unit Placement

RF Patterns

The Wi-Fi Array allows you to control—automatically or manually—the pattern of wireless coverage that best suits your deployment needs. You can choose to operate with full coverage, half coverage, or custom coverage (by enabling or disabling individual sectors).

Full (Normal) Coverage

In normal operation, the Array provides a full 360 degrees of coverage.

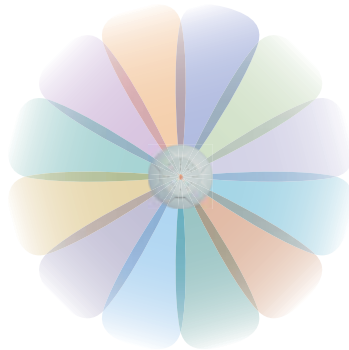

Figure 10. Full (Normal) Coverage

Half Coverage

If installing a unit close to an exterior wall, you can deactivate half of the radios to prevent redundant signals from “bleeding” beyond the wall and extending service into public areas. The same principle applies if you want to restrict service to an adjacent room within the site.

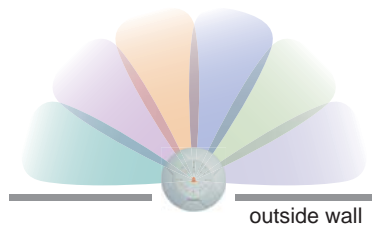

Figure 11. Adjusting RF Patterns

Custom Coverage

Where there are highly reflective objects in close proximity to the Array, you can turn off specific radios to avoid interference and feedback.

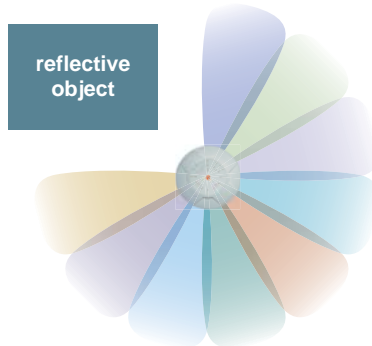

Figure 12. Custom Coverage

Capacity and Cell Sizes

Cell sizes should be estimated based on the number of users, the applications being used (for example, data/video/voice), and the number of Arrays available at the location. The capacity of a cell is defined as the minimum data rate desired for each sector multiplied by the total number of sectors being used.

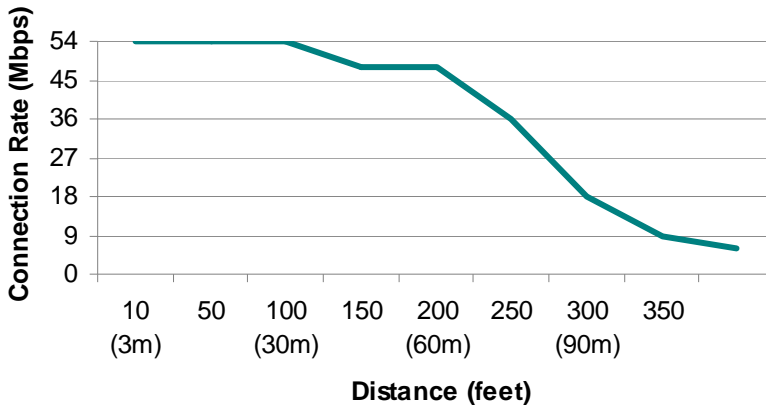

Figure 13. Connection Rate vs. Distance (relatively unobstructed area)

Figure 13 shows some sample maximum connection rates for the XN8 and XN16 at different distances in an unobstructed area. Wireless environments can vary greatly so the actual rates may be different depending on the specific network deployment.



The XN4 has a smaller range than the larger Arrays. The distance is about 80% of the values shown in Figure 13 above. Thus the maximum cell size is about 64% of the coverage area in the chart.

Fine Tuning Cell Sizes

Adjusting the [transmit power](#) allows you to fine tune cell sizes. There are four standard sizes—Small, Medium, Large, or Max (the default is **Max**). There is also an Auto setting that automatically determines the best cell size, and a Manual setting that allows you to choose your power settings directly. If you are installing many units in close proximity to each other, reduce the transmit power to avoid excessive interference with other Arrays or installed APs. See also, “[Coverage and Capacity Planning](#)” on page 32.

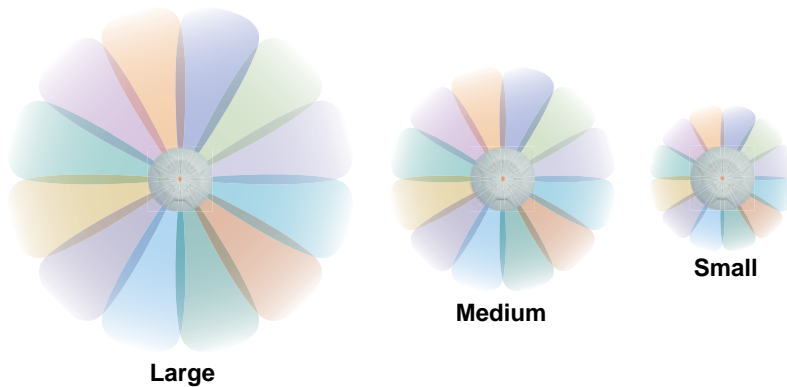

Figure 14. Transmit Power

Sharp Cell

This feature available from the Web Management Interface reduces interference between neighboring Wi-Fi Arrays or other Access Points by limiting to a defined

boundary (cell size) the trailing edge bleed of RF energy. To enable the Sharp Cell feature, go to “Global Settings (IAP)” on page 209.

Roaming Considerations

Cells should overlap approximately 10 - 15% to accommodate client roaming.

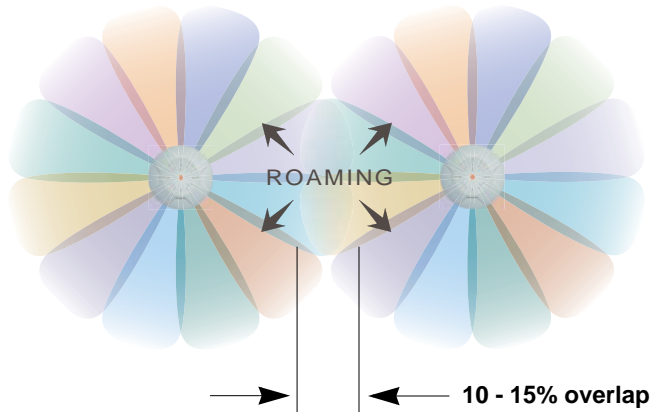

Figure 15. Overlapping Cells

Allocating Channels

Because the Wi-Fi Array is a multi-channel device, allocating the best channels to radios is important if peak performance is to be maintained.

Automatic Channel Selection

We recommend that you allow the Array to make intelligent channel allocation decisions automatically. In the automatic mode, channels are allocated dynamically, driven by changes in the environment.

Manual Channel Selection

You can manually assign channels on a per radio basis, though manual selection is not recommended (and not necessary).



To avoid co-channel interference, do not select adjacent channels for radios that are physically next to each other.

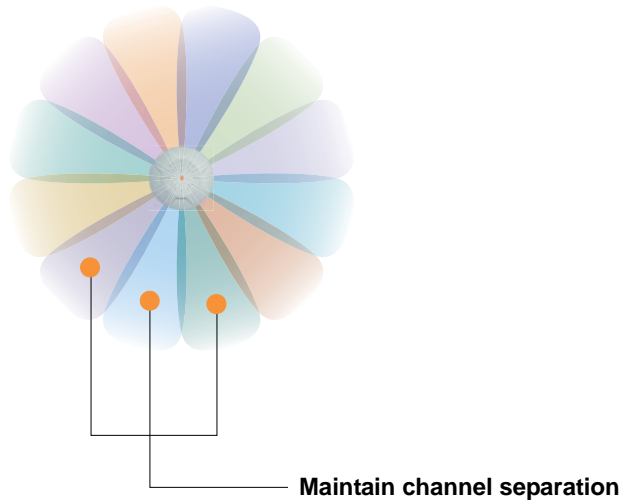

Figure 16. Allocating Channels Manually

See Also

Deployment Examples

Failover Planning

Installation Prerequisites

Deployment Examples

The following examples employ 802.11a cells, each offering minimum throughputs of 54 Mbps, 36 Mbps, and 18 Mbps per sector respectively, and assume a floor plan covering a total area of about 60,000 square feet (5574 sq m).

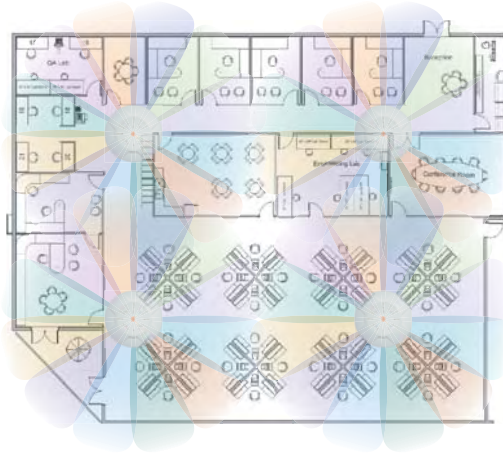

Figure 17. Deployment Scenario (54 Mbps)—Per Sector

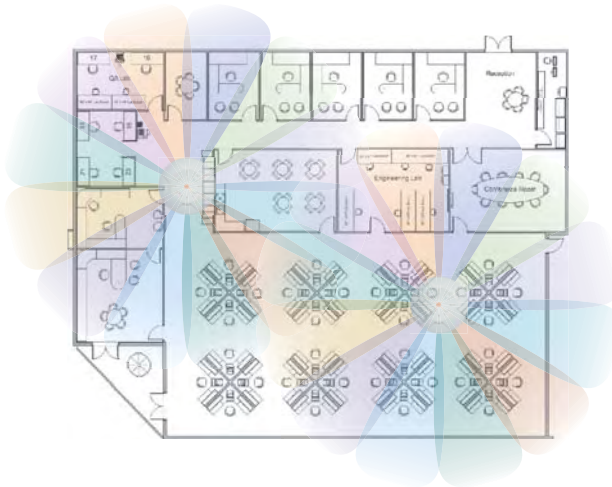

Figure 18. Deployment Scenario (36 Mbps)—Per Sector

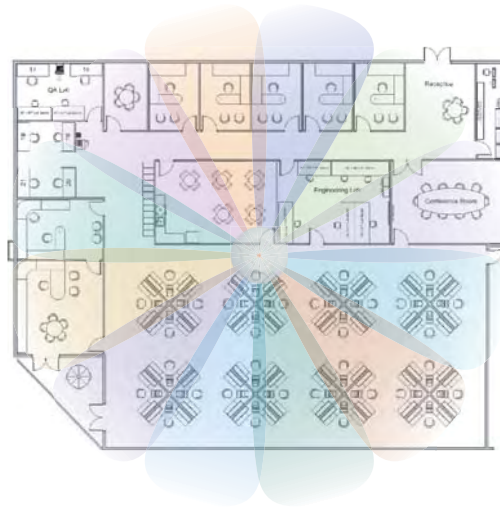

Figure 19. Deployment Scenario (18 Mbps)—Per Sector

See Also

Coverage and Capacity Planning

Failover Planning

Planning Your Installation

Failover Planning

This section discusses failover protection at the unit and port levels.

Port Failover Protection

To ensure that service is continued in the event of a port failure, you can utilize the Gigabit 1 and Gigabit 2 ports simultaneously.

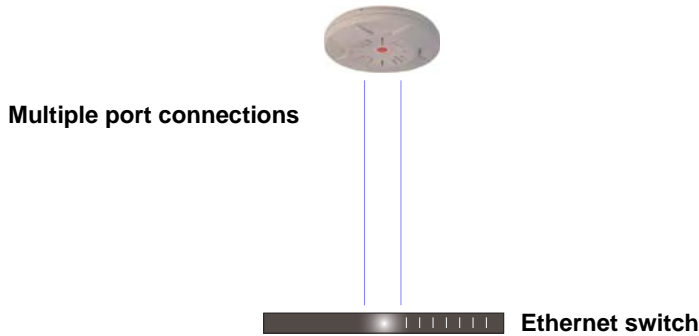

Figure 20. Port Failover Protection

In addition, the Array has full failover protection between the Gigabit 1 and Gigabit 2 Ethernet ports (see following table).

Interface	Bridges Data?	Bridges Management Traffic?	Fails Over To:	IP address
Fast Ethernet	No	Yes	None	DHCP or static
Gigabit 1	Yes	Yes	Gigabit 2	DHCP or static
Gigabit 2	Yes	Yes	Gigabit 1	Assumes the IP address of Gigabit 1

Switch Failover Protection

To ensure that service is continued in the event of a switch failure, you can connect Arrays to more than one Ethernet switch (not a hub).



Figure 21. Switch Failover Protection



Gigabit Ethernet connections must be on the same subnet.

See Also

- Coverage and Capacity Planning
- Deployment Examples
- Installation Prerequisites
- Network Management Planning
- Planning Your Installation
- Power Planning
- Security Planning

Power Planning

The XN8 and XN16 Array models and all four-port Arrays support both AC power and Power over Gigabit Ethernet (PoGE). This section discusses the AC and PoGE power options.

AC Power

The AC power option requires a direct connection between the Array and a dedicated AC power outlet. The power cord is provided with the unit.

Power over Gigabit Ethernet

To deliver power to the Array, you may use the optional XP1 or XP8 Power over Gigabit Ethernet (PoGE) modules. They provide power over Cat 5e or Cat 6 cables to the Array without running power cables—see [Figure 4 on page 10](#).

Specific models of the Array are compatible with specific PoGE modules. For details, please see [“Contact Information” on page 349](#).



When using Cat 5e or Cat 6 cable, power can be provided up to a distance of 100m.

See Also

[Coverage and Capacity Planning](#)

[Deployment Examples](#)

[Failover Planning](#)

[Network Management Planning](#)

[Security Planning](#)

Security Planning

This section offers some useful guidelines for defining your preferred encryption and authentication method. For additional information, see [“Understanding Security” on page 165](#) and the Security section of [“Frequently Asked Questions” on page 334](#).

Wireless Encryption

Encryption ensures that no user can decipher another user’s data transmitted over the airwaves. There are three encryption options available to you, including:

- **WEP-40bit or WEP-128bit**
Because WEP is vulnerable to cracks, we recommend that you only use this for legacy devices that cannot support a stronger encryption type.
- **Wi-Fi Protected Access (WPA)**
This is much more secure than WEP and uses TKIP for encryption.
- **Wi-Fi Protected Access (WPA2) with AES**
This is government-grade encryption—available on most new client adapters—and uses the AES-CCM encryption mode (Advanced Encryption Standard-Counter Mode).

Authentication

Authentication ensures users are who they say they are, and occurs when users attempt to join the wireless network and periodically thereafter. The following authentication methods are available with the Wi-Fi Array:

- **RADIUS 802.1x**
802.1x uses a remote RADIUS server to authenticate large numbers of clients, and can handle different authentication methods (EAP-TLS, EAP-TTLS, EAP-PEAP, and EAP-LEAP Passthrough).
- **Xirrus Internal RADIUS server**
Recommended for smaller numbers of users (about 100 or less). Supports EAP-PEAP only
- **Pre-Shared Key**
Uses a pass-phrase or key that is manually distributed to all authorized users. The same passphrase is given to client devices and entered into each Array.
- **MAC Access Control Lists (ACLs)**
MAC access control lists provide a list of client adapter MAC addresses that are allowed or denied access to the wireless network, and can be used in addition to any of the above authentication methods. ACLs are good for embedded devices, like printers and bar-code scanners (though MAC addresses can be spoofed). The Wi-Fi Array supports 1,000 ACL entries.

See Also

Failover Planning

Network Management Planning

Power Planning

Network Management Planning

Network management can be performed using any of the following methods:

- Command Line Interface, using an SSH (Secure Shell) utility, like PuTTY.
- Web-based management, using the Array's embedded Web Management Interface (WMI). This method provides configuration and basic monitoring tools, and is good for small deployments (one or two units).
- Centralized Web-based management, using the optional Xirrus Management System (XMS), which can be run on a dedicated Xirrus appliance (XM-3300) or your own server. The XMS is used for managing large Wi-Fi Array deployments from a centralized Web-based interface and offers the following features:
 - ◆ Globally manage large numbers of Arrays (up to 500)
 - ◆ Seamless view of the entire wireless network
 - ◆ Easily configure large numbers of Arrays
 - ◆ Rogue AP monitoring
 - ◆ Easily manage system-wide firmware updates
 - ◆ Monitor performance and trends
 - ◆ Aggregation of alerts and alarms

See Also

[Failover Planning](#)

[Power Planning](#)

[Security Planning](#)

WDS Planning

WDS (Wireless Distribution System) creates wireless backhauls between arrays, allowing your wireless network to be expanded using multiple Arrays without the need for a wired backbone to link them (see Figure 22). WDS features include:

- One to three IAPs may be used to form a WDS link, yielding up to 162 Mbps bandwidth per link. Up to 4 WDS links may be defined per Array.
- Automatic IAP Load Balancing
- Clients can still associate to a BSS on the same radio interface used for a WDS Host Link. This will take bandwidth from the WDS link.

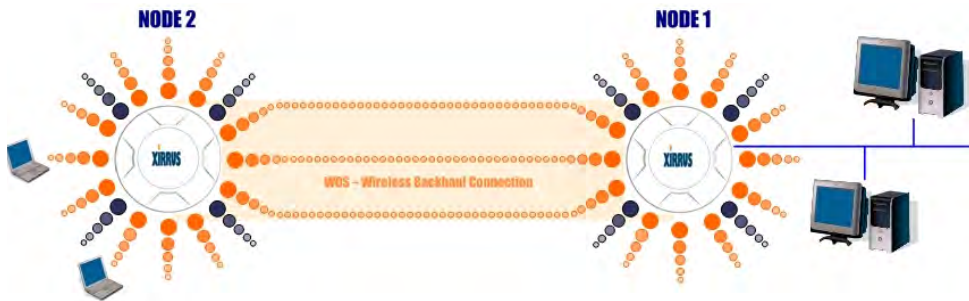

Figure 22. WDS Link

- Multiple links per Array allow you to configure multi-hop connections.



Figure 23. A Multiple Hop WDS Connection

- Multiple WDS links can provide link redundancy (failover capability - see Figure 24). A network protocol (Spanning Tree Protocol—STP) prevents Arrays from forming network loops.

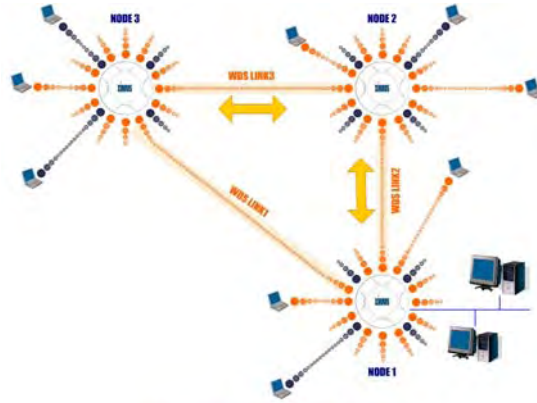

Figure 24. WDS Failover Protection

WDS links have a Host/Client relationship similar to the usual IAP/station pattern for Arrays:

- A *WDS Client Link* associates/authenticates to a host (target) Array in the same way that a station associates to an IAP. The client side of the link must be configured with the root MAC address of the target (host) Array.
- A *WDS Host Link* acts like an IAP by allowing one WDS Client Link to associate to it. An Array may have both client and host links.

WDS configuration is performed only on the client-side Array. See “WDS” on page 229. Note that both Arrays must be configured with the same SSID name.

Deployment Summary

The following table summarizes your deployment options.

Function	Number of Wi-Fi Arrays	
	One or Two	Three or More
Power	AC Power over Gigabit Ethernet	AC Power over Gigabit Ethernet UPS backup (recommended)
Failover	Recommended	Highly recommended
VLANs	Optional	Optional use, Can be used to put all APs on one VLAN or map to existing VLAN scheme
Encryption	WPA2 with AES (recommended) PSK or 802.1x	WPA2 with AES (recommended) 802.1x keying
Authentication	Internal RADIUS server EAP-PEAP Pre-Shared Key	External RADIUS server
Management	Internal WMI Internal CLI	XMS (SNMP)

See Also

[Coverage and Capacity Planning](#)

[Deployment Examples](#)

[Network Management Planning](#)

[Planning Your Installation](#)

[Power Planning](#)

[Security Planning](#)

Installation Workflow

This workflow illustrates the steps that are required to install and configure your Wi-Fi Array successfully. Review this flowchart before attempting to install the unit on a customer’s network.

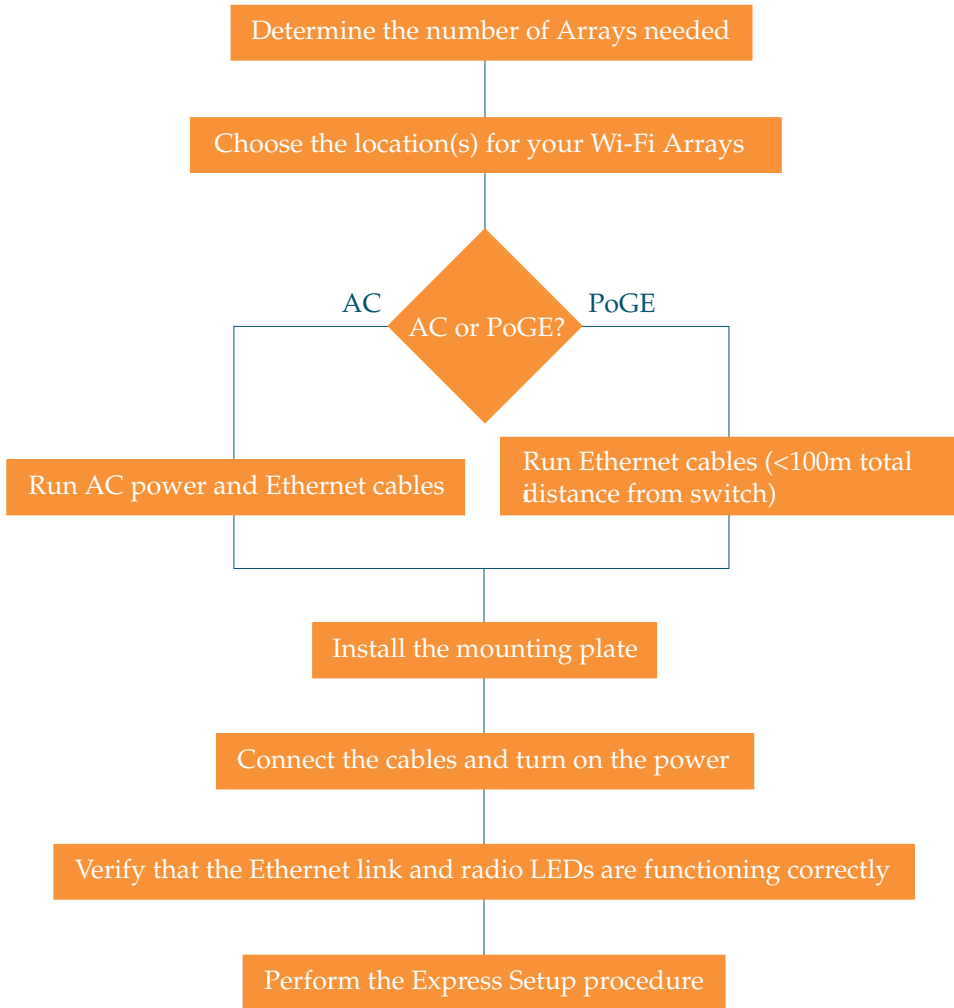

Figure 25. Installation Workflow

See Also[Coverage and Capacity Planning](#)[Deployment Examples](#)[Deployment Summary](#)[Failover Planning](#)[Installation Prerequisites](#)[Planning Your Installation](#)[Power Planning](#)[Wi-Fi Array Product Overview](#)[Product Specifications \(XN16 and XN8\)](#)[Product Specifications \(XN4\)](#)[Security Planning](#)

Unpacking the Wi-Fi Array

When you unpack your Wi-Fi Array, you will find the following items in the carton:

Item	Quantity
Xirrus Wi-Fi Array	1
AC power cord	1
Console cable	1
Mounting plate	1
Mounting screws	4
Tile grid mounting clamps	4
Clamp nuts	4
Mounting template	1

Item	Quantity
CD-ROM containing: This User's Guide in PDF format End User License Agreement (EULA) README file	1
Quick Install Guide	1
Registration Card	1

See Also

[Installation Prerequisites](#)

[Installation Workflow](#)

Installing Your Wi-Fi Array

This section provides instructions for completing a physical installation of your Xirrus Wi-Fi Array.

Choosing a Location

Based on coverage, capacity and deployment examples previously discussed, choose a location for the Array that will provide the best results for your needs. The Wi-Fi Array was designed to be mounted on a ceiling where the unit is unobtrusive and wireless transmissions can travel unimpeded throughout open plan areas.

You also have the option of mounting the Array on a wall, using the optional wall mount assembly kit. For wall mount instructions, go to [“Mounting the Array on a Wall \(XN16/XN8\)”](#) on page 62.

Choose a location that is central to your users (see the following diagram for correct placement).

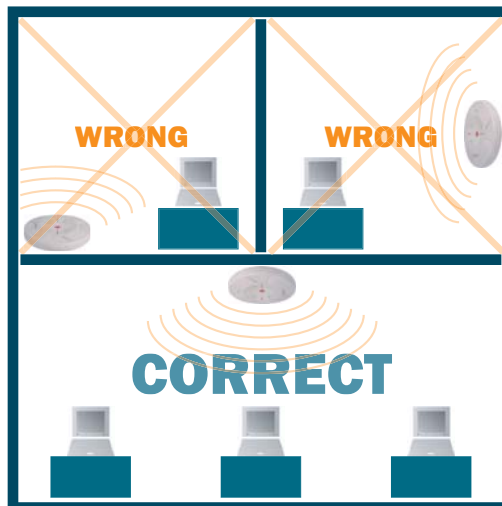

Figure 26. Array Placement

Wiring Considerations

Unless you are using the Xirrus Power over Gigabit Ethernet modules (PoGE) with an Array that supports PoGE, an AC power outlet must be available to the Array. If you are using PoGE to distribute power, see “Power over Gigabit Ethernet (PoGE) (Optional)” on page 10.

Once you have determined the best location for your Wi-Fi Array, you must run cables to the location for the following services:

Power

One of the following options:

- No power cable is required if using PoGE modules.
- Dedicated AC power if PoGE is not in use. You must use a UL-approved cord. Order the power cord from the Xirrus product list—Xirrus supplies only UL-approved power cords.

Network

- Gigabit 1—If using PoGE modules, the Cat 5e or Cat 6 cable from the Gigabit Ethernet switch to the Array must be less than 100m long. The Array must be connected to PoGE networks without routing cabling to the outside plant, to ensure that cabling is not exposed to lightning strikes or possible high voltage crossover.
- Gigabit 2 (optional)
- Fast Ethernet (optional)
- Serial cable— cable lengths up to 25’ per the RS-232 specification.

Important Notes About Network Connections

Read the following notes before making any network connections.



When the unit’s IP address is unknown or a network connection has not been established, the serial cable is used for connecting directly with the Command Line Interface (CLI) via HyperTerminal. When a network connection is established, the Array can be managed from any of the available network connections, either Fast Ethernet, Gigabit 1 or Gigabit 2.

! The Array's Ethernet ports should be plugged into an Ethernet switch, not an Ethernet hub—if a hub is used, we recommend that you connect only one Ethernet port.

! The Gigabit1 Ethernet interface is the primary port for both data and management traffic. If a single Ethernet connection is used, it must be connected to the Gigabit1 Ethernet interface. See also, "Port Failover Protection" on page 40.

The 10/100 Ethernet Port may be used for managing the Array out of band from the Gigabit Ethernet ports. The 10/100 port will route only management traffic, using a static route that may be configured for this interface. See "interface" on page 273.

See Also

Failover Planning

Installation Prerequisites

Installation Workflow

Mounting the Wi-Fi Array on a Wall (XN4)

Mounting the Array on a Wall (XN16/XN8)

Mounting the Array on a Ceiling

Power over Gigabit Ethernet (PoGE) (Optional)

Unpacking the Wi-Fi Array

Mounting the Array on a Ceiling

Most offices have drop-down acoustical ceiling tiles set into a standard grid. The Wi-Fi Array has been designed to enable mounting to a tiled ceiling via a mounting plate and clamps that attach to the grid. Once the mounting plate is attached, the Array simply rotates onto the plate (similar to a smoke detector). Once the unit is mounted it can be removed and re-attached easily, without the need for tools or modifications to the original installation.

This section assumes that you are mounting the Array to a tiled ceiling. If your ceiling is not tiled, the mounting plate can be attached directly to the ceiling with the screws and anchors provided (without using the tile grid mounting clamps).

Attaching the T-Bar Clips to the Template

The T-bar clips are used to create four mounting points on the ceiling tile grid for the Array mounting plate. Use the mounting template (provided) to find the correct location for all four clamps by pre-loading the 4 T-bar clips through the holes in the mounting template. Twist the clips until they are correctly aligned with the markings on the template.

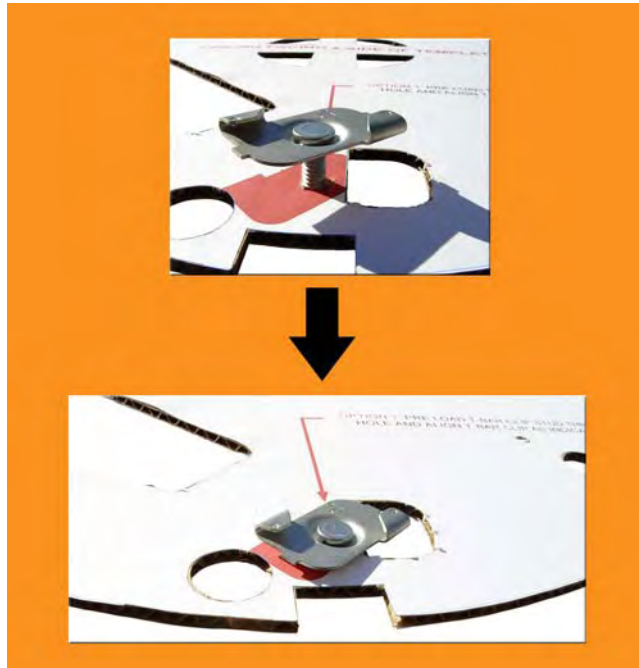

Figure 27. Attaching the T-Bar Clips to the Template

Secure the T-Bar Clips to the Ceiling Support Grid

The mounting template should be oriented so that the Array's **abg2** omnidirectional monitoring IAP (radio) is pointing in the direction of the least required wireless signal coverage—for example, a nearby exterior wall or entrance.

Use the mounting template to find the correct location for all four T-bar clips, then twist the clips onto the metal ceiling support grid and tighten the screw posts to 10-12 lbf.ft (1.38-1.66 kgf.m). See [Figure 28](#). *Do not overtighten the screw posts.*

Disengage the template from the screw posts (4 places) and remove the template from the ceiling.

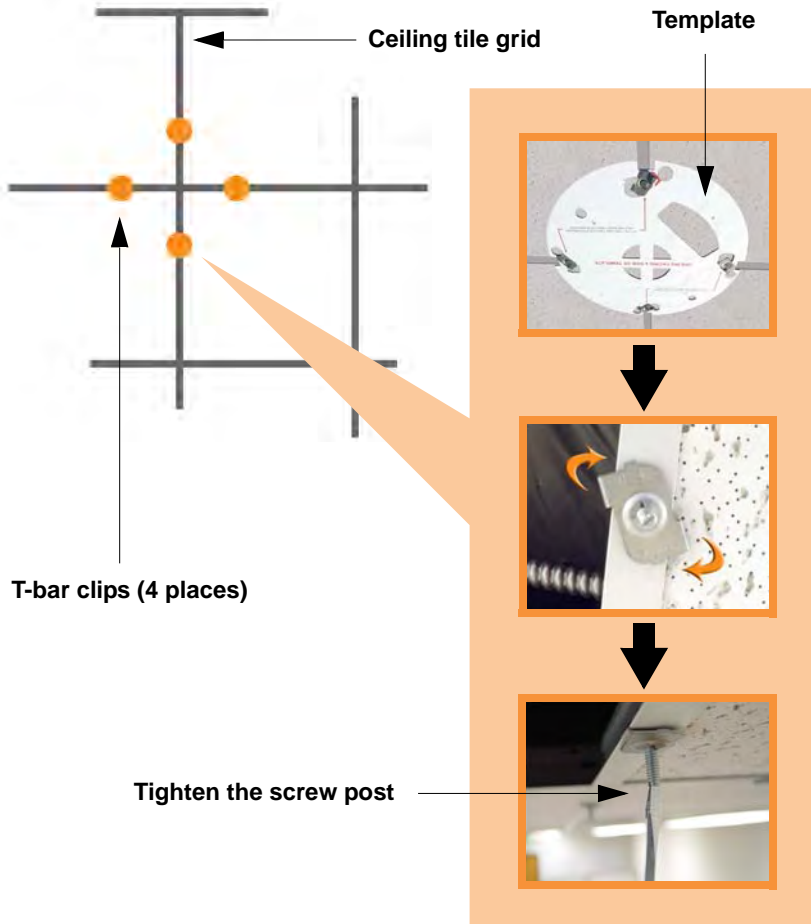

Figure 28. Attaching the T-Bar Clips to the Ceiling Grid

Installing the Mounting Plate

Locate the mounting plate on the four screw posts. Secure the plate to the four clamps using the nuts provided. Tighten the nuts to 10-12 lbf.ft (1.38-1.66 kgf.m), but *do not overtighten*.

Cut an access hole for the cables in the ceiling tile.

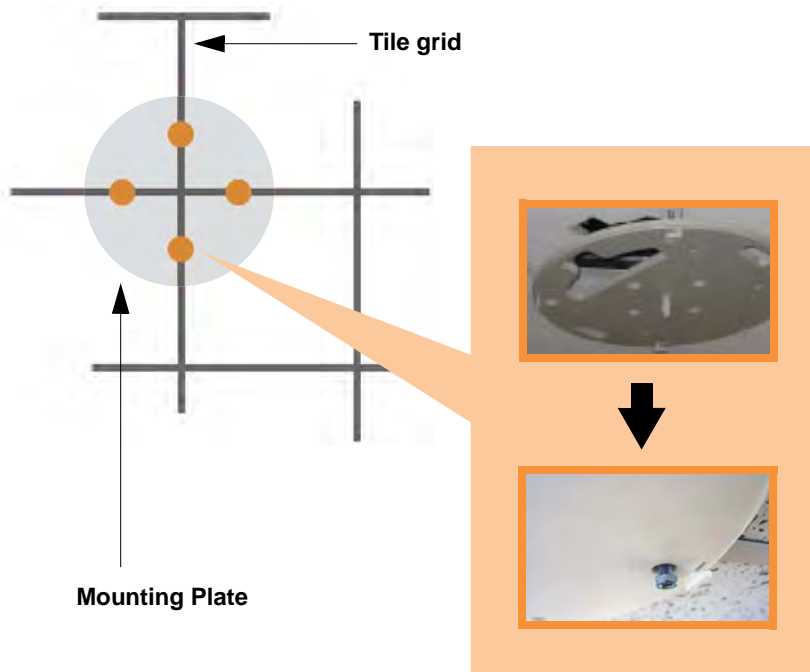

Figure 29. Installing the Mounting Plate

Connecting the Cables

Feed the power and Ethernet cables through the access hole in the tile and the mounting plate, then connect the cables to the unit. See also, “Wiring Considerations” on page 53.



Figure 30. Connecting the Cables

When the cables are connected, turn on the power switch—before attaching the unit to the mounting plate (next step). Verify that the Ethernet link LED lights and the LED boot sequence begins. The radio LEDs on the front of the unit will illuminate in rotation, indicating that the Wi-Fi Array software is loading and the unit is functioning correctly.

Attaching the Array to the Mounting Plate (XN16/XN8/XN4)

Align the Array with the key post on the mounting plate, then turn the Array to the right to lock the unit into place at the 4 lugs—similar to a smoke detector.

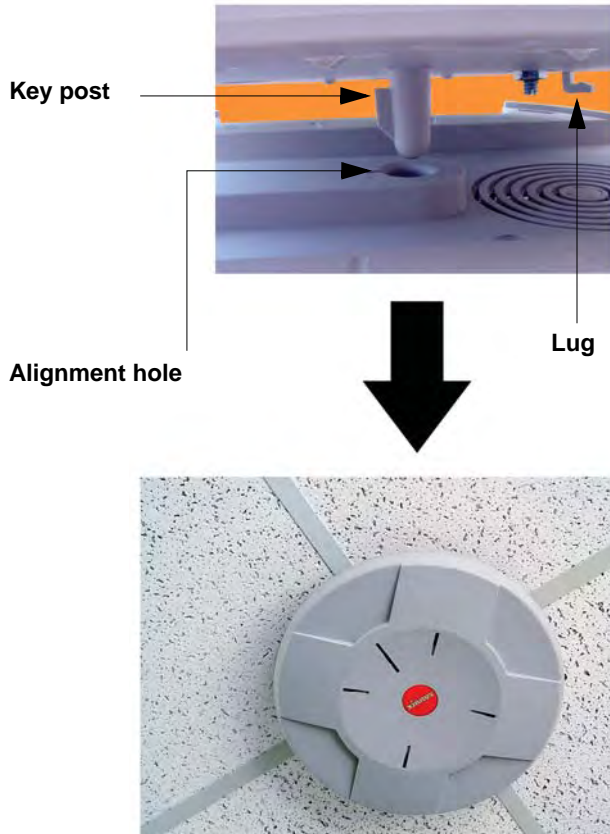

Figure 31. Attaching the Unit (XN4)

See Also

Installation Workflow

Installing Your Wi-Fi Array

Mounting the Wi-Fi Array on a Wall (XN4)

Mounting the Array on a Wall (XN16/XN8)

Securing the Array

Securing the Array

For added security, there is a locking bracket incorporated into the mounting plate, which will accept a small luggage-style padlock (if desired). There is also a Kensington lock slot located near the Ethernet ports. In addition, the mounting plate incorporates a positive locking tab that prevents the unit from being inadvertently released.



Locking bracket

Figure 32. Securing the Array

Now that the Array is physically installed, you must run the Express Setup procedure from the unit's Web Management Interface to enable the radios and establish initial system configuration settings. Go to [“Powering Up the Wi-Fi Array”](#) on page 73.

See Also

[Installation Workflow](#)

[Installing Your Wi-Fi Array](#)

[Mounting the Wi-Fi Array on a Wall \(XN4\)](#)

[Mounting the Array on a Wall \(XN16/XN8\)](#)

[Mounting the Array on a Ceiling](#)

[Powering Up the Wi-Fi Array](#)

Dismounting the Array

To dismount the Array, place your fingers so as to increase the space between the Array and the mounting plate at the positions indicated by the decals on the mounting plate—these are aligned with IAPs (radios) abg1 and abg3, as indicated on the clock-face of the Array.

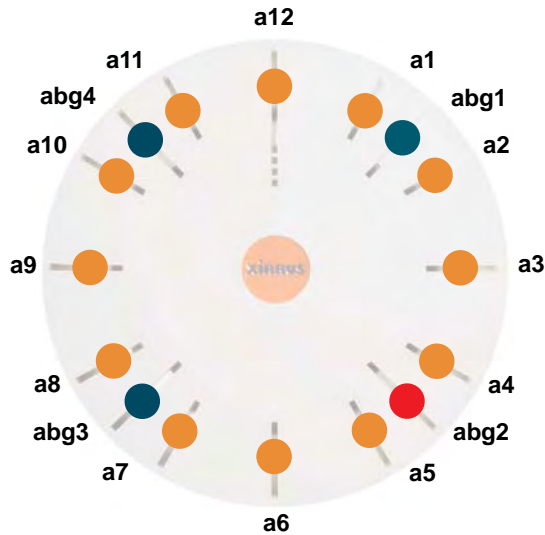

Figure 33. IAP Positions (XN16)

See Also

[Installation Workflow](#)

[Installing Your Wi-Fi Array](#)

[Mounting the Wi-Fi Array on a Wall \(XN4\)](#)

[Mounting the Array on a Wall \(XN16/XN8\)](#)

[Mounting the Array on a Ceiling](#)

[Securing the Array](#)

Mounting the Array on a Wall (XN16/XN8)

This procedure is applicable to the Wi-Fi Array's 16-radio models (XN16) and 8-radio models (XN8). If you are mounting a 4 radio model, go to ["Mounting the Wi-Fi Array on a Wall \(XN4\)"](#) on page 67.

The wall mounting assembly kit is used to mount the Wi-Fi Array (16-radio or 8-radio models) on a wall, instead of the traditional ceiling mount—if mounting the Array on the ceiling is impractical at your location.

Kit Contents (Wall Mount Assembly - XN16 and XN8)

The wall mount assembly kit includes the following items:

- 5 x SNAPTOGGLE™ toggle bolts (for attaching the wall bracket to the wall)
- 4 x 1/4 inch bolt assemblies (for attaching the mounting plate to the wall bracket)
- Wall Mounting Bracket

Tools Required

- Power drill
- 1/2 inch (13mm) drill bit
- Cross head screwdriver
- 1/4 inch nut wrench
- Pencil
- Level

Mark the Wall Position

1. Use the Wall Mounting Bracket as a template and mark the locations on the wall for the mounting holes.

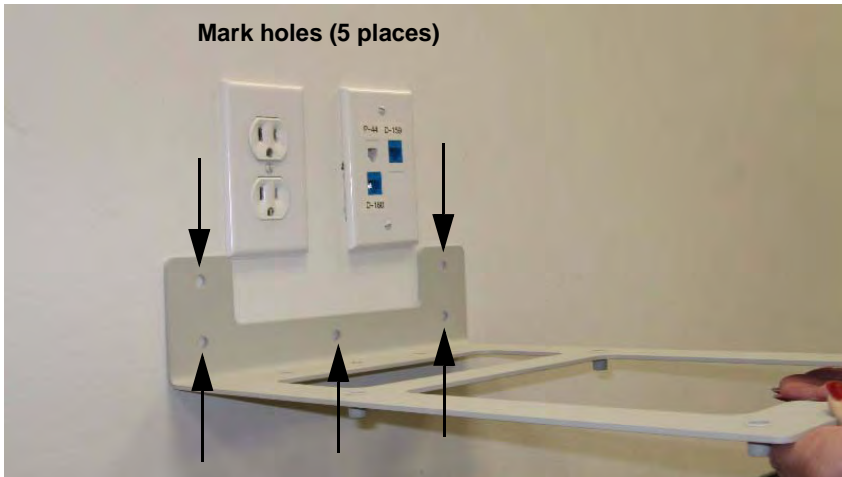

Figure 34. Wall Mount—Marking the Holes

When marking the holes, ensure that the mounting plate is level—you may need assistance.



The bracket must be secured to the wall in 5 places, using the 2 holes at the top and the 3 holes at the bottom (5 toggle bolts are provided).