

Canon

PUB. DIM-855A

DVD Camcorder

Instruction Manual

Caméscope DVD

Manuel d'instruction

Videocámara DVD

Manual de Instrucciones

DC330



Please read also the **Digital Video Software** instruction manual (on PDF file). Refer to the installation guide for further details.

Veuillez lire aussi le manuel d'instruction **Digital Video Software** (sur fichier PDF). Pour d'autres détails, référez-vous au guide d'installation.

Lea también el manual de instrucciones **Digital Video Software** (en archivo PDF). Para mayores detalles, refiérase a la guía de instalación.

English

Français

Español



Important Usage Instructions

WARNING!



TO REDUCE THE RISK OF FIRE OR ELECTRIC SHOCK, DO NOT EXPOSE THIS PRODUCT TO RAIN OR MOISTURE.

WARNING!



TO REDUCE THE RISK OF ELECTRIC SHOCK AND TO REDUCE ANNOYING INTERFERENCE, USE THE RECOMMENDED ACCESSORIES ONLY.

COPYRIGHT WARNING:

Unauthorized recording of copyrighted materials may infringe on the rights of copyright owners and be contrary to copyright laws.

DVD Camcorder, DC330 A systems

This device complies with Part 15 of the FCC Rules. Operation is subject to the following two conditions: (1) This device may not cause harmful interference, and (2) this device must accept any interference received, including interference that may cause undesired operation.

Note: This equipment has been tested and found to comply with the limits for class B digital device, pursuant to Part 15 of the FCC Rules. These limits are designed to provide reasonable protection against harmful interference in a residential installation. This equipment generates, uses and can radiate radio frequency energy and, if not installed and use in accordance with the instructions, may cause harmful interference to radio communications. However, there is no guarantee that interference will not occur in a particular installation. If this equipment does cause harmful interference to radio or television reception, which can be determined by turning the equipment off and on, the user is encouraged to try to correct the interference by one or more of the following measures:

- Reorient or relocate the receiving antenna.
- Increase the separation between the equipment and receiver.
- Connect the equipment into an outlet on a circuit different from that to which the receiver is connected.
- Consult the dealer or an experienced radio/TV technician for help.

The cable with the ferrite core provided with the digital video camcorder must be used with this equipment in order to comply with Class B limits in Subpart B of Part 15 of the FCC rules.

Do not make any changes or modifications to the equipment unless otherwise specified in the manual.

If such changes or modifications should be made, you could be required to stop operation of the equipment.

Canon U.S.A. Inc.

One Canon Plaza, Lake Success, NY 11042, U.S.A.

Tel No. (516)328-5600

CAUTION:

TO PREVENT ELECTRIC SHOCK, MATCH WIDE BLADE OF PLUG TO WIDE SLOT, FULLY INSERT.

Important Warning



The lightning flash with arrowhead symbol, within an equilateral triangle, is intended to alert the user to the presence of uninsulated "dangerous voltage" within the product's enclosure, that may be of sufficient magnitude to constitute a risk of electric shock to persons.

CAUTION:

TO REDUCE THE RISK OF ELECTRIC SHOCK, DO NOT REMOVE COVER (OR BACK). NO USER-SERVICEABLE PARTS INSIDE. REFER SERVICING TO QUALIFIED SERVICE PERSONNEL.



The exclamation point, within an equilateral triangle, is intended to alert the user to the presence of important operating and maintenance (servicing) instructions in the literature accompanying the product.

IMPORTANT SAFETY INSTRUCTIONS

In these safety instructions the word “product” refers to the Canon DVD Camcorder DC330 A and all its accessories.

- 1** Read Instructions — All the safety and operating instructions should be read before the product is operated.
- 2** Retain Instructions — The safety and operating instructions should be retained for future reference.
- 3** Heed Warnings — All warnings on the product and in the operating instructions should be adhered to.
- 4** Follow Instructions — All operating and maintenance instructions should be followed.
- 5** Cleaning — Unplug this product from the wall outlet before cleaning. Do not use liquid or aerosol cleaners. The product should be cleaned only as recommended in this manual.
- 6** Accessories — Do not use accessories not recommended in this manual as they may be hazardous.
- 7** Avoid magnetic or electric fields — Do not use the camera close to TV transmitters, portable communication devices or other sources of electric or magnetic radiation. They may cause picture interference, or permanently damage the camera.
- 8** Water and Moisture — Hazard of electric shock — Do not use this product near water or in rainy/moist situations.
- 9** Placing or Moving — Do not place on an unstable cart, stand, tripod, bracket or table. The product may fall, causing serious injury to a child or adult, and serious damage to the product.

A product and cart combination should be moved with care. Quick stops, excessive force, and uneven surfaces may cause the product and cart combination to overturn.



- 10** Power Sources — The CA-570 Compact Power Adapter should be operated only from the type of power source indicated on the marking label. If you are not sure of the type of power supply to your home, consult your product dealer or local power company. Regarding other power sources such as battery power, refer to instructions in this manual.
- 11** Polarization — The CA-570 Compact Power Adapter is equipped with a polarized 2-prong plug (a plug having one blade wider than the other).
The 2-prong polarized plug will fit into the power outlet only one way. This is a safety feature. If you are unable to insert the plug fully into the outlet, try reversing the plug. If the plug still fails to fit, contact your electrician to replace your obsolete outlet. Do not defeat the safety purpose of the polarized plug.
- 12** Power Cord Protection — Power cords should be routed so that they are not likely to be walked on or pinched by items placed upon or against them. Pay particular attention to plugs and the point from which the cords exit the product.
- 13** Outdoor Antenna Grounding — If an outside antenna is connected to the product, be sure the antenna is grounded so as to provide some protection against voltage surges and built-up static charges. Section 810 of the National Electrical Code, ANSI / NFPA No. 70—1984, provides information with respect to proper grounding of the mast and supporting structure, grounding of the lead-in wire to an antenna discharge unit, size of grounding conductors, location of antenna discharge unit, connection to grounding electrodes, and requirements for the grounding electrode. See figure 1.

Fig. 1 EXAMPLE OF ANTENNA GROUNDING AS PER NATIONAL ELECTRICAL CODE

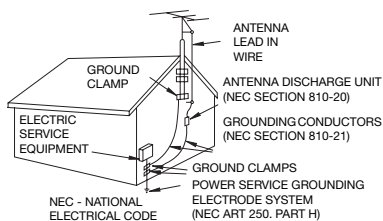

14 Lightning — For added protection of this product during a lightning storm, or when it is left unattended and unused for long periods of time, disconnect it from the wall outlet and disconnect the antenna. This will prevent damage to the product due to lightning and power-line surges.

15 Overloading — Do not overload wall outlets and extension cords as this can result in a risk of fire or electric shock.

16 Objects and Liquid Entry — Never push objects of any kind into this product through openings as they may touch dangerous voltage points or short out parts that could result in a fire or electric shock. Be careful not to spill liquid of any kind onto the product.

17 Servicing — Do not attempt to service this product yourself as opening or removing covers may expose you to dangerous voltage or other hazards. Refer all servicing to qualified service personnel.

18 Damage Requiring Service — Disconnect this product from the wall outlet and all power sources including battery, and refer servicing to qualified service personnel under the following conditions:

- When the power-supply cord or plug is damaged.
- If any liquid has been spilled onto, or objects have fallen into, the product.
- If the product has been exposed to rain or water.
- If the product does not operate normally even if you follow the operating instructions. Adjust only those controls that are covered by the operation instructions. Improper adjustment of other controls may result in damage and will often require extensive work by a qualified technician to restore the product to its normal operation.
- If the product has been dropped or the cabinet has been damaged.
- When the product exhibits a distinct change in performance. This indicates a need for service.

19 Replacement Parts — When replacement parts are required, be sure the service technician has used replacement parts that are specified by Canon or that have the same characteristics as the original part. Unauthorized substitutions may result in fire, electric shock or other hazards.

20 Safety Check — Upon completion of any service or repairs to this product, ask the service technician to perform safety checks to determine that the product is in safe operating order.

When replacement of the power supply is required, please return it to the responsible nearest Canon Service Center and please replace it with the same type number CA-570.

The Adapter can be used with a power supply between 100 and 240 V AC. For areas where 120 V AC power is not used, you will need a special plug adapter. Contact your nearest Canon Service Center for further information.

This Class B digital apparatus complies with Canadian ICES-003.

How to Select a DVD Disc

There are many types of DVD discs but this camcorder uses only the following three types of 8 cm mini DVD discs: DVD-R, DVD-R DL and DVD-RW. Read the differences between them and select the disc that best fits your needs.

DVD-R

Best for Compatibility

DVD-Rs can be recorded only once – you cannot edit or delete the recordings. On the other hand, these discs are comparatively cheaper.

DVD-R DL

Best for Recording Time

Dual-layered discs allow writing up to 80% more data (approx. 2.6 GB) on a single recording side. However, you cannot edit or delete the recordings.

Dual-layered discs have two recording layers. The camcorder will record on layer 1 and then continue to layer 2. During the playback of a recording spanning both layers, you may notice a brief stop (about 1 second) at the point where the camcorder switches to the second layer. The switch to layer 2 will break the recording into 2 separate scenes.

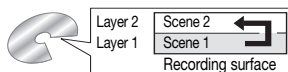

DVD-RW

Best for Reusability

Recordings made on a DVD-RW disc can be edited or deleted. Also, the disc can be initialized. Initializing a DVD-RW disc clears all the recordings and restores the free space on the disc to its initial value so you can use the same disc again.

Disc specification on DVD-RWs

DVD-RW discs can be recorded using either one of two disc specifications: VIDEO mode or VR mode. When you first insert a brand new DVD-RW disc, the camcorder will automatically display the initialization screen where you can select the disc specification for the disc.

VIDEO mode: Once finalized, discs recorded in VIDEO mode can be played back in most common DVD players offering the best compatibility. However, recordings cannot be edited (deleted, rearranged, etc.).

VR mode: You can easily edit the recordings. However, discs recorded in VR mode can only be played back with DVD players compatible with DVD-RWs in VR mode.

Note: DVD-R and DVD-R DL discs can only be recorded in VIDEO mode.

Advantages of Using DVDs

No need to worry about recording over a tape.

When you use a DVD, the camcorder will automatically record on the empty space of the disc. So you don't have to worry about mistakenly recording over a precious memory.

Just select a scene from the index screen.

You don't need to bother running a tape forwards and backwards to find the scene you want to play back. Simply select a scene from the index screen and start the playback in a breeze.

Easily play back your recordings on a DVD player.

After you finalize your DVD (□ 49), you can play it on a DVD player and share your recordings with friends and family.

Playback on external devices

Make sure to finalize discs (□ 49) before you play them back on external DVD devices. The disc's type will affect its compatibility with external devices. For a summary, you can refer to the sidebar on page 50. However, to be sure, always refer to the instruction manual of the external device and make sure it is compatible before inserting the disc.

For the highest compatibility with external DVD devices we recommend using VIDEO mode.

Discs that have been tested

The camcorder's performance was tested with single-layered discs using Hitachi-Maxell HG series DVD discs; and with dual-layered discs using Canon DVD-R DL54 discs and Verbatim DVD-R DL discs (as of January 2008*). For further details, contact directly the manufacturer's customer support center. Note that attempting to record or play with this camcorder DVD discs that were recorded, initialized or finalized with a device other than this camcorder can result in damage to the camcorder or in the permanent loss of the recordings.

* For the latest information, visit your local Canon Web site or contact your nearest Canon office. The use of DVD-R DL discs that have not been tested by Canon may result in incorrect recording/playback or in not being able to remove the disc.

Available features depend on the DVD disc used

Disc type	DVD-R, DVD-R DL	DVD-RW	
		VIDEO mode	VR mode
Editing scenes with this camcorder (deleting scenes, dividing scenes, etc.) (□ 46)	–	–	● ¹
Deleting a scene after recording it (□ 35)	–	●	●
Initializing the disc in order to use it again for recording (□ 48)	–	●	●
Giving a title to the disc (□ 48)	●	●	●
Finalizing the disc in order to play it with an external DVD device (□ 49) ²	●	●	●
Adding recordings to a disc already finalized (□ 50)	–	● ³	●
Editing scenes on a computer ⁴ (□ 68)	●	●	●

¹ Only scenes in the playlist can be divided.

² Disc finalization is the processing of the free space (the unrecorded area) on the disc in order to make it playable on external DVD devices (□ 49). Playback cannot be guaranteed with all external DVD devices. To finalize a DVD-R DL disc, the camcorder has to process both layers. Therefore, and depending on the amount of free space on the disc, this process may be lengthy.

³ You will need to unfinalize the disc first.

⁴ With the supplied software you can make copies of your disc, play back and edit your video, and more. For further details, refer to the **Corel Application Disc Installation Guide and User Manual**.

Table of contents

Introduction

- 5 How to Select a DVD Disc
- 6 Advantages of Using DVDs
- 11 About this Manual

12 Getting to Know the Camcorder

- 12 Supplied Accessories
- 13 Components Guide
- 16 Screen Displays



Preparations

19 Getting Started

- 19 Charging the Battery Pack
- 20 Preparing the Wireless Controller and Accessories

22 Basic Operation of the Camcorder

- 22 Power Switch
- 22 Operating Modes
- 22 Joystick and Joystick Guide
- 23 Using the Menu

25 First Time Settings

- 25 Setting the Date and Time
- 25 Changing the Language
- 26 Changing the Time Zone

26 Getting Ready to Start Recording

- 26 Opening the Lens Cover and Adjusting the LCD screen
- 27 Inserting and Removing a Disc
- 29 Inserting and Removing a Memory Card



Video

30 Basic Recording

- 30 Shooting Video
- 32 Selecting the Recording Mode
- 32 Zooming: Optical, Advanced and Digital Zoom
- 34 Quick Start Function
- 34 Reviewing and Deleting the Last Scene Recorded

35	Basic Playback
35	Playing Back the Video
37	Deleting Scenes
37	On-Screen Displays (Data Code)
38	Additional Functions
38	[P] : Special Scene Recording Programs
40	[P] Flexible Recording: Changing the Shutter Speed
41	LCD Video Light
41	Self Timer
42	Manual Focus Adjustment
43	Manual Exposure Adjustment
43	White Balance
44	Image Effects
45	Digital Effects
46	Managing Scenes and the Disc
46	Creating a Playlist
47	Moving Scenes in the Playlist
47	Dividing Scenes
48	Initializing the Disc
48	Disc Playback on an External Device
48	Changing the Disc Title
49	Finalizing the Disc
50	Disc Playback on External Devices
50	Unfinalizing the Disc - Additional Recordings on a Finalized Disc



Photos

52	Basic Recording
52	Taking Photos
53	Selecting Photo Size and Quality
54	Erasing the Last Photo Just Recorded
54	Basic Playback
54	Viewing Photos
56	Magnifying Photos during Playback
56	Erasing Photos
57	Additional Functions
57	Continuous Shooting and Exposure Bracketing (Drive Mode)
58	Automatic Focus Priority
59	Histogram and Other Screen Displays
59	Protecting Photos
60	Initializing the Memory Card

- 61 Printing Photos**
- 61 Printing Photos - Direct Print
- 61 Selecting the Print Settings
- 64 Print Orders



External Connections

- 66 Connecting to a TV or VCR**
- 66 Connection Diagram
- 67 Playback on a TV Screen
- 67 Copying your Recordings to an External Video Recorder
- 68 Connecting to a Computer**
- 68 PC Connection Diagram
- 68 Corel Application Disc - Movie Playback/Editing and Various Disc Operations
- 68 Transferring Photos - Direct Transfer
- 70 Transfer Orders



Additional Information

- 72 Appendix: Menu Options Lists**
- 72 FUNC. Menu
- 72 Setup menus
- 74 Camera Setup (Advanced Zoom, Image Stabilizer, etc.)
- 75 Disc Operations (Initialization, Finalization etc.)
- 75 Still Image Operations (Card Initialization, etc.)
- 76 Display Setup (LCD Brightness, Language, etc.)
- 77 System Setup (Volume, Beep, etc.)
- 78 Date/Time Setup
- 79 Trouble?**
- 79 Troubleshooting
- 82 List of Messages
- 86 Do's and Don'ts**
- 86 Handling Precautions
- 90 Using the Camcorder Abroad
- 92 General Information**
- 92 System Diagram
- 93 Optional Accessories
- 95 Product Codes
- 96 Specifications
- 99 Index

About this Manual

Thank you for purchasing the Canon DC330. Please read this manual carefully before you use the camcorder and retain it for future reference. Should your camcorder fail to operate correctly, refer to *Troubleshooting* (☞ 79).

Conventions Used in this Manual

- **!** IMPORTANT: Precautions related to the camcorder's operation.
- **i** NOTES: Additional topics that complement the basic operating procedures.
- **⊞** POINTS TO CHECK: Restrictions that apply if the function described is not available in all operating modes (the operating mode to which the camcorder should be set, the type of disc required, etc.).
- ☞: Reference page number.
- The following terms are used in this manual:
 - “Screen” refers to the LCD and the viewfinder screen.
 - “Scene” refers to one movie unit from the point you press **Start/Stop** to start recording until you press again to pause the recording.
 - The terms “photo” and “still image” are used interchangeably with the same meaning.
- The photos included in this manual are simulated pictures taken with a still camera.



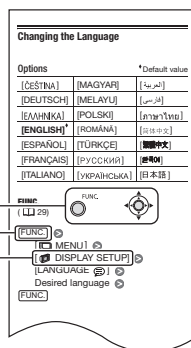

Buttons and switches to be operated

Names of buttons and switches other than the joystick are indicated within a “button” frame.
For example **[FUNC.]**.

Brackets [] and capital letters are used to refer to menu options as they are displayed on screen. In menu option lists and option tables the default value is shown in boldface.
For example **[ON]**, **[OFF]**.

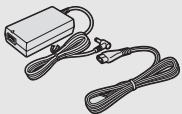
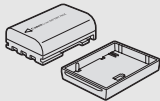

Supplied Accessories

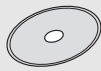
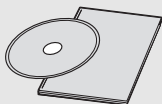
	CA-570 Compact Power Adapter (incl. power cord)		NB-2LH Battery Pack
WL-D86 Wireless Controller		Lithium Button Battery CR2025 for Wireless Controller	
	IFC-300PCU USB Cable		STV-250N Stereo Video Cable Yellow • Red • White plugs
Software CD-ROM* DIGITAL VIDEO Solution Disk		Software CD-ROM and User Manual Corel Application Disc	

* Includes the electronic version of the *Digital Video Software* instruction manual on PDF file.

Online product registration for U.S.A. Customers only.

Register your product online at www.registercanon.com

✓ **Protect your product**

We will keep the model number and date of purchase of your new Canon product on file to help you refer to this information in the event of an insurance claim such as loss or theft.

✓ Receive information on new products and promotions

Upon your request, we will send you information on Canon new products and promotions.

The serial number of this product can be found at the battery attachment unit of the camcorder. Write down the number and other information here and retain this book as a permanent record of your purchase to aid identification in case of theft.

Date of Purchase:

Model Name: DC330 A

Purchased From:

Serial No.:

Dealer Address:

Dealer Phone No.:

Components Guide

Left side view

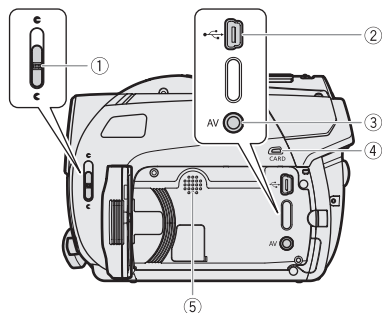

Right side view

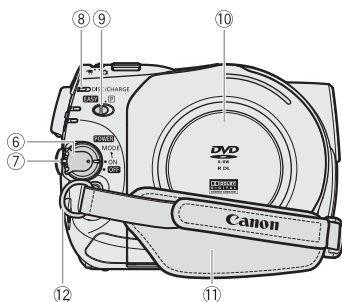

Front view



- ① Lens cover switch (☐ 30, 52)
(☐ open, ● closed)
- ② USB terminal (☐ 68)
- ③ AV terminal (☐ 66)
- ④ CARD access indicator (☐ 52)
- ⑤ Speaker
- ⑥ **POWER** switch (☐ 22)
- ⑦ Lock button
- ⑧ DISC access indicator (☐ 30) /
CHARGE indicator (☐ 19)
- ⑨ Mode switch (☐ 31)
EASY Easy recording
☐ Recording programs
- ⑩ Disc compartment cover (☐ 27)
- ⑪ Grip belt (☐ 21)
- ⑫ Strap mount (☐ 94)
- ⑬ Stereo microphone

Names of buttons and switches other than the joystick are indicated within a “button” frame (for example **[FUNC.]**).

Back view

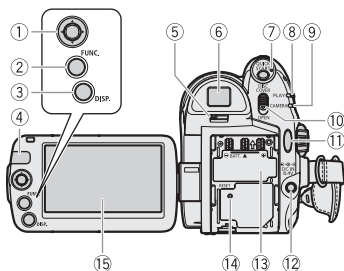

Top view

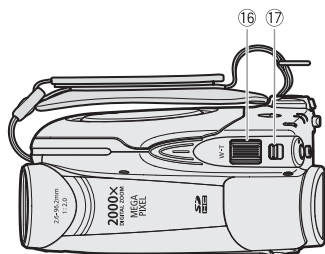

Bottom view

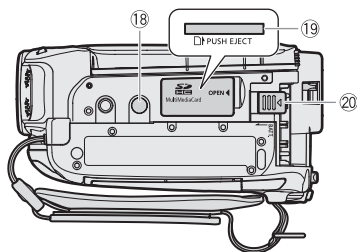

- ① Joystick (22)
- ② FUNC. button (23, 72)
- ③ DISP. button (37, 59)
- ④ Remote sensor (20)
- ⑤ Dioptic adjustment lever (31)
- ⑥ Viewfinder (31)
- ⑦ QUICK START button and standby lamp (34)
- ⑧ PLAY mode indicator (green) (22)
- ⑨ CAMERA mode indicator (red) (22)
- ⑩ OPEN (disc cover) switch (27)
- ⑪ Start/Stop button (30)
- ⑫ DC IN terminal (20)
- ⑬ Serial number/
Battery attachment unit (19)
- ⑭ RESET button (79)
- ⑮ LCD screen (26)
- ⑯ Zoom lever (32)
- ⑰ / (movies/still images) switch (22)
- ⑱ Tripod socket (21)
- ⑲ Memory card slot
(open the cover to access) (29)
- ⑳ BATT. (battery release) switch (19)

Names of buttons and switches other than the joystick are indicated within a “button” frame (for example **FUNC.**).

Wireless Controller WL-D86

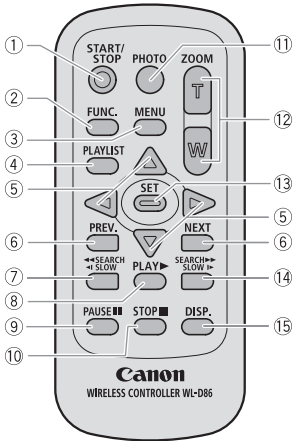



- ① START/STOP button (□ 30)
- ② FUNC. button (□ 23, 72)
- ③ MENU button (□ 24)
- ④ PLAYLIST button (□ 46)
- ⑤ Navigation buttons (▲/▼/◀/▶)
- ⑥ PREV./NEXT buttons:
Scene skip (□ 36) /
Index screen page up/down (□ 35)
- ⑦ Reverse ◀◀ SEARCH button (□ 36) /
Reverse ◀ SLOW button (□ 36)
- ⑧ PLAY ▶ button (□ 35)
- ⑨ PAUSE ■■ button (□ 35)
- ⑩ STOP ■ button (□ 35)
- ⑪ PHOTO button (□ 52)
- ⑫ Zoom buttons (□ 32)
- ⑬ SET button
- ⑭ Forward SEARCH ▶▶ button (□ 36) /
Forward SLOW ▶ button (□ 36)
- ⑮ DISP. (on-screen display) button
(□ 37, 59)

Screen Displays

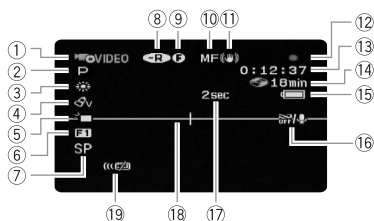
CAMERA Recording movies





- ① Operating mode (□ 22) / Disc specification (□ 5)
- ② Recording program (□ 38, 40)
- ③ White balance (□ 43)
- ④ Image effect (□ 44)
- ⑤ LCD video light (□ 41)
- ⑥ Digital effects (□ 45)
- ⑦ Recording mode (□ 32)
- ⑧ Disc type  DVD-R,  DVD-R DL,  DVD-RW (□ 5)
- ⑨ Finalized disc mark (□ 49)
- ⑩ Manual focus (□ 42)
- ⑪ Image stabilizer (□ 74)
- ⑫ Disc operation
- ⑬ Time code/Playback time (hours : minutes : seconds)
- ⑭ Remaining recording time on the disc
- ⑮ Remaining battery charge (□ 18)
- ⑯ Wind screen off (□ 74)
- ⑰ Recording reminder
- ⑱ Level marker (□ 76)
- ⑲ Remote sensor off (□ 77)
- ⑳ Scene number
- ㉑ Joystick guide (□ 22)
- ㉒ Data code (□ 37)

PLAY Playing movies (during playback)

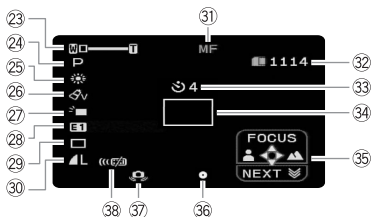

CAMERA · Recording still images



- 23 Zoom (□ 32), Exposure  (□ 43)
- 24 Recording program (□ 38, 40)
- 25 White balance (□ 43)
- 26 Image effect (□ 44)
- 27 LCD video light (□ 41)
- 28 Digital effects (□ 45)
- 29 Drive mode (□ 57)
- 30 Still image quality/size (□ 53)
- 31 Manual focus (□ 42)
- 32 Number of still images available on the memory card
- 33 Self timer (□ 41)
- 34 AF frame (□ 58)
- 35 Joystick guide (□ 22)

PLAY · Viewing still images

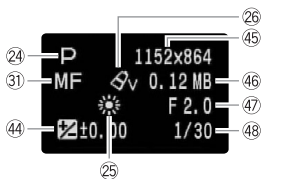
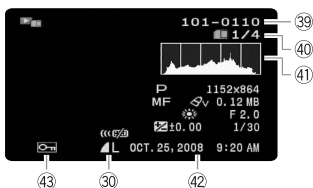

- 36 Focus/exposure automatically set and locked (□ 52)
- 37 Camcorder shake warning (□ 74)
- 38 Remote sensor off (□ 20)
- 39 Image number (□ 18)
- 40 Current image / Total number of images
- 41 Histogram (□ 59)
- 42 Date and time of recording
- 43 Image protection mark (□ 59)
- 44 Manual exposure (□ 43)
- 45 Image size (□ 53)
- 46 File size
- 47 Aperture value (□ 40)
- 48 Shutter speed (□ 40)

12 Disc operation



- Record, ● ||| Record pause,
- ▶ Playback, ||| Playback pause,
- ▶▶ Fast playback,
- ◀◀ Fast reverse playback,
- ▶ Slow playback,
- ◀ Slow reverse playback

14 Remaining recording time

When there is no more disc space available, “END” will be displayed and the recording will stop.

15 Remaining battery charge estimate





- When  is displayed in red, replace the battery pack with a fully charged one.
- When you attach an empty battery pack, the power may turn off without displaying .
- Depending on the conditions under which the camcorder and the battery pack are used, the actual battery charge may not be indicated accurately.

17 Recording reminder

The camcorder counts from 1 to 10 seconds when you start recording. This is helpful to avoid scenes that are too short.

32 Number of still images available on the card

 displayed in red: No card

 in green: 6 or more images

 in yellow: 1 to 5 images

 in red: No more images can be recorded

- When viewing the still images, the display will always be in green.
- Depending on the recording conditions, the number of available still images displayed may not decrease even after a recording has been made, or may decrease by 2 still images at once.

Card access display

▶  is displayed next to the number of images available while the camcorder is writing on the memory card.

39 Image number

The image number indicates the name and location of the file on the memory card. For example, the file name of image 101-0107 is “IMG_0107.JPG”, stored under the folder “DCIM\101CANON”.



Preparations

This chapter describes basic operations, such as navigating the menus, and first time settings to help you learn more about your camcorder.

Getting Started

Charging the Battery Pack

The camcorder can be powered with a battery pack or directly using the compact power adapter. Charge the battery pack before use.

For approximate charging times and recording/playback times with a full battery pack, refer to the tables on page 93.

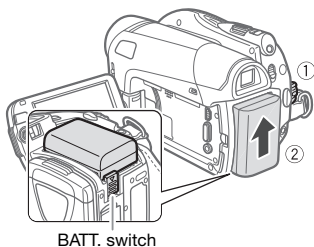

- 1 Turn off the camcorder.**
- 2 Attach the battery pack to the camcorder.**

Press the battery pack lightly and slide it up until it clicks.

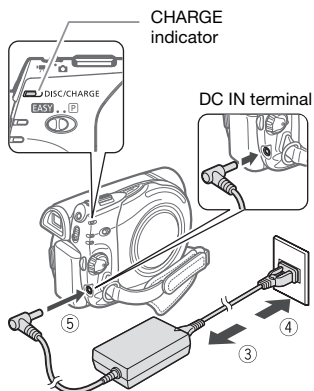

- 3 Connect the power cord to the compact power adapter.**
- 4 Plug the power cord into a power outlet.**
- 5 Connect the compact power adapter to the camcorder's DC IN terminal.**

- The CHARGE indicator starts flashing. The indicator will stay on when the charging is completed.
- You can also use the compact power adapter without attaching a battery pack.
- When the compact power adapter is connected, the power of the battery pack will not be consumed.

ONCE THE BATTERY PACK IS FULLY CHARGED

- 1 **Disconnect the compact power adapter from the camcorder.**
- 2 **Unplug the power cord from the power outlet and the compact power adapter.**

TO REMOVE THE BATTERY PACK

Press **[BATT.]** to release the battery pack. Slide the battery pack down and then pull it out.

! IMPORTANT

- Turn off the camcorder before connecting or disconnecting the compact power adapter. After you turn the **[POWER]** switch to **OFF**, important file allocation data is updated on the disc. Be sure to wait until the **PLAY** and **CAMERA** mode indicators are completely off.
- You may hear some noise from the compact power adapter during use. This is not a malfunction.
- We recommend charging the battery pack in temperatures between 10 °C and 30 °C (50 °F and 86 °F). Outside the temperature range of 0 °C to 40 °C (32 °F to 104 °F), the charging will not start.
- Do not connect to the camcorder's DC IN terminal or to the compact power adapter any electrical equipment that is not expressly recommended for use with this camcorder.
- To prevent equipment breakdowns and excessive heating, do not connect the supplied compact power adapter to voltage converters for overseas travels or special power sources such as those on aircraft and ships, DC-AC inverters, etc.

i NOTES

- The **CHARGE** indicator also serves as a rough estimate of the charge status.
Continuously on: Battery pack fully charged.
Two quick flashes at 1-second intervals: Battery pack at least 50% charged. If the indicator flashes quickly but not exactly in this pattern, refer to *Troubleshooting* (□ 79).
One flash at 1-second intervals: Battery pack less than 50% charged.
- We recommend that you prepare battery packs to last 2 to 3 times longer than you think you might need.
- **U.S.A. and Canada only:** The Lithium ion/polymer battery that powers the product is recyclable. Please call 1-800-8-BATTERY for information on how to recycle this battery.



Preparing the Wireless Controller and Accessories

Using the Wireless Controller

First, insert the supplied lithium button battery CR2025 into the wireless controller.

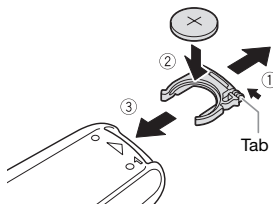

- 1 **Press the tab in the direction of the arrow and pull out the battery holder.**



2 Place the lithium button battery with the + side facing up.

3 Insert the battery holder.

TO USE THE WIRELESS CONTROLLER

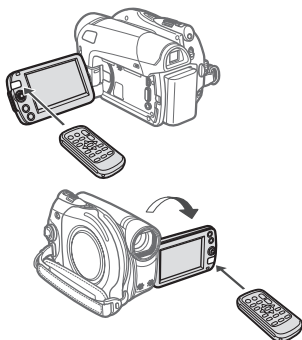

Point the wireless controller at the camcorder's remote sensor when you press the buttons.

You can rotate the LCD panel 180 degrees to use the wireless controller from the front of the camcorder.

i NOTES

- The wireless controller may not work properly when the remote sensor is situated under strong light sources or direct sunlight.
- If the wireless controller does not work, check that [WL.REMOTE] is not set to [OFF OFF (OFF)] (p. 77). Otherwise, replace the battery.

Accessories

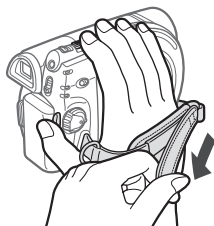

Fasten the grip belt.

Adjust the grip belt so that you can reach the zoom lever with your index finger, and the [Start/Stop] button with your thumb.

WHEN YOU MOUNT THE CAMCORDER ON A TRIPOD

Do not leave the viewfinder exposed to direct sunlight as it may melt (due to concentration of the light by the lens). Do not use tripods with fastening screws longer than 5.5 mm (0.2 in.). Doing so may damage the camcorder.

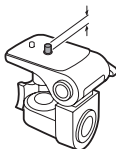

Basic Operation of the Camcorder

Power Switch

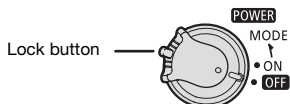

In addition to turning the camcorder on and off, the **POWER** switch also toggles the camcorder's operating mode.

To turn on the camcorder: Hold the lock button pressed down and turn the **POWER** switch to ON.

To change the operating mode: From the ON position, turn the **POWER** switch momentarily toward MODE and release it. This action will toggle the operating mode between recording (CAMERA - red indicator) and playback (PLAY - green indicator).

Operating Modes

The camcorder's operating mode is determined by the **POWER** switch and the position of the **MODE** switch. In this manual, **CAMERA** indicates that a function is available in the operating mode shown and **PLAY** indicates that the function is not available. When no operating mode icons are given, the function is available in all operating modes.

Joystick and Joystick Guide

Use the joystick to operate the camcorder's menus.

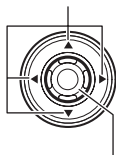

Push the joystick up, down, left or right (**▲**, **▼**, **◀**, **▶**) to select an item or change settings.



Press the joystick itself (**⊙**) to save the settings or confirm an action. On menu screens, this is indicated by the icon **SET**.

Operating mode	Operating mode indicator	MODE switch	Icon display	Operation	
CAMERA CAMERA	CAMERA	(movies)		Recording movies on a disc	30
CAMERA CAMERA	(Red)	(still images)		Recording still images on a memory card	52
PLAY PLAY	PLAY	(movies)		Playing movies from a disc	35
PLAY PLAY	(Green)	(still images)		Viewing still images from a memory card	54



The functions assigned to the joystick change according to the operation mode and the camcorder's settings. Press  to display/hide the joystick guide (when recording, the joystick guide will appear only when the mode switch is set to ). In the illustrations of this manual, positions other than those relevant to the function explained are marked with a striped pattern.

Depending on the operating mode, these positions may be empty or show a different icon than the one on the illustration.



When the guide contains multiple "pages", [NEXT] and the page number icon (▼) will appear at the bottom position. Push the joystick (▼) toward [NEXT] to display the next "page" of the guide.





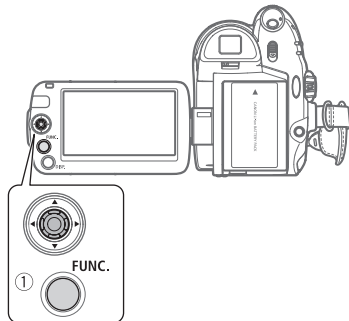

Using the Menus

Many of the camcorder's functions can be adjusted from the menus that open after pressing the FUNC. button (FUNC.).

For details about the available menu options and settings, refer to the *Menu Options Lists* (72).

Selecting a FUNC. Menu Option



- 1 Press .
- 2 Select () the icon of the function you want change from the left side column. Menu items not available will appear grayed out.
- 3 Select () the desired setting from the available options at the bottom bar.
 - The selected option will be highlighted in light blue. Menu items not available will appear grayed out.
 - With some settings, you will need to make further selections and/or press . Follow the additional operation guides that will appear on the screen (such as the  icon, small arrows, etc.).
- 4 Press  to save the settings and close the menu.

You can press **[FUNC.]** to close the menu at any time.

Selecting an Option from the Setup Menus

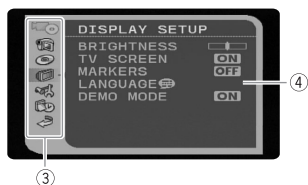
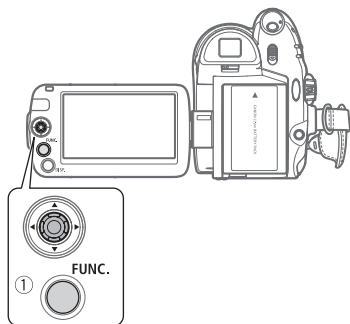

1 Press **[FUNC.]**.

In the index screen (VIDEO mode) and still image index screen, the setup menu will open. Skip to step 3.

2 Select (**▲▼**) the icon and press to open the setup menus.

- You can also hold **[FUNC.]** pressed down for more than 1 second or press **[MENU]** on the wireless controller to open directly the setup menu screen.
- In the index screen (DVD-RW discs in VR mode), push the joystick (**◀▶**) to select the .

3 Select (**▲▼**) the desired menu from the left side column and press .

The title of the selected menu appears on top of the screen and under it the list of settings.

4 Select (**▲▼**) the setting you want to change and press .

- The orange selection bar indicates the menu setting currently selected. Items not available appear in black.
- Push the joystick (**◀**) to return to the menu selection screen (step 3).

5 Select (**▲▼**) the desired option and press .

6 Press **[FUNC.]**.





You can press **[FUNC.]** to close the menu at any time.

Abbreviation of Menu Selections in this Manual

In this manual, the  arrow is used to abbreviate menu selections. Below is an example of changing a setting using the setup menu.

[FUNC.] 
[ MENU] 
[ DISPLAY SETUP] 
[LANGUAGE ] 
Desired language 
[FUNC.]

For selections in the FUNC. menu, the abbreviated form will always show the initial default value. In recording mode, its icon will appear on the left side column when you first open the menu. If the setting was changed, the icon of the currently selected option will appear instead.

[FUNC.] 
[ IMAGE EFFECT OFF] 
Desired image effect 
[FUNC.]



First Time Settings

Setting the Date and Time

You will need to set the date and time of the camcorder before you can start using it. The [DATE/TIME] screen will appear automatically when the camcorder's clock is not set.





When the [DATE/TIME] screen appears, the year will be displayed in orange and indicated with up/down arrows.

- 1 Change (**▲▼**) the year and move (**▶**) to the month.
- 2 Change the rest of the fields (month, day, hour and minutes) in the same way.
- 3 Move (**▶**) the cursor to the [OK] button and press  to start the clock and close the menu.

! IMPORTANT

- When you do not use the camcorder for about 3 months, the built-in rechargeable lithium battery may discharge completely and the date and time setting may be lost. In such case, recharge the built-in lithium battery ( 89) and set the time zone, date and time again.
- The date appears in a year-month-day format only in the first setup screen. In subsequent screen displays the date and time will appear as month-day-year

(for example, [JAN. 1, 2008 12:00 AM]). You can change the date format ( 78).

- You can also change the date and time later on (not during the initial setup). To open the [DATE/TIME] screen, press **[FUNC.]** and select  **[DATE/TIME SETUP]**  **[DATE/TIME]**.

Changing the Language

Options

◆ Default value

[ČEŠTINA]	[MAGYAR]	[العربية]
[DEUTSCH]	[MELAYU]	[فارسی]
[ΕΛΛΗΝΙΚΑ]	[POLSKI]	[ภาษาไทย]
[ENGLISH]◆	[ROMÂNĂ]	[简体中文]
[ESPAÑOL]	[TÜRKÇE]	[繁體中文]
[FRANÇAIS]	[РУССКИЙ]	[한국어]
[ITALIANO]	[УКРАЇНСЬКА]	[日本語]

FUNC.

() 24)

FUNC.



[FUNC.] 

[ MENU] 

[ DISPLAY SETUP] 

[LANGUAGE ] 

Desired language 

[FUNC.]

i NOTES

- If you changed the language by mistake, follow the  mark next to the menu item to change the setting.
- The display **[SET]** that appears in some menu screens refers to the name of buttons on the camcorder and will not change, regardless of the language selected.

Changing the Time Zone

Change the time zone to match your location. The default setting is New York.

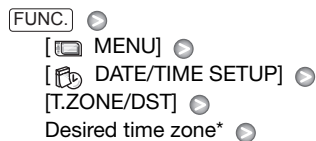

FUNC.

* To adjust for daylight saving time, select the area name marked with a .

World Time Zones

Once you have set the time zone, date and time, you do not need to reset the clock every time you travel to another time zone. Select the time zone to match the local time at your destination, referring to the date and time displayed on the screen.

1 Open the date and time setup screen.



2 Move the orange selection frame (▼) to the  time zone.

3 Select (◀▶) the area that corresponds to the local time at your destination and press .

- Refer to the changing date and time displayed on the screen.
- To adjust for daylight saving time, select the area name marked with a .

4 Press **FUNC. to close the menu.**

Getting Ready to Start Recording

Opening the Lens Cover and Adjusting the LCD screen

Before you start recording, open the lens cover.

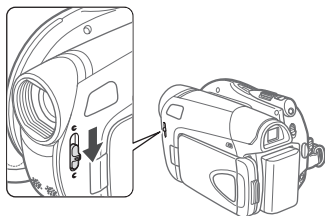

Move the lens cover switch down to  to open the lens cover.

Rotating the LCD Panel

Open the LCD panel 90 degrees.

You can rotate the panel 90 degrees downward.

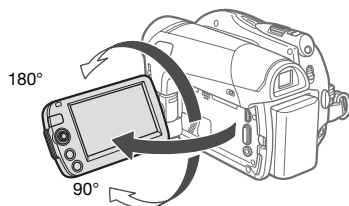

You can rotate the panel 180 degrees toward the lens (allowing the subject to monitor the LCD screen while you use the viewfinder). This is the only case where you can use the viewfinder and the LCD screen simultaneously.

Rotating the LCD panel 180 degrees can be useful in the following cases:



- When you wish to include yourself in the picture when recording with the self timer.
- To allow the camcorder to be operated with the wireless controller from the front.

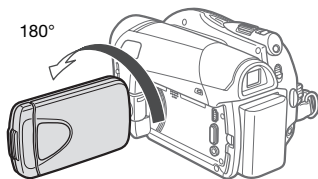

Subject can monitor the LCD screen

i NOTES

About the LCD and viewfinder screen: The screens are produced using extremely high-precision manufacturing techniques, with more than 99.99% of the pixels operating to specification. Less than 0.01% of the pixels may occasionally misfire or appear as black, red, blue or green dots. This has no effect on the recorded image and does not constitute a malfunction.

LCD Backlight

You can set the brightness of the LCD screen to normal or bright.

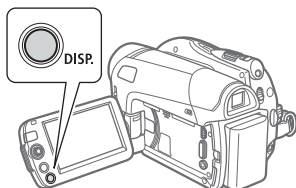

Hold **DISP.** pressed down for more than 2 seconds.

Repeat this action to toggle between the normal and bright settings.

i NOTES

- This setting does not affect the brightness of the recording.
- Using the bright setting will shorten the effective usage time of the battery pack.

Inserting and Removing a Disc

Use only 8 cm (3 in.) mini DVD discs marked with the DVD-R **DVD** logo (including DVD-R DL) or the DVD-RW **DVD** logo. Refer also to *Discs that have been tested* (□ 6). Before inserting the disc be sure to check that the recording surface is clean. If necessary, use a soft lens-cleaning cloth to remove any fingerprints, dirt buildup or smudges from the disc surface.

Inserting the Disc

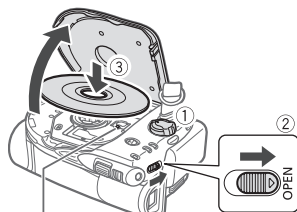

- 1 Turn the **POWER** switch to **ON** to set the camcorder in **CAMERA** mode.
- 2 Slide **OPEN** fully in the direction of the arrow and gently open the disc cover completely until it stops.

Retract the grip belt under the camcorder so it will not get in the way of the disc cover.

3 Insert the disc and press its center firmly until it clicks in place.

- Insert the disc with the recording side facing down (single sided discs – label side facing out).
- Be careful not to touch the recording surface of the disc or the pick up lens.

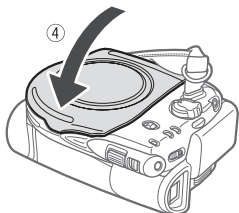

4 Close the disc cover.

Do not force the cover closed if the disc is not correctly inserted and firmly set in place.

i NOTES





The process of recognizing a disc may take a moment. The  display will move while the disc is being read. Wait until the camcorder finishes recognizing the disc before you start recording.







WHEN USING DVD-R/DVD-R DL DISCS

You can start recording movies once the record pause  indicator appears.

WHEN USING DVD-RW DISCS

You need to initialize new discs before you can start recording. The disc initialization screen will appear when a

new DVD-RW disc is first inserted if the /  switch is set to  (movies). If the disc is already initialized, you can start recording movies once the record pause  indicator appears. Otherwise, perform the following steps to initialize the disc.

- ① Select  the desired disc specification and press . For a comparison between the VIDEO and VR specifications, see *How to Select a DVD Disc* (□ 5).
- ② A confirmation message will appear on the screen. Select  [YES] and press  to start the disc initialization, or select [NO] and press  to return and select a different disc specification.
 - The disc initialization will take approximately one minute. Avoid moving the camcorder while the operation is in progress.
 - You can start recording movies once the record pause  indicator appears.

Removing the Disc

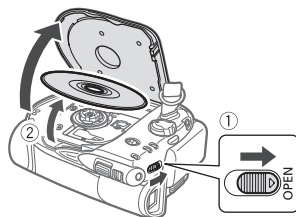

1 Slide **OPEN** fully in the direction of the arrow and gently open the disc cover completely until it stops.

- Do not subject the camcorder to strong impacts while the DISC access indicator is on or flashing.



- Retract the grip belt under the camcorder so it will not get in the way of the disc cover.
- It may take a moment after sliding **OPEN** for the disc cover to open.

2 Grab the edge of the disc and gently pull it out.

Be careful not to touch the recording surface of the disc or the pick up lens.

3 Close the disc cover.

! IMPORTANT

When you slide **OPEN** after making a recording, important file allocation data is updated on the disc before the disc cover opens. While the DISC access indicator is on or flashing do not subject the camcorder to shocks such as forcefully laying it on a table.

Inserting and Removing a Memory Card

You can use commercially available  SDHC (SD High Capacity) memory cards,  SD memory cards or MultiMedia Cards (MMC) with this camcorder.

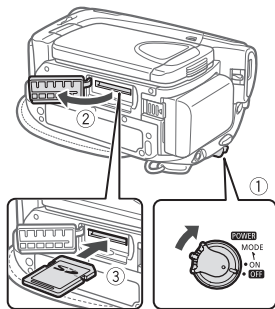

1 Turn off the camcorder.

2 Open the memory card slot cover.

3 Insert the memory card straight all the way into the memory card slot.

4 Close the cover.

Do not force the cover closed if the memory card is not correctly inserted.

TO REMOVE THE MEMORY CARD

First push the memory card once to release it, and then pull the card out.

! IMPORTANT

- Make sure to initialize all memory cards before using them with this camcorder ( 60).
- Memory cards have front and back sides that are not interchangeable. Inserting a memory card facing the wrong direction can cause a malfunction of the camcorder.

i NOTES

- Compatibility with all SD, SDHC or MMC memory cards cannot be guaranteed.
- **About SDHC Memory Cards:** SDHC is the new type of SD memory card with capacities over 2 GB. Please note that the specifications of SDHC memory cards are different from those of regular SD memory cards and you will not be able to use memory cards of over 2 GB with devices that do not support SDHC. However, SDHC devices (including this camcorder) are backward compatible and support regular SD memory cards.



Video

This chapter covers functions related to shooting and playing back movies - from basic recording and zooming to more advanced manual picture adjustments.

Basic Recording

Shooting Video

Before You Begin Recording

Make a test recording first to check if the camcorder operates correctly. Since recordings made on a DVD-R or DVD-R DL disc cannot be deleted, we recommend you use a DVD-RW disc to make the test recordings.

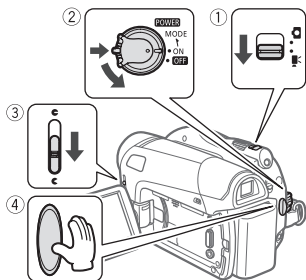

- 1 Move the / switch to (movies).
- 2 Turn the **POWER** switch to ON to set the camcorder in CAMERA mode.

The red CAMERA indicator will turn on.

- 3 Move the lens cover switch down to to open the lens cover.
- 4 Press **Start/Stop** to begin recording.
 - The recording starts; press **Start/Stop** again to pause the recording.
 - The DISC access indicator will flash while recording and will stay on briefly after pausing while the scene is recorded on the disc.

WHEN YOU HAVE FINISHED RECORDING

- 1 Make sure that the DISC access indicator is off.
- 2 Turn off the camcorder.
- 3 Close the lens cover and the LCD panel.
- 4 Remove the disc.

! IMPORTANT

- **When recording movies, try to get a calm, stable picture.**
Excessive camcorder movement while shooting and extensive use of fast zooms and panning can result in jittery scenes. In extreme cases, the playback of such scenes may result in visually induced motion sickness. If you experience such a reaction, immediately stop the playback and take a rest break as necessary.



- Observe the following precautions while the DISC access indicator is on or flashing. Failing to do so may result in permanent data loss.
 - Do not subject the camcorder to vibrations or strong impacts.
 - Do not open the disc cover and do not remove the disc.
 - Do not disconnect the power source or turn off the camcorder.
 - Do not change the operating mode.

i NOTES

- **About the recording time:** By changing the recording mode you can change the recording time available on the disc (□ 32).
- **About the Power Save mode:** To save power when the camcorder is powered by a battery pack, the camcorder will automatically shut off if left without any operations for 5 minutes (□ 77). To restore the power, turn the **POWER** switch toward **MODE** and release it, or turn the **POWER** switch to **OFF** and back to **ON** again.
- When recording in very loud places (such as fireworks shows or concerts), sound may become distorted or it may not be recorded at the actual levels. This is not a malfunction.

- The following may take longer with a disc in VR mode than a disc in VIDEO mode.
 - The time between turning on the camcorder and being able to record.
 - The time between turning the **POWER** switch to **OFF** and the camcorder shutting off.

Using the viewfinder

When recording in bright places it may be difficult to use the LCD screen. In such case, change the brightness of the LCD screen (□ 27) or use the viewfinder instead. To use the viewfinder, keep the LCD panel closed*.

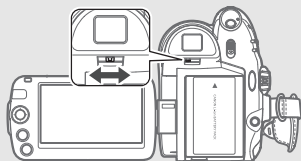

Adjust the viewfinder as necessary with the dioptic adjustment lever.

* The LCD screen and the viewfinder can be used simultaneously when the LCD panel is turned 180 degrees to face the subject (□ 27).

About the mode switch and recording programs

Set the mode switch to **EASY** to let the camcorder adjust all the settings for you, allowing you to just point the camcorder and start shooting.



Set the mode switch to **P** to select one of the recording programs. The Special Scene recording programs (□ 38) offer a convenient way to select the optimal settings to match special recording conditions. Conversely, with flexible recording programs (□ 40) you can set the shutter speed you want, or enjoy the flexibility to change other settings.



Selecting the Recording Mode

Changing the recording mode will change the recording time available on the disc. Select XP or SP mode for better movie quality; select LP mode for longer recording times.

The following table gives approximate recording times with a brand new DVD disc (on a single recording side).

♦ Default value

Recording mode	Disc type	
	DVD-R, DVD-RW	DVD-R DL
XP	20 min.	36 min.
SP ♦	30 min.	54 min.
LP	60 min.	108 min.



FUNC.
(23)



FUNC.

[**SP** STANDARD PLAY]

Desired recording mode

FUNC.

NOTES

The camcorder uses a variable bit rate (VBR) when encoding the video data so the actual recording times will vary depending on the content of the scenes.

Zooming: Optical, Advanced and Digital Zoom

The camcorder offers three types of zoom: optical, advanced and digital zoom when recording movies. (In

CAMERA mode only the optical zoom is available.) You can also change the zoom speed.

Selecting the Zoom Type



Options

♦ Default value

[OPTICAL] (37x)

The zoom range is limited to the optical magnification ratio of the lens.

[ADVANCED] ♦ (Advanced Zoom)

In addition to the optical zoom range, the camcorder processes the image digitally to obtain a larger zoom range without any deterioration in image quality. When recording movies with a 16:9 aspect ratio, the field of view (picture angle) will change. Refer to the table in the NOTES section.

[DIGITAL] (2000x)

When this option is selected, the camcorder will switch to digital zoom (light blue area on the zoom indicator) when you zoom in beyond the optical zoom range (white area on the zoom indicator). With the digital zoom the image is processed digitally so image quality will deteriorate the more you zoom in.

FUNC.
(23)





FUNC. >
 [MENU] >
 [CAMERA SETUP] >
 [ZOOM TYPE] > Desired option >

FUNC.

i NOTES

The zoom range of the advanced zoom will change depending on the aspect ratio of the scene (74).

[WIDESCREEN] set to [ON ON] (16:9)
48x*
* The picture angle will be wider at both full telephoto and full wide-angle.
[WIDESCREEN] set to [OFF OFF] (4:3)
55x

Selecting the Zoom Speed

CAMERA CAMERA | PLAY PLAY (22)

Options

♦ Default value

[VAR VARIABLE]♦
The variable zoom speed depends on how you operate the zoom lever: Press gently for slower zooms; press harder for faster zooms. With this option, the zoom speed will be faster in record pause mode.
[>] SPEED 1, [>>] SPEED 2, [>>>] SPEED 3
Constant zoom speeds. [>>>] SPEED 3 is the fastest, and [>] SPEED 1 is the slowest.

FUNC.
 (23)



FUNC. >
 [MENU] >
 [CAMERA SETUP] >
 [ZOOM SPEED] >
 Desired option >

FUNC.

i NOTES

The fastest zoom speed can be achieved with the [VAR VARIABLE] setting.

Using the Zoom

CAMERA CAMERA | PLAY PLAY (22)

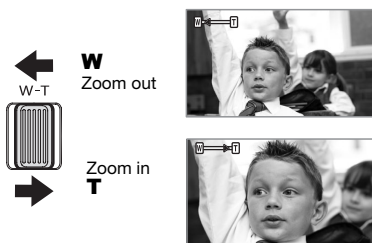

Move the zoom lever toward W to zoom out (wide-angle). Move it toward T to zoom in (telephoto).

i NOTES

- Keep at least 1 m (3.3 ft.) to the subject. At full wide-angle, you can focus on a subject as close as 1 cm (0.39 in.).
- You can also use the T and W buttons on the wireless controller. The zoom speed with the wireless controller will be the same as with the camcorder or fixed at [>>>] SPEED 3 (when [VAR VARIABLE] is selected).

Quick Start Function

When you press **QUICK START** the camcorder enters the **STANDBY** mode. In standby mode the camcorder consumes only about half the power used when recording, saving energy when you are using a battery pack. Additionally, when you press **QUICK START** again the camcorder is ready to start recording within approx. 1 second*, ensuring you do not miss important shooting opportunities.

* The exact time required until the camcorder is ready to start recording may vary depending on the shooting conditions.

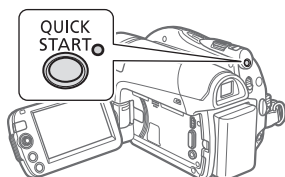

1 Press **QUICK START** firmly.

The standby lamp flashes at first while the camcorder is preparing and then stays on when it enters the standby mode.

2 When you wish to resume recording, press **QUICK START** again.

Within approx. 1 second, the camcorder is ready to record.

i NOTES

- When you wake up the camcorder from standby mode, the following settings will be changed automatically:

- Manual focus returns to automatic focus (AF).
- Manual exposure adjustment returns to automatic exposure.
- Zoom position returns to full wide angle **W**.
- The camcorder will shut off if left in standby mode for 10 minutes, regardless of the [POWER SAVE] setting (□ 77). You can select the length of time until shut-off with the [STANDBY OFF] setting (□ 77). To restore the power if the camcorder shut off, turn the **POWER** switch toward **MODE** and release it, or turn the camcorder off and then on again.
- If you perform any of the following actions while in standby mode (while the standby lamp is on), the camcorder will be woken up from standby mode.
 - Open the disc compartment cover.
 - Change the position of the **DISC** switch.
 - Turn the **POWER** switch toward **MODE**.

Reviewing and Deleting the Last Scene Recorded

Even in **CAMERA** mode you can play back the last scene recorded in order to check it. If you are using a DVD-RW disc, you can also delete the scene while reviewing it.



- 1 If the joystick guide does not appear on screen, press **DISC** to display it.



If does not appear on the joystick guide, repeatedly push the joystick () toward [NEXT] to display it.

2 Push the joystick () toward .

- The camcorder plays back the last scene (but without sound) and returns to record pause mode.
- While reviewing the scene, select the icon and press to return to the recording mode.

Deleting a Scene After Recording It

POINTS TO CHECK

Disc type: DVD-RW

After recording a scene:

1 Review the scene as described in the previous section.

2 While reviewing the scene, select and press .

3 Select [YES] and press .

NOTES

- Avoid any other operations on the camcorder while the scene is being deleted.
- You will not be able to delete the last scene if after the scene was recorded you changed the operating mode, turned off the camcorder or removed the disc.

Basic Playback

Playing Back the Video

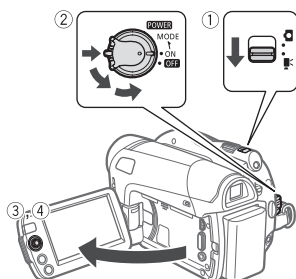

1 Move the switch to .

2 Turn the **POWER switch to ON, then turn it toward **MODE** and release it to set the camcorder in **PLAY** mode.**

- The green PLAY indicator will turn on.
- The scene index screen appears.

3 Move (,) the selection frame to the scene you want to play back.

4 Press to begin the playback.

The playback will start from the scene selected and continue until the end of the last scene recorded.

TO PAUSE/STOP PLAYBACK

- 5 If the joystick guide does not appear on screen, press  to display it.
- 6 Push the joystick (▲) toward ►/|| to pause the playback.
- 7 Push the joystick (▼) toward ■ to stop the playback and return to the scene index screen.

NOTES







- Depending on the recording conditions, you may notice brief stops in video or sound playback between scenes.
- This camcorder can play back discs recorded with this camcorder. Discs

recorded with other camcorders or discs created with a computer may not play back correctly.

- Be sure to finalize discs to play them back on external DVD devices ( 49).
- When playing back a finalized disc, depending on the number of scenes, it may take a moment before the index screen appears.









TO ADJUST THE VOLUME

During the playback of a scene:

 
[] SPEAKER VOL.] 
Adjust (◀▶) the volume 

Special playback modes

Use the joystick guide or the wireless controller ( 15) to enter the special playback modes. There is no sound during the special playback modes.

Special playback mode	Initial mode	 : Camcorder operation  : Wireless controller operation
Fast playback	Normal playback	 : Push the joystick (◀) toward ◀◀ or (▶) toward ▶▶.  : Press ◀◀SEARCH or SEARCH▶▶. Perform operation again to increase playback speed 5x → 15x the normal speed.
Slow playback	Playback pause	 : Push the joystick (◀) toward ◀◀ or (▶) toward ▶▶.  : Press ◀◀SLOW or SLOW▶▶. Perform operation again to increase playback speed 1/8x → 1/4x the normal speed.
Skip to the beginning of: the next scene the current scene the previous scene	Normal playback	 : Press NEXT. Press PREV. Press PREV. twice.
End special playback mode	Special playback	 : Push the joystick (▲) toward ►/ .  : Press PLAY▶.

During some special playback modes, you may notice some anomalies (blocky video artifacts, banding, etc.) in the playback picture.



- The sound from the built-in speaker will be muted when you close the LCD panel or while the STV-250N Stereo Video Cable is connected to the AV terminal.
- If you turn down the volume completely, the icon will change to .

Deleting Scenes

If you are using a DVD-RW disc, you can delete those scenes that you are not interested in keeping.

Deleting a Single Scene



POINTS TO CHECK

Disc type: DVD-RW • VR mode

From the original index screen, select (,) the scene to delete. To delete a scene only in the playlist, switch to the playlist first (47), and then select the scene.



Deleting All Scenes



POINTS TO CHECK

Disc type: DVD-RW • VR mode

To delete all the scenes from the original index screen, perform the following procedure. This will delete also the

whole playlist. If you want to delete only the playlist (without affecting the original recordings), switch to the playlist first (47), and then continue as follows.

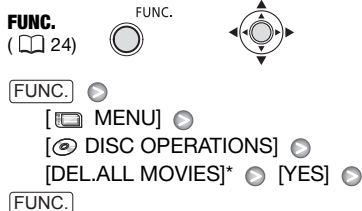

* When you are deleting the playlist, this menu option will be replaced by [DEL.PLAYLIST].

IMPORTANT

Be careful when deleting original recordings. Once deleted, an original scene cannot be recovered.

NOTES

- You may not be able to delete scenes shorter than 5 seconds. To delete such scenes you must initialize the disc (48), in the process deleting all the recordings on the disc.
- Do not change the position of the **POWER** switch or the / switch while the scene is being deleted (while the DISC access indicator is on or flashing).

On-Screen Displays (Data Code)

The camcorder keeps a data code containing the date and time and other camera data (shutter speed, aperture, etc.) registered at the time of recording. You can select the data to be displayed. For details about on-screen displays for still images, refer to *Histogram and Other Screen Displays* (59).

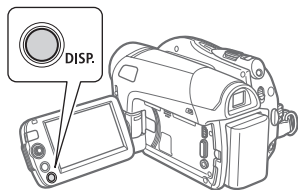

Repeatedly press **[DISP.]** to turn the on-screen displays on/off in the following sequence:

[CAMERA ·]

- All displays on
- All displays off¹

[PLAY ·]

- All displays on
- Data code² only
- All displays off

¹ However, the markers and the icons ● and ■ will still appear on the screen.

² Data code: Time, date and camera data at the time of recording. The contents to be displayed can be selected with the [DATA CODE] setting (□ 76).

Additional Functions

[P] : Special Scene Recording Programs

Recording in a very bright ski resort or capturing the full colors of a sunset or a fireworks display becomes as easy as selecting a Special Scene recording program. For details about the available options, refer to the sidebar on page 39.



✓ POINTS TO CHECK

Mode switch: [P]

FUNC.

(□ 23)

FUNC.



[FUNC.]



[P] PROGRAM AE



Desired recording program



[FUNC.]

[] PORTRAIT

The camcorder uses a large aperture, achieving a focus on the subject while blurring other distracting details.



[] BEACH

Use this mode to record on a sunny beach. It prevents the subject from being underexposed.



[] SPORTS

Use this mode to record sports scenes such as tennis or golf.



[] SUNSET

Use this mode to record sunsets in vibrant colors.



[] NIGHT

Use this mode to record in dimly lit places.



[] SPOTLIGHT

Use this mode to record spotlight scenes.



[] SNOW

Use this mode to record in bright ski resorts. It prevents the subject from being underexposed.



[] FIREWORKS

Use this mode to record fireworks.



NOTES

- Do not set the mode switch to **EASY** during the actual recording of a scene; the brightness of the picture may change abruptly.
- [] PORTRAIT/[] SPORTS/[] BEACH/[] SNOW
 - The picture may not appear smooth during playback.
- [] PORTRAIT
 - The blur effect of the background increases the more you zoom in (**T**).
- [] NIGHT
 - Moving subjects may leave a trailing afterimage.
 - Picture quality may not be as good as in other modes.
 - White points may appear on the screen.
- Autofocus may not work as well as in other modes. In such case, adjust the focus manually.
- [] SNOW/[] BEACH
 - The subject may become overexposed on cloudy days or in shaded places. Check the image on the screen.
- [] FIREWORKS
 - To avoid camcorder shake, we recommend using a tripod. Make sure to use a tripod especially in **[CAMERA •]** mode, as the shutter speed slows down.

Flexible Recording: Changing the Shutter Speed

Use the automatic exposure (AE) program to use functions like the white balance or image effects, or give priority to the shutter speed.

Use faster shutter speeds to record subjects moving quickly. Use slower shutter speeds to add motion blur, emphasizing the feel of movement.





POINTS TO CHECK

Mode switch: 

Options

 Default value

[ PROGRAM AE][♦]
The camcorder automatically adjusts the aperture and shutter speed to obtain the optimal exposure for the subject.
[ SHUTTER-PRIO.AE]
Set the shutter speed value. The camcorder automatically sets the appropriate aperture value.

FUNC.
( 23)

FUNC.



FUNC. 



[ PROGRAM AE] 

Desired option 

FUNC.

TO SET THE SHUTTER SPEED

When you select [ SHUTTER-PRIO.AE], a numeric value will appear next to the recording program icon.

- 1 If the joystick guide appears on the screen, press  to hide it.
- 2 Adjust () the shutter speed to the desired value.

Shutter speed guidelines

Note that on screen only the denominator is displayed – [ 250] indicates a shutter speed of 1/250 second, etc.

1/2*, 1/4*, 1/8, 1/15, 1/30
To record in dimly lit places.
1/60
To record under most ordinary conditions.
1/100
To record indoor sports scenes.
1/250, 1/500, 1/1000**
To record from within a moving car or train or to shoot fast-moving subjects such as roller coasters.
1/2000**
To record outdoor sports scenes on sunny days.

*  mode only.

**  mode only.

NOTES

- Do not set the mode switch to **EASY** during the actual recording of a scene; the brightness of the picture may change abruptly.
- [ SHUTTER-PRIO.AE]
 - When setting the shutter speed, the number display will flash if the value is not appropriate for the recording conditions. In such case, select a different value.
 - If you use a slow shutter speed in dark places, you can obtain a brighter



image, but the image quality may be lower, and the autofocus may not work well.

- The image may flicker when recording with fast shutter speeds.
- **Recording movies under fluorescent lights:** If the screen starts to flicker, select [TV SHUTTER-PRIO.AE] and set the shutter speed to 1/100.

LCD Video Light

You can use the LCD video light to record in completely dark places. For a brighter picture, we recommend keeping a distance of about 20 cm - 60 cm (8 in. - 2 ft.) from the subject and/or using the [NIGHT] recording program. When you activate the LCD video light, rotate the LCD panel to face the subject and use the viewfinder instead (□ 31).



FUNC.
(□ 23)



FUNC. (right arrow)

[LCD LIGHT OFF] (right arrow)

[LCD LIGHT ON]* (right arrow)

Press (directional pad)

FUNC. (right arrow)

* Using the viewfinder, select [LCD LIGHT OFF] instead to turn the LCD video light off. Closing the LCD panel will also turn the LCD video light off.

The LCD display turns entirely white when used as the video light. Use the viewfinder instead.

Self Timer



POINTS TO CHECK

CAMERA (video camera icon): Set the camcorder to record pause mode.

FUNC.
(□ 23)



1 Activate the self timer.

FUNC. (right arrow) [MENU] (right arrow)

[CAMERA SETUP] (right arrow)

[SELF TIMER] (right arrow) [ON ON] (down arrow)

2 Press FUNC. to close the menu.

- ⏻ appears.
- Set [SELF TIMER] to [OFF OFF] to cancel the self timer.

3 Press Start/Stop on the camcorder to start recording.

- The camcorder starts recording video (CAMERA - video camera icon mode) or takes a still image (CAMERA - still camera icon mode) after a 10-second countdown. The countdown appears on the screen.
- You can also press START/STOP (CAMERA - video camera icon mode) or PHOTO (CAMERA - still camera icon mode) on the wireless controller. In that case, the countdown will be only 2 seconds.

NOTES

Once the countdown has begun, you can press Start/Stop again or turn off the camcorder to cancel the self timer.

Manual Focus Adjustment

Autofocus may not work well on the following subjects. In such case, focus manually.

- Reflective surfaces
- Subjects with low contrast or without vertical lines
- Fast moving subjects
- Through wet windows
- Night scenes



POINTS TO CHECK

Adjust the zoom before you start the procedure.

Mode switch:



- 1 If the joystick guide does not appear on screen, press to display it.**

If [FOCUS] does not appear on the joystick guide, repeatedly push the joystick () toward [NEXT] to display it.

- 2 Push the joystick () toward [FOCUS].**

“MF” appears.

- 3 Adjust () the focus as necessary.**

- Push the joystick () toward for a farther focal distance or push it () toward for a closer focal distance.

- Pushing the joystick () toward [FOCUS] again will return the camcorder to autofocus.

- 4 Push the joystick () toward [NEXT] to save the focus adjustment.**

Infinity Focus

Use this function when you wish to focus on faraway subjects such as mountains or fireworks.

POINTS TO CHECK

Adjust the zoom before you start the procedure.

Mode switch:



- 1 If the joystick guide does not appear on screen, press to display it.**
- 2 Keep the joystick pushed () toward [FOCUS] for more than 2 seconds.**
 - ∞ appears.
 - Pushing the joystick () toward [FOCUS] again will return the camcorder to autofocus.
 - If you operate the zoom or the joystick () , ∞ changes to “MF” and the camcorder returns to manual focusing mode.
- 3 Push the joystick () toward [NEXT] to save the focus adjustment.**



Manual Exposure Adjustment

At times, backlit subjects may appear too dark (underexposed) or subjects under very strong lights may appear too bright or glaring (overexposed). To correct this, you can manually adjust the exposure.



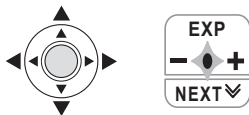

POINTS TO CHECK

Mode switch: [P] (except for the [FIREWORKS] recording program).





1 If the joystick guide does not appear on screen, press  to display it.

If [EXP] does not appear on the joystick guide, repeatedly push the joystick () toward [NEXT] to display it.

2 Push the joystick () toward [EXP].

The exposure adjustment indicator  and the neutral value “±0” appear on the screen.

3 Adjust () () the brightness of the image as required.

- The adjustment range and the length of the exposure adjustment indicator will vary depending on the initial brightness of the picture.
- Pushing the joystick () toward [EXP] again will cancel the exposure lock and return the camcorder to automatic exposure.

4 Push the joystick () toward [NEXT] to lock and save the exposure setting.

If you operate the zoom during exposure lock, the brightness of the image may change.

White Balance

The white balance function helps you to accurately reproduce colors under different lighting conditions so that white objects will always look truly white in your recordings.







POINTS TO CHECK

Mode switch: [P] (except for the Special Scene recording programs)

Options

◆ Default value

[ AUTO] ◆
Settings are automatically set by the camcorder. Use this setting for outdoor scenes.
[ DAYLIGHT]
For recording outdoors on a bright day.
[ TUNGSTEN]
For recording under tungsten and tungsten type (3-wavelength) fluorescent lighting.
[ SET]
Use the custom white balance setting to make white subjects appear white under colored lighting.

FUNC.
(23)



FUNC.

[**AWB AUTO**] Desired option*

FUNC.

* When you select [SET], do not press [**FUNC.**] and continue instead with the following procedure.

TO SET THE CUSTOM WHITE BALANCE

1 Point the camcorder at a white object, zoom in until it fills the whole screen and press .

When the adjustment is completed, stops flashing and stays on. The camcorder retains the custom setting even if you turn off the camcorder.

2 Press **FUNC.** to save the setting and close the menu.

NOTES

• When you select the custom white balance:

- Set the custom white balance in a sufficiently illuminated place.
- Select a zoom type other than [**2000x** DIGITAL] (32).
- Reset the white balance when the lighting conditions change.
- Depending on the light source, may keep flashing. The result will still be better than with [**AWB AUTO**].

• Custom white balance may provide better results in the following cases:

- Changing lighting conditions
- Close-ups
- Subjects in a single color (sky, sea or forest)
- Under mercury lamps and certain types of fluorescent lights

Image Effects

You can use the image effects to change the color saturation and contrast to record images with special color effects.

CAMERA | **CAMERA** | **PLAY** | **PLAY** (22)

POINTS TO CHECK

Mode switch: [] (except for the Special Scene recording programs)

Options ♦ Default value

[IMAGE EFFECT OFF] ♦
Records with no image enhancing effects.
[VIVID]
Emphasizes the contrast and color saturation.
[NEUTRAL]
Tones down the contrast and color saturation.
[SOFT SKIN DETAIL]
Softens the details in the skin tone area for a more complimentary appearance. To obtain the best effect, use this setting when recording a person in close-up. Note that areas similar to the skin color may lack in detail.

FUNC.
(23)



FUNC.

[**IMAGE EFFECT OFF**]

Desired option

FUNC.



Digital Effects



POINTS TO CHECK

Mode switch: [P]

[CAMERA] : [E1] BLK&WHT], [E2] SEPIA] only.

Options

◆ Default value

[D.EFFECT OFF]◆
Select this setting when you do not intend to use the digital effects.
[F1] FADE-T] (fade trigger), [F2] WIPE]
Select one of the faders to begin or end a scene with a fade from or to a black screen.
[E1] BLK&WHT]
Records images in black and white.
[E2] SEPIA]
Records images in sepia tones for an “old” look.
[E3] ART], [E4] MOSAIC]
Select one of these digital effects to add “flavor” to your recordings.

NOTES

- When you apply a fader, not only the picture but also the sound will fade in or out. When you apply an effect, the sound will be recorded normally.
- The camcorder retains the last setting used even if you turn off the digital effects or change the recording program.

Setting

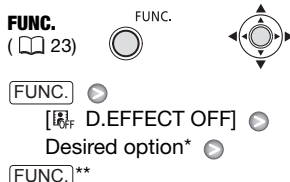

* You can preview the effect on the screen.

** The icon of the selected effect appears.

Applying



1 If the joystick guide does not appear on screen, press to display it.

If does not appear on the joystick guide, repeatedly push the joystick (▼) toward [NEXT] to display it.

2 Push the joystick (▲) toward .

- The icon of the selected effect turns green.
- Push the joystick (▲) toward again to deactivate the fader/effect.

TO FADE IN

Push the joystick (▲) toward in record pause mode (●||), then press [Start/Stop] to start recording with a fade in.

TO FADE OUT

Push the joystick (▲) toward while recording (●), then press [Start/Stop] to fade out and pause the recording.

TO ACTIVATE AN EFFECT

CAMERA (with camera icon) : Push the joystick (▲) toward  while recording or in record pause mode.

CAMERA (with camera icon) : Push the joystick (▲) toward  and then press **Start/Stop** to record the still image.

Managing Scenes and the Disc

Creating a Playlist

Create a playlist to easily edit your movies. Include in your playlist only the scenes you prefer or change the order in which they will be played back, without affecting your original recordings. After you add scenes to the playlist, you can switch between the original scenes and the playlist.

Adding Scenes to the Playlist

You can choose to add to the playlist all the original scenes at once or only the selected scene.



POINTS TO CHECK

Disc type:  DVD-RW • VR mode

From the original index screen, select (▲▼, ◀▶) the scene to add to the playlist. To add all scenes, there is no need to select any particular scene.



To delete scenes from the playlist, refer to *Deleting Scenes* (book icon 37).



Switching Between Original and Playlist Scenes



POINTS TO CHECK

Disc type: DVD-RW • VR mode



* Appears in the original index screen. In the playlist, [TO ORIGINAL] appears instead.

Original index screen (original recordings)

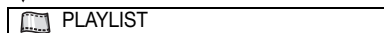
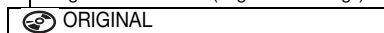

Playlist index screen

Moving Scenes in the Playlist



POINTS TO CHECK

Disc type: DVD-RW • VR mode

From the original index screen, switch to the playlist (page 47). From the playlist index screen, select (▲▼, ◀▶) the scene to move.

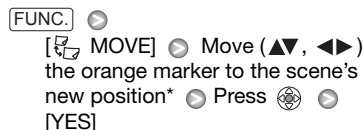
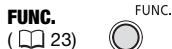

* The original position of the scene and the current position of the marker are displayed at the bottom of the screen.

Dividing Scenes

You can divide scenes in order to leave only the best parts and later cut out the rest. Remember that when you divide scenes in the playlist, you do not affect your original recordings.



POINTS TO CHECK

Disc type: DVD-RW • VR mode

From the original index screen, switch to the playlist (page 47). From the playlist index screen, select (▲▼, ◀▶) the scene to divide.

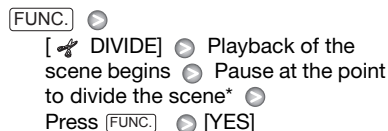

* You can use the following icons and the special playback modes (page 36) except for skipping scenes to bring the scene to a precise point. Slow playback mode requires the wireless controller.
◀||/||▶: Frame jump forward/backward.

NOTES

- Very short scenes (shorter than 2 seconds) cannot be divided.
- The new scene will be added to the playlist after the scene that was divided.

Initializing the Disc

You need to initialize all new DVD-RW discs when you first insert them into the camcorder and you may have to initialize them if you get the message “UNABLE TO RECOGNIZE THE DATA”. You can also initialize a DVD-RW disc when you want to completely erase the disc to reuse it or in order to change the disc specification.



POINTS TO CHECK

Disc type:  DVD-RW

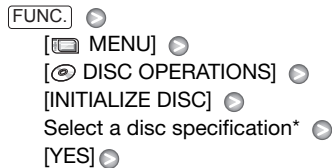

FUNC.**

* For details about disc specifications, refer to *Disc specification on DVD-RWs.* (□ 5)

** Close the menu only after the screen display returns to the [DISC OPERATIONS] menu.

IMPORTANT

Initializing the disc will permanently erase all recordings. The lost original recordings cannot be recovered.

Disc Playback on an External Device



Changing the Disc Title

Before you finalize your disc, you can give it a title¹. The disc title will be displayed on the index screen when playing the finalized disc in most DVD players. You can check the disc's title with the [DISC INFO] menu option (□ 75).

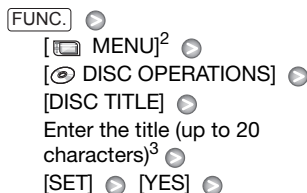
¹ You can change the title of DVD-RW discs recorded in VR mode also after having finalized them.



² Only when using a DVD-RW recorded in VR mode. Otherwise, pressing **FUNC.** will open the menu directly on the setup menus screen.

³ Select one character at a time and press  to add it to the title. Select [BACKSPACE] and press  to delete the character to the left of the cursor's position.



Finalizing the Disc

To play the disc you recorded on a DVD player, a computer's DVD drive or other digital device, **you need to finalize it first**. You do not need to finalize the disc to play back your recordings with the camcorder connected to the TV.



POINTS TO CHECK

Power the camcorder using the compact power adapter or a fully charged battery pack.

FUNC.

(24)



FUNC.

[MENU]¹

[DISC OPERATIONS]

[FINALIZE] [YES]²

Press when the confirmation screen appears³

FUNC.

¹ Only when using a DVD-RW recorded in VR mode. Otherwise, pressing [FUNC.] will open the menu directly on the setup menus screen.

² During the disc finalization a progress bar is displayed.

³ After pressing , the [DISC OPERATIONS] menu will reappear. Depending on the number of scenes, this may take a moment.

IMPORTANT

- Be sure to finalize the disc in normal room temperatures. If the procedure was not completed correctly due to high temperature, let the camcorder cool off before resuming operation.
- Place the camcorder on a table or other stable surface before starting the procedure. Subjecting the camcorder even to slight impacts (for example to place it on a table or to disconnect a cable) after the finalization process started may result in permanent data loss.
- Do not disconnect the power source while the operation is in progress. Doing so can interrupt the process and result in permanent data loss.
- Depending on the type of disc and the disc specification, after finalizing the disc you may not be able to initialize the disc, edit your recordings or add new recordings to the disc.
- Do not use this camcorder to finalize discs that were not recorded using it.

NOTES

- The time required to finalize the disc depends on the scenes recorded and the remaining free space on the disc.
- After the disc is finalized, will appear on the playback screen.

Disc Playback on External Devices

After finalizing the disc with your recordings, you can play it on DVD players compatible with the type of disc used (DVD-R, DVD-R DL or DVD-RW). You cannot play back discs on an external DVD device if the discs have not yet been finalized.

For a summary, you can refer to the sidebar on page 50. For details about disc compatibility refer to the instruction manual of the DVD player or DVD drive.

ON A DVD PLAYER

- 1 Turn on the TV and DVD player.
- 2 Insert the finalized disc in the DVD player.
- 3 Select the scene you want to play from the index screen.

ON A COMPUTER'S DVD DRIVE

- 1 Insert the finalized disc in the DVD drive.
- 2 Run the DVD playback software. Refer also to the instruction manual and help modules of your DVD playback software.

NOTES

- DVD-RW discs recorded in VR mode can be played only on VR mode-compatible DVD players.
- Depending on your DVD device you may not be able to play the disc.
- In order to play the disc on a computer you need to have DVD playback software installed and running. Also, in order to play back a DVD-R DL you must have a DVD drive capable of reading dual-layered DVD discs.

Unfinalizing the Disc - Additional Recordings on a Finalized Disc

Unfinalize a disc to allow recording additional movies on the disc even after it was finalized.



POINTS TO CHECK

Disc type:  DVD-RW • VIDEO mode • Finalized
Power the camcorder using the compact power adapter or a fully charged battery pack.

Restrictions after disc finalization

	Additional recordings	Editing recordings	Initializing the disc	Unfinalizing the disc
DVD-R/DVD-R DL in VIDEO mode	–	–	–	–
DVD-RW in VIDEO mode	● ¹	–	●	●
DVD-RW in VR mode	●	● ²	●	–

¹ You will need to unfinalize the disc first.

² Only scenes in the playlist can be divided.

FUNC.
(24)



FUNC.

[DISC OPERATIONS]

[UNFINALIZE] [YES]*

Press when the confirmation screen appears

FUNC.

* During the disc unfinalization a progress bar is displayed.

IMPORTANT

- **Be sure to unfinalize the disc in normal room temperatures. If the procedure was not completed correctly due to high temperature, let the camcorder cool off before resuming operation.**
- **Place the camcorder on a table or other stable surface before starting the procedure. Subjecting the camcorder even to slight impacts (for example to place it on a table or to disconnect a cable) after the unfinalization process started may result in permanent data loss.**
- Do not disconnect the power source while the operation is in progress. Doing so can interrupt the process and result in permanent data loss.
- Only discs that were finalized using this camcorder can be unfinalized with it.

Discs that can be unfinalized

DVD-R/DVD-R DL in VIDEO mode	—
DVD-RW in VIDEO mode	●
DVD-RW in VR mode	— You can record additional scenes even without unfinalizing the disc



Photos

Refer to this chapter for details on shooting photos – from capturing and playing back images to printing them.

Basic Recording

Taking Photos

Before using a memory card for the first time, be sure to initialize it with this camcorder (60).



(22)

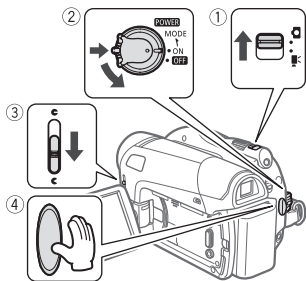

1 Move the switch to (still images).

2 Turn the **POWER** switch to **ON** to set the camcorder in **CAMERA** mode.

The red **CAMERA** indicator will turn on.

3 Move the lens cover switch down to to open the lens cover.

4 Press **Start/Stop**.

- Once the focus is automatically adjusted, will turn green and one or more AF frames will appear.
- The **CARD** access indicator will flash as the still image is being recorded.
- When you press **PHOTO** on the wireless controller, the still image is recorded after the autofocus is activated and locked.

! IMPORTANT

Observe the following precautions while the card access display () appears on screen, and when the **CARD** access indicator is on or flashing. Failing to do so may result in permanent data loss.

- Do not subject the camcorder to vibrations or strong impacts.
- Do not open the memory card slot cover and do not remove the memory card.
- Do not disconnect the power source or turn off the camcorder.
- Do not change the position of the switch or the operating mode.

i NOTES

If the subject is not suitable for autofocus, turns yellow. Adjust the focus manually (42).



Selecting Photo Size and Quality

Still images are recorded on the memory card using JPEG compression. As a general rule select a larger image size for higher quality. Select the [LW 1152x648] size for photos with an aspect ratio of 16:9.



Options

Image size options and the approximate number of still images that can be recorded on memory cards of various sizes are given in the table below.

FUNC.
(23)



FUNC.

[1152x864]

Desired image size*

Desired image quality*

FUNC.

* Press to move back and forth between size and quality selection. The number displayed on the right corner indicates the approximate number of images that can be recorded with the current quality/size setting.

NOTES

- Depending on the number of images on the memory card (Windows: 1,800 images or more; Macintosh: 1,000 images or more), you may not be able to transfer images to a computer. Try using a card reader.
- Connection to a PictBridge-compatible printer will not work when the memory card contains 1,800 images or more. For best performance, we recommend keeping the number of images on the memory card under 100.
- When printing still images, use the following guidelines as a reference for selecting the print size.

Approximate number of still images on a memory card

♦ Default value

Memory card	128 MB			512 MB			1 GB		
Image quality ¹ →									
Image size ↓									
LW 1152x648	245	360	695	970	1,435	2,745	1,945	2,875	5,490
L 1152x864♦	185	280	545	735	1,115	2,155	1,470	2,235	4,315
S 640x480	585	850	1,530	2,320	3,355	6,040	4,645	6,715	12,085 ²

¹ : [SUPER FINE], : [FINE], : [NORMAL]

² This is the number of images that can be recorded. However, the maximum number of remaining still images displayed on the screen will be 9999.

Image size	Recommended use
LW 1152x648	To print photos with a 16:9 aspect ratio. Wide-sized photo paper is required.
L 1152x864	To print photos up to L size (9 x 13 cm, 3.5 x 5 in.) or postcard size (10 x 14.8 cm, 4 x 6 in.).
S 640x480	To send images as e-mail attachments or to post on the Web.

Erasing the Last Photo Just Recorded

You can erase the still image recorded last while reviewing it within the time set for the [REVIEW] option (or immediately after recording it, if [REVIEW] is set to [OFF OFF]).



While reviewing the image immediately after recording:

- 1 Push the joystick (▼) toward .
- 2 Select (◀▶) [ERASE] and press .

Basic Playback

Viewing Photos

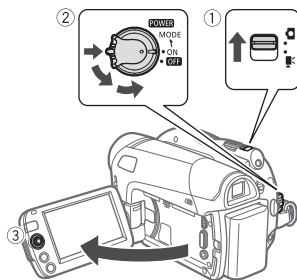

- 1 Move the switch to (still images).
- 2 Turn the **POWER** switch to ON, then turn it toward **MODE** and release it to set the camcorder in **PLAY** mode.
The green PLAY indicator will turn on.
- 3 Use the joystick (◀▶) to move between images.

Image Jump Function

You can locate a specific image without having to browse all of them one by one.



TO RUN THROUGH THE STILL IMAGES



Push the joystick (◀▶) and hold it pressed down to run quickly through the still images.

TO SKIP 10 OR 100 STILL IMAGES

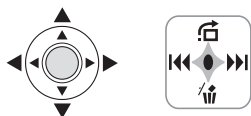

- 1 If the joystick guide does not appear on screen, press to display it.
- 2 Push the joystick (▲) toward .



- 3 Select (▲▼) [JUMP 10 IMAGES] or [JUMP 100 IMAGES].
- 4 Jump (◀▶) the number of images selected and press . You can press again to hide the joystick guide.

! IMPORTANT

- Observe the following precautions while the card access display (▶ □) appears on screen, and when the CARD access indicator is on or flashing. Failing to do so may result in permanent data loss.
 - Do not subject the camcorder to vibrations or strong impacts.
 - Do not open the memory card slot cover and do not remove the memory card.

- Do not disconnect the power source or turn off the camcorder.
- Do not change the position of the / switch or the operating mode.
- The following may not be displayed correctly.
 - Images not recorded with this camcorder.
 - Images edited on or transferred from a computer.
 - Images whose file names have been changed.

Slideshow



- FUNC. [SLIDESHOW] [START]
- Images are played back one after another.
 - Press to stop the slideshow.

Index Screen

- 1 Move the zoom lever toward **W**. The still images index screen appears.
- 2 Select (▲▼, ◀▶) an image.
 - Move the green selection frame to the image you want to view.
 - If you have a lot of still images, you may find it easier to browse entire index pages instead. Move the zoom lever toward **W** to extend the green selection frame to the whole page, and move (◀▶) between index pages. Move the zoom lever toward **T** to return to moving between single images.
- 3 Press . The index screen closes and the selected image is displayed.

Magnifying Photos during Playback

During playback, still images can be magnified up to 5 times.



1 Move the zoom lever toward **T**.

- The image is magnified by 2 times and a frame appears indicating the position of the magnified area.
- To further enlarge the image, move the zoom lever toward **T**. To reduce the magnification to less than 2 times, move the zoom lever toward **W**.
-  will appear for images that cannot be enlarged.

2 Move (, , ,) the frame to the part of the image you want to see enlarged.







To cancel the magnification, move the zoom lever toward **W** until the frame disappears.

Erasing Photos

You can erase still images recorded on the memory card. You can erase either a single still image or all the still images.

Erasing a Single Image



- 1 If the joystick guide does not appear on screen, press  to display it.
- 2 Select () the image you want to erase.
- 3 Push the joystick () toward .
- 4 Select () [ERASE] and press .

Erasing All Images



FUNC.
( 24)



[FUNC.] 

[ MENU] 

[ STILL IMG OPER.] 

[ERASE ALL IMAGES] 

[YES] 

[FUNC.]

IMPORTANT

Be careful when erasing images. Erased images cannot be recovered.

NOTES

Protected images on the memory card cannot be erased.



Additional Functions

Continuous Shooting and Exposure Bracketing (Drive Mode)

Take a series of pictures of a moving subject or record the same picture in 3 levels of exposure in order to choose later the picture you like the best.



POINTS TO CHECK

Mode switch: **[P]** (except for the **[FIREWORKS]** recording program).

Options

◆ Default value

[<input type="checkbox"/> SINGLE] ◆
Records a single still image.
[CONT.SHOOT.] (Continuous Shooting), [HISPEED CONT.SHOOT.] (High-Speed Continuous Shooting)
Captures a series of still images as long as you hold [Start/Stop] pressed down. For the number of frames per second, refer to the sidebar on page 57.
[AEB] (Auto Exposure Bracketing)
The camcorder records a still image in three different exposures (dark, normal, light in 1/2 EV steps), allowing you to choose the shot you like the best.

FUNC.

(23)

FUNC.



FUNC.

[SINGLE]

Desired option

FUNC.

Maximum number of continuous shots

Number of frames (shots) per second	
Normal speed	3 frames
High speed	5 frames

Maximum number of continuous shots	
LW 1152x648, L 1152x864	20 images
S 640x480	60 images

These figures are approximate and vary with the recording conditions and subjects. The actual number of frames per second will be lower when (camcorder shake warning) is displayed on the screen.

CONTINUOUS SHOOTING/ HIGH-SPEED CONTINUOUS SHOOTING

Press **[Start/Stop]** and hold it pressed down.

Once the focus is automatically adjusted,  will turn green. A series of still images will be recorded as long as you hold the button pressed.

AUTO EXPOSURE BRACKETING

Press **[Start/Stop]**.

Once the focus is automatically adjusted,  will turn green. Three still images in different exposures will be recorded on the memory card.

Automatic Focus Priority

When the focus priority is activated, the camcorder records a still image only after the focus has been adjusted automatically.



POINTS TO CHECK

Mode switch at **[EASY]**: The focus priority cannot be turned off.

Mode switch at **[P]**: You can turn off the focus priority and you can also select the AF (autofocus) frame to be used.

Options

◆ Default value

[AF AF ON:AI AF]◆

(Mode switch: **[P]***, **[EASY]**)

Depending on the shooting conditions, one or more AF frames out of the nine frames available are automatically selected and the focus is fixed on them.

[□ ON: CENTER]

(Mode switch: **[P]***)

In this mode, a single focusing frame appears in the center of the screen and the focus is automatically fixed on it. This is convenient for making sure the focus is exactly where you want it.

[OFF OFF]

Select this option if you wish to record a still image as soon as you press **[Start/Stop]**.

* Except for the **[FIREWORKS]** recording program.

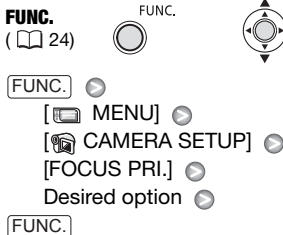

NOTES

In the **[FIREWORKS]** recording program the focus priority is automatically set to **[OFF OFF]**.



Histogram and Other Screen Displays

When viewing still images you can display the histogram and the icons of all the functions used at the time of recording. Use the histogram as a reference to verify the correct exposure of the still image.

The area to the right of the histogram represents highlights and the left side represents shadows. A still image whose histogram skews to the right is relatively bright; while one whose histogram peaks to the left, is relatively dark.

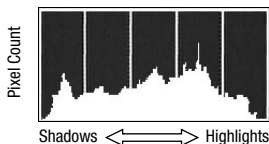

i NOTES

The histogram will appear also after recording a still image, while reviewing it within the time set for the [REVIEW] option (or immediately after recording it, if [REVIEW] is set to [OFF OFF]). You can choose to turn off the histogram by pressing [DISP].

TO SELECT THE ON-SCREEN DISPLAYS

Repeatedly press [DISP.] to turn the on-screen displays on and off in the following sequence.

CAMERA -

- All displays on
- All displays off¹

PLAY -

- All displays on
- Regular displays only (removes the histogram and information icons)

- All displays off

¹ However, the markers and the icon and AF frames when the autofocus is locked will still appear on the screen.

Protecting Photos

You can protect still images recorded on the memory card from accidental erasure.

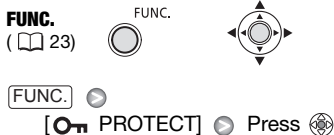

[FUNC.] [PROTECT]: The image selection screen appears.

FROM THE IMAGE SELECTION SCREEN

- 1 Select () () the still image you want to protect.
- 2 Press to protect the still image. appears on the bottom bar and the image cannot be erased. Press again to cancel the image protection.
- 3 Repeat steps 1-2 to protect additional images or press [FUNC.] twice to close the menu.

! IMPORTANT

Initializing the memory card (60) will permanently erase all recorded still images, even the protected ones.

Initializing the Memory Card

Initialize memory cards when you use them with this camcorder for the first time, or to erase all the still images on them.

Options

[INITIALIZE]
Clears the file allocation table but does not physically erase the stored data.
[COMPL.INIT.]
Erases all data completely.



FUNC.
(24)



FUNC. >

[MENU] >

[STILL IMG OPER.] >

[INITIALIZE CARD] >

Select the card initialization method >

[YES]* >

FUNC.

* Press  to cancel the complete initialization while it is in progress. All the image files will be erased and the memory card can be used without any problem.

IMPORTANT

Initializing the memory card will erase all still images, even the protected ones. The original still images cannot be recovered.

You can also use the following functions...

The following functions and features of the camcorder can be used either for shooting video or for taking photos. The way to set and use them was already explained in detail, so we refer you to the relevant page in the “Video” section.

- Quick Start (34)
- Zoom (32)
- Special Scene recording programs (38)
- Flexible recording programs (40)
- LCD video light (41)
- Self timer (41)
- Manual focus (42)
- Manual exposure adjustment (43)
- White balance (43)
- Image effects (44)
- Digital effects (45)



Printing Photos

Printing Photos - Direct Print

The camcorder can be connected to any PictBridge-compatible printer. You can mark in advance the still images you want to print and set the desired number of copies as a print order (□ 64).

PictBridge

Canon printers: SELPHY printers of the CP, DS and ES series and PIXMA printers marked with the PictBridge logo.



Connecting the Camcorder to the Printer





1 Insert the memory card containing the still images you want to print.

2 Turn on the printer.

3 Connect the camcorder to the printer using the supplied USB cable.

- Refer to *PC Connection Diagram* (□ 68).
-  appears and changes to .

IMPORTANT

- If  continues to flash (for more than 1 minute) or if  does not appear, the camcorder is not correctly connected to the printer. In such case, disconnect the USB cable and turn off the camcorder and the printer. After a short while, turn them on again, set the camcorder to

 mode and restore the connection.

- During the following operations, even if you connect a printer to the camcorder it will not be recognized.
 - Erasing all still images
 - Erasing all transfer orders
 - Erasing all print orders



NOTES



-  will appear for images that cannot be printed.
- We recommend powering the camcorder using the compact power adapter.
- For more information, refer to the printer's instruction manual.

Selecting the Print Settings

You can select the number of copies and other settings for printing. The setting options vary depending on your printer model.

Options

[PAPER]
[ PAPER SIZE]: Available paper sizes vary depending on the printer model.
[ PAPER TYPE]: Select [PHOTO], [FAST PHOTO], [PLAIN] or [DEFAULT].
[ PAGE LAYOUT]: Select [DEFAULT] or one of the following available page layouts. [BORDERED]: Prints the whole image area almost exactly as the recorded still image. [BORDERLESS]: Enlarges the center portion of the still image to fit the width/height ratio of the selected paper size. The top, bottom and sides of the still image may be slightly trimmed out. [2-UP], [4-UP], [8-UP], [9-UP], [16-UP]: Refer to the sidebar on page 62.

[] (Date print)
Select [ON], [OFF] or [DEFAULT].
[] (Print Effect)
The print effect can be used with printers compatible with the Image Optimize function to achieve higher quality prints. Select [ON], [OFF] or [DEFAULT]. Canon PIXMA/SELPHY DS printers: You can also select [VIVID], [NR] and [VIVID+NR].
[] (Number of Copies)
Select 1-99 copies.

NOTES

Print setting options and [DEFAULT] settings vary depending on the printer model. For details, refer to the printer's instruction manual.

Printing multiple images on the same sheet [2-UP], [4-UP], etc.

When using Canon printers you can print the same still image multiple times on the same sheet of paper. Use the following table as a guideline for the recommended number of copies depending on the [ PAPER SIZE] setting.

[ PAPER SIZE] →	[CREDITCARD]	[9 x 13 cm]	[10 x 14.8 cm]	[A4]
Canon printer ↓				
PIXMA SELPHY DS	-	-	2, 4, 9 or 16 ¹	4
SELPHY CP	2, 4 or 8 ²	2 or 4	2 or 4	-
SELPHY ES	2, 4 or 8 ³	2 or 4	2 or 4	-

¹ You can also use the special sticker sheets.

² When you use the wide-sized photo paper with the [DEFAULT] setting, you can also use [2-UP] or [4-UP].

³ With the [8-UP] setting, you can also use the special sticker sheets.



Printing after Changing the Print Settings



- 1 If the joystick guide does not appear on screen, press to display it.
- 2 Push the joystick () toward . The print settings menu appears.

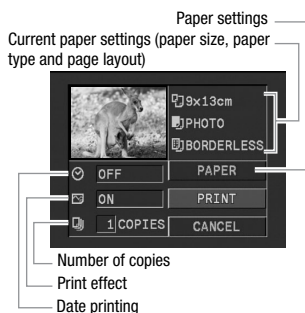

- 3 In the print settings menu, select (,) the setting you want to change and press .
- 4 Select (,) the desired setting option and press .
- 5 Select (,) [PRINT] and press .
 - Printing starts. The print settings menu disappears when the printing is completed.
 - To continue printing, select () another still image.

TO CANCEL THE PRINTING

- 1 Press while printing.
- 2 Select () [OK] and press .

PRINTING ERRORS

If an error occurs while printing, an error message appears (84).

- Canon's PictBridge-compatible printers: Resolve the error. When printing does not resume automatically, select [CONTINUE] and press . If [CONTINUE] cannot be selected, select [STOP], press and retry printing. Refer also to the printer's instruction manual for details.
- If the error still persists and printing does not restart, disconnect the USB cable and turn off the camcorder and the printer. After a short while, turn them on again, set the camcorder to mode and restore the connection.

WHEN YOU HAVE FINISHED PRINTING

Disconnect the cable from the camcorder and printer and turn off the camcorder.

! IMPORTANT

- The following still images may not be printed correctly with a PictBridge-compatible printer.
 - Images created or changed on a computer and transferred to the memory card.
 - Images recorded with the camcorder but edited on a computer.
 - Images whose file names were changed.
 - Images not recorded with this camcorder.
- Observe the following precautions during printing:
 - Do not turn off the camcorder or the printer.
 - Do not change the position of the switch.
 - Do not disconnect the USB cable.
 - Do not open the memory card slot cover and do not remove the memory card.

- If the message “BUSY” does not disappear, disconnect the USB cable and restore the connection after a short while.

Print Orders

You can mark in advance the still images you want to print and set the desired number of copies as a print order. Later, you can easily print out the print orders by connecting the camcorder to a PictBridge-compatible printer (□ 61). You can set print orders for up to 998 still images.

Selecting Still Images for Printing (Print Order)



POINTS TO CHECK

Set the print orders before connecting the USB cable to the camcorder.

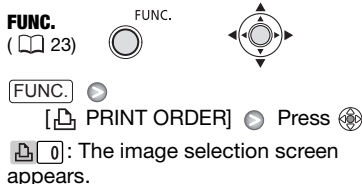

FROM THE IMAGE SELECTION SCREEN

- 1 Select (◀▶) the still image you want to mark with a print order.**
- 2 Press [PRINT] to set the print order.**
The number of copies appears in orange in the box next to the print order symbol □.
- 3 Set (▲▼) the number of copies desired and press [OK].**

To cancel the print order, set (▲▼) the number of copies to 0.

- 4 Repeat steps 1-3 to mark additional images with print orders or press [FUNC.] twice to close the menu.**

Printing the Still Images Marked with Print Orders



- 1 Connect the camcorder to the printer using the supplied USB cable.**

Refer to *PC Connection Diagram* (□ 68).

- 2 Open the print settings menu.**



The print settings menu appears. The error message “SET PRINT ORDER” appears if you connect a printer with direct print function and select [PRINT] without having set any print orders beforehand.

- 3 Select (▲▼, ◀▶) [PRINT] and press [OK].**

Printing starts. The print settings menu disappears when the printing is completed.

NOTES

- Depending on the connected printer, you can change some print settings before step 3 (□ 61).
- **Cancel Printing/Printing Errors** (□ 63).
- **Restarting Printing:** Open the print settings menu as explained in step 2. In the print settings menu, select [RESUME]* and



press . The remaining images will be printed.

Printing cannot be restarted when the print order settings have been changed or if you deleted a still image with print order settings.

- * In case the print order was interrupted after the first still image, this menu option will appear as [PRINT] instead.

Erasing All Print Orders



FUNC.

( 24)



FUNC. 

[ MENU] 

[ STILL IMG OPER.] 

[ERASE ALL  ORD] 

[YES] 

FUNC.



External Connections

This chapter explains step-by-step how to connect your camcorder to an external device such as a TV, VCR, or computer.

Connecting to a TV or VCR

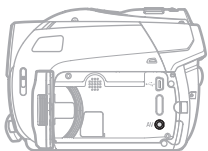

Open the LCD panel to access.



① AV Terminal

Sound from the built-in speaker will be muted while the STV-250N Stereo Video Cable is connected to the camcorder.

Connection Diagram

Turn off all the devices when making the connection and refer also to the instruction manual of the connected device.

Terminal on the camcorder

Connecting cable

Terminal on the connected device

1 Output connection (signal flow →) to a TV or VCR with AV terminals.





Playback on a TV Screen

This section explains how to play back the disc or still images with this camcorder by connecting it to a TV. To play back the disc with another DVD device refer to *Disc Playback on an External Device* (□ 48).



POINTS TO CHECK

Before connecting the camcorder, select the [TV TYPE] setting according to the TV set to which you will connect the camcorder (□ 77).

Connecting

Connect the camcorder to the TV following the connection diagram shown in the previous section *Connection Diagram* (□ 66).

Playback

1 Turn on the camcorder and the connected TV or VCR.

On a TV: Select as the video input the same terminal to which you connected the camcorder.

On a VCR: Set the input selector to the external video input (usually labeled LINE IN).

2 Start the playback of the movies (□ 35) or still images (□ 54).

NOTES

- Turn off all the devices before starting the connections.
- Sound from the built-in speaker will be muted while the STV-250N Stereo Video Cable is connected to the camcorder.
- We recommend powering the camcorder using the compact power adapter.

- Refer also to the instruction manual of the connected TV.

Copying your Recordings to an External Video Recorder

You can copy your recordings by connecting the camcorder to a VCR or a digital video device.



Connecting

Connect the camcorder to the device following the connection diagram shown in the previous section *Connection Diagram* (□ 66).

Recording

- 1 **Connected device: Load a blank cassette or disc and set the device to record pause mode.**
- 2 **This camcorder: Locate the scene you wish to copy and pause playback shortly before the scene.**
- 3 **This camcorder: Resume the movie playback.**
- 4 **Connected device: Begin recording when the scene you wish to copy appears. Stop recording when copying is complete.**
- 5 **This camcorder: Stop playback.**

NOTES

- We recommend powering the camcorder using the compact power adapter.
- By default, the on-screen displays will be embedded in the output video signal, but you can change the displays by repeatedly pressing [DISP.] (□ 37).

Connecting to a Computer

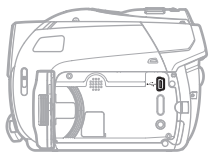

① USB Terminal

Open the LCD panel to access.

Note: Do not use the camcorder as an external drive when using a computer to create discs.

PC Connection Diagram

Terminal on the
camcorder

Connecting cable

Terminal on the
connected device

① Output connection (signal flow →) to a computer or PictBridge-compatible printer with a USB port.

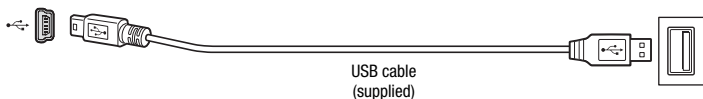

Corel Application Disc - Movie Playback/Editing and Various Disc Operations

The supplied CD-ROM **Corel Application Disc** includes software that will allow you to play back movies, transfer movies to a computer and easily edit them, make copies of your disc or create (author) new personalized discs, and more.

For further details, refer to the **Corel Application Disc Installation Guide and User Manual**.

Transferring Photos - Direct Transfer

With the supplied USB cable and software (on the **DIGITAL VIDEO Solution Disk** CD-ROM) you can transfer still images to a computer.

Preparations

Install the software before you connect the camcorder to the computer for the first time. (Windows users only: you also need to select CameraWindow's auto-launch setting.) After that, just connect the camcorder to the computer (steps 2



and 3) and proceed directly to transfer the still images (□ 69).

1 Install the supplied Digital Video Software.

Refer to the installation guide (separate leaflet included with the CD-ROM).

2 Set the camcorder to mode.



3 Connect the camcorder to the computer using the USB cable.

- Refer to *PC Connection Diagram* (□ 68).
- The direct transfer menu appears on the camcorder screen.

FIRST-TIME CONNECTION TO A COMPUTER RUNNING WINDOWS

Windows users only: The first time you connect the camcorder to the computer, you need also to select the CameraWindow auto-launch setting. See *Connecting the Camcorder to a Computer* in the *Digital Video Software* instruction manual (electronic version on PDF file).

IMPORTANT





- Observe the following precautions when the CARD access indicator is on or flashing. Failing to do so may result in permanent data loss.
 - Do not subject the camcorder to vibrations or strong impacts.
 - Do not open the memory card slot cover and do not remove the memory card.
 - Do not disconnect the USB cable.
 - Do not turn off the camcorder or the computer.
 - Do not change the position of the  /  switch or the operating mode.

- Operation may not work correctly depending on the software and the specifications/settings of your computer.
- If you wish to use the image files on your computer, make copies of them first. Use the copied files, retaining the originals.
- During the following operations, even if you connect the camcorder to the computer it will not be recognized.
 - Erasing all still images from the card
 - Erasing all transfer orders
 - Erasing all print orders

NOTES

- We recommend powering the camcorder using the compact power adapter.
- Refer also to the computer's instruction manual.
- Users of Windows Vista, Windows XP and Mac OS X:
Your camcorder is equipped with the standard Picture Transfer Protocol (PTP) allowing you to transfer still images (JPEG only) simply by connecting the camcorder to a computer using the USB cable without having to install the supplied software.

Transferring Images



 ALL IMAGES
Transfers all still images.
 NEW IMAGES
Transfers only those images that have not yet been transferred to the computer.
 TRANSFER ORDERS
Transfers still images marked with transfer orders (□ 70).
 SELECT & TRANSFER
Allows you to select the still image.

[WALLPAPER]

Allows you to select the still image and set it as your computer's desktop background.





AUTOMATIC TRANSFER OPTIONS

When you select [, ] or [], all the relevant still images will be transferred to the computer in one batch and their thumbnails will be displayed on the computer.

1 Select () a transfer option and press .

2 Select () [OK] and press .

- The camcorder returns to the transfer menu once the transfer is complete.
- To cancel the transfer, select () [CANCEL] and press  or press [FUNC.].

MANUAL TRANSFER OPTIONS

When you select [, ]:

1 Select () a transfer option and press .

2 Select () the image you want to transfer and press .

- [ SELECT & TRANSFER]: The selected image is transferred and displayed on the computer. To continue transferring, select () another image.

- [ WALLPAPER]: The selected image is transferred to the computer and displayed as the desktop's background.
- Press [FUNC.] to return to the transfer menu.

NOTES

When the camcorder is connected to the computer and the image selection screen is displayed, press [FUNC.] to return to the transfer menu.

Transfer Orders

You can mark in advance the still images you want to transfer to the computer as transfer orders. You can set transfer orders for up to 998 still images.





Selecting Still Images to Transfer (Transfer Order)

POINTS TO CHECK

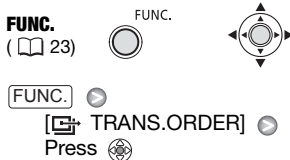
Set the transfer orders before connecting the camcorder to the computer.





 : The image selection screen appears.

FROM THE IMAGE SELECTION SCREEN

- 1 Select () the still image you want to mark with a transfer order.**



2 Press  to set the transfer order.

A checkmark ✓ appears in the box next to the transfer order symbol  .
Press  again to cancel the transfer order.

3 Repeat steps 1-2 to mark additional images with transfer orders or press **FUNC. twice to close the menu.**

Erasing All Transfer Orders

FUNC.
( 24)



FUNC. 

[ MENU] 

[ STILL IMG OPER.] 

[ERASE ALL  ORD] 

[YES] 

FUNC.



Additional Information

This chapter contains troubleshooting advice, screen messages, handling and maintenance tips, and other information.

Appendix: Menu Options Lists

Menu items not available appear grayed out. For details about how to select an item, refer to *Using the Menus* (p. 23). For details about each function, see the reference page. Menu options without a reference page are explained below the tables.

FUNC. Menu

Menu item	Setting options	CAMERA		PLAY		📖
		📷	📹	▶	📺	
Recording programs ¹	[P PROGRAM AE], [I TV SHUTTER-PRIO.AE], [S PORTRAIT], [S SPORTS], [N NIGHT], [S SNOW], [B BEACH], [S SUNSET], [A SPOTLIGHT], [F FIREWORKS]	●	●	–	–	38
White balance ¹	[A AUTO], [D DAYLIGHT], [T TUNGSTEN], [S SET]	●	●	–	–	43
Image effects ¹	[OFF IMAGE EFFECT OFF], [V VIVID], [N NEUTRAL], [D SOFT SKIN DETAIL]	●	●	–	–	44
LCD video light	[OFF LCD LIGHT OFF], [ON LCD LIGHT ON]	●	●	–	–	41
Digital effects ¹	[OFF D.EFFECT OFF], [T FADE-T], [W WIPE], [B BLK&WHT], [S SEPIA], [A ART], [M MOSAIC]	●	–	–	–	45
	[OFF D.EFFECT OFF], [B BLK&WHT], [S SEPIA]	–	●	–	–	
Recording mode	[H HIGH QUALITY], [S STANDARD PLAY], [L LONG PLAY]	●	–	–	–	32
Drive mode ¹	[S SINGLE], [C CONT.SHOOT.], [H HISPEED CONT.SHOOT.], [A AEB]	–	●	–	–	57



FUNC. Menu (cont.)

Menu item	Setting options	CAMERA		PLAY		Book icon
Still image size/quality	Size: [LW 1152x648], [L 1152x864], [S 640x480] Quality: [SUPER FINE], [FINE], [NORMAL]	-	●	-	-	53
[TO PLAYLIST] ²	-	-	-	●	-	47
[TO ORIGINAL] ³	-	-	-	●	-	47
[ADD TO PLAYLIST] ²	[ALL SCENES], [ONE SCENE], [CANCEL]	-	-	●	-	46
[MOVE] ³	-	-	-	●	-	47
[DIVIDE] ³	-	-	-	●	-	47
[DELETE] ⁴	[NO], [YES]	-	-	●	-	37
[SPEAKER VOL.] ⁵	-.....■■■■■■■■■■+	-	-	●	-	36
[SLIDESHOW]	-	-	-	-	●	55
[PROTECT]	-	-	-	-	●	59
[PRINT ORDER]	[0] - [99] COPIES	-	-	-	●	64
[TRANS.ORDER]	-	-	-	-	●	70

¹ Option available only when the mode switch is set to .







² Option available only in the original index screen with DVD-RW discs in VR mode.

³ Option available only in the playlist index screen with DVD-RW discs in VR mode.

⁴ Option available only in the index screen with DVD-RW discs in VR mode.

⁵ Option available only during playback.

CAMERA SETUP

Menu item	Setting options	CAMERA		
				
[A.SL SHUTTER] ¹	[ON ON], [OFF OFF]	●	●	–
[ZOOM TYPE]	[37x OPTICAL], [48x ADVANCED] ³ , [2000x DIGITAL]	●	–	32
[ZOOM SPEED]	[VAR VARIABLE], [3 SPEED 3], [2 SPEED 2], [1 SPEED 1]	●	●	33
[FOCUS PRI.] ²	[AiAF ON: AiAF], [ON : CENTER], [OFF OFF]	–	●	58
[REVIEW]	[OFF OFF], [2sec 2 sec], [4sec 4 sec], [6sec 6 sec], [8sec 8 sec], [10sec 10 sec]	–	●	–
[IMG STAB] ²	[ON ON ], [OFF OFF]	●	–	–
[WIDESCREEN]	[ON ON], [OFF OFF]	●	–	–
[SELF TIMER]	[ON ON ], [OFF OFF]	●	●	41
[WIND SCREEN] ²	[A AUTO], [OFF OFF ]	●	–	–

¹ Option available only when the recording program is set to **EASY** or **P** (only in the **P** PROGRAM AE) recording program).

² Option available only when the mode switch is set to **P**.

³ [**55x** ADVANCED] when [WIDESCREEN] is set to [**OFF** OFF].

[A.SL SHUTTER]: The camcorder automatically uses slow shutter speeds to obtain brighter recordings in places with insufficient lighting.

- The camcorder uses shutter speeds down to 1/30 (1/15 in **CAMERA** mode).
- If a trailing afterimage appears, set the slow shutter to [**OFF** OFF].
- If  (camcorder shake warning) appears, we recommend stabilizing the camcorder, for example, by mounting it on a tripod.

[REVIEW]: Selects the time to display a still image after it has been recorded.

- This menu item will not be available when the drive mode ( 57) is set to **CONT.SHOOT.**, **HISPEED CONT.SHOOT.** or **AEB**.
- If you press **[DISP.]** while reviewing a still image it will continue to be displayed indefinitely. Press **[Start/Stop]** to return to the normal display.

[IMG STAB]: The image stabilizer compensates for camcorder shake even at full telephoto.

- The image stabilizer is designed to compensate for a normal degree of camcorder shake.
- The image stabilizer may not be effective when recording in dark places with [A.SL SHUTTER] set to [**ON** ON] or using the **NIGHT** recording program.
- The image stabilizer cannot be turned off when the mode switch is set to **EASY**.
- We recommend setting the image stabilizer to [**OFF** OFF] when using a tripod.

[WIDESCREEN]: The camcorder uses the full width of the image sensor providing high-resolution 16:9 recordings.

- Since the screens on the camcorder have an aspect ratio of 16:9, recordings with a 4:3 aspect ratio will appear in the center of the screen with black sidebars.



- **Playing back a widescreen recording:** TV sets compatible with the Video ID-1 system will automatically switch to wide (16:9) mode. Otherwise, change the aspect ratio of the TV manually. To play back on a TV with normal aspect ratio (4:3) change the [TV TYPE] setting accordingly (□ 77).

[WIND SCREEN]: The camcorder automatically reduces the background sound of wind when recording outdoors.

- The wind screen cannot be turned off when the mode switch is set to **EASY**.
- Some low-frequency sounds will be suppressed along with the sound of wind. When recording in surroundings unaffected by wind or if you want to record low-frequency sounds, we recommend setting the wind screen to [OFF OFF OFF].

DISC OPERATIONS

Menu item	Setting options	CAMERA	PLAY	
[DISC INFO]	–	●	●	–
[INITIALIZE DISC] ¹	[VIDEO], [VR], [CANCEL]	●	●	48
[FINALIZE]	[NO], [YES]	–	●	49
[UNFINALIZE] ²	[NO], [YES]	–	●	50
[DEL.ALL MOVIES] ³	[NO], [YES]	–	●	37
[DEL.PLAYLIST] ⁴	[NO], [YES]	–	●	37
[DISC TITLE]	–	–	●	48

¹ Option available only with DVD-RW discs.

² Option available only with finalized DVD-RW discs in VIDEO mode.

³ Option available only in the original index screen with DVD-RW discs in VR mode.

⁴ Option available only in the playlist index screen with DVD-RW discs in VR mode.



















[DISC INFO]: Displays a screen where you can verify the details regarding the disc.

- The disc information includes the disc title, the disc type (DVD-R, DVD-R DL or DVD-RW), the disc specification (VIDEO mode or VR mode), and an icon to indicate whether the disc is finalized (Ⓢ). Additionally, the total recorded time is displayed for non-finalized discs.

STILL IMG OPER.

Menu item	Setting options	PLAY	
[ERASE ALL ORD]	[NO], [YES]	●	65
[ERASE ALL ORD]	[NO], [YES]	●	65
[ERASE ALL IMAGES]	[NO], [YES]	●	56
[INITIALIZE CARD]	[INITIALIZE], [COMPL.INIT.], [CANCEL]	●	60

DISPLAY SETUP

Menu item	Setting options	CAMERA		PLAY		
						
[BRIGHTNESS]		●	●	●	●	–
[TV SCREEN]	[ ON] ON], [ OFF] OFF]	●	●	–	–	–
[MARKERS]	[ OFF] OFF], [ LEVEL(WHT)], [ LEVEL(GRY)], [ GRID(WHT)], [ GRID(GRY)]	●	●	–	–	–
[DATA CODE]	[ DATE], [ TIME], [ DATE & TIME], [ CAMERA DATA]	–	–	●	–	37
[LANGUAGE]	[ČEŠTINA], [DEUTSCH], [ΕΛΛΗΝΙΚΑ], [ENGLISH], [ESPAÑOL], [FRANÇAIS], [ITALIANO], [MAGYAR], [MELAYU], [POLSKI], [ROMÂNĂ], [TÜRKÇE], [РУССКИЙ], [УКРАЇНСЬКА], [العربية], [فارسی], [ภาษาไทย], [简体中文], [繁體中文], [한국어], [日本語]	●	●	●	●	25
[DEMO MODE]	[ ON] ON], [ OFF] OFF]	●	●	–	–	–

[BRIGHTNESS]: Adjust (◀▶) the brightness of the LCD display with the joystick.

- Changing the brightness of the LCD display does not affect that of the viewfinder or the recordings.

[TV SCREEN]: When set to [ ON] ON], the camcorder's on-screen displays will appear also on the screen of a connected TV or monitor.

[MARKERS]: You can display a grid or a horizontal line at the center of the screen. The markers are available in white or gray. Use the markers as a reference to make sure your subject is framed correctly (vertically and/or horizontally).

- Using the markers will not affect the recordings.

[DEMO MODE]: The demonstration mode displays the camcorder's main features. It starts automatically when the camcorder is powered with the power adapter if you leave it turned on without loading a recording media for more than 5 minutes.

- To cancel the demo mode once it started, press any button, turn off the camcorder or load a disc.



SYSTEM SETUP

Menu item	Setting options	CAMERA		PLAY		
[WL.REMOTE]	[ON ON], [OFF OFF]	●	●	●	●	–
[SPEAKER VOL.]		–	–	●	–	–
[BEEP]	[HIGH VOLUME], [LOW VOLUME], [OFF OFF]	●	●	●	●	–
[POWER SAVE]	[ON ON], [OFF OFF]	●	●	●	●	–
[STANDBY OFF]	[10min 10 min], [20min 20 min], [30min 30 min]	●	●	–	–	–
[FILE NOS.]	[RESET], [CONTINUOUS]	–	●	–	–	–
[TV TYPE]	[4:3 NORMAL TV], [16:9 WIDE TV]	●	●	●	●	–
[FIRMWARE]	–	–	–	–	●	–

[WL. REMOTE]: Allows the camcorder to be operated with the wireless controller.

[SPEAKER VOL.]: Adjust () the volume of the playback.

[BEEP]: A beep will accompany some operations like turning on the camcorder, the self-timer countdown, etc. It also serves as a warning beep under unusual conditions.

[POWER SAVE]: In order to save power when the camcorder is powered by a battery pack, it will automatically shut off if left without any operation for 5 minutes. Approximately 30 seconds before the camcorder shuts off, the message “ AUTO POWER OFF ” will appear.

[**STANDBY OFF]:** Select the length of time after which the camcorder will end the standby mode and shut off automatically.

[FILE NOS.]: Select the image numbering method to be used when you insert a new memory card.

Images are automatically assigned consecutive image numbers from 0101 to 9900, and stored in folders containing up to 100 images. Folders are numbered from 101 to 998.

[**RESET**]: Image numbers will restart from 101-0101 every time you insert a new memory card.

[**CONTINUOUS**]: Image numbers will continue from the number following that of the last image recorded with the camcorder.

- If the memory card you insert already contains an image with a larger number, a new image will be assigned a number one higher than that of the last image on the memory card.
- We recommend using the [**CONTINUOUS**] setting.





[TV TYPE]: In order to display the picture in full and in the correct aspect ratio, select the setting according to the type of television to which you will connect the camcorder.

[**4:3 NORMAL TV**]: TV sets with 4:3 aspect ratio.

[**16:9 WIDE TV**]: TV sets with 16:9 aspect ratio.

[FIRMWARE]: You can verify the current version of the camcorder’s firmware. This menu option is usually grayed out.

DATE/TIME SETUP

Menu item	Setting options	CAMERA		PLAY		
						
[T.ZONE/DST]	List of world time zones.	●	●	●	●	26
[DATE/TIME]	–	●	●	●	●	25
[DATE FORMAT]	[Y.M.D (2008.1.1 AM 12:00)], [M.D,Y (JAN. 1, 2008 12:00 AM)], [D.M.Y (1.JAN.2008 12:00 AM)]	●	●	●	●	–

[DATE FORMAT]: Changes the date format for on-screen displays and for date printing.



Troubleshooting



If you have a problem with your camcorder, refer to this section. Consult your dealer or a Canon Service Center if the problem persists.

Power Source

- **The camcorder will not turn on or it turns off by itself.**
- **The disc compartment cover will not open.**
- **The LCD/viewfinder switches on and off.**

- Battery pack is exhausted. Replace or charge the battery pack (□ 19).
- Attach the battery pack correctly.
- Use the compact power adapter.

The charge indicator flashes rapidly.

-  (one flash at 0.5-second intervals)
Charging has stopped because the compact power adapter or the battery pack is faulty. Consult a Canon Service Center.
-  (two quick flashes at 1-second intervals)
Battery pack at least 50% charged (□ 20). This is not a malfunction.

- **Battery pack will not charge.**
- **The charge indicator flashes very slowly (one flash at 2-second intervals).**

- Charge the battery pack in temperatures between 0 °C and 40 °C (32 °F and 104 °F).
- Battery packs become hot with use and may not charge. When the battery pack is outside the charging temperature range, the CHARGE indicator will flash irregularly. The charging will start once the battery pack temperature is below 40 °C (104 °F).
- The battery pack is damaged. Use a different battery pack.
- If you connect a faulty power adapter or battery pack, the CHARGE indicator flashes approx. twice per second and the charging stops.

- Check that the compact power adapter is correctly connected to the camcorder.

Camcorder is on but is unresponsive.

- The camcorder has exceeded its operational temperature (□ 28 appears). Turn off the camcorder and let it cool down before resuming use.

Recording/Playback

Buttons will not work.

- Turn on the camcorder.
- Load a disc (□ 27).

Abnormal characters appear on the screen. The camcorder does not operate properly.

- Disconnect the power source and reconnect it after a short time. If the problem still persists, disconnect the power source and press the RESET button with a pointed item. Pressing the RESET button resets all settings.

appears on the screen.

- Load a disc (□ 27).

appears on the screen.

- Battery pack is exhausted. Replace or charge the battery pack (□ 20).

The wireless controller will not work.

- Set [WL.REMOTE] to [ON] (□ 77).
- The battery of the wireless controller is exhausted. Replace the battery (□ 20).

Video noise appears on screen.

- When using the camcorder close to devices that emit strong electromagnetic fields (plasma TVs, cellular phones, etc.), keep a distance between the camcorder and these devices.

Video noise appears on the TV screen.

- When using the camcorder in a room where a TV is located, keep a distance between the compact power adapter and the power or antenna cables of the TV.

Even without a disc loaded, when closing the disc compartment cover a motor sound can be heard.

- The camcorder is checking if a disc is loaded or not. This is not a malfunction.

Cannot open the disc cover to remove the disc.

- Turn off the camcorder, disconnect the compact power adapter and remove the battery pack. Restore the power supply and try again.
- The camcorder has exceeded its operational temperature. Turn off the camcorder and let it cool down before resuming use.

The disc cannot be recognized.

- The disc is dirty. Clean the disc with a soft lens-cleaning cloth (□ 87). If the problem persists replace the disc.
- The disc is not correctly loaded. Check the disc (□ 27).
- Verify that the camcorder supports the type of DVD disc you inserted (□ 5).

The camcorder vibrates.

- Depending on the condition of the disc, the camcorder might vibrate occasionally. This is not a malfunction.

- **The disc's rotation can be faintly heard.**
- **Occasionally the operation sound can be heard.**

- The disc is activated from time to time. This is not a malfunction.

- **After using the camcorder for a long time, it becomes hot.**

- **LED lights up in red.**

- This is not a malfunction. Turn the camcorder off and let it cool for a while before resuming operation.

Recording

Image will not appear on the screen.

- Set the camcorder to  mode (□ 30).

- Open the lens cover.

Pressing will not start recording.

- Set the camcorder to  mode (□ 30).
- Load a disc that has been tested (□ 6).
- The disc is full ("END" appears on the screen). Delete some recordings (DVD-RW in VR mode) to free some space (□ 37) or replace the disc.
- The camcorder has exceeded its operational temperature. Turn off the camcorder and let it cool down before resuming use.
- Unfinalize (□ 50) the disc (DVD-RW in VIDEO mode).

Even after stopping recording, the disc access indicator does not go off.

- The scene is being recorded on the disc. This is not a malfunction.

The point where was pressed does not match the beginning/end of the recording.

- There is a slight interval between pressing  and the actual start of the recording on the disc. This is not a malfunction.

The recording suddenly stops shortly after starting recording.

- The disc is dirty. Clean the disc with a soft lens-cleaning cloth (□ 87). If the problem persists replace the disc.
- The camcorder has exceeded its operational temperature. Turn off the camcorder and let it cool down before resuming use.

Camcorder will not focus.

- Autofocus does not work on that subject. Focus manually (□ 42).
- If you are using the viewfinder, adjust it with the diopter adjustment lever (□ 31).
- Lens is dirty. Clean the lens with a soft lens-cleaning cloth (□ 87). Never use tissue paper to clean the lens.

Sound is distorted.

- When recording near loud sounds (such as fireworks or concerts), sound may become distorted.



A vertical light bar appears on the screen.

- Bright light in a dark scene may cause a vertical light bar (smear) to appear. This is not a malfunction.

Viewfinder picture is blurred.

- Adjust the viewfinder with the dioptic adjustment lever (□ 31).

Playback/Editing

Playback does not start.

- Load a disc (□ 27).
- Set the camcorder to **PLAY** mode (□ 35).
- You may not be able to play with this camcorder, discs recorded or edited with other DVD recorders or computer DVD drives.
- If using a single-sided disc, check that the disc is inserted with the label side facing up.
- The camcorder has exceeded its operational temperature. Turn off the camcorder and let it cool down before resuming use.

• During playback there is video noise and the sound is distorted.

• The disc cannot be read.

- The disc is dirty. Clean the disc with a soft lens-cleaning cloth (□ 87).
- You may not be able to play with this camcorder, discs recorded or edited with other DVD recorders or computer DVD drives.

Cannot add scenes to the playlist.

- The disc is full (“END” appears on the screen). Delete some recordings to free some space (□ 37).
- You cannot add more than 999 scenes to the playlist.

Cannot divide the scene.

- You cannot edit or delete scenes on a disc that was recorded in another digital device.
- You cannot divide the scene if there are already 999 scenes on the disc.
- You cannot divide original scenes.
- You cannot divide the scene if it is too short (2 seconds or less).

Cannot edit the disc title.

- You cannot add a title to a DVD-R/DVD-R DL disc after it was finalized (□ 49).
- Unfinalize (□ 50) the disc first (DVD-RW in VIDEO mode).
- You may not be able to edit the title if you entered it with another digital device.

Cannot edit or delete scenes.

- You cannot edit or delete scenes on a disc that was protected with another digital device.
- Scenes cannot be deleted in a DVD-R/DVD-R DL disc or a DVD-RW disc recorded in VIDEO mode.

Cannot finalize the disc.

- The camcorder has exceeded its operational temperature. Turn off the camcorder and let it cool down before resuming use.
- When using a battery pack, make sure it is fully charged.

No sound from the built-in speaker.

- Open the LCD panel.
- Speaker volume is turned off. Adjust the volume with the [SPEAKER VOL.] setting (□ 36).

Playing Back the Disc in an External DVD Device

There is a brief stop between scenes.

- Depending on the DVD player, there might be a very short stop between scenes during playback.

Disc is running, but image will not appear on the TV screen.

- The video input on the TV is not set to the video terminal to which you connected the camcorder. Select the correct video input.
- You attempted to play back an incompatible disc. Stop playback.

The disc cannot be recognized by the device. Or, even though the disc is read, cannot play back the disc or the picture is distorted.

- The disc is dirty. Clean the disc with a soft lens-cleaning cloth (□ 87).

- Finalize the disc using the camcorder (□ 49).
- DVD-RW discs in VR mode can only be played back with VR mode-compatible DVD players. Refer to the instruction manual of your DVD device.

Cannot edit my recordings or add recordings to the disc with the DVD device.

- It may not be possible to edit or add recordings with an external DVD recorder on a disc recorded with this camcorder.

Memory Card Operation

Memory card cannot be inserted.

- Memory card is not facing the correct direction. Turn the memory card over and reinsert it (□ 29).

Cannot record on the memory card.

- Memory card is full. Erase still images (□ 56) to free some space or replace the memory card.
- Memory card was not initialized. Initialize the memory card (□ 60).
- The folder and file numbers have reached their maximum value. Set [FILE NOS.] to [RESET] (□ 77) and insert a new memory card.
- The write-protect switch on an SD or SDHC memory card is set to prevent accidental erasure. Change the position of the write-protect switch.

Memory card cannot be played back.

- Set the camcorder to  mode (□ 54).

Image cannot be erased.

- Image is protected. Cancel the protection (□ 59).
- The write-protect switch on an SD or SDHC memory card is set to prevent accidental erasure. Change the position of the write-protect switch.

appears in red.

- A memory card error occurred. Turn off the camcorder. Remove and reinsert the memory card. Initialize the memory card (□ 60) if the icon still appears in red.

Printing

The printer is not operating even though the camcorder and printer are correctly connected.

- Disconnect the USB cable and turn off the camcorder and the printer. After a short while, turn them on again, set the camcorder to  mode and restore the connection.

List of Messages (in alphabetical order)

CANNOT ENTER THE STANDBY MODE NOW

- The camcorder cannot enter the Quick Start standby mode (□ 34) while the disc is being recognized after it was inserted or if the remaining battery charge is too low.

CANNOT PLAY BACK

- The disc is dirty or you attempted to play back a disc type not supported by this camcorder (not DVD-R/RW) or a disc that is dirty or scratched.
- This message can also appear if condensation has formed. Wait until the camcorder dries completely before resuming use (□ 90).

CANNOT READ THE DISC CHECK THE DISC

- Disc could not be read. Try cleaning it or replace the disc (□ 87).
- This message can also appear if the camcorder has exceeded its operational temperature. Turn off the camcorder and let it cool down before resuming use.
- This message can also appear if condensation has formed. Wait until the camcorder dries completely before resuming use (□ 90).
- The disc may not be loaded correctly. Try removing the disc and reinserting it (□ 27).



• CANNOT RECORD

• CANNOT RECORD

CHECK THE DISC

- There is a problem with the disc. Replace the disc (□ 27).
- This message can also appear if condensation has formed. Wait until the camcorder dries completely before resuming use (□ 90).
- The disc's recording surface may be dirty or scratched.
- This message may appear when the camcorder is repeatedly subject to vibration.

CANNOT USE DISC USE OF A RECOMMENDED DISC IS ADVISED

- The disc cannot be used. We recommend that you use a disc that has been tested (□ 6).

CARD ERROR

- A memory card error occurred. The camcorder cannot record or display the image. The error may be temporary. If the message disappears after 4 seconds and □ appears in red, turn the camcorder off, remove the card and reinsert the card. If □ changes to green, you can resume recording/playback.

CARD FULL

- Memory card is full. Erase some images (□ 56) to free some space or replace the memory card.

CHANGE THE BATTERY PACK

- Battery pack is exhausted. Replace or charge the battery pack (□ 19).

DISC ACCESS FAILURE CHECK THE DISC

- There was an error when reading the disc or attempting to write onto it. Try cleaning the disc or replace it (□ 87).
- This message can also appear if condensation has formed. Wait until the camcorder dries completely before resuming use (□ 90).
- The disc may not be loaded correctly. Try removing the disc and reinserting it (□ 27).

DISC COVER IS OPEN

- Verify the disc is correctly inserted and close the disc cover (□ 27).

DISC FULL

- The disc is full ("END" appears on the screen). Delete some recordings (DVD-RW in VR mode) to free some space (□ 37) or replace the disc.

DISC IS FINALIZED CANNOT RECORD

- You cannot record additional scenes on a finalized DVD-R/DVD-R DL disc.
- You cannot record additional scenes or unfinalize a DVD-RW disc in VIDEO mode that was finalized with another digital device.

DISC MUST BE FINALIZED TO PLAY BACK IN COMPATIBLE PLAYERS

- Be sure to finalize the disc and check the compatibility of the device before playing back the disc on external DVD devices (□ 49).

LOADING THE DISC

- The disc is being read. Wait before you start recording.

NAMING ERROR

- The folder and file numbers have reached their maximum value. Set the [FILE NOS.] option to [RESET] and erase all the images on the memory card (□ 56) or initialize it (□ 60).

NO CARD

- There is no memory card in the camcorder (□ 29).

NO DISC

- No disc is loaded. Insert a disc (□ 27).
- This message can also appear if condensation has formed. Wait until the camcorder dries completely before resuming use (□ 90).

NO IMAGES

- No images are recorded on the memory card.

PRINT ORDER ERROR

- You attempted to set more than 998 still images in the print order (□ 64).

REACHED THE MAXIMUM NUMBER OF SCENES

- The maximum number of scenes has been reached. Delete some recordings (DVD-RW in VR mode) to free some space (□ 37) or replace the disc.

RECOVERING DATA PLEASE WAIT...

- Data on the disc is being recovered. Wait until this message disappears before resuming use.

TASK IN PROGRESS DO NOT DISCONNECT THE POWER SOURCE

- The camcorder is updating important file allocation data on the disc. Do not disconnect the compact power adapter or remove the battery pack.

• TEMPERATURE TOO HIGH CANNOT RECORD

• TEMPERATURE TOO HIGH CANNOT REMOVE DISC

- The camcorder has exceeded its operational temperature. Disconnect the compact power adapter and remove the battery and let the camcorder cool down before resuming use.

TOO MANY STILL IMAGES DISCONNECT USB CABLE

Disconnect the USB cable and decrease the number of still images on the memory card to less than 1,800. If a dialog appeared on the computer screen, close it and then restore the connection.

TRANSFER ORDER ERROR

You attempted to set more than 998 transfer orders (□ 70).

UNABLE TO RECOGNIZE THE DATA

- The disc may not be recognized by this camcorder if it was initialized with a different device.
- You inserted a disc recorded in a different Television System (PAL or SECAM).

UNABLE TO RECOVER DATA

- Could not recover a corrupted file.
- This message can also appear if condensation has formed. If you suspect condensation is the reason, do not initialize the disc and wait until the

camcorder dries completely before resuming use (□ 90).

UNFINALIZE THE DISC

- You cannot record additional scenes on a finalized DVD-RW in VIDEO mode. Unfinalize the disc first (□ 50).

USE OF A RECOMMENDED DISC IS ADVISED

- The disc can be used but performance is not guaranteed. We recommend that you use a disc that has been tested (□ 6).

Direct Print Related Messages

About Canon PIXMA/SELPHY DS Printers: If the printer's error indicator flashes or an error message appears on the printer's operation panel, refer to the printer's instruction manual.

CANNOT PRINT!

- You attempted to print an image that was recorded with another camcorder, with a different compression, or was edited on a computer.

COMMUNICATION ERROR

- The printer is experiencing a data transfer error. Cancel printing. Disconnect the USB cable and turn off the camcorder and the printer. After a short while, turn them on again, set the camcorder to **PLAY** mode and restore the connection. If you attempted to print from a memory card that contains a large number of images, reduce the number of images.

COULD NOT PRINT X IMAGES

- You attempted to use the print order settings to print X images that were recorded with another camcorder, with a different compression or were edited on a computer.

FILE ERROR

- You attempted to print an image that was recorded with another camcorder,



with a different compression, or was edited on a computer.

HARDWARE ERROR

- Cancel printing. Turn off the printer and turn it back on. Check the printer status. If the printer is equipped with a battery, it might be exhausted. In such case, turn off the printer, replace the battery and turn it back on.

INCOMPATIBLE PAPER SIZE

- The paper settings of the camcorder conflict with the printer's settings.

INK ABSORBER FULL

- Select [CONTINUE] to resume printing. Consult a Canon Service Center (refer to the list included with the printer) to replace the ink absorber.

INK ERROR

- There is a problem with the ink.

LOW INK LEVEL

- The ink cartridge needs to be replaced soon. Select [CONTINUE] to restart printing.

NO INK

- The ink cartridge is not inserted or is out of ink.

NO PAPER

- Paper is not correctly inserted or there is no paper.

NO PRINTHEAD

- No print head is installed in the printer or the print head is defective.

PAPER ERROR

- There is a problem with the paper. The paper is not correctly loaded or the paper size is wrong. Alternatively, if the paper output tray is closed, open it to print.

PAPER JAM

- The paper jammed during printing. Select [STOP] to cancel printing. After removing the paper, set some paper again and retry printing.

PAPER LEVER ERROR

- Paper lever error occurred. Adjust the paper selection lever to the proper position.

PRINT ERROR

- Cancel printing, disconnect the USB cable and turn off the printer. After a while, turn the printer back on and reconnect the USB cable. Check the printer status.

PRINTER COVER OPEN

- Close the printer cover securely.

PRINTER ERROR

- Cancel printing. Turn off the printer and turn it back on. Check the printer status. If the error still persists, refer to the printer's instruction manual and contact the appropriate customer support center or service center.

PRINTER IN USE

- The printer is in use. Check the printer status.

SET PRINT ORDER

- No still image on the memory card has been marked with a print order.

Handling Precautions

Camcorder

- Do not touch the pick up lens.
- Do not subject the camcorder to vibrations or strong impacts while the DISC access indicator is on or flashing. The data may not be correctly recorded on the disc, and the recording may be permanently lost.
- Do not carry the camcorder by the LCD panel or the disc cover. Be careful when closing the LCD panel.
- Do not leave the camcorder in places subject to high temperatures (like the inside of a car under direct sunlight), or high humidity.
- Do not use the camcorder near strong electromagnetic fields such as above TVs, near plasma TVs or mobile phones.
- Do not point the lens or viewfinder at strong light sources. Do not leave the camcorder pointed at a bright subject.
- Do not use or store the camcorder in dusty or sandy places. The camcorder is not waterproof – avoid also water, mud or salt. If any of the above should get into the camcorder it may damage the camcorder and/or the lens. Be sure to close the disc compartment cover after use.
- Be careful of heat generated by lighting equipment.
- Do not disassemble the camcorder. If the camcorder does not function properly, consult qualified service personnel.
- Handle the camcorder with care. Do not subject the camcorder to shocks

or vibration as this may cause damage.

Battery Pack

DANGER!

Treat the battery pack with care.

- Keep it away from fire (or it might explode).
 - Do not expose the battery pack to temperature higher than 60 °C (140 °F). Do not leave it near a heater or inside a car in hot weather.
 - Do not try to disassemble or modify it.
 - Do not drop it or subject it to shocks.
 - Do not get it wet.
- Charged battery packs continue to discharge naturally. Therefore, charge them on the day of use, or the day before, to ensure a full charge.
 - Contact of the battery pack terminals with metallic objects may cause a short circuit and damage the battery pack.
 - Dirty terminals may cause a poor contact between the battery pack and the camcorder. Wipe the terminals with a soft cloth.
 - Since storing a charged battery pack for a long time (about 1 year) can shorten its lifecycle or affect performance, we recommend to discharge the battery pack fully and to store it in a dry place at temperatures no higher than 30 °C (86 °F). If you do not use the battery pack for long periods, charge and discharge it fully at least once a year. If you have more than one battery pack, perform these



precautions at the same time for all battery packs.

- Although the battery pack's operating temperature range is from 0 °C to 40 °C (32 °F to 104 °F), the optimal range is from 10 °C to 30 °C (50 °F to 86 °F). At cold temperatures, performance will temporarily decline. Warm it in your pocket before use.
- Replace the battery pack if the usable time after full charge diminishes substantially at normal temperatures.

About the battery terminal cover

The battery terminal cover has a []-shaped hole. This is useful when you wish to differentiate between charged and uncharged battery packs.

Back side of the battery pack

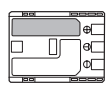

Terminal cover attached

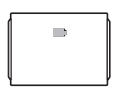

Charged



Uncharged

Mini DVD Disc

The recording surface of DVD discs is extremely delicate. If handled or stored in an incorrect manner, the camcorder may stop recognizing or may not be able to play back the disc. Be sure to observe the following precautions when storing/handling your discs.

- **Always remove the disc from the camcorder after you finish recording.**

Do not store the camcorder with a disc left inside.

- Do not bend, scratch or wet the disc and do not subject it to strong shocks.
- Do not attach any labels or stickers on the disc surfaces. The disc may not rotate in a stable manner and this may cause malfunctions.
- Keep the disc clean of dust, dirt or smudges. Even very small smudges or particles of dust can lead to problems when recording or playing back the disc. Carefully inspect the recording surface of the disc before inserting it in the camcorder. If the disc gets dirty use a dry, soft lens-cleaning cloth to remove any fingerprints, dirt buildup or smudges from the disc surface. Clean the disc in a radial motion from its center outwards.
- Never use a chemically treated cloth or flammable solvents such as paint thinner to clean the disc.
- To protect the disc, return it to its case for storage.
- When writing on the label side of the disc, avoid hard tip pens. Use waterproof soft-tipped felt pens instead.
- Moving a disc rapidly between hot and cold temperatures may cause condensation to form on its surfaces. If condensation forms on the disc, put it aside until the water droplets have evaporated completely.
- Never expose the disc to direct sunlight and do not store it in places subject to high temperatures or high humidity.
- Always finalize a disc before inserting it into an external DVD device. Failing to do so can result in the loss of the recorded data.

Memory Card

- We recommend saving backups of memory card images on your computer. Image data may be corrupted or lost due to memory card defects or exposure to static electricity. Canon makes no warranties for corrupted or lost data.
- Do not turn off the camcorder, disconnect the power source or remove the memory card while the CARD access indicator is flashing.
- Do not use memory cards in places subject to strong magnetic fields.
- Do not leave memory cards in places subject to high humidity and high temperature.
- Do not disassemble, bend, drop, or subject memory cards to shocks and do not expose them to water.
- Do not touch or expose the terminals to dust or dirt.
- Check the direction before inserting the memory card. Forcing a memory card into the slot if it is not correctly oriented may damage the memory card or the camcorder.
- Do not attach any labels or stickers on the memory card.
- When you erase image files or initialize the memory card, only the file allocation table is altered and the data itself is not actually deleted. Take the necessary precautions when you dispose of the memory card, for example by physically damaging it to prevent the leakage of private data.

Lithium Button Battery

WARNING!

- The battery used in this device may present a fire or chemical burn hazard if mishandled.
 - Do not disassemble, modify, immerse in water, heat above 100 °C (212 °F) or incinerate the battery.
 - Lithium battery for the wireless controller: Replace with a CR2025 battery made by Panasonic, Hitachi Maxell, Sony, Sanyo, or with Duracell2025. Use of other batteries may present a risk of fire or explosion.
 - Do not insert the battery into the mouth. If swallowed, seek medical assistance immediately. The battery case may break and the battery fluids may cause internal damage.
 - Keep the battery out of the reach of children.
 - Do not recharge, short-circuit or insert the battery in the wrong direction.
 - Dispose of the used battery according to applicable recycling regulations.
-
- Do not pick up the battery using tweezers or other metal tools as this will cause a short circuit.
 - Wipe the battery with a clean dry cloth to ensure proper contact.
 - **For California, USA only:** The lithium battery included contains Perchlorate Material - special handling may apply. See www.dtsc.ca.gov/hazardouswaste/perchlorate for details.



Built-in Rechargeable Lithium Battery

The camcorder has a built-in rechargeable lithium battery to keep the date/time and other settings. The built-in lithium battery is recharged while you use the camcorder; however, it will become totally discharged if you do not use the camcorder for about 3 months.

To recharge the built-in lithium battery:

Connect the compact power adapter to the camcorder and leave it connected for 24 hours with the **POWER** switch set to **OFF**.

Maintenance/Others

Storage

If you do not intend to use the camcorder for a long time, store it in a place free of dust, in low humidity, and at temperatures not higher than 30 °C (86 °F).

Cleaning

Camcorder Body

- Use a soft, dry cloth to clean the camcorder body. Never use chemically treated cloths or volatile solvents such as paint thinner.

Pick Up Lens

- Remove any dust or dirt particles using a non-aerosol type blower brush. Never touch the pick up lens directly to clean it.

Lens and Viewfinder

- If the lens surface is dirty, the autofocus may not work properly.
- Remove any dust or dirt particles using a non-aerosol type blower brush.
- Use a clean, soft lens-cleaning cloth to gently wipe the lens or viewfinder. Never use tissue paper.

LCD Screen

- Clean the LCD screen using a clean, soft lens-cleaning cloth.
- Condensation may form on the surface of the screen when the

temperature changes suddenly. Wipe it with a soft dry cloth.

Condensation

Moving the camcorder rapidly between hot and cold temperatures may cause condensation (water droplets) to form on its internal surfaces. Stop using the camcorder if condensation is detected. Continued use may damage the camcorder.

Condensation may form in the following cases:

- When the camcorder is moved from an air-conditioned room to a warm, humid place
- When the camcorder is moved from a cold place to a warm room
- When the camcorder is left in a humid room
- When a cold room is heated rapidly

TO AVOID CONDENSATION

- Do not expose the camcorder to sudden or extreme changes in temperature.
- Unload the disc, place the camcorder in an airtight plastic bag and let it adjust to temperature changes slowly before removing it from the bag.

WHEN CONDENSATION IS DETECTED

- If a disc is loaded, remove the disc immediately and leave the disc cover open. Leaving the disc in the camcorder may damage it.
- A disc cannot be loaded when condensation is detected.

RESUMING USE

The precise time required for water droplets to evaporate will vary depending on the location and weather conditions. As a general rule, wait for 2 hours before resuming use of the camcorder.

Using the Camcorder Abroad

Power Sources

You can use the compact power adapter to operate the camcorder and to charge battery packs in any country with power supply between 100 and 240 V AC, 50/60 Hz. Consult a Canon Service Center for information on plug adapters for overseas use.

Playback on a TV Screen

You can only play back your recordings on TVs compatible with the NTSC system. The NTSC system is used in the following countries/areas:

American Samoa, Antigua, Aruba, Bahamas, Barbados, Bermuda, Bolivia, Canada, Chile, Colombia, Costa Rica, Cuba, Ecuador, El Salvador, Greenland, Guam, Guatemala, Haiti, Honduras, Jamaica, Japan, Korea, Mexico, Micronesia, Myanmar, Nicaragua, Panama, Peru, Philippines, Puerto Rico, Saint Kitts and Nevis, Saint Lucia, Saint Vincent and the Grenadines, Surinam, Taiwan, Trinidad and Tobago, USA, Venezuela, Virgin Islands.



Trademark Acknowledgements

- The SD logo is a trademark. The SDHC logo is a trademark.
- Microsoft, Windows and Windows Vista are trademarks or registered trademarks of Microsoft Corporation in the United States and/or other countries.
- Macintosh and Mac OS are trademarks of Apple Inc., registered in the U.S. and other countries.
-  is a trademark of DVD Format/Logo Licensing Corporation.
- Manufactured under license from Dolby Laboratories.
"Dolby" and the double-D symbol are trademarks of Dolby Laboratories.
- Corel, the Corel logo, Ulead, the Ulead logo, Ulead DVD MovieFactory, InterVideo, the InterVideo logo, WinDVD are trademarks or registered trademarks of Corel Corporation and/or its subsidiaries.
- Other names and products not mentioned above may be trademarks or registered trademarks of their respective companies.
- ANY USE OF THIS PRODUCT OTHER THAN CONSUMER PERSONAL USE IN ANY MANNER THAT COMPLIES WITH THE MPEG-2 STANDARD FOR ENCODING VIDEO INFORMATION FOR PACKAGED MEDIA IS EXPRESSLY PROHIBITED WITHOUT A LICENSE UNDER APPLICABLE PATENTS IN THE MPEG-2 PATENT PORTFOLIO, WHICH LICENSE IS AVAILABLE FROM MPEG LA, L.L.C., 250 STEELE STREET, SUITE 300, DENVER, COLORADO 80206.



System Diagram (Availability differs from area to area)

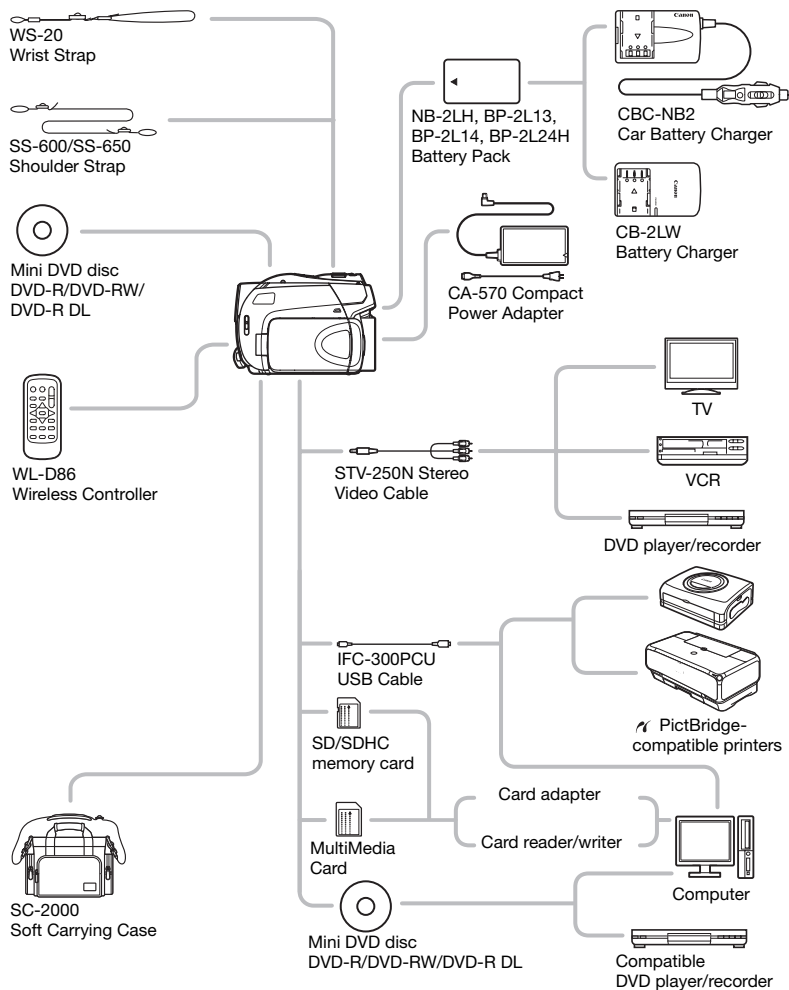

Optional Accessories

Call or visit your local retailer/dealer for genuine Canon video accessories. You can also obtain genuine accessories for your Canon camcorder by calling: 1-800-828-4040, Canon U.S.A. Information Center.

Use of genuine Canon accessories is recommended.

This product is designed to achieve excellent performance when used with genuine Canon accessories. Canon shall not be liable for any damage to this product and/or accidents such as fire, etc., caused by the malfunction of non-genuine Canon accessories (e.g., a leakage and/or explosion of a battery pack). Please note that this warranty does not apply to repairs arising out of the malfunction of non-genuine Canon accessories, although you may request such repairs on a chargeable basis.

Battery Packs

When you need extra battery packs, select one of the following models: NB-2LH, BP-2L13, BP-2L14 or BP-2L24H*.

* Attaching the BP-2L24H battery pack will make using the viewfinder more difficult.

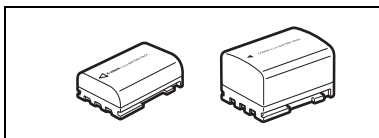

CB-2LW Battery Charger

Use the battery charger to charge the battery packs. It plugs directly into a power outlet without a cable.

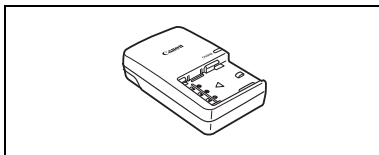

Charging Times

The charging times given in the following table are approximate and vary according to charging conditions and initial charge of the battery pack.

Battery pack →	NB-2LH	BP-2L13	BP-2L14	BP-2L24H
Charging conditions ↓				
Using the camcorder	135 min.	225 min.	240 min.	370 min.
Using the CB-2LW Battery Charger	105 min.	175 min.	195 min.	330 min.

Recording and Playback Times

The recording and playback times given in the following table are approximate and vary according to recording mode and charging, recording or playback conditions. The effective usage time of the battery pack may decrease when recording in cold surroundings, when using the brighter screen settings, etc.

Battery pack	NB-2LH		BP-2L13		BP-2L14		BP-2L24H	
Screen used	Viewfinder	LCD	Viewfinder	LCD	Viewfinder	LCD	Viewfinder	LCD
Maximum Recording Time								
XP	105 min.	100 min.	185 min.	180 min.	220 min.	215 min.	375 min.	365 min.
SP	125 min.	125 min.	225 min.	215 min.	265 min.	260 min.	440 min.	430 min.
LP	135 min.	130 min.	235 min.	230 min.	285 min.	275 min.	470 min.	455 min.
Typical Recording Time*								
XP	60 min.	60 min.	110 min.	110 min.	135 min.	130 min.	220 min.	215 min.
SP	65 min.	65 min.	115 min.	115 min.	140 min.	135 min.	230 min.	225 min.
LP	70 min.	65 min.	120 min.	115 min.	145 min.	140 min.	240 min.	235 min.
Playback Time								
XP	–	140 min.	–	245 min.	–	290 min.	–	495 min.
SP	–	170 min.	–	300 min.	–	355 min.	–	590 min.
LP	–	185 min.	–	320 min.	–	385 min.	–	635 min.

* Approximate times for recording with repeated operations such as start/stop, zooming, and power on/off.

CBC-NB2 Car Battery Charger

Use the car battery charger to charge battery packs while you are on the go. The car battery cable plugs into your car's cigarette lighter and runs off a 12-24 V DC negative ground battery.

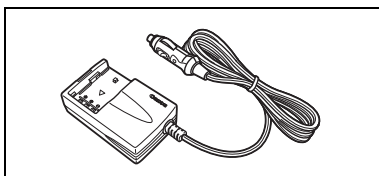

Shoulder Strap

You can attach a shoulder strap for more security and portability. Pass the ends through the strap mount and adjust the length of the strap.

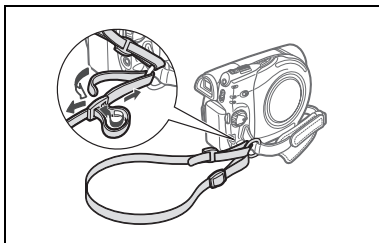

WS-20 Wrist Strap

Use this for extra additional protection for active shooting.

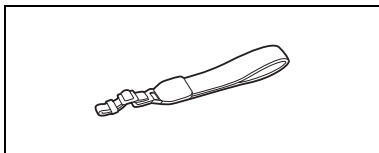



SC-2000 Soft Carrying Case

A handy camcorder bag with padded compartments and plenty of space for accessories.



This mark identifies genuine Canon video accessories. When you use Canon video equipment, we recommend Canon-brand accessories or products bearing the same mark.



Product Codes

Provided Accessories

CA-570 Compact Power Adapter	8468A002AA
NB-2LH Battery Pack	9612A001AA
WL-D86 Wireless Controller	D83-0722-000
STV-250N Stereo Video Cable	3067A001BA (D82-0590-001)
IFC-300PCU USB Cable	6906A001AA (D82-0590-001)

Optional Accessories

BP-2L13 Battery Pack	2069B002AA
BP-2L14 Battery Pack	9582A002AA
BP-2L24H Battery Pack	2383B002AA
CB-2LW Battery Charger	0763B001AA
CBC-NB2 Car Battery Charger	7873A002AA
WS-20 Wrist Strap	3118A002AA (D81-0190-202)
SC-2000 Soft Carrying Case	9389A001AA

Specifications

DC330

System

Disc Recording System	DVD-VIDEO (all disc types) DVD-VR (only with DVD-RW discs) Video Compression: MPEG-2 Audio Compression: Dolby Digital 2ch
Television System	EIA standard (525 lines, 60 fields) NTSC color signal
Compatible Media	8 cm (3 in.) mini DVD discs marked with the DVD-R, DVD-R DL or DVD-RW logo 
Maximum Recording Time	1.4 GB single sided 8 cm mini DVD disc: XP: 20 min., SP: 30 min., LP: 60 min. 2.6 GB single sided dual-layered 8 cm mini DVD disc: XP: 36 min., SP: 54 min., LP: 108 min. (All times given are approximate figures)
Image Sensor	1/6-inch CCD, approx. 1,070,000 pixels Effective pixels ¹ (all figures are approximate values) 16:9 Movies (advanced zoom) 410,000 (T) / 710,000 (W) pixels (other zoom types) 550,000 pixels 4:3 Movies (advanced zoom) 310,000 (T) / 690,000 (W) pixels (other zoom types) 690,000 pixels 16:9 Still images 600,000 pixels 4:3 Still images 800,000 pixels
LCD Screen	2.7 in., wide, TFT color, approx. 112,000 pixels
Viewfinder	0.35 in., wide, TFT color, approx. 114,000 pixels
Microphone	Stereo electret condenser microphone
Lens	f=2.6-96.2 mm, F/2.0-5.2, 37x power zoom 35 mm equivalent (all figures are approximate values) 16:9 Movies (advanced zoom) 41.7-2,002 mm (other zoom types) 47.1-1,743 mm 4:3 Movies (advanced zoom) 44.6-2,453 mm (other zoom types) 44.6-1,650 mm 16:9 Still images 45.2-1,672 mm 4:3 Still images 41.5-1,536 mm
Lens Configuration	10 elements in 8 groups (1 double-sided, aspheric element)
AF System	TTL autofocus, manual focus available
Minimum Focusing Distance	1 m (3.3 ft.); 1 cm (0.39 in.) on maximum wide angle
White Balance	Auto white balance, preset white balance (DAYLIGHT, TUNGSTEN) or custom white balance
Minimum Illumination	2 lx ([NIGHT] recording program, Shutter speed at 1/8) 7.5 lx ([EASY] mode, Auto slow shutter [ON], Shutter speed at 1/30)



Recommended Illumination More than 100 lx

Image Stabilization Electronic

¹ When two values are given, the first indicates the value at full telephoto (T) and the second indicates the value at full wide-angle (W).

Memory Card

Recording Media SDHC (SD High Capacity) memory card, SD memory card, MultiMedia Card (MMC)*

Size of Still Images 1,152 x 648 / 1,152 x 864 / 640 x 480 pixels

File Format Design rule for Camera File system (DCF), Exif 2.2 compliant**, DPOF compliant

Image Compression Method JPEG (compression: Super Fine, Fine, Normal)

* This camcorder has been tested with SD/SDHC cards up to 8 GB. Performance cannot be guaranteed for all memory cards.

** This camcorder supports Exif 2.2 (also called "Exif Print"). Exif Print is a standard for enhancing the communication between camcorders and printers. By connecting to an Exif Print-compliant printer, the camcorder's image data at the time of shooting is used and optimized, yielding extremely high quality prints.

Terminals

AV Terminal \varnothing 3.5 mm minijack, output only
Video: 1 V_{p-p}/75 ohms unbalanced
Audio: -10 dBV (47 kohms load/3 kohms or less)

USB Terminal mini-B

Power/Others

Power supply (rated) 7.4 V DC (battery pack), 8.4 V DC (compact power adapter)

Power consumption (SP mode) 2.3 W (viewfinder), 2.4 W (LCD screen, normal brightness)

Operating temperature 0 – 40 °C (32 – 104 °F)

Dimensions (W x H x D) 66 x 90 x 126 mm (2.6 x 3.5 x 5.0 in.) excluding the grip belt

Weight (camcorder body only) 380 g (13.4 oz.)

CA-570 Compact Power Adapter

Power supply 100 – 240 V AC, 50/60 Hz

Rated output / consumption 8.4 V DC, 1.5 A / 29 VA (100 V) – 39 VA (240 V)

Operating temperature 0 – 40 °C (32 – 104 °F)

Dimensions 52 x 29 x 90 mm (2.1 x 1.1 x 3.5 in.)

Weight 135 g (4.8 oz.)

NB-2LH Battery Pack

Battery type	Rechargeable Lithium Ion Battery
Rated voltage	7.4 V DC
Operating temperature	0 – 40 °C (32 – 104 °F)
Battery capacity	720 mAh
Dimensions	33.3 x 16.2 x 45.2 mm (1.3 x 0.64 x 1.8 in.)
Weight	43 g (1.5 oz.)

Weight and dimensions are approximate. Errors and omissions excepted. Subject to change without notice.



Index

A

- Abroad, using the camcorder90
- AEB - Auto exposure bracketing57
- Aspect ratio
 - of a connected TV (TV Type)77
 - of movies (Widescreen)74
- Auto slow shutter74
- Autofocus (AF): AF frame
 - (9-point AiAF/Center point)58
- AV terminal66

B

- Battery pack
 - Charging19
 - Remaining charge indicator18
- Beach (recording program)39
- Beep77
- Built-in backup battery89

C

- Compact power adapter19
- Condensation90
- Connections
 - to a computer68
 - to a TV/VCR66
- Continuous shooting57

D

- Data code37
- Date and time25
 - Date format78
 - Daylight saving time26
 - Time zone26
- Digital effects45
- Direct print61
- Direct transfer68
- Disc title48
- Disc types
 - (DVD-R, DVD-R DL, DVD-RW)5
- Discs that have been tested6
- Drive mode57

E

- EASY (recording program)31
- Erasing still images56
- Error messages82
- Exposure43

F

- File numbers77
- Finalizing the disc49
- Fireworks (recording program)39
- Focus priority58
- FUNC. menu23, 72

G

- Grip belt21

I

- Image effects44
- Image jump54
- Image stabilizer74
- Index screen
 - Movies35
 - Still images55
- Initialization
 - Disc48
 - Memory card60

J

- Joystick22
- Joystick guide22

L

- Language25
- LCD screen26
- LCD video light41
- LP mode32

M

- Magnifying a still image56
- Maintenance89
- Manual exposure adjustment43
- Manual focus42
- Markers76
- Memory card29, 88

Mode switch 30

N

Night (recording program) 39

O

Onscreen display selection 37

Original recordings 46

P

P (recording program) 40

Playback

 Movies 35

 Still images 54

Playlist 46

Portrait (recording program) 39

Power save 77

Print order 64

Printing still images 61

Protecting still images 59

Q

Quick Start function 34

R

Recording

 Movies 30

 Still images 52

Recording mode 32

Recording programs 40

Recording reminder 18

Remote sensor 20

RESET 79

Reviewing

 Movies (Record review) 34

 Still images (Review) 74

S

Scene editing 46

Screen icons 16

SD/SDHC card 29

Self timer 41

Serial number 13

Setup menus 24, 74

Shutter speed 40

Slideshow 55

Snow (recording program) 39

SP mode 32

Special scene (recording programs) ... 38

Sports (recording program) 39

Spotlight (recording program) 39

Still image quality 53

Still image size 53

Sunset (recording program) 39

T

Telephoto 33

Transfer order 70

Transferring to a computer

 Movies 68

 Still images 68

Tripod 21

Troubleshooting 79

Tv (recording program) 40

U

USB terminal 68

V

VIDEO mode (disc specification) 5

Viewfinder 31

Volume 36

VR mode (disc specification) 5

W

White balance 43

Wide angle 33

Widescreen 16:9 74, 75

Wind screen 75

Wireless controller 20

X

XP mode 32

Z

Zoom

 Advanced zoom 32

 Zoom speed 33

 Zoom type 32

U.S.A.

CANON CONSUMER DIGITAL VIDEO EQUIPMENT LIMITED WARRANTY FOR THE UNITED STATES

The limited warranty set forth below is given by Canon U.S.A., Inc. ("Canon USA") with respect to Canon Consumer Digital Video Equipment (the "Equipment") purchased in the United States. This limited warranty is only effective upon presentation of your Bill of Sale or other proof of purchase.

The Equipment is warranted under normal, non-commercial, personal use, against defective materials or workmanship as follows:

Parts: Defective parts will be exchanged for new parts or comparable rebuilt parts for a period of ONE YEAR from the date of original purchase, except for a defective Video Head, which will be exchanged for a period of three months from the date of purchase.

Labor: For a period of ONE YEAR from the date of original purchase, labor will be provided free of charge by our factory service centers or designated service facilities located in the United States.

When returning Equipment under this warranty, you must pre-pay the shipping charges, and you must enclose the Bill of Sale or other proof of purchase with a complete explanation of the problem. During the ONE-YEAR warranty period, repairs will be made and the Equipment will be return-shipped to you free of charge. For repairs after the warranty period is over, you will be given an estimate of the cost of repair and an opportunity to approve or disapprove of the repair expense before it is incurred. If you approve, repairs will be made and the Equipment will be return-shipped to you. (shipping charges apply). If you disapprove, we will return-ship the equipment at no charge to you.

Non-Canon brand peripheral equipment and software which may be distributed with, or factory loaded on, the Equipment, are sold "AS IS" without warranty of any kind by Canon USA, including any implied warranty regarding merchantability or fitness for a particular purpose. The sole warranty with respect to such non-Canon brand items is given by the manufacturer or producer thereof. If the Equipment contains a hard disk drive, Canon USA recommends that data stored on that drive be duplicated or backed up to prevent its loss in the event of failure or other malfunction of such drive.

Canon USA shall have no responsibility under this limited warranty for use of the Equipment in conjunction with incompatible peripheral equipment and incompatible software.

In order to obtain warranty service, contact the authorized Canon retail dealer from whom you purchased the Equipment or call the CANON INFORMATION CENTER AT 1-800-OK-CANON). You will be directed to the nearest service facility for your Equipment.

This Limited Warranty covers all defects encountered in normal use of the Equipment and does not apply in the following cases:

- A) Loss or damage to the Equipment due to abuse, mishandling, accident, improper maintenance, or failure to follow operating instructions;
- B) If the Equipment is defective as a result of leaking batteries, sand, dirt or water damage;
- C) If defects or damages are caused by the use of unauthorized parts or by service other than by Canon USA's factory service centers or authorized service facilities;
- D) If the Equipment is used for commercial or industrial use.

This Limited Warranty does not cover cabinet (exterior finish), video cassette tape, head cleanings, nor does it apply to Equipment purchased outside the United States. This warranty does not cover units sold to rental firms, military operations, hotels, schools, hospitals or for other commercial, industrial, or institutional applications. These uses are covered only by such specific warranty as Canon may issue with such sales.

This Limited Warranty does not apply to accessories or consumables for the Equipment, which are sold "AS IS", without warranty of any kind by Canon USA.

Please retain this warranty card and your Bill of Sale as a permanent record of your purchase. This card is most important in order to be sure you are contacted right away should there be a safety inspection, modification or product recall under applicable laws or regulations.

NO IMPLIED WARRANTY, INCLUDING MERCHANTABILITY AND FITNESS FOR A PARTICULAR PURPOSE APPLIES TO THIS EQUIPMENT AFTER THE APPLICABLE PERIOD OF EXPRESS WARRANTY OR GUARANTY, EXCEPT AS MENTIONED ABOVE, GIVEN BY ANY PERSON, FIRM OR CORPORATION WITH RESPECT TO THIS EQUIPMENT SHALL BIND THE UNDERSIGNED (SOME STATES DO NOT ALLOW LIMITATIONS ON HOW LONG AN IMPLIED WARRANTY LASTS, SO THE ABOVE LIMITATION OR EXCLUSION MAY NOT APPLY TO YOU). CANON USA SHALL NOT BE LIABLE FOR LOSS OF REVENUES OR PROFITS, EXPENSE FOR SUBSTITUTE EQUIPMENT OR SERVICE, STORAGE CHARGES, LOSS OR CORRUPTION OF DATA, INCLUDING WITHOUT LIMITATION, LOSS OR CORRUPTION OF DATA STORED ON THE EQUIPMENT'S HARD DRIVE, OR ANY OTHER SPECIAL, INCIDENTAL OR CONSEQUENTIAL DAMAGES CAUSED BY THE USE, MISUSE OR INABILITY TO USE THE EQUIPMENT, REGARDLESS OF THE LEGAL THEORY ON WHICH THE CLAIM IS BASED, AND EVEN IF CANON USA HAS BEEN ADVISED OF THE POSSIBILITY OF SUCH DAMAGES. NOR SHALL RECOVERY OF ANY KIND AGAINST CANON USA BE GREATER THAN THE PURCHASE PRICE OF THE EQUIPMENT SOLD BY CANON USA AND CAUSING THE ALLEGED DAMAGE. WITHOUT LIMITING THE FOREGOING, YOU ASSUME ALL RISK AND LIABILITY FOR LOSS, DAMAGE OR INJURY TO YOU AND YOUR PROPERTY AND TO OTHERS AND THEIR PROPERTY ARISING OUT OF USE, MISUSE OR INABILITY TO USE THE EQUIPMENT NOT CAUSED DIRECTLY BY THE NEGLIGENCE OF CANON USA. (SOME STATES DO NOT ALLOW THE EXCLUSION OR LIMITATION OF INCIDENTAL OR CONSEQUENTIAL DAMAGES, SO THE ABOVE LIMITATION MAY NOT APPLY TO YOU). THIS WARRANTY SHALL NOT EXTEND TO ANYONE OTHER THAN THE ORIGINAL PURCHASER OF THIS EQUIPMENT OR THE PERSON FOR WHOM IT WAS PURCHASED AS A GIFT.

This warranty gives you specific legal rights, and you may also have other rights which vary from state to state.

CANON U.S.A., INC.

CANON CONSUMER DIGITAL VIDEO EQUIPMENT LIMITED WARRANTY

The limited warranty set forth below is given by Canon Canada Inc. ("Canon Canada") with respect to Canon Consumer Digital Video Equipment (the "Equipment") purchased in Canada. This limited warranty is only effective upon presentation of a bill of sale or other proof of purchase for this Equipment to a Canon Service Facility when repairs are required.

The Equipment is warranted under normal, non-commercial, personal use, against defective materials or workmanship as follows:

Parts: Defective parts will be exchanged for new parts or, at Canon Canada's option, comparable rebuilt parts for a period of one year from the date of original purchase, except Video Heads which will be exchanged for a period of 3 months from the date of purchase.

Labour: For a period of one year from the date of original purchase, labour will be provided free of charge by our Canon Service Facilities in Canada.

This limited warranty covers all defects except where:

(a) The loss or damage to the product results from:

- i) accident, natural disaster, mishandling, abuse, neglect, unauthorized product modification or failure to follow instructions contained in the instruction manual;
- ii) the use of accessories, attachments, products, supplies, parts or devices with the Equipment that do not conform to Canon specifications or that cause abnormally frequent service problems;
- iii) repairs or services performed by any party other than a Canon Service Facility;
- iv) defective batteries or any exposure to water, sand or dirt;
- v) shipping (claim must be presented to the shipper);

(b) Any serial number on the video Equipment is altered or removed.

(c) The Equipment is used for commercial, professional or industrial purposes.

This limited warranty does not cover the cabinet (exterior finish) of the Equipment, media, nor does it apply to Equipment purchased outside Canada. If the Equipment contains a hard disk drive, Canon Canada recommends that data stored on that drive be duplicated or backed up to prevent its loss in the event of a failure or other malfunction of such drive.

TO OBTAIN WARRANTY SERVICE

Ship your Equipment in its original carton, box or equivalent, properly packed, fully insured with shipping charges prepaid, together with a copy of your bill of sale or other proof of purchase and a description of the problem to any of the Canon Service Facilities in Canada.

LIMITATIONS

Except as otherwise required by applicable legislation, this warranty is in lieu of all other warranties, conditions, guarantees or representations, express or implied, statutory or otherwise, relative to the Equipment, including implied warranties or conditions of merchantability or fitness for a particular purpose.

Canon Canada assumes no liability for special, consequential or incidental damages, loss or corruption of data including, without limitation, data stored on the hard disk drive of the Equipment or loss that may arise, whether on account of negligence or otherwise, from the use, misuse or inability to use the Equipment (including loss of profit, revenue, media or enjoyment) or from failure to conform to any express or implied warranties, conditions, guarantees or representations. Any recovery under this limited warranty shall not exceed the purchase price of the equipment. Canon Canada does not assume or authorize any other person to assume for Canon Canada any other liability with respect to this equipment.

This warranty does not extend to any person other than the original purchaser of the Equipment or the person for whom it was purchased as a gift and states your exclusive remedy.

NOTICE TO CONSUMER

If you plan to take important videos or if the product has not been used for some time, please check all functions with the instruction book before using it.

Canon



DIM-855

U.S.A. **CANON U.S.A., INC. NEW JERSEY OFFICE**
100 Jamesburg Road, Jamesburg, NJ 08831 USA
CANON U.S.A., INC. CHICAGO OFFICE
100 Park Blvd., Itasca, IL 60143 USA
CANON U.S.A., INC. LOS ANGELES OFFICE
15955 Alton Parkway, Irvine, CA 92618 USA
CANON U.S.A., INC. HONOLULU OFFICE
210 Ward Avenue, Suite 200, Honolulu, HI 96814 USA

- ❖ If you have any questions, call the Canon U.S.A. Information Center toll-free at 1-800-828-4040 (U.S.A. only).

CANADA **CANON CANADA INC. NATIONAL HEADQUARTERS**
6390 Dixie Road, Mississauga, Ontario L5T 1P7
CANON CANADA INC. CALGARY
2828, 16th Street, N.E. Calgary, Alberta T2E 7K7
CANON CANADA INC. MONTREAL
5990 Côte de Liesse, Quebec H4T 1V7

- ❖ If you have any questions, call the Canon Canada Information Center toll-free at 1-800-828-4040 (CANADA only).
- ❖ Si vous avez des questions, veuillez téléphoner sans frais au Canada 1-800-828-4040 (CANADA seulement).

MEXICO **CANON MEXICANA, S. DE R.L. DE C.V.**
Periférico Sur No. 4124, Col. Ex-Rancho de Anzaldo,
C.P. 01900 México, D.F., México
CANON U.S.A., INC. NEW JERSEY OFFICE
100 Jamesburg Road, Jamesburg, NJ 08831 USA

CENTRO Y SURAMÉRICA **CANON LATIN AMERICA, INC.**
703 Waterford Way, Suite 400, Miami, FL 33126 USA

ASIA **CANON HONGKONG COMPANY LTD.**
19/F, The Metropolis Tower, 10 Metropolis Drive,
Hunghom, Kowloon, Hong Kong

The information in this manual is verified as of February 2008.
Les informations contenues dans ce manuel ont été vérifiées février 2008.
La información de este manual fué verificada febrero de 2008.