

HD Camcorder

# EOS C100

Instruction Manual



# Important Usage Instructions

2

## **WARNING**

TO REDUCE THE RISK OF FIRE OR ELECTRIC SHOCK, DO NOT EXPOSE THIS PRODUCT TO RAIN OR MOISTURE.

TO REDUCE THE RISK OF ELECTRIC SHOCK, DO NOT EXPOSE THIS PRODUCT TO DRIPPING OR SPLASHING.

## **WARNING**

TO REDUCE THE RISK OF ELECTRIC SHOCK AND TO REDUCE ANNOYING INTERFERENCE, USE THE RECOMMENDED ACCESSORIES ONLY.

## **COPYRIGHT WARNING:**

Unauthorized recording of copyrighted materials may infringe on the rights of copyright owners and be contrary to copyright laws.

## **FCC NOTICE**

HD Camcorder, EOS C100 Systems.

This device complies with Part 15 of the FCC Rules. Operation is subject to the following two conditions: (1) This device may not cause harmful interference, and (2) this device must accept any interference received, including interference that may cause undesired operation.

Note: This equipment has been tested and found to comply with the limits for class B digital device, pursuant to Part 15 of the FCC Rules. These limits are designed to provide reasonable protection against harmful interference in a residential installation. This equipment generates, uses and can radiate radio frequency energy and, if not installed and used in accordance with the instructions, may cause harmful interference to radio communications. However, there is no guarantee that interference will not occur in a particular installation. If this equipment does cause harmful interference to radio or television reception, which can be determined by turning the equipment off and on, the user is encouraged to try to correct the

interference by one or more of the following measures:

- Reorient or relocate the receiving antenna.
- Increase the separation between the equipment and receiver.
- Connect the equipment into an outlet on a circuit different from that to which the receiver is connected.
- Consult the dealer or an experienced radio/TV technician for help.

Use of shielded cable is required to comply with class B limits in Subpart B of Part 15 of FCC Rules.

Do not make any changes or modifications to the equipment unless otherwise specified in the manual.

If such changes or modifications should be made, you could be required to stop operation of the equipment.

Canon U.S.A., Inc.

One Canon Park, Melville, NY 11747, USA  
Tel No. 1-800-OK-CANON (1-800-652-2666)

The Mains plug is used as the disconnect device. The Mains plug shall remain readily operable to disconnect the plug in case of an accident.

## **CAUTION:**

- Danger of explosion if the wrong type of batteries are attached. Use only the same type of batteries.
- Do not expose batteries or product to excessive heat such as the inside of a car under direct sunlight, fire, etc.

EOS C100 / CA-930 identification plate is located on the bottom.



**CAUTION**  
RISK OF ELECTRIC SHOCK  
DO NOT OPEN



**CAUTION:**  
TO REDUCE THE RISK OF ELECTRIC SHOCK, DO NOT REMOVE COVER (OR BACK). NO USER-SERVICEABLE PARTS INSIDE. REFER SERVICING TO QUALIFIED SERVICE PERSONNEL.



The lightning flash with arrowhead symbol, within an equilateral triangle, is intended to alert the user to the presence of uninsulated “dangerous voltage” within the product’s enclosure, that may be of sufficient magnitude to constitute a risk of electric shock to persons.



The exclamation point, within an equilateral triangle, is intended to alert the user to the presence of important operating and maintenance (servicing) instructions in the literature accompanying the product.

**Only for European Union and EEA (Norway, Iceland and Liechtenstein)**



These symbols indicate that this product is not to be disposed of with your household waste, according to the WEEE Directive (2012/19/EU), the Battery Directive (2006/66/EC) and/or national legislation implementing those Directives.



If a chemical symbol is printed beneath the symbol shown above, in accordance with the Battery Directive, this indicates that a heavy metal (Hg = Mercury, Cd = Cadmium, Pb = Lead) is present in this battery or accumulator at a concentration above an applicable threshold specified in the Battery Directive.

This product should be handed over to a designated collection point, e.g., on an authorized one-for-one basis when you buy a new similar product or to an authorized collection site for recycling waste electrical and electronic equipment (EEE) and batteries and accumulators. Improper handling of this type of waste could have a possible impact on the environment and human health due to potentially hazardous substances that are generally associated with EEE. Your cooperation in the correct disposal of this product will contribute to the effective usage of natural resources.

For more information about the recycling of this product, please contact your local city office, waste authority, approved scheme or your household waste disposal service or visit [www.canon-europe.com/weee](http://www.canon-europe.com/weee), or [www.canon-europe.com/battery](http://www.canon-europe.com/battery).

# Important Safety Instructions

4

In these safety instructions the word “apparatus” refers to the Canon HD Camcorder EOS C100 and all its accessories.

1. Read these instructions.
2. Keep these instructions.
3. Heed all warnings.
4. Follow all instructions.
5. Do not use this apparatus near water.
6. Clean only with dry cloth.
7. Do not block any ventilation openings. Install in accordance with the manufacturer’s instructions.
8. Do not install near any heat sources such as radiators, heat registers, stoves, or other apparatus (including amplifiers) that produce heat.
9. Do not defeat the safety purpose of the polarized or grounding-type plug. A polarized plug has two blades with one wider than the other.

A grounding type plug has two blades and a third grounding prong. The wide blade or the third prong are provided for your safety. If the provided plug does not fit into your outlet, consult an electrician for replacement of the obsolete outlet.

10. Protect the power cord from being walked on or pinched particularly at plugs, convenience receptacles, and the point where they exit from the apparatus.
11. Only use attachments/accessories specified by the manufacturer.
12. Unplug this apparatus during lightning storms or when unused for long periods of time.
13. Refer all servicing to qualified service personnel. Servicing is required when the apparatus has been damaged in any way, such as power-supply cord or plug is damaged, liquid has been spilled or objects have fallen into the apparatus, the apparatus has been exposed to rain or moisture, does not operate normally, or has been dropped.

CAN ICES-3(B)/NMB-3(B)

## Trademark Acknowledgements

- SD, SDHC and SDXC Logos are trademarks of SD-3C, LLC.
- Microsoft and Windows are trademarks or registered trademarks of Microsoft Corporation in the United States and/or other countries.
- Apple, Mac OS are trademarks of Apple Inc., registered in the U.S. and other countries.
- HDMI, the HDMI logo and High-Definition Multimedia Interface are trademarks or registered trademarks of HDMI Licensing LLC in the United States and other countries.
- “AVCHD” and the “AVCHD” logo are trademarks of Panasonic Corporation and Sony Corporation.
- Manufactured under license from Dolby Laboratories. “Dolby” and the double-D symbol are trademarks of Dolby Laboratories.
- Other names and products not mentioned above may be trademarks or registered trademarks of their respective companies.
- This device incorporates exFAT technology licensed from Microsoft.
- ANY USE OF THIS PRODUCT OTHER THAN CONSUMER PERSONAL USE IN ANY MANNER THAT COMPLIES WITH THE MPEG-2 STANDARD FOR ENCODING VIDEO INFORMATION FOR PACKAGED MEDIA IS EXPRESSLY PROHIBITED WITHOUT A LICENSE UNDER APPLICABLE PATENTS IN THE MPEG-2 PATENT PORTFOLIO, WHICH LICENSE IS AVAILABLE FROM MPEG LA, L.L.C., 250 STEELE STREET, SUITE 300, DENVER, COLORADO 80206.
- This product is licensed under AT&T patents for the MPEG-4 standard and may be used for encoding MPEG-4 compliant video and/or decoding MPEG-4 compliant video that was encoded only (1) for a personal and non-commercial purpose or (2) by a video provider licensed under the AT&T patents to provide MPEG-4 compliant video. No license is granted or implied for any other use for MPEG-4 standard.



## Highlights of the EOS C100

The Canon HD Camcorder EOS C100 is a versatile camcorder that combines the power of our latest CMOS sensor and interchangeable lenses with the convenience of a compact size. The following are just some of the many features that will help turn your creative vision into reality.

### HD Recording

#### Large Super 35mm CMOS sensor and DIGIC DV III image processor

The camcorder is equipped with a large Super 35mm CMOS sensor that captures video at an effective pixel count of 8.29 megapixels (3840x2160). Combined with the DIGIC DV III image processor, the camcorder offers a center resolution of 1,000 TV lines\*. Furthermore, thanks to its fast scanning speed, the camcorder produces spectacular video with true-to-life color reproduction while reducing noise and “rolling shutter” artifacts.

\* Varies depending on the lens used.

#### Interchangeable lenses

Enjoy the freedom and creative versatility of using interchangeable lenses to achieve exactly the look you want. The camcorder features an EF lens mount allowing you to use a huge variety of high-quality Canon EF lenses, including the new high-end Canon Cinema lenses, as well as other lenses.

#### Superb HD video

The camcorder offers you a whole array of options when it comes to the video configuration of your recordings. By controlling the system frequency (50.00 Hz recordings or 59.94 Hz recordings), bit rate, resolution and frame rate of your recordings you can select a video configuration to suit your needs from a total of 24 different combinations.

### Operability and Adaptability

#### Freely customizable compact design

At its most compact configuration, the camcorder offers convenient and hassle-free hand-held operation. Modular components let you expand your options. The handle unit, for example, adds advanced audio capabilities allowing for simple one-person operation (📖 29).

#### Recording media

The camcorder supports all the latest types of Secure Digital (SD) cards. You can even make lengthy recordings without worry because the camcorder features two SD card slots. When one SD card becomes full, the recording will automatically continue on the other one when you use relay recording (📖 41).

In addition, using double slot recording (📖 41) lets you record the same clip simultaneously to both SD cards.

#### Enhanced automatic functions

The camera features a variety of automatic functions to support a simple one-person operation. These include automatic aperture and push auto iris (📖 60) for automatic aperture adjustment as long as you press and hold the button, automatic white balance (📖 64) to let the camcorder continuously adjust the optimal white balance setting, and continuous AF or One-shot AF (📖 65) to let the camcorder focus automatically one time.

### Versatile Artistic Expression

#### Custom picture settings

With custom picture settings (📖 92), you can enjoy unparalleled image control to deliver the look you want by adjusting parameters, such as gamma and color matrix. The camcorder also features a new, easy interface that lets you adjust the gamma curve and white balance using an intuitive graph. The custom picture settings can be saved onto an SD card, which allows multiple C100 camcorders to use the same settings.

#### Canon Log gamma (📖 49) for cinematic recordings

You can easily apply the [CINEMA Locked] preset settings, especially designed with professional cinematography in mind. The Canon Log gamma makes the most of the newly-developed image sensor to achieve amazing dynamic range, allowing you to realize in post-production the artistic vision you desire.

## Advanced Professional Features

### Customization

The camcorder features several customization options. You can assign often-used functions to assignable buttons (📖 89) so that you can call up those functions with the press of a single button. You can also register frequently-used menu settings in an easy-to-access personal menu (My Menu, 📖 28). Custom functions (📖 102) and custom onscreen displays (📖 102) give you even more freedom to control many aspects of the camcorder's operation. Save custom picture and menu settings to an SD card (📖 103) so that you can transfer your setting preferences to other C100 camcorders in order to use them in the same way.

### Time code/User bit output

The internal camcorder-generated time code can be output from the HDMI OUT terminal for easy logging and referencing (📖 140). Additionally, the camcorder can output also the user bit (📖 73).

## Other Functions

### Audio

When recording at the highest bit rate, you have the option to record sound as 2-channel linear PCM audio (16-bit/48 kHz). You can use the built-in microphone, Ø 3.5 mm MIC terminal or the two XLR audio input terminals (with phantom power supply) when recording.

### LCD screen and viewfinder

The LCD screen and viewfinder both have 100% frame coverage, which will ensure that you can accurately check that your shots are framed how you want them.

### Video scopes

Check the brightness of the image using the waveform monitor (📖 81) or the focus using the edge monitor (📖 82).

### Added and improved functionality

Other functions include the ability to down-convert your recordings to standard definition (MPEG-2) in the camcorder itself (📖 113), and the Intelligent System-compatible battery pack (📖 160).

# Table of Contents

## 1. Introduction 11

- About this Manual 11
  - Conventions Used in this Manual 11
- Supplied Accessories 13
- Names of Parts 14
  - Grip Unit 19
  - Handle Unit 20

## 2. Preparations 21

- Preparing the Power Supply 21
  - Using a Battery Pack 21
  - Using a Household Power Outlet 24
  - Turning the Camcorder On and Off 24
- Date, Time and Language Settings 25
  - Setting the Date and Time 25
  - Changing the Time Zone 25
  - Displaying the Date and Time while Recording 26
  - Changing the Language 26
- Using the Menus 27
  - Selecting an Option from the Menu 27
  - Using the Customized Submenu (My Menu) 28
- Preparing the Camcorder 29
  - Preparing the Lens 29
  - Attaching and Removing the Handle Unit 32
  - Using the Viewfinder 33
  - Using the LCD Panel 33
  - Adjusting the Viewfinder/LCD Screen 33
  - Using a Tripod 34
  - Removing and Attaching the Grip Unit 34
  - Attaching a Shoulder Strap 36
  - Removing and Attaching the Terminal Covers 36
  - The Camcorder's Cooling System 37
- Using an SD Card 38
  - SD Cards Compatible for Use with the Camcorder 38
  - Inserting and Removing an SD Card 39
  - Checking the Status of the SD Card Slots 39
  - Initializing an SD Card 40
  - Switching Between the SD Card Slots 41
  - Selecting the SD Card Recording Method 41
  - Checking the Remaining Recording Time on the SD Card 42
  - Recovering Data on an SD Card 42
- Adjusting the Black Balance 43

## 3. Recording 45

- Recording Video 45
  - Preparing to Record 45
  - Recording 45
  - Onscreen Displays 48
  - Canon Log Gamma and CINEMA Preset 49
- Video Configuration: System Frequency, Bit Rate and Frame Rate 51
- Changing Main Camera Functions with the Joystick 53
- Shutter Speed 54
  - Changing the Shutter Mode 55
  - Adjusting the Shutter Value 55
  - Flicker Reduction 56
- ISO Speed/Gain 57
  - Changing the ISO Speed or Gain Settings 57
  - Adjusting the ISO/Gain Value 58
- ND Filter 59
- Adjusting the Aperture 60
  - Automatic Aperture 60
  - Manual Aperture Control 60
  - Momentary Automatic Aperture - Push Auto Iris 61
  - Exposure Compensation - AE Shift 61
  - Light Metering Mode 62
- White Balance 63
  - Custom White Balance 63
  - Preset White Balance Settings 64
  - Color Temperature Setting 64
  - Auto White Balance 64
- Adjusting the Focus 65
  - Manual Focus 65
  - One-Shot AF 65
  - Continuous AF 66
  - Using the Focus Assistance Functions 67
- Onscreen Markers and Zebra Patterns 68
  - Displaying Onscreen Markers 68
  - Displaying Zebra Patterns 69
- Setting the Time Code 70
  - Selecting the Running Mode 70
  - Selecting Drop or Non-Drop Frame 71
  - Putting the Time Code Display on Hold 71
- Setting the User Bit 73

**Recording Audio 74**

- Connecting an External Microphone or External Audio Input Source to the Camcorder 74
  - Using the Built-in Microphone or an External Microphone Connected to the MIC Terminal 74
  - Adjusting the Audio Level for the MIC Terminal 75
  - Using Audio Input from the XLR Terminals 77
  - Adjusting the Audio Level for the XLR Terminals 78
  - Monitoring the Audio with Headphones 79
- Color Bars/Audio Reference Signal 80**
- Recording Color Bars 80
  - Recording an Audio Reference Signal 80

**Video Scopes 81**

- Displaying a Video Scope 81
- Configuring the Waveform Monitor 81
- Configuring the Edge Monitor 82

**Reviewing a Recording 83****Pre-recording Mode 84****Continuous Recording 85****Using the RC-V100 Remote Controller 87****4. Customization 89****Assignable Buttons 89**

- Changing the Assigned Function 89
- Using an Assignable Button 90

**Custom Picture Settings 92**

- Selecting Custom Picture Files 92
- Editing a Custom Picture File's Settings 93
- Resetting the current file's settings to default values 93
- Renaming Custom Picture Files 93
- Protecting Custom Picture Files 94
- Transferring Custom Picture Files 94
- Available Custom Picture Settings 95
- Simplified Graphical Interface 101

**Customizing Functions and Onscreen Displays 102**

- Customizing Functions 102
- Customizing Onscreen Displays 102

**Saving and Loading Camera Settings 103**

- Saving Camera Settings to an SD Card 103
- Loading Camera Settings from an SD Card 103

**5. Playback 105****Playback 105**

- Clip Index Screen 105
- Playing Back Clips 107
- Onscreen Displays 108
- Playback Controls 109
- Adjusting the Volume 109

**Clip Operations 111**

- Using the Clip Menu 111
- Copying Clips 111
- Deleting Clips and Shots 112
- Converting Clips to Standard Definition 113
- Deleting SD Movies 115

**6. External Connections 117****Video Output Configuration 117****Connecting to an External Monitor 118**

- Connection Diagram 118
- Using the HDMI OUT Terminal 118
- Using the AV OUT Terminal 119
- SD Output 119
- Superimposing Onscreen Displays to Appear on an External Monitor 120

**Audio Output 121**

- Synchronizing the Video with the Audio being Monitored 121
- Selecting the Audio Channel 121
- Selecting the Output Level of the AV OUT Terminal 122

**Saving Clips to a Computer 123**

- Connection Diagram 123

**7. Photos 125****Taking Photos 125**

- Taking Photos in CAMERA Mode 125
- Capturing Photos in MEDIA Mode 125

**Photo Playback 127**

- Displaying the [Photos] Index Screen 127
- Viewing Photos 127

**Photo Operations 128**

- Using the Photo Menu 128
- Copying Photos 128
- Deleting Photos 129
- Copying Custom Picture Files 131



**8. Additional Information 133**

Menu Options 133

Displaying the Status Screens 141

Resetting the File Numbering 147

Troubleshooting 148

    List of Messages 151

Handling Precautions 155

Maintenance/Others 158

Optional Accessories 159

Specifications 162

Index 165



## About this Manual



Thank you for purchasing the Canon EOS C100. Please read this manual carefully before you use the camcorder and retain it for future reference. Should the camcorder fail to operate correctly, refer to *Troubleshooting* (📖 148).

### Conventions Used in this Manual

- **!** IMPORTANT: Precautions related to the camcorder's operation.
- **i** NOTES: Additional topics that complement the basic operating procedures.
- **📖**: Reference page number.
- The following terms are used in this manual.
  - “Screen” refers to the LCD screen and the viewfinder screen.
  - “SD card” refers to an SD, SDHC or SDXC card.
- Photographs in the manual are simulated pictures taken with a still camera. Some screenshots have been altered to make them easier to read.
- Illustrations in the manual show the Canon EOS C100 camcorder with a Canon EF 24-70mm f/2.8 L II USM lens attached.



The  arrow is used to abbreviate menu selections. For a detailed explanation on how to use the menus, refer to *Using the Menus* (📖 27). For a concise summary of all available menu options and settings, refer to the appendix *Menu Options* (📖 133).

### Operating modes

 indicates that a function is available in the operating mode indicated and  indicates that the function is not available. For a detailed explanation, refer to *Turning the Camcorder On and Off* (📖 24).

### Setting the Time Code



The camcorder generates a time code signal and embeds it in your recordings. You can output the time code along with video output from the HDMI OUT terminal (🔌 134). For 59.94 Hz recordings, you can also select between a drop frame and non-drop frame time code.

Operating modes:  



#### Selecting the Running Mode

You can select the running mode of the camcorder's time code.

- Open the time code [Mode] submenu.
 

[00:00 TC/UB Setup]  [Time Code]  [Mode]
- Select the desired option and then press the joystick.
 

€ If you selected [Regen.], you do not need to perform the rest of this procedure. If you selected [Preset] and would like to set the time code's initial value, see the following section *Setting the Time Code's Initial Value*.
- After you select [Preset], open the time code [Run] submenu.
 

[00:00 TC/UB Setup]  [Time Code]  [Run]
- Select the desired option and then press the joystick.

**Options**

[Preset]: The time code starts from an initial value you can select in advance. The default initial time code is 00:00:00.00. The time code's running mode depends on the [Run] setting.

[Rec Run]: The time code runs only while recording so clips recorded consecutively on the same SD card will have continuous time codes.

[Free Run]: The time code starts running the moment you press the joystick to select this option and keeps running regardless of the camcorder's operation.

[Regen.]: The camcorder will read the selected SD card and the time code will continue from the last recorded time code on the SD card. The time code runs only while recording so clips recorded consecutively on the same SD card will have continuous time codes.

[00:00 TC/UB Setup]

[Time Code]

[Mode]

[Preset]

[00:00 TC/UB Setup]

[Time Code]

[Run]

[Rec Run]

[00:00 TC/UB Setup]

[Time Code]

[Setting]

#### Setting the Time Code's Initial Value

If you set the time code mode to [Preset], you can set the initial value of the time code.

When a procedure requires selecting an option, the available options are listed within or after the procedure. Brackets [ ] are used to refer to menu options as they are displayed on screen.

When a function requires the use of the menu, the quick reference shows the submenus and, when applicable, the default setting for the menu item. The example illustration indicates that you can find the function by selecting the **[00:00 TC/UB Setup]** menu and then the [Time Code] menu item.

## Supplied Accessories

The following accessories are supplied with the camcorder.

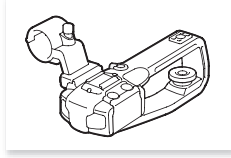

Handle Unit

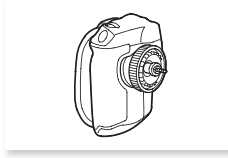

Grip Unit<sup>1</sup>

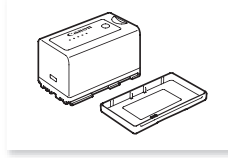

BP-955 Battery Pack  
(incl. terminal cover)

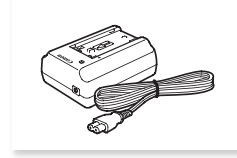

CA-930 Compact Power Adapter  
(incl. power cord)



Body Cap<sup>1</sup>

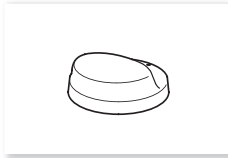

Thumb Rest

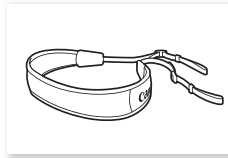

SS-1200 Shoulder Strap

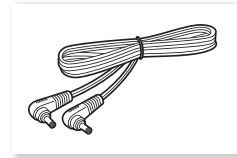

DC-930 DC Cable

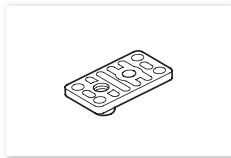

Adapter Base for 0.64 cm (1/4 in.)  
Tripods



Tape Measure Hook<sup>1</sup>

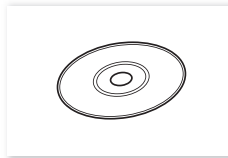

PIXELA Software CD-ROM<sup>2</sup>

<sup>1</sup> Comes pre-attached to the camcorder.

<sup>2</sup> Use **Data Import Utility** to transfer your clips to a computer. Refer to *Saving Clips to a Computer* (□ 123). The CD-ROM includes the instruction manual of the software (on PDF file).

## Names of Parts

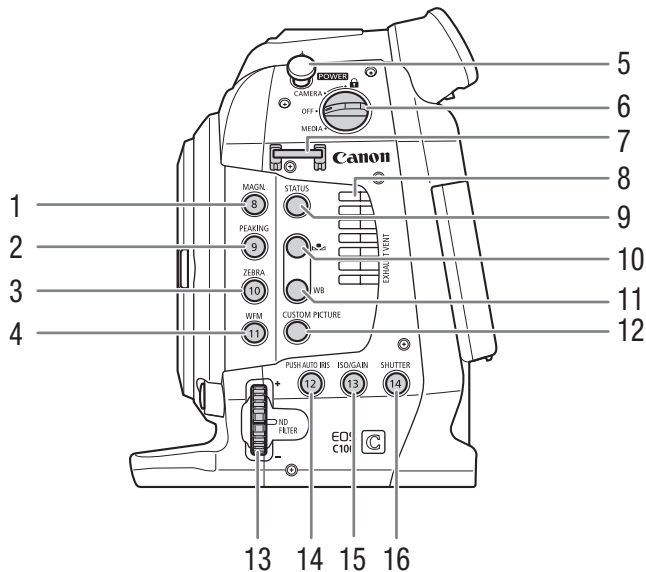

- |   |   |    |  |
|---|---|----|--|
| 1 | MAGN. (magnification) button (📖 67)/<br>Assignable button 8 (📖 89)                            | 8  | Exhaust ventilation outlet (📖 37)  |
| 2 | PEAKING button (📖 67) /<br>Assignable button 9 (📖 89)   | 9  | STATUS button (📖 141)  |
| 3 | ZEBRA button (📖 69)/<br>Assignable button 10 (📖 89)   | 10 | ☑ (white balance adjustment) button (📖 63)   |
| 4 | WFM (waveform monitor) button (📖 81)/<br>Assignable button 11 (📖 89)                          | 11 | WB (white balance) button (📖 63)   |
| 5 | Tape measure hook<br>Use the hook to accurately measure the distance<br>from the focal plane. | 12 | CUSTOM PICTURE button (📖 92)   |
| 6 | <b>POWER</b> switch (📖 24)  | 13 | ND FILTER dial (📖 59)  |
| 7 | Strap mount (📖 36)  | 14 | PUSH AUTO IRIS (momentary automatic aperture)<br>button (📖 61)/Assignable button 12 (📖 89) |
|   |   | 15 | ISO/GAIN button (📖 58)/Assignable button 13<br>(📖 89)                                      |
|   |   | 16 | SHUTTER button (📖 55)/Assignable button 14<br>(📖 89)                                       |

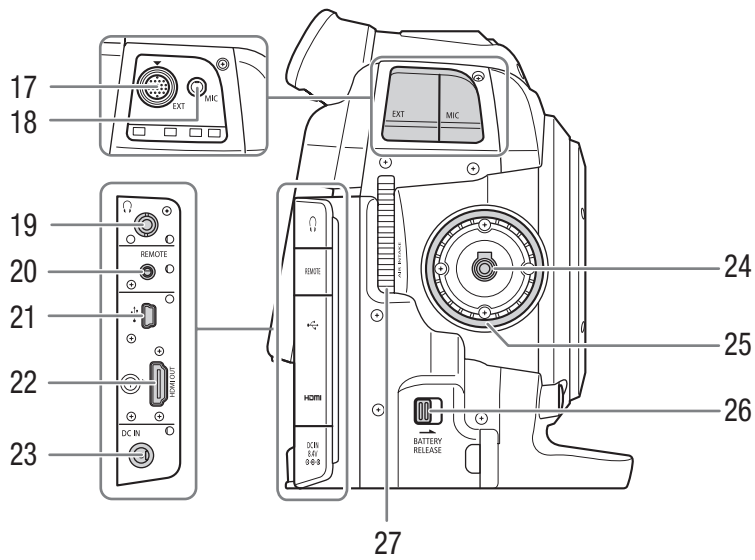

17 EXT (modular unit) terminal (📖 32)

18 MIC (microphone) terminal (📖 74)

19 🎧 (headphone) terminal (📖 79)

20 REMOTE terminal

For connecting commercially available remote controllers.

21 USB terminal (📖 123)

22 HDMI OUT terminal (📖 118)

23 DC IN terminal (📖 24)

24 Grip Unit connection terminal (📖 34)

25 Grip Unit attachment thread (📖 34)

26 BATTERY RELEASE latch (📖 22)

27 Air intake vent (📖 37)

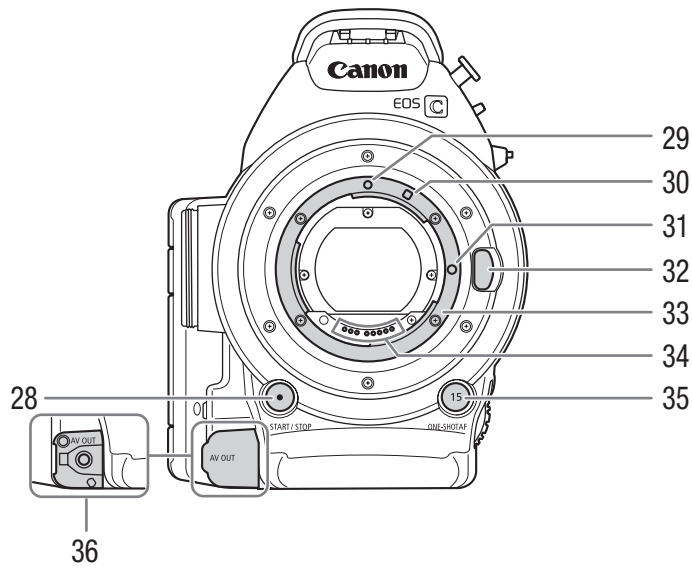

- 28 START/STOP button ( 45)
- 29 EF Lens mount index ( 29)
- 30 EF-S Lens mount index ( 29)
- 31 EF Lens lock pin ( 29)
- 32 Lens release button ( 30)
- 33 EF Lens mount ( 29)
- 34 EF Lens contacts ( 29)

- 35 ONE-SHOT AF (focus automatically once) button ( 65)/Assignable button 15 ( 89)
- 36 AV OUT terminal ( 119)



LCD panel fully open

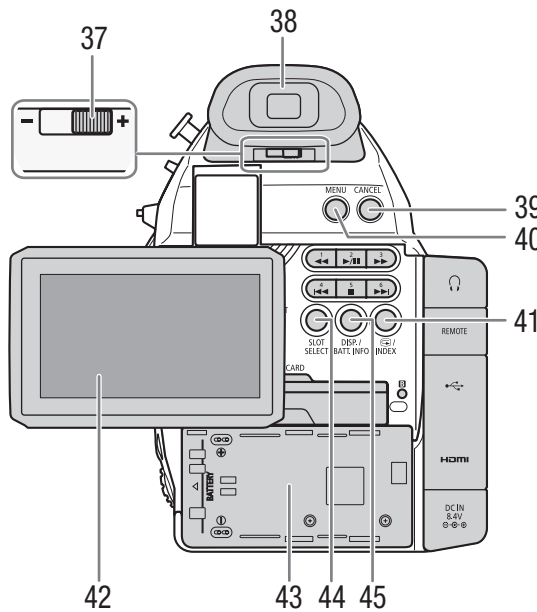

LCD panel raised 90° up and turned left

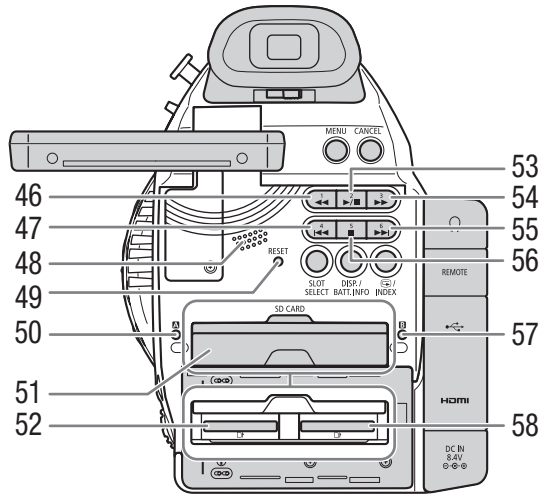

- 37 Dioptic adjustment lever ( 33)
- 38 Viewfinder ( 33, 33)
- 39 CANCEL button ( 27)
- 40 MENU button ( 27)
- 41 (review recording) button ( 83)/  
INDEX button ( 106)
- 42 LCD screen ( 33)
- 43 Battery compartment
- 44 SLOT SELECT (SD card slot selection) button  
( 41, 106)
- 45 DISP. (display) button ( 48, 108)/BATT. INFO  
(battery information) button ( 23)
- 46 ◀◀ (fast reverse playback) button ( 109)/  
Assignable button 1 ( 89)
- 47 ◀◀ (skip backward) button ( 109, 127)/  
Assignable button 4 ( 89)

- 48 Speaker ( 109)
- 49 RESET button ( 150)
- 50 SD card **A** access indicator ( 39)
- 51 SD card compartment cover
- 52 SD card slot **A** ( 39)
- 53 ▶/|| (play/pause) button ( 107, 127)/  
Assignable button 2 ( 89)
- 54 ▶▶ (fast playback) button ( 109)/  
Assignable button 3 ( 89)
- 55 ▶▶| (skip forward) button ( 109, 127)/  
Assignable button 6 ( 89)
- 56 ■ (stop) button ( 107, 127)/  
Assignable button 5 ( 89)
- 57 SD card **B** access indicator ( 39)
- 58 SD card slot **B** ( 39)

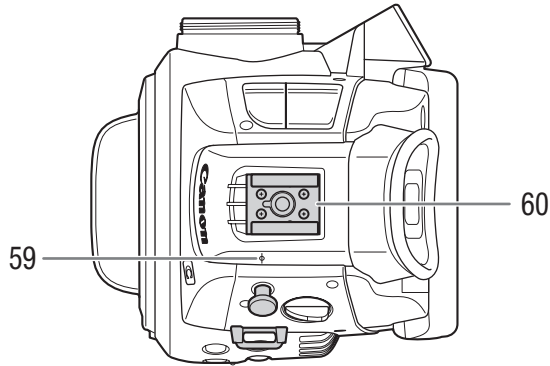

- 59  $\phi$  Focal plane mark
- 60 Accessory shoe with mounting hole for 0.64 cm (1/4 in.) screws  
Cold shoe for attaching the supplied handle unit or other accessories, such as the optional VL-10Li II Battery Video Light.

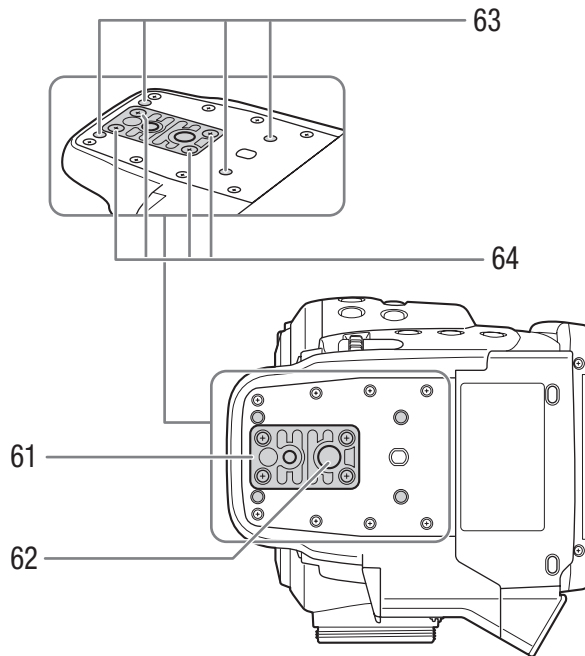

- 61 TB-1 Tripod Base for tripods with 0.95 cm (3/8 in.) screws (📖 34)
- 62 Tripod socket (📖 34)
- 63 Attachment sockets for the optional TA-100 Tripod Adapter (📖 34)
- 64 Tripod base screws (📖 34)

## Grip Unit

The grip unit comes originally attached to the camcorder. If the grip unit is removed, you will not be able to use the joystick, but you can set the joystick's functions (up/down/left/right/SET) to assignable buttons ( 89) to be able to change settings that require the joystick\*.

When the grip unit is not attached, the control dial ( 60, 61) and MAGN. button/Assignable button 7 ( 89) cannot be used to operate the camcorder either.

\* Except during photo playback. Functions that require the joystick include all settings in the menus ( 27, 133), white balance, ISO speed/gain and shutter speed ( 53), custom picture settings ( 92), etc.

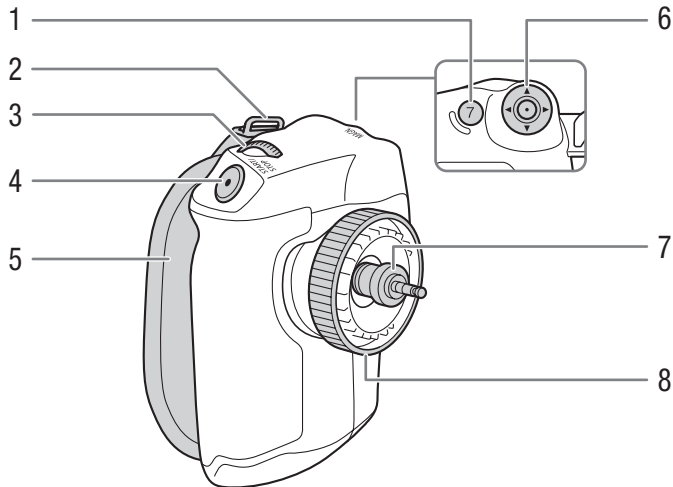

- 1 MAGN. (magnification) button ( 67)/  
Assignable button 7 ( 89)
- 2 Strap mount ( 36)
- 3 Control dial ( 60)
- 4 START/STOP button ( 45)
- 5 Grip belt ( 35)
- 6 Joystick ( 27)
- 7 Connection plug ( 34)
- 8 Lock screw ( 34)

Handle Unit

20

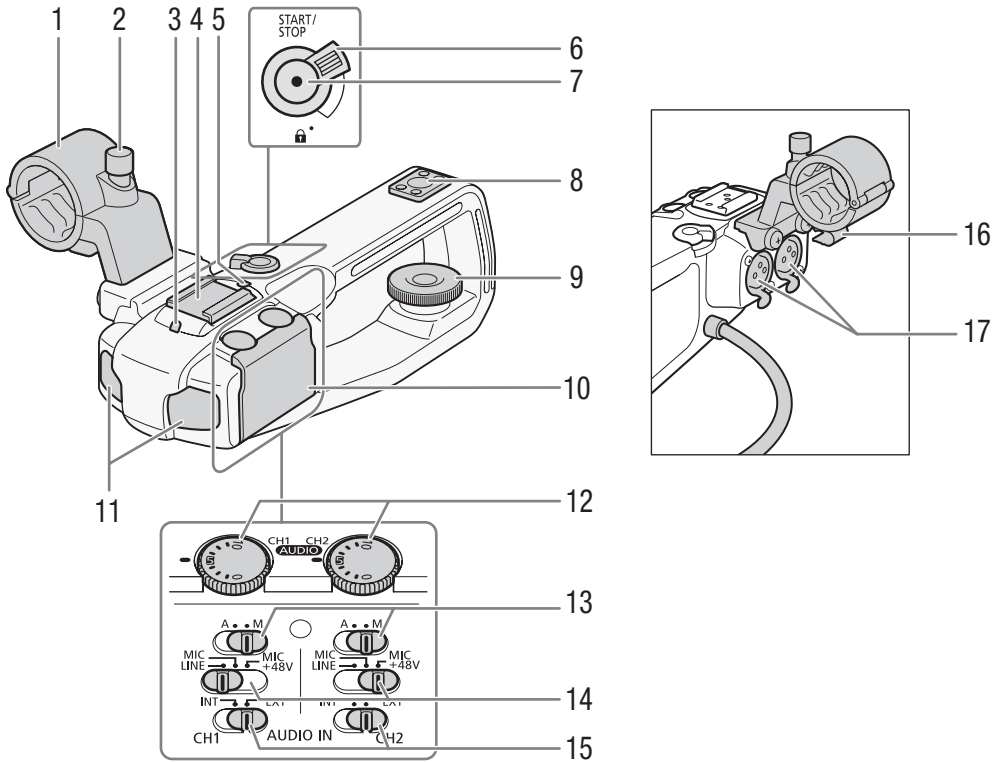

- |   |   |
|---|---|
| <ul style="list-style-type: none"> <li>1 Microphone holder (📖 74)</li> <li>2 Microphone lock screw (📖 74)</li> <li>3 Front tally lamp (📖 45)</li> <li>4 Cold accessory shoe</li> <li>5 Rear tally lamp (📖 45)</li> <li>6 START/STOP lock (🔒) lever (📖 47)</li> <li>7 START/STOP button (📖 45)</li> <li>8 Mounting hole for 0.64 cm (1/4 in.) screws</li> <li>9 Lock screw (📖 32)</li> <li>10 Protective cover for audio controls</li> <li>11 Built-in microphone (📖 74)</li> <li>12 <b>AUDIO</b> (audio level) dials for CH1 (left) and CH2 (right) (📖 75, 78)</li> </ul> | <ul style="list-style-type: none"> <li>13 Audio level switches for CH1 (left) and CH2 (right) (📖 75, 78)</li> <li>14 XLR terminal switches for CH1 (left) and CH2 (right) (📖 77)</li> <li>15 AUDIO IN (audio input selection) switches for CH1 (left) and CH2 (right) (📖 74, 77)</li> <li>16 Microphone cable clamp (📖 74)</li> <li>17 XLR terminals CH1 (right) and CH2 (left) (📖 74)</li> </ul> |
|---|---|

## Preparing the Power Supply

You can power the camcorder using a battery pack or directly using the compact power adapter. If you connect the compact power adapter to the camcorder while a battery pack is attached, the camcorder will draw power from the power outlet.

Charge battery packs before use. For approximate charging times and recording/playback times with a fully charged battery pack, refer to *Charging Times* (□ 160) and *Recording and Playback Times* (□ 160).

### Using a Battery Pack

You can power the camcorder using the supplied BP-955 or an optional BP-950G, BP-970G or BP-975 Battery Pack. The BP-955 and BP-975 are compatible with Intelligent System, meaning that you can check the remaining battery time.

### Charging the Battery Pack

Charge battery packs using the supplied DC-930 Compact Power Adapter. Before charging, disconnect the DC cable from the compact power adapter and remove the terminal cover of the battery pack.

1 If the DC cable is connected to the compact power adapter, disconnect it.

- Charging will not start while the DC cable is connected to the compact power adapter.

2 Connect the power cord to the compact power adapter.

3 Plug the power cord into a power outlet.

4 Attach the battery pack to the compact power adapter.

- Press lightly and slide the battery pack in the direction of the arrow until it clicks.
- The CHARGE indicator starts flashing and also indicates the battery pack's approximate charge. The indicator will stay on when charging has completed.

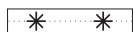

0-34%: Flashes once per second

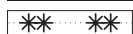

35-69%: Flashes twice per second

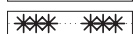

70-99%: Flashes 3 times per second

5 When charging has completed, remove the battery pack from the compact power adapter.

6 Unplug the power cord from the power outlet and disconnect it from the compact power adapter.

### ! IMPORTANT

- Do not connect to the compact power adapter any product that is not expressly recommended for use with this camcorder.

### i NOTES

- We recommend charging the battery pack in temperatures between 10 °C and 30 °C (50 °F and 86 °F). Outside the temperature range of 0 °C to 40 °C (32 °F to 104 °F), charging will not start.
- If there is a malfunction with the compact power adapter or battery pack, the charge indicator will go out and charging will stop.
- For handling precautions regarding the battery pack, refer to *Battery Pack* (□ 155).

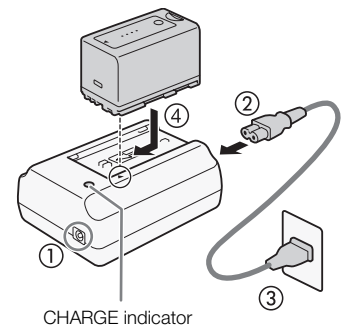

- Charged battery packs continue to discharge naturally. Therefore, charge them on the day of use, or the day before, to ensure a full charge.
- We recommend that you prepare battery packs to last 2 to 3 times longer than you think you might need.
- To charge the battery pack, disconnect the DC cable from the compact power adapter.

### Attaching the Battery Pack

- 1 Set the **POWER** switch to OFF.
- 2 Insert the battery pack all the way into the compartment as shown in the illustration and press it gently toward the left until it clicks.

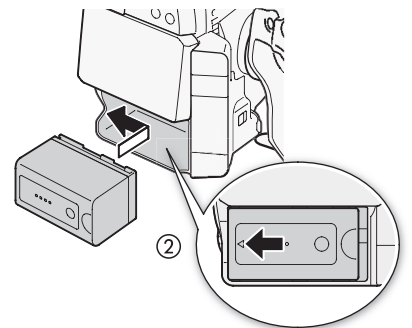
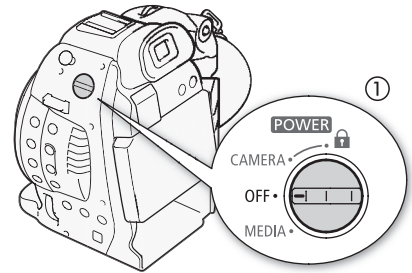

### Removing the Battery Pack

- 1 Set the **POWER** switch to OFF.
- 2 Push the BATTERY RELEASE latch in the direction of the arrow. While holding it down, slide the battery pack toward the right and then pull it out.

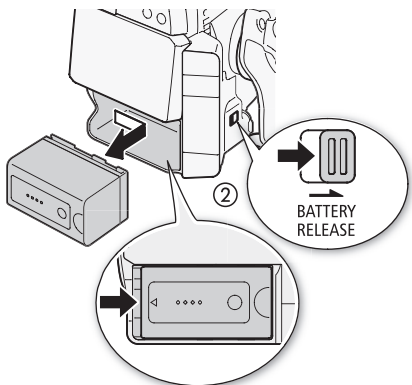
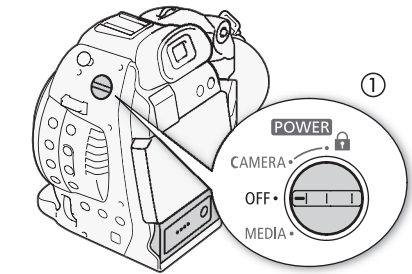

## Checking the Remaining Battery Charge

When the camcorder is turned on, you can check the remaining battery charge by looking at any recording/playback screen or the [Battery/Hour Meter] status screen (□ 144). When the camcorder is turned off, use one of the following methods to check the approximate remaining battery charge of a battery compatible with Intelligent System.

Press the CHECK button on the battery pack. An indicator will light for approximately 3 seconds and show the approximate remaining battery charge.

	0-25%
	26-50%
	51-75%
	76-100%

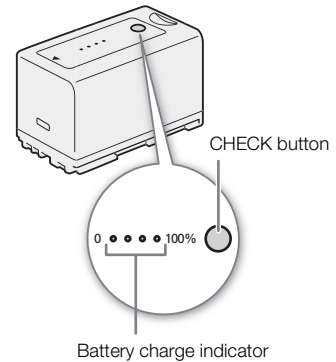

Press the BATT. INFO button to display the approximate remaining battery charge for about 5 seconds. Depending on the battery life, the battery information may not be displayed.

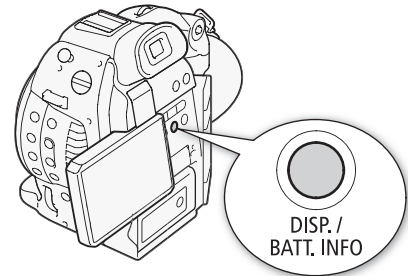

### NOTES

- The first time you use a battery pack, fully charge it and then use the camcorder until the battery pack is completely exhausted. Doing so will ensure that the remaining recording time will be displayed accurately in the various recording/playback screens.
- Repeatedly charging and discharging the battery pack will eventually shorten its battery life. You can check the battery life on the [Battery/Hour Meter] status screen (□ 144) or the battery information screen (press the BATT. INFO button while the camcorder is turned off). Fully charging the battery pack and then discharging it will give you a more accurate reading.
- **USA and Canada only:** The Lithium ion/polymer battery that powers the product is recyclable. Please call 1-800-8-BATTERY for information on how to recycle this battery.



### Using a Household Power Outlet

You can also power the camcorder directly from a power outlet using the supplied CA-930 Compact Power Adapter and DC-930 DC Cable.

- 1 Set the **POWER** switch to OFF.
- 2 Connect the DC cable to the DC IN terminal on the camcorder.
- 3 Connect the power cord to the compact power adapter and plug it into a power outlet.
- 4 Connect the DC cable to the compact power adapter.

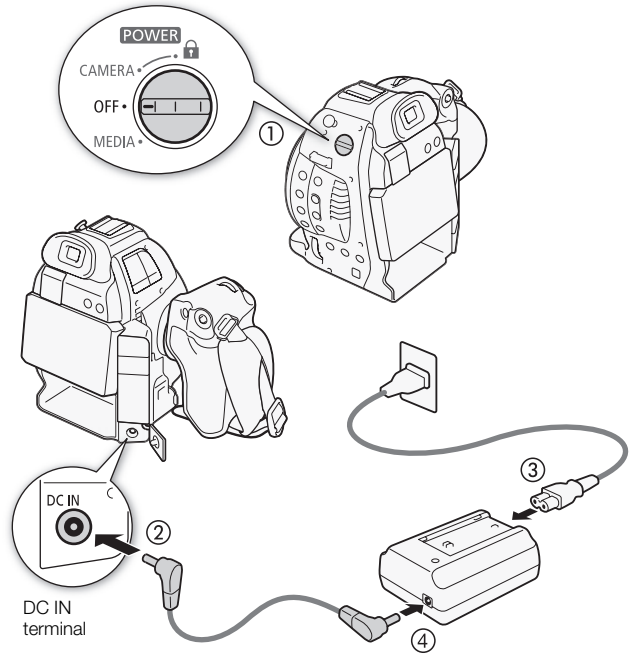

#### ! IMPORTANT

- Turn off the camcorder before connecting or disconnecting the compact power adapter.

#### i NOTES

- When using the camcorder with a household power outlet, you can change the battery pack while the power is on.

### Turning the Camcorder On and Off

The camcorder has two operating modes: CAMERA (CAMERA) mode for making recordings and MEDIA (MEDIA) mode for playing back recordings. Select the operating mode using the **POWER** switch.

#### To turn on the camcorder

Set the **POWER** switch to CAMERA for CAMERA mode or MEDIA for MEDIA mode.

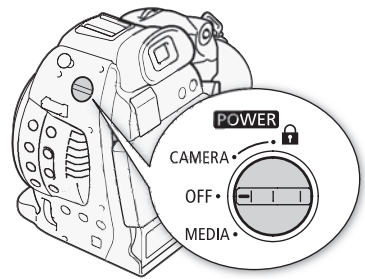
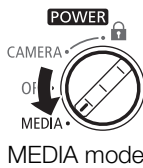

#### To turn off the camcorder

Set the **POWER** switch to OFF.

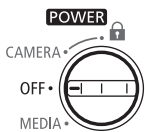



## Date, Time and Language Settings

### Setting the Date and Time

You will need to set the date and time of the camcorder before you can start using it. When the camcorder's clock is not set, the [Date/Time] screen will appear automatically with the first field selected (month or day, depending on the country/region of purchase).

Operating modes: CAMERA MEDIA



- 1 Push the joystick up/down to change the month/day then push it right to move to the next field.
  - To move to the next field you can also press the joystick itself.
- 2 Change the rest of the fields in the same way.
- 3 Select [Set] and then press the joystick to start the clock and close the screen.

#### **i** NOTES

- You can change the date format and the clock format (12/24 hours) with the [**Other Functions**] ➤ [Set Clock] ➤ [Date Format] setting.
- You can also change the date and time later on (not during the initial setup) with the [**Other Functions**] ➤ [Set Clock] ➤ [Date/Time] setting.
- When the built-in rechargeable lithium battery is exhausted, the date and time setting may be lost. In such case, recharge the built-in lithium battery (📖 157) and set the time zone, date and time again.

### Changing the Time Zone

Change the time zone to match the time zone of your location. The default setting is [UTC-05:00 New York] or [UTC+01:00 Central Europe], depending on the country/region of purchase. The time zones are based on Coordinated Universal Time (UTC).

Operating modes: CAMERA MEDIA

- 1 Press the MENU button.
- 2 Push the joystick up/down to select [**Other Functions**].
- 3 Select [Time Zone] in a similar fashion.
- 4 Push the joystick up/down to change the time zone.
- 5 Press the joystick to set the time zone and then press the MENU button to close the menu.

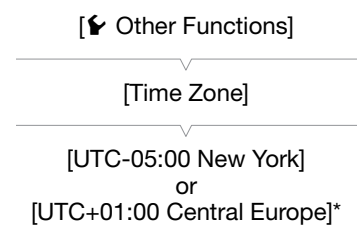

\* Depending on the country/region of purchase.

## Displaying the Date and Time while Recording

You can display the date and time on the screen.

Operating modes: CAMERA MEDIA

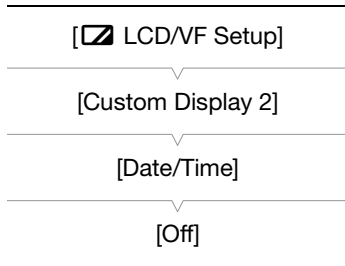

- 1 Press the MENU button.
- 2 Push the joystick up/down to select [ LCD/VF Setup].
- 3 Select [Custom Display 2] and then [Date/Time] in a similar fashion.
- 4 Push the joystick up/down to select the information to display.
  - Select [Off] to record without displaying the date and time.
- 5 Press the joystick and then press the MENU button to close the menu.
  - The selected date/time display will appear at the bottom left of the screen.



## Changing the Language

The default language of the camcorder is English. You can change it to German, Spanish, French, Italian, Polish, Russian, Simplified Chinese, Korean or Japanese. Please note that some settings and screens will be displayed in English, regardless of the language setting.

Operating modes: CAMERA MEDIA

- 1 Press the MENU button.
- 2 Push the joystick up/down to select [ Other Functions].
- 3 Select [Language ] in a similar fashion.
- 4 Push the joystick up/down to select a language.
- 5 Press the joystick to change the language and then press the MENU button to close the menu.

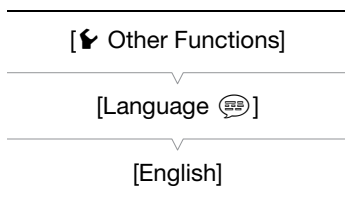

## Using the Menus

In **CAMERA** mode, many of the camcorder's functions can be adjusted from the menu for general settings, which opens after pressing the MENU button. You can also register frequently used menu settings in a customized submenu (My Menu) for easy access. In **MEDIA** mode, press the MENU button to open the menu for general settings or press the joystick to open the clip menu for clip operations. For details about the available menu options and settings, refer to *Menu Options* (133).

Operating modes: **CAMERA** **MEDIA**

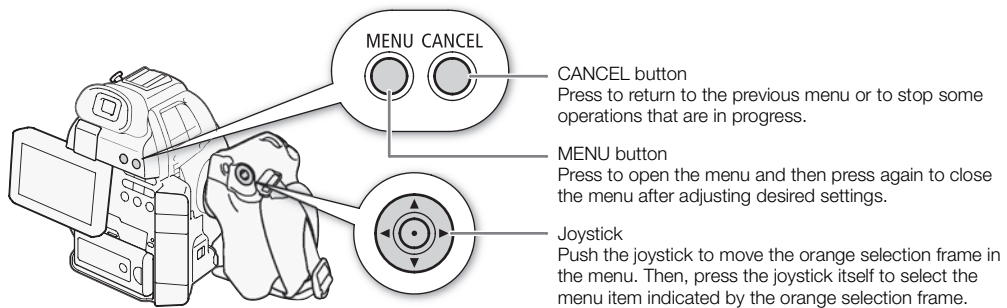

### Selecting an Option from the Menu

The following is a step-by-step explanation of how to select an option from the menu. In the procedures throughout the rest of this manual, opening and closing the menu is assumed and not included in the procedure.

#### 1 Press the MENU button.

- The menu opens with the orange selection frame indicating the menu item that was selected the previous time the menu was closed (unless the camcorder was turned off).

#### 2 Push the joystick up/down to select the desired submenu.

#### 3 Push the joystick right or press the joystick.

- The orange selection frame will appear on a menu item in the submenu.
- Press the CANCEL button, push the joystick left, or select [↩] to return to the previous submenu.

#### 4 Push the joystick up/down to select the desired menu item.

- If a submenu contains many menu items, a scroll bar will appear on the right side of the submenu indicating that you must scroll up or down to see other menu items.
- A ► mark next to a menu item indicates another submenu. Repeat steps 3 and 4.

#### 5 Push the joystick right or press the joystick.

- The orange selection frame will appear on a setting option.
- Press the CANCEL button to return to the previous submenu.

#### 6 Push the joystick up/down to select the desired setting option and then press the joystick.

- Depending on the menu item, additional selections may be necessary.

#### 7 Press the MENU button to close the menu.

#### **i** NOTES

- Unavailable items may appear grayed out.
- Pressing the MENU button at any time closes the menu.

- When an optional RC-V100 Remote Controller is connected to the camcorder, you can use the remote controller's Up/Down/Left/Right/SET buttons in the same way as the camcorder's joystick. Pressing the SET button is equivalent to pressing the joystick on the camcorder.
- You can check some of the current menu settings on the status screens (📖 141).

## Using the Customized Submenu (My Menu)

You can register up to 14 frequently used menu settings under the My Menu submenu for easy access. Furthermore, if you set an assignable button to [My Menu] (📖 89), you can press the button to access your registered menu settings even faster and more easily.

### Adding Menu Settings

- 1 Open the My Menu [Register] screen.
  - [★ My Menu] ➡ [Edit] ➡ [Register]
  - The menu will change to blue to indicate you are selecting menu settings to add to the My Menu submenu.
  - Select [Cancel] to cancel the operation.
- 2 Navigate the menus to find the menu setting you want to add and then press the joystick.
- 3 Select [OK] and then press the joystick twice.
  - The menu setting you registered will now appear under the [My Menu] submenu.

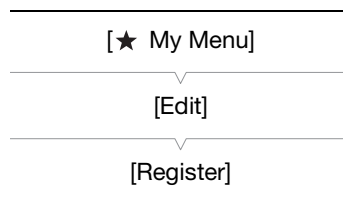

### Rearranging Menu Settings

- 1 Open the My Menu [Move] screen.
  - [★ My Menu] ➡ [Edit] ➡ [Move]
- 2 Push the joystick up/down to select the setting you want to move and then press the joystick.
  - An orange ⬆️ icon will appear next to the setting you selected to move.
- 3 Push the joystick up/down to move the setting to the desired position and then press the joystick.

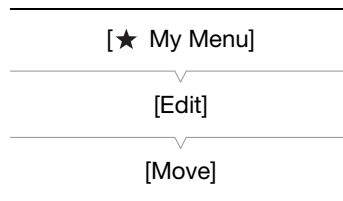

### Removing Menu Settings

- 1 Open the My Menu [Delete] screen.
  - [★ My Menu] ➡ [Edit] ➡ [Delete]
- 2 Push the joystick up/down to select the setting you want to remove and then press the joystick.
- 3 Select [OK] and then press the joystick twice.

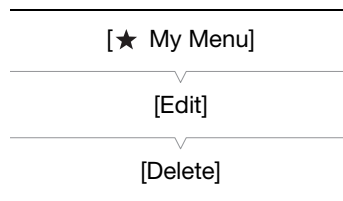

### Resetting the My Menu Submenu

- 1 Reset all the menu settings registered to the My Menu submenu.
  - [★ My Menu] ➡ [Edit] ➡ [Reset All]
- 2 Select [OK] and then press the joystick twice.

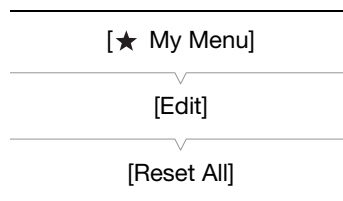

## Preparing the Camcorder

This section outlines the basic preparations for the camcorder such as attaching a lens and attaching the modular units (handle unit, grip unit, etc.) to the camcorder. The modular units extend the camcorder's functionality so you can choose the configuration that best fits your needs and shooting conditions.

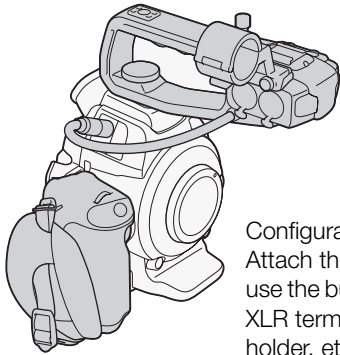

Configuration with handle:  
Attach the handle unit to use the built-in microphone, XLR terminals, microphone holder, etc. (☞ 74).

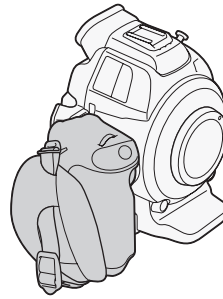

Light configuration with grip  
for hand-held shooting.

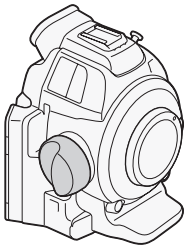

Minimal configuration with thumb rest. You will not be able to use the joystick, but you can set the joystick's functions (up/down/left/right/SET) to assignable buttons (☞ 89) to be able to change settings that require the joystick\*. Also, the control dial (☞ 60, 61) and MAGN. button/Assignable button 7 (☞ 89) cannot be used to operate the camcorder.

\* Except during photo playback. Functions that require the joystick include all settings in the menus (☞ 27, 133), white balance, ISO speed/gain and shutter speed (☞ 53), custom picture settings (☞ 92), etc.

## Preparing the Lens

As much as possible, attach and remove the lens quickly and in a clean environment free of dust. Refer also to the instruction manual of the lens used.

### ! IMPORTANT

- When attaching/removing a lens, avoid direct sunlight or strong light sources. Also, be careful not to drop the camcorder or lens.

### i NOTES

- Be careful not to touch the lens mount or any components inside the lens mount area.
- Replace the body cap to the lens mount immediately after removing the lens from the camcorder.
- Keep the body cap clean and free from dust or dirt particles.

### Attaching an EF Lens

- 1 Set the **POWER** switch to OFF.
- 2 Remove the body cap from the camcorder and any dust caps from the lens.
- 3 Attach the lens to the camcorder and turn the lens in the direction of the arrow until it clicks in place.
  - EF lenses: Align the red mark on the lens with the red EF Lens mount index mark on the camcorder.
  - EF-S lenses: Align the white mark on the lens with the white EF-S Lens mount index mark on the camcorder.

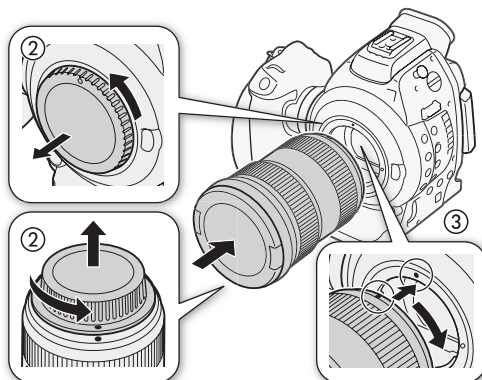

### **i** NOTES

- Turning on the image stabilization function of an EF lens may reduce the effective usage time of the battery pack. When image stabilization is not necessary, for example if the camcorder is fixed to a tripod, it is recommended to turn it off.
- On some EF lenses equipped with autofocus (AF) function, the focus ring will be disabled when the focus mode switch is set to AF. In such case, set the focus mode switch to MF.
- Depending on the lens used, you may experience one or more of the following limitations.
  - The lens model name may be shortened when displayed on the screen.
  - You may not be able to use the focus preset function (super telephoto lenses).
  - You may not be able to use the power zoom function of the lens.

### Removing an EF Lens

- 1 Set the **POWER** switch to OFF.
- 2 Hold down the lens release button and turn the lens all the way in the direction of the arrow until it stops.
- 3 Remove the lens and replace the body cap to the camcorder and the dust cap to the lens.

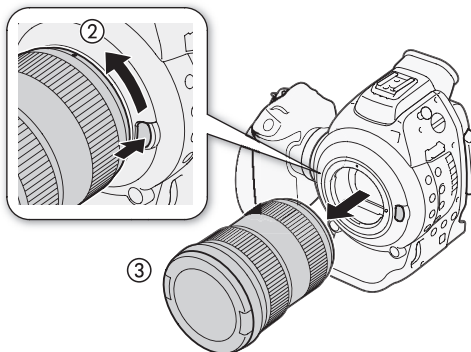

### Peripheral Illumination Correction

Depending on the characteristics of the lens used, the image around the corners of the picture may seem darker due to light fall-off or peripheral illumination drop. If the camcorder has correction data available for the EF lens used, it can apply this correction data to compensate as necessary.

Operating modes: CAMERA MEDIA

- 1 Attach the lens you want to use.
- 2 Open the peripheral illumination correction screen.
  - [**Camera Setup**] **▶** [**Periph. Illum. Corr.**]
  - If correction data is available, the lens model name will appear on the screen.
  - If correction data is not available, [**Periph. Illum. Corr.**] will appear grayed out. Visit your local Canon Web site and check if there is correction data available for the lens you are using. If so, download the necessary update package and upgrade the camcorder's firmware following the instructions supplied therein.

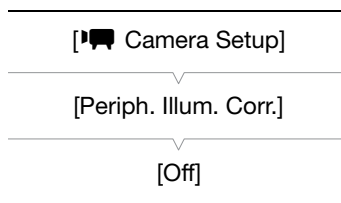

3 Select [On] and then press the joystick.

- As long as [Camera Setup] [Periph. Illum. Corr.] is set to [On], the camcorder will automatically apply the appropriate correction data.

### Correction for EF-S Lenses

The peripheral illumination fall-off may be more pronounced with EF-S lenses than with EF lenses. To prevent this, when you use an EF-S lens, you can change the sensor area that is used for producing the image.

Operating modes: CAMERA MEDIA

1 Open the [EF-S Lens] submenu.

[Camera Setup] [EF-S Lens]

2 Select [On] and then press the joystick.

- [EF-S] will appear at the lower center of the screen.
- When [EF-S Lens] is set to [On], the image is enlarged digitally by a factor of approximately 1.04x, slightly affecting the image quality. In most cases, using the default [Off] setting is recommended.

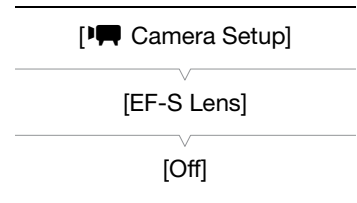

### NOTES

#### • About lens correction data:

- The camcorder contains a register of correction data for compatible lenses that were available at the time the camcorder went on sale. Correction data for future lenses will be made available as part of the regular updates released for the camcorder's firmware. For more details, visit your local Canon Web site.
- Depending on the recording conditions, noise may appear in the periphery of the image as a result of the correction.
- The level of correction will be lower for lenses that cannot provide distance information.
- The level of correction will be lower the higher the ISO speed/gain setting used.
- No correction will be applied when correction data is not available for the lens attached.
- When using non-Canon lenses, peripheral illumination cannot be corrected. Even if the [Periph. Illum. Corr.] setting is available (not grayed out), setting it to [Off] is recommended.

### Updating the Firmware of an EF Lens

You can update the lens firmware of an EF lens using the camcorder. For details about firmware updates for EF lenses, visit your local Canon Web site.

Operating modes: CAMERA MEDIA

1 Insert the SD card containing the lens firmware update into SD card slot A.

2 Attach to the camcorder the lens you wish to update and open the [Lens Firmware] submenu.

[Other Functions] [Lens Firmware]

- The current lens firmware version will appear on the screen.
- If the [Lens Firmware] submenu is grayed out, the attached lens may not support firmware updates or the SD card in SD card slot A may not contain a valid lens firmware file. Check the lens and SD card and repeat the procedure from the beginning.

3 Select [OK] and then press the joystick.

4 Select the lens firmware file (file extension .LFU) and then press the joystick.

5 Select [OK] and then press the joystick.

- The lens firmware will be updated. Once in progress, the lens firmware update cannot be canceled.

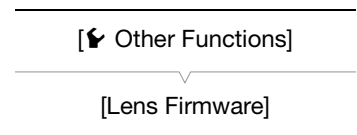

6 When the confirmation message appears, press the joystick.

**!** IMPORTANT

- Be sure to observe the following precautions while the lens firmware is being updated.
  - Do not disconnect the power source or turn off the camcorder.
  - Do not remove the lens.
  - Do not operate any buttons or controls on the camcorder.
  - Do not open the SD card compartment cover and do not remove the SD cards.

**i** NOTES

- The lens firmware cannot be updated while pre-recording is activated.
- We recommend that you power the camcorder from a household power outlet using the compact power adapter or use a sufficiently charged battery pack.
- When using an optional EF Extender, remove the Extender before performing the procedure.

## Attaching and Removing the Handle Unit

The handle unit extends the camcorder's audio capabilities, adding XLR terminals as well as a built-in stereo microphone.

### Attaching the Handle Unit

- 1 Set the **POWER** switch to OFF.
- 2 Insert the attachment base at the bottom of the handle unit to the camcorder's accessory shoe.
- 3 Tighten the handle unit's lock screw while gently pressing it down.
- 4 Connect the handle unit's cable to the camcorder's EXT terminal, aligning the ▲ marks.

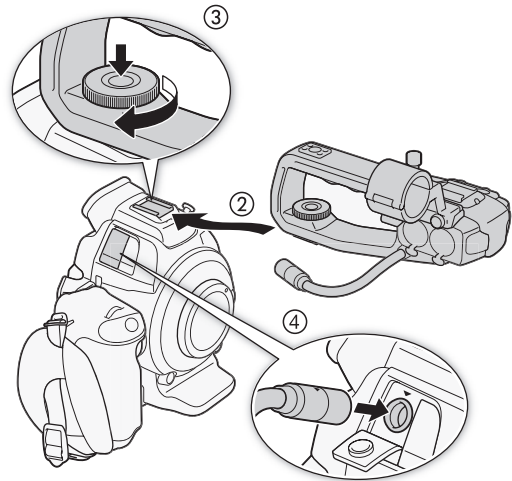

### Removing the Handle Unit

- 1 Set the **POWER** switch to OFF.
- 2 Disconnect the handle unit's cable.
  - Pull back the metallic tip of the cable to release the cable and then disconnect the cable from the terminal.
- 3 Loosen the handle unit's lock screw and gently slide out the handle unit from the accessory shoe.

**i** NOTES

- You can use the accessory shoe or the socket for 0.64 cm (1/4 in.) screws on the handle unit to attach a variety of commercially available accessories.



## Using the Viewfinder

### Dioptric Adjustment

Turn on the camcorder and adjust the dioptric adjustment lever.

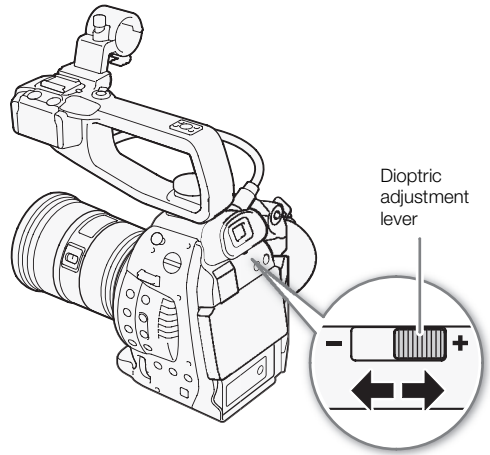

### Using the LCD Panel

- 1 Pull the LCD panel 90° up.
- 2 Rotate the LCD panel 180° left.
- 3 Push down the LCD panel to adjust it to the desired angle of view.

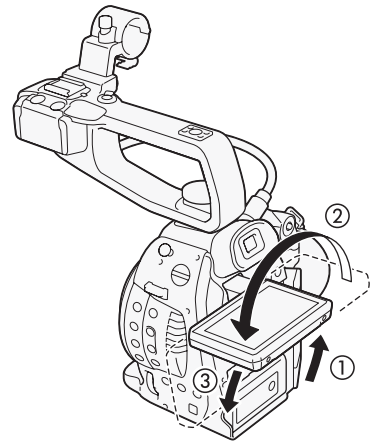

### **i** NOTES

- You can set the LCD screen to black & white ( 34).
- When you use a commercially available lens adapter and the image on the screen is inverted, you can use the [ Other Functions ] [ Custom Function ] [ Scan Reverse Rec ] setting to return the image to the correct orientation.
- If you are not interested in using the viewfinder along with the LCD screen, you can set [ LCD/VF Setup ] [ LCD/VF Simul. ] to [ Off ] to conserve the camcorder's power. Even when [ LCD/VF Simul. ] is set to [ Off ], closing the LCD panel will automatically activate the viewfinder.

## Adjusting the Viewfinder/LCD Screen

You can adjust the brightness, contrast, color, sharpness, and backlight of the viewfinder and LCD screen independently of each other. These adjustments will not affect your recordings.

Operating modes: CAMERA MEDIA

- 1 Open the setup menu for the viewfinder or LCD screen.  
[ LCD/VF Setup ] [ LCD Setup ] or [ VF Setup ]
- 2 Select [ Brightness ], [ Contrast ], [ Color ], [ Sharpness ] or [ Backlight ] and then press the joystick.
- 3 Adjust the setting and then press the joystick.
  - Repeat steps 2 and 3 to adjust other settings as necessary.

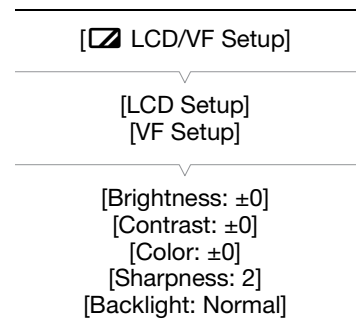

### **i** NOTES

- If you set an assignable button to [ LCD Setup ] or [ VF Setup ] ( 89 ), you can press the button to open the respective submenu.

### Setting the Screen to Black & White

The viewfinder and LCD screen display in color by default but you can set them to black & white. Even when the screen is black & white, onscreen text and icons will still be displayed in color.

- 1 Open the [LCD/VF B&W] submenu.  
 [LCD/VF Setup]  [LCD/VF B&W]
- 2 Select [On] and then press the joystick.

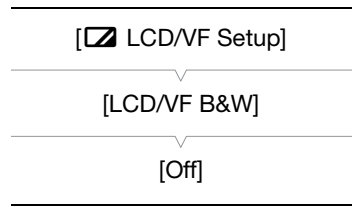

#### NOTES

- If you set an assignable button to [LCD/VF B&W] ( 89), you can press the button to turn the black & white display on and off.
- **About the LCD and viewfinder screens:** The screens are produced using extremely high-precision manufacturing techniques, with more than 99.99% of the pixels operating to specification. Less than 0.01% of the pixels may occasionally misfire or appear as black, red, blue or green dots. This has no effect on the recorded image and does not constitute a malfunction.

### Using a Tripod

The camcorder is shipped with the TB-1 Tripod Base for tripods with 0.95 cm (3/8 in.) screws. You can mount the camcorder on a tripod but do not use tripods with mounting screws longer than 5.5 mm (0.2 in.) as this may cause damage to the camcorder.

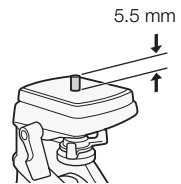



#### Using a Tripod with 0.64 cm (1/4 in.) Mounting Screws

To use a tripod with 0.64 cm (1/4 in.) mounting screws, first attach the supplied tripod adapter base to the camcorder and then attach the tripod to the adapter base.

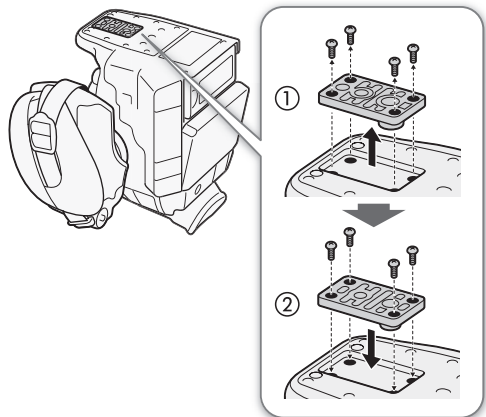
- 1 Remove the original TB-1 Tripod Base from the camcorder.
  - Remove the 4 screws and then remove the base.
- 2 Attach the supplied tripod adapter base for 0.64 cm (1/4 in.) tripods.
  - Firmly screw in the 4 screws.
- 3 Attach the tripod.
  - Firmly screw in the tripod screw.



### Removing and Attaching the Grip Unit

The grip unit comes originally attached to the camcorder. You can remove it and replace it with the thumb rest should the minimal configuration be necessary. Although you will not be able to use the joystick, you can set the joystick's functions (up/down/left/right/SET) to assignable buttons ( 89) to be able to change settings that require the joystick\*. Also, the control dial ( 60, 61) and MAGN. button/Assignable button 7 ( 89) cannot be used to operate the camcorder.

\* Except during photo playback. Functions that require the joystick include all settings in the menus ( 27, 133), white balance, ISO speed/gain and shutter speed ( 53), custom picture settings ( 92), etc.

### Removing the Grip Unit

- 1 Set the **POWER** switch to OFF.
- 2 Unscrew the grip unit's lock screw and gently detach the grip unit.
  - The grip unit contains an internal connection cable so be sure not to pull it too forcefully.
- 3 Disconnect the grip unit's connection plug.
- 4 Screw the thumb rest onto the camcorder.

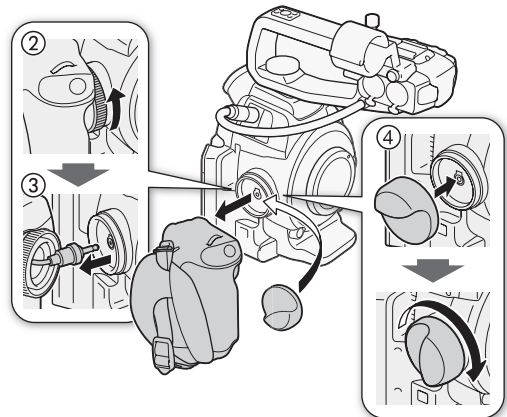

### Attaching the Grip Unit

The grip unit can be attached in any of 24 positions (at 15° intervals) to give you a convenient grip angle for high- and low-angle shooting.

- 1 Set the **POWER** switch to OFF.
- 2 Unscrew the thumb rest and remove it from the camcorder.
- 3 Firmly insert the grip unit's plug all the way into the grip unit connection terminal on the camcorder.
  - Make sure to insert the plug all the way in, until the white line around the terminal is not visible.
  - If the plug is not correctly connected (for example, if the white line around the terminal is partly visible), all the controls on the camcorder may be disabled.
- 4 Attach the grip unit to the camcorder aligning it at the desired angle and tighten the grip unit's lock screw.

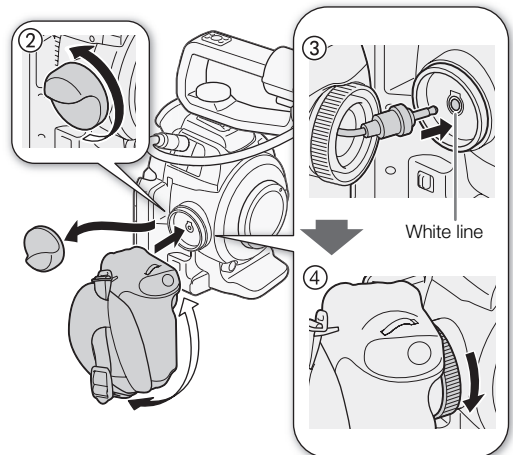

### Adjusting the Grip Belt

Adjust the grip belt so that you can reach the START/STOP button on the grip unit with your index finger but still have a comfortable but secure grip.

#### ! IMPORTANT

- Be careful not to drop the camcorder when adjusting the grip belt.

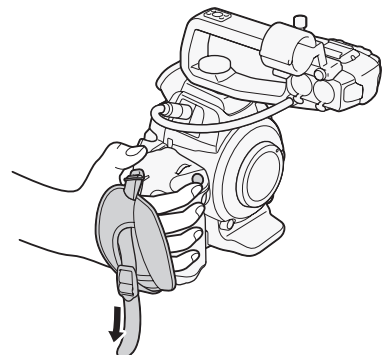

### Attaching a Shoulder Strap

Pass the ends through the strap mount and adjust the length of the strap.

**!** IMPORTANT

- Be careful not to drop the camcorder when attaching or adjusting the shoulder strap.

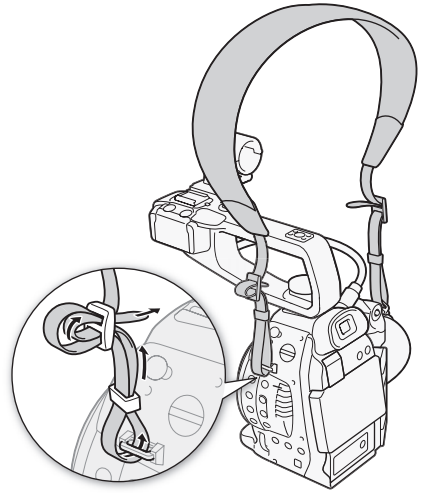

### Removing and Attaching the Terminal Covers

You can remove the plastic covers of the following terminals to access them more readily.

- AV OUT
- EXT
- MIC
- (headphones)
- REMOTE
- DC IN
- USB and HDMI OUT

#### Removing the Terminal Covers

Open the terminal cover and gently pull it straight out.

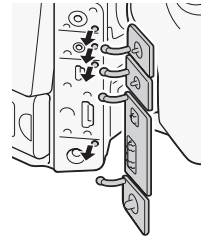

#### Attaching the Terminal Covers

Insert the connecting strip into the opening to attach the terminal cover.

**i** NOTES

- If the connecting strip is difficult to grasp, use a pair of tweezers or similar tool.

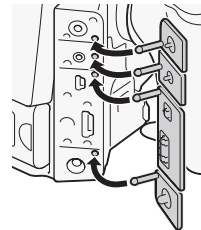

## The Camcorder's Cooling System

The camcorder's internal temperature is controlled using a cooling fan that will turn on whenever the camcorder itself is turned on. However, you can turn off the cooling fan temporarily if necessary.

Operating modes: CAMERA MEDIA



### 1 Open the [Fan] submenu.

[Other Functions] ➤ [Fan]

### 2 Select [Automatic] and then press the joystick.

#### Options

[On]: The cooling fan is on as long as the camcorder is on.

[Automatic]: The cooling fan is temporarily turned off. If the camcorder's internal temperature rises too much, the  will appear in yellow on the left of the screen. If the temperature starts to become critical, the  will turn red and the cooling fan will come on to prevent overheating. Once the camcorder has cooled off sufficiently, the fan will turn off again. While the fan is activated automatically, **FAN** will appear next to the  icon.

#### NOTES

- Depending on the ambient temperature and other shooting conditions, the cooling fan may not turn off even if you set [Fan] to [Automatic].
- The cooling fan cannot be turned off in MEDIA mode.
- When changing the camcorder's configuration, be careful not to obstruct the cooling fan's air intake and exhaust vents (marked respectively as AIR INTAKE and EXHAUST VENT).
- If you set an assignable button to [Fan] ( 89), you can press the button to toggle between the [On] and [Automatic] settings.

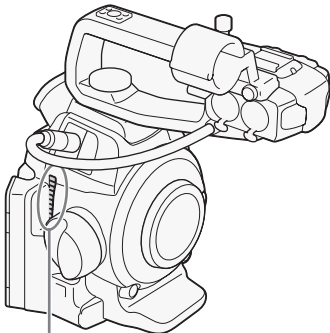

Exhaust vent (EXHAUST VENT)

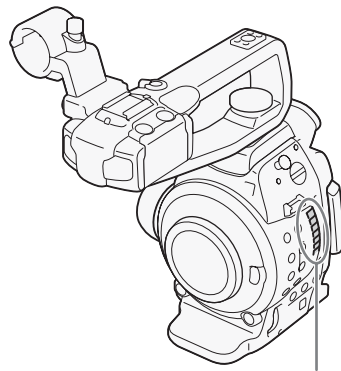

Intake vent (AIR INTAKE)

[Other Functions]

[Fan]

[On]

## Using an SD Card

### SD Cards Compatible for Use with the Camcorder

You can use the following types of commercially available Secure Digital (SD) cards with this camcorder. The camcorder is equipped with two SD card slots. Initialize SD cards (📖 40) when you use them with this camcorder for the first time.

As of October 2012, the video recording function has been tested using SD/SDHC/SDXC cards made by Panasonic, Toshiba and SanDisk.

Memory card type:	 SD card,  SDHC card,  SDXC card
SD Speed Class*:	 CLASS 2,  CLASS 4,  CLASS 6,  CLASS 10
Capacity:	128 MB or larger**.

\* When using an SD card without a speed class rating or one rated SD Speed Class 2, you may not be able to record video, depending on the card used.

\*\*SD cards with a capacity of 64 MB or smaller cannot be used to record video.

#### ! IMPORTANT

- After repeatedly recording, deleting and editing clips (fragmented memory), it will take longer to write data on the SD card and recording may stop. Save your recordings and initialize the SD card using the camcorder.

#### i NOTES

- **About the Speed Class:** Speed Class is a standard that indicates the minimum guaranteed data transfer speed of SD cards. When you buy a new SD card, look for the Speed Class logo on the package. We recommend using SD cards rated SD Speed Class 4, 6 or 10.

### SDXC Cards

You can use SDXC cards with this camcorder. When using SDXC cards with other devices, such as digital recorders, computers and card readers, **make sure that the external device is compatible with SDXC cards.** The table below summarizes compatibility by computer operating system, as of October 2012. For the latest information, however, contact the computer, operating system or card manufacturer.

#### Compatible operating systems for SDXC cards

Operating system	Compatibility
Windows 7	Compatible
Windows Vista	Compatible (requires Service Pack 1 or later)
Windows XP	Compatible (requires Service Pack 3 and KB955704 update)
Mac OS X	Compatible (requires version 10.6.5 or later)

#### ! IMPORTANT

- If you use an SDXC card with a computer OS that is not SDXC-compatible, you may be prompted to format the card. In such case, **cancel the operation to prevent data loss.**

## Inserting and Removing an SD Card

You can insert an SD card into SD card slot A or slot B. If you have two SD cards, you can use both slots.

- 1 Turn off the camcorder.
- 2 Lift the LCD panel upwards and open the SD card compartment cover.
- 3 Insert the SD card straight, with the label facing up, all the way into the SD card slot until it clicks.
- 4 Close the SD card compartment cover.
  - Do not force the cover closed if the SD card is not correctly inserted.

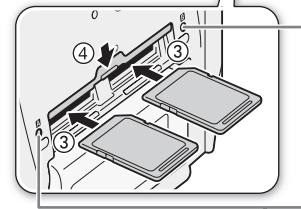
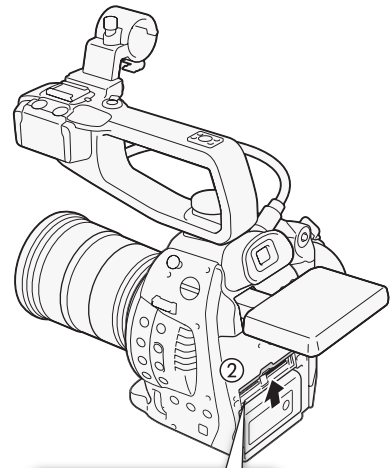

SD card access indicator

## Checking the Status of the SD Card Slots

You can check the status of the SD card slots immediately by looking at the SD card **A**/SD card **B** access indicator. Refer to the following table. Depending on the position of the LCD panel, it may be difficult to see the SD card access indicators. In such case, adjust the position or angle of the LCD panel as necessary.

Access indicator color	SD card slot status
Red	Accessing the SD card.
Green	Recording/playback is possible and the SD card slot is selected for recording/playback.
Indicator off	An SD card is not inserted, the SD card slot is not currently selected, or the SD card is not being accessed.

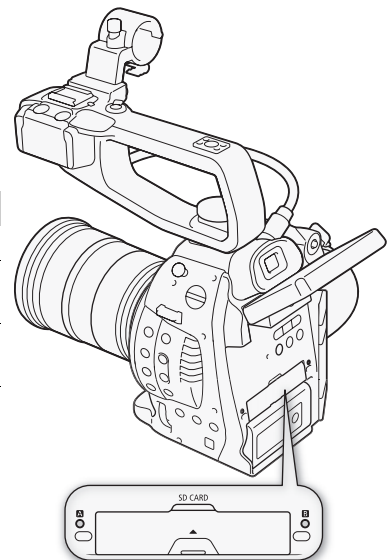

### ! IMPORTANT

- Observe the following precautions while either of the SD card access indicators is illuminated in red. Failure to do so may result in permanent data loss.
  - Do not disconnect the power source or turn off the camcorder.
  - Do not open the SD card compartment cover and do not remove the SD cards.
- Turn off the camcorder before inserting or removing an SD card. Inserting or removing the SD card with the camcorder on may result in permanent data loss.
- SD cards have front and back sides that are not interchangeable. Inserting an SD card facing the wrong direction can cause a malfunction of the camcorder. Be sure to insert the SD card as described in step 3.

**i** NOTES

- **To remove the SD card:** Push the SD card once to release it. When the SD card springs out, pull it all the way out.
- If you set the [ Other Functions] [Media Access LED] function to [Off], the access indicators will not illuminate.

**Initializing an SD Card**

The first time you use an SD card with this camcorder, initialize it first. You can also initialize an SD card to permanently delete all the data it contains.

When initializing an SD card, you can select quick initialization, which clears the file allocation table but does not physically erase the stored data, or complete initialization, which deletes all data completely.

Operating modes: CAMERA MEDIA

1 Open the [Initialize Media] submenu.

[ Other Functions] [Initialize Media]

2 Select [ A] or [ B] and then press the joystick.

3 Select [Complete] (complete initialization) or [Quick] (quick initialization) and then press the joystick.

4 Select [OK] and then press the joystick.

- If you are using the [Complete] initialization option, press the joystick twice to cancel the operation while it is in progress. You can use the SD card but all data will be erased.

5 When the confirmation message appears, press the joystick.

- The SD card is initialized and all the data it contains is erased.

**!** IMPORTANT

- Initializing an SD card will permanently erase all data, including custom picture files. Lost data cannot be recovered. Make sure you save important recordings in advance.
- Depending on the SD card, the complete initialization may take up to a few minutes.

**i** NOTES

- If you set an assignable button to [Initialize Media] ( 89), you can press the button to open the initialization submenu.

---

[ Other Functions]

---

[Initialize Media]

---



## Switching Between the SD Card Slots

The camcorder features two SD card slots, SD card slot A and SD card slot B. If both slots contain an SD card, you can switch between them as necessary.

Operating modes: **CAMERA** **MEDIA**

Press the **SLOT SELECT** button.

- The access indicator of the selected SD card slot will illuminate in green. On the screen, the SD card selected is indicated with a ► mark next to the SD card icon.

### **i** NOTES

- You cannot use the SLOT SELECT button to switch between SD card slots while recording.
- The SD card slot selected for recording will be used to record both clips and photos.

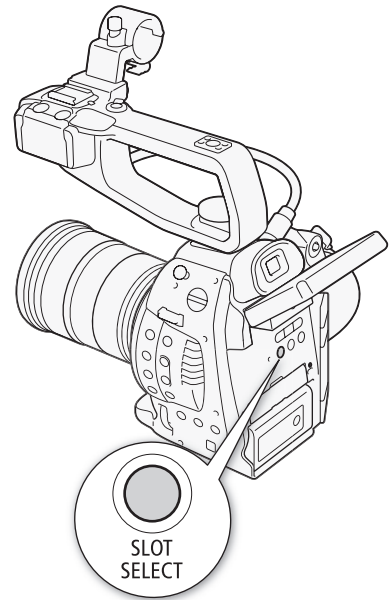

## Selecting the SD Card Recording Method

The camcorder features two useful SD card recording methods, relay recording and double slot recording.

**Relay recording:** This allows you to continue recording on another SD card if the SD card you are using becomes full. Relay recording is available from SD card slot A to SD card slot B, and vice versa.

**Double slot recording:** This records the same clip simultaneously to both SD cards, which is a convenient way to make a backup copy of your recording while you record.

Operating modes: **CAMERA** **MEDIA**

### To use relay recording

By default, this function is activated. If it has been deactivated, follow the procedure below to activate it.

- 1 Open the [Relay Rec] submenu.  
[Other Functions] ► [Relay Rec]
- 2 Select [On] and then press the joystick.

### To use double slot recording

- 1 Open the [Double Slot Rec] submenu.  
[Other Functions] ► [Double Slot Rec]
- 2 Select [On] and then press the joystick.

### **i** NOTES

- During relay recording, there will be a very brief stop in the video at the point where the recording switches to the other SD card. With the supplied software, **Data Import Utility**, you can join relay clips recorded on two SD cards and save them on a computer (123).
- If an SD card becomes full during double slot recording, recording on both SD cards will stop. On the other hand, if an error occurs with one of the SD cards, recording will continue on the other SD card.
- Double slot recording cannot be used with relay recording, pre-recording or deleting the last clip recorded.

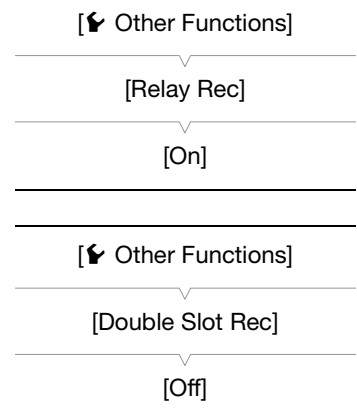

## Checking the Remaining Recording Time on the SD Card

When the camcorder is in **CAMERA** mode, the display on the upper left of the screen indicates which SD card slot is in use and the available recording time (in minutes\*) that remains on each SD card.

On the **[Media]** status screen (📖 143), you can check the total space, SD speed class, used space, available recording time and available number of photos on each of the SD cards.

\* The approximate available recording time is based on the current bit rate (📖 51).

## Recovering Data on an SD Card

Some actions, such as suddenly turning off the camcorder or removing the SD card while data is being recorded, can cause data errors on the SD card. In such case, you may be able to recover the data on the SD card.

Operating modes: **CAMERA** **MEDIA**

- 1 Insert the SD card with the data to be recovered into the camcorder.
- 2 When the screen prompts you to recover the data, select **[OK]** and then press the joystick.
- 3 When the confirmation message appears, press the joystick.

### NOTES

- In some cases, data may not be recovered, such as when the file system is corrupted or the SD card is physically damaged.

## Adjusting the Black Balance

You can have the camcorder adjust the black balance automatically when ambient temperature changes considerably or if there is a noticeable change in a true black video signal.

Operating modes: CAMERA MEDIA

### 1 Open the [ABB] screen.

[ Camera Setup] [ABB]

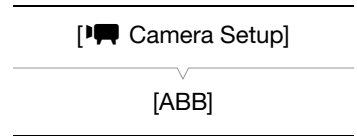

### 2 Attach the body cap to the lens mount.

- If a lens was attached, remove the lens and replace the body cap.

### 3 Select [OK] and then press the joystick.

- The automatic black balance procedure will start.

### 4 When the confirmation message appears, press the joystick.

- If the body cap is not correctly attached, [Error] will appear on the screen. Press the joystick and repeat the procedure from the beginning.

### NOTES

- Adjusting the black balance may be necessary in the following cases:
  - When using the camcorder for the very first time or after a long period of not using it.
  - After sudden or extreme changes in ambient temperature.
  - After changing the ISO speed/gain settings.
- The automatic black balance procedure will take approximately 40 seconds when the frame rate is set to PF24 or 24P.
- During the adjustment of the black balance, you may notice some irregular displays appear on the screen. This is not a malfunction.
- Resetting the camcorder's settings using the [ Other Functions] [Reset] [All Settings] or [Camera Settings] menu option will reset also the black balance adjustment. In such case, perform the procedure again.



## Recording Video

This section explains the recording basics. Before you begin recording, make a test recording first to check if the camcorder operates correctly. Record for approximately 15 minutes at the default bit rate, 24 Mbps (LPCM) ( 51). Should the camcorder fail to operate correctly, refer to *Troubleshooting* ( 148). For details on recording audio, refer to *Recording Audio* ( 74).

Operating modes: CAMERA MEDIA

### Preparing to Record

- 1 Attach the handle unit, grip unit, etc. as necessary to build the desired configuration ( 29).
- 2 Attach a charged battery pack to the camcorder ( 22).
- 3 Insert an SD card into an SD card slot ( 39).
  - Insert another SD card into the other SD card slot to use relay recording ( 41) or double slot recording ( 41).
- 4 Attach a lens ( 29).
- 5 Adjust the viewfinder.

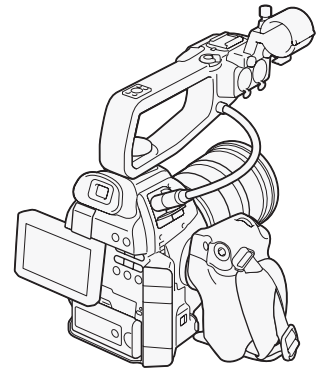

### Recording

- 1 Set the **POWER** switch to **CAMERA** ( 24).
  - The camcorder turns on in CAMERA mode and enters record pause mode.
  - At first, both SD card access indicators will illuminate in red. After a moment, the access indicator of the SD card slot selected for recording will turn green and the other access indicator will go out.

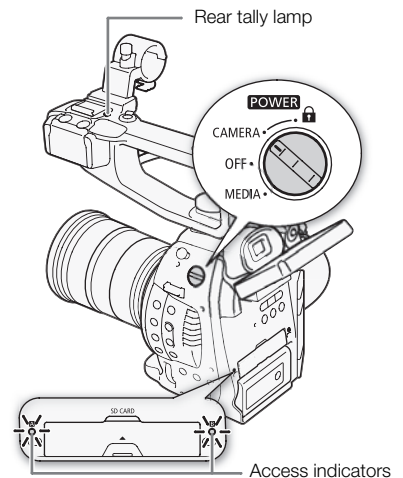

## 2 Press the START/STOP button to begin recording.

- Recording starts. The rear and front tally lamps illuminate and the recording indicator [●REC] appears at the top of the screen.
- You can use the START/STOP button on the grip unit, the camcorder's body (on the front, next to the lens mount) or the handle unit.

## 3 Press the START/STOP button to pause the recording.

- The clip\* is recorded to the SD card and the camcorder enters record pause mode. Both tally lamps will go out.

\* "Clip" refers to one movie unit from the point you press the START/STOP button to start recording until you press again to pause the recording.

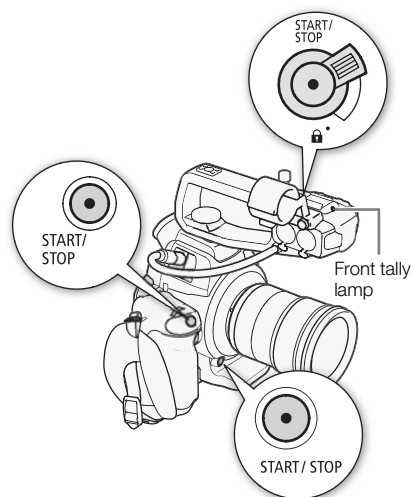

### ! IMPORTANT

- Observe the following precautions while either of the SD card access indicators is illuminated in red. Failure to do so may result in permanent data loss.
  - Do not open the SD card compartment cover and do not remove the SD cards.
  - Do not disconnect the power source or turn off the camcorder.
- Be sure to save your recordings regularly (📖 123), especially after making important recordings. Canon shall not be liable for any loss or corruption of data.

### i NOTES

- Depending on the shooting conditions, the camcorder may pick up and record the operation sounds of the lens (autofocus, aperture, image stabilization, etc.) or the cooling fan. In such case, using an external microphone is recommended to reduce the effect.
- A single clip can be recorded continuously for up to 12 hours. After 12 hours, the camcorder will automatically stop recording.
- You can use [👉 Other Functions] ➡ [Rec Review] (📖 83) to review part or all of the last clip recorded.
- You can use [👉 Other Functions] ➡ [Delete Last Clip] (📖 140) to delete the last clip recorded. However, you cannot delete the last clip if double slot recording is on.
- If [👉 Other Functions] ➡ [HDMI] ➡ [Rec Command] is set to [On] and you use the HDMI OUT terminal to connect the camcorder to a device compatible with HDMI recording commands, when you start or stop recording with the camcorder, the other device will also start or stop recording.
- When the camcorder switches from recording on one SD card to another during relay recording, the video will be recorded as two separate relay clips. With the supplied software, **Data Import Utility**, you can join relay clips recorded on two SD cards and save them on a computer (📖 123).
- The video (stream) file in a clip will be split approximately every 2 GB for clips with a long recording time. Even in such case, playback will be continuous. With the supplied software, **Data Import Utility**, you can join such split files into a single clip and save them on a computer (📖 123).

### Locking the Controls in Recording Mode

Once in **CAMERA** mode, you can set the **POWER** switch to **🔒** (key lock) to lock all the physical controls (buttons and switches) on the camcorder, save for the START/STOP button\*. This is useful in preventing settings from being changed due to inadvertently pressing one of the buttons. Return the **POWER** switch to the CAMERA position to reactivate the controls.

Additionally, the START/STOP button on the handle unit has its own lock lever to prevent its accidental operation. Turn the lock lever to **🔒** position to lock the START/STOP button\*\*. Return the lock lever to its original position to enable use of the START/STOP button again.

\* With the [**🔑** Other Functions] **▶** [Custom Function] **▶** [**🔒** START/STOP] setting, you can choose to lock all buttons, including the START/STOP button.

\*\*You can still use the START/STOP buttons on the camcorder and grip unit.

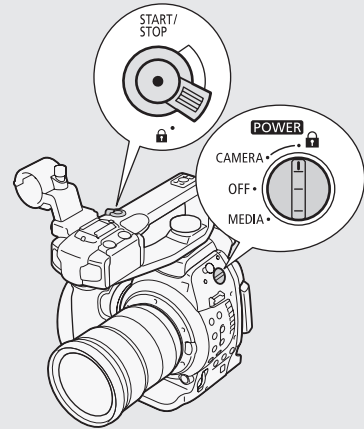

## Onscreen Displays

Refer to this section for an explanation of the various screen displays that appear in **CAMERA** mode. You can use the custom display function (☐ 102) to turn off individual onscreen displays if they are not required.

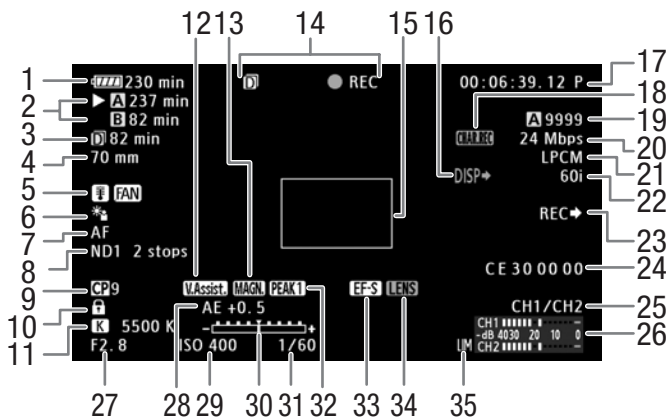

When displaying the date and time (☐ 26):



- |  |   |
|--|---|
| 1 Remaining battery time (☐ 49)  | 18 Onscreen displays recorded with the clip (☐ 102)     |
| 2 SD card status/available recording time (☐ 49)   | 19 Photo recording - available number of photos (☐ 125) |
| 3 Remaining recording time for double slot recording (☐ 41)/CONT: Total shot recording time during continuous recording (☐ 85) | 20 Bit rate (☐ 51)                                      |
| 4 Current focal length of an attached EF lens*   | 21 LPCM audio recording** (☐ 74)                        |
| 5 High temperature warning and cooling fan operation (☐ 37)  | 22 Frame rate (☐ 51)                                    |
| 6 Light metering (☐ 62)  | 23 HDMI recording command (☐ 140)                       |
| 7 Focus mode (☐ 65)  | 24 User bit (☐ 73)                                      |
| 8 ND filter (☐ 59)   | 25 Audio output channel (☐ 121)                         |
| 9 Custom picture (☐ 92)  | 26 Audio level meter (☐ 75, 78)                         |
| 10 Key lock (☐ 47)   | 27 Aperture value (☐ 60)                                |
| 11 White balance (☐ 63)  | 28 AE shift (☐ 61)                                      |
| 12 View assistance (☐ 50)  | 29 ISO speed/Gain (☐ 57)                                |
| 13 Magnification (☐ 67)  | 30 Exposure bar (☐ 61)                                  |
| 14 Recording operation (☐ 49)  | 31 Shutter speed (☐ 54)                                 |
| 15 One-shot AF's autofocus frame (☐ 65)  | 32 Peaking (☐ 67)                                       |
| 16 Onscreen displays superimposed on video output (☐ 120)  | 33 Sensor area correction for EF-S lenses (☐ 31)        |
| 17 Time code (☐ 70)  | 34 Lens error warning (☐ 151)                           |
|  | 35 Audio peak limiter (☐ 75, 78)                        |
|  | 36 Date/time (☐ 26)                                     |

\* The displayed value is an estimate.



\*\*Only displayed when [Other Functions] ➤ [Bit Rate] is set to [24 Mbps LPCM].

### NOTES



- You can press the DISP. button to switch the onscreen displays in the following sequence. Show all onscreen displays → show only onscreen markers\* → hide all onscreen displays.
  - \* Only when [LCD/VF Setup] ➤ [Markers] ➤ [Enable] is set to [On].







## 1 Remaining battery time

- The icon shows a rough estimate of the remaining charge as a percentage of the full charge of the battery pack. When a battery pack compatible with Intelligent System is used, the remaining recording/playback time of the battery pack is displayed, in minutes, next to the icon.
-  (in red).  
When  is displayed, replace the battery pack with a fully charged one.
- Depending on the conditions under which the camcorder and the battery pack are used, the actual battery charge may not be indicated accurately.

## 2 SD card status/available recording time

- The following indicates the SD card status.
  -  Can record on SD card
  -  No SD card or cannot record on SD card
- The SD card selected for recording is indicated with a  mark.

## 14 Recording operation

- |   |   |
|---|---|
|  | Recording   |
| STBY  | Record pause  |
|  | Pre-recording (after pressing the START/STOP button)  |
| PRE REC STBY  | Pre-recording (before pressing the START/STOP button) |
- When double slot recording ( 41) is activated, the  icon will appear to the left of the operation indicator.
  - During continuous recording mode ( 85), [CONT] will appear to the left of the operation indicator.

## Canon Log Gamma and CINEMA Preset

You can easily set the camcorder to use a number of preset picture-related settings especially designed with professional cinematography and motion picture production in mind. With the CINEMA preset settings, the gamma and color matrix ( 95) will be set to the advanced Canon Log setting, which makes full use of the newly developed image sensor to offer spectacular dynamic range. On the other hand, other custom picture settings will not be available.

Clips recorded using Canon Log gamma need to be processed in post-production. During post-production, you can apply a LUT (look-up table) to clips recorded using Canon Log gamma to view the clips with more natural colors. For details about available LUTs, visit your local Canon Web site.

---

 Camera Setup]

---

 CINEMA Locked]

---

[Off]

---

### 1 Open the [ CINEMA Locked] submenu.

 Camera Setup]  [ CINEMA Locked]

### 2 Select [On] and then press the joystick.

- All picture-related settings will be set according to the CINEMA preset values.
- [ LOCKED] appears on the left of the screen.

### Checking Clips Recorded with Canon Log Gamma (View Assistance)

When Canon Log gamma is used, the image displayed on the screen will appear darker than usual. You can use the view assistance function to display an image that approximates the one that would be obtained using a normal gamma setting. View assistance is only applied on the camcorder screen; it will not affect your recordings or the video signal output from the various terminals.

- 1 Open the [View Assist.] submenu.  
[ LCD/VF Setup] ➤ [View Assist.]
- 2 Select [On] and then press the joystick.
  - **V.Assist.** will appear on the lower left of the screen.

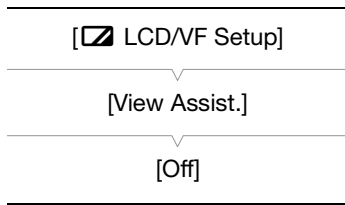

## Video Configuration: System Frequency, Bit Rate and Frame Rate

Before you record, select the bit rate and frame rate that best match your creative needs. The options available will depend on the system frequency selected: 59.94 Hz (former NTSC broadcast area) or 50.00 Hz (former PAL broadcast area). A single SD card can contain only one type of recordings.

### Selecting the System Frequency

Operating modes: **CAMERA** **MEDIA**

- 1 Open the [System Frequency] submenu.  
[Other Functions] ➤ [System Frequency]
- 2 Select [59.94 Hz] or [50.00 Hz] and then press the joystick.
  - The camcorder will reset and restart in the selected mode.

### Selecting the Bit Rate

The bit rate selected determines also the resolution (frame size) and audio recording mode of the recordings.

Operating modes: **CAMERA** **MEDIA**

- 1 Open the [Bit Rate] submenu to set the bit rate and resolution.  
[Other Functions] ➤ [Bit Rate]
- 2 Select the desired option and then press the joystick.
  - The selected bit rate will appear on the upper right of the screen.

### Selecting the Frame Rate

Operating modes: **CAMERA** **MEDIA**

- 1 Open the [Frame Rate] submenu to set the frame rate.  
[Other Functions] ➤ [Frame Rate]
- 2 Select the desired option and then press the joystick.
  - The selected frame rate will appear on the upper right of the screen.

### **i** NOTES

- A single SD card cannot be used to record clips at different system frequencies (50.00 Hz recordings/59.94 Hz recordings).
- For details on the signal output from each terminal, refer to *Video Output Configuration* (📖 117).
- Clips recorded using the 24P frame rate cannot be converted to standard definition using the camcorder.

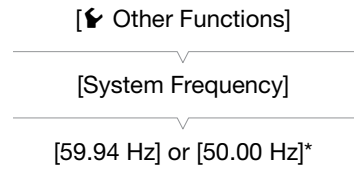

\* Depending on the country/region of purchase.

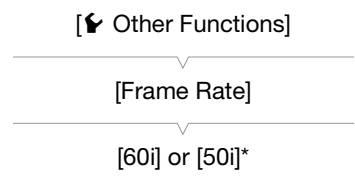
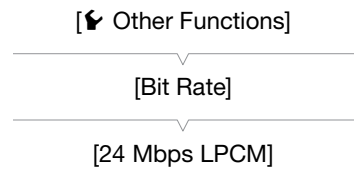

\* Depending on the country/region of purchase.

Available bit rate and frame rate settings

[Bit Rate] setting <sup>1</sup>	Resolution	Audio recording mode	[System Frequency] set to [59.94 Hz]	[System Frequency] set to [50.00 Hz]
			Available [Frame Rate] settings	
[24 Mbps LPCM]	1920 x 1080	Linear PCM, 2ch	[60i] [PF30] <sup>2</sup> [PF24] <sup>3</sup> [24P]	[50i] [PF25] <sup>4</sup>
[24 Mbps]		Dolby Digital, 2ch		
[17 Mbps]	1440 x 1080			
[7 Mbps]				

<sup>1</sup> The camcorder uses a variable bit rate (VBR).

<sup>2</sup> Shooting at 30 frames per second, progressive; recorded as 60i.

<sup>3</sup> Shooting at 24 frames per second, progressive; recorded as 60i.

<sup>4</sup> Shooting at 25 frames per second, progressive; recorded as 50i.

## Changing Main Camera Functions with the Joystick

You can adjust three main camera functions –shutter speed, white balance and ISO speed/gain– using only the joystick. This section will explain the basic operation for changing a value. For specific details about the functions please refer to the each function's section: shutter speed (📖 54), white balance (📖 63), ISO speed/gain (📖 57).

Operating modes: CAMERA MEDIA

### 1 Press the joystick.

- The white balance mode icon will be highlighted in orange. If no operation is performed for more than 6 seconds, the display will return to normal.
- Push the joystick left/right to move the highlight between the white balance mode icon, the ISO/gain value and the shutter value.

### 2 Push the joystick up/down to select the desired value (ISO speed, gain, shutter) or desired white balance mode and then press the joystick.

- The selected value will be set and the display will return to normal.

White balance (highlighted in orange)



Push the joystick (◀▶) to highlight the ISO/Gain value or the Shutter value

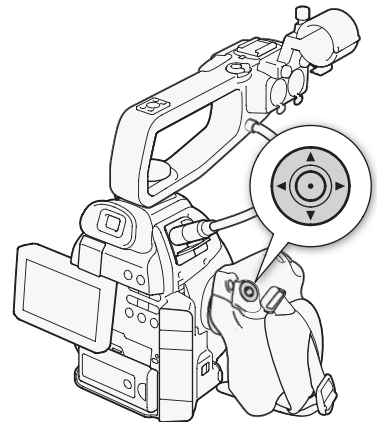

## Shutter Speed

Set the shutter speed based on the recording conditions. For example, you may want to set slower shutter speeds in darker environments. The camcorder offers the following 5 modes.

Operating modes:

[Speed]: Allows you to set the shutter speed (in fractions of a second). You can select the increment to use when adjusting the shutter speed between 1/3-stop and 1/4-stop increments.

[Angle]: You can set the shutter angle to determine the shutter speed.

[Clear Scan]: Set the frequency in order to record CRT computer monitors without displaying black bands or flicker on the screen.

[Slow]: You can set slower shutter speeds to obtain brighter recordings in places with insufficient lighting.

[Off]: The camcorder uses a standard shutter speed based on the frame rate.

### Available Shutter Speeds

The available shutter speeds vary depending on the frame rate.

Shutter mode		Frame rate (59.94 Hz recordings)		
		60i	PF30	PF24 / 24P
Off		1/60	1/30	1/24
Speed	1/3-stop increments	1/60, 1/80, 1/100, 1/125, 1/160, 1/200, 1/250, 1/320, 1/400, 1/500, 1/640, 1/800, 1/1000, 1/1250, 1/1600, 1/2000	1/30, 1/40, 1/50, 1/60, 1/80, 1/100, 1/125, 1/160, 1/200, 1/250, 1/320, 1/400, 1/500, 1/640, 1/800, 1/1000, 1/1250, 1/1600, 1/2000	1/25, 1/30, 1/40, 1/50, 1/60, 1/80, 1/100, 1/125, 1/160, 1/200, 1/250, 1/320, 1/400, 1/500, 1/640, 1/800, 1/1000, 1/1250, 1/1600, 1/2000
	1/4-stop increments	1/60, 1/75, 1/90, 1/100, 1/120, 1/150, 1/180, 1/210, 1/250, 1/300, 1/360, 1/420, 1/500, 1/600, 1/720, 1/840, 1/1000, 1/1200, 1/1400, 1/1700, 1/2000	1/30, 1/34, 1/40, 1/48, 1/60, 1/75, 1/90, 1/100, 1/120, 1/150, 1/180, 1/210, 1/250, 1/300, 1/360, 1/420, 1/500, 1/600, 1/720, 1/840, 1/1000, 1/1200, 1/1400, 1/1700, 1/2000	1/24, 1/30, 1/34, 1/40, 1/48, 1/60, 1/75, 1/90, 1/100, 1/120, 1/150, 1/180, 1/210, 1/250, 1/300, 1/360, 1/420, 1/500, 1/600, 1/720, 1/840, 1/1000, 1/1200, 1/1400, 1/1700, 1/2000
Angle		360°, 240°, 216°, 180°, 120°, 90°, 60°, 45°, 30°, 22.5°, 15°, 11.25°	360°, 240°, 216°, 180°, 120°, 108°, 90°, 60°, 45°, 30°, 22.5°, 15°, 11.25°	360°, 345.6°, 288°, 240°, 180°, 172.8°, 144°, 120°, 90°, 86.4°, 72°, 60°, 45°, 30°, 22.5°, 15°, 11.25°
Clear Scan		59.94 Hz to 250.27 Hz	29.97 Hz to 250.27 Hz	23.98 Hz to 250.27 Hz
Slow		1/4, 1/8, 1/15, 1/30	1/4, 1/8, 1/15	1/3, 1/6, 1/12

Shutter mode		Frame rate (50.00 Hz recordings)	
		50i	PF25
Off		1/50	1/25
Speed	1/3-stop increments	1/50, 1/60, 1/80, 1/100, 1/125, 1/160, 1/200, 1/250, 1/320, 1/400, 1/500, 1/640, 1/800, 1/1000, 1/1250, 1/1600, 1/2000	1/25, 1/30, 1/40, 1/50, 1/60, 1/80, 1/100, 1/125, 1/160, 1/200, 1/250, 1/320, 1/400, 1/500, 1/640, 1/800, 1/1000, 1/1250, 1/1600, 1/2000
	1/4-stop increments	1/50, 1/60, 1/75, 1/90, 1/100, 1/120, 1/150, 1/180, 1/210, 1/250, 1/300, 1/350, 1/400, 1/500, 1/600, 1/700, 1/800, 1/1000, 1/1200, 1/1400, 1/1600, 1/2000	1/25, 1/29, 1/33, 1/40, 1/50, 1/60, 1/75, 1/90, 1/100, 1/120, 1/150, 1/180, 1/210, 1/250, 1/300, 1/350, 1/400, 1/500, 1/600, 1/700, 1/800, 1/1000, 1/1200, 1/1400, 1/1600, 1/2000
Angle		360°, 300°, 240°, 180°, 150°, 120°, 90°, 60°, 45°, 30°, 22.5°, 15°, 11.25°	360°, 300°, 240°, 180°, 150°, 120°, 90°, 75°, 60°, 45°, 30°, 22.5°, 15°, 11.25°
Clear Scan		50.00 Hz to 250.78 Hz	25.00 Hz to 250.78 Hz
Slow		1/3, 1/6, 1/12, 1/25	1/3, 1/6, 1/12

## Changing the Shutter Mode

- 1 Open the shutter [Mode] submenu.  
[Camera Setup] ➤ [Shutter] ➤ [Mode]
- 2 Select the desired mode and then press the joystick.
  - If you selected [Speed] (the default value), you can continue the procedure to select the increment scale to use when adjusting the shutter speed.
- 3 Open the [Shutter Increment] submenu.  
[Camera Setup] ➤ [Shutter] ➤ [Shutter Increment]
- 4 Select [1/3 stop] or [1/4 stop] and then press the joystick.

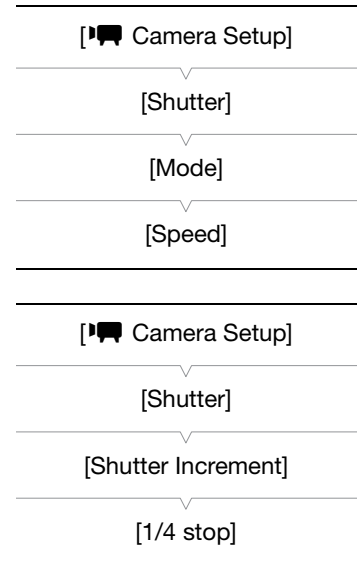

## Adjusting the Shutter Value

- 1 Press the SHUTTER button.
  - The current shutter value will be highlighted in orange.
- 2 Push the joystick up/down to select the desired shutter value (shutter speed, angle value or clear scan frequency) and then press the joystick.
  - The selected shutter value will be set and the display will return to normal.
  - You can also adjust the shutter value using only the joystick (📖 53).

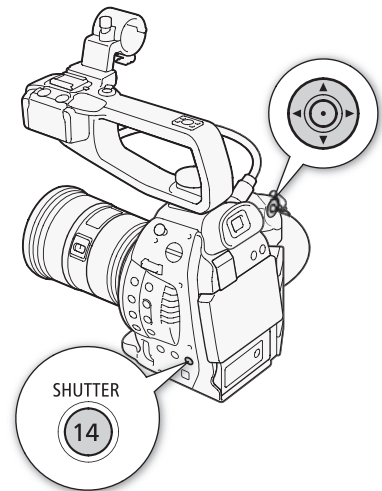

### **i** NOTES

- If you set an assignable button to [SHUTTER] (📖 89), you can press that button instead of the SHUTTER button to highlight the shutter value.

### Using Slow Shutter Mode

When recording in dark surroundings, you can obtain a brighter picture by using slow shutter mode. You can also use this mode when you wish to add certain effects to your recordings, such as blurring the background during panning shots or recording a moving subject with an afterimage trail.

- Image quality may not be as good as when using faster shutter speeds in brighter surroundings.

**i** NOTES

- Closing down the aperture when recording under bright conditions may cause the picture to appear soft or out of focus. To avoid the loss of sharpness due to diffraction, use a faster shutter speed, a denser ND filter (📖 59) or open up the aperture.
- When the shutter mode is set to [Slow], bright red, green or blue dots may appear on the screen. In such case, use a faster shutter speed or select a lower ISO speed or gain value (📖 57).
- Even when using the [C7: EOS Std.] preset custom picture file, if you set the camcorder to a certain shutter speed, you may not get the exactly the same image brightness as you would on an EOS digital SLR camera set to the same shutter speed.
- When an optional RC-V100 Remote Controller is connected to the camcorder, you can change the shutter mode with the remote controller's SHUTTER SELECT button.

### Flicker Reduction

You can perform the following procedure to have the camcorder automatically detect and reduce flicker.

1 Open the [Flicker Reduction] submenu.

[🗨 Camera Setup] ➡ [Flicker Reduction]

2 Select [Automatic] and then press the joystick.

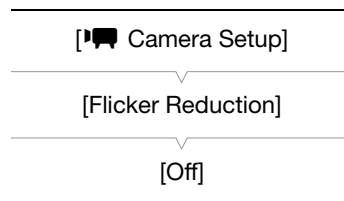

**i** NOTES

- When recording under artificial light sources such as fluorescent, mercury or halogen lamps, the screen may flicker depending on the shutter speed. You may be able to avoid flicker by setting the shutter mode to [Speed] and the shutter speed to a value matching the frequency of the local electrical system: 1/50\* or 1/100 for 50 Hz systems, 1/60 or 1/120 for 60 Hz systems.

\* May not be available depending on the frame rate.



## ISO Speed/Gain

Depending on the shooting conditions you may want to adjust the brightness of the image. You can do so by changing the ISO speed or gain value to adjust the sensitivity of the sensor.

Operating modes: CAMERA MEDIA

### Available ISO speed and gain settings

	Increment	Normal range	Extended range <sup>1</sup>
ISO Speed	1-stop increments	320 <sup>2</sup> , 400, 800, <850> <sup>3</sup> , 1600, 3200, 6400, 12800, 20000 <sup>2, 4</sup>	25600, 51200, 80000 <sup>2</sup>
	1/3-stop increments	320, 400, 500, 640, 800, <850> <sup>3</sup> , 1000, 1250, 1600, 2000, 2500, 3200, 4000, 5000, 6400, 8000, 10000, 12800, 16000, 20000	25600, 32000, 40000, 51200, 64000, 80000
Gain	Normal	-6 dB, -3 dB, 0 dB, 3 dB, 6 dB, 9 dB, 12 dB, 15 dB, 18 dB, 21 dB, 24 dB, 27 dB, 30 dB	33 dB, 36 dB, 39 dB, 42 dB
	Fine	0 dB to 24 dB in 0.5 dB increments	–

<sup>1</sup> Settings available only when [Camera Setup] ➤ [ISO/Gain] ➤ [Extended Range] is set to [On].

<sup>2</sup> The minimum and maximum ISO speeds are available even when the 1-stop increment scale is selected.

<sup>3</sup> ISO speed required for a suitable dynamic range for Canon Log gamma. Equivalent to a gain value of 2.5 dB.

<sup>4</sup> This value is only available when [Extended Range] is set to [Off].

## Changing the ISO Speed or Gain Settings

1 Open the ISO Speed/Gain [Select] submenu.

[Camera Setup] ➤ [ISO/Gain] ➤ [Select]

2 Select [ISO] or [Gain] and then press the joystick.

**If you selected [ISO] (the default value):**

3 Open the [ISO Increment] submenu to select the increment to use when adjusting the ISO speed.

[Camera Setup] ➤ [ISO/Gain] ➤ [ISO Increment]

4 Select [1 stop] or [1/3 stop] and then press the joystick.

**If you selected [Gain]:**

3 Open the [Gain] submenu to select the increment to use when adjusting the gain.

[Camera Setup] ➤ [ISO/Gain] ➤ [Gain]

4 Select [Normal] (3-dB increment) or [Fine] (0.5-dB increment) and then press the joystick.

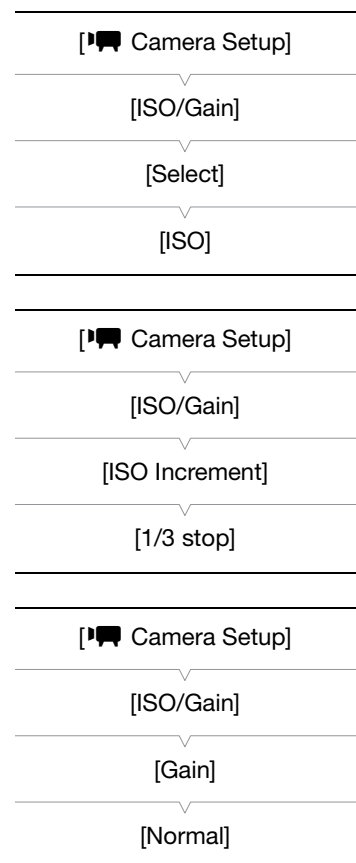

## Adjusting the ISO/Gain Value

### 1 Press the ISO/GAIN button.

- The current ISO/gain value will be highlighted in orange.

### 2 Push the joystick up/down to select the desired ISO speed or gain value and then press the joystick.

- The selected ISO/gain value will be set and the display will return to normal.
- You can also adjust the ISO/gain value using only the joystick (📖 53).

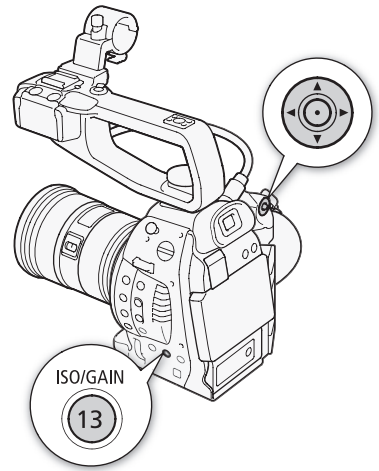

### **i** NOTES

- When high ISO speeds or gain levels are set, the picture may flicker slightly.
- When high ISO speeds or gain levels are set, bright red, green or blue dots may appear on the screen. In such case, use a faster shutter speed (📖 54) or select a lower ISO speed or gain value.
- When the ISO speed or gain level is changed, some noise may appear momentarily on the screen. Do not adjust the ISO speed/gain level while recording.
- When an optional RC-V100 Remote Controller is connected to the camcorder, you can adjust the ISO speed or gain value with the remote controller's ISO/GAIN ▲/▼ buttons.

## ND Filter

Using the ND filters allows you keep the aperture within an appropriate range when recording in bright surroundings\*.

\* Closing down the aperture when recording under bright conditions may cause the picture to appear soft or out of focus. To avoid the loss of sharpness due to diffraction, use a denser ND filter or a faster shutter speed (☞ 54).

Operating modes: CAMERA MEDIA

Turn the ND FILTER dial toward the + or - direction to select the desired ND filter setting.

- Turning the dial up (in the + direction) will change the ND filter setting in the following order: [ND1 2 stops] → [ND2 4 stops] → [ND3 6 stops] → ND filter off. (Turning the dial down (in the - direction) will cycle through the settings in reverse order.)

### **i** NOTES

- Depending on the scene, the color may change when turning the ND filter on/off. Setting a custom white balance (☞ 63) may be effective in such case.

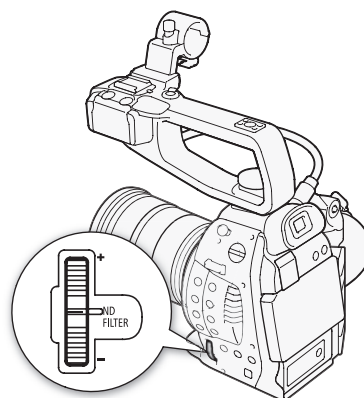

## Adjusting the Aperture

You can affect the brightness of your recordings or change the depth of field by adjusting the aperture. For example, use a small aperture value for a shallow depth of field that isolates the subject in focus and nicely blurs the background. You can have the camcorder automatically set the aperture according to the brightness of the subject, or adjust the aperture manually.

Operating modes: CAMERA MEDIA

### Automatic Aperture

When an EF-S 18-135mm f/3.5-5.6 IS STM or EF-S 18-55mm f/3.5-5.6 IS STM lens is attached to the camcorder, you can have the camcorder automatically adjust the aperture (f/stop).

1 Open the aperture [Mode] submenu.

[Camera Setup] ➤ [Iris] ➤ [Mode]

2 Select [Automatic] and then press the joystick.

- When the camcorder is set to automatic aperture, **A** will appear on the screen next to the aperture value.

#### **i** NOTES

- If you set an assignable button to [Iris Mode] (89), you can press the button to toggle between the [Automatic] and [Manual] settings.

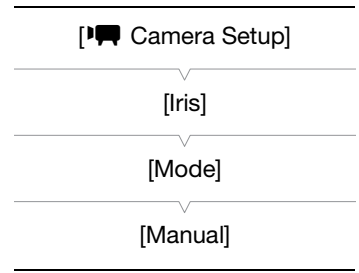

### Manual Aperture Control

You can adjust the aperture value of most EF lenses using the control dial on the grip unit. Available aperture values will vary depending on the EF lens attached to the camcorder.

By default, the camcorder is set to manual aperture. If the aperture mode was changed, set [Camera Setup] ➤ [Iris] ➤ [Mode] to [Manual] (60) in advance.

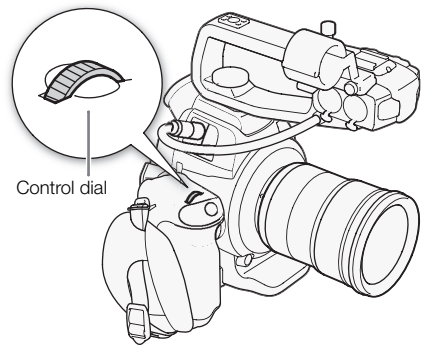

### Selecting the Increment Scale to Use When Adjusting the Aperture

1 Open the [Iris Increment] submenu.

[Camera Setup] ➤ [Iris] ➤ [Iris Increment]

2 Select [1/2 stop], [1/3 stop] or [Fine] and then press the joystick.

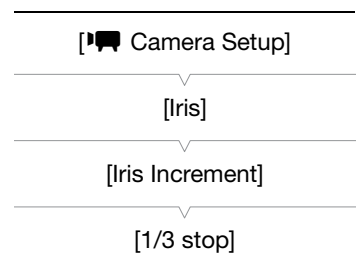

### Changing the Aperture Value

Turn the control dial to adjust the aperture.

- The selected aperture value will appear on the lower left of the screen.
- When [Camera Setup] ➤ [Iris] ➤ [Iris Increment] is set to [Fine], the actual increments will be smaller than 1/3 stop but the onscreen display will show the closest 1/3-stop aperture value.

## **i** NOTES

- When using an EF lens with no lens contacts, such as a Canon Cinema lens, you cannot adjust the aperture using the camcorder. Adjust the aperture using the lens.
- You can use the [**Other Functions**] **➤** [Custom Function] **➤** [Grip Ctrl Dial Dir.] setting (📖 102) to change the direction of the adjustment when you turn the control dial.
- If you are using an EF lens that can correct the aperture value according to the position of the zoom, you can use the [**Camera Setup**] **➤** [Iris] **➤** [Zoom-Iris Correct.] setting to select whether to maintain the f/stop as you zoom.
- If you set an assignable button to [Iris +] or [Iris -] (📖 89), you can press the button to respectively open up or close the aperture.
- When an optional RC-V100 Remote Controller is connected to the camcorder, you can adjust the aperture with the remote controller's IRIS dial. At default settings, turn the dial right to open up the aperture (smaller F value) and left to close the aperture (larger F value).

## Momentary Automatic Aperture - Push Auto Iris

During manual aperture, you can press the PUSH AUTO IRIS button to have the camcorder temporarily take control and automatically adjust the aperture (f/stop) for an optimal exposure.

Hold down the PUSH AUTO IRIS button.

- The camcorder will automatically adjust the aperture to obtain optimal exposure. As long as you hold the button pressed down, **A** will appear on the screen next to the aperture value.
- When you release the button, the selected f/stop will be set as the aperture value. Automatic aperture mode will end and the **A** icon next to the aperture value will disappear.

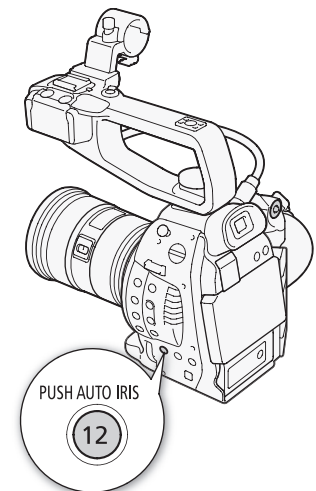

## Exposure Compensation - AE Shift

Use AE shift to compensate the exposure that was set using automatic aperture, in order to darken or lighten the image. You can select from 15 available AE shift levels.

1 Open the [AE Shift] submenu.

[**Camera Setup**] **➤** [AE Shift]

2 Select an AE shift level and then press the joystick.

### Available AE Shift Levels

+2.0	+1.5	+1.25	+1.0	+0.75	+0.5	+0.25	±0
-0.25	-0.5	-0.75	-1.0	-1.25	-1.5	-2.0	

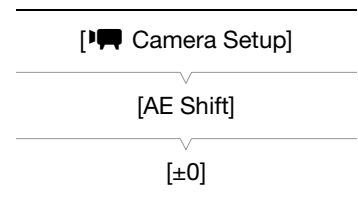

## **i** NOTES

- You can also set the AE shift level by turning the control dial while holding the PUSH AUTO IRIS button pressed down.
- If you set an assignable button to [AE Shift +] or [AE Shift -] (📖 89), you can press the button to adjust the AE shift level.
- When you use automatic aperture (including push auto iris) after setting an AE shift level, the camcorder will try to adjust the aperture (f/stop) so as to achieve the AE shift level that was set rather than optimal aperture.

**The Exposure Bar**

You can use the exposure bar as a reference when adjusting the aperture or shutter speed or when compensating the exposure using AE shift. The ▼ on top of the exposure bar indicates optimal exposure without any shift (AE±0); the scale markings indicate the deviation from optimal exposure in 1/2 EV increments. The indicator inside the exposure bar represents the current exposure. When the difference between current and optimal exposure is larger than ±2 EV, the indicator will flash at the edge of the exposure bar. Optimal exposure will change depending on the light metering mode (☞ 62) used.

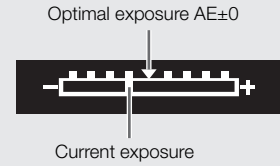

**Light Metering Mode**

Select the light metering mode to match the recording conditions. Using the appropriate setting will ensure that the camcorder obtains the most suitable exposure level when automatic aperture is used.

1 Open the [Light Metering] submenu.

[Camera Setup] ➔ [Light Metering]

2 Select the desired option and then press the joystick.

- The icon of the selected mode appears on the left of the screen.

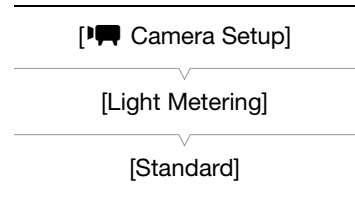

**Options**

[Backlight] \*: Suitable when recording backlit scenes.

[Standard]: Averages the light metered from the entire screen, giving more weight to the subject in the center.



[Spotlight] : Use this option when recording a scene in which only a certain part of the picture is lit, for example, when the subject is lit by a spotlight.



**NOTES**

- If you set an assignable button to [Backlight] or [Spotlight] (☞ 89), you can press the button to change the light metering mode.

## White Balance

The camcorder uses an electronic white balance process to calibrate the picture and ensure accurate colors under different lighting conditions. There are 4 methods of setting the white balance.

**Custom white balance:** You can use a white object to establish the white balance and set it to one of two custom white balance positions, A or B.







**Preset white balance:** Set the white balance to  (daylight) or  (incandescent lamp). Preset white balance settings can be further fine-tuned within a range of -9 to 9.

**Set color temperature:** Allows you to set the color temperature between 2,000 K and 15,000 K.

**Auto white balance:** The camcorder automatically adjusts the white balance to the optimal level.

Operating modes: CAMERA MEDIA

### NOTES



- The [Color Matrix] ( 99) and [White Balance] ( 99, 101) custom picture settings take precedence over the white balance settings.
- You can use the [ Other Functions]  [Custom Function]  [Shockless WB] setting ( 102) to make the transition look smoother when you change the white balance settings.
- When an optional RC-V100 Remote Controller is connected to the camcorder, you can adjust the white balance with the remote controller's A button, B button, PRESET button and  button.

## Custom White Balance

### 1 Press the WB button.

- The white balance mode icon will be highlighted in orange.
- You can also select the white balance mode icon using only the joystick ( 53).



### 2 Push the joystick up/down to select the A or B icon.

- If a custom white balance has been stored previously, press the joystick to set the stored custom white balance. You do not need to perform the rest of the procedure.
- If a custom white balance has not yet been stored, the custom white balance icon A or B and default value (5,500 K) will flash slowly. Continue the procedure to establish the custom white balance.

### 3 Point the camcorder at a white object so that it fills the whole screen.

- Use the same lighting conditions you plan to use when recording.

### 4 Press the button.

- The A or B icon will flash quickly.
- Make sure the white object fills the screen until the procedure is completed.
- After the icon stops flashing, the procedure is completed. The setting is retained even if you turn off the camcorder.

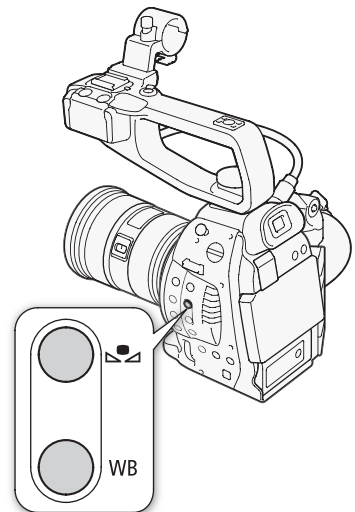

### NOTES

- Readjust the custom white balance if the light source or ND filter setting changes.
- Very rarely and depending on the light source,  may keep flashing (it will change to a slow flashing). The result will still be better than with the auto white balance.

## Preset White Balance Settings

### 1 Press the WB button.

- The white balance mode icon will be highlighted in orange.
- You can also select the white balance mode icon using only the joystick (📖 53).

### 2 Push the joystick up/down to select the ☀️ or 🌙 icon and then press the joystick.

- If necessary, instead of pressing the joystick, you can continue the procedure to fine-tune the preset settings within a range of -9 to 9.

### 3 Press the 📏 button.

- The adjustment value  $\pm 0$  will appear next to the white balance icon, highlighted in orange.

### 4 Push the joystick up/down to change the adjustment value and then press the joystick.

- The selected adjustment value will be set and will appear next to the white balance icon.

## Color Temperature Setting

### 1 Press the WB button.

- The white balance mode icon will be highlighted in orange.
- You can also select the white balance mode icon using only the joystick (📖 53).

### 2 Push the joystick up/down to select the **K** icon.

### 3 Press the 📏 button.

- The default color temperature value (5,500 K) will be highlighted in orange.

### 4 Push the joystick up/down to change the color temperature value and then press the joystick.

- The selected color temperature will be set and will appear next to the white balance icon.

## Auto White Balance

The camcorder constantly adjusts the white balance automatically to achieve an optimal level. The camcorder will adjust the white balance if the light source changes.

### 1 Press the WB button.

- The white balance mode icon will be highlighted in orange.
- You can also select the white balance mode icon using only the joystick (📖 53).

### 2 Push the joystick up/down to select the **A** icon and then press the joystick.

- The **A** icon appears next to the color temperature display.

### NOTES

- Custom white balance may provide better results in the following cases:
  - Changing lighting conditions
  - Close-ups
  - Subjects in a single color (sky, sea or forest)
  - Under mercury lamps and certain types of fluorescent and LED lights



## Adjusting the Focus

The camcorder offers three ways to focus.

**Manual focus:** Turn the focus ring on the attached lens to adjust the focus. The camcorder offers several focus assistance functions to help you focus more accurately when using the manual focus.

**One-shot AF:** With the lens's focus mode switch set to AF, press and hold the ONE-SHOT AF button to let the camcorder focus automatically on the subject at the center of the screen.

**Continuous AF\*:** Set the lens's focus mode switch to AF to have the camcorder continuously focus on the subject.

\* Only when an EF-S 18-135mm f/3.5-5.6 IS STM or EF-S 18-55mm f/3.5-5.6 IS STM lens is attached to the camcorder.

Operating modes: CAMERA MEDIA

### Manual Focus

Turn the focus ring to adjust the focus.

#### NOTES

- In most cases, you can use the focus ring on the lens to adjust the focus even when the focus mode switch is set to AF (autofocus). However, depending on the lens, the focus ring may be disabled in AF mode. In such case, set the focus mode switch to MF.
- If you operate the zoom after focusing manually, the focus on the subject may be lost.
- When adjusting the focus, be careful not to touch the front of the lens or moving parts on the lens except for the focus ring.
- If you focus manually and then leave the camcorder with the power turned on, the focus on the subject may be lost after a while. This possible slight shift in focus is a result of the internal temperature rising in the camcorder and lens. Check the focus before resuming shooting.
- When an optional RC-V100 Remote Controller is connected to the camcorder, you can adjust the focus with the remote controller's FOCUS dial. At default settings, turn the dial right to focus farther and left to focus nearer.

### One-Shot AF

**1 Set the focus mode switch on the lens to AF in advance.**

- Refer to the instruction manual of the lens used.
- [AF] will appear on the left of the screen.

**2 Press and hold the ONE-SHOT AF button.**

- The AF frame will appear at the center of the screen and the camcorder will focus automatically. When correct focus has been achieved, the AF frame turns green.
- If the camcorder cannot focus automatically, the AF frame will turn red.
- The AF frame will disappear when you release the ONE-SHOT AF button.

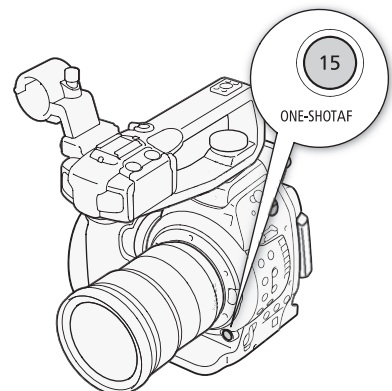

## Continuous AF

When a compatible lens is attached to the camcorder, you can have the camcorder focus automatically.

### 1 Set the focus mode switch on the lens to AF in advance.

- Refer to the instruction manual of the lens used.
- [AF] will appear on the left of the screen.

### 2 Open the [AF Mode] submenu.

[ Camera Setup]  [AF Mode]

### 3 Select [Continu.] and then press the joystick.

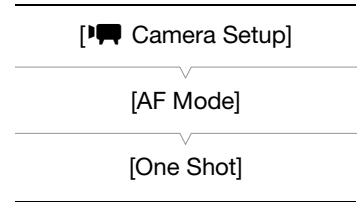

## Using the Focus Assistance Functions

In order to focus more accurately, you can use two focus assistance functions – peaking, which creates a clearer contrast by emphasizing the outlines of the subject, and magnification, which enlarges the image on the screen. You can use both functions simultaneously for greater effect.

You can also use the [Other Functions] [Custom Function] [F. Assist. B&W] setting (102) to switch the screen to black & white while using the focus assistance functions.

### Peaking

The camcorder offers two peaking levels. Select the level before activating peaking.

- Press the PEAKING button.
  - The peaking icon (PEAK1 or PEAK2) appears at the lower center of the screen and the outlines in the image will be emphasized, depending on the focus.
  - Press the button again to turn off peaking.
  - Alternatively, you can use the [LCD/VF Setup] [Peaking] setting to turn peaking on and off.
- Open the [Select] submenu (under [Peaking]) to select the peaking level.
  - [LCD/VF Setup] [Select] (under [Peaking])
- Select the desired level and then press the joystick.

### Magnification

- Press the MAGN. button.
  - MAGN. appears at the lower center of the screen and the center of the screen is magnified approximately 2 times\*.
- If necessary, use the joystick (▲▼◀▶) to move around the orange frame and check other parts of the image.
  - Set the focus mode switch on the lens to MF in advance.
  - You can move the orange frame 5 steps vertically or horizontally. Press the CANCEL button to return the magnification frame to the center position.
- Press the MAGN. button again to cancel the magnification.

\* The magnification that appears on the LCD screen and on the viewfinder screen is different. The magnification also differs based on the video configuration.

### NOTES

- Peaking/Magnification appears only on the camcorder screen. It will not appear on an external monitor connected to the camcorder and will not affect your recordings.
- You can use the [LCD/VF Setup] [Peaking 1] and [Peaking 2] settings to set the color, gain and frequency of the two peaking levels independently of each other.
- The camcorder features professional video scopes (81). You can display the edge monitor to help you focus even more accurately.
- You can use peaking together with the edge monitor. In such case, The gain and frequency of the peaking effect will be adjusted automatically according to the gain settings of the edge monitor.
- You can use the [Other Functions] [Custom Function] [Magn. Add. Disp.] setting (102) to select an additional assistance display (peaking or the edge monitor) to also be displayed when magnification is used.

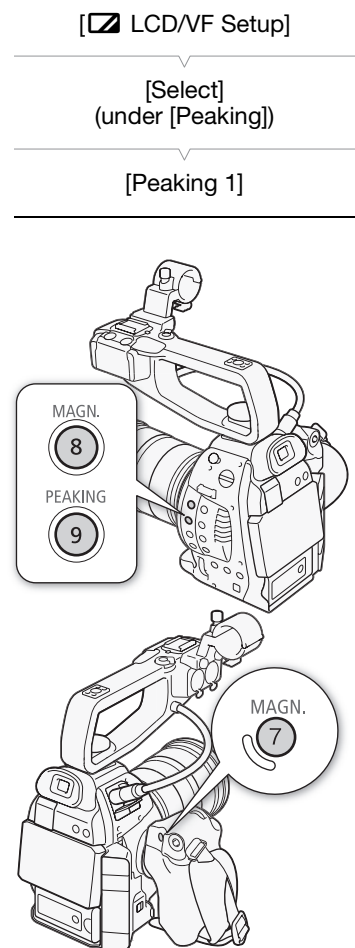

## Onscreen Markers and Zebra Patterns

Using onscreen markers allows you to make sure your subject is correctly framed and is within the appropriate safe area. The zebra patterns help you identify areas that are overexposed. The onscreen markers and zebra pattern will not affect your recordings.

Operating modes: CAMERA MEDIA

### Displaying Onscreen Markers

The camcorder offers 5 types of onscreen markers. You can display multiple onscreen markers simultaneously.

1 Open the [Markers] submenu.

[ LCD/VF Setup] ➔ [Markers]

2 Select a marker you wish to display, select [White] or [Gray] and then press the joystick.

- Select [Off] to turn off the selected marker.
- You can display multiple markers simultaneously. Repeat this step as necessary.
- If you selected [Safety Zone] or [Aspect Marker], continue to step 3. Otherwise, you can skip to step 4.

3 Select [Safety Zone Area] or [Aspect Ratio], select the desired option and then press the joystick.

4 Select [Enable], select [On] and then press the joystick to enable the onscreen markers.

- All of the selected onscreen markers will be displayed.
- Select [Off] to turn off all onscreen markers.

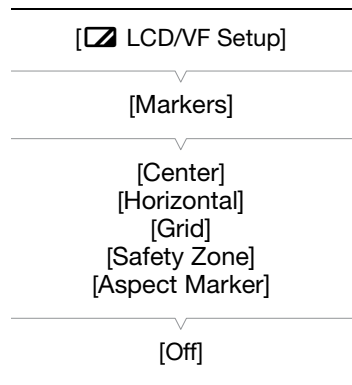

#### Options

- [Center]: Displays a small marker that indicates the center of the screen.
- [Horizontal]: Displays a horizontal line to help you compose level shots.
- [Grid]: Displays a grid that allows you to frame your shots correctly (horizontally and vertically).
- [Safety Zone]: Displays indicators that show various safe areas, such as the action safe area and text safe area. Available options for [Safety Zone Area] are [80%], [90%], [92.5%] and [95%].
- [Aspect Marker]: Displays markers that indicate various aspect ratios to help you keep your shot within that area. Available options for [Aspect Ratio] are [4:3], [13:9], [14:9], [1.66:1], [1.75:1], [1.85:1] and [2.35:1].

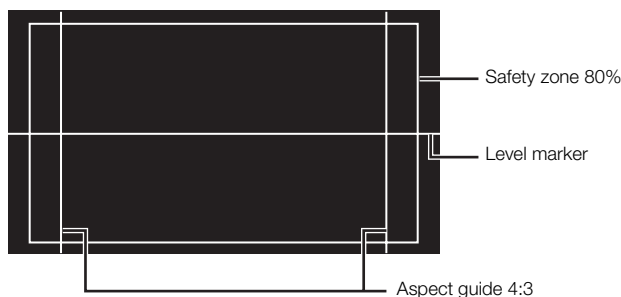

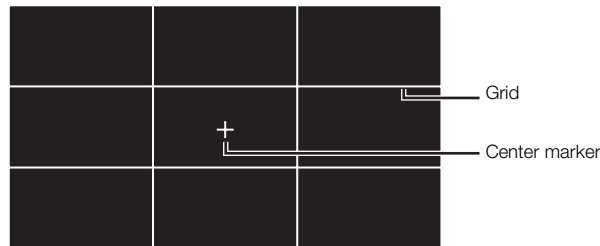

### **i** NOTES

- You can turn off all other onscreen displays, leaving only the onscreen markers (📖 48).
- If you set an assignable button to [Markers] (📖 89), you can press the button to turn the onscreen markers on and off.

## Displaying Zebra Patterns

The camcorder has a zebra pattern feature that shows black and white diagonal stripes over areas that are overexposed. This is displayed only on the screen and will not affect your recordings. There are two types of zebra patterns and you can display both simultaneously. Zebra 1 lets you identify areas within a certain range ( $\pm 5\%$  of a specified level) while zebra 2 lets you identify areas that are over a specified level. When you display both simultaneously and they overlap, only zebra 1 will be displayed in those areas.

- 1 Open the zebra pattern [Select] submenu.  
[ LCD/VF Setup] ➤ [Select] (under [Zebra])
- 2 Select [Zebra 1], [Zebra 2] or [Zebra 1&2] and then press the joystick.
- 3 Open the zebra level submenu.  
[ LCD/VF Setup] ➤ [Zebra 1 Level] or [Zebra 2 Level]
- 4 Select a zebra level and then press the joystick.
- 5 Press the ZEBRA button to activate the selected zebra pattern.
  - Alternatively, before closing the menu, you can also select [Zebra], select [On] and then press the joystick.

### **i** NOTES

- You can use the [ LCD/VF Setup] ➤ [Zebra HD Output] setting to display the zebra pattern on an external monitor connected to the HDMI OUT terminal (HD output only).

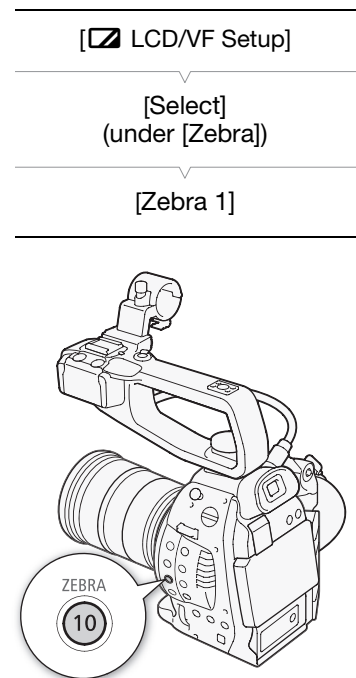

## Setting the Time Code

The camcorder generates a time code signal and embeds it in your recordings. You can output the time code along with video output from the HDMI OUT terminal (📖 140). For 59.94 Hz recordings, you can also select between a drop frame and non-drop frame time code.

Operating modes: CAMERA MEDIA

### Selecting the Running Mode

You can select the running mode of the camcorder's time code.

1 Open the time code [Mode] submenu.

[00:00 TC/UB Setup] ➤ [Time Code] ➤ [Mode]

2 Select the desired option and then press the joystick.

- If you selected [Regen.], you do not need to perform the rest of this procedure. If you selected [Preset] and would like to set the time code's initial value, see the following section *Setting the Time Code's Initial Value*.

3 After you select [Preset], open the time code [Run] submenu.

[00:00 TC/UB Setup] ➤ [Time Code] ➤ [Run]

4 Select the desired option and then press the joystick.

#### Options

[Preset]: The time code starts from an initial value you can select in advance. The default initial time code is 00:00:00.00. The time code's running mode depends on the [Run] setting.

[Rec Run]: The time code runs only while recording so clips recorded consecutively on the same SD card will have continuous time codes.

[Free Run]: The time code starts running the moment you press the joystick to select this option and keeps running regardless of the camcorder's operation.

[Regen.]: The camcorder will read the selected SD card and the time code will continue from the last recorded time code on the SD card. The time code runs only while recording so clips recorded consecutively on the same SD card will have continuous time codes.

### Setting the Time Code's Initial Value

If you set the time code mode to [Preset], you can set the initial value of the time code.

1 Open the time code [Setting] submenu.

[00:00 TC/UB Setup] ➤ [Time Code] ➤ [Setting]

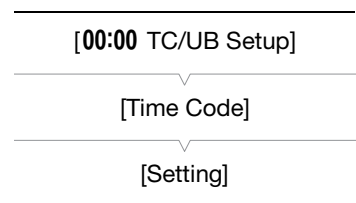
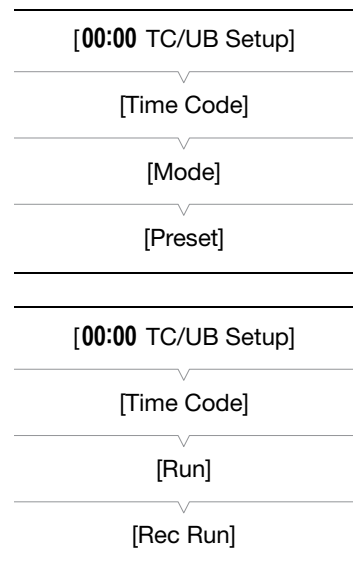

- 2 Select [Set] and then press the joystick.
  - The time code setting screen appears with an orange selection frame indicating the hours.
  - To reset the time code to [00:00:00.00], select [Reset] instead. If the running mode is set to [Free Run], the time code will be reset the moment you press the joystick and keep running continuously from 00:00:00.00.
- 3 Push the joystick up/down to set the hours and then press the joystick to move to the minutes.
- 4 Change the rest of the fields (minutes, seconds, frame) in the same way.
  - Press the CANCEL button to close the screen without setting the time code.
- 5 Select [Set] and then press the joystick to close the screen.
  - If the running mode is set to [Free Run], the time code will start running from the selected time code the moment you press the joystick.

## Selecting Drop or Non-Drop Frame

When [ Other Functions] [System Frequency] is set to [59.94 Hz], you can select between a drop frame (DF) or non-drop frame (NDF) time code, depending on how you plan to use your recordings.

In the following cases, the time code is set to non-drop frame (NDF) and cannot be changed.

- [ Other Functions] [System Frequency] is set to [50.00 Hz]
- [ Other Functions] [System Frequency] is set to [59.94 Hz] and the frame rate is set to 24P

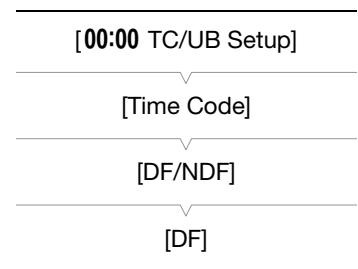

- 1 Open the [DF/NDF] submenu.

[00:00 TC/UB Setup] [Time Code] [DF/NDF]

- 2 Select [DF] or [NDF] and then press the joystick.

- The time code display will differ depending on the setting. When you select [DF], the time code will appear as [00:00:00.00]; when you select [NDF], it will appear as [00:00:00:00].

## Putting the Time Code Display on Hold



If you set an assignable button to [Time Code Hold] ( 89), you can press the button to freeze the display of the time code. While the time code display is put on hold, [H] will appear on the screen next to the time code. The time code continues to run normally while the time code display is on hold. When you resume the time code display, the current time code will be displayed.

### About the Time Code Display

An icon may appear next to the time code depending on the operation. Refer to the following table.

Icon	Description
R	The time code is set to [Regen].
P	The time code is set to [Preset] and the running mode is set to [Rec Run].
F	The time code is set to [Preset] and the running mode is set to [Free Run].
H	Time code display is on hold.
No icon	Time code during clip playback.

 NOTES

- When the frame rate is set to 24P, the frames value in the time code runs from 0 to 23. When the frame rate is set to 50i or PF25, it runs from 0 to 24. With other frame rates, it runs from 0 to 29.
- When pre-recording mode is activated, [Free Run] is set automatically and cannot be changed.
- When you mix drop frame and non-drop frame time codes, there might be a discontinuity in the time code at the point where the recording starts.
- As long as the built-in rechargeable lithium battery is charged and you selected the [Free Run] running mode, the time code continues to run even if you disconnect all other power sources. However, this is less accurate than when the camcorder is on.
- If you set an assignable button to [Time Code] ( 89), you can press the button to open the [00:00 TC/UB Setup]  [Time Code] submenu.



## Setting the User Bit

The user bit display can be selected from the date or the time of recording, or an identification code consisting of 8 characters in the hexadecimal system. There are sixteen possible characters: the numbers 0 to 9 and the letters A to F.

Operating modes: CAMERA MEDIA

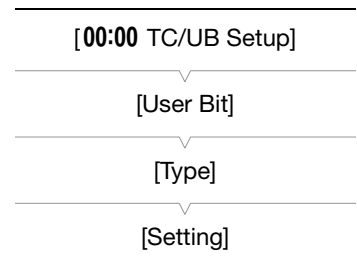

### 1 Open the user bit [Type] submenu.

[00:00 TC/UB Setup] ➤ [User Bit] ➤ [Type]

### 2 Select the desired user bit type and then press the joystick.

- Select [Setting] to set your own identification code, [Time] to use the time as user bit, or [Date] to use the date as the user bit.
- If you selected [Time] or [Date], you do not need to perform the rest of the procedure. If you selected [Setting], continue the procedure to set the identification code.

### 3 Select [Set] and then press the joystick.

- The user bit setting screen appears with an orange selection frame on the leftmost digit.
- To reset the user bit to [00 00 00 00], select [Reset] instead.

### 4 Push the joystick up/down to select the first character and then press the joystick to move to the next digit.

- Change the rest of the digits in the same way.
- Press the CANCEL button to close the screen without setting the user bit.

### 5 Select [Set] and then press the joystick to close the screen.

#### NOTES

- **User bit output:** The user bit will be output along with the video output from the HDMI OUT terminal. In CAMERA mode, when the frame rate is set to PF24 or 24P, you can output the user bit as 2:3 pulldown data by setting [00:00 TC/UB Setup] ➤ [User Bit] ➤ [Output Mode] to [Pulldown].

## Recording Audio

You can record audio using the built-in stereo microphone\*, commercially available microphones (XLR terminal\*, MIC terminal) or line input (XLR terminal\*). Using the XLR terminals, you can select the audio input independently for channel 1 and channel 2.

When the bit rate is set to [24 Mbps LPCM], you can enjoy two-channel linear PCM audio recording with a sampling frequency of 48 kHz. LPCM audio playback is also available for clips recorded with that bit rate.

\* Only available when the handle unit is attached to the camcorder.

Operating modes: CAMERA MEDIA

### Connecting an External Microphone or External Audio Input Source to the Camcorder

In order to use the microphone holder and XLR terminals, the handle unit must be attached to the camcorder. Follow the procedure below to attach a microphone (refer also to the following illustration). To connect an external device to the camcorder, plug the device's cable into the camcorder's XLR terminal (4).

- 1 Loosen the microphone lock screw (1), open the microphone holder and insert the microphone (2).
- 2 Tighten the lock screw and put the microphone cable through the microphone cable clamp under the microphone holder (3).
- 3 Plug the microphone cable into the desired XLR terminal (4) or the MIC terminal (5).

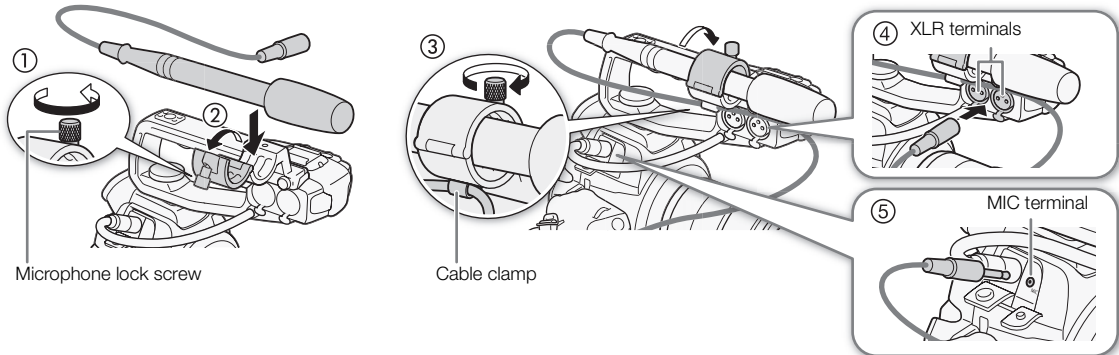

### Using the Built-in Microphone or an External Microphone Connected to the MIC Terminal

Follow the step below to use the built-in microphone or an external microphone attached to the MIC terminal. Use commercially available condenser microphones with their own power supply and a  $\varnothing$  3.5 mm mini-stereo plug\*. You can use the microphone attenuator for either type of microphone. If you are using the built-in microphone, you can also use the low-cut filter and select the sensitivity.

\* For 50.00 Hz recordings, use commercially available microphones with a cable no longer than 3 m.

Set the AUDIO IN switch of the desired channel to INT.

- If you connect a microphone to the MIC terminal while the AUDIO IN switch is set to INT, the camcorder will switch automatically from the built-in microphone to the external microphone.

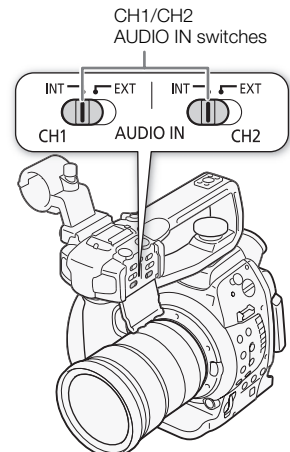

## Adjusting the Audio Level for the MIC Terminal

You can adjust the audio recording level of a microphone attached to the MIC terminal to auto or manual. The way to adjust the audio level depends on whether the handle unit is attached to the camcorder.

### When the Handle Unit is Attached

With the handle unit attached, the audio level adjustment is done using the audio controls on the handle unit.

- 1 Select the audio level adjustment mode with the CH1 audio level switch.
  - **Automatic audio level adjustment:** Set the CH1 audio level switch to A. You do not need to perform the rest of the procedure.
  - **Manual audio level adjustment:** Set the CH1 audio level switch to M. Continue the procedure to set the microphone's audio recording level.
- 2 Turn the CH1 **AUDIO** dial to adjust the audio level.
  - For reference, 0 corresponds to  $-\infty$ , 5 corresponds to 0 dB, and 10 corresponds to +18 dB.
  - As a guideline, adjust the audio recording level so that the audio level meter on the screen will go to the right of the 18 dB mark (one mark right of the 20 dB mark) only occasionally.
  - Closing the protective cover will prevent the audio controls from being changed inadvertently.

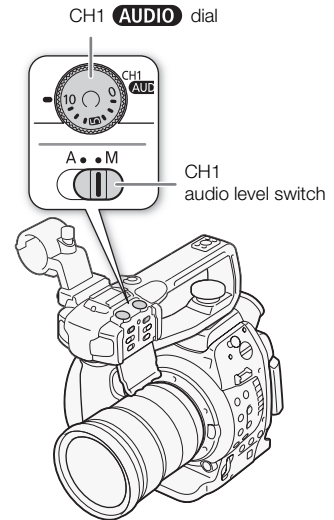

### When the Handle Unit is Not Attached

You can use an external microphone connected to the MIC terminal without attaching the handle unit. In such case, adjust the microphone's audio recording level using the menu.

- 1 Open the [MIC Mode] submenu.
 

[J) Audio Setup] ➤ [Audio Input] ➤ [MIC Mode]
- 2 Select [Automatic] or [Manual] and then press the joystick.
  - If you selected [Automatic], you do not need to perform the rest of the procedure. If you selected [Manual], continue the procedure to set the microphone's audio recording level.
- 3 Open the [MIC Level] screen.
 

[J) Audio Setup] ➤ [Audio Input] ➤ [MIC Level]
- 4 Push the joystick up/down to set the audio recording level and then press the joystick.
  - For reference, 0 corresponds to  $-\infty$ , 50 corresponds to 0 dB, and 99 corresponds to +18 dB.
  - As a guideline, adjust the audio recording level so that the audio level meter on the screen will go to the right of the 18 dB mark (one mark right of the 20 dB mark) only occasionally.

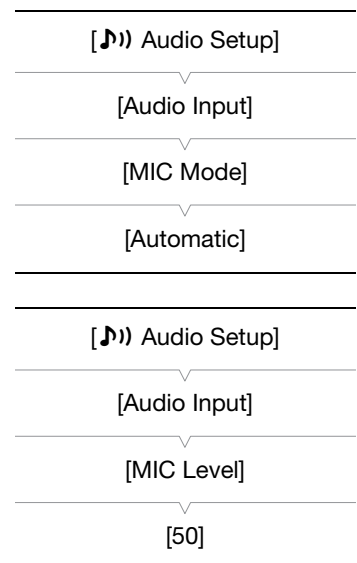

### NOTES

- When adjusting the audio level manually, you can activate the audio peak limiter with the [J) Audio Setup] ➤ [Audio Input] ➤ [Limiter] setting. When activated, the audio peak limiter will limit the amplitude of audio input signals when they exceed -6 dBFS.
- We recommend using headphones when adjusting the audio level. If the input level is too high, audio may become distorted even if the audio level indicator shows an appropriate level.
- If you set an assignable button to [Audio Level] (89), you can press the button to turn the onscreen audio level indicator on and off.

### Configuring the Built-in Microphone's Low-Cut Filter

- 1 Open the [Int. Mic Low Cut] submenu.  
[J) Audio Setup] ➤ [Audio Input] ➤ [Int. Mic Low Cut]
- 2 Select the desired option and then press the joystick.

#### Options

- [Off]: For recording audio under usual conditions.
- [LC1]: For recording mainly people's voices.
- [LC2]: For reducing the background sound of wind when recording outdoors in windy surroundings (for example, on a beach or close to buildings). Note that when you use this setting some low-frequency sounds may be suppressed along with the sound of wind.

### Selecting the Built-in Microphone's Sensitivity

- 1 Open the [Int. Mic Sensitivity] submenu.  
[J) Audio Setup] ➤ [Audio Input] ➤ [Int. Mic Sensitivity]
- 2 Select the desired option and then press the joystick.

#### Options

- [Normal]: For recording audio under usual conditions.
- [High]: For recording audio at a higher volume (+6 dB).

### Activating the Microphone Attenuator

If the audio level is too high and the sound sounds distorted when recording with the built-in microphone or an external microphone connected to the MIC terminal, activate the microphone attenuator (built-in microphone: 12 dB, external microphone (MIC terminal): 20 dB).

- 1 Open the [MIC/Int. Mic Att.] submenu.  
[J) Audio Setup] ➤ [Audio Input] ➤ [MIC/Int. Mic Att.]
- 2 Select [On] and then press the joystick.

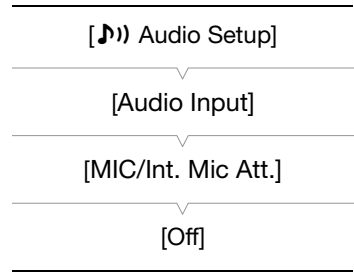
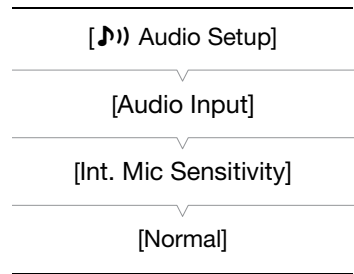
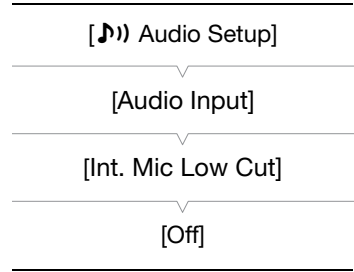

## Using Audio Input from the XLR Terminals

Using the XLR terminals CH1 and CH2, you can record audio independently to the two audio channels from a microphone or analog audio input source.

### Switching Between Microphone and Line Input

- 1 Set the AUDIO IN switch of the desired channel to EXT.
- 2 Set the XLR terminal switch of the desired channel to LINE or MIC.
  - To supply a microphone with phantom power, set the switch to MIC+48V instead. Make sure to connect the microphone first, before turning the phantom power on. Keep the microphone connected when turning off the phantom power.
  - When using the XLR terminal to record to only one channel, use the CH1 terminal.

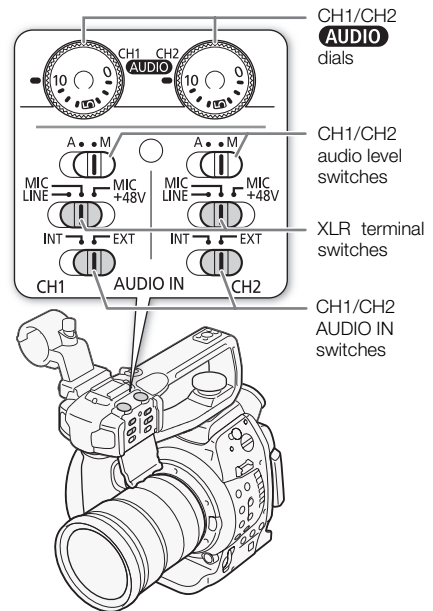

### Selecting the Recording Channel

You can select to which channel the camcorder will record audio.

- 1 Open the [XLR Rec Channel] submenu.  
[Audio Setup] ➤ [Audio Input] ➤ [XLR Rec Channel]
- 2 Select the desired option and then press the joystick.

#### Options

- [CH1]: Records audio to each channel separately. Audio input into CH1 is recorded to channel 1, while audio input into CH2 is recorded to channel 2.
- [CH1/CH2]: Audio input into CH1 is recorded to both channels. Audio input into CH2 will not be recorded.

#### ! IMPORTANT

- When connecting a microphone or device that does not support phantom power, make sure to set the XLR terminal switch to MIC or LINE, respectively. If you set the switch to MIC+48V, the microphone or device may be damaged.

[Audio Setup]

[Audio Input]

[XLR Rec Channel]

[CH1]

## Adjusting the Audio Level for the XLR Terminals

You can set the audio recording level for audio input from the XLR terminals to automatic or manual independently for each channel.

### Automatic Audio Level Adjustment

Set the audio level switch of the desired channel to A (automatic) to let the camcorder automatically adjust that channel's audio level.

#### NOTES



- When both CH1 and CH2 are set to the same audio input (external microphone or external line input), if the audio level is set to automatic, you can use the [  ] Audio Setup] ➤ [Audio Input] ➤ [XLR ALC Link] setting to link the audio level adjustment of both channels.

### Manual Audio Level Adjustment

You can set the audio level for each channel manually from  $-\infty$  to 18 dB.

- 1 Set the audio level switch of the desired channel to M.
- 2 Turn the corresponding **AUDIO** dial to adjust the audio level.
  - For reference, 0 corresponds to  $-\infty$ , 5 corresponds to 0 dB, and 10 corresponds to +18 dB.
  - As a guideline, adjust the audio recording level so that the audio level meter on the screen will go to the right of the 18 dB mark (one mark right of the 20 dB mark) only occasionally.
  - Closing the protective cover will prevent the audio controls from being changed inadvertently.

#### NOTES

- If at least one of the channels is set to manual audio level adjustment, you can also activate the audio peak limiter to prevent audio distortions. When activated, the audio peak limiter will limit the amplitude of audio input signals when they exceed -6 dBFS. Use the [  ] Audio Setup] ➤ [Audio Input] ➤ [Limiter] setting.
- We recommend using headphones when adjusting the audio level. If the input level is too high, audio may become distorted even if the audio level indicator shows an appropriate level.
- If you set an assignable button to [Audio Level] (  89), you can press the button to turn the onscreen audio level indicator on and off.

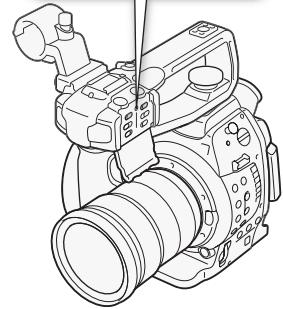
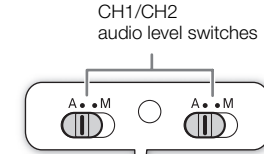

CH1/CH2  
**AUDIO** dials

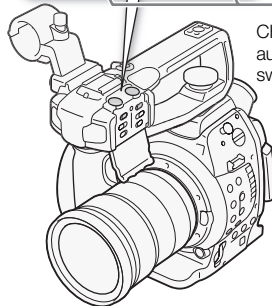
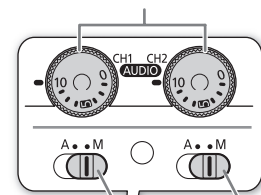

CH1/CH2  
audio level  
switches

## Adjusting the Microphone's Sensitivity

You can adjust the microphone's sensitivity if the XLR terminal switch is set to MIC or MIC+48V.

- 1 Open the desired XLR terminal's sensitivity submenu.  
 [  Audio Setup ] ➤ [ Audio Input ] ➤ [ XLR1 Mic Trimming ] or [ XLR2 Mic Trimming ]
- 2 Select the desired level and then press the joystick.

### Available Sensitivity Levels

+12 dB	+6 dB	0 dB	-6 dB	-12 dB
--------	-------	------	-------	--------

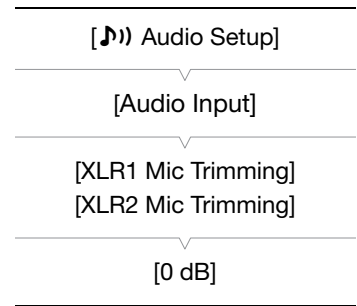



## Activating the Microphone's Attenuator

You can activate the microphone's attenuator (20 dB) if the XLR terminal switch is set to MIC or MIC+48V.

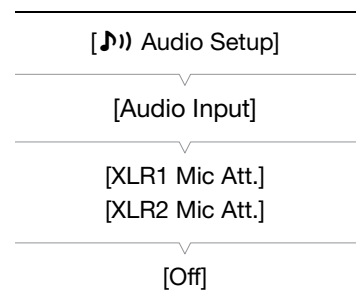
- 1 Open the desired XLR terminal's microphone attenuator submenu.  
 [  Audio Setup ] ➤ [ Audio Input ] ➤ [ XLR1 Mic Att. ] or [ XLR2 Mic Att. ]
- 2 Select [On] and then press the joystick.





## Monitoring the Audio with Headphones

Connect headphones\* to the  (headphone) terminal to monitor the recorded audio. You can adjust the headphone volume with the [  Audio Setup ] ➤ [ Audio Output ] ➤ [ Headphone Volume ] setting.

\* For 50.00 Hz recordings, use commercially available headphones with a cable no longer than 3 m.

### NOTES

- If you set an assignable button to [Headphone +] or [Headphone -] ( 89), you can press the button to adjust the headphone volume without using the menu.
- When you are monitoring the audio, you can choose to synchronize the audio signal with the video signal or monitor the audio in real time. Use the [  Audio Setup ] ➤ [ Audio Output ] ➤ [ Monitor Delay ] setting to select the method. Note that there will be a slight delay when you monitor in real time. Regardless of the setting, however, the audio and video signals recorded will be synchronized.

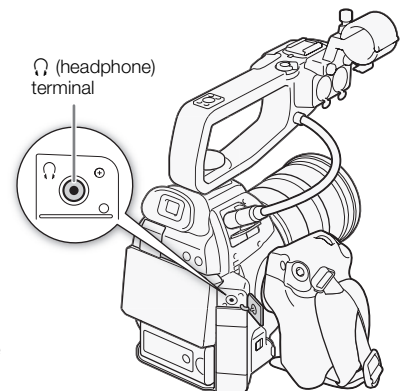

## Color Bars/Audio Reference Signal

You can have the camcorder generate and record color bars and a 1 kHz audio reference signal and output them from the HDMI OUT terminal, AV OUT terminal and  (headphone) terminal (audio reference signal only).

Operating modes: CAMERA MEDIA

### Recording Color Bars

The types of color bars available depend on the camcorder's system frequency setting. When [System Frequency] is set to [59.94 Hz], you can choose between SMPTE standard-definition color bars and ARIB multi-format HDTV color bars. When [System Frequency] is set to [50.00 Hz], you can choose between EBU color bars and SMPTE standard-definition color bars.

1 Open the color bars [Type] submenu.

 Camera Setup  [Color Bars]  [Type]

2 Select the type of color bars and then press the joystick.

3 Open the [Enable] submenu to activate the color bars.

 Camera Setup  [Color Bars]  [Enable]

4 Select [On] and then press the joystick.

- The selected color bars appear on the screen and will be recorded when you press the START/STOP button.
- Turning the camcorder off or changing the operating mode to MEDIA mode will deactivate the color bars.

#### NOTES

- If you set an assignable button to [Color Bars] ( 89), you can press the button to activate and deactivate the color bars.

### Recording an Audio Reference Signal

The camcorder can output a 1 kHz audio reference signal with the color bars.

1 Open the [1 kHz Tone] submenu.

 Audio Setup  [Audio Input]  [1 kHz Tone]

2 Select the desired level and then press the joystick.

- Available levels are -12 dB, -18 dB and -20 dB.
- Select [Off] to turn off the signal.
- The signal is output at the selected level and will be recorded when you press the START/STOP button.

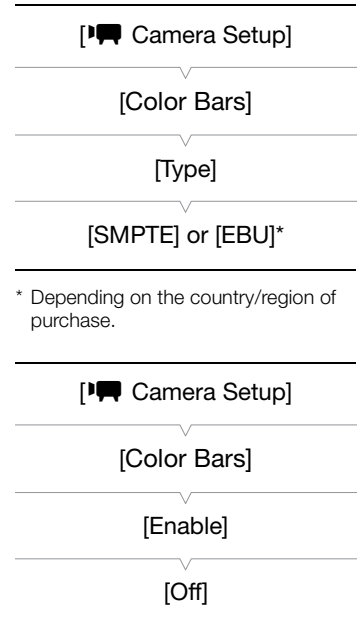

\* Depending on the country/region of purchase.

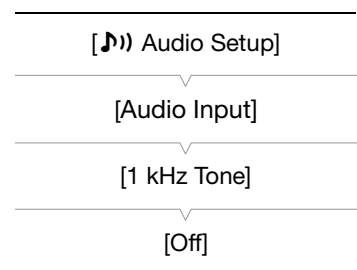



## Video Scopes

The camcorder can display a simplified waveform monitor or an edge monitor\* to help you focus. The video scopes appear only on the LCD screen. They do not appear in the viewfinder or on an external monitor.

\* The edge monitor looks at the focus of the entire picture and displays the results as a waveform. The edge monitor is available only in **CAMERA** mode.

### Displaying a Video Scope

Operating modes: **CAMERA** **MEDIA**

Press the WFM button.

- The waveform monitor will appear in a window on the lower right of the screen.
- You can press the WFM button repeatedly to activate the video scopes in the following sequence.

Waveform monitor → Edge monitor\* → Off

- Alternatively, you can display the video scopes using [**Other Functions**] ➤ [WFM (LCD)] ➤ [Setting]. Select [WFM] for the waveform monitor or [Edge Mon.]\* for the edge monitor.

\* Not available in **MEDIA** mode.

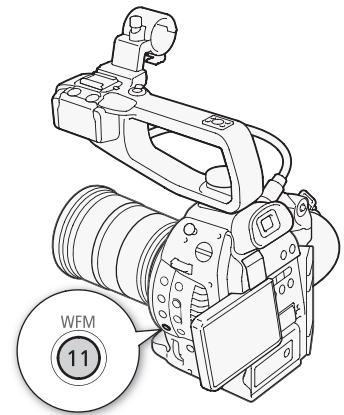

### Configuring the Waveform Monitor

The camcorder's waveform monitor function offers 5 modes. You can also change the gain.

Operating modes: **CAMERA** **MEDIA**

1 Open the [Waveform Monitor] submenu.

[**Other Functions**] ➤ [WFM (LCD)] ➤ [Waveform Monitor]

2 Select the desired option and then press the joystick.

- If you do not need to change the gain, you do not need to perform steps 3 and 4.

3 Open the waveform monitor [Gain] submenu.

[**Other Functions**] ➤ [WFM (LCD)] ➤ [Gain] (under [Waveform Monitor])

4 Select [1x] or [2x] and then press the joystick.

#### Options

[Line]: Sets the waveform monitor to line display mode.

[Line+Spot]: The waveform of the area in the red frame is displayed in red on top of the [Line] mode waveform.

[Field]: Sets the waveform monitor to field display mode.

[RGB]: Functions like an RGB parade scope.

[YPbPr]: Functions like a YPbPr parade scope.

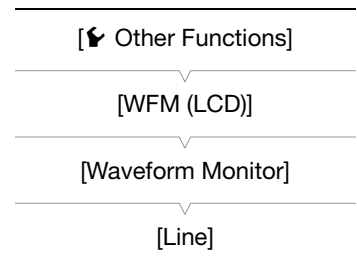

## Configuring the Edge Monitor

Using this video scope allows you to focus with more precision. You can use the edge monitor along with the other focus assistance functions (67). The edge monitor features 2 modes.

Operating modes: CAMERA MEDIA

1 Open the [Edge Monitor] submenu.

[Other Functions] ➤ [WFM (LCD)] ➤ [Edge Monitor]

2 Select the desired option and then press the joystick.

- If you do not need to change the gain, you do not need to perform steps 3 and 4.

3 Open the edge monitor [Gain] submenu.

[Other Functions] ➤ [WFM (LCD)] ➤ [Gain] (under [Edge Monitor])

4 Select the desired gain value and then press the joystick.

### Options

[Type 1]: The waveform that represents the focus of the entire picture is displayed in green. In addition, the waveform of the area in the three red frames is displayed in red on top of the previous waveform.

[Type 2]: This mode displays the edge monitor with the waveform monitor in [Line+Spot] mode. The waveform monitor appears on the left in green while the edge monitor appears on the right in blue. The waveform of the area in the red frame is displayed in red on top of the edge monitor waveform.

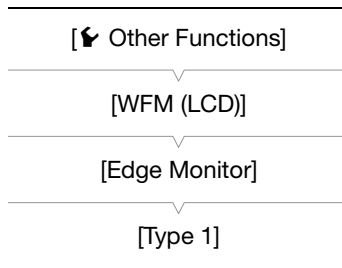

## Reviewing a Recording

When the camcorder is in **CAMERA** mode, you can review the last clip that was recorded.

Operating modes: **CAMERA** **MEDIA**

1 Open the [Rec Review] submenu to set the review length.

[Other Functions] ➤ [Rec Review]

2 Select the desired option and then press the joystick.

3 After you finish recording, press the **GO** button.

- The last clip that was recorded is played back without audio for the selected duration. [▶ REVIEW] appears at the top of the screen.
- Press the CANCEL button to stop reviewing the clip and change the camcorder back to record pause mode.
- After the clip finishes playing back, the camcorder returns to record pause mode.

### Options

[Entire Clip]: Allows you to review the entire clip.

[Last 4 sec]: Allows you to review just the last 4 seconds of the clip.

### **i** NOTES

- When pre-recording mode is activated (84), you cannot review a clip.
- If the camcorder switched SD cards during a recording, the camcorder will play back the clip on the SD card most recently recorded on.

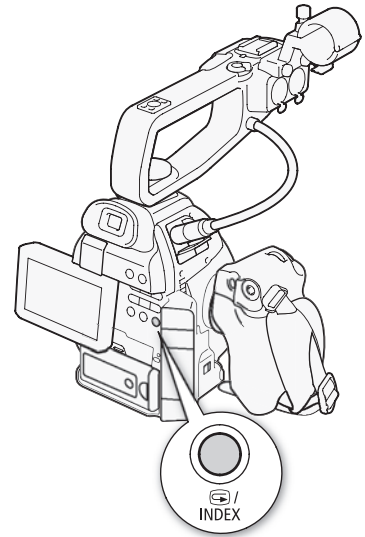
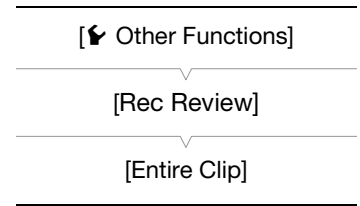

# Pre-recording Mode

When pre-recording mode is activated, the camcorder starts recording continuously into a temporary memory of approximately 3 seconds so when you press the START/STOP button, the clip will contain also approximately 3 seconds of video and audio recorded before you pressed the button. This is especially useful when it is difficult to predict when to start recording.

Operating modes: CAMERA MEDIA

1 Open the [Pre Rec] submenu.

[Other Functions] [Pre Rec]

2 Select [On] and then press the joystick.

- [PRE REC STBY] appears at the top of the screen.

3 Press the START/STOP button to begin recording.

- The rear and front tally lamps illuminate.
- [PRE REC STBY] changes to [● PRE REC] while recording.

4 Press the START/STOP button again to stop recording.

- The camcorder records the clip, including approximately 3 seconds of video and audio recorded before the START/STOP button was pressed.
- Both tally lamps will go out and [PRE REC STBY] appears at the top of the screen.

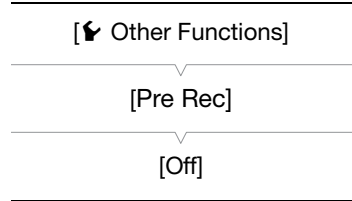

## *i* NOTES

- During pre-recording mode, if the camcorder is left in record pause mode for approximately 1 hour, a message will be displayed (153). After about 1 minute, pre-recording will be deactivated automatically.
- Pre-recording mode cannot be used with double slot recording, deleting the last clip recorded or reviewing a recording.
- During pre-recording mode, the time code will be recorded with the running mode (70) set to [Free Run], regardless of the previous setting. When the time code is recorded, it will include the 3 seconds before the START/STOP button was pressed. When pre-recording mode is deactivated, the running mode will return to its previous setting.

# Continuous Recording

Using continuous recording you can avoid missing important shooting opportunities. You need to activate the continuous recording mode using the menu. Once continuous recording has started, the camcorder will keep recording until you access the menu to stop recording. Additionally, when two SD cards are inserted in the camcorder, activating the continuous recording mode will automatically activate also the double slot recording function so you can have an additional copy of your continuous recording.

During continuous recording, you can press the START/STOP button to set in and out points\* in the recording; the portion of a clip between an in point and an out point will be defined as a "shot". In **MEDIA** mode, you can display a special index screen of shots (105) and play back and delete specific shots. The in and out point information can also be read by compatible NLE software\*\* and used for editing.

\* In points and Out points are marks in the continuous recording clips that indicate the beginning and end point of important parts in the recording.

\*\*For details about compatible software, visit your local Canon Web site.

Operating modes: **CAMERA** **MEDIA**

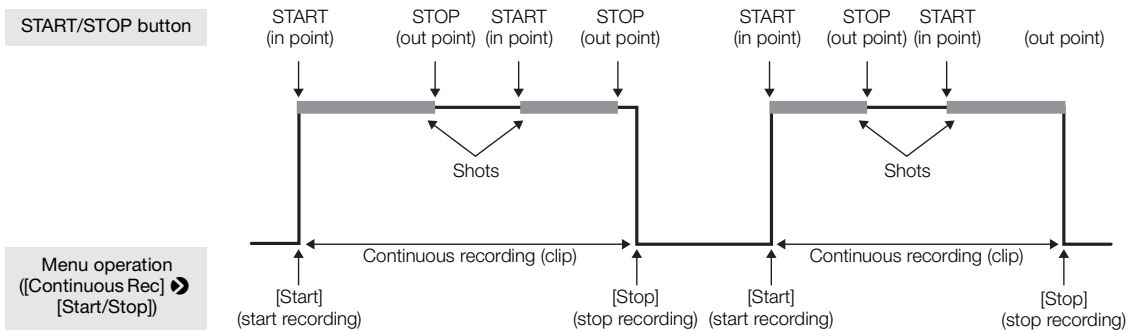

### 1 Open the continuous recording [Mode] submenu.

[Other Functions] > [Continuous Rec] > [Mode]

### 2 Select [On] and then press SET.

- [CONT STBY] or [D] CONT STBY (when using two SD cards) appears at the top of the screen and the camcorder will enter continuous recording standby mode.
- The total shot recording time (D) CONT 00:00:00 will appear on the left of the screen.

### 3 Press the START/STOP button to begin recording.

- The rear and front tally lamps illuminate and continuous recording will start. [CONT] will be displayed in red and the time code will start running.
- At the same time, the first shot's in point is recorded. [STBY] changes to [● REC] and the total shot recording time will start advancing.
- You can also set [Other Functions] > [Continuous Rec] > [Start/Stop] to [Start] to start recording.

### 4 Press the START/STOP button as necessary to set additional in and out points.

- While recording: An out point is recorded, [● REC] changes to [STBY] and the total shot recording time will stop advancing.
- During standby mode: An in point is recorded, [STBY] changes to [● REC] and the total shot recording time will start advancing again.

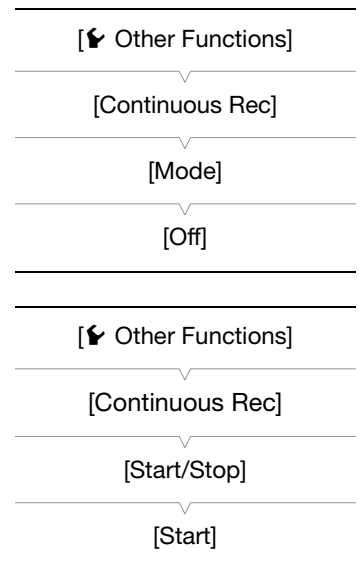

5 To stop the continuous recording, open the continuous recording [Start/Stop] submenu.

[ Other Functions] [Continuous Rec] [Start/Stop]

6 Select [Stop] and then press SET.

- Continuous recording will stop. Both tally lamps will go out and the clip will be recorded on the SD card(s).
- [CONT] will change back to white and the time code will stop.
- If a shot was being recorded while the menu was accessed, stopping the continuous recording will automatically record also an out point for that shot.

7 To end the continuous recording mode, open the continuous recording [Mode] submenu.

[ Other Functions] [Continuous Rec] [Mode]

8 Select [Off] and then press SET.

- [CONT] and the total shot recording time display will disappear.

NOTES

- When using two SD cards for continuous recording, even if continuous recording is not possible on one SD card because the maximum number of clips (200 clips) has been reached, continuous recording may continue only on the other SD card as long as continuous recording clips can still be recorded on that SD card.
- During continuous recording mode, relay recording, pre-recording, reviewing a recording or deleting the last clip recorded cannot be used.
- Immediately after activating the continuous recording mode or stopping a continuous recording, the onscreen [CONT] display will flash momentarily. During this time, settings in the [Continuous Rec] submenu cannot be changed. Wait until the onscreen display stops flashing and stays on to change other settings.

## Using the RC-V100 Remote Controller

You can connect the optional RC-V100 Remote Controller to control the camcorder (including advanced recording functions) from a distance. In addition to turning the camcorder on and off and navigating the menus, while recording you can control various camera functions, such as aperture and shutter speed, and custom picture settings, like knee and sharpness.

The connection cable supplied with the RC-V100 is required to connect the remote controller to the camcorder's REMOTE terminal. For details on how to connect and use the remote controller, refer to its instruction manual.

Operating modes: CAMERA MEDIA

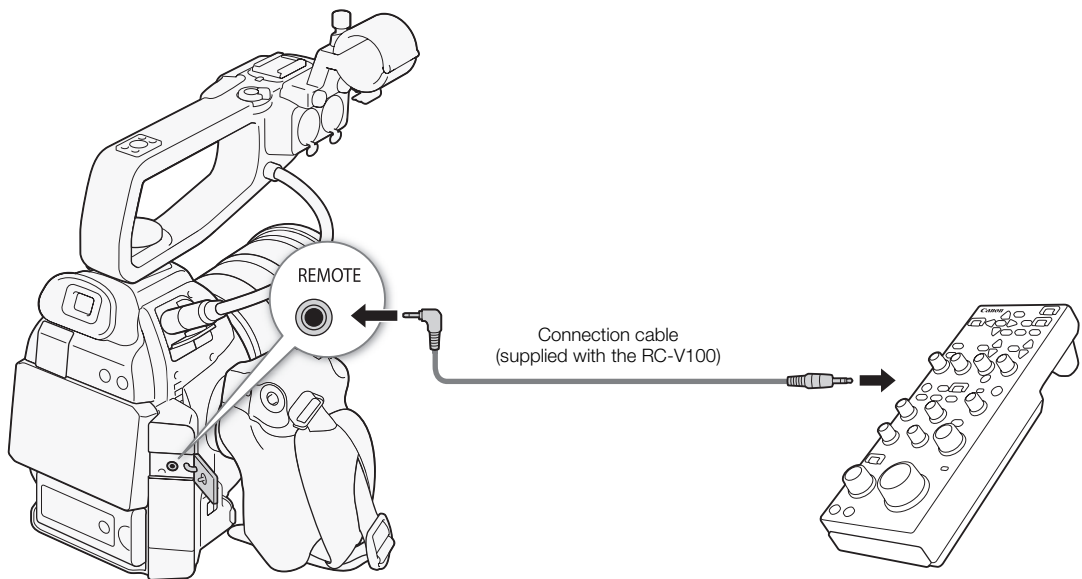

- 1 Turn off the camcorder and connect the optional RC-V100 Remote Controller to the camcorder.
- 2 Turn on the camcorder in CAMERA mode and open the [REMOTE Term.] submenu.  
[Other Functions] ➤ [REMOTE Term.]
- 3 Select [RC-V100] and then press the joystick.

### Options

[RC-V100]: Select this option to use the optional RC-V100 Remote Controller.

[Standard]: Select this option to use commercially available remote controls.

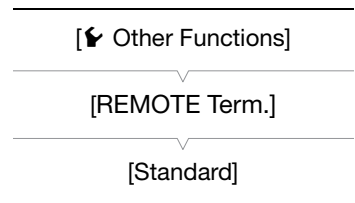

### **i** NOTES

- The following controls on the remote controller will not operate the camcorder: ND button, AGC button, AUTO KNEE button, ZOOM dial and AF button.
- The AUTO IRIS button on the remote controller will operate the camcorder only when a compatible EF lens (📖 60) is attached to the camcorder.
- Custom picture settings can be changed using the remote controller only when an appropriate custom picture file is selected (📖 93).





## Assignable Buttons

The camcorder conveniently features 15\* buttons to which you can assign various functions. By assigning often-used functions, you can quickly access them with a single press of a button. Assignable button 7 is located on the grip unit, so its availability depends on the camcorder configuration used.

\* In **MEDIA** mode, only assignable buttons 7 to 15 are available.

Operating modes: **CAMERA** **MEDIA**

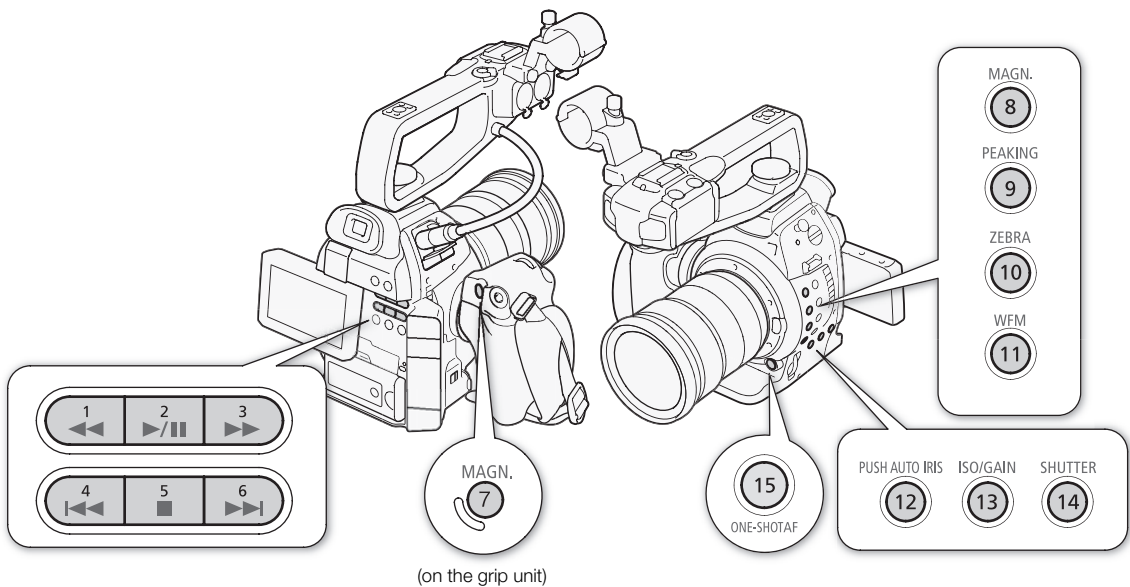

### Changing the Assigned Function

1 Open the [Assign Button] submenu.

[Other Functions] ➤ [Assign Button]

2 Select the button to change and then press the joystick.

- A list of available functions appears.
- The quick reference shows the default settings for each assignable button. The labels on the camcorder/grip unit for assignable buttons 7 to 15 also indicate their default settings. By default, buttons 1 to 6 have no assignable function set.

3 Select the desired function and then press the joystick.

- If you selected [User Setting (NONE)], the menu will change from orange to blue to indicate you are selecting a menu setting to register. Continue the procedure to register a menu setting. Otherwise, you do not need to perform the rest of the procedure.

[Other Functions]

[Assign Button]

[1 to 6 (NONE)]  
 [7 MAGN.]  
 [8 MAGN.]  
 [9 PEAKING]  
 [10 ZEBRA]  
 [11 WFM]  
 [12 PUSH AUTO IRIS]  
 [13 ISO/GAIN]  
 [14 SHUTTER]  
 [15 ONE-SHOT AF]

4 Navigate the menus to find the menu setting you want to register and then press the joystick.

- The selected menu setting will be registered to the customizable slot and to the assignable button.
- The name of the selected menu setting will be listed instead of [User Setting (NONE)] and the customizable slot will be marked by a ★ .

**i** NOTES

- You can check the two [Assign Button] status screens (📖 142) to see what functions are set for the assignable buttons.
- You can reset only the functions assigned to the assignable buttons, without affecting other camera settings, with the [👉 Other Functions] ➡ [Reset] ➡ [Assignable Buttons] function. All the assignable buttons will return to their default function.

### Using an Assignable Button

After you assign a function to one of the buttons, press the button to activate the function. For some functions, an options menu may appear. In such case, select the desired option and then press the joystick.

#### Assignable Functions

Functions can be set separately in **CAMERA** mode and **MEDIA** mode. Refer to the following table for assignable functions and available modes.

Function name	Description	CAMERA	MEDIA	📖
[ONE-SHOT AF]	The camcorder focuses automatically one time only (One-shot AF function).	●	–	65
[PUSH AUTO IRIS]	The camcorder automatically adjusts the aperture (f/stop).	●	–	61
[Iris Mode]	Switches the aperture adjustment mode between automatic and manual.	●	–	60
[Iris +]	Opens up the aperture.	●	–	60
[Iris -]	Closes the aperture.	●	–	
[AE Shift +]	Compensates the exposure toward the bright side.	●	–	61
[AE Shift -]	Compensates the exposure toward the dark side.	●	–	
[Backlight]	Turns the [Backlight] light metering option on/off.	●	–	62
[Spotlight]	Turns the [Spotlight] light metering option on/off.	●	–	
[ISO/GAIN]	Highlights the ISO speed or gain value so it can be adjusted.	●	–	57
[SHUTTER]	Highlights the shutter speed so it can be adjusted.	●	–	54
[View Assist.]	Turns view assistance on/off.	●	–	50
[PEAKING]	Turns peaking on/off.	●	–	67
[ZEBRA]	Turns zebra patterns on/off.	●	–	69
[WFM]	Activates video scopes in the following sequence: Waveform monitor → Edge monitor ( <b>CAMERA</b> mode only) → Off	●	●	81
[MAGN.]	Turns magnification on/off.	●	–	67
[Color Bars]	Turns color bars on/off.	●	–	80
[Markers]	Turns onscreen markers on/off.	●	–	68
[LCD Setup]	Opens the [LCD Setup] submenu.	●	●	33
[VF Setup]	Opens the [VF Setup] submenu.	●	●	
[LCD/VF B&W]	Turns the B&W mode of the LCD and viewfinder on/off.	●	●	34
[Onscreen Display]	Turns on/off the inclusion of onscreen displays on video output from the camcorder's terminals (both HD and SD video output).	●	●	120
[Time Code]	Displays the [Time Code] submenu.	●	–	70
[Time Code Hold]*	Puts the time code display on hold or resumes it.	●	●	71

Function name	Description	CAMERA	MEDIA	
[Headphone +]	Increases the headphone volume.	●	●	109
[Headphone -]	Reduces the headphone volume.	●	●	
[Speaker +]	Increases the built-in speaker's volume.	–	●	109
[Speaker -]	Reduces the built-in speaker's volume.	–	●	
[Audio Output CH]	Switches the audio output channel.	●	●	121
[Audio Level]	Turns the audio level meter on/off.	●	●	75, 78
[Photo]*	Records a photo.	●	●	125
[Fan]	Switches the cooling fan's operation between always on and automatic.	●	–	37
[My Menu]	Opens the [My Menu] customized submenu.	●	–	28
[Initialize Media]	Opens the [Initialize Media] submenu.	●	●	40
[◀ Up]	Replaces the joystick's up arrow.	●	●**	27
[◀ Down]	Replaces the joystick's down arrow.	●	●**	
[◀ Left]	Replaces the joystick's left arrow.	●	●**	
[◀ Right]	Replaces the joystick's right arrow.	●	●**	
[◀ SET]	Replaces the joystick's SET button. That is, pressing the assignable button is the same as pressing down the joystick itself.	●	●**	
[User Setting (NONE)]*	Customizable slot. Assign to the button any menu setting you would like to register.	●	●	–

\* Function can be used only by assigning it to a button.

\*\*Not available during photo playback.

## Custom Picture Settings

You can preset a number of picture-related settings (📖 95). You can change each individual setting for maximum control or use a more intuitive graphical interface to adjust the gamma curve and white balance shift (📖 101). After adjusting the desired settings to your preference, you can save the whole set in the camcorder or SD card as a custom picture file. You can then load the file at a later date to change the current settings to the preset levels you selected. You can even use the [🔧 Other Functions] ➤ [Photos] ➤ [Add 📷 File] setting to embed the custom picture settings in photos recorded to an SD card.

You can save up to 9 different custom picture files on the camcorder and up to 20 custom picture files on an SD card. Custom picture files can be copied between the camcorder and SD card.

Custom picture files created with previous Canon camcorders are not compatible with this camcorder. Custom picture files created with this camcorder are compatible only with other C100 camcorders.

Operating modes: CAMERA MEDIA

### Selecting Custom Picture Files

Select a custom picture file to apply its settings to your recordings or to edit, rename, protect, or transfer it. When [🗨 Camera Setup] ➤ [📷 CINEMA Locked] is set to [On], the custom picture menu cannot be accessed and custom picture files cannot be used.

#### 1 Press the CUSTOM PICTURE button.

- The custom picture menu appears. The currently selected file appears next to the **SET** icon or [Off] if no file is selected.
- When an optional RC-V100 Remote Controller is connected to the camcorder, you can also press the remote controller's CUSTOM PICT. button to open the custom picture submenu.

#### 2 Select [**SET** 📷 Select File] and then press the joystick.

#### 3 Select the location of the custom picture file and then press the joystick.

- Select [Camera] to apply a custom picture file saved in the camcorder or [📷A] or [📷B] to apply a custom picture file saved on the respective SD card.
- [📷A] and [📷B] will only appear if the SD card contains previously saved custom picture files.

#### 4 Select the desired file and then press the joystick.

- Select [Off] to record without applying any custom picture settings.
- To apply the file's settings, press the CUSTOM PICTURE button to exit the custom picture menu. An icon representing the selected custom picture file will appear on the left of the screen.
- To perform other operations on the file, continue with the following procedures.

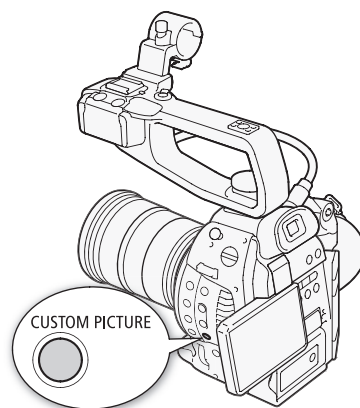

### Preset Custom Picture Files



By default, the custom picture files in the camcorder in file slots [C7] to [C9] are protected. Remove the protection (📖 94) to edit the file. The following describes when to use the preset files.

[C7: EOS Std.]: Reproduces the image quality and look (high contrast, vibrant colors) of an EOS digital SLR camera with its picture style set to [Standard].

[C8: Wide DR]: Applies a gamma curve with a very wide dynamic range and an appropriate color matrix that nevertheless do not require post-production processing.



[C9: CINEMA]: Uses the Canon Log gamma and color matrix for an outstanding dynamic range and an image suitable for processing in post-production.

## NOTES

- **About changing custom picture related settings using the optional RC-V100 Remote Controller**
  - If a protected custom picture file or no custom picture file is selected on the camcorder ([  Select File] is set to [Off]) custom picture related settings cannot be changed using the remote controller.
  - While the remote controller is connected to the camcorder, custom picture files on an SD card ([A1] to [A20] for SD card A, [B1] to [B20] for SD card B) cannot be used. If you connect the remote controller while a custom picture file on an SD card was selected, the custom picture file will change automatically to [Off] (recording without custom picture settings). To use the settings of a custom picture file saved on an SD card, copy the file in advance from the SD card to an open file slot in the camcorder ( 95).
  - Adjusting custom picture related settings using the remote controller will change the settings registered under the currently selected custom picture file. If you want to keep an important custom picture file, copy it in advance to an SD card or select in advance a custom picture file you do not mind changing.



## Editing a Custom Picture File's Settings

This procedure describes how to change the custom picture settings in detail when you want maximum control over the image. In addition, the camcorder offers an easier, more intuitive way to adjust only the gamma curve and white balance settings using a simplified graphical interface ( 101).

- 1 After selecting a file, select [  Fine Tuning] and then press the joystick.
- 2 Select a setting and then press the joystick.
- 3 Change the setting to the desired level and then press the joystick.
  - Refer to *Available Custom Picture Settings* ( 95) for details on the various settings.
  - Repeat steps 2 and 3 for other settings, as necessary.
- 4 Press the CUSTOM PICTURE button to exit the custom picture menu and apply the new custom picture settings.

## Resetting the current file's settings to default values



- 1 After selecting a file, open the [Reset] submenu.
 

  Fine Tuning





[Reset]

  

  Fine Tuning  [Reset]
- 2 Select the desired default values and then press the joystick.
  - Select [NEUTRAL] to reset to neutral default values (equivalent to not using custom picture settings at all) or one of the preset settings ([CINEMA], [Wide DR] or [EOS Std.]) if you want to replicate these preset settings, for example as a starting point to edit them further.
- 3 Select [OK] and then press the joystick.

## Renaming Custom Picture Files



- 1 After selecting a file, open the [Rename] submenu.
 

  Fine Tuning



[Rename]

  Fine Tuning  [Rename]

  - A screen appears that displays the current file name with an orange selection frame on the first character.
- 2 Push the joystick up/down to select an alphanumeric character or symbol and then press the joystick to move to the next field.
  - Change the rest of the name in the same way.

3 Select [Set] and then press the joystick.

4 Press the CUSTOM PICTURE button to exit the custom picture menu and apply the selected custom picture settings.

## Protecting Custom Picture Files

Protecting a custom picture file prevents its settings from being accidentally changed.

1 After selecting a file, open the [Protect] submenu.

[FINE CP Fine Tuning] ➤ [Protect]



2 Select [Protect] and then press the joystick.

- In the custom picture menu,  will appear next to the file name.
- To remove protection settings, select [Unprotect] instead.

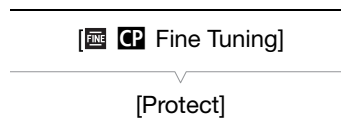
3 Press the CUSTOM PICTURE button to exit the custom picture menu and apply the selected custom picture settings.





## Transferring Custom Picture Files

You can transfer custom picture files between the camcorder and SD cards. When the custom picture file is in the camcorder, use [Copy To ] or [Load From ] depending on the operation you wish to perform. Similarly, when the custom picture file is on an SD card, use [Copy To Cam.] or [Load From Cam]. Custom picture files cannot be copied directly from one SD card to another.

### Copying a File from the Camcorder to an SD Card

1 After selecting a file in the camcorder, open the [Copy To ] submenu.

[FINE CP Transfer File] ➤ [Copy To ]

2 Select [A] or [B] and then press the joystick.

3 Select the file slot on the SD card under which to save the file and then press the joystick.

- If there are available slots, you can select [New File] to save the file in the first available slot.

4 Select [OK] and then press the joystick.

- The currently selected file will be copied to the selected slot on the SD card, overwriting the file in that slot. When the confirmation screen appears, press the joystick.

5 Press the CUSTOM PICTURE button to exit the custom picture menu and apply the selected custom picture settings.

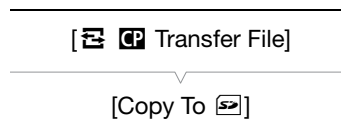

### Replacing a File in the Camcorder with a File on an SD Card

1 After selecting a file in the camcorder to replace, open the [Load From ] submenu.

[FINE CP Transfer File] ➤ [Load From ]

2 Select [A] or [B] and then press the joystick.

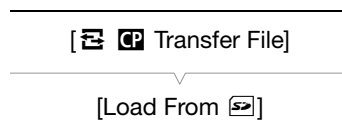

3 Select the file to transfer to the camcorder and then press the joystick.



- 4 Select [OK] and then press the joystick.
  - The file in the camcorder will be overwritten by the one on the SD card. When the confirmation screen appears, press the joystick.
- 5 Press the CUSTOM PICTURE button to exit the custom picture menu and apply the selected custom picture settings.

### Copying a File from an SD Card to the Camcorder



- 1 After selecting a file on an SD card, open the [Copy To Cam.] submenu.
 

[  Transfer File]

---



[Copy To Cam.]

---

[  Transfer File] ➤ [Copy To Cam.]
- 2 Select the file slot under which to save the file and then press the joystick.
- 3 Select [OK] and then press the joystick.
  - The currently selected file will be copied to the selected slot on the camcorder, overwriting the file in that slot. When the confirmation screen appears, press the joystick.
- 4 Press the CUSTOM PICTURE button to exit the custom picture menu and apply the selected custom picture settings.

### Replacing a File on an SD Card with a File in the Camcorder



- 1 After selecting a file on an SD card to replace, open the [Load From Cam.] submenu.
 

[  Transfer File]

---

[Load From Cam.]

---

[  Transfer File] ➤ [Load From Cam.]
- 2 Select the file to transfer to the SD card and then press the joystick.
- 3 Select [OK] and then press the joystick.
  - The file on the SD card will be overwritten by the one in the camcorder. When the confirmation screen appears, press the joystick.
- 4 Press the CUSTOM PICTURE button to exit the custom picture menu and apply the selected custom picture settings.

### NOTES

- You can also copy a custom picture file embedded in a photo to the camcorder ( 131).

## Available Custom Picture Settings

The following are the available settings. Even if no custom picture file is selected, the default settings are still applied to the picture.

### [Gamma]

The gamma curve changes the overall look of the image. Generally, this should be the same setting as [Select] under [Color Matrix]. (Default: [Normal 1]).

[Normal 1] to [Normal 4]: These settings are suitable for viewing the image on a TV monitor. Highlights in [Normal 2] are brighter than those of [Normal 1]. Dark tones in the lower part of the gamma curve for [Normal 3] (ITU-R BT.709 standard) and [Normal 4] are more pronounced than those of [Normal 2].

[Cine 1] or [Cine 2]: Use [Cine 1] for a gamma curve that results in a picture with a cinema-like feel and cinema-like tones. [Cine 2] has softer contrasts than does [Cine 1] but is also suitable for creating a cinema-like picture.

[EOS Std.]: This gamma curve approximates the look of an EOS digital SLR camera when the picture style is set to [Standard] (high contrast, vibrant colors).

[Wide DR]: Applies a gamma curve with a very wide dynamic range, optimized for playback on an HDTV.

[Canon Log]: Applies a logarithmic gamma curve for outstanding dynamic range. Requires image processing in post-production.

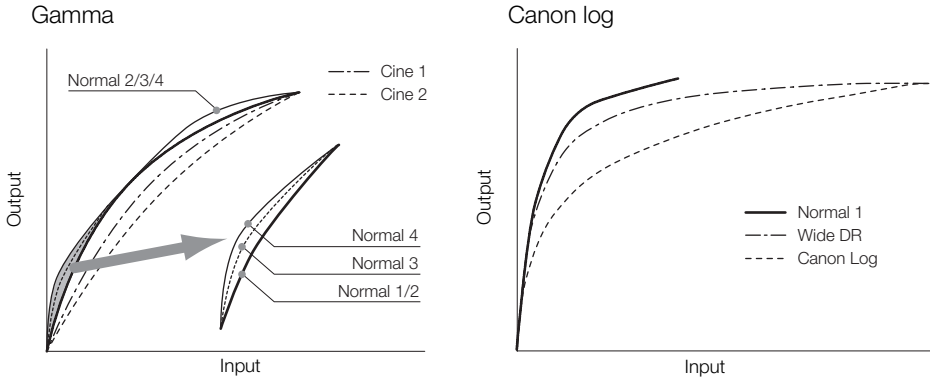

**[Black]**

Controls the black level and color cast of blacks.

**[Master Pedestal]**

The master pedestal increases or decreases the black level. Higher settings will make dark areas brighter but decrease contrast. This setting can be adjusted from -50 to 50. (Default: ±0)

**[Master Black]**

Corrects color cast in blacks.

[Red]: -50 to 50 (Default: ±0)

[Green]: -50 to 50 (Default: ±0)

[Blue]: -50 to 50 (Default: ±0)

**[Black Gamma]**

Controls the lower part of the gamma curve (dark areas of the image). When [Gamma] is set to [Wide DR] or [Canon Log], this setting has no effect on the picture.

[Level]: Raises or lowers the lower part of the gamma curve. This setting can be adjusted from -50 to 50. (Default: ±0)

[Range]: Selects the range in which dark areas are affected. This setting can be adjusted from -5 to 50. (Default: ±0)

[Point]: Determines the shape of the lower part of the gamma curve. This setting can be adjusted from -1 to 50. (Default: ±0)

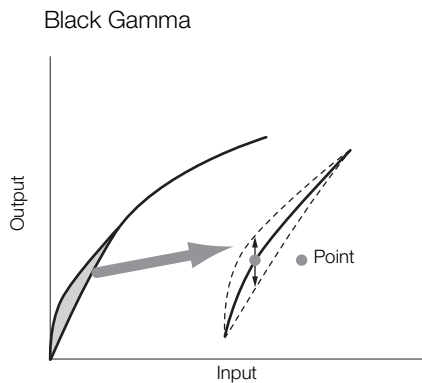



**[Low Key Satur.]**

Adjusts color saturation in dark areas.

[Enable]: Activates/deactivates the setting. (Default: [Off])

[Level]: Specifies how saturated colors are in dark areas. This setting can be adjusted from -50 to 50. (Default:  $\pm 0$ )

**[Knee]**

Controls the upper part of the gamma curve (highlights of the image). By compressing the highlights, you can prevent parts of the image from being overexposed. When [Gamma] is set to [Cine 1], [Cine 2], [EOS Std.], [Wide DR] or [Canon Log], this setting has no effect on the picture.

[Enable]: Activates/deactivates the setting. (Default: [On])

[Slope]: Determines the slope of the gamma curve above the knee point. This setting can be adjusted from -35 to 50. (Default:  $\pm 0$ )

[Point]: Sets the knee point of the gamma curve. This setting can be adjusted from 50 to 109. (Default: 95)

[Saturation]: Adjusts color saturation in highlights. This setting can be adjusted from -10 to 10. (Default:  $\pm 0$ )

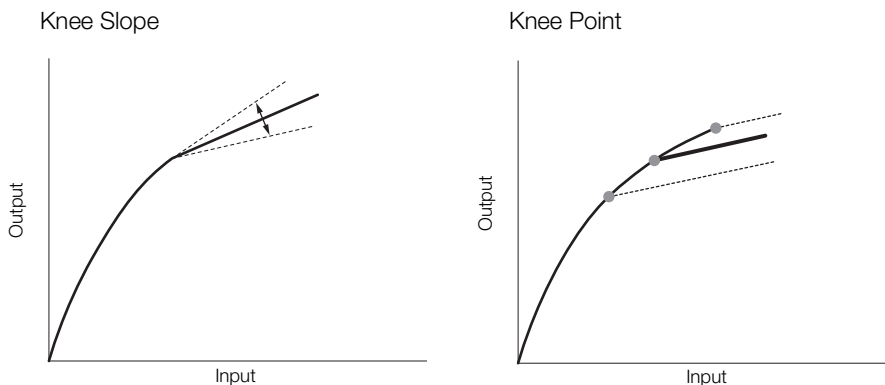
**[Sharpness]**

Sets the sharpness of the output and recording signal.

[Level]: Sets the sharpness level. This setting can be adjusted from -10 to 50. (Default:  $\pm 0$ )

[H Detail Freq.]: Sets the center frequency of horizontal sharpness. Setting higher values increases the frequency, which, in turn, increases the sharpness. This setting can be adjusted from -8 to 8. (Default:  $\pm 0$ )

[Coring]: Reduces noise artifacts caused by high sharpness levels.

[Level]: Sets the coring level. Higher values prevent sharpness from being applied to minute details, resulting in less noise. This setting can be adjusted from -30 to 50. (Default:  $\pm 0$ )

[D-Ofst]: You can use [D-Ofst], [D-Curve] and [D-Depth] to adjust the coring level based on brightness. [D-Ofst] sets the coring level of the minimum brightness level. This setting can be adjusted from 0 to 50. (Default: 0)

[D-Curve]: Sets the curve of the coring adjustment. This curve is the change from [Level] to [D-Ofst]. This setting can be adjusted from 0 to 8. (Default: 0)

[D-Depth]: Sets a multiplier to [D-Ofst] that determines the coring level adjustment based on brightness. Positive values raise the coring level in dark areas and negative values lower the level. This setting can be adjusted from -4 to 4. (Default:  $\pm 0$ )

[HV Detail Bal.]: Adjusts the ratio between horizontal and vertical detail. Higher values emphasize vertical detail while lower values emphasize horizontal detail. This setting can be adjusted from -8 to 8. (Default:  $\pm 0$ )

[Limit]: Restricts how much sharpness is applied. This setting can be adjusted from -50 to 50. (Default:  $\pm 0$ )

- [Select]: In addition to the sharpness set by [Level], [Select] sets the sharpness for areas with higher frequencies. Higher values apply more sharpness to areas with higher frequencies. Use this for subjects in which normal sharpening is not effective. This setting can be adjusted from 0 to 15. (Default: 0)
- [Knee Aperture]: Allows you to set the sharpness of only the areas above the knee point by adjusting the gain and slope. This is not available when [Gamma] is set to [Cine 1], [Cine 2], [Canon Log] or [EOS Std.].
- [Gain]: Sets the amount of sharpness. This setting can be adjusted from 0 to 9. (Default: 0)
- [Slope]: Sets the slope of the sharpness. This setting can be adjusted from 0 to 3, with 0 having no slope, 1 having a steep slope and 3 having a gradual slope. (Default: 1)
- [Level Depend]: Lowers the amount of sharpness applied to dark areas of the image.
- [Level]: Sets the brightness of the dark areas of the image that will be affected. This setting can be adjusted from 0 to 50. (Default: 0)
- [Slope]: Determines the slope of the area between the upper and lower parts of the gamma curve. This setting can be adjusted from 0 to 3, with 0 having no slope, 1 having a steep slope and 3 having a gradual slope. (Default: 0)
- [Offset]: Adjusts the sharpness level of dark areas in the image. Setting higher values will lower the sharpness level. This setting can be adjusted from 0 to 50. (Default: 0)

### [Noise Reduction]

Reduces the amount of noise that appears in the image. Select a level from 1 (lowest level) to 12 (highest level), or select [Off] to turn the noise reduction off. (Default: [Off])

### [Skin Detail]

The camcorder applies a softening filter to areas in the picture with skin tones to give a more pleasant appearance. By changing these settings, you can determine what areas will be detected as skin tones. A zebra pattern will appear over areas on the screen that are detected as having skin tones.

- [Effect Level]: Adjusts the level of the filter. The available options are [Off], [Low], [Middle] and [High]. (Default: [Off])
- [Hue]: Adjusts the hue for detection of skin tones. This setting can be adjusted from -16 to 16. (Default:  $\pm 0$ )
- [Chroma]: Adjusts the color saturation for detection of skin tones. This setting can be adjusted from 0 to 31. (Default: 16)
- [Area]: Adjusts the color range for detection of skin tones. This setting can be adjusted from 0 to 31. (Default: 16)
- [Y Level]: Adjusts the brightness for detection of skin tones. This setting can be adjusted from 0 to 31. (Default: 16)

### [Selective NR]

The camcorder detects the characteristics of a certain color or tone and applies a noise reduction filter to the targeted areas. A zebra pattern will appear over targeted areas on the screen.

- [Effect Level]: Adjusts the level of the noise reduction filter. The available options are [Off], [Low], [Middle] and [High]. (Default: [Off])
- [Hue]: Adjusts the hue for the color to be detected. This setting can be adjusted from 0 to 31. (Default: 0)
- [Chroma]: Adjusts the color saturation for the color to be detected. This setting can be adjusted from 0 to 31. (Default: 16)
- [Area]: Adjusts the color range for the color to be detected. This setting can be adjusted from 0 to 31. (Default: 16)
- [Y Level]: Adjusts the brightness for the color to be detected. This setting can be adjusted from 0 to 31. (Default: 16)

**[Color Matrix]**

Color matrix affects the color tones throughout the whole image. When [Gamma] is set to [Canon Log], this setting has no effect on the picture.

- [Select]: Available options are [Normal 1] to [Normal 4], [Cine 1] and [Cine 2], [EOS Std.], [Wide DR] and [Canon Log]. Generally, this should be the same setting as [Gamma]. After selecting an option, you can make more precise adjustments. (Default: [Normal 1])
- [Gain]: Adjusts the color intensity. This setting can be adjusted from -50 to 50. (Default:  $\pm 0$ )
- [Phase]: Adjusts the color phase. This setting can be adjusted from -18 to 18. (Default:  $\pm 0$ )
- [R-G]: The R-G matrix changes the tint of the picture along the cyan/green and red/magenta gradations. This setting can be adjusted from -50 to 50. (Default:  $\pm 0$ )
- [R-B]: The R-B matrix changes the tint of the picture along the cyan/blue and red/yellow gradations. This setting can be adjusted from -50 to 50. (Default:  $\pm 0$ )
- [G-R]: The G-R matrix changes the tint of the picture along the magenta/red and green/cyan gradations. This setting can be adjusted from -50 to 50. (Default:  $\pm 0$ )
- [G-B]: The G-B matrix changes the tint of the picture along the magenta/blue and green/yellow gradations. This setting can be adjusted from -50 to 50. (Default:  $\pm 0$ )
- [B-R]: The B-R matrix changes the tint of the picture along the yellow/red and blue/cyan gradations. This setting can be adjusted from -50 to 50. (Default:  $\pm 0$ )
- [B-G]: The B-G matrix changes the tint of the picture along the yellow/green and blue/magenta gradations. This setting can be adjusted from -50 to 50. (Default:  $\pm 0$ )

**[White Balance]**

Adjusts the amount of white balance throughout the whole image.

- [R Gain]: Adjust the intensity of red tones. This setting can be adjusted from -50 to 50. (Default:  $\pm 0$ )
- [B Gain]: Adjust the intensity of blue tones. This setting can be adjusted from -50 to 50. (Default:  $\pm 0$ )

**[Color Correction]**

The camcorder detects the characteristics of a certain color (color phase, chroma, area and Y level) and corrects them when recording. You can set the color correction for up to two different areas (A and B).

- [Select Area]: Selects the area or areas to correct. Available options are [Area A], [Area B] and [Area A&B]. Select [Off] to turn this setting off. (Default: [Off])
- [Area A Setting]: Determines the area in which colors will be corrected.
  - [Phase]: Adjusts the color phase for area A. This setting can be adjusted from 0 to 31. (Default: 0)
  - [Chroma]: Adjusts the color saturation for area A. This setting can be adjusted from 0 to 31. (Default: 16)
  - [Area]: Adjusts the color range for area A. This setting can be adjusted from 0 to 31. (Default: 16)
  - [Y Level]: Adjusts the brightness for area A. This setting can be adjusted from 0 to 31. (Default: 16)
- [Area A Revision]: Sets the amount of correction for area A.
  - [Level]: Adjusts the amount of correction to the color saturation. This setting can be adjusted from -50 to 50. (Default:  $\pm 0$ )
  - [Phase]: Adjusts the amount of correction to the color phase. This setting can be adjusted from -18 to 18. (Default:  $\pm 0$ )
- [Area B Setting]: Determines the area in which colors will be corrected.
  - [Phase]: Adjusts the color phase for area B. This setting can be adjusted from 0 to 31. (Default: 0)
  - [Chroma]: Adjusts the color saturation for area B. This setting can be adjusted from 0 to 31. (Default: 16)
  - [Area]: Adjusts the color range for area B. This setting can be adjusted from 0 to 31. (Default: 16)
  - [Y Level]: Adjusts the brightness for area B. This setting can be adjusted from 0 to 31. (Default: 16)

[Area B Revision]: Sets the amount of correction for area B.

[Level]: Adjusts the amount of correction to the color saturation. This setting can be adjusted from -50 to 50.  
(Default:  $\pm 0$ )

[Phase]: Adjusts the amount of correction to the color phase. This setting can be adjusted from -18 to 18.  
(Default:  $\pm 0$ )

### [Other Functions]









[Setup Level]: Adjusts the black level set by the [Black] and [Master Pedestal] settings.

[Level]: Determines the amount of adjustment to be made. This setting can be adjusted from -50 to 50.  
(Default:  $\pm 0$ )

[Press]: Compresses the dynamic range of the video signal so that it does not exceed 100%. Available options are [On] and [Off]. (Default: [Off])

[Clip At 100%]: When the video signal exceeds 100%, this function clips the white level at 100%. Available options are [On] and [Off]. (Default: [Off])

### NOTES

- When an optional RC-V100 Remote Controller is connected to the camcorder, the following custom picture settings can be changed using the buttons and dials on the remote controller. They cannot be changed from the camcorder while the RC-V100 is connected.
  - [Black]  [Master Pedestal]; [Black]  [Master Black]  [Red], [Blue]
  - [Black Gamma]  [Level]
  - [Knee]  [Slope] and [Point] (only when [Knee]  [Enable] is set to [On])
  - [Sharpness]  [Level]
  - [White Balance]  [R Gain], [B Gain]

## Simplified Graphical Interface

In addition to the very detailed settings explained in the previous section (📖 95), the camcorder offers a more intuitive graphical interface for adjusting the gamma curve and white balance settings. Instead of remembering numeric values, you can see how your changes affect the gamma curve or white balance shift right on the screen.

### Gamma Curve

1 After selecting a file, open the gamma curve adjustment screen.

[📁 CP Edit File] ➔ [Gamma]

- The current gamma curve will be displayed on the screen.

2 Push the joystick left/right to highlight the [M] field and then push the joystick up/down to select the desired basic gamma curve.

- The numbers correspond to the [Gamma] settings explained previously (📖 95), as follows:

- 1 to 4: [Normal 1] to [Normal 4]
- 5 and 6: [Cine 1] and [Cine 2]
- 7: [EOS Std.]
- 8: [Wide DR]
- 9: [Canon Log]

3 Push the joystick left/right to highlight the [H] field or [L] field and then push the joystick up/down to adjust the gamma curve as necessary.

- The [L] value can be adjusted from 1 to 9. It is equivalent to the [Black Gamma] setting and controls the lower part of the gamma curve (dark areas of the image). This setting is not available when the [M] value is set to 8 or 9.
- The [H] value can be adjusted from 1 to 5. It is equivalent to the [Knee] setting and controls the upper part of the gamma curve (highlights of the image). This setting is not available when the [M] value is set to 5 or higher.

4 Push the joystick left/right to select [Set] and then press the joystick.

- The adjusted gamma curve will be saved. The [Gamma] value under the [FINE CP Fine Tuning] submenu will change accordingly.

5 Press the CUSTOM PICTURE button to exit the custom picture menu and apply the selected custom picture settings.

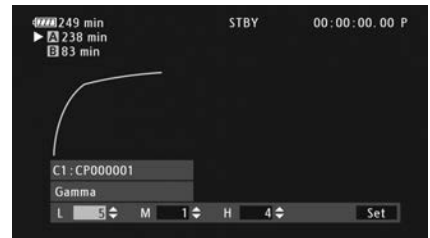
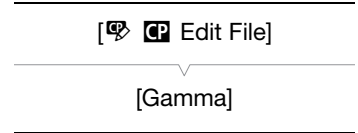

### White Balance

1 After selecting a file, open the white balance shift screen.

[📁 CP Edit File] ➔ [White Balance]

- The current white balance is shown as an orange point at the center of the WB correction coordinates.

2 Push the joystick left/right to shift the white balance along the blue (B)/amber (A) gradation. Push the joystick up/down to shift the white balance along the green (G)/magenta (M) gradation.

- The white balance shift can be set to one of 9 levels in each color's direction.
- The amount of white balance shift will be displayed as two coordinates in the [SHIFT] box to the left of the graph.

3 Press the joystick.

- The adjusted white balance shift value will be saved. The [White Balance] value under the [FINE CP Fine Tuning] submenu will change accordingly.

4 Press the CUSTOM PICTURE button to exit the custom picture menu and apply the selected custom picture settings.

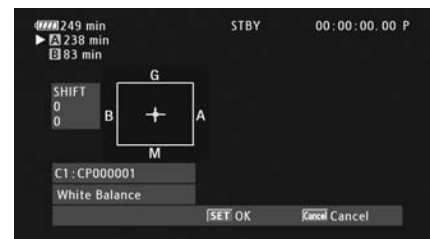
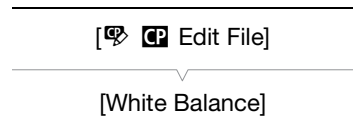

## Customizing Functions and Onscreen Displays

Customize the camcorder to match your shooting style and needs. Use the [ Other Functions] [Custom Function] setting to adjust how some of the camcorder's controls and functions operate in **CAMERA** mode. Similarly, use the [ LCD/VF Setup] [Custom Display 1] or [Custom Display 2] setting to customize the onscreen displays that appear during recording. You can save these preferences along with other menu settings to an SD card and use them again later ( 103).

### Customizing Functions

The following table describes which functions can be customized using [Custom Function].

Operating modes: **CAMERA** **MEDIA**

- 1 Open the [Custom Function] submenu.  
 Other Functions] [Custom Function]
- 2 Select the desired function.
- 3 Change the setting option and then press the joystick.

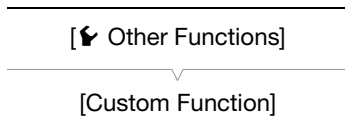

#### Customizable Functions with [Custom Function]

Menu item	Description
[Shockless WB]	When this function is set to [On], it creates a softer transition when the white balance is changed.
[AE Response]	Controls the camcorder's response ([Fast], [Normal] or [Slow]) when you change the automatic exposure setting.
[Grip Ctrl Dial Dir.]	Changes the direction of the adjustment ([Normal] or [Reverse]) when operating the control dial on the grip unit.
[F. Assist. B&W]	Automatically switches the screen to B&W while the focus assist functions (peaking and magnification) are activated. You can have the screen switch to B&W only when peaking is activated ([Peaking]), only when the magnification is activated ([Magnify]) or when either function is activated ([Both]).
[Magn. Add. Disp.]	Simultaneously activates peaking ([Peaking]) or displays the edge monitor ([Edge Mon.]) whenever the magnification function is used.
[Scan Reverse Rec]	Inverts the recorded image horizontally ([Horizontal]), vertically ([Vertical]) or both ([Both]).
[Character Rec]	When this function is set to [On], all of the onscreen displays will be recorded to the clip exactly as they appear on the screen.
[ START/STOP]	Selects whether the START/STOP button will be active or locked too when the <b>POWER</b> switch is set to  (key lock) ( 47).

### Customizing Onscreen Displays

For details on which onscreen displays can be customized, refer to *Onscreen Displays* ( 48). For details on the setting options, refer to *[Custom Display 1]* and *[Custom Display 2]* ( 136).

Operating modes: **CAMERA** **MEDIA**

- 1 Open the [Custom Display 1] or [Custom Display 2] submenu.  
 LCD/VF Setup] [Custom Display 1] or [Custom Display 2]
- 2 Select the desired onscreen display.
- 3 Change the setting option and then press the joystick.

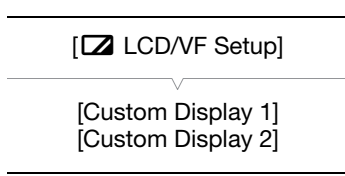











## Saving and Loading Camera Settings

After you adjust custom picture settings and settings in the various menus, you can save those settings on an SD card. You can load those settings at a later date or on another C100 camcorder so that you can use that camcorder in that same exact way.







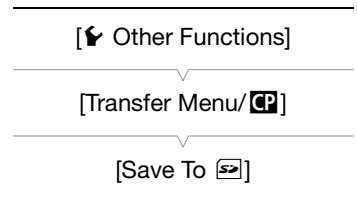



Operating modes: CAMERA MEDIA

### Saving Camera Settings to an SD Card

- Open the [Save To ] submenu.  
[ Other Functions]  [Transfer Menu/]  [Save To ]
- Select [A] or [B] and then press the joystick.
- Select [Menu] or [Menu+] and then press the joystick.
  - Selecting [Menu] will save menu settings and [Menu+] will save menu and custom picture settings.
- Select [OK] and then press the joystick.
  - The current settings are saved to the SD card. If the SD card already has camera settings on it, they will be overwritten.
- When the confirmation screen appears, press the joystick.



### Loading Camera Settings from an SD Card

- Open the [Load From ] submenu.  
[ Other Functions]  [Transfer Menu/]  [Load From ]
- Select [A] or [B] and then press the joystick.
- Select [Menu] or [Menu+] and then press the joystick.
  - Selecting [Menu] will load menu settings and [Menu+] will load menu and custom picture settings.
- Select [OK] and then press the joystick.
- When the confirmation screen appears, press the joystick.

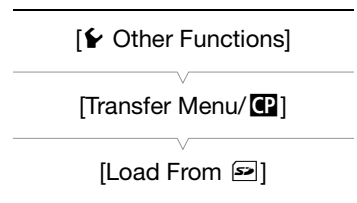

#### NOTES

- The SD card includes a text file that lists the camera settings. You can check the settings by using a USB card reader to access the SD card on a computer. In the "PRIVATE\CAMSET" folder, open the file "CAMSET4.TXT".
- When loading camera settings from an SD card, even protected custom picture files in the camcorder will be replaced.
- Only camera settings from other Canon C100 camcorders can be used with this camcorder.





## Playback

This section explains how to play back clips recorded on an SD card. For details on playing back clips using an external monitor, refer to *Connecting to an External Monitor* (📖 118). For details on viewing photos, refer to *Viewing Photos* (📖 127).

Operating modes: CAMERA MEDIA

### Clip Index Screen

Playback functions are accessed from the clip index screen. To open the clip index screen, set the camcorder to MEDIA mode.

Set the **POWER** switch to **MEDIA**.

- The camcorder switches to MEDIA mode and the clip index screen appears.
- Clips recorded at a system frequency other than the one currently used by the camcorder, cannot be played back. To play back such clips, change the camcorder's system frequency (📖 51) to match the recordings on the SD card.

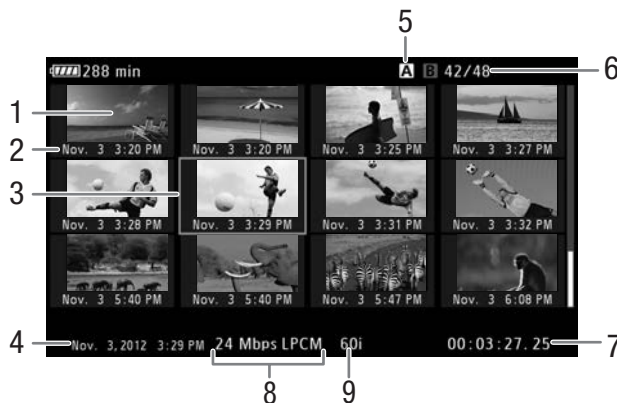
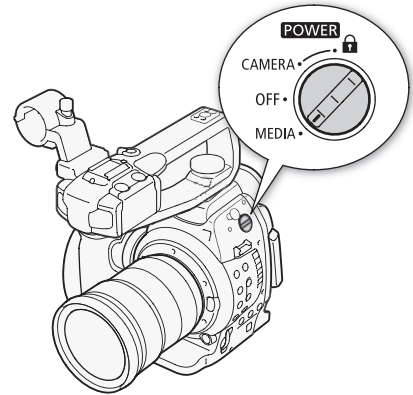

- |   |  |   |   |
|---|--|---|---|
| 1 | Clip thumbnail                               | 5 | Currently selected SD card slot (📖 106)   |
| 2 | Recording date (month and day only) and time | 6 | Clip number / Total number of clips       |
| 3 | Orange selection frame                       | 7 | Clip's start time code                    |
| 4 | Recording date and time                      | 8 | Bit rate and audio recording mode* (📖 51) |
|   |  | 9 | Frame rate (📖 51)                         |

\* The audio recording mode is only displayed for clips recorded using the [24 Mbps LPCM] bit rate.

### Switching Between the SD Card Slots

If both SD card slots contain an SD card, you can switch between them as necessary.

Operating modes: **CAMERA** **MEDIA**

Press the **SLOT SELECT** button.

- The access indicator of the selected SD card slot will illuminate in green.

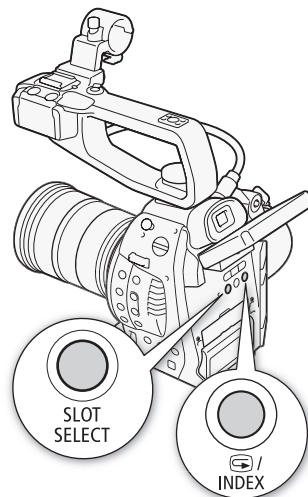

### Switching to Other Index Screens

The clip index screen shows AVCHD clips that were recorded on the SD card using the camcorder. To view other recordings on the same SD card, you will need to open a different index screen. Open the [Photos] index screen to view photos, the [SD Movies] index screen to access clips that were converted to standard definition, or the [Shot List] index screen to view only shots recorded during continuous recording.

Operating modes: **CAMERA** **MEDIA**

- 1 Press the **INDEX** button.
  - The index screen selection menu appears.
- 2 Select the desired index screen and then press the joystick.
  - The selected index screen appears.
  - Select [Cancel] instead to cancel the operation.
  - Press the **INDEX** button again to return to the clip index screen.

#### **i** NOTES

- If you set the camcorder to **MEDIA** mode during continuous recording mode, the [Shot List] index screen will open automatically.

## Playing Back Clips

You can play back clips from the clip index screen. You can control the playback with the controls on the camcorder or with the joystick and onscreen joystick guide.

1 Move the orange selection frame to the clip you want to play back.

2 Press the ►/|| button to start playback.

- Playback will start from the clip selected and continue until the end of the last clip in the index screen. When the last frame of the last clip is reached, playback will be paused.
- Press the ►/|| button again or press the joystick to pause/resume the playback.
- Press the ■ button to stop the playback and return to the index screen.

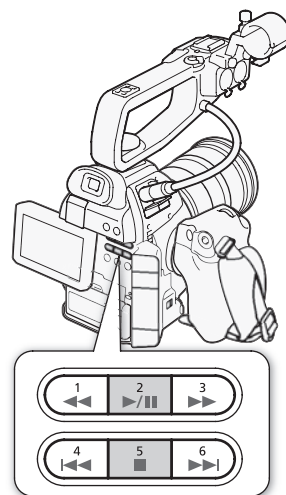

### ! IMPORTANT

- Observe the following precautions while either of the SD card access indicators is illuminated in red. Failure to do so may result in permanent data loss.
  - Do not disconnect the power source or turn off the camcorder.
  - Do not open the SD card compartment cover and do not remove the SD cards.

### i NOTES

- You may notice brief stops in video or audio playback between clips.
- Playback of clips converted to standard definition (□ 113) is limited to only ► (play) and ■ (stop). Also, playback will stop at the end of each clip.

## Onscreen Displays



- |   |   |
|---|---|
| 1 Remaining battery time (📖 49)           | 9 Bit rate and audio recording mode** (📖 51)              |
| 2 Temperature warning (📖 37)              | 10 Frame rate (📖 51)                                      |
| 3 Joystick guide (📖 109)                  | 11 Onscreen displays superimposed on video output (📖 120) |
| 4 Recording date and time*                | 12 User bit (📖 73)  |
| 5 Playback operation                      | 13 Audio output channel (📖 121)                           |
| 6 Currently selected SD card slot (📖 106) | 14 Audio level meter***                                   |
| 7 Time code (📖 70)                        |   |
| 8 Clip number / Total number of clips     |   |

\* Appears when [LCD/VF Setup] [Date/Time] is set to [On].

\*\* The audio recording mode is only displayed for clips recorded using the [24 Mbps LPCM] bit rate.

\*\*\* Appears when [LCD/VF Setup] [Audio Level] is set to [On].

### 5 Playback operation

- |          |                             |
|----------|-----------------------------|
| ▶ PLAY   | Playback                    |
| ⏸ PAUSE  | Playback pause              |
| ◀▶/▶▶    | Frame reverse/Frame advance |
| F FWD ▶▶ | Fast playback*              |
| ◀◀ F REV | Fast reverse playback*      |

\* The playback speed (x5, x15 or x60) will also appear in the indicator.

## Playback Controls

When you play back a clip, operate the buttons on the camcorder's body or use the joystick and joystick guide to use fast playback, play back frame-by-frame or skip clips. Refer to the following table.

### Available Playback Types

Playback type	Operation
Fast playback	Buttons: Press the ◀◀ or ▶▶ button. Joystick: During playback, push the joystick up or down. Repeat to increase the playback speed to approximately 5x → 15x → 60x the normal speed.
Frame advance/reverse	Joystick: During playback pause, push the joystick up or down.
Skip to the beginning of the next clip	Buttons: Press the ▶▶  button. Joystick: Push the joystick right.
Skip to the beginning of the current clip	Buttons: Press the ◀◀ button. Joystick: Push the joystick left.
Skip to the previous clip	Buttons: Press the ◀◀ button twice. Joystick: Push the joystick left twice.
Return to playback mode	Buttons: Press the ▶/   button. Joystick: Press the joystick itself.

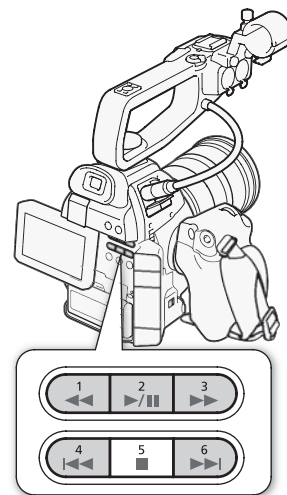

### NOTES

- There is no audio during any of the playback types listed in the previous table.
- During some special playback modes, you may notice some anomalies (blocky video artifacts, banding, etc.) in the playback picture.
- The speed indicated on the screen is approximate.
- You can press the DISP. button to turn the joystick guide display on and off.

## Adjusting the Volume

During playback, audio will come from the monaural built-in speaker or headphones. When you connect headphones to the  (headphone) terminal, the built-in speaker will be muted.

1 Open the [Headphone Volume] or [Speaker Volume] submenu.

 [Audio Setup]  [Audio Output]  [Headphone Volume] or [Speaker Volume]

2 Select the desired level and then press the joystick.

- Select [Off] to mute the audio.

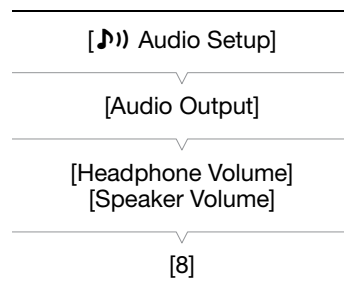

**i** NOTES

- For details on changing the audio channel, refer to *Selecting the Audio Channel* (📖 121).
- If you set an assignable button to [Headphone +], [Headphone -], [Speaker +] or [Speaker -] (📖 89), you can press the button to adjust the headphone volume or built-in speaker volume without using the menu.

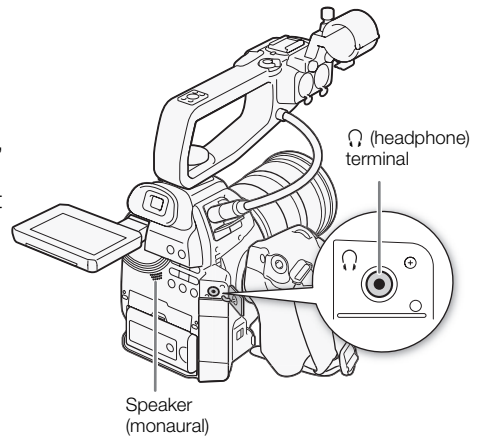

## Clip Operations

You can use the clip menu to copy\* clips, delete clips, and convert\* clips to standard definition. Clip menu functions apply only to a single clip. Selecting the same functions from the [👉 Other Functions] ➤ [Clips] submenu, you can perform the same operations on multiple clips (selected clips or all clips).

\* Original AVCHD clips in the clips index screen only.

Operating modes: CAMERA MEDIA

### Using the Clip Menu

- 1 Select a clip and then press the joystick.
  - The clip menu appears.
- 2 Select the desired function and then press the joystick.
- 3 Select [OK] and then press the joystick to perform the operation.
  - Select [Cancel] instead to cancel the operation.
- 4 When the confirmation message appears, press the joystick.

#### ! IMPORTANT

- Observe the following precautions while either of the SD card access indicators is illuminated in red. Failure to do so may result in permanent data loss.
  - Do not disconnect the power source or turn off the camcorder.
  - Do not open the SD card compartment cover and do not remove the SD cards.

#### i NOTES

- When performing clip operations, make sure the LOCK switch on the SD cards used is not set to prevent writing.

### Copying Clips

You can copy clips from one SD card to the other.

#### Copying a Single Clip

- 1 Select the desired clip and then press the joystick to open the clip menu.
- 2 Select [Copy Clip] and then press the joystick.
- 3 Select [OK] and then press the joystick.
  - Select [Cancel] instead to cancel the operation.
  - While the clip is being copied, you can press the joystick to cancel.
- 4 When the confirmation message appears, press the joystick.
  - The selected clip is copied to the other SD card and the screen changes back to the clip index screen.

### Copying a Selection of Clips

- 1 Open the clip selection index screen.  
 [👉 Other Functions] ➤ [Clips] ➤ [Copy] ➤ [Select]
- 2 Using the joystick, bring the orange selection frame to a clip you wish to copy and then press the joystick.
  - A checkmark  will appear next to the clip's thumbnail to indicate it was selected. Press the joystick again to remove the checkmark.
  - Repeat this step to select all the clips you wish to copy. The total number of selected clips will appear at the bottom of the screen, next to the  icon.
- 3 After selecting all the desired clips, press the MENU button.
- 4 Select [OK] and then press the joystick.
  - Select [Cancel] instead to return to the clip selection screen.
  - While the clips are being copied, you can press the joystick to cancel.
- 5 When the confirmation message appears, press the joystick.

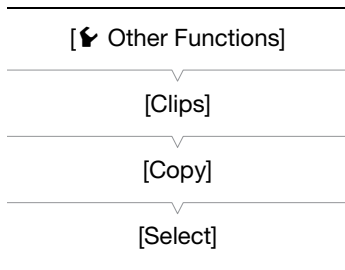

### Copying All Clips

- 1 Open the [Clips Copy All] screen.  
 [👉 Other Functions] ➤ [Clips] ➤ [Copy] ➤ [All]
- 2 Select [OK] and then press the joystick.
  - All of the clips on the selected SD card will be copied to the other SD card.
  - Select [Cancel] instead to cancel the operation.
  - While the clips are being copied, you can press the joystick to cancel.
- 3 When the confirmation message appears, press the joystick.

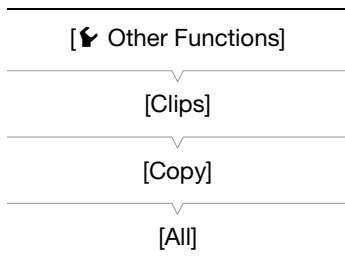

### Deleting Clips and Shots

You can delete clips or shots you are not interested in keeping from the SD card. When you delete a shot, only the in point/out point marks within the continuous recording clip are deleted but the video file itself is not deleted. Although the following procedures make reference only to clips, unless stated otherwise, the procedures are the same when deleting shots.

#### Deleting a Single Clip/Shot

- 1 Select the desired clip and then press the joystick to open the clip menu.
- 2 Select [Delete Clip] or [Delete Shot] and then press the joystick.
- 3 Select [OK] and then press the joystick.
  - Select [Cancel] instead to cancel the operation.
  - While the clip is being deleted, the operation cannot be canceled.
- 4 When the confirmation message appears, press the joystick.



### Deleting a Selection of Clips/Shots

- Open the clip selection or shot selection index screen.  
 [Other Functions] ➤ [Clips] ➤ [Delete] ➤ [Select]  
 [Other Functions] ➤ [Delete Shots] ➤ [Select]
- Using the joystick, bring the orange selection or shot selection frame to a clip you wish to delete and then press the joystick.
  - A checkmark  will appear next to the clip's thumbnail to indicate it was selected. Press the joystick again to remove the checkmark.
  - Repeat this step to select all the clips you wish to delete. The total number of selected clips will appear at the bottom of the screen, next to the  icon.
- After selecting all the desired clips, press the MENU button.
- Select [OK] and then press the joystick.
  - Select [Cancel] instead to return to the clip selection screen.
  - While the clips are being deleted, you can press the joystick to cancel.
- When the confirmation message appears, press the joystick.

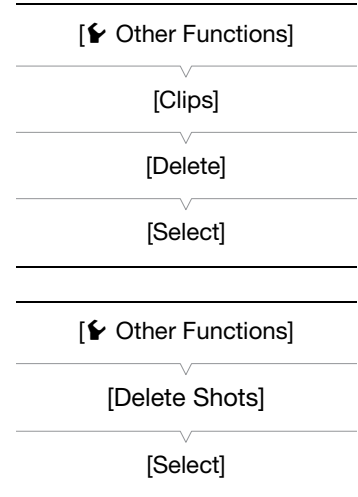

### Deleting All Clips/Shots

- Open the [Clips Delete All] or [Delete Shots All] screen.  
 [Other Functions] ➤ [Clips] ➤ [Delete] ➤ [All]  
 [Other Functions] ➤ [Delete Shots] ➤ [All]
- Select [OK] and then press the joystick.
  - All of the clips on the selected SD card will be deleted.
  - Select [Cancel] instead to cancel the operation.
  - While the clips are being deleted, you can press the joystick to cancel.
- When the confirmation message appears, press the joystick.

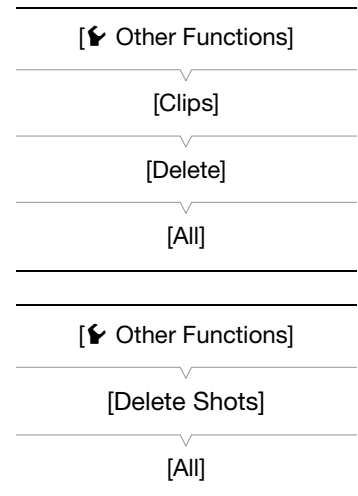

## Converting Clips to Standard Definition

You can convert original AVCHD clips to standard definition (MPEG-2) movies. The down-conversion to standard definition requires two SD cards: one (source) that contains the source clips to be converted and the other one (destination) that will store the converted files (SD movies).

### Converting a Single Clip to Standard Definition

- Select the desired clip from the index screen of the source card and then press the joystick to open the clip menu.
- Select [Convert HD ➔ SD] and then press the joystick.
  - The estimated size of the converted SD movie and the available space on the destination card will be displayed on the screen.
- Select [OK] and then press the joystick.
  - Select [Cancel] instead to cancel the operation.

- The clip will be played back as it is converted. While the clip is being converted, you can press the joystick to cancel.
- 4 When the confirmation message appears, press the joystick.
    - The selected clip is converted to an SD movie on the destination card and the screen changes back to the clip index screen.

### Converting a Selection of Clips to Standard Definition

- 1 From the index screen of the source card, open the clip selection index screen.
 

[Other Functions] ➤ [Clips] ➤ [Convert HD➔SD] ➤ [Select]
- 2 Using the joystick, bring the orange selection frame to a clip you wish to convert and then press the joystick.
  - A checkmark  will appear next to the clip's thumbnail to indicate it was selected. Press the joystick again to remove the checkmark.
  - Repeat this step to select all the clips you wish to convert. The total number of selected clips will appear at the bottom of the screen, next to the  icon.
- 3 After selecting all the desired clips, press the MENU button.
  - The estimated total size of the converted SD movies and the available space on the destination card will be displayed on the screen.
- 4 Select [OK] and then press the joystick.
  - Select [Cancel] instead to return to the clip selection screen.
  - The selected clips will be played back as they are converted. While the clips are being converted, you can press the joystick to cancel.
- 5 When the confirmation message appears, press the joystick.

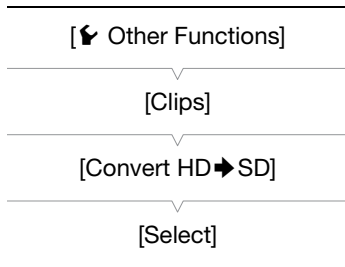

### Converting All Clips to Standard Definition

- 1 From the index screen of the source card, open the [Clips Convert HD➔SD All] screen.
 

[Other Functions] ➤ [Clips] ➤ [Convert HD➔SD] ➤ [All]

  - The estimated total size of the converted SD movies and the available space on the destination card will be displayed on the screen.
- 2 Select [OK] and then press the joystick.
  - All of the clips on the source card will be converted to SD movies on the destination card.
  - Select [Cancel] instead to cancel the operation.
  - The clips will be played back as they are converted. While the clips are being converted, you can press the joystick to cancel.
- 3 When the confirmation message appears, press the joystick.

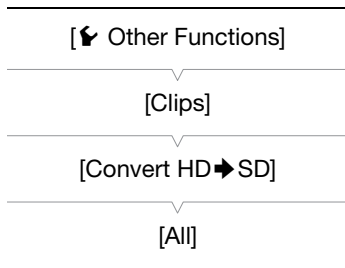

### NOTES

- The maximum total playback time of the clips to be converted to standard definition is 12 hours.
- The bit rate of converted SD movies is 9 Mbps.
- Clips recorded with the 24P frame rate cannot be converted to standard definition.
- Clips are played back as they are converted to standard definition. If you set an assignable button to [Headphone +], [Headphone -], [Speaker +] or [Speaker -] (□ 89), you can press the button to adjust the headphone volume or built-in speaker during the conversion.
- Clips cannot be converted to standard definition when the SD card already contains the maximum number of folders or clips (□ 147).

## Deleting SD Movies

From the [SD Movies] index screen you can delete clips that were converted to standard definition.

### Deleting a Single SD Movie

- 1 Open the [SD Movies] index screen (📖 106).
- 2 Select the desired SD movie and then press the joystick to open the clip menu.
- 3 Select [Delete Clip] and then press the joystick.
- 4 Select [OK] and then press the joystick.
  - Select [Cancel] instead to cancel the operation.
  - While the SD movie is being deleted, the operation cannot be canceled.
- 5 When the confirmation message appears, press the joystick.

### Deleting All SD Movies

- 1 Open the [SD Movies] index screen (📖 106).
- 2 Open the [Clips Delete All] screen.  
[👉 Other Functions] ➤ [Clips] ➤ [Delete] ➤ [All]
- 3 Select [OK] and then press the joystick.
  - All the SD movies will be deleted.
  - Select [Cancel] instead to cancel the operation.
  - While the SD movies are being deleted, you can press the joystick to cancel.
- 4 When the confirmation message appears, press the joystick.

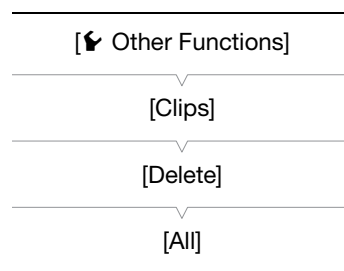



## Video Output Configuration

The video signal output from the HDMI OUT terminal depends on the various menu settings and the capabilities of the external monitor. Video from the AV OUT terminal is output as 480/59.94i (59.94 Hz recordings) or 576/50.00i (50.00 Hz recordings). If necessary, you can superimpose the onscreen displays on the video displayed on the external monitor (📖 120).

Operating modes: CAMERA MEDIA

### Video Output Configuration by Terminal

Terminal		[System Frequency] set to [59.94 Hz]	[System Frequency] set to [50.00 Hz]
HDMI OUT	HD Output*	1080/59.94i	1080/50.00i
	SD Output	480/59.94P	576/50.00P
AV OUT	SD Output	480/59.94i	576/50.00i

\* You can use the [ LCD/VF Setup] ➤ [Zebra HD Output] setting to display the zebra patterns on an external monitor (HD output only).

## Connecting to an External Monitor

When you connect the camcorder to an external monitor for recording or playback, use the terminal on the camcorder that matches the one you wish to use on the monitor. Then, select the video signal output configuration (📖 117).

Operating modes: CAMERA MEDIA

### Connection Diagram

We recommend that you power the camcorder from a household power outlet using the compact power adapter.

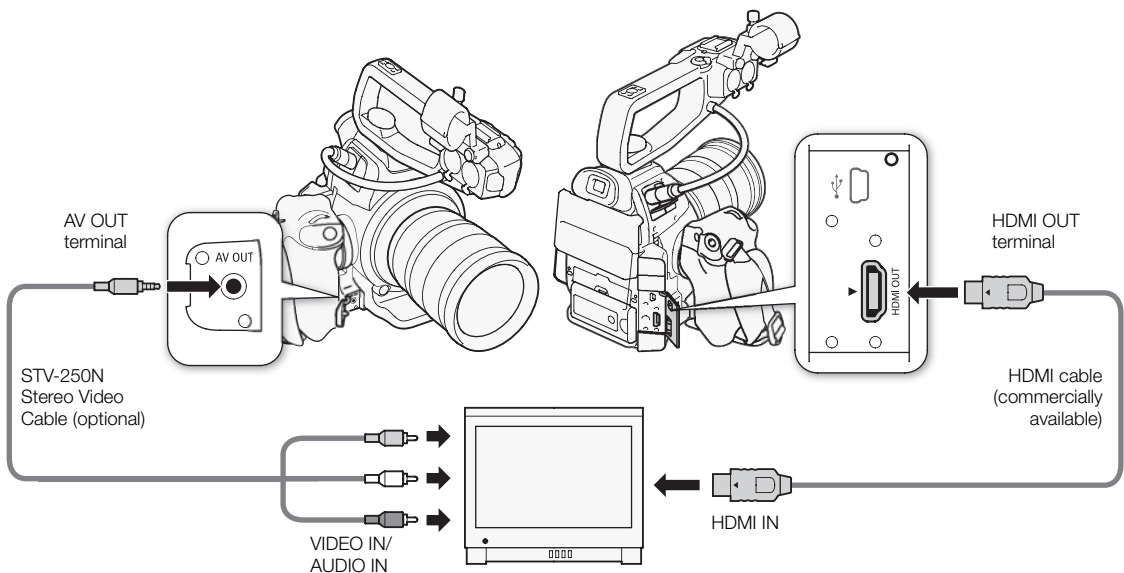

### Using the HDMI OUT Terminal

The HDMI™ OUT terminal offers a digital connection and outputs both a video and audio signal. The output signal will automatically switch to HD or SD depending on the capability of the external monitor. Audio will be output as a 2ch linear PCM (16 bits, 48 kHz) signal.

#### **i** NOTES

- If necessary, you can superimpose the onscreen displays on the video displayed on the external monitor (📖 120).
- You can select the SD output method (📖 119).
- The HDMI OUT terminal on the camcorder is for output only. Do not connect it to an HDMI output terminal on an external device, as this may damage the camcorder.
- There will be no video output from the AV OUT terminal while an external monitor is connected to the HDMI OUT terminal.
- Correct operation cannot be guaranteed when connecting the camcorder to DVI monitors.
- Video may not be output correctly depending on the monitor. In such case, use the AV OUT terminal.

## Using the AV OUT Terminal

The AV OUT terminal outputs a down-converted analog video signal and audio signal for connection to monitors with a composite audio/video input.

### NOTES

- When you play back a clip on a monitor with a 4:3 aspect ratio, the monitor will switch automatically to widescreen mode if it is compatible with the Video ID-1 or WSS system.
- If necessary, you can superimpose the onscreen displays on the video displayed on the external monitor ( 120).

## SD Output

When HD video (16:9 aspect ratio) is converted and output as SD video (4:3 aspect ratio), you can choose how it appears on the external monitor.

Operating modes: CAMERA MEDIA

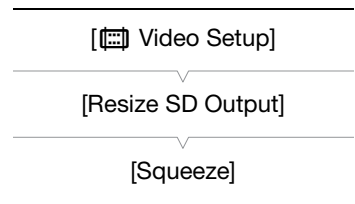

1 Open the [Resize SD Output] submenu.

 Video Setup  [Resize SD Output]

2 Select the desired option and then press the joystick.

### Options

- [Letterbox]: The 16:9 aspect ratio is maintained but black letterbox bars are added to the top and bottom of the image.
- [Squeeze]: The image is squeezed from the left and right so that the entire image fits within the screen. The image will appear normal if the external monitor also has a 16:9 aspect ratio.
- [Side Crop]: The left and right sides of the image are cropped so that the central part of the image fits within the screen.



Original image (16:9)

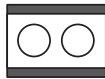

[Letterbox] setting

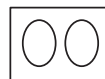

[Squeeze] setting



[Side Crop] setting

### NOTES

- The [Resize SD Output] setting applies also to the reviewing of the last clip recorded ( 83).
- In CAMERA mode, the [Squeeze] setting is applied and cannot be changed.

## Superimposing Onscreen Displays to Appear on an External Monitor

By default, onscreen displays are shown on the viewfinder but you can choose to superimpose onscreen displays on video output from the HDMI OUT terminal or AV OUT terminal. Doing so will display the onscreen displays on an external monitor. You must set this function separately for HD and SD output. This setting will not affect your recordings.

Operating modes: CAMERA MEDIA

In CAMERA mode, you need to select where the onscreen displays will be output. Perform all the procedure from the beginning. In MEDIA mode, onscreen displays will automatically disappear from the viewfinder's screen when video is being output from one of the terminals, so steps 1 and 2 are not necessary. Start the procedure from step 3.

### 1 Open the [Character Display] submenu.

[Video Setup] ➤ [Character Display]

### 2 Select [Ext. Out] and then press the joystick.

### 3 Open the [HD Onscreen Disp.] or [SD Onscreen Disp.] submenu.

[Video Setup] ➤ [HD Onscreen Disp.] or [SD Onscreen Disp.]

### 4 Select [On] and then press the joystick.

- **DISP** appears on the upper right of the screen (when  LCD/VF Setup) ➤ [Custom Display 2] ➤ [Output Display] is set to [On]).

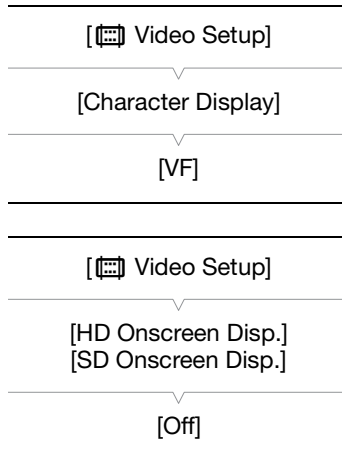

## **i** NOTES

- Onscreen displays cannot appear simultaneously on the viewfinder and on an external monitor connected to one of the video output terminals.
- During SD video output, onscreen displays will not appear on an external monitor if [Video Setup] ➤ [Resize SD Output] is set to [Side Crop].
- If you set an assignable button to [Onscreen Display] (89), you can press the button to turn on and off the superimposing of onscreen displays on video output from the camcorder's terminals (simultaneously for HD and SD video).





## Audio Output



The camcorder can output audio from the HDMI OUT terminal, AV OUT terminal or  (headphone) terminal. When audio is output from the AV OUT terminal or  (headphone) terminal, you can configure other settings, such as the output channel.

### Synchronizing the Video with the Audio being Monitored

When audio is output from the AV terminal or  (headphone) terminal, you can choose to synchronize the audio signal with the video signal or have the camcorder output the audio in real time. When the audio is output in real time, there will be a slight delay. Regardless of the setting, however, the audio and video signals recorded will be synchronized.

Operating modes:

1 Open the [Monitor Delay] submenu.

 [Audio Setup]  [Audio Output]  [Monitor Delay]

2 Select the desired option and then press the joystick.

#### Options

[Line Out]: Synchronizes the audio and video signals.

[Normal]: Allows you to monitor the audio in real time.

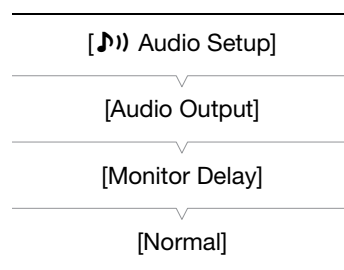

### Selecting the Audio Channel

You can select the audio channel that is output from the AV OUT terminal or  (headphone) terminal.

Operating modes:

1 Open the [Channel] submenu.

 [Audio Setup]  [Audio Output]  [Channel]

2 Select the desired option and then press the joystick.

#### Options

[CH1/CH2]: Audio from CH1 is output from the left audio channel and audio from CH2 is output from the right audio channel.

[CH1/CH1]: Audio from CH1 is output from both the left and right audio channels.

[CH2/CH2]: Audio from CH2 is output from both the left and right audio channels.

[All/All]: Audio from CH1 and CH2 is mixed and output from both the left and right audio channels.

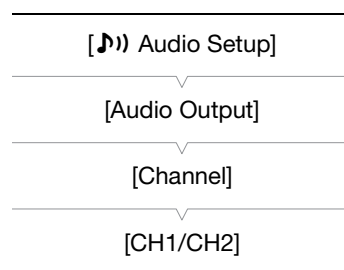

#### NOTES

- If you set an assignable button to [Audio Output CH] ( 89), you can press the button to change the audio channel directly.

## Selecting the Output Level of the AV OUT Terminal

You can select the output level of audio that is output from the AV OUT terminal.

Operating modes:

1 Open the audio output [Level] submenu.

[] Audio Setup] [Audio Output] [Level]

2 Select the desired level and then press the joystick.

### Options

[1 Vrms]: The audio output level is normal.

[2 Vrms]: The audio output level is 6 dB higher.

### NOTES

- This setting does not affect audio output to headphones.

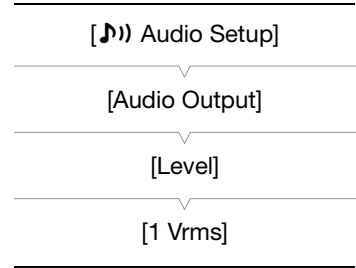

## Saving Clips to a Computer

Using the supplied software **Data Import Utility** to save your clips, you have the additional advantage of automatically joining clips that were saved as multiple files so you can work with them as single clips with the editing software of your choice.

Operating modes: CAMERA MEDIA

### Saving Clips Using Data Import Utility:

- Save clips to the computer (all clips/new clips only).
- Join relay clips (📄 41) that were saved on separate SD cards and save them as a single clip.
- Join multiple video stream files of a single clip split because of the 2 GB maximum file size restriction and save them as a single clip.

For more details, check the **Data Import Utility** Software Guide, a PDF file\* in the [Manual\English] folder of the supplied PIXELA CD-ROM.

\* Adobe® Reader® 6 or later is required to view the PDF file.

### Installing the Software

See *Installation* and *System requirements* in the **Data Import Utility** Software Guide (PDF file) for step-by-step installation instructions and full system requirements. Below are the main system requirements.

OS	Windows Vista*, SP2 Windows 7*, SP1 Windows 8*	Mac OS X 10.6, 10.7, 10.8
CPU	Intel® Core or equivalent	Intel® CPU (not compatible with Power PC)
RAM	1 GB (2 GB for Windows 7/Windows 8, 64-bit version or Mac OS X 10.7/10.8)	
Display	1024 x 768 pixels	

\* 32-bit and 64-bit versions.

### Connection Diagram

We recommend that you power the camcorder from a household power outlet using the compact power adapter.

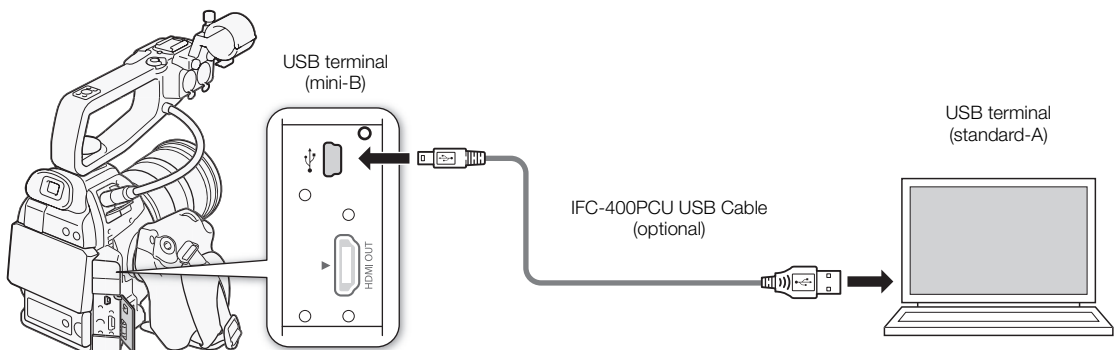



## Taking Photos

You can take photos when the camcorder is in **CAMERA** mode or you can capture a photo from a clip when the camcorder is in **MEDIA** mode. The size of the photos recorded on the SD card is 1920 x 1080\*.

\* At this size, the camcorder can save approximately 670 photos on a 1 GB SD card.

### Taking Photos in CAMERA Mode

You can take a photo while the camcorder is recording a clip or is in record pause mode. If a custom picture file is selected in advance, it will be recorded with the photo (📖 92). To take a photo, set an assignable button to [Photo] in advance.

Operating modes: **CAMERA** **MEDIA**

- 1 Set an assignable button to [Photo] (📖 89).
- 2 Press the assignable button to take a photo.
  - The icon of the selected SD card (**A** or **B**) and the number of available photos appear momentarily on the upper right of the screen.
  - If a custom picture file is selected, it will be recorded with the photo.
  - The SD card access indicator will illuminate in red as the photo is being recorded.

### Capturing Photos in MEDIA Mode

You can capture a photo from a clip during playback pause. To capture a photo, set an assignable button to [Photo] in advance.





Operating modes: **CAMERA** **MEDIA**

- 1 Set an assignable button to [Photo] (📖 89).
- 2 Select the desired clip and press the ▶/|| button to start playback.
- 3 Pause the playback at the point you want to capture.
- 4 Press the assignable button to capture a photo.
  - The screen will momentarily turn black as if a camera shutter had released.
  - The icon of the selected SD card (**A** or **B**) and the number of available photos appear momentarily on the upper right of the screen.
  - The SD card access indicator will illuminate in red as the photo is being recorded.
- 5 Press the ■ button to stop playback.

#### ! IMPORTANT

- Observe the following precautions while either of the SD card access indicators is illuminated in red. Failure to do so may result in permanent data loss.
  - Do not disconnect the power source or turn off the camcorder.
  - Do not open the SD card compartment cover and do not remove the SD cards.

 NOTES

- If the LOCK switch on the SD card selected for recording is set to prevent writing, you will not be able to record a photo. Change the position of the LOCK switch in advance.
- Even if [ Other Functions]  [Custom Function]  [Scan Reverse Rec] ( 102) is set to a setting other than [Off], photos will not be inverted.

## Photo Playback

You can view the photos that you took with the camcorder.

Operating modes: CAMERA MEDIA

### Displaying the [Photos] Index Screen

Display the [Photos] index screen to view photos.

- 1 Set the **POWER** switch to MEDIA.
  - The camcorder switches to MEDIA mode and the clip index screen appears.
- 2 Press the INDEX button.
  - The index screen selection menu appears.
- 3 Select [Photos] and then press the joystick.
  - The [Photos] index screen appears.
  - After you are finished viewing photos, press the INDEX button to return to the clip index screen.

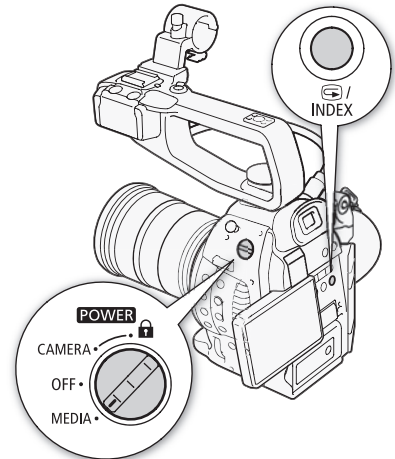

### Viewing Photos

- 1 Move the orange selection frame to the desired photo.
- 2 Press the ►/|| button to view the photo.
  - The photo playback screen appears and the selected photo is displayed.
  - Use the ◀◀/▶▶ buttons or push the joystick left/right to switch to the previous/next photo.
  - Press the DISP. button to hide/show the onscreen displays.
  - Press the ■ button to return to the [Photos] index screen.

#### ! IMPORTANT

- Observe the following precautions while either of the SD card access indicators is illuminated in red. Failure to do so may result in permanent data loss.
  - Do not disconnect the power source or turn off the camcorder.
  - Do not open the SD card compartment cover and do not remove the SD cards.

#### i NOTES

- The following photos may not be displayed correctly.
  - Photos not recorded with this camcorder.
  - Photos created or edited on a computer.
  - Photos whose file names have been changed.

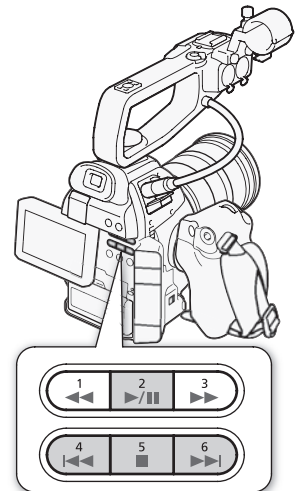

## Photo Operations

You can use the photo menu to copy a photo, delete a photo, or copy a custom picture file embedded in a photo. You can display the photo menu from the [Photos] index screen or photo playback screen.

### Using the Photo Menu

- 1 From the [Photos] index screen, select a photo and then press the joystick.
  - If you are viewing a photo, simply press the joystick.
  - The photo menu appears. Available functions depend on the photo's settings.
- 2 Select the desired function and then press the joystick.

### Copying Photos

You can copy photos from one SD card to the other.

Operating modes: CAMERA MEDIA

#### Copying a Photo from the Playback Screen

- 1 Display the photo to be copied (📖 127).
- 2 Press the joystick to open the photo menu.
- 3 Select [Copy] and then press the joystick.
- 4 Select [OK] and then press the joystick.
  - Select [Cancel] instead to cancel the operation.
  - The selected photo is copied.
- 5 When the confirmation message appears, press the joystick.

#### Copying a Photo from the Index Screen

- 1 Open the [Photos] index screen (📖 127).
- 2 Move the orange selection frame to the photo to be copied.
- 3 Press the joystick to open the photo menu.
- 4 Select [Copy] and then press the joystick.
- 5 Select [OK] and then press the joystick.
  - Select [Cancel] instead to cancel the operation.
  - The selected photo is copied.
- 6 When the confirmation message appears, press the joystick.



### Copying a Selection of Photos

- From the [Photos] index screen open the photo selection screen.  
[👉 Other Functions] ➤ [Photos] ➤ [Copy] ➤ [Select]
- Using the joystick, bring the orange selection frame to a photo you wish to copy and then press the joystick.
  - A checkmark  will appear next to the photo's thumbnail to indicate it was selected. Press the joystick again to remove the checkmark.
  - Repeat this step to select all the photos you wish to copy. The total number of selected photos will appear at the bottom of the screen, next to the  icon.
- After selecting all the desired photos, press the MENU button.
- Select [OK] and then press the joystick.
  - Select [Cancel] instead to return to the photo selection screen.
  - While the photos are being copied, you can press the joystick to cancel.
- When the confirmation message appears, press the joystick.

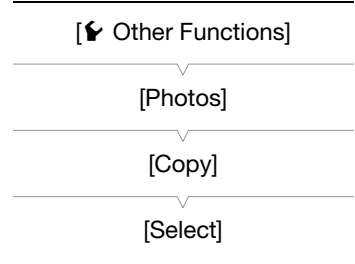

129

### Copying All Photos

- From the [Photos] index screen open the [Photos Copy All] screen.  
[👉 Other Functions] ➤ [Photos] ➤ [Copy] ➤ [All]
- Select [OK] and then press the joystick.
  - Select [Cancel] instead to cancel the operation.
  - While the photos are being copied, you can press the joystick to cancel.
- When the confirmation message appears, press the joystick.

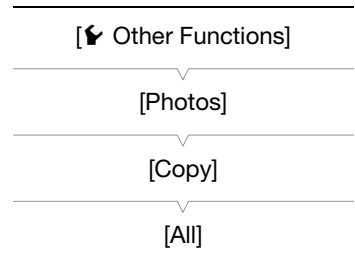

### Deleting Photos

You can delete a photo you no longer need. When you do so, however, the custom picture file embedded in it will also be deleted. Photos can be deleted one at a time from the photo playback screen or [Photos] index screen.

Operating modes: CAMERA MEDIA

### Deleting a Photo from the Playback Screen

- Display the photo to be deleted (📖 127).
- Press the joystick to open the photo menu.
- Select [Delete] and then press the joystick.
- Select [OK] and then press the joystick.
  - Select [Cancel] instead to cancel the operation.
  - The selected photo is deleted and the next photo is displayed.
  - If a custom picture file is embedded in the photo, it is also deleted.
- When the confirmation message appears, press the joystick.

### Deleting a Photo from the Index Screen

- 1 Open the [Photos] Index Screen (📖 127).
- 2 Move the orange selection frame to the photo to be deleted.
- 3 Press the joystick to open the photo menu.
- 4 Select [Delete] and then press the joystick.
- 5 Select [OK] and then press the joystick.
  - Select [Cancel] instead to cancel the operation.
  - The selected photo is deleted.
  - If a custom picture file is embedded in the photo, it is also deleted.
- 6 When the confirmation message appears, press the joystick.

### Deleting a Selection of Photos

- 1 From the [Photos] index screen open the photo selection screen.  
[👉 Other Functions] ➡ [Photos] ➡ [Delete] ➡ [Select]
- 2 Using the joystick, bring the orange selection frame to a photo you wish to delete and then press the joystick.
  - A checkmark  will appear next to the photo's thumbnail to indicate it was selected. Press the joystick again to remove the checkmark.
  - Repeat this step to select all the photos you wish to delete. The total number of selected photos will appear at the bottom of the screen, next to the  icon.
- 3 After selecting all the desired photos, press the MENU button.
- 4 Select [OK] and then press the joystick.
  - Select [Cancel] instead to return to the photo selection screen.
  - While the photos are being deleted, you can press the joystick to cancel.
- 5 When the confirmation message appears, press the joystick.

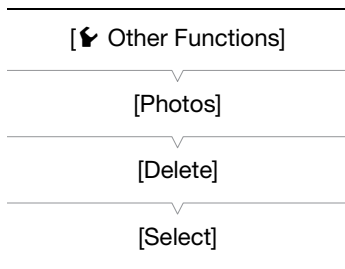

### Deleting All Photos

- 1 From the [Photos] index screen open the [Photos Delete All] screen.  
[👉 Other Functions] ➡ [Photos] ➡ [Delete] ➡ [All]
- 2 Select [OK] and then press the joystick.
  - Select [Cancel] instead to cancel the operation.
  - While the photos are being deleted, you can press the joystick to cancel.
- 3 When the confirmation message appears, press the joystick.

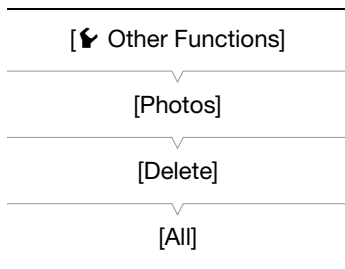

### ! IMPORTANT

- Be careful when deleting photos. Deleted photos cannot be recovered.
- Photos that were protected using other devices cannot be deleted with the camcorder.

## Copying Custom Picture Files

You can copy to the camcorder a custom picture file embedded in a photo. Custom picture files can be copied from the photo playback screen or [Photos] index screen.

Operating modes: CAMERA MEDIA

### Copying a File from the Playback Screen

- 1 Display the photo with the custom picture file to be copied (📖 127).
- 2 Press the joystick to open the photo menu.
- 3 Select [Copy **CP** File] and then press the joystick.
  - The [**CP** Data 1/3] screen appears with a file slot in the camcorder highlighted in orange.
  - Alternatively, you can press the CUSTOM PICTURE button.
  - You can push the joystick up/down to display the [**CP** Data 2/3] and [**CP** Data 3/3] screens.
- 4 Push the joystick left/right to select the desired file slot and then press the joystick.
- 5 Select [OK] and then press the joystick.
  - The custom picture file embedded in the selected photo is copied, overwriting the file in that slot.
  - Select [Cancel] instead to cancel the operation.
- 6 When the confirmation message appears, press the joystick.

### Copying a File from the Index Screen

- 1 Open the [Photos] Index Screen (📖 127).
- 2 Move the orange selection frame to the photo with the custom picture file to be copied.
- 3 Press the joystick to open the photo menu.
- 4 Select [Copy **CP** File] and then press the joystick.
  - The [**CP** Data 1/3] screen appears with the orange selection frame indicating a file slot in the camcorder.
  - Alternatively, you can press the CUSTOM PICTURE button.
  - You can push the joystick up/down to display the [**CP** Data 2/3] and [**CP** Data 3/3] screens.
- 5 Push the joystick left/right to select the desired file slot and then press the joystick.
- 6 Select [OK] and then press the joystick.
  - The custom picture file embedded in the selected photo is copied, overwriting the file in that slot.
  - Select [Cancel] instead to cancel the operation.
- 7 When the confirmation message appears, press the joystick.

#### NOTES

- You cannot copy the custom picture file to a file slot with a protected file.
- By default, file slots [C7] to [C9] are protected.



## Menu Options

For details about how to select an item, refer to *Using the Menus* (📖 27). For details about each function, see the reference page. Menu items without a reference page are explained after the tables. Setting options in boldface indicate default values. Menu items not available appear grayed out.

To skip directly to the page of a specific menu:

[📷 Camera Setup] menu	📖 133
[🎧 Audio Setup] menu	📖 134
[📺 Video Setup] menu	📖 134
[📺 LCD/VF Setup] menu	📖 135
[00:00 TC/UB Setup] menu	📖 138
[👉 Other Functions] menu	📖 138
[★ My Menu] customized menu	📖 140

[📷 Camera Setup] menu (CAMERA mode only)

Menu item	Submenu	Setting options	📖
[Light Metering]		[Backlight], [ <b>Standard</b> ], [Spotlight]	62
[AE Shift]		[+2.0], [+1.5], [+1.25], [+1.0], [+0.75], [+0.5], [+0.25], [ <b>±0</b> ], [-0.25], [-0.5], [-0.75], [-1.0], [-1.25], [-1.5], [-2.0]	61
[ISO/Gain]	[Select]	[ <b>ISO</b> ], [Gain]	57
	[Extended Range]	[On], [ <b>Off</b> ]	
	[ISO Increment]	[1 stop], [ <b>1/3 stop</b> ]	
	[Gain]	[ <b>Normal</b> ], [Fine]	
[Iris]	[Mode]*	[Automatic], [ <b>Manual</b> ]	60
	[Iris Increment]	[1/2 stop], [ <b>1/3 stop</b> ], [Fine]	
	[Zoom-Iris Correct.]	[ <b>On</b> ], [Off]	
[Shutter]	[Mode]	[ <b>Speed</b> ], [Angle], [Clear Scan], [Slow], [Off]	54
	[Shutter Increment]	[1/3 stop], [ <b>1/4 stop</b> ]	
[AF Mode]*		[ <b>One Shot</b> ], [Continu.]	65
[Flicker Reduction]		[Automatic], [ <b>Off</b> ]	56
[📷 CINEMA Locked]		[On], [ <b>Off</b> ]	49
[EF-S Lens]		[On], [ <b>Off</b> ]	31
[ABB]		[ <b>Cancel</b> ], [OK]	43
[Color Bars]	[Enable]	[On], [ <b>Off</b> ]	80
	[Type]	When [System Frequency] is set to [59.94 Hz]: [ <b>SMPTE</b> ], [ARIB] When [System Frequency] is set to [50.00 Hz]: [ <b>EBU</b> ], [SMPTE]	
[Periph. Illum. Corr.]		[On], [ <b>Off</b> ]	30

\* Available only when an EF-S 18-135mm f/3.5-5.6 IS STM or EF-S 18-55mm f/3.5-5.6 IS STM lens is attached.

[🔊] Audio Setup] menu

Menu item	Submenu	Setting options	CAMERA	MEDIA	📖
[Audio Input]	[Int. Mic Low Cut]	[Off], [LC1], [LC2]	●	–	76
	[Int. Mic Sensitivity]	[Normal], [High]	●	–	76
	[MIC/Int. Mic Att.]	[On], [Off]	●	–	76
	[MIC Mode]	[Automatic], [Manual]	●	–	75
	[MIC Level]	0 to 99 (50)	●	–	
	[XLR Rec Channel]	[CH1], [CH1/CH2]	●	–	77
	[XLR1 Mic Trimming]	[+12 dB], [+6 dB], [0 dB], [-6 dB], [-12 dB]	●	–	79
	[XLR2 Mic Trimming]				
	[XLR1 Mic Att.]	[On], [Off]	●	–	79
	[XLR2 Mic Att.]				
	[XLR ALC Link]	[Linked], [Separated]	●	–	78
	[Limiter]	[On], [Off]	●	–	75, 78
	[1 kHz Tone]	[-12 dB], [-18 dB], [-20 dB], [Off]	●	–	80
[Audio Output]*	[Monitor Delay]	[Line Out], [Normal]	●	–	121
	[Channel]	[CH1/CH2], [CH1/CH1], [CH2/CH2], [All/All]	●	●	121
	[Level]	[1 Vrms], [2 Vrms]	●	●	122
	[Headphone Volume]	[Off], 1 to 15 (8)	●	●	79, 109
	[Speaker Volume]	[Off], 1 to 15 (8)	–	●	109

\* Not available in the [Photos] index screen.

[📺] Video Setup] menu

Menu item	Setting options	CAMERA	MEDIA	📖
[Character Display]	[VF], [Ext. Out]	●	–	120
[HD Onscreen Disp.]	[On], [Off]	●	●	
[SD Onscreen Disp.]	[On], [Off]	●	●	
[Resize SD Output]	[Letterbox], [Squeeze], [Side Crop]	–	●	119

[ LCD/VF Setup] menu

Menu item	Submenu	Setting options	CAMERA	MEDIA	
[LCD Setup]	[Brightness]	-99 to 99 ( <b>±0</b> )	●	●	33
	[Contrast]	-99 to 99 ( <b>±0</b> )	●	●	
	[Color]	-20 to 20 ( <b>±0</b> )	●	●	
	[Sharpness]	1 to 4 ( <b>2</b> )	●	●	
	[Backlight]	<b>[Normal]</b> , [Bright]	●	●	
[VF Setup]	[Brightness]	-99 to 99 ( <b>±0</b> )	●	●	33
	[Contrast]	-99 to 99 ( <b>±0</b> )	●	●	
	[Color]	-20 to 20 ( <b>±0</b> )	●	●	
	[Sharpness]	1 to 4 ( <b>2</b> )	●	●	
	[Backlight]	<b>[Normal]</b> , [Bright]	●	●	
[LCD/VF B&W]		[On], <b>[Off]</b>	●	●	34
[LCD/VF Simul.]		<b>[On]</b> , [Off]	●	●	33
[View Assist.]		[On], <b>[Off]</b>	●	–	50
[Peaking]		[On], <b>[Off]</b>	●	–	67
[Select]		<b>[Peaking 1]</b> , [Peaking 2]	●	–	
[Peaking 1]	[Color]	<b>[White]</b> , [Red], [Yellow], [Blue]	●	–	
	[Gain]	[Off], 1 to 15 ( <b>8</b> )	●	–	
	[Frequency]	1 to 4 ( <b>2</b> )	●	–	
[Peaking 2]	[Color]	[White], <b>[Red]</b> , [Yellow], [Blue]	●	–	
	[Gain]	[Off], 1 to 15 ( <b>15</b> )	●	–	
	[Frequency]	1 to 4 ( <b>1</b> )	●	–	
[Zebra]		[On], <b>[Off]</b>	●	–	69
[Select]		<b>[Zebra 1]</b> , [Zebra 2], [Zebra 1&2]	●	–	
[Zebra 1 Level]		<b>[70 ±5%]</b> , [75 ±5%], [80 ±5%], [85 ±5%], [90 ±5%], [95 ±5%]	●	–	
[Zebra 2 Level]		[70%], [75%], [80%], [85%], [90%], [95%], <b>[100%]</b>	●	–	
[Zebra HD Output]		[On], <b>[Off]</b>	●	–	
[Markers]	[Enable]	[On], <b>[Off]</b>	●	–	68
	[Center]	[White], [Gray], <b>[Off]</b>	●	–	
	[Horizontal]	[White], [Gray], <b>[Off]</b>	●	–	
	[Grid]	[White], [Gray], <b>[Off]</b>	●	–	
	[Safety Zone]	[White], [Gray], <b>[Off]</b>	●	–	
	[Safety Zone Area]	[80%], [90%], [92.5%], <b>[95%]</b>	●	–	
	[Aspect Marker]	[White], [Gray], <b>[Off]</b>	●	–	
[Aspect Ratio]	[4:3], [13:9], [14:9], [1.66:1], [1.75:1], [1.85:1], <b>[2.35:1]</b>	●	–		
[Audio Level]		<b>[On]</b> , [Off]	–	●*	–

Menu item	Submenu	Setting options	CAMERA	MEDIA	
[Custom Display 1]	[Light Metering]	[On], [Off]	●	—	—
	[Custom Picture]	[On], [Off]	●	—	—
	[Focal Length]	[On], [Off]	●	—	—
	[ND Filter]	[On], [Off]	●	—	—
	[AF Mode]	[On], [Off]	●	—	—
	[Key Lock]	[On], [Off]	●	—	—
	[White Balance]	[On], [Off]	●	—	—
	[Exposure]	[On], [Off]	●	—	—
	[Iris]	[On], [Off]	●	—	—
	[ISO/Gain]	[On], [Off]	●	—	—
	[Shutter]	[On], [Off]	●	—	—
	[Peaking]	[On], [Off]	●	—	—
	[Magnification]	[On], [Off]	●	—	—
	[View Assist.]	[On], [Off]	●	—	—
	[EF-S Lens]	[On], [Off]	●	—	—
[Lens]	[On], [Off]	●	—	—	
[Custom Display 2]	[Remaining Battery]	[Warning], [Normal], [Off]	●	—	—
	[Remaining Rec Time]	[Warning], [Normal], [Off]	●	—	—
	[Rec Mode]	[On], [Off]	●	—	—
	[Time Code]	[On], [Off]	●	—	—
	[Photo]	[Warning], [Normal], [Off]	●	—	—
	[Bit Rate]	[On], [Off]	●	—	—
	[Frame Rate]	[On], [Off]	●	—	—
	[Character Rec]	[On], [Off]	●	—	—
	[Output Display]	[On], [Off]	●	—	—
	[User Bit]	[On], [Off]	●	—	—
	[Audio Output CH]	[On], [Off]	●	—	—
	[Audio Level]	[On], [Off]	●	—	—
	[HDMI Rec Command]	[On], [Off]	●	—	—
	[Temperature/Fan]	[On], [Off]	●	—	—
	[Date/Time]	[Date/Time], [Time], [Date], [Off]	●	—	—
[Date/Time]	[On], [Off]	—	●*	—	

\* Not available in the [Photos] index screen.

[Audio Level]: Displays the audio level meter when set to [On].

### [Custom Display 1] settings

[Light Metering]: When set to [On], the light metering icon (\* or ) is displayed if [ Camera Setup] [Light Metering] is set to [Backlight] or [Spotlight].

[Custom Picture]: Displays the custom picture icon () when set to [On], indicating that a custom picture file was selected and its custom picture settings will be applied.

[Focal Length]: Displays the current focal length of an attached EF lens when set to [On].

[ND Filter]: Displays the ND filter indicator when set to [On].

[AF Mode]: When set to [On], displays the autofocus icon (AF) if the focus mode switch on the attached EF lens is set to AF.

[Key Lock]: Displays the key lock icon () when set to [On].



[White Balance]: Displays the white balance indicator when set to [On].

[Exposure]: Displays the exposure bar when set to [On].

[Iris]: Displays the aperture setting when set to [On].

[ISO/Gain]: Displays the ISO speed or gain setting when set to [On].

[Shutter]: Displays the shutter speed setting when set to [On].

[Peaking]: Displays the peaking icon (**PEAK1** or **PEAK2**) when set to [On].

[Magnification]: Displays the screen magnification icon (**MAGN**) when set to [On], indicating that the image on the screen is being magnified.

[View Assist.]: Displays the view assistance icon (**V.Assist.**) when set to [On].

[EF-S Lens]: Displays the EF-S lens correction icon (**EF-S**) when set to [On].

[Lens]: Displays the lens warning icon (**LENS**) when set to [On].

### [Custom Display 2] settings

[Remaining Battery]: Controls when the remaining battery indicator appears.

[Normal]: Always appears on the screen.

[Warning]: Appears only when there is a warning.

[Remaining Rec Time]: Displays the remaining recording time.

[Normal]: Always appears on the screen.

[Warning]: Appears only when there is a warning.

[Rec Mode]: Displays the recording operation indicator ([STBY] in record pause mode, for example) when set to [On].

[Time Code]: Displays the time code when set to [On].

[Photo]: Controls the display of the SD card status indicator and remaining number of photos when taking a photo.

[Normal]: Always appears on the screen.

[Warning]: Appears only when there is a warning.

[Bit rate]: Displays the bit rate when set to [On].

[Frame Rate]: Displays the frame rate when set to [On].

[Character Rec]: Displays the character recording warning icon (**CHAR.REC**) when set to [On], indicating that the onscreen displays will be recorded on the clip.

[Output Display]: Displays the output display warning icon (**DISP+**) when set to [On], indicating that the onscreen displays will be output to an external monitor.

[User Bit]: Displays the user bit when set to [On].

[Audio Output CH]: Displays the audio output channel when set to [On].

[Audio Level]: Displays the audio level indicator and, if activated, the audio peak limiter icon (**LIM**) when set to [On].

[HDMI Rec Command]: Displays the status of the HDMI recording command that is being output when [Other Functions] ➤ [HDMI] ➤ [Rec Command] is set to [On].

[Temperature/Fan]: Displays the cooling system warning icons (**TEMP** and/or **FAN**) when set to [On].

[Date/Time]: Displays the date and/or the time while recording.

[Date/Time]: Displays the date and time of recording during playback.

## [00:00 TC/UB Setup] menu (CAMERA mode only)

Menu item	Submenu	Setting options	
[Time Code]	[Mode]	[Preset], [Regen.]	70
	[Run]	[Rec Run], [Free Run]	
	[DF/NDF]*	[DF], [NDF]	71
	[Setting]	[Set], [Reset]	70
[User Bit]	[Output Mode]	[Fixed], [Pulldown]	73
	[Type]	[Setting], [Time], [Date]	73

\* In the following cases, the time code is set to [NDF] and this setting cannot be changed:

- [Other Functions] [System Frequency] is set to [50.00 Hz]
- [Other Functions] [System Frequency] is set to [59.94 Hz] and the frame rate is set to 24P

## [Other Functions] menu

Menu item	Submenu	Setting options	CAMERA	MEDIA	
[Reset]	[All Settings]	[Cancel], [OK]	●	●	-
	[Camera Settings]	[Cancel], [OK]	●	-	
	[Assignable Buttons]	[Cancel], [OK]	●	● <sup>1</sup>	
[Transfer Menu/CP]	[Save To ]	[SA] A]	●	●	103
		[SA] B]			
	[Load From ]	[SA] A]	●	●	
		[SA] B]			
[Time Zone]		List of world time zones. [UTC-05:00 New York] or [UTC+01:00 Central Europe] <sup>2</sup>	●	●	25
[Set Clock]	[Date/Time]	-	●	●	25
	[Date Format]	[YMD], [YMD/24H], [MDY], [MDY/24H], [DMY], [DMY/24H] <sup>2</sup>	●	●	
[WFM (LCD)]	[Setting]	[WFM], [Edge Mon.], [Off]	●	-	81
		[WFM], [Off]	-	● <sup>4</sup>	
	[Waveform Monitor]	[Line], [Line+Spot], [Field], [RGB], [YPbPr]	●	● <sup>4</sup>	81
	[Gain]	[1x], [2x]	●	● <sup>4</sup>	82
	[Edge Monitor]	[Type 1], [Type 2]	●	-	
[Gain]	[Off], 1 to 15 (12)	●	-		
[Language ]		[Deutsch], [English], [Español], [Français], [Italiano], [Polski], [Русский], [简体中文], [한국어], [日本語]	●	●	26
[REMOTE Term.]		[RC-V100], [Standard]	●	●	87
[Assign Button]	[1] to [15]	See footnote 3	●	-	89
	[7] to [15]		-	● <sup>1</sup>	
[Tally Lamp]	[Front]	[On], [Off]	●	-	-
	[Rear]				
[Media Access LED]		[On], [Off]	●	●	-
[Fan]		[On], [Automatic]	●	-	37
[System Frequency]		[59.94 Hz], [50.00 Hz] <sup>2</sup>	●	● <sup>1</sup>	51
[Relay Rec]		[On], [Off]	●	-	41
[Double Slot Rec]		[On], [Off]	●	-	41
[Continuous Rec]	[Mode]	[On], [Off]	●	-	85
	[Start/Stop]	[Start], [Stop]			

Menu item	Submenu	Setting options	CAMERA	MEDIA	📖
[Bit Rate]		[24 Mbps LPCM], [24 Mbps], [17 Mbps], [7 Mbps]	●	–	51
[Frame Rate]		When [System Frequency] is set to [59.94 Hz]: [60i], [PF30], [PF24], [24P] When [System Frequency] is set to [50.00 Hz]: [50i], [PF25]	●	–	51
[Pre Rec]		[On], [Off]	●	–	84
[Delete Last Clip]		[Cancel], [OK]	●	–	–
[Clips]	[Copy]	[Select], [All]	–	● <sup>4</sup>	111
	[Delete]	[Select], [All]	–	● <sup>4</sup>	112
		[All]	–	● <sup>5</sup>	
	[Convert HD → SD]	[Select], [All]	–	● <sup>4</sup>	113
[Delete Shots]		[Select], [All]	–	● <sup>6</sup>	112
[Rec Review]		[Entire Clip], [Last 4 sec]	●	–	83
[HDMI]	[Time Code]	[On], [Off]	●	–	–
	[Rec Command]	[On], [Off]	●	–	–
[Photos]	[File Numbering]	[Reset], [Continu.]	●	–	147
	[Add 📁 File]	[On], [Off]	●	–	92
	[Copy]	[Select], [All]	–	● <sup>7</sup>	128
	[Delete]	[Select], [All]	–	● <sup>7</sup>	129
[File Numbering]		[Reset], [Continu.]	–	● <sup>1</sup>	147
[Custom Function]	[Shockless WB]	[On], [Off]	●	–	102
	[AE Response]	[Fast], [Normal], [Slow]			
	[Grip Ctrl Dial Dir.]	[Reverse], [Normal]			
	[F. Assist. B&W]	[Both], [Magnify], [Peaking], [Off]			
	[Magn. Add. Disp.]	[Peaking], [Edge Mon.], [Off]			
	[Scan Reverse Rec]	[Both], [Vertical], [Horizontal], [Off]			
	[Character Rec]	[On], [Off]			
	[🔒 START/STOP]	[On], [Off]			
[Reset Hour Meter]		[Cancel], [OK]	●	●	–
[Initialize Media]	[📁] A	[Complete], [Quick]	●	●	40
	[📁] B		●	●	
[Lens Firmware]		–	●	–	31
[Firmware]		–	●	–	–

<sup>1</sup> Not available in the [Photos] index screen.

<sup>2</sup> The default value depends on the country/region or purchase.

<sup>3</sup> Setting options for [Assign Button]: [(NONE)], [ONE-SHOT AF], [PUSH AUTO IRIS], [Iris Mode], [Iris +], [Iris -], [AE Shift +], [AE Shift -], [Backlight], [Spotlight], [ISO/GAIN], [SHUTTER], [View Assist.], [PEAKING], [ZEBRA], [WFM], [MAGN.], [Color Bars], [Markers], [LCD Setup], [VF Setup], [LCD/VF B&W], [Onscreen Display], [Time Code], [Time Code Hold], [Headphone +], [Headphone -], [Speaker +], [Speaker -], [Audio Output CH], [Audio Level], [Photo], [Fan], [My Menu], [Initialize Media], [🔍 Up], [🔍 Down], [🔍 Left], [🔍 Right], [🔍 SET], [User Setting (NONE)].

The default settings are as follows. [1] to [6]: [(NONE)], [7] and [8]: [MAGN.], [9]: [PEAKING], [10]: [ZEBRA], [11]: [WFM], [12]: [PUSH AUTO IRIS], [13]: [ISO/GAIN], [14]: [SHUTTER], [15]: [ONE-SHOT AF]

<sup>4</sup> Available in the clip index screen only.

<sup>5</sup> Available in the [SD Movies] index screen only.

<sup>6</sup> Available in the [Shot List] index screen only.

<sup>7</sup> Available in the [Photos] index screen only.

[Reset]: Reset various camcorder settings.

[All Settings]: Resets all the camcorder's settings to default settings, except for the hour meter.

[Camera Settings]: Resets the white balance, iris, ISO speed, gain, shutter speed, [CAMERA Camera Setup] settings and custom picture settings to default settings.

[Assignable Buttons]: Resets the assignable buttons to default settings.

[Tally Lamp]: Allows you to set whether the front and rear tally lamps illuminate while the camcorder is recording.

[Media Access LED]: Allows you to set whether the respective SD card access indicator illuminates while the camcorder is accessing an SD card.

[Delete Last Clip]: Deletes the last clip you recorded. This menu option will not be available if you turned the camcorder off since recording the last clip.

**[HDMI] settings**

[Time Code]: Allows you to output the internal camcorder-generated time code through the HDMI OUT terminal. The setting cannot be changed while the camcorder is connected to an external device using an HDMI cable (commercially available).

[Rec Command]: After selecting to output the time code, this setting allows you to additionally output also the camcorder’s recording command. When you connect the camcorder to another recording device using the HDMI OUT terminal, if you start or stop recording with the camcorder, the other device will also start or stop recording. The setting cannot be changed while the camcorder is connected to an external device using an HDMI cable (commercially available).

[Reset Hour Meter]: The camcorder has two “hour meters” – the first keeps track of total operation time and the second keeps track of operation time since the last time the second hour meter was reset with this function.

[Firmware]: You can verify the current version of the camcorder’s firmware. This menu option is usually unavailable.

[★ My Menu] (CAMERA mode only)

Menu item	Submenu	Setting options	
[Edit]	[Register]	[Cancel], [OK]	28
	[Move]	[Cancel], [OK]	
	[Delete]	[Cancel], [OK]	
	[Reset All]	[Cancel], [OK]	

## Displaying the Status Screens

You can use the status screens to check the camcorder's various recording- and playback-related settings. You can also output the status screens on an external monitor.

Operating modes: CAMERA MEDIA

### 1 Press the STATUS button.

- The status screen most recently displayed will appear unless you turned off the camcorder or changed the operating mode. In such case, the [Camera] status screen appears in CAMERA mode and the [Assign Button 1/2] status screen appears in MEDIA mode.

### 2 Push the joystick up/down to scroll through the status screens.

### 3 When you are finished, press the STATUS button again to exit the status screens.

- Alternatively, you can press the MENU or CUSTOM PICTURE button. Doing so will exit the status screen and open the respective menu.

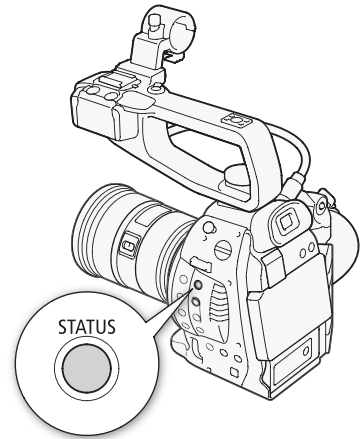

Status screen	Description	CAMERA	MEDIA	📖
[Camera]	Displays settings related to recording, such as ISO speed/gain, iris and shutter speed increments, peripheral illumination correction and attached lens model information.	●	–	142
[Assign Button 1/2], [Assign Button 2/2]	Allows you to verify the current function of each assignable button.	●	●	142
[Audio]	Displays settings related to audio.	●	● <sup>1</sup>	143
[Media]	Displays information about the SD cards.	●	●	143
[Video]	Displays the settings for the video terminals and whether the pre-recording mode is in effect.	●	●	144
[Battery/Hour Meter]	Allows you to check the remaining battery time, battery life and how long the camcorder has been in operation.	●	●	144
[CP Data 1/3], [CP Data 2/3], [CP Data 3/3] <sup>2</sup>	Displays the settings for the custom picture file that is in effect.	●	–	145, 146

<sup>1</sup> Does not appear in the [Photos] index screen.

<sup>2</sup> These screens appear only after a custom picture file has been selected.

**[Camera] Status Screen** (CAMERA mode only)

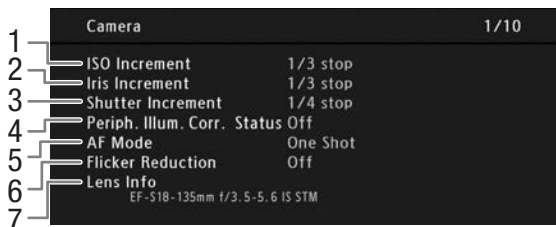

- |                                   |   |
|-----------------------------------|---|
| 1 ISO speed/Gain increment (📖 57) | 4 Correction for peripheral illumination (📖 30) |
| 2 Iris increment (📖 60)           | 5 AF mode (📖 65)                                |
| 3 Shutter speed increment (📖 55)  | 6 Flicker reduction (📖 56)                      |
|                                   | 7 Lens model name info (📖 29)                   |

**[Assign Button 1/2], [Assign Button 2/2] Status Screen**

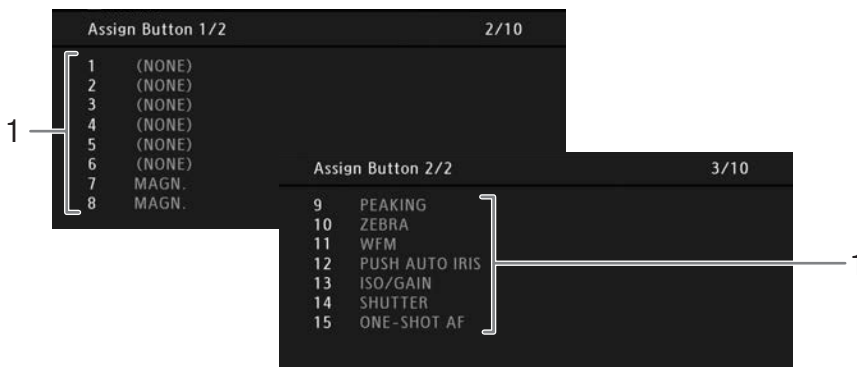

- 1 Assignable buttons 1 to 15\* (📖 89)

\* Assignable buttons 1 to 6 do not appear in MEDIA mode.

## [Audio] Status Screen

In **CAMERA** mode

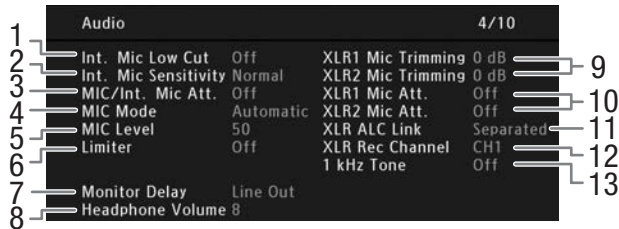

In **MEDIA** mode

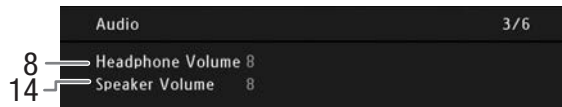

- |  |   |
|--|---|
| 1 Low-cut filter (built-in microphone) (📖 76)                      | 7 Monitor delay (📖 121)                             |
| 2 Microphone's sensitivity (built-in microphone) (📖 76)            | 8 Headphone volume (📖 109)                          |
| 3 Microphone attenuator (MIC terminal, built-in microphone) (📖 76) | 9 Microphone sensitivity (XLR terminal) (📖 79)      |
| 4 Microphone mode (MIC terminal) (📖 75)                            | 10 Microphone attenuator (XLR terminal) (📖 79)      |
| 5 Microphone recording level (MIC terminal) (📖 75)                 | 11 Linking recording levels of XLR terminals (📖 78) |
| 6 Audio peak limiter (📖 75, 78)                                    | 12 XLR terminal recording channel (📖 77)            |
|  | 13 Audio reference signal (📖 80)                    |
|  | 14 Speaker volume (📖 109)                           |

## [Media] Status Screen

In **CAMERA** mode

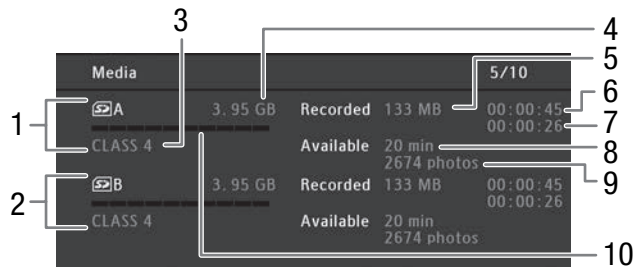

- |                           |  |
|---------------------------|--|
| 1 SD card A               | 6 Clip recording time* (📖 85)              |
| 2 SD card B               | 7 Total shot recording time* (📖 85)        |
| 3 SD speed class (📖 38)   | 8 Available recording time on the card**   |
| 4 Total space on the card | 9 Available number of photos on the card** |
| 5 Used space on the card  | 10 Approximate used space on the card      |

\* This information appears only during continuous recording mode.

\*\*In **MEDIA** mode, this information appears only when opening the status screen from the clip index screen.

### **i** NOTES

- Depending on the card used, the total space displayed on the screen may differ from the nominal capacity listed on the SD card.

- In **MEDIA** mode and when both relay recording and double slot recording mode are turned off in **CAMERA** mode, only the information about the SD card currently selected for recording/playback will be displayed.

### [Video] Status Screen

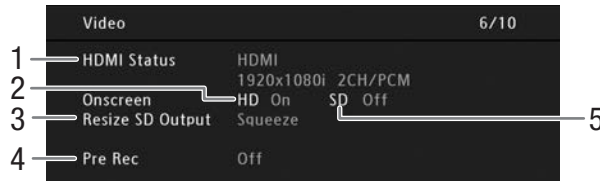

- 1 HDMI OUT terminal status
  - 2 Onscreen displays superimposed on HD video output (📖 120)
  - 3 SD output setting (📖 119)
  - 4 Pre-recording mode\* (📖 84)
  - 5 Onscreen displays superimposed on SD video output (📖 120)
- \* **CAMERA** mode only.

### [Battery/Hour Meter] Status Screen

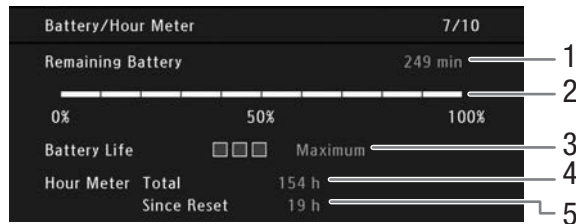

- 1 Remaining recording time
- 2 Remaining recording time indicator
- 3 Battery life indicator
- 4 Total operation time (📖 140)
- 5 Operation time since using [Reset Hour Meter] (📖 140)



[CP] Data 1/3] Status Screen (CAMERA mode only)

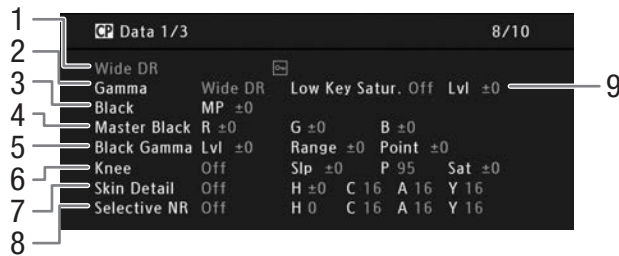

- |  |  |
|--|--|
| 1 Custom picture file name (📖 92)                      | 6 Knee settings (slope, point and saturation) (📖 97)           |
| 2 Gamma (📖 95)   | 7 Skin detail settings (hue, chroma, area and Y level) (📖 98)  |
| 3 Master pedestal (📖 96)                               | 8 Selective NR settings (hue, chroma, area and Y level) (📖 98) |
| 4 Master black RGB levels (📖 96)                       | 9 Low key saturation (📖 97)                                    |
| 5 Black gamma settings (level, range and point) (📖 96) |  |

[CP] Data 2/3] Status Screen (CAMERA mode only)

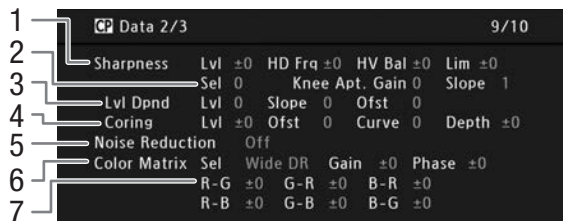

- |   |   |
|---|---|
| 1 Sharpness settings (level, horizontal detail frequency, horizontal/vertical detail balance, and limit) (📖 97) | 4 Coring settings (level, offset, curve and depth) (📖 97) |
| 2 Sharpness settings (select, knee aperture gain and slope) (📖 97)  | 5 Noise reduction (📖 98)                                  |
| 3 Level depend settings (level, slope and offset) (📖 98)  | 6 Color matrix settings (select, gain and phase) (📖 99)   |
|   | 7 Color matrix settings (📖 99)                            |

[**CP** Data 3/3] Status Screen (CAMERA mode only)

146

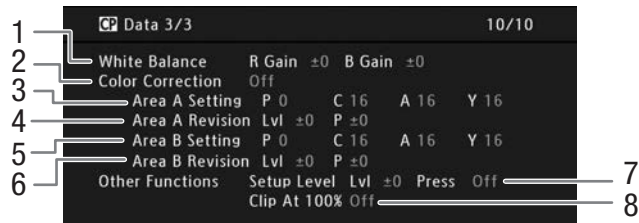

- |   |  |   |  |
|---|--|---|--|
| 1 | White balance R/B gain (📖 99)                            | 5 | Area B settings (phase, chroma, area and Y level) (📖 99) |
| 2 | Color correction (📖 99)                                  | 6 | Area B revision settings (level and phase) (📖 99)        |
| 3 | Area A settings (phase, chroma, area and Y level) (📖 99) | 7 | Setup level and press (📖 100)                            |
| 4 | Area A revision settings (level and phase) (📖 99)        | 8 | Clip at 100% (📖 100)                                     |

## Resetting the File Numbering

Photos and SD movies are automatically assigned consecutive numbers from 0101 to 9900, and stored on the SD card in folders containing up to 100 files. Folders are numbered from 101 to 998. You can select the file numbering method to be used but using the default [Continu.] setting is recommended.

Operating modes: CAMERA MEDIA

### 1 Open the [File Numbering] submenu.

CAMERA mode: [**Other Functions**] ➤ [Photos] ➤ [File Numbering]

MEDIA mode: [**Other Functions**] ➤ [File Numbering]

### 2 Select the desired option and then press the joystick.

CAMERA mode:

[**Other Functions**]

[Photos]

[File Numbering]

[Continu.]

MEDIA mode:

[**Other Functions**]

[File Numbering]

[Continu.]

### Options

- [Reset]: File numbers will restart from 101-0101 every time you insert a new SD card. If an SD card already contains photos or SD movies, file numbers will continue from the number following that of the last photo or SD movie on the SD card.
- [Continu.]: File numbers will continue from the number following that of the last photo recorded or SD movie converted with the camcorder. However, if the SD card you insert already contains photos or SD movies, file numbers will continue from the number following that of the last photo or SD movie on the SD card. This setting is the most convenient for managing files on a computer.

### NOTES

- The file number indicates the name and location of the file on the SD card. For example, the file of a photo numbered 101-0107 is "IMG\_0107.jpg" and it can be found in the "DCIM\101CANON" folder, while the file of an SD movie numbered 101-0108 is "MVI\_0108.mpg" and it is stored in the same folder.

## Troubleshooting

If you have a problem with your camcorder, refer to this section. Consult your dealer or a Canon Service Center if the problem persists.

### Power source

**The camcorder will not turn on or it turns off by itself.**

- The battery pack is exhausted. Replace or charge the battery pack.
- Remove the battery pack and reattach it correctly.

**Shortly after turning it on, the camcorder turns off on its own.**

- You are using a battery pack that is not compatible for use with this camcorder. Use a recommended battery pack (□ 160).

**Cannot charge the battery pack.**

- The temperature of the battery pack is outside the charging range. If the battery pack's temperature is below 0 °C (32 °F), warm it before charging it; if it is above 40 °C (104 °F), let the battery pack cool down before charging it.
- Charge the battery pack in temperatures between 0 °C and 40 °C (32 °F and 104 °F).
- The battery pack is faulty. Replace the battery pack.

**The battery pack is exhausted extremely quickly even at normal temperatures.**

- Check the [Battery/Hour Meter] status screen (□ 144) to see whether the battery pack is at the end of its service life. If so, buy a new battery pack.

### Recording

**The camcorder's controls are not responsive/disabled.**

- The grip unit's plug may not be correctly connected to the camcorder. When attaching the grip unit to the camcorder, make sure the grip unit's plug is firmly inserted all the way into the connection terminal on the camcorder (□ 35). If you changed the angle of the grip unit, make sure you did not partially disconnect the plug by mistake.
- When the **POWER** switch is set to **🔒**, all buttons except for the START/STOP button are locked and cannot be operated. (Depending on the [Other Functions] ➤ [Custom Function] ➤ **🔒 START/STOP** setting, the START/STOP button may be locked as well.) Set the **POWER** switch to CAMERA.

**Pressing the START/STOP button will not start recording.**

- The SD card is full or it already contains the maximum number of clips (3,999 clips). Delete some clips (□ 112) or save your clips (□ 123) and initialize the SD card (□ 40) to free some space. Alternatively, replace the SD card.
- The START/STOP lock lever on the handle unit is set to **🔒**, rendering the handle unit's START/STOP button inoperable. Change the position of the lock lever.

**The point where the START/STOP button was pressed does not match the beginning/end of the recording.**

- There is a slight interval between pressing the START/STOP button and the actual start/end of recording. This is not a malfunction.

**The camcorder will not focus.**

- The viewfinder is not adjusted. Use the dioptic adjustment lever to make the proper adjustment (□ 33).
- The lens is dirty. Clean the lens with a soft lens-cleaning cloth.

**When a subject flits across in front of the lens, the image appears slightly bent.**

- This is a phenomenon typical of CMOS image sensors. When a subject crosses very quickly in front of the camcorder, the image may seem slightly warped. This is not a malfunction.

**Bright red, green or blue dots appear on the screen.**

- The camcorder's CMOS sensor is a delicate piece of precision engineering. Direct exposure of the sensor to ion rays or other types of cosmic radiation may affect it and this may rarely appear as bright colored dots on the screen. This is the nature of CMOS image sensors and does not represent a malfunction. Adjusting the black balance (□ 43) may help solve the problem.
- The effects of the damage may be more noticeable when the camcorder is used in places subject to high temperatures, when a high ISO speed or gain level is used and when slow shutter speeds are used.

**Abnormal images appear on the screen and the camcorder cannot record properly.**

- While recording using an almost empty battery pack together with the compact power adapter, the compact power adapter was inadvertently disconnected or the power supply was suddenly interrupted. Reconnect the compact power adapter and turn the camcorder off and then on again or replace the battery pack with a fully charged one.

**Changing between recording (●REC) and record pause (STBY) takes longer than usual.**

- When the SD card contains a large number of clips, some operations may take longer than usual. Save your clips (☐ 123) and initialize the SD card (☐ 40). Alternatively, replace the SD card.

**The camcorder cannot record to an SD card properly.**

- This may occur as recordings are made and deleted over time. Save your clips (☐ 123) and initialize the SD card (☐ 40).

**After using the camcorder for a long time, it becomes hot.**

- The camcorder may become hot after using it continuously for long periods of time; this is not a malfunction. If the camcorder becomes unusually hot or it becomes hot after using it only for a short while, it may indicate a problem with the camcorder. Consult a Canon Service Center.

## Playback

**Cannot delete clips or photos.**

- Clips and photos that were protected using other devices cannot be deleted with the camcorder.
- The LOCK switch on the SD card is set to prevent accidental erasure. Change the position of the LOCK switch.

**Deleting clips takes longer than usual.**

- When the SD card contains a large number of clips, some operations may take longer than usual. Save your clips (☐ 123) and initialize the SD card (☐ 40).

**Cannot copy clips.**

- There is not enough available space on the SD card being copied to or the SD card already contains the maximum number of clips (3,999 clips). Delete some clips (☐ 112) to free some space or replace the SD card.

**Cannot select clips or photos.**

- You cannot select more than 100 individual clips or photos. Use the [All] option instead of [Select].

## Indicators and Onscreen Displays

 lights up in red.

- Battery pack is exhausted. Replace or charge the battery pack.

 appears on the screen.

- The camcorder cannot communicate with the battery pack attached so the remaining battery time cannot be displayed.

**The tally lamps do not illuminate.**

- Set [Other Functions] ➤ [Tally Lamp] ➤ [Front] or [Rear] to [On].

**The tally lamps flash quickly.**  (4 flashes per second)

- The battery pack is exhausted. Replace or charge the battery pack.
- There is not enough available space on both SD cards. Delete some clips (☐ 112) to free some space or replace the SD card.
- A system error has occurred. Turn off the camcorder and back on again. If this does not solve the problem, consult a Canon Service Center.

**The tally lamps flash slowly.**  (1 flash per second)

- The combined available space on both SD cards is low. Replace the SD card.

 appears in red on the screen.

- An SD card error occurred. Turn off the camcorder. Remove and reinsert the SD card. Initialize the SD card (☐ 40) if the display does not change back to normal.
- The SD card is full. Replace the SD card or delete some clips (☐ 112) or photos (☐ 129) to free some space on the SD card.

**Even after stopping recording, the SD card access indicator stays illuminated in red.**

- The clip is being recorded. This is not a malfunction.

 appears in yellow on the screen.

- The camcorder's internal temperature has reached a predetermined level. You can continue using the camera.

 appears in red on the screen.

- In [CAMERA] mode, when [Other Functions] ➤ [Fan] is set to [Automatic], the cooling fan will start automatically ( appears on the screen).

**LENS** appears on the screen.

- The camcorder and lens cannot communicate normally. Clean the lens's contacts and reattach the lens.

## Picture and Sound

**Screen displays turn on and off repeatedly.**

- The battery pack is exhausted. Replace or charge the battery pack.
- Remove the battery pack and reattach it correctly.

**Abnormal characters appear on the screen and the camcorder does not operate properly.**

- Disconnect the power source and reconnect it after a short time. If the problem still persists, perform one of the following actions.
  - Disconnect the power source and press the RESET button. This resets all the camcorder's settings to default values except for custom picture settings and the hour meter.
  - Use the [Other Functions] ➤ [Reset] ➤ [All Settings] function. This resets all the camcorder's settings to default values except for the hour meter.

**Video noise appears on screen.**

- Keep a distance between the camcorder and devices that emit strong electromagnetic fields such as near powerful magnets and motors, MRI machines or high-voltage power lines.

**Horizontal bands appear on the screen.**

- This is a phenomenon typical of CMOS image sensors when recording under some types of fluorescent, mercury or sodium lamps. This is not a malfunction. You may be able to reduce the symptoms by setting [Camera Setup] ➤ [Flicker Reduction] to [Automatic] and/or by setting the shutter mode to [Speed] and the shutter speed to a value matching the frequency of the local electrical system: 1/50\* or 1/100 for 50 Hz systems, 1/60 or 1/120 for 60 Hz systems.

\* May not be available depending on the frame rate.

**No picture appears on the viewfinder.**

- No picture will be output to the viewfinder if a cable is connected to the HDMI OUT or AV OUT terminal in playback mode. Remove the cable.

**No onscreen displays appear on the viewfinder.**

- In **CAMERA** mode, [Video Setup] ➤ [Character Display] is set to [Ext. Out]. Set it to [VF].

**Audio cannot be recorded.**

- The audio input switch is not set correctly (☐ 74) or the audio recording level is not set correctly (☐ 75, 78).
- An external microphone connected to the XLR terminal requires phantom power. Set the XLR terminal switch to MIC+48V (☐ 77).

**Audio is recorded at an extremely low level.**

- The AUDIO LEVEL switch is set to M, and the recording level is set too low. When using the MIC terminal: [Audio Setup] ➤ [Audio Input] ➤ [MIC Mode] is set to [Manual] and the [MIC Level] setting is too low. Check the audio level meter on the screen and adjust the audio level correctly (☐ 75, 78).
- The microphone attenuator is on. Turn off the microphone attenuator (☐ 76, 79).

**Sound is distorted or is recorded at lower levels.**

- When recording near loud sounds (such as fireworks, shows or concerts), sound may become distorted or it may not be recorded at the actual levels. Activate the microphone attenuator (☐ 76, 79), or adjust the audio recording level manually (☐ 75, 78).

**The picture is displayed correctly but there is no sound from the built-in speaker.**

- Speaker volume is turned off. Adjust the volume (☐ 109).
- If headphones are connected to the camcorder, disconnect them.

## SD Cards and Accessories

**Cannot insert the SD card.**

- The SD card you are trying to insert is not facing the correct direction. Turn it over and insert it.

**Cannot record on the SD card.**

- A compatible SD card must be used (□ 38).
- Initialize the SD card (□ 40) when you use it with the camcorder for the first time.
- The LOCK switch on the SD card is set to prevent accidental erasure. Change the position of the LOCK switch.
- The SD card is full or it already contains the maximum number of clips (3,999 clips). Delete some clips (□ 112) or photos (□ 129) to free some space or replace the SD card.
- The folder and file numbers have reached their maximum value. Set [File Numbering] to [Reset] (□ 147) and insert a new SD card.

**Recording to and playing back from an SD card is slow.**

- This may occur as clips and photos are recorded/deleted over time. Save your recordings (□ 123) and initialize the SD card (□ 40).

**The optional RC-V100 Remote Controller or commercially available remote control does not work.**

- Make sure that the [Other Settings] ➤ [REMOTE Term.] setting is set to [RC-V100] when using the optional RC-V100 Remote Controller or [Standard] when using a commercially available remote control.
- When [Camera Setup] ➤ [CINEMA Locked] is set to [On] or a custom picture file is not selected, custom picture settings cannot be adjusted using the RC-V100. Set [CINEMA Locked] to [Off] or select a custom picture file ([C1] to [C9]) (□ 92).
- Turn off the camcorder, reconnect the RC-V100 or other remote control and then turn the camcorder back on again.

## Connections with External Devices

**Video noise appears on a nearby TV screen.**

- When using the camcorder in a room where a TV is located, keep a distance between the compact power adapter and the power or antenna cables of the TV.

**Playback looks fine on the camcorder but there is no image on the external monitor.**

- The camcorder is not connected correctly to the external monitor. Make sure you are using the correct connection (□ 118).
- The video input on the external monitor is not set to the video terminal to which you connected the camcorder. Select the correct video input.

**The camcorder is connected using a commercially available HDMI cable, but there is no picture or sound from the external monitor.**

- Disconnect the HDMI cable and then restore the connection or turn the camcorder off and then on again.

**The computer does not recognize the camcorder even though the camcorder is connected correctly.**

- Disconnect the USB cable and turn off the camcorder. After a short while, turn it on again and restore the connection.
- Connect the camcorder to a different USB port on the computer.
- USB connection is not available while the [Shot List] index screen is displayed. Press the INDEX button to return to the clip index screen (□ 106) and then try connecting again.

## List of Messages

Refer to this section if a message appears on the screen. The messages in this section appear in alphabetical order.

**Accessing A/B Do not remove**

- You opened the SD card compartment cover while the camcorder was accessing the SD card. Close the SD card compartment cover.

**Camera  Lens communication error. Clean the lens's contacts and reattach the lens.**

- The camcorder cannot correctly communicate with the lens due to dirty lens contacts. After the message disappears, the  icon appears on the screen. Clean the lens's contacts and reattach the lens.

**Cannot acquire battery information**

- Battery information can be displayed only for batteries bearing the Intelligent System mark.

**Cannot acquire battery information Continue using this battery pack?**

- If you are using a battery pack that bears the Intelligent System mark, there may be a problem with the camcorder or battery pack. Consult a Canon Service Center.

**Cannot play back**

- The file control information is corrupted or there was a decoder error. Turn off the camcorder and back on again. If this does not solve the problem, consult a Canon Service Center.
  - Corrupted file control information cannot be recovered. SD cards or clips with corrupt file control information cannot be read by the supplied software, **Data Import Utility**.

**Cannot record**

- The file control information is corrupted or there was an encoder error. Turn off the camcorder and back on again. Then, remove the SD card being used and reinsert it. Alternatively, replace the SD card. If this does not solve the problem, consult a Canon Service Center.
  - Corrupted file control information cannot be recovered. SD cards or clips with corrupt file control information cannot be read by the supplied software, **Data Import Utility**.

**Cannot switch SD card slots**

- The SLOT SELECT button was pressed while the camcorder is recording. Wait until recording is finished to change the selected SD card slot.

**Change the battery pack**

- The battery pack is exhausted. Replace or charge the battery pack.

**Check A/B**



- The SD card cannot be accessed. Check that the SD card is inserted correctly and not malfunctioning.
- Due to an SD card error, recording on/playback from the SD card is not possible. Remove and then reinsert the SD card or use a different SD card.
- You inserted a MultiMedia Card (MMC) into the camcorder. Use a recommended SD card (□ 38).
- If after the message disappears, the SD card access indicator illuminates in red, perform the following: Turn off the camcorder and remove and reinsert the SD card. If the SD card access indicator illuminates in green, you can resume recording/playback. If the problem persists, save your recordings (□ 123) and initialize the SD card (□ 40).

**Check the data on A/B Initializing the card is also recommended**

- The SD card cannot be used for any of the following reasons.
  - A problem has occurred with the SD card.
  - The camcorder cannot read the SD card's data.
  - The SD card was initialized using a computer.
  - The SD card has been partitioned.
- Save your clips (□ 123) and initialize the SD card (□ 40).

**Data on A/B needs recovering Attempt to recover?**

- If data on the SD card is corrupted, such as when the power suddenly turned off while recording, the data must be recovered. When this message appears, select [OK] and then press the joystick.

**Data on A/B needs recovering Change the position of the LOCK switch on the memory card.**

- This message will appear the next time you turn on the camcorder if power supply was accidentally interrupted while the camcorder was writing on the SD card and later the position of the SD card's LOCK switch was changed to prevent erasure. Change the position of the LOCK switch.

**Fan error**

- The cooling fan has stopped working or may not be working properly. Consult a Canon Service Center.

**File name error**

- The folder and file numbers have reached their maximum value. Set [File Numbering] to [Reset] (□ 147) and delete all the photos on the SD card (□ 129) or initialize it (□ 40).

**Invalid operation**

- The following operations cannot be performed.
  - In  mode, immediately reviewing a recording made using pre-recording or double slot recording.
  - Pressing the START/STOP button when there is no SD card in the camcorder.
  - During continuous recording mode, pressing the START/STOP button while continuous recording is stopped and recording is not possible (not enough space on the SD card, or maximum number of shots or continuous recording clips already recorded).

**Lens error Change the frame rate**

- The lens attached to the camcorder is not compatible for shooting at the frame rate selected on the camcorder. Select a different the frame rate (□ 51).

**Lens error Turn the camcorder off, then on again.**

- There was a communication error between the camcorder and the lens. Turn the camcorder off and then on again.

**Lens firmware update Firmware update failed. Try updating again.**

- The lens's firmware could not be correctly updated. Try updating the lens's firmware again.



**Media full**

- SD card A and SD card B are full. Delete some clips (☞ 112) or photos (☞ 129) to free some space or replace one or both SD cards.

**Media is almost full**

- The amount of available space on SD card A and SD card B combined is low. Replace one or both SD cards.

**Memory card cover is open**

- The SD card compartment cover was open when the camcorder was switched to or turned on in CAMERA mode. Close the compartment cover.

**No clips**

- There are no clips on the SD card to play back. Clips must be recorded (☞ 45) in order to play them back.

**No photos**

- There are no photos on the SD card to play back. Photos must be taken (☞ 125) in order to view them.

**Pre Rec was canceled. Activate Pre Rec again?**

- Pre-recording was deactivated automatically after the camcorder was left in record pause mode for about 1 hour with pre-recording activated. Select [On] and then press the joystick to activate pre-recording again.

**Pre Rec will be canceled in a moment.**

- The camcorder has been in record pause mode for about 1 hour with pre-recording activated. Pre-recording will be deactivated automatically in approximately 1 minute.

**Recorded at 50.00 Hz/59.94 Hz Check the data on A/B Initializing the card is also recommended**

- The SD card contains clips that were recorded using a recording type (system frequency) other than the one currently used by the camcorder. To record on this SD card, save your clips (☞ 123) and initialize the SD card (☞ 40). To play back the recordings on the SD card, set [ Other Functions] [System Frequency] to [59.94 Hz] or [50.00 Hz] as necessary, so the camcorder matches the SD card.

**This photo cannot be displayed**

- You may not be able to display photos taken with other devices or image files created or edited on a computer.

**A/B Buffer overflow. Recording was stopped.**

- The data transfer rate was too high for the SD card in use and the recording was stopped. Use a recommended card (☞ 38).

**A/B Cannot record movies on this memory card**

- Video cannot be recorded on a 64 MB or smaller SD card. Use a recommended card (☞ 38).

**A/B Cannot restore**

- Could not recover data on the SD card. Save your clips (☞ 123) and initialize the SD card (☞ 40).

**A/B Cannot start continuous rec**

- You have already recorded the maximum number of continuous recording clips (200 clips) in a single SD card. Replace the SD card(s).

**A/B May not be possible to record movies on this memory card**

- You may not be able to record video on an SD card without a speed class rating or rated SD Speed Class 2. Replace the SD card with one rated SD speed class 4, 6 or 10.

**A/B Media full**

- SD card A or SD card B is full so recording will not start. Switch to the SD card in the other SD card slot to record.

**A/B Memory card is write-protected**

- The LOCK switch on the SD card is set to prevent accidental erasure. Change the position of the LOCK switch.

**A/B Number of clips already at maximum**

- The SD card selected for recording already contains the maximum number of clips (3,999 clips). Replace the SD card or use the SD card in the other SD card slot.
- Because both SD cards reached the maximum number of clips, double slot recording is not available.
  - During double slot recording, both “A” and “B” will appear in the message.

**A/B Number of shots already at maximum**

- You have already recorded the maximum number of shots (3,999 shots) in a single SD card. When using two SD cards, you cannot record additional shots on either SD card. To add more shots, replace the SD card(s).

**A/B Number of shots in this clip already at maximum**





- You have already recorded the maximum number of shots (950 shots) in a single continuous recording clip. Continuous recording can continue but you cannot record additional shots. To add more shots, stop the continuous recording to record a clip and then start recording a new continuous recording clip (☞ 85).

 A /  B Reached the recording limit for one clip. Recording was stopped.

- When recording a single clip for an extended period of time, the clip will be split into smaller video files every 2 GB. This message will appear when the number of smaller video files reaches 50.

 A /  B Recording was stopped.

- The file control information is corrupted or there was an encoder error. Turn off the camcorder and back on again. Then, remove the SD card being used and reinsert it. Alternatively, replace the SD card. If this does not solve the problem, consult a Canon Service Center.
  - Corrupted file control information cannot be recovered. SD cards or clips with corrupt file control information cannot be read by the supplied software, **Data Import Utility**.

 A →  B /  B →  A Switched

- This message appears when you use the SLOT SELECT button to switch the SD card slot in use or recording continued from one SD card to the other.

 A →  B /  B →  A Will switch in a moment

- The SD card is almost full so recording will continue on the other SD card in approximately 1 minute.

## Handling Precautions

### Camcorder

Be sure to observe the following precautions to ensure maximum performance.

- Do not carry the camcorder by the LCD panel. Be careful when closing the LCD panel.
- Do not leave the camcorder in places subject to high temperatures (like the inside of a car parked under direct sunlight), or high humidity.
- Do not use the camcorder near strong electromagnetic fields such as near powerful magnets and motors, MRI machines or high-voltage power lines. Using the camcorder in such places may cause anomalies in the video or audio or video noise to appear.
- Do not use or store the camcorder in dusty or sandy places. The camcorder is not waterproof – avoid also water, mud or salt. If any of the above should get into the camcorder it may damage the camcorder and/or the lens. Consult a Canon Service Center as soon as possible.
- Be careful to avoid dust and dirt particles accumulating on the lens or entering the camcorder. When you finish using the camcorder, make sure to attach the body cap to the lens mount and the lens cap and dust cap to the lens.
- Do not point the camcorder or viewfinder toward an intense light source, such as the sun on a sunny day or an intense artificial light source. Doing so may damage the image sensor or the camcorder's internal components. Be careful especially when using a tripod or shoulder strap. When you are not using the camcorder, make sure to attach the body cap to the camcorder.
- Be careful of heat generated by lighting equipment.
- Do not disassemble the camcorder. If the camcorder does not function properly, consult qualified service personnel.
- Do not touch the lens contacts on the lens mount. Dirty contacts may cause a poor contact between the camcorder and the lens resulting in incorrect operation of the camcorder. After removing the lens, make sure to attach the body cap to the lens mount and the lens cap and dust cap to the lens.
- Handle the camcorder with care. Do not subject the camcorder to shocks or vibration as this may cause damage. When using the shoulder strap, do not allow the camcorder to swing and hit an object.

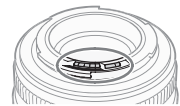

### Long-term storage

If you do not intend to use the camcorder for a long time, store it in a place free of dust, in low humidity, and at temperatures not higher than 30 °C (86 °F).

### Battery Pack

#### **DANGER!**

**Treat the battery pack with care.**

- Keep it away from fire (or it might explode).
  - Do not expose the battery pack to temperature higher than 60 °C (140 °F). Do not leave it near a heater or inside a car in hot weather.
  - Do not try to disassemble or modify it.
  - Do not drop it or subject it to shocks.
  - Do not get it wet.
- Dirty terminals may cause a poor contact between the battery pack and the camcorder. Wipe the terminals with a soft cloth.

### Long-term storage

- Store battery packs in a dry place at temperatures no higher than 30 °C (86 °F).
- To extend the battery life of the battery pack, discharge it completely before storing it.
- Charge and discharge all your battery packs fully at least once a year.

### Always attach the battery terminal cover.

Do not allow any metal objects to touch the terminals (figure 1), as this can cause a short circuit and damage the battery pack. Attach the terminal cover whenever the battery pack is not being used (figure 2).

The battery terminal cover has a [ ]-shaped hole. This is useful when you wish to differentiate between charged and uncharged battery packs. For example, with charged battery packs, attach the terminal cover so that the [ ]-shaped hole shows the colored label.

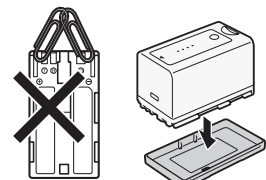
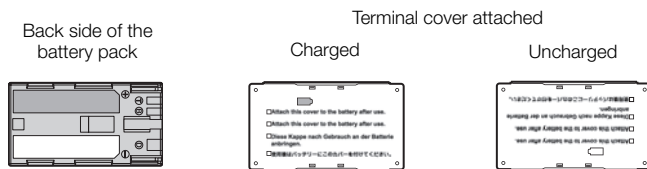

Figure 1

Figure 2



### Remaining battery time

If the remaining battery time displayed is not correct, charge the battery pack fully. Still, the correct time may not be displayed if a fully charged battery pack is used continuously in high temperatures or it is left unused for long periods of time. Also, the correct remaining time may not be displayed, depending on the battery life. Use the time shown on the screen as an approximation.

### Regarding the use of non-Canon battery packs

- We recommend using genuine Canon battery packs bearing the Intelligent System  Intelligent Li-ion Battery mark.
- If you attach to the camcorder battery packs that are not genuine Canon battery packs, the remaining battery time will not be displayed.

### SD Cards

- We recommend backing up the recordings on the SD cards onto your computer. Data may be corrupted or lost due to defects or exposure to static electricity. Canon shall not be liable for lost or corrupted data.
- Do not touch or expose the terminals to dust or dirt.
- Do not use SD cards in places subject to strong magnetic fields.
- Do not leave SD cards in places subject to high humidity and high temperature.
- Do not disassemble, bend, drop, or subject SD cards to shocks and do not expose them to water.
- Check the direction before inserting the SD cards. Forcing an SD card into the slot if it is not correctly oriented may damage the SD card or the camcorder.
- Do not attach any labels or stickers on the SD card.

- SD cards have a physical switch to prevent writing on the card so as to avoid the accidental erasure of the card's content. To write-protect the SD card, set the switch to the LOCK position.

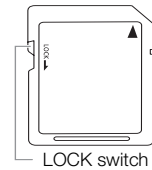

## Built-in Rechargeable Lithium Battery

The camcorder has a built-in rechargeable lithium battery to keep the date/time and other settings. The built-in lithium battery is recharged while you use the camcorder; however, it will discharge completely if you do not use the camcorder for about 3 months.

**To recharge the built-in lithium battery:** Connect the DC cable and compact power adapter to the camcorder and use a household power outlet to power the camcorder for 24 hours while it is turned off.

## Disposal

When you delete data on an SD card, only the file allocation table is altered and stored data is not physically erased. Take the necessary precautions when you dispose of an SD card, for example by physically damaging it to prevent the leakage of private data.

If giving an SD card to another person, initialize it using the [Complete] initialization option (📖 40). Fill it up with unimportant recordings, and then initialize it again. This makes recovering the original recordings very difficult.

## Maintenance/Others

### Cleaning

158

#### Camcorder Body

- Use a soft, dry cloth to clean the camcorder body. Never use chemically treated cloths or volatile solvents such as paint thinner.

#### Lens

- Remove any dust or dirt particles using a non-aerosol type blower brush.
- Use a clean, soft lens-cleaning cloth to gently wipe the lens using commercially available cleaning fluid for eyeglasses. Never use tissue paper.

#### LCD Screen

- Clean the LCD screen using a clean, soft lens-cleaning cloth.
- Condensation may form on the surface of the screen when the temperature changes suddenly. Wipe it with a soft dry cloth.

### Condensation

Moving the camcorder rapidly between hot and cold temperatures may cause condensation (water droplets) to form on its internal surfaces. Stop using the camcorder if condensation is detected. Continued use may damage the camcorder.

#### Condensation may form in the following cases:

- When the camcorder is moved quickly from cold to warm places
- When the camcorder is left in a humid room
- When a cold room is heated rapidly

#### To avoid condensation

- Do not expose the camcorder to sudden or extreme changes in temperature.
- Remove the SD cards and battery pack. Then, place the camcorder in an airtight plastic bag and let it adjust gradually to temperature changes before removing it from the bag.

#### When condensation is detected

The camcorder automatically shuts off.

The precise time required for water droplets to evaporate will vary depending on the location and weather conditions. As a general rule, wait for 2 hours before resuming use of the camcorder.

### Using the Camcorder Abroad

#### Power Sources

You can use the supplied compact power adapter to operate the camcorder and to charge battery packs in any country with power supply between 100 and 240 V AC, 50/60 Hz. Consult a Canon Service Center for information on plug adapters for overseas use.

## Optional Accessories

The following optional accessories are compatible with this camcorder. The availability differs from area to area.

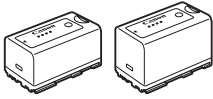

BP-950G, BP-955,  
BP-970G, BP-975  
Battery Pack

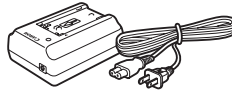

CA-930 Compact  
Power Adapter

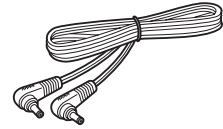

DC-930 DC Cable



CB-920 Car Battery  
Adapter

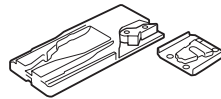

TA-100 Tripod Adapter

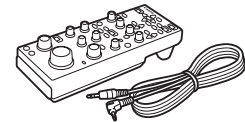

RC-V100 Remote  
Controller

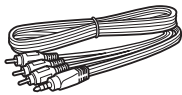

STV-250N Stereo Video  
Cable

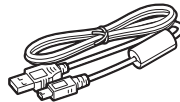

IFC-400PCU  
USB Cable



TB-1 Tripod Adapter  
Base

**For our customers in the USA:** Call or visit your local retailer/dealer for genuine Canon video accessories. You can also obtain genuine accessories for your Canon camcorder by calling: 1-800-828-4040, Canon U.S.A. Information Center.

### Use of genuine Canon accessories is recommended.

This product is designed to achieve excellent performance when used with genuine Canon accessories. Canon shall not be liable for any damage to this product and/or accidents such as fire, etc., caused by the malfunction of non-genuine Canon accessories (e.g., a leakage and/or explosion of a battery pack). Please note that this warranty does not apply to repairs arising out of the malfunction of non-genuine Canon accessories, although you may request such repairs on a chargeable basis.

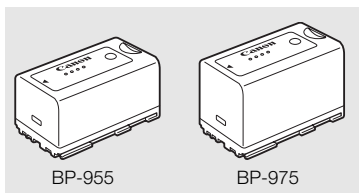

**Battery Packs**

When you need extra battery packs, select from the following: BP-950G, BP-955, BP-970G, BP-975

When you use battery packs bearing the Intelligent System mark, the camcorder will communicate with the battery and display the remaining usage time (accurate to 1 minute). You can only use and charge these battery packs with camcorders and chargers compatible with Intelligent System.

**Charging Times**

Use the supplied CA-930 Compact Power Adapter to charge battery packs. The charging times given in the following table are approximate and vary according to charging conditions and initial charge of the battery pack.

BP-950G	BP-955	BP-970G	BP-975
245 min.	200 min.	350 min.	295 min.

**Recording and Playback Times**

Recording and playback times given in the following tables are approximate and vary according to recording mode and charging, recording or playback conditions. The effective usage time of the battery pack may decrease when recording in cold surroundings, when using the brighter screen settings, etc.

EF lenses with lens contacts draw power from the camcorder to operate some functions. Effective usage times may decrease depending on the lens used.

**Approximate times (LCD screen + viewfinder)**

System frequency	Bit rate	Usage time	BP-950G	BP-955	BP-970G	BP-975
59.94 Hz	24 Mbps / 24 Mbps LPCM	Recording (maximum)	280 min.	265 min.	390 min.	405 min.
		Recording (typical*)	170 min.	160 min.	235 min.	250 min.
		Playback	425 min.	405 min.	595 min.	635 min.
	17 Mbps	Recording (maximum)	280 min.	265 min.	390 min.	410 min.
		Recording (typical*)	170 min.	160 min.	235 min.	250 min.
		Playback	425 min.	405 min.	595 min.	635 min.
	7 Mbps	Recording (maximum)	280 min.	270 min.	395 min.	415 min.
		Recording (typical*)	170 min.	165 min.	240 min.	255 min.
		Playback	430 min.	410 min.	600 min.	640 min.
50.00 Hz	24 Mbps / 24 Mbps LPCM	Recording (maximum)	295 min.	285 min.	415 min.	430 min.
		Recording (typical*)	180 min.	170 min.	250 min.	265 min.
		Playback	430 min.	410 min.	600 min.	640 min.
	17 Mbps	Recording (maximum)	295 min.	285 min.	420 min.	430 min.
		Recording (typical*)	180 min.	170 min.	250 min.	265 min.
		Playback	430 min.	410 min.	605 min.	645 min.
	7 Mbps	Recording (maximum)	300 min.	285 min.	420 min.	450 min.
		Recording (typical*)	180 min.	175 min.	255 min.	270 min.
		Playback	430 min.	410 min.	610 min.	650 min.



**Approximate times using the viewfinder**

System frequency	Bit rate	Usage time	BP-950G	BP-955	BP-970G	BP-975
59.94 Hz	24 Mbps / 24 Mbps LPCM	Recording (maximum)	295 min.	280 min.	405 min.	430 min.
		Recording (typical*)	180 min.	170 min.	250 min.	265 min.
	17 Mbps	Recording (maximum)	295 min.	280 min.	415 min.	430 min.
		Recording (typical*)	180 min.	170 min.	250 min.	265 min.
	7 Mbps	Recording (maximum)	300 min.	285 min.	420 min.	440 min.
		Recording (typical*)	180 min.	175 min.	250 min.	270 min.
50.00 Hz	24 Mbps / 24 Mbps LPCM	Recording (maximum)	320 min.	305 min.	435 min.	470 min.
		Recording (typical*)	190 min.	180 min.	260 min.	280 min.
	17 Mbps	Recording (maximum)	320 min.	305 min.	435 min.	470 min.
		Recording (typical*)	190 min.	180 min.	260 min.	280 min.
	7 Mbps	Recording (maximum)	325 min.	310 min.	445 min.	475 min.
		Recording (typical*)	190 min.	180 min.	265 min.	285 min.

\* Approximate times for recording with repeated operations such as start/stop, and power on/off.

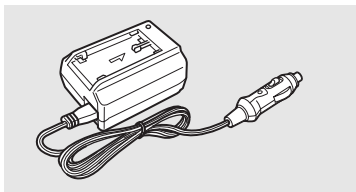

**CB-920 Car Battery Adapter**

Use the car battery adapter to charge battery packs on the go. The car battery adapter plugs into your car's cigarette lighter socket and runs off a 12-24V DC negative ground battery.

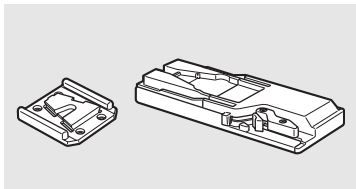

**TA-100 Tripod Adapter**

The TA-100 allows you to quickly mount/unmount the camcorder on/from a tripod.

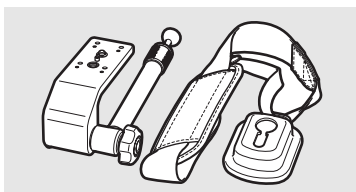

**SBR-1000 Shooting Brace**

Using the SBR-1000 for additional support of the camcorder with the neck strap will significantly lighten the load of the camcorder's weight while shooting.



This mark identifies genuine Canon video accessories. When you use Canon video equipment, we recommend Canon-brand accessories or products bearing the same mark.

# Specifications

## C100

### System

- **Recording System**

Movies: AVCHD      Video compression: MPEG-4 AVC/H.264  
 Audio compression: Linear PCM, 16 bits, 48 kHz, 2ch;  
 Dolby Digital 2ch

Photos: DCF (Design rule for Camera File system), compatible with Exif Ver. 2.3, JPEG compression

- **Video Configuration (recording/playback)**

24 Mbps LPCM (VBR), 24 Mbps (VBR), 17 Mbps (VBR):  
 1920x1080: 60i, 50i, PF30, PF25, PF24, 24P

7 Mbps (VBR):  
 1440x1080: 60i, 50i, PF30, PF25, PF24, 24P

- **Recording Media (not included)**

SD, SDHC or SDXC memory card<sup>1</sup> (2 slots)

<sup>1</sup> Custom picture files, and camera settings files can be saved on and read from the SD card as well.

- **Maximum Recording Time<sup>2</sup>**

16 GB SD Card

24 Mbps LPCM: 85 min., 24 Mbps: 85 min., 17 Mbps : 125 min., 7 Mbps : 285 min.

32 GB SD Card

24 Mbps LPCM: 175 min., 24 Mbps: 175 min., 17 Mbps : 250 min., 7 Mbps : 575 min.

<sup>2</sup> Approximate figures based on continuous recording.

- **Image Sensor:** Super-35mm-equivalent CMOS sensor, approx. 8,290,000 pixels (3840x2160)

- **LCD screen:** 8.8 cm (3.5 in.), wide, color, equivalent to approx. 922,000 dots, 100% coverage

- **Viewfinder:** 0.61cm (0.24 in.), wide, color, equivalent to approx. 1,555,000 dots, 100% coverage

- **Lens Mount**

Canon EF mount compatible with Canon EF lenses (including EF-S lenses)

Lens multiplication factor: approx. 1.53 (for 35mm-equivalent focal length)

- **ND Filter:** Built-in (Off, 2, 4 or 6 stops), manual

- **White Balance**

Custom white balance (two sets, A and B); two preset settings (daylight, 5,400 K<sup>3</sup> and incandescent lamp, 3,200 K<sup>3</sup>) that can be further fine-tuned; color temperature setting (2,000 K to 15,000 K); automatic white balance

<sup>3</sup> Color temperatures are approximate and given for reference purposes only.

- **Iris:** Manual (1/2-stop increments, 1/3-stop increments, fine-tuning), push auto iris, automatic<sup>4</sup>

- **Focus:** Manual, one-shot AF, continuous AF<sup>4</sup>

<sup>4</sup> Only when an EF-S 18-135mm f/3.5-5.6 IS STM or EF-S 18-55mm f/3.5-5.6 IS STM lens is attached to the camcorder.

- **ISO Speed**

ISO 320 to ISO 20000, ISO 25600<sup>5</sup> to ISO 80000<sup>5</sup> (1-stop or 1/3-stop increments)

- **Gain**

-6 dB to 30 dB (3-dB increments), 33 dB<sup>5</sup> to 42 dB<sup>5</sup> (3-dB increments), 0 dB to 24 dB (fine-tuning in 0.5-dB increments)

<sup>5</sup> With extended ISO/Gain range.

- **Shutter Speed**

Speed (1/3-stop increments, 1/4-stop increments), angle, clear scan, slow, off

- **Lens Peripheral Illumination Correction:** Available for Canon EF lenses<sup>6</sup>

<sup>6</sup> Some Canon EF lenses are not compatible with peripheral illumination correction.

- **Sensor Sensitivity (ISO 640 (0 dB), 2000 lux, 89.9% reflection)**  
**59.94 Hz** F9 (1920x1080 at 60i) **50.00 Hz** F10 (1920x1080 at 50i)
- **S/N Ratio (ISO 850, using Canon Log gamma)**  
 54 dB (typical, 1920x1080, **59.94 Hz** at PF30 / **50.00 Hz** at PF25)
- **Subject Illumination (24 dB, with an f/1.2 lens)**  
**59.94 Hz** 0.30 lux (PF30, shutter speed 1/30)  
**50.00 Hz** 0.25 lux (PF25, shutter speed 1/25)
- **Size of Photos:** 1920x1080 pixels

## Terminals

- **HDMI OUT Terminal:** HDMI connector, output only, supports time code output
- **AV OUT Terminal**  
 Ø 3.5 mm stereo minijack, output only  
 Video: 1 Vp-p / 75 Ω unbalanced  
 Audio: -10 dBV (47 kΩ load) / 3 kΩ or less
- **USB Terminal:** mini-B, Hi-Speed USB, output only
- **MIC Terminal**  
 Ø 3.5 mm stereo mini-jack, -72 dBV (manual volume center, full scale -18 dB) / 600 Ω  
 Microphone attenuator: 20 dB
- **⌚ (Headphone) Terminal**  
 Ø 3.5 mm stereo mini-jack, -∞ to -12 dBV (16 Ω load, volume range Min to Max) / 50 Ω or less
- **REMOTE Terminal:** Ø 2.5 mm stereo mini-jack
- **Grip Unit Connection Terminal**  
 Proprietary connector for the supplied Grip Unit connection plug

## Power/Others

- **Power Supply (rated):** 7.4 V DC (battery pack), 8.4 V DC (DC IN)
- **Power Consumption (recording at 24 Mbps/24 Mbps LPCM, viewfinder/LCD screen normal brightness)**  
 LCD screen and viewfinder: **59.94 Hz** 8.1 W, **50.00 Hz** 7.6 W  
 Viewfinder only: **59.94 Hz** 7.7 W, **50.00 Hz** 7.3 W  
 Maximum rated power consumption: 19.6 W
- **Operating Temperature:** 0 – 40 °C (32 – 104 °F)
- **Dimensions (W x H x D)\***  
 Minimal configuration with thumb rest:  
 135 x 170 x 129 mm (5.3 x 6.7 x 5.1 in.)  
 Configuration with grip unit:  
 182 x 170 x 129 mm (7.2 x 6.7 x 5.1 in.)  
 Configuration with handle unit and grip unit:  
 182 x 281 x 263 mm (7.2 x 11.1 x 9.3 in.)  
 \* All dimensions are approximate.
- **Weight \*\***  
 Camcorder unit only:  
 1,020 g (2.2 lb.)  
 Camcorder with grip unit and grip belt, BP-955 battery pack and two SD cards:  
 1,475 g (3.3 lb.)  
 Camcorder with grip unit and grip belt, handle unit, BP-955 battery pack and two SD cards:  
 1,835 g (4.0 lb.)  
 \*\* All weights are approximate.

## Modular Units

### Handle Unit

Modular unit includes a cold accessory shoe and socket for 0.64 cm (1/4 in.) screws for other accessories, built-in microphone, XLR terminals and related audio controls.

- **CH1, CH2 Terminals**

XLR jack (pin1: shield, pin2: hot, pin3: cold), 2 sets

Sensitivity

MIC setting: -60 dBu (manual volume center, full scale -18 dB) / 600  $\Omega$

LINE setting: 4 dBu (manual volume center, full scale -18 dB) / 10 k $\Omega$

Microphone attenuator: 20 dB

- **Microphone:** Stereo electret condenser microphone

- **Weight:** Approx. 360 g (12.7 oz.)

### Grip Unit

Modular unit can be attached at any of 24 positions (15° intervals); includes limited recording controls.

- **Weight:** Approx. 230 g (8.1 oz.)

## CA-930 Compact Power Adapter

- **Rated Input:** 100 – 240 V AC, 50/60 Hz

Used as power adapter: 46 VA (100 V AC) – 62 VA (240 V AC)

Used as battery charger: 40 VA (100 V AC) – 54 VA (240 V AC)

- **Rated Output**

Used as power adapter: 8.4 V DC, 2.4 A

Used as battery charger: 8.4 V DC, 1.5 A/2.0 A

- **Operating Temperature:** 0 – 40 °C (32 – 104 °F)

- **Dimensions (W x H x D):** Approx. 85 x 51 x 110 mm (3.3 x 2.0 x 4.3 in.)

- **Weight:** 240 g (8.5 oz.)

## BP-955 Battery Pack

- **Battery Type:** Rechargeable lithium ion battery, compatible with Intelligent System

- **Rated Voltage:** 7.4 V DC

- **Operating Temperature:** 0 – 40 °C (32 – 104 °F)

- **Battery Capacity**

Typical: 5,200 mAh

Minimum: 37 Wh / 4,900 mAh

- **Dimensions (W x H x D):** 38.2 x 43.5 x 70.5 mm (1.5 x 1.7 x 2.8 in.)

- **Weight:** 220 g (7.8 oz.)

Weight and dimensions are approximate. Errors and omissions excepted.

The information in this manual is verified as of April 2014. Subject to change without notice.

# Index

24P .....51  
50.00 Hz/59.94 Hz recordings .....51

## A

ABB (automatic black balance) .....43  
Accessories .....159  
AE shift .....61  
Aperture .....60  
Aspect ratio .....119  
Assignable buttons .....89  
Audio output .....121  
Audio peak limiter .....75, 78  
Audio recording .....74  
Audio recording level .....75, 78  
Audio reference signal .....80  
AV OUT terminal .....119

## B

Battery pack .....21  
Bit rate .....51  
Black balance .....43  
Built-in backup battery .....157  
Built-in microphone .....74, 76

## C

Camera settings .....103  
Canon Log gamma .....49  
CINEMA (preset custom picture) .....49  
Clips  
    Converting to SD .....113  
    Copying .....111  
    Deleting .....112  
    Playback .....107  
    Saving to a computer .....123  
Color bars .....80  
Condensation .....158  
Connection to an external monitor .....118  
Continuous AF .....66  
Continuous recording .....85  
Custom displays .....102  
Custom functions .....102  
Custom picture .....92  
    Detailed custom picture settings .....95  
    Graphical interface .....101

## D

Date and time .....25  
DC IN terminal .....24  
Double slot recording .....41  
Down-conversion (HD ➔ SD) .....113  
Drop frame (time code) .....71

## E

Edge monitor .....82  
EF lens .....29  
EF-S lens correction .....31  
Exposure compensation .....61  
EXT terminal .....32

## F

Fan .....37  
File numbering .....147  
Flicker reduction .....56  
Focus .....65  
Frame rate .....51  
Free-run (time code) .....70

## G

Gain .....57  
Gamma curve .....101  
Grip belt .....35  
Grip unit .....34

## H

Handle unit .....32  
HDMI OUT terminal .....118  
Headphone terminal .....79  
Hour meter .....140

## I

Index screens .....105  
Iris .....60  
ISO speed .....57

## J

Joystick .....27, 53, 109  
Joystick guide .....109

**K**

Key lock .....47, 62

**L**

Language .....26

LCD screen .....33

Lens firmware .....31

Light metering mode .....62

LUT (lookup table) .....50

**M**

Magnification .....67

Menu settings .....133

Message list .....151

MIC terminal .....74

Microphone .....74

Microphone attenuator .....76, 79

Microphone sensitivity .....76, 79

Modular units .....29

Monitor delay .....121

My Menu .....28

**N**

ND filter .....59

Non-drop frame (time code) .....71

**O**

One-shot AF .....65

Onscreen displays .....48, 102, 108

Onscreen markers .....68

**P**

Peaking .....67

Peripheral illumination correction .....30

Phantom power (microphone) .....77

Photos

    Copying .....128

    Copying custom picture files .....131

    Deleting .....129

    Viewing .....127

Playback

    Clips .....107

    Photos .....127

Power supply .....21

POWER switch .....24

Pre-recording mode .....84

Push auto iris .....61

**R**

Rec run (time code) .....70

Recording

    Clips .....45

    Photos .....125

Relay recording .....41

Remaining battery .....23

Remote Controller .....87

REMOTE terminal .....87

Resetting all camcorder settings .....138

Resolution (frame size) .....51

Reviewing a recording .....83

Running mode (time code) .....70

**S**

Safety zone .....68

SD card .....39

    Initializing .....40

    Inserting/Removing .....39

    Recording method .....41

    Recovering data .....42

    Switching SD card slots .....41, 106

SD movies .....113, 115

Shot list .....106

Shots .....85, 112

Shutter speed .....54

Specifications .....162

Status screens .....141

System frequency .....51

**T**

Tally lamps .....45, 138

Terminal covers .....36

Thumb rest .....34

Time code .....70

Tripod .....34

Troubleshooting .....148

Turning the camcorder on/off .....24

**U**

USB terminal .....123

User bit .....73

**V**

Video configuration .....	51
Video output configuration .....	117
Video scopes .....	81
View assistance .....	50
Viewfinder .....	33
Volume .....	109

**W**

Waveform monitor .....	81
White balance .....	63, 101

**X**

XLR terminals .....	74
---------------------	----

**Z**

Zebra pattern .....	69
---------------------	----

## CANON CINEMA EOS LIMITED WARRANTY FOR PRODUCTS PURCHASED IN THE UNITED STATES

The limited warranty set forth below is given by Canon U.S.A., Inc. ('Canon USA') with respect to (a) the Canon Cinema EOS Product, and (b) the accessories for the Canon Cinema EOS Product (if any), packaged with this limited warranty (collectively the "Products")\* and purchased in the United States. This limited warranty is only effective upon presentation of your Bill of Sale or other proof of purchase. The Products are warranted to the original end-user purchaser, when delivered in new condition in its original container, under normal use against defective materials or workmanship as follows: Parts: At Canon USA's option, defective parts will be exchanged for new parts or comparable rebuilt parts for a period of ONE YEAR from the date of original purchase. Labor: For a period of ONE YEAR from the date of original purchase, labor will be provided free of charge by Canon USA's factory service centers or designated service facilities located in the United States. When returning Products under this warranty, you must pre-pay the shipping charges, and you must enclose a copy of the Bill of Sale or other proof of purchase with a complete explanation of the problem. During the ONE-YEAR warranty period, repairs will be made and the Products will be return-shipped to you free of charge. For repairs after the warranty period is over, you will be given an estimate of the cost of repair and an opportunity to approve or disapprove of the repair expense before it is incurred. If you approve, repairs will be made and the Products will be returned to you at your risk and expense. If you disapprove, we will return-ship the Products to you at no charge to you to an address within the United States.

**This limited warranty only applies if the Products are used in conjunction with compatible computer equipment and compatible software, as to which items Canon USA will have no responsibility. Canon USA shall have no responsibility under this limited warranty for use of the Products in conjunction with incompatible peripheral equipment and/or incompatible software. Non-Canon brand peripheral equipment and software which may be distributed with, or factory loaded on, the Products, are sold 'AS IS' without warranty of any kind by Canon USA, including any implied warranty regarding merchantability or fitness for a particular purpose. The sole warranty with respect to such non-Canon brand items is given by the manufacturer or producer thereof.**

\*Except for the battery pack packaged with the Products, which carries a separate ninety (90) day limited warranty.

In order to obtain warranty service, please contact the authorized Canon retail dealer from whom you purchased the Products or contact the CANON INFORMATION CENTER AT **855-CINE-EOS** (855-246-3367) or on the internet at [pro.usa.canon.com/support](http://pro.usa.canon.com/support). You will be directed to the nearest service facility for your Products.

This Limited Warranty covers all defects encountered in normal use of the Products and does not apply in the following cases:

- A. Loss or damage to the Products due to abuse, mishandling, accident, improper maintenance, use of non-Canon accessories or failure to follow operating, maintenance or environmental instructions prescribed in Canon USA's user's manual;
- B. If the Products are defective as a result of leaking batteries, sand, dirt or water damage;
- C. If defects or damages are caused by the use of parts or supplies (other than those sold by Canon USA) that cause damage to the Products or that cause abnormally frequent service calls or service problems;
- D. If defects or damages are caused by service other than Canon USA's factory service centers or authorized service facilities;
- E. Any internal modification to product hardware or firmware;
- F. Any applicable fee for Maintenance of the Products;
- G. If the Product has had its serial number or dating altered or removed.

This Limited Warranty does not apply to Products purchased outside the United States. This Limited Warranty does not apply to accessories or consumables not originally packaged with the Product. Please retain this warranty card and your Bill of Sale as a permanent record of your purchase. This card ensures that you are contacted promptly should there be a safety inspection, modification or Product recall under applicable laws or regulations.

**NO IMPLIED WARRANTY, INCLUDING MERCHANTABILITY AND FITNESS FOR A PARTICULAR PURPOSE APPLIES TO THE PRODUCTS AFTER THE APPLICABLE PERIOD OF EXPRESS WARRANTY OR GUARANTY (EXCEPT AS MENTIONED ABOVE) GIVEN BY ANY PERSON, FIRM OR CORPORATION WITH RESPECT TO THE PRODUCTS SHALL BIND CANON USA (SOME STATES DO NOT ALLOW LIMITATIONS ON HOW LONG AN IMPLIED WARRANTY LASTS, SO THE ABOVE LIMITATION OR EXCLUSION MAY NOT APPLY TO YOU). CANON USA SHALL NOT BE LIABLE FOR LOSS OF REVENUES OR PROFITS, EXPENSE FOR SUBSTITUTE PRODUCTS OR SERVICE, STORAGE CHARGES, LOSS OR CORRUPTION OF DATA, INCLUDING WITHOUT LIMITATION, LOSS OR CORRUPTION OF DATA STORED ON THE PRODUCTS' HARD DRIVE, OR ANY OTHER SPECIAL, INCIDENTAL OR CONSEQUENTIAL DAMAGES CAUSED BY THE USE, MISUSE OR INABILITY TO USE THE PRODUCTS, REGARDLESS OF THE LEGAL THEORY ON WHICH THE CLAIM IS BASED, AND EVEN IF CANON USA HAS BEEN ADVISED OF THE POSSIBILITY OF SUCH DAMAGES. NOR SHALL RECOVERY OF ANY KIND AGAINST CANON USA BE GREATER THAN THE PURCHASE PRICE OF THE PRODUCTS SOLD BY CANON USA AND CAUSING THE ALLEGED DAMAGE. WITHOUT LIMITING THE FOREGOING, YOU ASSUME ALL RISK AND LIABILITY FOR LOSS, DAMAGE OR INJURY TO YOU AND YOUR PROPERTY AND TO OTHERS AND THEIR PROPERTY ARISING OUT OF USE, MISUSE OR INABILITY TO USE THE PRODUCTS NOT CAUSED DIRECTLY BY THE NEGLIGENCE OF CANON USA (SOME STATES DO NOT ALLOW THE EXCLUSION OR LIMITATION OF INCIDENTAL OR CONSEQUENTIAL DAMAGES, SO THE ABOVE LIMITATION MAY NOT APPLY TO YOU). THIS LIMITED WARRANTY SHALL NOT EXTEND TO ANYONE OTHER THAN THE ORIGINAL PURCHASER OF THE PRODUCTS OR THE PERSON FOR WHOM IT WAS PURCHASED AS A GIFT.**

This warranty gives you specific legal rights, and you may also have other rights which vary from state to state.

CANON U.S.A., INC.



## CANON CINEMA EOS LIMITED WARRANTY FOR PRODUCTS PURCHASED IN CANADA

The limited warranty set forth below is given by Canon Canada Inc. ('Canon Canada') with respect to (a) the Canon Cinema EOS product, and (b) the accessories for the Canon Cinema EOS Product (if any), packaged with this limited warranty (collectively the "Products")\* and purchased in Canada. This limited warranty is only effective upon presentation of your Bill of Sale or other proof of purchase. The Products are warranted to the original end-user purchaser, when delivered in new condition in its original container, under normal use against defective materials or workmanship as follows: Parts: At Canon Canada's option, defective parts will be exchanged for new parts or comparable rebuilt parts for a period of ONE YEAR from the date of original purchase. Labor: For a period of ONE YEAR from the date of original purchase, labor will be provided free of charge by Canon Canada's factory service center or designated service facilities located in Canada. When returning Products under this warranty, you must pre-pay the shipping charges, and you must enclose a copy of the Bill of Sale or other proof of purchase with a complete explanation of the problem. During the ONE-YEAR warranty period, repairs will be made and the Products will be return-shipped to you free of charge. For repairs after the warranty period is over, you will be given an estimate of the cost of repair and an opportunity to approve or disapprove of the repair expense before it is incurred. If you approve, repairs will be made and the Products will be returned to you at your risk and expense. If you disapprove, we will return-ship the Products to you at no charge to you at an address within Canada.

**This limited warranty only applies if the Products are used in conjunction with compatible computer equipment and compatible software, as to which items Canon Canada will have no responsibility. Canon Canada shall have no responsibility under this limited warranty for use of the Products in conjunction with incompatible peripheral equipment and/or incompatible software. Non-Canon brand peripheral equipment and software which may be distributed with, or factory loaded on, the Products, are sold 'AS IS' without warranty of any kind by Canon Canada, including any implied warranty or condition regarding merchantability or fitness for a particular purpose. The sole warranty with respect to such non-Canon brand items is given by the manufacturer or producer thereof.**

\*Except for the battery pack packaged with the Products, which carries a separate ninety (90) day limited warranty.

In order to obtain warranty service, please contact the authorized Canon retail dealer from whom you purchased the Products or contact the CANON PROFESSIONAL SERVICE CENTRE 1-800-667-2666 or on the internet at [www.canon.ca/pro](http://www.canon.ca/pro). You will be directed to the nearest service facility for your Products.

This Limited Warranty covers all defects encountered in normal use of the Products and does not apply in the following cases:

- A. Loss or damage to the Products due to abuse, mishandling, accident, improper maintenance, use of non-Canon accessories or failure to follow operating, maintenance or environmental instructions prescribed in Canon Canada's user's manual;
- B. If the Products are defective as a result of leaking batteries, sand, dirt or water damage;
- C. If defects or damages are caused by the use of parts or supplies (other than those sold by Canon Canada) that cause damage to the Products or that cause abnormally frequent service calls or service problems;
- D. If defects or damages are caused by service other than Canon Canada's factory service centers or authorized service facilities;
- E. Any internal modification to product hardware or firmware;
- F. Any applicable fee for Maintenance of the Products;
- G. If the Product has had its serial number or dating altered or removed.

This Limited Warranty does not apply to Products purchased outside Canada. This Limited Warranty does not apply to accessories or consumables not originally packaged with the Product. Please retain this warranty card and your Bill of Sale as a permanent record of your purchase. This card ensures that you are contacted promptly should there be a safety inspection, modification or Product recall under applicable laws or regulations.

**NO IMPLIED WARRANTY OR CONDITION, INCLUDING MERCHANTABILITY AND FITNESS FOR A PARTICULAR PURPOSE APPLIES TO THE PRODUCTS AFTER THE APPLICABLE PERIOD OF EXPRESS WARRANTY OR GUARANTY (EXCEPT AS MENTIONED ABOVE) GIVEN BY ANY PERSON, FIRM OR CORPORATION WITH RESPECT TO THE PRODUCTS SHALL BIND CANON CANADA (SOME PROVINCES DO NOT ALLOW LIMITATIONS ON HOW LONG AN IMPLIED WARRANTY OR CONDITION LASTS, SO THE ABOVE LIMITATION OR EXCLUSION MAY NOT APPLY TO YOU). CANON CANADA SHALL NOT BE LIABLE FOR LOSS OF REVENUES OR PROFITS, EXPENSE FOR SUBSTITUTE PRODUCTS OR SERVICE, STORAGE CHARGES, LOSS OR CORRUPTION OF DATA, INCLUDING WITHOUT LIMITATION, LOSS OR CORRUPTION OF DATA STORED ON THE PRODUCTS' HARD DRIVE, OR ANY OTHER SPECIAL, INCIDENTAL OR CONSEQUENTIAL DAMAGES CAUSED BY THE USE, MISUSE OR INABILITY TO USE THE PRODUCTS, REGARDLESS OF THE LEGAL THEORY ON WHICH THE CLAIM IS BASED, AND EVEN IF CANON CANADA HAS BEEN ADVISED OF THE POSSIBILITY OF SUCH DAMAGES. NOR SHALL RECOVERY OF ANY KIND AGAINST CANON CANADA BE GREATER THAN THE PURCHASE PRICE OF THE PRODUCTS SOLD BY CANON CANADA AND CAUSING THE ALLEGED DAMAGE. WITHOUT LIMITING THE FOREGOING, YOU ASSUME ALL RISK AND LIABILITY FOR LOSS, DAMAGE OR INJURY TO YOU AND YOUR PROPERTY AND TO OTHERS AND THEIR PROPERTY ARISING OUT OF USE, MISUSE OR INABILITY TO USE THE PRODUCTS NOT CAUSED DIRECTLY BY THE NEGLIGENCE OF CANON CANADA (SOME PROVINCES DO NOT ALLOW THE EXCLUSION OR LIMITATION OF INCIDENTAL OR CONSEQUENTIAL DAMAGES, SO THE ABOVE LIMITATION MAY NOT APPLY TO YOU). THIS LIMITED WARRANTY SHALL NOT EXTEND TO ANYONE OTHER THAN THE ORIGINAL PURCHASER OF THE PRODUCTS OR THE PERSON FOR WHOM IT WAS PURCHASED AS A GIFT.**

This warranty gives you specific legal rights, and you may also have other rights which vary from province to province.

CANON CANADA INC.



Canon Inc. 30-2, Shimomaruko 3-chome, Ohta-ku, Tokyo 146-8501, Japan

---

**ASIA and HONG KONG, S.A.R.**

Canon Hongkong Company Ltd  
19/F, The Metropolis Tower, 10 Metropolis Drive,  
Hungghom, Kowloon, Hong Kong  
☎ +852 3191 2333, 📠 +852 2428 3963

**AUSTRALIA** [www.canon.com.au](http://www.canon.com.au)

Canon Australia Pty Ltd  
☎ 13-13-83 (within Australia only)  
☎ (61) 02-9805-2555

**CANADA** [www.canon.ca/pro](http://www.canon.ca/pro)

**CANON CANADA INC.**  
❖ Professional Product Support /  
Soutien des produits professionnels  
☎ (800) 667-2666

**CENTRO Y SURAMÉRICA** [www.cla.canon.com](http://www.cla.canon.com)

**CANON LATIN AMERICA, INC.**

**EUROPE** [www.canon-europe.com](http://www.canon-europe.com)

Canon Europa N.V.  
Bovenkerkerweg 59,  
1185 XB Amstelveen, The Netherlands

**MÉXICO** [www.canon.com.mx](http://www.canon.com.mx)

**CANON MEXICANA, S DE RL DE CV**  
☎ 52 (55) 5249-4905

**NEW ZEALAND** [www.canon.co.nz](http://www.canon.co.nz)

Canon New Zealand Ltd  
☎ 0800-222-666 (within New Zealand only)  
☎ (64) 09-489-0300

**SINGAPORE**

Canon Singapore Pte. Ltd  
1 HarbourFront Avenue, #04-01 Keppel Bay Tower,  
Singapore 098632  
☎ (65) 6799 8888, 📠 (65) 6799 8882

**UNITED KINGDOM**

Canon UK Ltd  
CCI Service Centre, Unit 130, Centennial Park,  
Borehamwood, Hertfordshire, WD6 3SE  
☎ 0844-369-0100

**USA** [pro.usa.canon.com](http://pro.usa.canon.com)

**CANON U.S.A., INC.**  
[pro.usa.canon.com/support](http://pro.usa.canon.com/support)  
☎ (855) CINE-EOS (855-246-3367)  
(USA only)

---

Visit your local Canon Web site to download the latest version of this Instruction Manual.

