

Canon

EOS *REBEL T5* EOS 1200D



Basic Instruction Manual

This basic manual covers only the most basic operations.
For other features and more details, see the
Camera Instruction Manual pdf file in the CD-ROM.



Introduction

The EOS REBEL T5/EOS 1200D is a digital single-lens reflex camera featuring a fine-detail CMOS sensor with approx. 18.0 effective megapixels, DIGIC 4, high-precision and high-speed 9-point AF, approx. 3.0 fps continuous shooting, Live View shooting, and Full High-Definition (Full HD) movie shooting.

Before Starting to Shoot, Be Sure to Read the Following

To avoid botched pictures and accidents, first read the “Safety Precautions” (p.100-102) and “Handling Precautions” (p.12-13).

Refer to This Manual While Using the Camera to Further Familiarize Yourself with the Camera

While reading this manual, take a few test shots and see how they come out. You can then better understand the camera.

Testing the Camera Before Use and Liability

After shooting, play images back and check whether they have been properly recorded. If the camera or memory card is faulty and the images cannot be recorded or downloaded to a computer, Canon cannot be held liable for any loss or inconvenience caused.

Copyrights

Copyright laws in your country may prohibit the use of your recorded images or copyrighted music and images with music in the memory card for anything other than private enjoyment. Also be aware that certain public performances, exhibitions, etc., may prohibit photography even for private enjoyment.

Item Check List

Before starting, check that all the following items have been included with your camera. If anything is missing, contact your dealer.

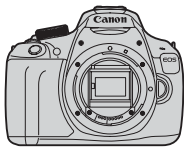

Camera

(with eyecup and body cap)



Battery Pack LP-E10
(with protective cover)



Battery Charger
LC-E10/LC-E10E*



Wide Strap



Interface Cable

* Battery Charger LC-E10 or LC-E10E is provided. (The LC-E10E comes with a power cord.)

- The Instruction Manual and CD-ROMs provided are listed on the next page.
- If you purchased a Lens Kit, check that the lenses are included.
- Depending on the Lens Kit type, lens instruction manuals may also be included.
- Be careful not to lose any of the above items.

Instruction Manual and CD-ROMs

The instruction manual consists of a booklet and PDF manuals in electronic form (provided on the CD-ROM disc). **The booklet is the Basic Instruction Manual. For more detailed instructions, see the Camera Instruction Manual on the CD-ROM disc.**



**Camera Basic
Instruction Manual**



Camera Instruction Manual CD-ROM

Contains the following instruction manuals in PDF:

- Camera Instruction Manual
- Quick Reference Guide

Instructions for viewing the Camera Instruction Manual CD-ROM are on page 90.



EOS DIGITAL Solution Disk (Software CD-ROM)

Contains software such as image-editing software and software instruction manuals in PDF format.

For more information and installation procedures of the software, see pages 94-96.

Instructions for viewing the Software Instruction Manual are on page 97.

Compatible Cards

The camera can use the following cards regardless of capacity: **If the card is new or was previously formatted by another camera or computer, it is recommended that you format the card with this camera** (p.42).

- SD memory cards
- SDHC memory cards
- SDXC memory cards



The camera can use UHS-I cards, but since it is not compatible with the UHS-I standard, reading/writing speeds will be equivalent to SD Speed Class 10 at most.

Cards that Can Record Movies

When shooting movies, use a large-capacity SD card rated SD Speed Class 6 “CLASS 6” or higher.

- If you use a slow-writing card when shooting movies, the movie may not be recorded properly. Also, if you play back a movie on a card with a slow reading speed, the movie may not play back properly.
- If you want to shoot still photos while shooting a movie, you will need an even faster card.
- To check the card's reading/writing speed, refer to the card manufacturer's Web site.



In this manual, “card” refers to SD memory cards, SDHC memory cards, and SDXC memory cards.

*** The camera does not come with a card for recording images/movies.** Please purchase it separately.

Quick Start Guide

1

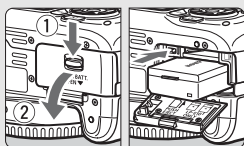

Insert the battery (p.24).

- To charge the battery, see page 22.

2

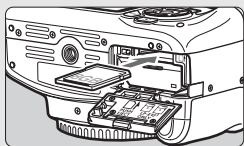

Insert a card (p.24).

- With the card's label facing toward the back of the camera, insert it into the card slot.

3

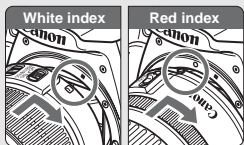

Attach the lens (p.32).

- Align the lens's white or red index with the camera's index in the matching color.

4

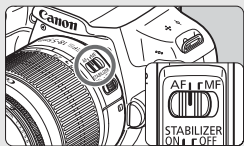

Set the lens's focus mode switch to <AF> (p.32).

5

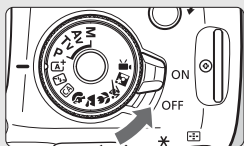

Set the power switch to <ON> (p.27).

- When the LCD monitor displays the date/time/zone setting screens, see page 29.

6

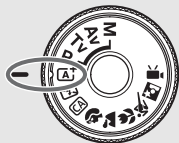

Set the Mode Dial to **<AI+>** (Scene Intelligent Auto) (p.48).

- All the necessary camera settings will be set automatically.

7



Focus on the subject (p.37).

- Look through the viewfinder and aim the viewfinder center over the subject.
- Press the shutter button halfway, and the camera will focus on the subject.
- If necessary, the built-in flash will be raised automatically.

8



Take the picture (p.37).

- Press the shutter button completely to take the picture.

9







Review the picture.

- The image just captured will be displayed for 2 sec. on the LCD monitor.
- To display the image again, press the **<▶>** button (p.65).





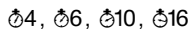

- To shoot while looking at the LCD monitor, see “Live View Shooting” (p.67).
- To view the images captured so far, see “Image Playback” (p.65).
- To delete an image, see “Erasing Images” (p.88).

Conventions Used in this Manual

Icons in this Manual

-  : Indicates the Main Dial.
-  : Indicates the  cross keys on the top, bottom, left, and right.
-  : Indicates the Setting button.
-  : Indicates that the corresponding function remains active for 4 sec., 6 sec., 10 sec., or 16 sec. respectively after you let go of the button.

* In this manual, the icons and markings indicating the camera's buttons, dials, and settings correspond to the icons and markings on the camera and on the LCD monitor.

-  : Indicates a function that can be changed by pressing the <MENU> button and changing the setting.
-  : Shown at the upper right of a page title to indicate a function that is available only in the Creative Zone modes (p.18).
- (p.**)
-  : Warning to prevent shooting problems.
-  : Supplemental information.
-  : Tips or advice for better shooting.
-  : Problem-solving advice.

Basic Assumptions



- All operations explained in this manual assume that the power switch is <ON> (p.27).
- It is assumed that all the menu settings and Custom Functions are set to their defaults.
- The illustrations in this manual show the camera attached with the EF-S18-55mm f/3.5-5.6 IS II lens as an example.













Contents

Introduction **2**





Item Check List	3
Instruction Manual and CD-ROMs	4
Compatible Cards	5
Quick Start Guide.....	6
Conventions Used in this Manual	8
Handling Precautions.....	12
Nomenclature.....	14

1 Getting Started **21**

Charging the Battery	22
Installing and Removing the Battery and Card	24
Turning on the Power.....	27
Setting the Date, Time, and Zone	29
Selecting the Interface Language	31
Attaching and Detaching a Lens	32
Lens Image Stabilizer	35
Basic Operation	36
 Quick Control for Shooting Functions.....	38
 Menu Operations	40
Formatting the Card	42
Switching the LCD Monitor Display.....	44
Feature Guide	45

2	Basic Shooting and Image Playback	47
	 Fully Automatic Shooting (Scene Intelligent Auto).....	48
	 Full Auto Techniques (Scene Intelligent Auto).....	51
	 Disabling Flash.....	53
	 Creative Auto Shooting.....	54
	 Shooting Portraits.....	57
	 Shooting Landscapes.....	58
	 Shooting Close-ups.....	59
	 Shooting Moving Subjects.....	60
	 Shooting Night Portraits.....	61
	 Quick Control.....	63
	 Image Playback.....	65
3	Shooting with the LCD Monitor (Live View Shooting)	67
	 Shooting with the LCD Monitor.....	68
	Using AF to Focus (AF Method).....	71
4	Shooting Movies	77
	 Shooting Movies.....	78
	Setting the Movie Recording Size.....	80

5 Image Playback 83

 Searching for Images Quickly	84
 Magnified View	85
 Playing Movies.....	86
 Erasing Images	88

**6 Viewing the CD-ROM Instruction Manuals /
Downloading Images to Your Computer 89**

Viewing the Camera Instruction Manual CD-ROM	90
Downloading Images to a Computer.....	92
Software Overview.....	94
Installing the Software.....	96
Software Instruction Manual	97
Safety Precautions.....	100

Handling Precautions

Camera Care

- This camera is a precision instrument. Do not drop it or subject it to physical shock.
- The camera is not waterproof and cannot be used underwater. If you accidentally drop the camera into water, promptly consult the nearest Canon Service Center. Wipe off any water droplets with a dry and clean cloth. If the camera has been exposed to salty air, wipe it with a well-wrung wet cloth.
- Never leave the camera near anything having a strong magnetic field such as a magnet or electric motor. Also avoid using or leaving the camera near anything emitting strong radio waves, such as a large antenna. Strong magnetic fields can cause camera misoperation or destroy image data.
- Do not leave the camera in excessive heat, such as in a car in direct sunlight. High temperatures can cause the camera to malfunction.
- The camera contains precision electronic circuitry. Never attempt to disassemble the camera yourself.
- Do not block the built-in flash, mirror operation with your finger, etc. Doing so may cause a malfunction.
- Use a blower to blow away dust on the lens, viewfinder, reflex mirror, and focusing screen. Do not use cleaners that contain organic solvents to clean the camera body or lens. For stubborn dirt, take the camera to the nearest Canon Service Center.
- Do not touch the camera's electrical contacts with your fingers. This is to prevent the contacts from corroding. Corroded contacts can cause camera misoperation.
- If the camera is suddenly brought in from the cold into a warm room, condensation may form on the camera and internal parts. To prevent condensation, first put the camera in a sealed plastic bag and let it adjust to the warmer temperature before taking it out of the bag.
- If condensation forms on the camera, do not use the camera. This is to avoid damaging the camera. If there is condensation, remove the lens, card and battery from the camera, and wait until condensation has evaporated before using the camera.
- If the camera will not be used for an extended period, remove the battery and store the camera in a cool, dry, well-ventilated location. Even while the camera is in storage, press the shutter button a few times once in a while to check that the camera is still working.
- Avoid storing the camera where there are chemicals that result in rust and corrosion such as in a chemical lab.

- If the camera has not been used for an extended period, test all its functions before using it. If you have not used the camera for some time or if there is an important shoot such as a foreign trip coming up, have the camera checked by your Canon dealer or check the camera yourself and make sure it is working properly.
- If you use continuous shooting, Live View shooting, or movie shooting for a prolonged period, the camera may become hot. This is not a malfunction.

LCD Monitor

- Although the LCD monitor is manufactured with very high precision technology with over 99.99% effective pixels, there may be a few dead pixels displaying only black or red, etc. among the remaining 0.01% or less pixels. Dead pixels are not a malfunction. They do not affect the images recorded.
- If the LCD monitor is left on for a prolonged period, screen burn-in may occur where you see remnants of what was displayed. However, this is only temporary and will disappear when the camera is left unused for a few days.
- The LCD monitor display may seem slow in low temperatures, or look black in high temperatures. It will return to normal at room temperature.

Cards

To protect the card and its recorded data, note the following:

- Do not drop, bend, or wet the card. Do not subject it to excessive force, physical shock, or vibration.
- Do not touch the card's electronic contacts with your fingers or anything metallic.
- Do not affix any stickers, etc., on the card.
- Do not store or use the card near anything that has a strong magnetic field, such as a TV set, speakers, or magnet. Also avoid places prone to having static electricity.
- Do not leave the card in direct sunlight or near a heat source.
- Store the card in a case.
- Do not store the card in hot, dusty, or humid locations.

Lens

After detaching the lens from the camera, put down the lens with the rear end up and attach the lens caps to avoid scratching the lens surface and electrical contacts.

Smudges Adhering to the Front of the Sensor

Besides dust entering the camera from outside, in rare cases lubricant from the camera's internal parts may adhere to the front of the sensor. If visible spots remain on the image, having the sensor cleaned by a Canon Service Center is recommended.



Nomenclature

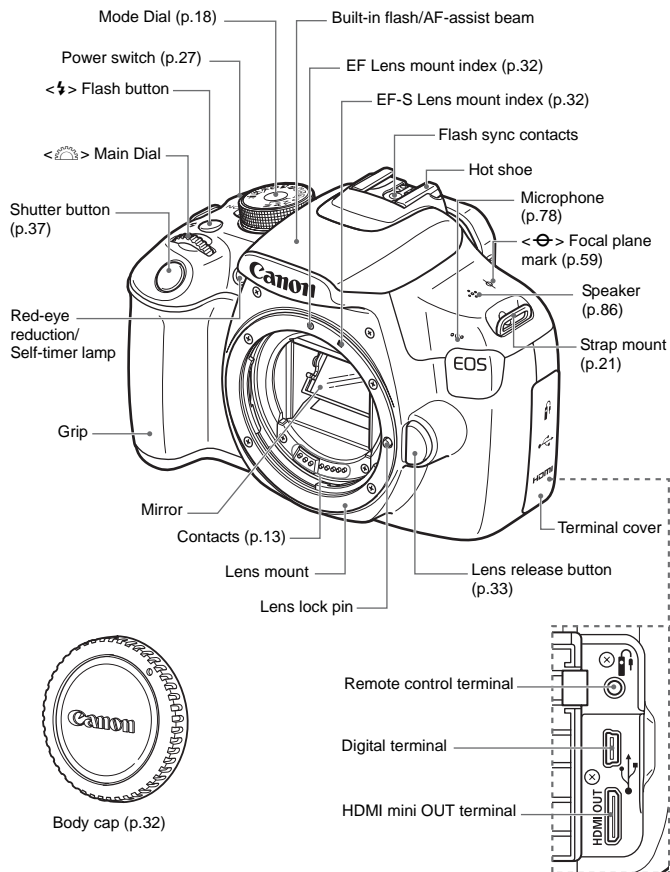

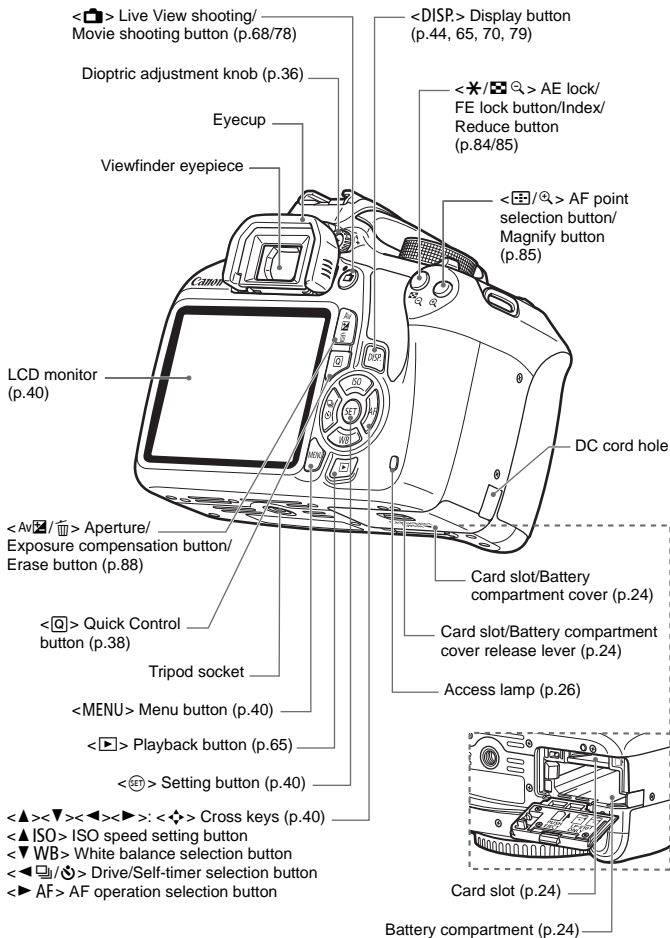

Shooting Settings (in Creative Zone modes, p.18)

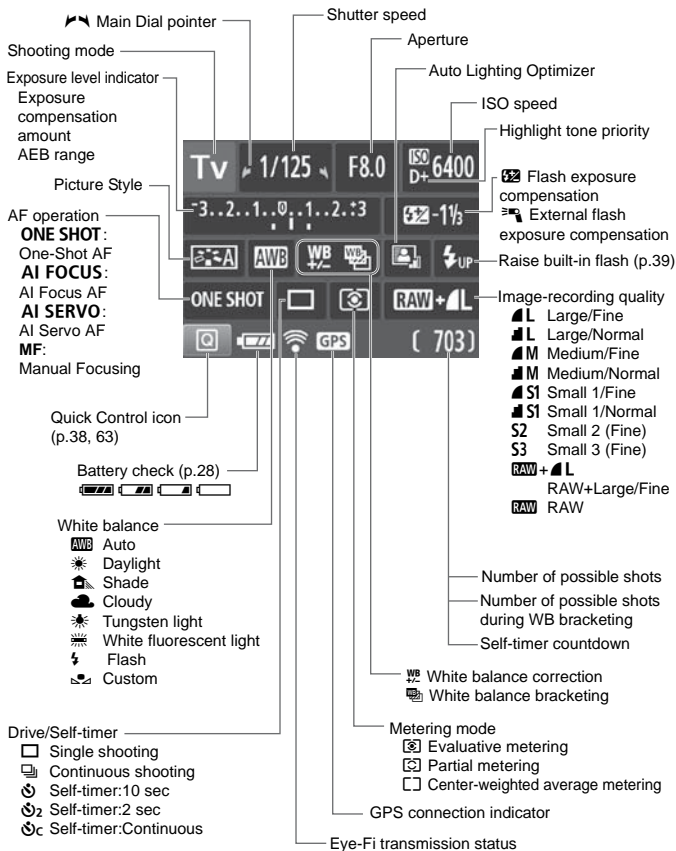

The display will show only the settings currently applied.

Viewfinder Information

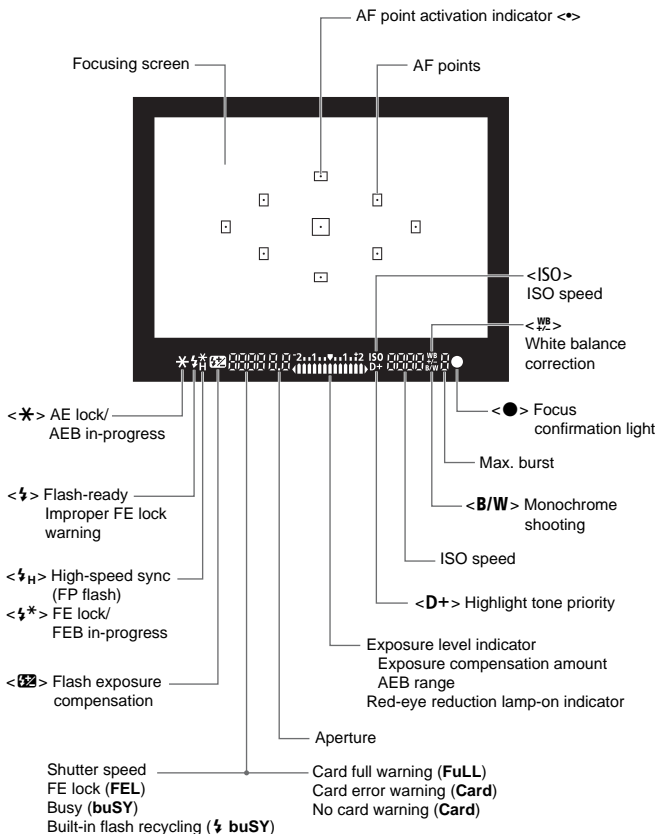

The display will show only the settings currently applied.

Mode Dial

The Mode Dial includes the Basic Zone modes, Creative Zone modes, and the Movie shooting mode.

Creative Zone Modes

These modes give you more control for shooting various subjects.

- P** : Program AE
- Tv** : Shutter-priority AE
- Av** : Aperture-priority AE
- M** : Manual exposure

Basic Zone Modes

All you do is press the shutter button. The camera sets everything to suit the subject or scene.

- A+** : Scene Intelligent Auto (p.48)
- [Flash Off]** : Flash Off (p.53)
- CA** : Creative Auto (p.54)

Image Zone Modes

- [Portrait]** : Portrait (p.57)
- [Landscape]** : Landscape (p.58)
- [Close-up]** : Close-up (p.59)
- [Sports]** : Sports (p.60)
- [Night Portrait]** : Night Portrait (p.61)

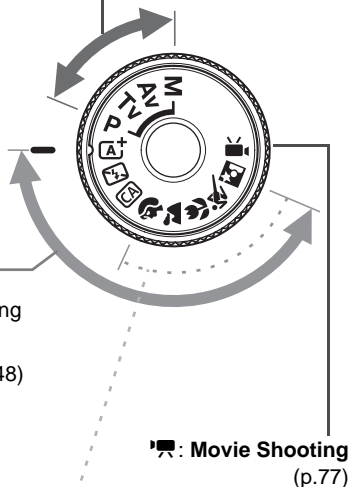

Lens

Lens without a distance scale

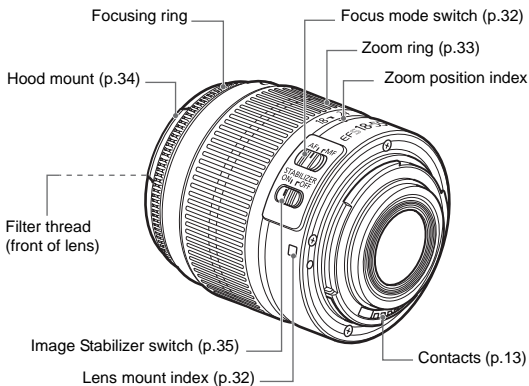

Battery Charger LC-E10

Charger for Battery Pack LP-E10 (p.22).

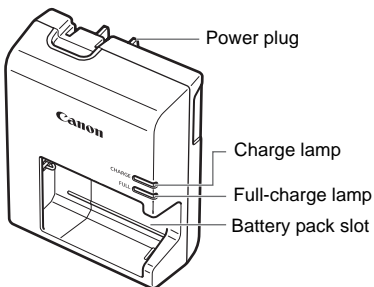

**IMPORTANT SAFETY INSTRUCTIONS-SAVE THESE INSTRUCTIONS.
DANGER-TO REDUCE THE RISK OF FIRE OR ELECTRIC SHOCK,
CAREFULLY FOLLOW THESE INSTRUCTIONS.**

For connection to a supply not in the U.S.A., use an attachment plug adapter of the proper configuration for the power outlet, if needed.

Battery Charger LC-E10E

Charger for Battery Pack LP-E10 (p.22).

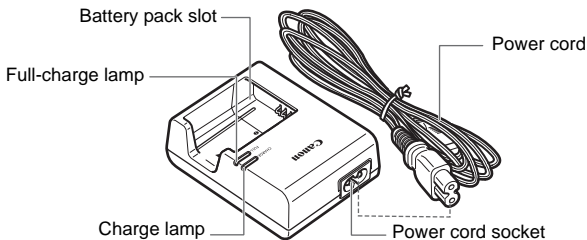

1

Getting Started

This chapter explains preparatory steps before you start shooting and basic camera operations.

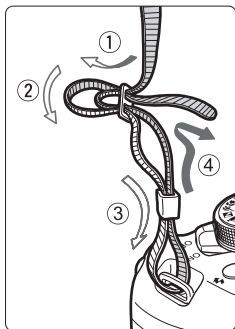

Attaching the Strap

Pass the end of the strap through the camera's strap mount eyelet from the bottom. Then pass it through the strap's buckle as shown in the illustration. Pull the strap to take up any slack and make sure the strap will not loosen from the buckle.

- The eyepiece cover is also attached to the strap.

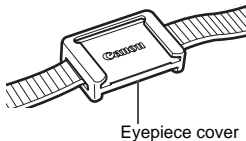

Charging the Battery

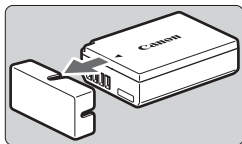

1 Remove the protective cover.

- Detach the protective cover provided with the battery.

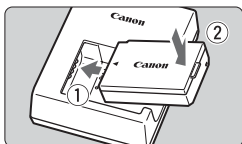

2 Attach the battery.

- As shown in the illustration, attach the battery securely to the charger.
- To detach the battery, follow the above procedure in reverse.

LC-E10

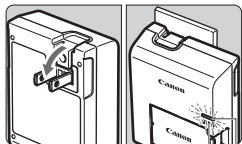

3 Recharge the battery.

For LC-E10

- As shown by the arrow, flip out the battery charger's prongs and insert the prongs into a power outlet.

For LC-E10E

- Connect the power cord to the charger and insert the plug into a power outlet.

Full-charge lamp

Charge lamp

LC-E10E

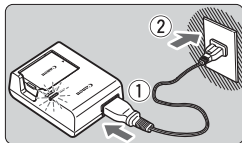

- ▶ Recharging starts automatically and the charge lamp lights up in orange.
- ▶ When the battery is fully recharged, the full-charge lamp will light up in green.

- It takes approx. 2 hours to fully recharge a completely exhausted battery at room temperature (23°C / 73°F). The time required to recharge the battery will vary greatly depending on the ambient temperature and the battery's remaining capacity.
- For safety reasons, recharging in low temperatures (6°C - 10°C / 43°F - 50°F) will take longer (up to approx. 4 hours).



Tips for Using the Battery and Charger

- **Upon purchase, the battery is not fully charged.**
Charge the battery before use.
 - **Recharge the battery on the day before or on the day it is to be used.**
Even during storage, a charged battery will gradually drain and lose its capacity.
 - **After recharging the battery, detach it and disconnect the charger from the power outlet.**
 - **When not using the camera, remove the battery.**
If the battery is left in the camera for a prolonged period, a small amount of power current is released, resulting in excess discharge and shorter battery life. Store the battery with the protective cover (provided) attached. Storing the battery when it is fully charged may lower the battery's performance.
 - **The battery charger can also be used in foreign countries.**
The battery charger is compatible with a 100 V AC to 240 V AC 50/60 Hz power source. If necessary, attach a commercially-available plug adapter for the respective country or region. Do not attach any portable voltage transformer to the battery charger. Doing so can damage the battery charger.
 - **If the battery becomes exhausted quickly even after being fully charged, the battery has reached the end of its service life.**
Purchase a new battery.
-
- After disconnecting the charger's power plug, do not touch the prongs for at least 3 sec.
 - Do not charge any battery other than a Battery Pack LP-E10.
 - Battery Pack LP-E10 is dedicated to Canon products only. Using it with an incompatible battery charger or product may result in malfunction or accidents for which Canon cannot be held liable.

Installing and Removing the Battery and Card

Load a fully charged Battery Pack LP-E10 into the camera. The camera can use an SD, SDHC, or SDXC memory card (sold separately). The captured images are recorded onto the card.

- **Make sure the card's write-protect switch is set upward to enable writing/erasing.**

Installing the Battery and Card

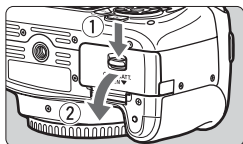

1 Open the cover.

- Slide the lever as shown by the arrows and open the cover.

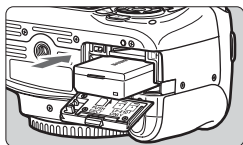

2 Insert the battery.

- Insert the end with the battery contacts.
- Insert the battery until it locks in place.

Write-protect switch

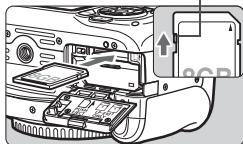

3 Insert the card.

- As shown by the illustration, face the card's label side toward the back of the camera and insert it until it clicks in place.

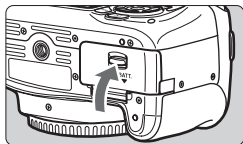

4 Close the cover.

- Press the cover until it snaps shut.
- When you set the power switch to <ON>, the number of possible shots (p.28) will be displayed on the LCD monitor.



After opening the card slot/battery compartment cover, be careful not to swing it back further. Otherwise, the hinge may break.



- The number of possible shots depends on the remaining capacity of the card, image-recording quality, ISO speed, etc.
- Setting [1: Release shutter without card] to [Disable] will prevent you from forgetting to insert a card.

Removing the Battery and Card

1 Set the power switch to <OFF>
(p.27).

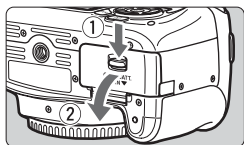

2 Open the cover.

- Make sure the access lamp is off, then open the cover.
- If [Recording...] is displayed, close the cover.

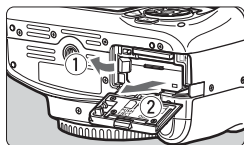

3 Remove the battery.

- Press the battery lock lever as shown by the arrow and remove the battery.
- To prevent short circuiting of the battery contacts, be sure to attach the provided protective cover (p.22) to the battery.

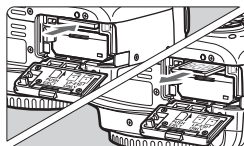

4 Remove the card.

- Gently push in the card, then let it go to eject.
- Pull the card straight out.

5 Close the cover.

- Press the cover until it snaps shut.

- **When the access lamp is lit or blinking, it indicates that images are being written to or read by the card, being erased, or data is being transferred. Do not open the card slot/battery compartment cover. Also, never do any of the following while the access lamp is lit or blinking. Otherwise, it can damage the image data, card, or camera.**
 - **Removing the card.**
 - **Removing the battery.**
 - **Shaking or banging the camera around.**
- If the card already contains recorded images, the image number may not start from 0001.
- If a card-related error message is displayed on the LCD monitor, remove and reinsert the card. If the error persists, use a different card. If you can transfer all the images on the card to a computer, transfer all the images, then format the card with the camera (p.42). The card may then return to normal.
- Do not touch the card's contacts with your fingers or metal objects. Do not expose the contacts to dust or water. If a smudge adheres to the contacts, contact failure may result.
- The camera cannot use MultiMediaCards (MMC). (A card error will appear.)

Turning on the Power

If you turn on the power and the date/time/zone setting screen appears, see page 29 to set the date/time/zone.

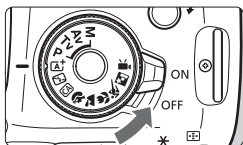

- <ON> : The camera turns on.
<OFF> : The camera is turned off and does not operate. Set to this position when not using the camera.

MENU Auto Power Off

- To save battery power, the camera turns off automatically after approx. 30 seconds of non-operation. To turn on the camera again, just press the shutter button halfway (p.37).
- You can set the auto power off time with [**F1: Auto power off**].







If you set the power switch to <OFF> while an image is being recorded to the card, [**Recording...**] will be displayed and the power will turn off after the card finishes recording the image.

Checking the Battery Level

When the power is turned on, the battery level will be indicated in one of the four levels.



-  : Battery level is sufficient.
-  : Battery level is low, but the camera can still be used.
-  : Battery will be exhausted soon. (Blinks)
-  : Recharge the battery.

Number of Possible Shots (Approx. number of shots)

Temperature	Room Temperature (23°C / 73°F)	Low Temperatures (0°C / 32°F)
No Flash	600	580
50% Flash Use	500	410

- The figures above are based on a fully-charged Battery Pack LP-E10, no Live View shooting, and CIPA (Camera & Imaging Products Association) testing standards.



- Doing any of the following will exhaust the battery sooner:
 - Pressing the shutter button halfway for a prolonged period.
 - Activating the AF frequently without taking a picture.
 - Using the lens Image Stabilizer.
 - Using the LCD monitor often.
- The number of possible shots may decrease depending on the actual shooting conditions.
- The lens operation is powered by the camera's battery. Depending on the lens used, the battery power may be consumed faster.
- For the number of possible shots with Live View shooting, see page 69.

MENU Setting the Date, Time, and Zone

When you turn on the power for the first time or if the date/time/zone have been reset, the date/time/zone setting screen will appear. Follow the steps below to set the time zone first. If you set the camera to the correct time zone for where you currently live, when you travel to another time zone you can simply set the camera to the correct time zone for your destination to adjust the camera's date/time automatically.

Note that the date/time appended to recorded images will be based on this date/time setting. Be sure to set the correct date/time.

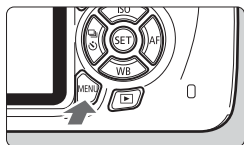

1 Display the menu screen.

- Press the <MENU> button to display the menu screen.



2 Under the [F2] tab, select [Date/Time/Zone].

- Press the <◀> <▶> keys to select the [F2] tab.
- Press the <▲> <▼> keys to select [Date/Time/Zone], then press <SET>.

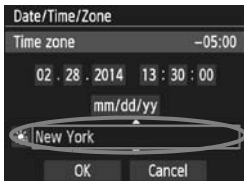

3 Set the time zone.

- [London] is set by default.
- Press the <◀> <▶> keys to select the time zone box.
- Press <SET> so <□> is displayed.
- Press the <▲> <▼> keys to select the time zone, then press <SET>.
(Returns to <□>.)



- The menu setting procedure is explained on pages 40-41.
- In step 3, the time displayed on the upper right of the screen is the time difference compared with Coordinated Universal Time (UTC). If you do not see your time zone, set the time zone while referring to the difference with UTC.

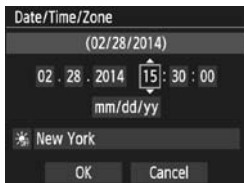

4 Set the date and time.

- Press the <◀> <▶> keys to select the number.
- Press <SET> so <☐> is displayed.
- Press the <▲> <▼> keys to set the number, then press <SET>. (Returns to <☐>.)

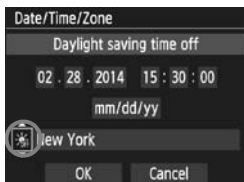

5 Set the daylight saving time.

- Set it if necessary.
- Press the <◀> <▶> keys to select [☀].
- Press <SET> so <☐> is displayed.
- Press the <▲> <▼> keys to select [☀], then press <SET>.
- When the daylight saving time is set to [☀], the time set in step 4 will advance by 1 hour. If [☀] is set, the daylight saving time will be canceled and the time will go back by 1 hour.

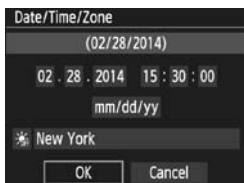

6 Exit the setting.

- Press the <◀> <▶> keys to select [OK], then press <SET>.
- ▶ The date/time/zone and daylight saving time will be set and the menu will reappear.

! The date/time/zone settings may be reset in the following cases. If this happens, set the date/time/zone again.

- When the camera is stored without the battery.
- When the camera's battery becomes exhausted.
- When the camera is exposed to below freezing temperatures for a prolonged period.

- The date/time that was set will start from when you press <SET> in step 6.
- After changing the time zone, check that the correct date/time has been set.

MENU Selecting the Interface Language

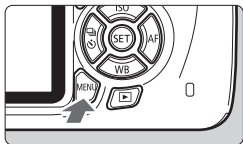

1 Display the menu screen.

- Press the <MENU> button to display the menu screen.



2 Under the [F2] tab, select [Language].

- Press the <◀> <▶> keys to select the [F2] tab.
- Press the <▲> <▼> keys to select [Language], then press <SET>.



3 Set the desired language.

- Press the <◇> cross keys to select the language, then press <SET>.
- ▶ The interface language will change.

English	Norsk	Română
Deutsch	Svenska	Türkçe
Français	Español	العربية
Nederlands	Ελληνικά	ગુજરાતી
Dansk	Русский	繁體中文
Português	Polski	繁體中文
Suomi	Čeština	한국어
Italiano	Magyar	日本語
Українська		

Attaching and Detaching a Lens

The camera is compatible with all Canon EF and EF-S lenses. **The camera cannot be used with EF-M lenses.**

Attaching a Lens

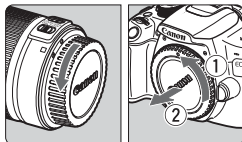

1 Remove the caps.

- Remove the rear lens cap and the body cap by turning them as shown by the arrows.

White index

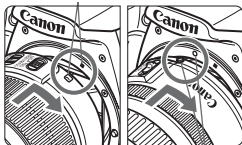

2 Attach the lens.

- Align the lens's red or white index with the camera's index matching the same color. Turn the lens as shown by the arrow until it clicks in place.

Red index

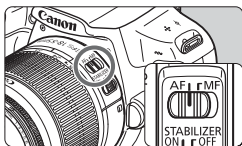

3 Set the lens's focus mode switch to <AF>.

- <AF> stands for autofocus.
- If it is set to <MF> (manual focus), autofocus will not operate.

4 Remove the front lens cap.

Minimizing Dust

- When changing lenses, do it quickly in a place with minimal dust.
- When storing the camera without a lens attached, be sure to attach the body cap to the camera.
- Remove dust on the body cap before attaching it.

Zooming

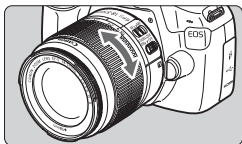

To zoom, turn the zoom ring on the lens with your fingers.

If you want to zoom, do it before focusing. Turning the zoom ring after achieving focus may throw off the focus.

Detaching the Lens

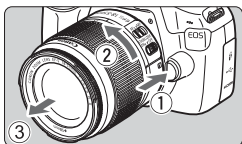

While pressing the lens release button, turn the lens as shown by the arrows.

- Turn the lens until it stops, then detach it.
- Attach the rear lens cap to the detached lens.



- Do not look at the sun directly through any lens. Doing so may cause loss of vision.
- When attaching or detaching a lens, set the camera's power switch to <OFF>.
- If the front part (focusing ring) of the lens rotates during autofocus, do not touch the rotating part.



Image Conversion Factor

Since the image sensor size is smaller than the 35mm film format, it will look like the lens focal length is increased by approx. 1.6x.



Image sensor size (Approx.)
(22.3 x 14.9 mm / 0.88 x 0.59 in.)

35mm image size
(36 x 24 mm / 1.42 x 0.94 in.)

Attaching a Lens Hood

A lens hood can block unwanted light and diminish rain, snow, dust etc. adhering to the front of the lens. Before storing the lens in a bag, etc., you can attach the hood in reverse.

- **If there is no index mark on the lens and hood:**

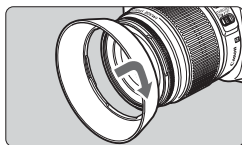

Attach the lens hood.

- Turn the hood as shown by the arrow to attach it securely.

- **If there is an index mark on the lens and hood:**

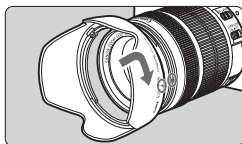

- 1 Align the red dots on the hood and lens edges, then turn the hood as shown by the arrow.**

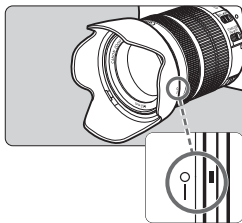

- 2 Turn the hood as shown in the illustration.**

- Turn the hood clockwise until it attaches securely.

- If you do not attach the hood properly, it may obstruct the image's periphery, making it look dark.
- When attaching or detaching the hood, grasp the base of the hood when turning it. Grasping the hood's edges when turning it may deform the hood, resulting in failure to turn.
- When using the camera's built-in flash, detach the hood. Otherwise, the hood will obstruct part of the flash.

Lens Image Stabilizer

When you use an Image Stabilizer (IS) lens, camera shake is corrected to obtain a sharper shot. The procedure explained here is based on the EF-S18-55mm f/3.5-5.6 IS II lens as an example.

* IS stands for Image Stabilizer.

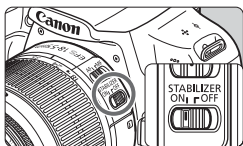

- 1 Set the IS switch to <ON>.**
 - Set also the camera's power switch to <ON>.
- 2 Press the shutter button halfway.**
 - ▶ The Image Stabilizer will operate.
- 3 Take the picture.**
 - When the picture looks steady in the viewfinder, press the shutter button completely to take the picture.



- The Image Stabilizer is not effective if the subject moves at the time of exposure.
- For bulb exposures, set the IS switch to <OFF>. If <ON> is set, Image Stabilizer misoperation may occur.
- The Image Stabilizer may not be effective for excessive shaking such as on a rocking boat.



- The Image Stabilizer can operate with the lens's focus mode switch set to either <AF> or <MF>.
- When using a tripod, you can still shoot with the IS switch set to <ON> with no problem. However, to save battery power, setting the IS switch to <OFF> is recommended.
- The Image Stabilizer is effective even when the camera is mounted on a monopod.
- Some IS lenses enable you to switch the IS mode manually to suit the shooting conditions. However, the EF-S18-55mm f/3.5-5.6 IS II or EF-S55-250mm f/4-5.6 IS II switches the IS mode automatically.

Basic Operation

Adjusting the Viewfinder Sharpness

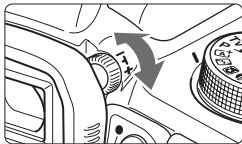

Turn the dioptic adjustment knob.

- Turn the knob left or right so that the AF points (nine boxes) in the viewfinder look sharp.

If the camera dioptic adjustment still cannot provide a sharp viewfinder image, using E-series Dioptic Adjustment Lenses (sold separately) is recommended.

Holding the Camera

To obtain sharp images, hold the camera still to minimize camera shake.

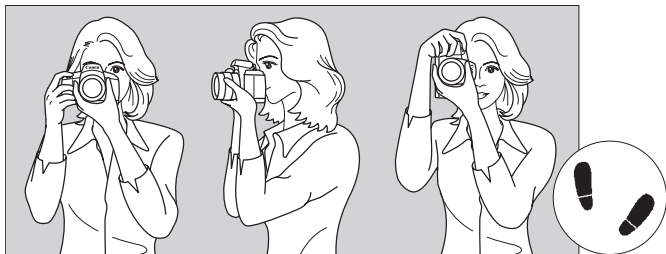

Horizontal shooting

Vertical shooting

1. Wrap your right hand around the camera grip firmly.
2. Hold the lens bottom with your left hand.
3. Rest your hand's right index finger lightly on the shutter button.
4. Press your arms and elbows lightly against the front of your body.
5. To maintain a stable stance, place one foot slightly ahead of the other.
6. Press the camera against your face and look through the viewfinder.

To shoot while looking at the LCD monitor, see page 67.

Shutter Button

The shutter button has two steps. You can press the shutter button halfway. Then you can further press the shutter button completely.

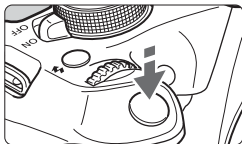

Pressing Halfway

This activates autofocus and the automatic exposure system that sets the shutter speed and aperture. The exposure setting (shutter speed and aperture) is displayed in the viewfinder (⊙4).

While you press the shutter button halfway, the LCD monitor will turn off.

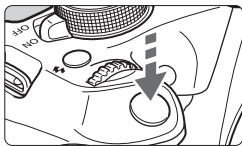

Pressing Completely

This releases the shutter and takes the picture.

Preventing Camera Shake

Hand-held camera movement during the moment of exposure is called camera shake. It can cause blurred pictures. To prevent camera shake, note the following:

- Hold and steady the camera as shown on the preceding page.
- Press the shutter button halfway to autofocus, then slowly press the shutter button completely.



- If you press the shutter button completely without pressing it halfway first, or if you press the shutter button halfway and then press it completely immediately, the camera will take a moment before it takes the picture.
- Even during menu display, image playback, or image recording, you can instantly go back to shooting-ready by pressing the shutter button halfway.

Q Quick Control for Shooting Functions

You can directly select and set the shooting functions displayed on the LCD monitor. This is called the Quick Control.



1 Press the **<Q>** button.

- ▶ The Quick Control screen will appear (10).

2 Set the desired function.

- Press the **<⬆>** cross keys to select a function.
- ▶ The selected function and Feature guide (p.45) will appear.
- Turn the **<⚙>** dial to change the setting.

Basic Zone Modes

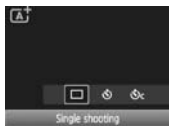

Creative Zone Modes

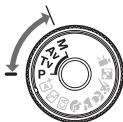

3 Take the picture.

- Press the shutter button completely to take the picture.
- ▶ The captured image will be displayed.

 For the functions settable in Basic Zone modes and the setting procedure, see page 63.

Sample Quick Control Screen

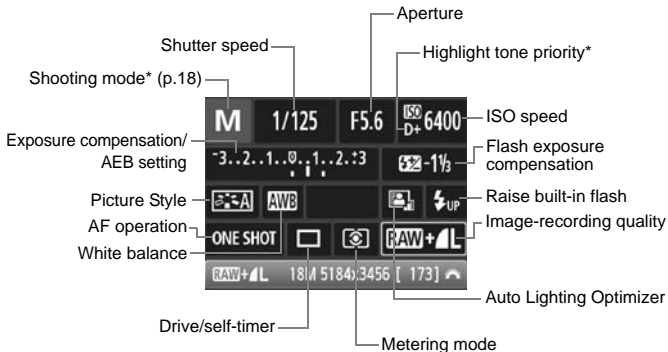

- * These functions cannot be set with the Quick Control screen.
- When you select <UP> and press <SET>, the built-in flash will pop-up.

Function Setting Screen



- Select the desired function and press <SET>. The function setting screen will appear.
- Press the <◀> <▶> keys or turn the <DISP.> dial to change some of the settings. Also, some functions can be set by pressing the <DISP.> button.
- Press <SET> to finalize the setting and return to the Quick Control screen.

MENU Menu Operations

You can set various settings with the menus such as the image-recording quality, date/time, etc.

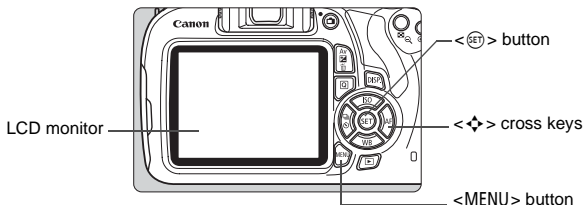

Menu Screen

The menu tabs and items displayed will differ depending on the shooting mode.

Basic Zone Modes



Movie Shooting Mode



Creative Zone Modes

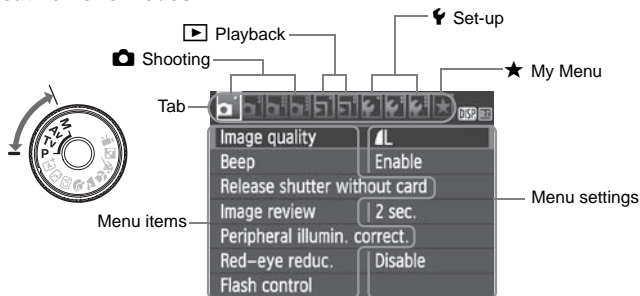

Menu Setting Procedure

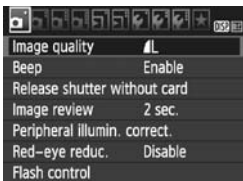

1 Display the menu screen.

- Press the <MENU> button to display the menu screen.

2 Select a tab.

- Press the <◀> <▶> keys to select a tab (group of functions).
- For example, in this manual, “the [📷3] tab” refers to the screen displayed when the third 📷 (Shooting) tab from the left [📷:] is selected.

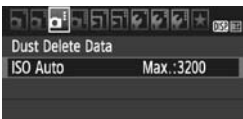

3 Select the desired item.

- Press the <▲> <▼> keys to select the option, then press <SET>.



4 Select the setting.

- Press the <▲> <▼> or <◀> <▶> keys to select the desired setting. (Some settings require you to press either the <▲> <▼> or <◀> <▶> keys to select it.)
- The current setting is indicated in blue.

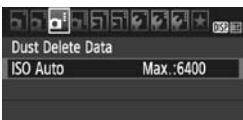

5 Set the desired setting.

- Press <SET> to set it.

6 Exit the setting.

- Press the <MENU> button to return to the shooting function settings display.



- In step 2, you can also turn the <📷> dial to select a menu tab.
- The explanation of menu functions hereinafter assumes that you have pressed the <MENU> button to display the menu screen.
- To cancel, press the <MENU> button.

MENU Formatting the Card

If the card is new or was previously formatted by another camera or computer, format the card with the camera.

- !** When the card is formatted, all images and data in the card will be erased. Even protected images will be erased, so make sure there is nothing you need to keep. If necessary, transfer the images and data to a computer, etc., before formatting the card.

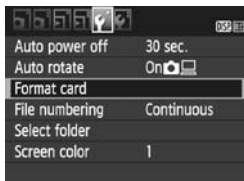

1 Select [Format card].

- Under the [**F1**] tab, select [**Format card**], then press <SET>.

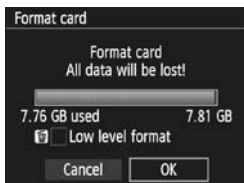

2 Format the card.

- Select [**OK**], then press <SET>.
- ▶ The card will be formatted.
- ▶ When the formatting is completed, the menu will reappear.



- For low-level formatting, press the <[F1]> button to append [**Low level format**] with a checkmark <✓>, then select [**OK**].

**Execute [Format card] in the following cases:**

- The card is new.
- The card was formatted by a different camera or a computer.
- The card is full with images or data.
- A card-related error is displayed.

Low-level Formatting

- Perform low-level formatting if the card's recording or reading speed seems slow or if you want to totally erase data in the card.
- Since low-level formatting will format all recordable sectors in the card, the formatting will take slightly longer than normal formatting.
- You can stop the low-level formatting by selecting **[Cancel]**. Even in this case, normal formatting will be completed and you can use the card as usual.



- When the card is formatted or data is erased, only the file management information is changed. The actual data is not completely erased. Be aware of this when selling or discarding the card. When discarding the card, execute low-level formatting or destroy the card physically to prevent the personal data from being leaked.
- **Before using a new Eye-Fi card, the software on the card must be installed on your computer. Then format the card with the camera.**



- The card capacity displayed on the card format screen may be smaller than the capacity indicated on the card.
- This device incorporates exFAT technology licensed from Microsoft.

Switching the LCD Monitor Display

The LCD monitor can display the shooting settings screen, menu screen, captured images, etc.

Shooting Settings

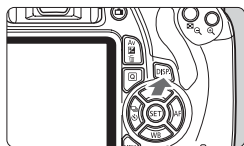

- When you turn on the power, the shooting settings will be displayed.
- **When you press the shutter button halfway, the display will turn off. And when you let go of the shutter button, the display will turn on.**
- **You can also turn off the display by pressing the <DISP.> button.** Press the button again to turn on the display.

Menu Functions

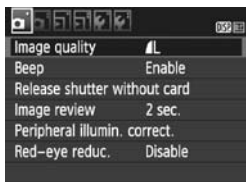

- Appears when you press the <MENU> button. Press the button again to return to the shooting settings screen.

Captured Image



- Appears when you press the <▶> button. Press the button again to return to the shooting settings screen.

- You can set [**2: LCD off/on btn**] so that the shooting settings display does not keep turning off and on.
- Even when the menu screen or captured image is displayed, pressing the shutter button will enable you to shoot immediately.

Feature Guide

The Feature guide appears when you change the shooting mode or set a shooting function, Live View shooting, movie shooting, or Quick Control for playback, and displays a brief description of that mode, function or option. It also displays a description when you select a function or option on the Quick Control screen. The Feature guide turns off when you further proceed with any operation.

● Shooting mode (Sample)

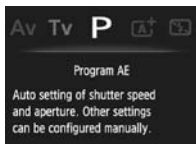
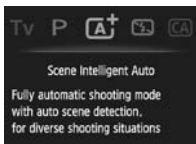

● Quick Control (Sample)



Shooting settings



Live View shooting

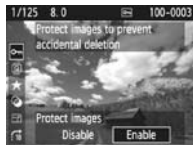

Playback

MENU Disabling the Feature Guide



Select [Feature guide].

- Under the [F2] tab, select [Feature guide], then press <SET>.
- Select [Disable], then press <SET>.



2

Basic Shooting and Image Playback

This chapter explains how to use the Basic Zone modes on the Mode Dial for best results and how to play back images.

With Basic Zone modes, all you do is point and shoot while the camera sets everything automatically (p.64). Also, to prevent botched pictures due to mistaken operations, advanced shooting function settings cannot be changed.

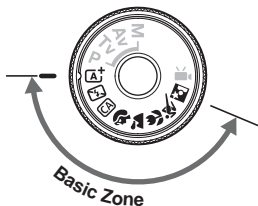

Auto Lighting Optimizer

In Basic Zone modes, the Auto Lighting Optimizer will adjust the image automatically to obtain the optimum brightness and contrast. It is also enabled by default in Creative Zone modes.

[A⁺] Fully Automatic Shooting (Scene Intelligent Auto) ■

<[A⁺> is a fully automatic mode. The camera analyzes the scene and sets the optimum settings automatically. It also adjusts focus automatically by detecting whether the subject is still or moving (p.51).



1 Set the Mode Dial to <[A⁺>.

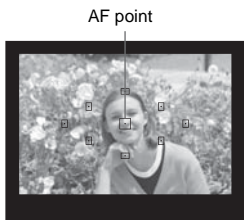

2 Aim any AF point over the subject.

- All the AF points will be used to focus, and generally the closest object will be focused.
- Aiming the center AF point over the subject will make focusing easier.

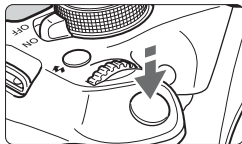

3 Focus on the subject.

- Press the shutter button halfway, and the lens's focusing ring will rotate to focus.
- ▶ The dot inside the AF point achieving focus flashes briefly in red. At the same time, the beeper will sound and the focus confirmation light **<●>** in the viewfinder will light up.
- ▶ If necessary, the built-in flash will be raised automatically.



Focus confirmation light



4 Take the picture.

- Press the shutter button completely to take the picture.
- ▶ The captured image will be displayed for 2 sec. on the LCD monitor.
- After you finish shooting, push down the built-in flash with your fingers.



The **<A+>** mode makes the colors look more impressive in nature, outdoor, and sunset scenes. If the desired color tone is not obtained, use a Creative Zone mode and select a Picture Style other than **<Picture A>** and shoot.



FAQ

- **The focus confirmation light **<●>** blinks and focus is not achieved.**

Aim the AF point over an area with good contrast, then press the shutter button halfway (p.37). If you are too close to the subject, move away and try again.

- **Multiple AF points flash simultaneously.**

This indicates that focus is achieved at all those AF points. When the AF point covering the desired subject flashes, take the picture.

- **The beeper continues to beep softly. (The focus confirmation light **<●>** does not light up.)**

It indicates that the camera is focusing continuously on a moving subject. (The focus confirmation light **<●>** does not light up.) You can take sharp pictures of a moving subject.

Note that focus lock (p.51) will not work in this case.

- **Pressing the shutter button halfway does not focus on the subject.**

If the focus mode switch on the lens is set to **<MF>** (manual focus), set it to **<AF>** (autofocus).

- **The flash fired even though it was daylight.**

For a backlit subject, the flash may fire to help lighten the subject's dark areas. If you do not want the flash to fire, use the Flash off mode (p.53). Other than the flash setting, the camera will shoot with the same settings as with **A⁺**.

- **The flash fired and the picture came out extremely bright.**

Move further away from the subject and shoot. When shooting flash photography, if the subject is too close to the camera, the picture may come out extremely bright (overexposure).

- **In low light, the built-in flash fired a series of flashes.**

Pressing the shutter button halfway may trigger the built-in flash to fire a series of flashes to assist autofocusing. This is called AF-assist beam. Its effective range is approx. 4 meters/13.1 feet.

- **When flash was used, the bottom part of the picture came out unnaturally dark.**

The shadow of the lens barrel was captured in the picture because the subject was too close to the camera. Move further away from the subject and shoot. If a hood is attached to the lens, remove it before taking the flash picture.

[A]⁺ Full Auto Techniques (Scene Intelligent Auto) ■

Recomposing the Shot



Depending on the scene, position the subject toward the left or right to create a balanced background and good perspective.

In the <[A]⁺> mode, while you press the shutter button halfway to focus on a still subject, the focus will be locked. You can then recompose the shot and press the shutter button completely to take the picture. This is called “focus lock”. Focus lock is also possible in other Basic Zone modes (except <[S]>).

Shooting a Moving Subject



In the <[A]⁺> mode, if the subject moves (distance to camera changes) while or after you focus, AI Servo AF will take effect to focus on the subject continuously. (The beeper will continue beeping softly.) As long as you keep aiming the AF point on the subject while pressing the shutter button halfway, the focusing will be continuous. When you want to take the picture, press the shutter button completely.

Live View Shooting

You can shoot while viewing the image on the LCD monitor. This is called “Live View shooting”. For details, see page 67.



1 Display the Live View image on the LCD monitor.

- Press the  button.
- ▶ The Live View image will appear on the LCD monitor.



2 Focus on the subject.

- Aim the center AF point  on the subject.
- Press the shutter button halfway to focus.
- ▶ When focus is achieved, the AF point will turn green and the beeper will sound.
- ▶ If necessary, the built-in flash will be raised automatically.

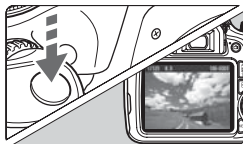

3 Take the picture.

- Press the shutter button completely.
- ▶ The picture will be taken and the captured image is displayed on the LCD monitor.
- ▶ After the image review ends, the camera will return to Live View shooting automatically.
- Press the  button to end the Live View shooting.

Disabling Flash

The camera analyzes the scene and sets the optimum settings automatically. In places where flash photography is prohibited such as in a museum or an aquarium, use the <> (Flash Off) mode. This mode is also effective for capturing the particular ambience of a scene, such as candlelight scenes.

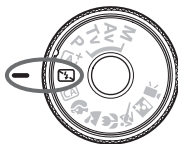

Shooting Tips

- **Prevent camera shake if the numeric display in the viewfinder blinks.**

Under low light when camera shake is prone to occur, the viewfinder's shutter speed display will blink. Hold the camera steady or use a tripod. When using a zoom lens, use the wide-angle end to reduce blur caused by camera shake even while handholding the camera.

- **Take portraits without flash.**

In low-light conditions, tell the subject to keep still until the picture is taken. Any movement by the subject during shooting may result in the subject being blurred in the picture.

CA Creative Auto Shooting

In the <CA> mode, you can easily change the depth of field, drive/self-timer, and flash firing. You can also choose the ambience you want to convey in your images. The default settings are the same as the <A+> mode.

* CA stands for Creative Auto.



1 Set the Mode Dial to <CA>.

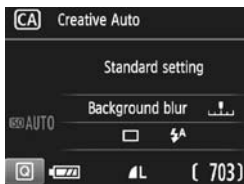

2 Press the <Q> button. (10)

▶ The Quick Control screen will appear.



3 Set the desired function.

- Press the <4-way> cross keys to select a function.
- ▶ The selected function and Feature guide (p.45) will appear.
- For the setting procedure and details on each function, see pages 55-56.

4 Take the picture.

- Press the shutter button completely to take the picture.

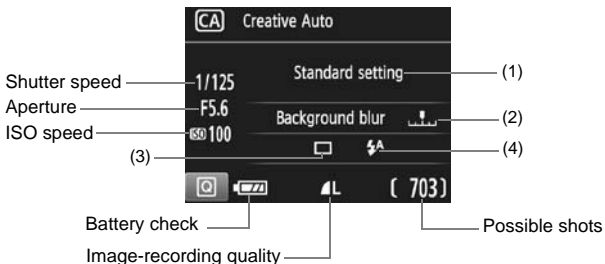

Pressing the **<Q>** button enables you to set the following:

(1) Ambience-based shots





You can set the ambience you want to convey in your images. Press the **<◀>** **<▶>** keys or turn the **<☀>** dial to select the desired ambience. You can also select it from a list by pressing **<SET>**.

(2) Blurring/sharpening the background



If you move the index mark toward the left, the background will look more blurred. If you move it toward the right, the background will look more in focus. If you want to blur the background, see “Shooting Portraits” on page 57. Press the **<◀>** **<▶>** keys or turn the **<☀>** dial to select the desired ambience.

Depending on the lens and shooting conditions, the background may not look so blurred. This function cannot be set (grayed out) if the built-in flash is raised and **<⚡>** or **<⚡>** has been selected. If flash is used, this setting will not be applied.

(3) Drive/self-timer: Press  and set it with   or the  dial.



 **Single shooting** : Shoot one image at a time.





 **Continuous shooting:**

While you hold down the shutter button completely, shots will be taken continuously. You can shoot up to approx. 3 shots per second.

 **Self-timer: 10 sec** :The picture is taken 10 seconds after you press the shutter button.

 **Self-timer: Continuous:**

Press the   keys to set the number of multiple shots (2 to 10) to be taken with the self-timer. 10 seconds after you press the shutter button, the set number of multiple shots will be taken.

(4) Flash firing: Press  and set it with   or the  dial.

 **Auto flash** : The flash fires automatically when necessary.

 **Flash on** : The flash fires at all times.

 **Flash off** : The flash is disabled.

 If you use an external Speedlite, **[Flash firing]** cannot be set.

 When using , see "Disabling Flash" on page 53.

Shooting Portraits

The <> (Portrait) mode blurs the background to make the human subject stand out. It also makes skin tones and hair look softer.

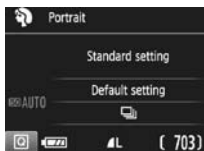

Shooting Tips

- **The further the distance between the subject and background, the better.**

The further the distance between the subject and background, the more blurred the background will look. The subject will also stand out better against an uncluttered dark background.

- **Use a telephoto lens.**
If you have a zoom lens, use the telephoto end to fill the frame with the subject from the waist up. Move in closer if necessary.
- **Focus the face.**
Check that the AF point covering the face flashes. For close-ups of the face, focus on the eyes.



- If you hold down the shutter button, you can shoot continuously to capture subtle changes in the subject's pose and facial expression (max. approx. 3 shots/sec.).
- If necessary, the built-in flash will pop up automatically.

Shooting Landscapes

Use the <> (Landscape) mode for wide scenery or to have everything in focus from near to far. For vivid blues and greens, and very sharp and crisp images.

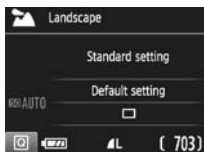
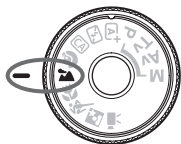

Shooting Tips

- **With a zoom lens, use the wide-angle end.**

When using the wide-angle end of a zoom lens, objects near and far will be in focus. It also adds breadth to landscapes.

- **Shooting night scenes.**

Since the built-in flash will be disabled, this mode <> is also good for night scenes.

Use a tripod to prevent camera shake.

If you want to shoot a person against a night scene, set the Mode Dial to <> (Night Portrait) and use a tripod (p.61).





The flash will not fire even in backlit or low-light conditions.

Shooting Close-ups

When you want to shoot flowers or small things up close, use the <  > (Close-up) mode. To make small things appear much larger, use a macro lens (sold separately).



Shooting Tips

- **Use a simple background.**
A simple background makes small objects such as flowers stand out better.
- **Move as close as possible to the subject.**
Check the lens for its minimum focusing distance. Some lenses have indications such as <  0.25m/0.8ft > on them. The lens minimum focusing distance is measured from the <  > (focal plane) mark on the top of the camera to the subject. If you are too close to the subject, the focus confirmation light <  > will blink. If you use flash and the bottom of the picture looks unusually dark, move away from the subject.
- **With a zoom lens, use the telephoto end.**
If you have a zoom lens, using the telephoto end will make the subject look larger.

Shooting Moving Subjects

Use the  (Sports) mode to shoot a moving subject, such as a running person or a moving vehicle.

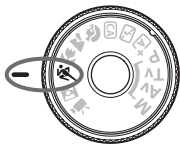

Shooting Tips

- **Use a telephoto lens.**

The use of a telephoto lens is recommended for shooting from a distance.

- **Use the center AF point to focus.**

Aim the center AF point over the subject, then press the shutter button halfway to autofocus. During autofocusing, the beeper will continue beeping softly. If focus cannot be achieved, the focus confirmation light  will blink.

When you want to take the picture, press the shutter button completely. If you hold down the shutter button, you will be able to maintain autofocusing during continuous shooting of the subject's movement (max. approx. 3 shots per sec.).



 Under low light when camera shake is prone to occur, the viewfinder's shutter speed display on the bottom left will blink. Hold the camera steady and shoot.

Shooting Night Portraits

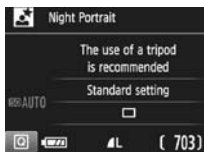
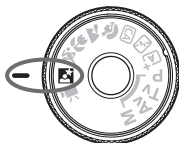
To shoot people at night and obtain a natural-looking night scene in the background, use the  (Night Portrait) mode. Using a tripod is recommended.



Shooting Tips

- **Use a wide-angle lens and a tripod.**
When using a zoom lens, use the wide-angle end to obtain a wide night view. Also, use a tripod to prevent camera shake.
- **Check the subject's brightness.**
Under low light, the built-in flash will fire automatically to obtain a good exposure of the subject.
It is recommended that you play back the image after the shooting to check the image brightness. If the subject looks dark, move nearer and shoot again.
- **Also shoot with the  (Scene Intelligent Auto) mode.**
Since camera shake is prone to occur with night shots, shooting also in the  mode is recommended.

 During Live View shooting, it may be difficult to focus on dots of light such as in a night scene. In such a case, it is recommended that you set the AF method to [**Quick mode**] and shoot. If it is still difficult to focus, set the lens's focus mode switch to <**MF**> and focus manually.

- 
- Tell the subject to keep still even after the flash fires.
 - If you use the self-timer together with flash, the self-timer lamp will light up briefly after the picture is taken.

Q Quick Control

In Basic Zone modes when the shooting function settings screen is displayed, you can press the <Q> button to display the Quick Control screen. The table on the next page shows the functions that can be set with the Quick Control screen in each Basic Zone mode.

1 Set the Mode Dial to a Basic Zone mode.

Example: Portrait mode

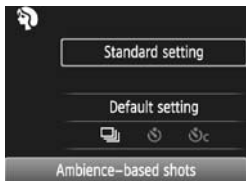

2 Press the <Q> button. (10)

▶ The Quick Control screen will appear.





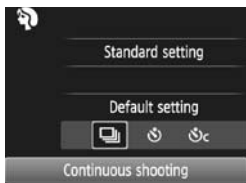









3 Set the functions.

- Press the <▲> <▼> keys to select a function. (This step is not necessary in the A^+ / M mode.)
- ▶ The selected function and Feature guide (p.45) will appear.
- Press the <◀> <▶> keys or turn the <☺> dial to change the setting.



Settable Functions in Basic Zone Modes

●: Set automatically ○: User selectable □: Not selectable

Function		 (p.48)	 (p.53)	 (p.54)	 (p.57)	 (p.58)	 (p.59)	 (p.60)	 (p.61)
Drive mode	 : Single shooting	○	○	○	□	○	○	□	○
	 : Continuous shooting	□	□	○	○	□	□	○	□
	Self-timer	 : 10 sec.	○	○	○	○	○	○	○
 : Continuous shooting*		○	○	○	○	○	○	○	○
Flash firing	 : Automatic firing	●	□	●	●	□	●	□	●
	 : Flash on (Fires at all times)	□	□	○	□	□	□	□	□
	 : Flash off	□	●	○	□	●	□	●	□
Ambience-based shots		□	□	○	○	○	○	○	○
Light/scene-based shots		□	□	□	○	○	○	○	□
Blurring/sharpening the background (p.55)		□	□	○	□	□	□	□	□

* Use the <▲> <▼> keys to set the number of continuous shots.

 If you change the shooting mode or set the power switch to <OFF>, the camera will revert to the default settings (except the self-timer).

▶ Image Playback

The easiest way to play back images is explained below.



1 Play back the image.

- Press the <▶> button.
- ▶ The last captured image or last image played back will appear.



2 Select an image.

- To view images starting with the last captured image, press the <◀> key.
- To view images starting with the first (oldest) image, press the <▶> key.
- Each time you press the <DISP.> button, the display format will change.



With basic information



Basic information +
Image quality/Playback number



Histogram

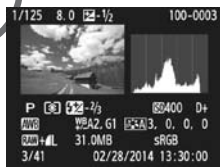

Shooting information display

3 Exit the image playback.

- Press the <▶> button to exit the image playback and return to the shooting settings display.



3

Shooting with the LCD Monitor (Live View Shooting)

You can shoot while viewing the picture on the camera's LCD monitor. This is called "Live View shooting".

Live View shooting is effective for still subjects which do not move.

If you handhold the camera and shoot while viewing the LCD monitor, camera shake can cause blurred images. Using a tripod is recommended.



Remote Live View Shooting

With EOS Utility (EOS software, p.94) installed on your computer, you can connect the camera to the computer and shoot remotely while viewing the computer screen. For details, refer to the EOS Utility Instruction Manual (p.97).

Shooting with the LCD Monitor



1 Display the Live View image.

- Press the  button.
- ▶ The Live View image will appear on the LCD monitor.
- The Live View image will closely reflect the brightness level of the actual image you capture.



2 Focus on the subject.

- When you press the shutter button halfway, the camera will focus with the current AF method (p.71).

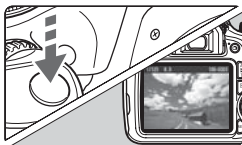

3 Take the picture.

- Press the shutter button completely.
- ▶ The picture will be taken and the captured image will be displayed on the LCD monitor.
- ▶ After the image review ends, the camera will return to Live View shooting automatically.
- Press the  button to exit the Live View shooting.

Enabling Live View Shooting

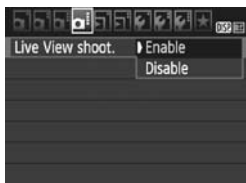

Set [**Live View shoot.**] to [**Enable**]. In Basic Zone modes, the Live View menu options will be displayed under [**2**], and in Creative Zone modes, they will be displayed under [**4**].

Number of Possible Shots with Live View Shooting

(Approx. number of shots)

Temperature	Shooting Conditions	
	No Flash	50% Flash Use
Room temperature (23°C / 73°F)	190	180
Low temperatures (0°C / 32°F)	180	170

- The figures above are based on a fully-charged Battery Pack LP-E10 and CIPA (Camera & Imaging Products Association) testing standards.
- With a fully-charged Battery Pack LP-E10, continuous Live View shooting is possible for approx. 1 hr. 25 min. at room temperature (23°C / 73°F).

Do not hold the camera in the same position for long periods of time. Even if the camera does not feel too hot, prolonged contact with the same body part may cause skin redness, blistering or low-temperature contact burns. The use of a tripod is recommended for people with circulation problems or very sensitive skin, or when using the camera in very hot places.

Information Display

- Each time you press the <DISP.> button, the information display will change.

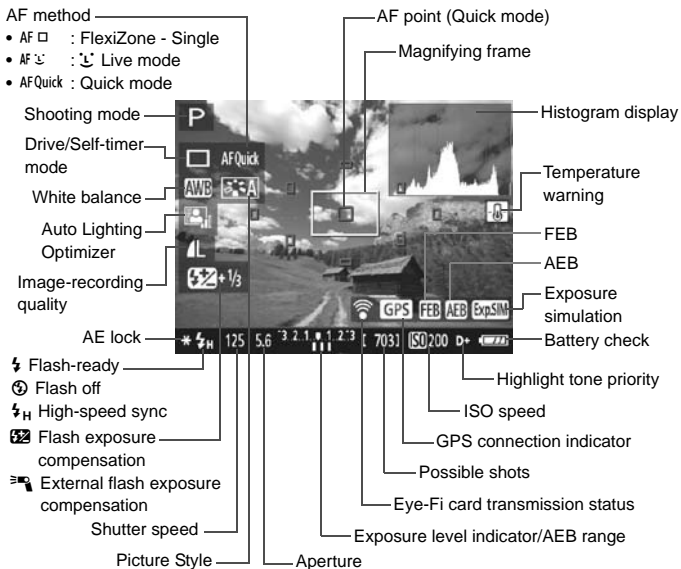

Using AF to Focus (AF Method)

Selecting the AF Method

You can select an AF method to suit the shooting conditions and your subject. The following AF methods are provided: [**FlexiZone - Single**], [**Live mode**] (face detection, p.72), and [**Quick mode**] (p.74).

If you want to achieve precise focus, set the lens's focus mode switch to <MF>, magnify the image, and focus manually.

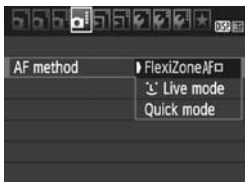

Select the AF method.

- Under the [**4**] tab, select [**AF method**]. (In Basic Zone modes, it is under the [**2**] tab.)
- Select the desired AF method, then press <SET>.
- While the Live View image is displayed, you can press the <Q> button to select the AF method on the Quick Control screen.

FlexiZone - Single: AF □

The image sensor is used to focus. Although AF is possible with the Live View image displayed, **the AF operation will take longer than with the Quick mode**. Also, achieving focus may be more difficult than with the Quick mode.



AF point

1 Display the Live View image.

- Press the <LIVE VIEW> button.
- ▶ The Live View image will appear on the LCD monitor.
- ▶ The AF point <□> will appear.

2 Move the AF point.

- Press the <DIRECTIONAL KEYS> cross keys to move the AF point to where you want to focus. (It cannot go to the edges of the picture.)
- Press <SET> to return the AF point to the center. (If C.Fn-9 is set, hold down the <AV/DELETE> button and press <SET>.)

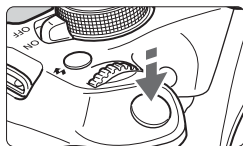

3 Focus on the subject.

- Aim the AF point over the subject and press the shutter button halfway.
- ▶ When focus is achieved, the AF point will turn green and the beeper will sound.
- ▶ If focus is not achieved, the AF point will turn orange.



4 Take the picture.

- Check the focus and exposure, then press the shutter button completely to take the picture (p.68).

☺ (Face detection) Live Mode: AF ☺

Human faces are detected and focused with the same AF method as [FlexiZone - Single]. Have the person whose picture you want to take face the camera.



1 Display the Live View image.

- Press the <☑> button.
- ▶ The Live View image will appear on the LCD monitor.

2 Select an AF point.

- When a face is detected, the <☑> frame will appear over the face to be focused.
- If multiple faces are detected, <☑> will be displayed. Use the <◀> <▶> keys to move the <☑> frame over the face you want to focus.

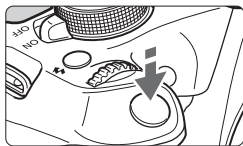

3 Focus on the subject.

- Press the shutter button halfway and the camera will focus on the face covered by the <[]> frame.
- ▶ When focus is achieved, the AF point will turn green and the beeper will sound.
- ▶ If focus is not achieved, the AF point will turn orange.
- If a face cannot be detected, the AF point <[]> will be displayed and AF will be executed at the center.



4 Take the picture.

- Check the focus and exposure, then press the shutter button completely to take the picture (p.68).

Quick Mode: AFQuick

The dedicated AF sensor is used to focus in One-Shot AF, using the same AF method as with viewfinder shooting.



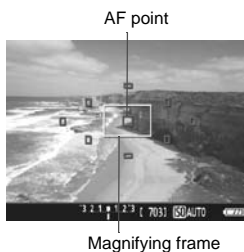

Although you can focus on the target subject quickly, **the Live View image will be interrupted momentarily during the AF operation.**

You can use nine AF points to focus (automatic selection). You can also select one AF point to focus and focus only the area covered by that AF point (manual selection).

**1 Display the Live View image.**

- Press the <  > button.
- ▶ The Live View image will appear on the LCD monitor.
- The small boxes on the screen are the AF points, and the larger box is the magnifying frame.

**2 Select the AF point. ☆**

- Press the <  > button ( 10) to display the Quick Control screen.
- ▶ The settable functions will be displayed on the left of the screen.
- Press the <  > <  > keys to make the AF point selectable.
- Turn the <  > dial to select the AF point.



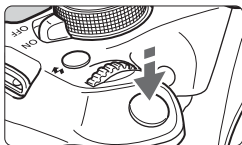

3 Focus on the subject.

- Aim the AF point over the subject and press the shutter button halfway.
- ▶ The Live View image will turn off, the reflex mirror will go back down, and AF will be executed. (No picture is taken.)
- ▶ When focus is achieved, the AF point that achieved focus will turn green and the Live View image will reappear.
- ▶ If focus is not achieved, the AF point will turn orange and blink.



4 Take the picture.

- Check the focus and exposure, then press the shutter button completely to take the picture (p.68).





4

Shooting Movies

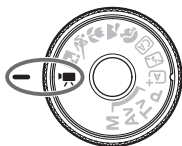

Movie shooting is enabled by setting the Mode Dial to . The movie recording format will be MOV.

- For cards that can record movies, see page 5.



Full HD 1080

Full HD 1080 indicates compatibility with High-Definition featuring 1080 vertical pixels (scanning lines).



Shooting Movies

Connecting the camera to a TV set is recommended to play back the movies shot.

Autoexposure Shooting



1 Set the Mode Dial to <Movie>.

- ▶ The reflex mirror will make a sound, then the image will appear on the LCD monitor.

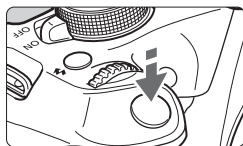

2 Focus on the subject.

- Before shooting a movie, focus with AF or manual focus (p.71-75).
- When you press the shutter button halfway, the camera will focus with the current AF method.



3 Shoot the movie.

- Press the <Movie> button to start shooting a movie. To stop movie shooting, press <Movie> again.
- ▶ While the movie is being shot, the “●” mark will be displayed on the upper right of the screen.

Recording movie



Microphone

Do not hold the camera in the same position for long periods of time.

Even if the camera does not feel too hot, prolonged contact with the same body part may cause skin redness, blistering or low-temperature contact burns. The use of a tripod is recommended for people with circulation problems or very sensitive skin, or when using the camera in very hot places.

Information Display

- Each time you press the <DISP.> button, the information display will change.

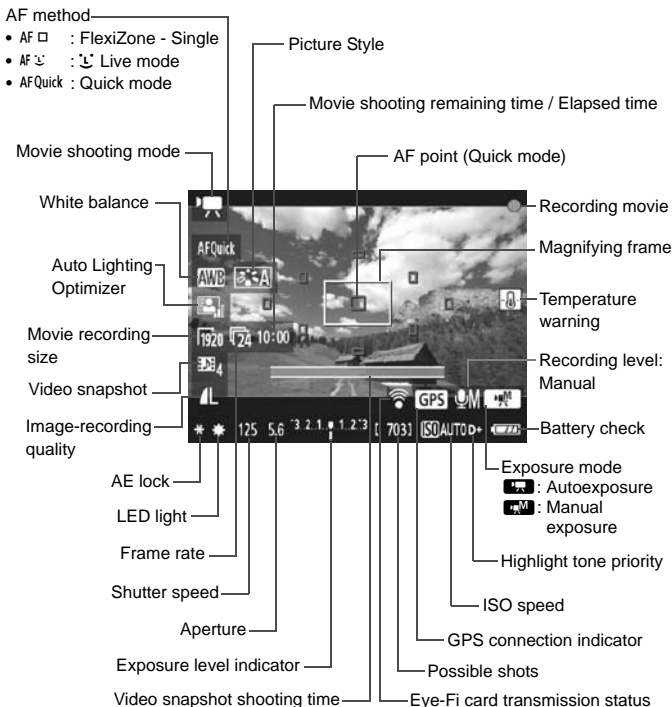

MENU Setting the Movie Recording Size

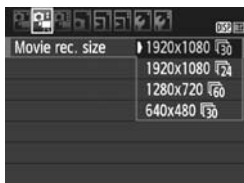

The menu option [**2: Movie rec. size**] enables you to select the movie's image size [****x****] and frame rate [**] (frames recorded per second). The [**] (frame rate) switches automatically depending on the [**2: Video system**] setting.







● Image Size

- [**1920x1080**] (**1920**) : Full High-Definition (Full HD) recording quality. The aspect ratio will be 16:9.
- [**1280x720**] (**1280**) : High-Definition (HD) recording quality. The aspect ratio will be 16:9.
- [**640x480**] (**640**) : Standard-definition recording quality. The aspect ratio will be 4:3.

● Frame Rate (fps: frames per second)

- 30/60** : For areas where the TV format is NTSC (North America, Japan, Korea, Mexico, etc.).
- 25/50** : For areas where the TV format is PAL (Europe, Russia, China, Australia, etc.).
- 24** : Mainly for motion pictures.

Total Movie Recording Time and File Size Per Minute

Movie Recording Size		Total Recording Time (approx.)			File Size (approx.)
		4 GB Card	8 GB Card	16 GB Card	
[1920x1080]		11 min.	22 min.	44 min.	330 MB/min.
					
					
[1280x720]		11 min.	22 min.	44 min.	330 MB/min.
					
[640x480]		46 min.	1 hr. 32 min.	3 hr. 4 min.	82.5 MB/min.
					

- **Movie Files Exceeding 4 GB**

Due to the file system, movie shooting will stop automatically if the file size of a single movie clip reaches 4 GB. You can start shooting a movie again by pressing the  button. (A new movie file starts being recorded.)

- **Movie Shooting Time Limit**

The maximum recording time of one movie clip is 29 min. 59 sec. If the movie shooting time reaches 29 min. 59 sec., the movie shooting will stop automatically. You can start shooting a movie again by pressing the  button. (A new movie file starts being recorded.)



An increase of the camera's internal temperature may cause movie shooting to stop before the maximum recording time shown in the table above.



5

Image Playback

This chapter explains basic procedures to play back images and movies.

Images shot and saved with another device

The camera may not be able to properly display images captured with a different camera, edited with a computer, or that have had their file names changed.

▶ Searching for Images Quickly

▣ Display Multiple Images on One Screen (Index Display)

Search for images quickly with the index display showing four or nine images on one screen.



1 Play back the image.

- When you press the <▶> button, the last image captured will be displayed.



2 Switch to the index display.

- Press the <DISP Q> button.
- ▶ The 4-image index display will appear. The selected image is highlighted in an orange frame.
- Press the <DISP Q> button again to switch to the 9-image display.
- Pressing the <Q> button will switch the display between nine images, four images and one image displayed.

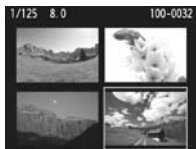

3 Select an image.



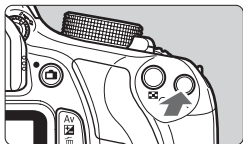

- Press the <⬆> cross keys to move the orange frame to select an image.
- Turning the <◀▶> dial will display image(s) on the next or previous screen.
- Press <SET> in the index display to display the selected image as a single image.

/ **Magnified View**

You can magnify a captured image by approx. 1.5x to 10x on the LCD monitor.



1 **Magnify the image.**



- Press the  button during image playback.
- ▶ The image will be magnified.
- If you hold down the  button, the image will be magnified until it reaches the maximum magnification.
- Press the   button to reduce the magnification. If you hold down the button, the magnification will be reduced to the single-image display.

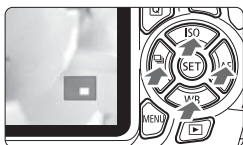

Magnified area position



2 **Scroll around the image.**

- Use the  cross keys to scroll around the magnified image.
- To exit magnified view, press the  button and the single-image display will reappear.



- In magnified view, you can turn the  dial to view another image at the same magnification.
- The image cannot be magnified during the image review immediately after shooting.
- A movie cannot be magnified.

▶ Playing Movies



1 Play back the image.

- Press the <▶> button to display an image.



2 Select a movie.

- Press the <◀> <▶> keys to select a movie.
- In the single-image display, the <▶ SET> icon displayed on the upper left of the screen indicates a movie. If the movie is a video snapshot, [▶ SET] will be displayed.
- In the index display, perforations at the left edge of a thumbnail indicate a movie. **As movies cannot be played from the index display, press <SET> to switch to the single-image display.**



3 In the single-image display, press <SET>.

- ▶ The movie playback panel will appear at the bottom of the screen.









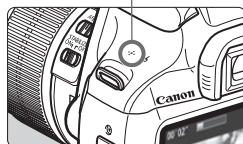



4 Play back the movie.

- Select [▶] (Play), then press <SET>.
- ▶ The movie will start playing.
- You can pause the movie playback by pressing <SET>.
- You can adjust the sound volume by turning the <◀ VOLUME ▶> dial even during movie playback.
- For more details on the playback procedure, see the next page.

Speaker



Movie Playback Panel

Operation	Playback Description
 Exit	Returns to the single-image display.
 Play	Pressing <ⓈET> toggles between play and stop.
 Slow motion	Adjust the slow motion speed by pressing the <◀> <▶> keys. The slow-motion speed is indicated at the upper right of the screen.
 First frame	Displays the movie's first frame.
 Previous frame	Each time you press <ⓈET>, the previous frame is displayed. If you hold down <ⓈET>, it will rewind the movie.
 Next frame	Each time you press <ⓈET>, the movie will play frame-by-frame. If you hold down <ⓈET>, it will fast forward the movie.
 Last frame	Displays the movie's last frame.
 Edit	Displays the editing screen.
 Background music*	Plays back a movie with the selected background music.
	Playback position
mm' ss"	Playback time (minutes:seconds)
 Volume	You can adjust the built-in speaker's (p.86) volume by turning the <🔊> dial.

* When background music is set, the movie's sound will not be played.

Erasing Images

You can either select and erase unnecessary images one by one or erase them in one batch. Protected images will not be erased.

- ⓘ **Once an image is erased, it cannot be recovered. Make sure you no longer need the image before erasing it. To prevent important images from being erased accidentally, protect them. Erasing a **RAW** + **L** image will erase both the RAW and JPEG images.**

Erasing a Single Image



1 Play back the image to be erased.

2 Press the  button.

- ▶ The Erase menu will appear at the bottom of the screen.



3 Erase the image.

- Select [**Erase**], then press . The image displayed will be erased.

6

Viewing the CD-ROM Instruction Manuals / Downloading Images to Your Computer

This chapter explains how to view the Camera Instruction Manual CD-ROM on your computer, download images from the camera to your computer, gives an overview of the software in the EOS DIGITAL Solution Disk (CD-ROM), and explains how to install the software on your computer. It also explains how to view the software instruction manuals.



**Camera Instruction
Manual**



EOS DIGITAL Solution Disk
(Software/Software Instruction Manuals)

Viewing the Camera Instruction Manual CD-ROM



The Camera Instruction Manual CD-ROM contains the following instruction manuals (PDF):

- **Camera Instruction Manual**

Explains all of the camera's functions and operation procedures, including basic content.

- **Quick Reference Guide**

Explains basic camera functions and procedures for shooting and playback.

Viewing the Camera Instruction Manual on the CD-ROM

To view the instruction manuals (PDF files), Adobe Reader 6.0 or higher must be installed in your computer. Adobe Reader can be downloaded free from the Internet. After installing Adobe Reader, follow the procedure below.

- 1 Insert the “CAMERA INSTRUCTION MANUAL” CD-ROM into your computer.**

- 2 Double-click the CD-ROM icon.**



- For Windows, the icon is displayed in [(My) Computer].
- For Macintosh, the icon is displayed on the desktop.
- The icon displayed will differ depending on your computer's operating system.



3 Double-click the **START** file.

- ▶ The screen shown in step 4 will appear.
- The icon displayed will differ depending on your computer's operating system.

4 Click on the manual you want to view.

- Click on the name of the manual under your respective language.

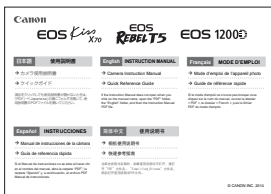

- ▶ The manual will be displayed.



- You can save the PDF file to your computer.
- All the instruction manuals (PDF files) have page links to make it quick to open the page desired. Click on a page number in the Table of Contents or Index and that page will appear.
- To learn how to use Adobe Reader, refer to Adobe Reader's Help section.

Downloading Images to a Computer

You can use the EOS software to download the images in the camera to your computer. There are two ways to do this.

Downloading by Connecting the Camera to the Computer

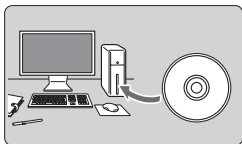

1 Install the software (p.96).

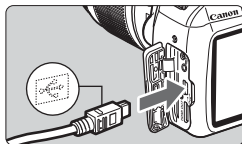

2 Use the provided interface cable to connect the camera to your computer.

- Use the interface cable provided with the camera.
- Connect the cable to the camera's digital terminal with the cable plug's icon facing the front of the camera.
- Connect the cord's plug to the computer's USB terminal.

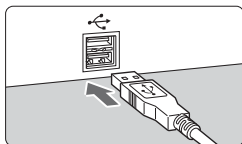

3 Use EOS Utility to download the images.

- For details, refer to the EOS Utility Instruction Manual (p.97).

Downloading Images with a Card Reader

You can also use a card reader to download images to your computer.

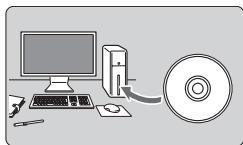

1 Install the software (p.96).

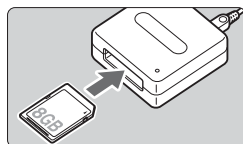

2 Insert the card into the card reader.

3 Use Canon software to download the images.

- ▶ Use Digital Photo Professional.
- ▶ Use ImageBrowser EX.
- For details, refer to the Software Instruction Manual (p.97).



When downloading images from the camera to your computer using a card reader without using EOS software, copy the DCIM folder on the card to your computer.

Software Overview



EOS DIGITAL Solution Disk

Various software for EOS DIGITAL cameras are contained on the EOS DIGITAL Solution Disk.

EOS Utility

With the camera connected to a computer, EOS Utility enables you to transfer still photos and movies shot with the camera to the computer. You can use this software to set various camera settings and shoot remotely with the computer connected to the camera. Also, you can copy background music tracks, such as EOS Sample Music*, to the card.

* You can use the background music as the soundtrack for a video snapshot album, movie, or slide show played back with your camera.

Digital Photo Professional

This software is recommended for users who mainly shoot RAW images. You can quickly view, edit, process and print RAW images. You can also edit JPEG images while retaining the original images.

Picture Style Editor

You can edit Picture Styles and create and save original Picture Style files. This software is aimed at advanced users who are experienced in processing images.

ImageBrowser EX

Connect to the Internet to download and install the software*.

This software is recommended for users who mainly shoot JPEG images. You can easily view and play back still photos, MOV movies, and video snapshot albums and also print JPEG images.

* EOS DIGITAL Solution Disk is necessary for downloading and installing ImageBrowser EX.

 Note that the software ZoomBrowser EX/ImageBrowser provided with previous cameras does not support still photos and movie files shot with this camera (it is not compatible). Use ImageBrowser EX.

Installing the Software

- **Do not connect the camera to your computer before you install the software. The software will not be installed correctly.**
- When downloading and installing ImageBrowser EX, follow the steps below as with other EOS software included on the EOS DIGITAL Solution Disk. Note that Internet connection is necessary. Downloading or installing software is not possible in environments with no Internet connection.
- Even if your computer already has ImageBrowser EX installed, follow the steps below to reinstall ImageBrowser EX. It will be updated to the latest version with features optimized for your camera. Also, the latest functions may be added with the auto update feature.
- For software other than ImageBrowser EX, if a previous version is installed, follow the steps below to reinstall the software. (The newer version will overwrite the previous version.)

1 Insert the EOS DIGITAL Solution Disk into your computer.

- For Macintosh, double-click to open the CD-ROM icon displayed on the desktop, then double-click on [setup].

2 Click [Easy Installation] and follow the on-screen instructions to install.

- If the “Microsoft Silverlight” installation prompt is displayed during installation, install “Microsoft Silverlight”.

3 Click [Restart] and remove the CD-ROM after the computer restarts.

- When the computer has restarted, the installation is complete.

Software Instruction Manual



Software Instruction Manuals are contained on the EOS DIGITAL Solution Disk. You can copy and view the software instruction manual (PDF files) as follows:

1 Insert the EOS DIGITAL Solution Disk into your computer.

2 Close the install screen.

- When the EOS DIGITAL Solution Disk install screen appears, close the install screen.

3 Open the CD-ROM.

4 Open the [Manual] folder.

5 Copy the [English] folder to your computer.

- Instruction Manual PDFs with the names below are copied.

	Windows	Macintosh
EOS Utility	EUx.xW_E_xx	EUx.xM_E_xx
Digital Photo Professional	DPPx.xW_E_xx	DPPx.xM_E_xx
Picture Style Editor	PSEx.xW_E_xx	PSEx.xM_E_xx

- Instruction manual for ImageBrowser EX (ImageBrowser EX User Guide) is included in the software.

6 Double-click the copied PDF file.

- Adobe Reader (most recent version recommended) must be installed on your computer.
- Adobe Reader can be downloaded free from the Internet.

Trademarks

- Adobe is a trademark of Adobe Systems Incorporated.
- Microsoft and Windows are trademarks or registered trademarks of Microsoft Corporation in the United States and/or other countries.
- Macintosh and Mac OS are trademarks of Apple Inc., registered in the U.S. and other countries.
- SDXC logo is a trademark of SD-3C, LLC.
- HDMI, HDMI logo, and High-Definition Multimedia Interface are trademarks or registered trademarks of HDMI Licensing LLC.
- All other trademarks are the property of their respective owners.

About MPEG-4 Licensing

"This product is licensed under AT&T patents for the MPEG-4 standard and may be used for encoding MPEG-4 compliant video and/or decoding MPEG-4 compliant video that was encoded only (1) for a personal and non-commercial purpose or (2) by a video provider licensed under the AT&T patents to provide MPEG-4 compliant video. No license is granted or implied for any other use for MPEG-4 standard."

* Notice displayed in English as required.



Certification Logo

Under the [**F3**] tab, if you select [**Certification Logo Display**] and press <[SET]>, some of the logos of the camera's certifications will appear. Other certification logos can be found in this Instruction Manual, on the camera body, and on the camera's package.

Use of genuine Canon accessories is recommended

This product is designed to achieve excellent performance when used with genuine Canon accessories.

Canon shall not be liable for any damage to this product and/or accidents such as fire, etc., caused by the malfunction of non-genuine Canon accessories (e.g., a leakage and/or explosion of a battery pack). Please note that this warranty does not apply to repairs arising out of the malfunction of non-genuine Canon accessories, although you may request such repairs on a chargeable basis.

Safety Precautions

The following precautions are provided to prevent harm or injury to yourself and others. Make sure to thoroughly understand and follow these precautions before using the product.

If you experience any malfunctions, problems, or damage to the product, contact the nearest Canon Service Center or the dealer from whom you purchased the product.



Warnings: Follow the warnings below. Otherwise, death or serious injuries may result.

- To prevent fire, excessive heat, chemical leakage, explosions, and electrical shock, follow the safeguards below:
 - Do not use any batteries, power sources, or accessories not specified in the Instruction Manual. Do not use any home-made or modified batteries.
 - Do not short-circuit, disassemble, or modify the battery. Do not apply heat or solder to the battery. Do not expose the battery to fire or water. Do not subject the battery to strong physical shock.
 - Do not insert the battery's plus and minus ends incorrectly.
 - Do not recharge the battery in temperatures outside the allowable ambient temperature range. Also, do not exceed the recharging time indicated in the Instruction Manual.
 - Do not insert any foreign metallic objects into the electrical contacts of the camera, accessories, connecting cables, etc.
- When disposing of a battery, insulate the electrical contacts with tape to prevent contact with other metallic objects or batteries. This is to prevent a fire or an explosion.
- If excessive heat, smoke, or fumes are emitted when recharging the battery, immediately unplug the battery charger from the power outlet to stop recharging. Otherwise, it may cause a fire, heat damage or electrical shock.
- If the battery leaks, changes color, deforms, or emits smoke or fumes, remove it immediately. Be careful not to get burned in the process. It may cause a fire, electrical shock or skin burn if you keep using it.
- Prevent any battery leakage from contacting your eyes, skin, and clothing. It can cause blindness or skin problems. If the battery leakage contacts your eyes, skin, or clothing, flush the affected area with lots of clean water without rubbing it. See a physician immediately.
- Do not leave any cords near a heat source. It can deform the cord or melt the insulation and cause a fire or electrical shock.
- Do not hold the camera in the same position for long periods of time. Even if the camera does not feel too hot, prolonged contact with the same body part may cause skin redness, blistering or low-temperature contact burns. Using a tripod is recommended for people with circulation problems or very sensitive skin, or when using the camera in very hot places.
- Do not fire the flash at anyone driving a car or other vehicle. It may cause an accident.
- Do not fire the flash near a person's eyes. It may impair the person's vision. When using flash to photograph an infant, keep at least 1 meter/3.3 feet away.

- When the camera or accessories are not in use, make sure to remove the battery and disconnect the power plug from the equipment before storing. This is to prevent electrical shock, excessive heat, fire, or corrosion.
- Do not use the equipment where there is flammable gas. This is to prevent an explosion or a fire.
- If you drop the equipment and the casing breaks open to expose the internal parts, do not touch the internal parts. There is a possibility of an electrical shock.
- Do not disassemble or modify the equipment. High-voltage internal parts can cause electrical shock.
- Do not look at the sun or an extremely bright light source through the camera or lens. Doing so may damage your vision.
- Keep equipment out of the reach of children and infants, including when in use. Straps or cords may accidentally cause choking, electrical shock, or injury. Choking or injury may also occur if a child or infant accidentally swallows a camera part or accessory. If a child or infant swallows a part or accessory, consult a physician immediately.
- Do not store the equipment in dusty or humid places. Likewise, store the battery with its protective cover attached to prevent short-circuit. This is to prevent a fire, excessive heat, electrical shock, or burn.
- Before using the camera inside an airplane or hospital, check if it is allowed. Electromagnetic waves emitted by the camera may interfere with the plane's instruments or the hospital's medical equipment.
- To prevent a fire and electrical shock, follow the safeguards below:
 - Always insert the power plug all the way in.
 - Do not handle a power plug with wet hands.
 - When unplugging a power plug, grasp and pull the plug instead of the cord.
 - Do not scratch, cut, or excessively bend the cord or put a heavy object on the cord. Also do not twist or tie the cords.
 - Do not connect too many power plugs to the same power outlet.
- Do not use a cord whose wire is broken or insulation is damaged.
- Unplug the power plug periodically and clean off the dust around the power outlet with a dry cloth. If the surrounding is dusty, humid, or oily, the dust on the power outlet may become moist and short-circuit the outlet, causing a fire.
- Do not connect the battery directly to an electrical outlet or a car's cigarette lighter outlet. The battery may leak, generate excessive heat or explode, causing a fire, burns or injuries.
- A thorough explanation of how to use the product by an adult is required when the product is used by children. Supervise children while they are using the product. Incorrect usage may result in electrical shock or injury.
- Do not leave a lens or lens-attached camera in the sun without the lens cap attached. Otherwise, the lens may concentrate the sun's rays and cause a fire.
- Do not cover or wrap the product with a cloth. Doing so may trap heat within and cause the casing to deform or catch fire.
- Be careful not to get the camera wet. If you drop the product in the water or if water or metal get inside the product, promptly remove the battery. This is to prevent a fire and an electrical shock.
- Do not use paint thinner, benzene, or other organic solvents to clean the product. Doing so may cause fire or a health hazard.



Cautions: Follow the cautions below. Otherwise physical injury or property damage may result.

- Do not use or store the product inside a car under the hot sun or near a heat source. The product may become hot and cause skin burns. Doing so may also cause battery leakage or explosion, which will degrade the performance or shorten the life of the product.
- Do not carry the camera around when it is attached to a tripod. Doing so may cause injury. Also make sure the tripod is sturdy enough to support the camera and lens.
- Do not leave the product in a low-temperature environment for an extended period of time. The product will become cold and may cause injury when touched.
- Never play the provided CD-ROM in a drive that is not compatible with the CD-ROM. If you use it in a music CD player, you may damage the speakers and other components. When using headphones, there is also a risk of injury to your ears from excessively loud volume.

Digital Camera Model DS126491 Systems

This device complies with Part 15 of the FCC Rules. Operation is subject to the following two conditions: (1) This device may not cause harmful interference, and (2) this device must accept any interference received, including interference that may cause undesired operation.

Note: This equipment has been tested and found to comply with the limits for class B digital devices, pursuant to Part 15 of the FCC Rules. These limits are designed to provide reasonable protection against harmful interference in a residential installation. This equipment generates, uses and can radiate radio frequency energy and, if not installed and used in accordance with the instructions, may cause harmful interference to radio communications. However, there is no guarantee that interference will not occur in a particular installation. If this equipment does cause harmful interference to radio or television reception, which can be determined by turning the equipment off and on, the user is encouraged to try to correct the interference by one or more of the following measures:

- Reorient or relocate the receiving antenna.
- Increase the separation between the equipment and receiver.
- Connect the equipment into an outlet on a circuit different from that to which the receiver is connected.
- Consult the dealer or an experienced radio/TV technician for help.

The cable with the ferrite core provided with the digital camera must be used with this equipment in order to comply with Class B limits in Subpart B of Part 15 of the FCC rules.

Do not make any changes or modifications to the equipment unless otherwise specified in the manual. If such changes or modifications should be made, you could be required to stop operation of the equipment.

Canon U.S.A. Inc.
One Canon Park, Melville, NY 11747, U.S.A.
Tel No. 1-800-OK-CANON (1-800-652-2666)

CAN ICES-3 (B) / NMB-3 (B)



When connecting to and using a household power outlet, use only AC Adapter Kit ACK-E10 (rated input: 100-240 V AC 50/60 Hz, rated output: 7.4 V DC). Using anything else can cause fire, overheating, or electrical shock.

IMPORTANT SAFETY INSTRUCTIONS

1. **SAVE THESE INSTRUCTIONS** — This manual contains important safety and operating instructions for Battery Charger LC-E10 & LC-E10E.
2. Before using the charger, read all instructions and cautionary remarks on (1) the charger, (2) the battery pack, and (3) the product using the battery pack.
3. **CAUTION** — To reduce risk of injury, charge only the Battery Pack LP-E10. Other types of batteries may burst, causing personal injury and other damage.
4. Do not expose the charger to rain or snow.
5. Use of an attachment not recommended or sold by Canon may result in fire, electric shock, or personal injury.
6. To reduce risk of damage to electric plug and cord, pull by plug rather than by cord when disconnecting charger.
7. Make sure cord is located so that it will not be stepped on, tripped over, or otherwise subjected to damage or stress.
8. Do not operate the charger with damaged cord or plug - replace them immediately.
9. Do not operate the charger if it has received a sharp blow, been dropped, or otherwise damaged in any way; take it to a qualified serviceman.
10. Do not disassemble the charger; take it to a qualified serviceman when service or repair is required. Incorrect reassembly may result in a risk of electric shock or fire.
11. To reduce risk of electric shock, unplug charger from outlet before attempting any maintenance or cleaning.

MAINTENANCE INSTRUCTION

Unless otherwise stated in this manual, there are no user serviceable parts inside. Refer servicing to qualified serviceman.



USA and Canada only:

The Lithium ion/polymer battery that powers the product is recyclable. Please call 1-800-8-BATTERY for information on how to recycle this battery.

For CA, USA only

Included lithium battery contains Perchlorate Material – special handling may apply. See www.dtsc.ca.gov/hazardouswaste/perchlorate/ for details.

CAUTION

RISK OF EXPLOSION IF BATTERY IS REPLACED BY AN INCORRECT TYPE.
DISPOSE OF USED BATTERIES ACCORDING TO LOCAL REGULATION.

Canon

The descriptions in this Instruction Manual are current as of October 2014. For information on the compatibility with any products introduced after this date, contact any Canon Service Center. For the latest version Instruction Manual, refer to the Canon Web site.