

Canon

FAXPHONE B640

..... **Electronic User's Manual**

How to Use this User's Guide

Before you use this *User's Guide*, read this list of symbols, terms and abbreviations to become familiar with them. A complete glossary of terms is included at the end of this guide.

- **Document**

The original sheet(s) of paper you send, receive or copy with your FAXPHONE.

- **Menu**

A list of options or features from which you select an item to set up or change.

- **Numeric buttons**

The round buttons on the operation panel with digits 0 through 9, ✕ and # on them.

- **Arrow buttons**

The buttons  used to display choices and change settings. These buttons also change the volume setting of the speaker.

- **STOP button**

Press  to cancel any operation or to cancel the selection of a menu item.

- **START/COPY button**

Press  to start an operation or register a setting.

- **Transaction number**

A number automatically assigned every time you send or receive a fax. Transaction numbers are 4-digit decimal numbers that can help you keep track of the documents you send and receive.

- **TX/RX NO. XXXX**

Represents the transaction number when displayed on the LCD, where XXXX is the 4-digit transaction number.

- **TX**

Stands for transmit or send.

- **RX**

Stands for receive.

- **NOTE**

A note describes important points and helpful hints, or how to avoid minor difficulties.



As an ENERGY STAR Partner, Canon has determined that the FAXPHONE B640 meets the ENERGY STAR guidelines for energy efficiency.

Trademarks

Canon, BJ and FAXPHONE are registered trademarks and Bubble Jet is a trademark of Canon Inc.

Copyright

This manual is copyrighted by Canon Computers Systems, Inc. (CCSI) with all rights reserved. Under the copyright laws, this manual may not be reproduced in any form, in whole or part, without the prior written consent of CCSI.

©1997 Canon Computer Systems, Inc.

Welcome

Thank you for choosing the Canon FAXPHONE® B640 Bubble Jet™ facsimile. The compact, upright design of the FAXPHONE B640 means it takes up less space in your work area. And the Bubble Jet print mechanism uses cut-sheet plain paper, so you get crisp reproductions of your fax documents and copies.

The FAXPHONE B640 has a number of features that make it ideal for small to medium-sized offices with a single telephone line.

Features

Plain paper

The FAXPHONE accepts letter, legal and A4 size cut-sheet plain paper for crisp reproduction and faxes that are flat and easy to write on.

Automatic switching between fax and voice calls

The FAXPHONE recognizes incoming fax calls, and automatically switches to receive mode.

Automatic dialing

A variety of dialing methods lets you register frequently used fax numbers and phone numbers and access them by pressing one or a few buttons.

Error Correction Mode (ECM) TX / RX

Automatically helps correct transmission errors due to system and telephone line noise.

Delayed transmission

Sends a fax automatically at a later time, for example, at night when telephone rates are lower.

Distinctive Ring Pattern Detection (DRPD)

Lets you use your telephone company's special service to have separate fax and voice numbers with different ring patterns on a single telephone line.

360 dpi copy mode

Lets you make copies at 360 × 360 dpi.

Disclaimer

Canon Computer Systems, Inc. has reviewed this manual thoroughly in order that it will be an easy to use guide to your Canon FAXPHONE B640 Bubble Jet facsimile. All statements, technical information, and recommendations in this manual and in any guides or related documents are believed reliable, but the accuracy and completeness thereof are not guaranteed or warranted, and they are not intended to be, nor should they be understood to be, representations or warranties concerning the products described.

Your FAXPHONE has been sold to you subject to the limited warranty set forth in the warranty card. Further, CCSI reserves the right to make changes in the specifications of the products described in this manual at any time without notice and without obligation to notify any person of such changes.

If you have any questions regarding your FAXPHONE or the information in this manual, please call the Canon Computer Systems Customer Care Center at 1-800-423-2366 (U.S.A.) or contact Canon Canada at 1-800-263-1121.

Users in the U.S.A.

PRE-INSTALLATION REQUIREMENTS FOR CANON FACSIMILE EQUIPMENT

A. Location

Supply a suitable table, cabinet, or desk. See Specifications (p. 103) for unit's dimensions and weight.

B. Order Information

1. Only a single line, touch tone or rotary telephone set is to be used.
2. Order an RJ11-C modular jack (USOC code), which should be installed by the phone company. If the RJ11-C jack is not present, installation cannot occur.
3. Order a normal business line from your telephone company's business representative. The line should be a regular voice grade line or equivalent. Use one line per unit.

DDD (DIRECT DISTANCE DIAL) LINE

or

IDDD (INTERNATIONAL DIRECT DISTANCE DIAL) LINE IF YOU
COMMUNICATE OVERSEAS

NOTE: Canon recommends an individual line following industry standards [e.g., the 2500 (Touch tone) or 500 (Rotary/Pulse Dial) telephones]. A dedicated extension off a PBX unit without "Call Waiting" can be used with your FAX unit. Key telephone systems are not recommended because they send non-standard signals to individual telephones for ringing and special codes, which may cause a FAX error.

C. Power Requirements

This equipment should be connected to a standard 120 volt AC, three-wire grounded outlet only. Do not connect this unit to an outlet or power line shared with other appliances that cause "electrical noise." Air conditioners, electric typewriters, copiers, and machines of this sort generate noise which often interferes with communications equipment and the sending and receiving of documents.

CONNECTION OF THE EQUIPMENT

This equipment complies with Part 68 of the FCC rules. On the rear panel of this equipment is a label that contains, among other information, the FCC Registration Number and Ringer Equivalence Number (REN) for this equipment. If requested, this information must be given to the telephone company. This equipment may not be used on coin service provided by the telephone company. Connection to party lines is subject to state tariffs.

IN CASE OF EQUIPMENT MALFUNCTION

Should any malfunction occur which cannot be corrected by the procedures described in this *User's Guide*, disconnect the equipment from the telephone line or unplug the power cord. The telephone line should not be reconnected or the power cord plugged in until the problem is completely resolved.

Canon provides experienced support personnel to help you in every way.

CANON COMPUTER SYSTEMS CUSTOMER CARE CENTER

World Wide Web: <http://www.ccsi.canon.com>

Canon BBS: 1-757-420-2000

Fax Retrieval System: 1-800-526-4345

Customer Care Center: 1-800-423-2366

(6 a.m. to midnight EST, 7 days/week, except holidays)

RIGHTS OF THE TELEPHONE COMPANY

Should the equipment cause harm to the telephone network, the telephone company may temporarily disconnect service. The telephone company also retains the right to make changes in facilities and services which may affect the operation of this equipment. When such changes are necessary, the telephone company is required to give adequate prior notice to the user.

WARNING

Do not make any changes or modifications to the equipment unless otherwise specified in the manual. If such changes or modifications should be made, you could be required to stop operation of the equipment.

Note: This equipment has been tested and found to comply with the limits for a Class B digital device, pursuant to Part 15 of the FCC Rules. These limits are designed to provide reasonable protection against harmful interference in a residential installation. This equipment generates, uses and can radiate radio frequency energy and, if not installed and used in accordance with the instructions, may cause harmful interference to radio communications.

However, there is no guarantee that interference will not occur in a particular installation. If this equipment does cause harmful interference to radio or television reception, which can be determined by turning the equipment off and on, the user is encouraged to try to correct the interference by one of the following measures:

- Re-orient or relocate the receiving antenna.
- Increase the separation between the equipment and receiver.
- Connect the equipment into an outlet on a circuit different from that to which the receiver is connected.
- Consult the dealer or an experienced radio/TV technician for help.

The Telephone Consumer Protection Act of 1991 makes it unlawful for any person to use a computer or other electronic device to send any message via a telephone fax machine unless such message clearly contains in a margin at the top or bottom of each transmitted page or on the first page of the transmission, the date and time it is sent and an identification of the business or other entity, or other individual sending the message and the telephone number of the sending machine or such business, other entity, or individual.

In order to program this information into your fax machine, you should complete the procedure to register your telephone/fax number, name, date and time on pages 36, 37, and 38.

Important safety instructions

- 1 Read these safety instructions and refer to them later if you have any questions.
- 2 Follow all warnings and instructions marked on the FAXPHONE B640.
- 3 Place the FAXPHONE on a level surface. Do not place it on an unstable cart, stand, or table. If the FAXPHONE B640 falls, serious damage could occur.
- 4 Do not use the FAXPHONE B640 near water.
- 5 Slots and openings on the cabinet and on the back or bottom are provided for ventilation. To ensure reliable operation of the FAXPHONE B640 and to protect it from overheating, do not block or cover these openings. Do not block the openings by placing the unit on a bed, sofa, rug, or other similar surface, or near a radiator or heat register. Do not place the FAXPHONE B640 in a closet or built-in installation unless proper ventilation is provided.
- 6 Operate the FAXPHONE B640 only from the type of power source indicated on the unit's label. If you are not sure of the type of power available, consult your dealer or local power company.
- 7 The FAXPHONE B640 is equipped with a 3-prong, grounding-type plug; the plug has a third (grounding) pin. This plug will only fit into a grounding-type outlet. This is a safety feature. If you are unable to insert the plug into your outlet, contact an electrician to replace your outlet (do not use a 3-to-2 adapter). Do not defeat the safety purpose of the grounding-type plug.
- 8 Do not allow anything to rest on the power cord, and do not locate the FAXPHONE B640 where the cord will be walked on.
- 9 If you use an extension cord with the FAXPHONE B640, make sure that the total of the ampere ratings on the products plugged into the extension cord does not exceed the extension cord ampere rating. Also, make sure that the total of all products plugged into the wall outlet does not exceed the current amperage of the circuit breaker.
- 10 Do not push objects of any kind into the slots or openings on the cabinet as they may touch dangerous voltage points or short out parts, which could result in a risk of fire or electric shock.
- 11 Do not spill liquid of any kind on the FAXPHONE B640. If you spill liquid or if any substance falls into the unit, immediately unplug the FAXPHONE B640. Call your Canon Authorized Service Facility (ASF).
- 12 Unplug the FAXPHONE B640 from the wall outlet before cleaning. See pp. 88 and 89 for details.
- 13 Except as explained elsewhere in this manual, do not attempt to service the FAXPHONE B640 yourself. Opening and removing interior covers may expose you to dangerous voltage points or other risks. Refer all servicing to a Canon Authorized Service Facility (ASF).
- 14 Unplug this product from the wall outlet and refer servicing to qualified service personnel under the following conditions:
 - When the power cord or plug is damage or frayed.
 - If liquid has been spilled into the unit.
 - If the FAXPHONE B640 has been exposed to rain or water.
 - If the FAXPHONE B640 does not operate normally when you have followed the operating instructions. Adjust only those controls that are covered by the operating instructions in this manual. Improper adjustment of other controls may result in damage and many require extensive work by a qualified technician to restore the product to normal operation.
 - If the FAXPHONE B640 has been dropped or the cabinet has been damaged.
 - If the FAXPHONE B640 exhibits a distinct change in performance, indicating a need for service.

You must register your fax number, your name or company name, and the date and time in the FAXPHONE B640 before you use it.

This is required by the FCC rules governing the use of fax equipment. See pp. 36, 37, and 38 for details.

Users in Canada

PRE-INSTALLATION REQUIREMENTS FOR CANON FACSIMILE EQUIPMENT

A. Location

Supply a suitable table, cabinet, or desk. See specifications (p. 103) for unit's dimensions and weight.

B. Order Information

1. Provide only a single line to touch-tone or rotary telephone set terminated with a standard 4-pin modular phone plug. (Touch-tone is recommended if available in your area.)
2. Order an RJ11-C modular jack (USOC code), which should be installed by the phone company. If the RJ11-C jack is not present, installation cannot occur.
3. Order a normal business line from your telephone company's business representative. The line should be a regular voice grade line or equivalent. Use one line per unit.

DDD (DIRECT DISTANCE DIAL) LINE

or

IDDD (INTERNATIONAL DIRECT DISTANCE DIAL) LINE IF YOU
COMMUNICATE OVERSEAS

NOTE: Canon recommends an individual line following industry standards [e.g., the 2500 (Touch tone) or 500 (Rotary/Pulse Dial) telephones]. A dedicated extension off a PBX unit without "Camp On" signals is also permissible with a FAX unit. Key telephone systems are not recommended because they send non-standard signals to individual telephones for ringing and special codes, which may cause a FAX error.

C. Power Requirements

The power outlet should be a three-prong grounded receptacle (Single or Duplex). It should be independent from copiers, heaters, air conditioners, or any electric equipment that is thermostatically controlled. The rated value is 120 volts and 15 amperes. The RJ11-C modular jack should be relatively close to the power outlet to facilitate installation.

NOTICE

The Industry Canada label identifies certified equipment. This certification means that the equipment meets telecommunications network protective, operational and safety requirements as prescribed in the appropriate Terminal Equipment Technical Requirements document(s). The Department does not guarantee the equipment will operate to the user's satisfaction.

Before installing this equipment, users should ensure that it is permissible to be connected to the facilities of the local telecommunications company. The equipment must also be installed using an acceptable method of connection. The customer should be aware that compliance with the above conditions may not prevent degradation of service in some situations.

Repairs to certified equipment should be coordinated by a representative designated by the supplier. Any repairs or alterations made by the user to this equipment, or equipment malfunctions, may give the telecommunications company cause to request the user to disconnect the equipment. Information regarding authorized service facility locations can be obtained by calling Canon Canada below.

CANON CANADA
1-800-263-1121
24 HOURS A DAY, 7 DAYS A WEEK

Users should ensure for their own protection that the electrical ground connection's power utility, telephone lines and internal metallic water pipe system, if present, are connected together. This precaution may be particularly important in rural areas.

Caution

Users should not attempt to make such connections themselves, but should contact the appropriate electric inspection authority, or electrician, as appropriate.

NOTICE

The Ringer Equivalence Number (REN) assigned to each terminal device provides an indication of the maximum number of terminals allowed to be connected to a telephone interface. The termination on an interface may consist of any combination of devices subject only to the requirement that the sum of the Ringer Equivalence Numbers of all the devices does not exceed 5.

Precautions

General

Make sure the place where you set up the FAXPHONE satisfies the following conditions:

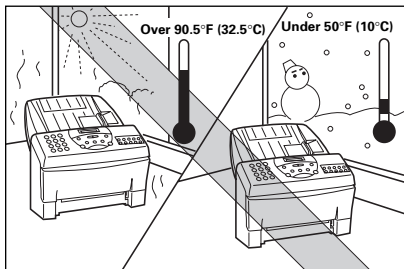

- Use the FAXPHONE only within the following temperature and humidity ranges.

Ambient temperature:
50°F to 90.5°F (10°C to 32.5°C)
Ambient humidity:
10% to 80% RH (no condensation)

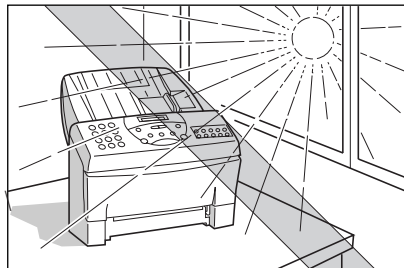

- Keep your FAXPHONE out of direct sunlight, as this can damage the unit.

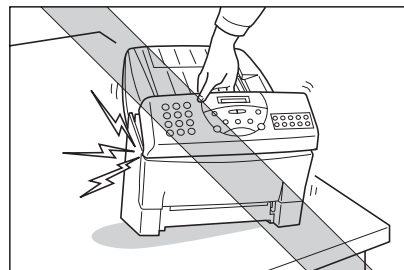

- Do not lift the FAXPHONE by the operation panel.

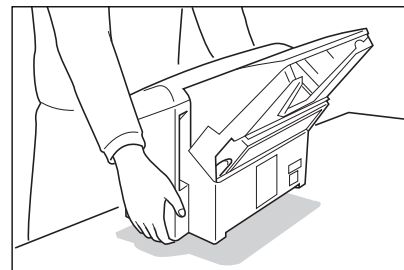

- Hold the FAXPHONE as shown when transporting it.

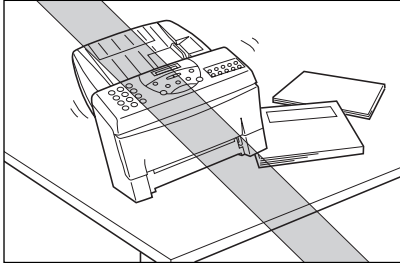

- Place the FAXPHONE on a level surface.

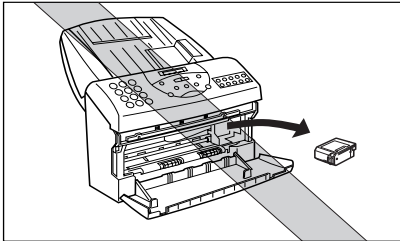

- Do not remove the BJ cartridge from the unit unless it needs to be replaced, or when transporting the FAXPHONE. Removing the cartridge and leaving the print head unprotected will cause it to dry out and become unusable.

- Do not place the FAXPHONE on the edge of a desk to prevent received documents from falling onto the floor.
- Certain table surfaces may prevent received documents from sliding out smoothly, resulting in paper jams. Do not place the FAXPHONE on these types of tables.
- Do not install the FAXPHONE near devices which contain magnets or generate magnetic fields.
- Do not subject the FAXPHONE to strong physical shock or vibration.
- Keep the FAXPHONE clean. Dust accumulation can prevent the FAXPHONE from operating properly.
- Before you transport your FAXPHONE, be sure to remove the BJ cartridge and recover the print head with the orange tape. After moving the FAXPHONE, remove the orange tape and reload the BJ cartridge.

Others

Here are some other general precautions when using or working around the FAXPHONE.

CAUTION

- Avoid installing your FAXPHONE in places exposed to direct sunlight, dust, vibration, high temperature or humidity, or on unstable surfaces.
- To assure proper electrical contact, make sure the FAXPHONE is firmly plugged in.
- Never pull on the cord to unplug the FAXPHONE. Pull on the plug itself.



Table of Contents

How to Use this User's Guide	
Welcome	iii
Features	iii
Disclaimer	iv
Users in the U.S.A.	iv
Important safety instructions	vi
Users in Canada	vii
Precautions	viii
General	viii
Others	ix

1. SETTING UP

Unpacking	2
Removing the shipping materials	3
Assembling the FAXPHONE	4
Attaching components	4
Connecting the AC power cord	5
Loading the paper	6
Selecting the right kind of paper	6
Loading the paper	6
Installing the BJ cartridge	8
BJ cartridge guidelines	8
Handling the BJ cartridge	9
Installing the BJ cartridge	10
Connecting the phone line	13
Connecting to the wall jack	13
Connecting an extension phone or answering machine (optional) ...	13
Setting the TEL LINE TYPE	14
Setting up to receive faxes	15
Selecting the receiving mode	15
Fax Only Mode	16
Fax/Tel Mode	17
Manual Mode	18
Ans. Machine Mode	19
Distinctive Ring Pattern Detection (DRPD) feature	21
Types of ring patterns	21
Turning on DRPD and assigning a setting to a ring pattern	22
How DRPD responds to calls	24
Communicating using the Distinctive Ring Pattern Detection (DRPD) feature	24

2. PREPARING TO USE YOUR FAXPHONE

Main components of the FAXPHONE	28
Front view	28
Rear view	29
FAXPHONE controls — the Operation Panel	30
Registering your name and number	32
Moving through the main menus	32
Entering a number	33
Entering a name	34
Personalizing your FAXPHONE	35

Table of Contents

	Registering the date and time	36
	Registering your telephone/fax number and name	37
	Registering One-touch Speed Dialing numbers and names	39
	Registering Coded Speed Dialing numbers and names	41
3. HANDLING DOCUMENTS	Preparing documents	44
	Types of documents you can scan	44
	Loading the document	45
	Setting the resolution and density	47
4. MAKING COPIES	Copying documents	50
5. SENDING FAXES	Preparing to send a document	52
	Sending methods	52
	Dialing methods	52
	Sending documents	53
	Direct Sending	53
	Manual Sending	53
	Automatic Dialing	54
	Memory Sending	55
	Canceling Sending	56
	Redialing	56
	Messages displayed during sending	57
	Clearing document jams (ejecting a document from the ADF)	58
	Delayed Sending	59
	Sending other documents while the FAXPHONE is set for Delayed Sending	60
	Canceling Delayed Sending	61
	Sequential broadcasting	62
	Sending a document to more than one location	62
6. RECEIVING FAXES	Receiving documents	64
	Receiving documents in Manual Mode	64
	Receiving documents in Fax Only Mode	65
	Receiving documents in Fax/Tel Mode	65
	Receiving documents in Ans. Machine Mode	66
	Receiving documents in memory	67
	Printing documents in memory	68
	Receiving while registering, copying or printing	68

Table of Contents

7. SETTINGS AND ACTIVITY REPORTS

User menu settings	70
Settings	73
How to change a setting	73
Activity reports	79
How to print a report	79
Activity management report	80
One-touch Speed Dialing list	80
Coded Speed Dialing list	81
User's data list	82
Activity report (Sending)	82
Activity report (Receiving)	83
Multi-activity report	83
Memory clear list	84

8. SOLUTIONS TO COMMON PROBLEMS

Paper jams	86
Automatic Document Feeder (ADF) jams	86
Recording paper jams	87
Periodic care	88
Cleaning the FAXPHONE exterior	88
Cleaning the glass scanning window	88
Cleaning the printer area	89
Cleaning the BJ cartridge print head	90
Replacing the BJ cartridge	91
Frequently Asked Questions	92
TRANSMITTING	92
RECEIVING	93
TELEPHONE	94
COPYING	95
PAPER LOADING PROBLEMS	95
GENERAL	95
Print quality problems	97
Error codes, messages and solutions	98
In case of a power failure	101
During a power failure	101

Specifications	102
Appendix	104
Document sizes	104
What happens when Fax/Tel Mode is selected	105
Glossary	106
Index	110

1

SETTING UP

Unpacking	2
Removing the shipping materials	3
Assembling the FAXPHONE	4
Attaching components	4
Connecting the AC power cord	5
Loading the paper	6
Selecting the right kind of paper	6
Loading the paper	6
Installing the BJ cartridge	8
BJ cartridge guidelines	8
Handling the BJ cartridge	9
Installing the BJ cartridge	10
Connecting the phone line	13
Connecting to the wall jack	13
Connecting an extension phone or answering machine (optional) ..	13
Setting the TEL LINE TYPE	14
Setting up to receive faxes	15
Selecting the receiving mode	15
Fax Only Mode	16
Fax/Tel Mode	17
Manual Mode	18
Ans. Machine Mode	19
Distinctive Ring Pattern Detection (DRPD) feature ..	21
Types of ring patterns	21
Turning on DRPD and assigning a setting to a ring pattern	22
How DRPD responds to calls	24
Communicating using the Distinctive Ring Pattern Detection (DRPD) feature	24

Unpacking

As you unpack the FAXPHONE, save the carton and packing material in case you want to move or ship the unit in the future.

Carefully remove all items from the box.

z It is best to have someone hold the box while you lift the FAXPHONE and its protective packaging out of the carton.

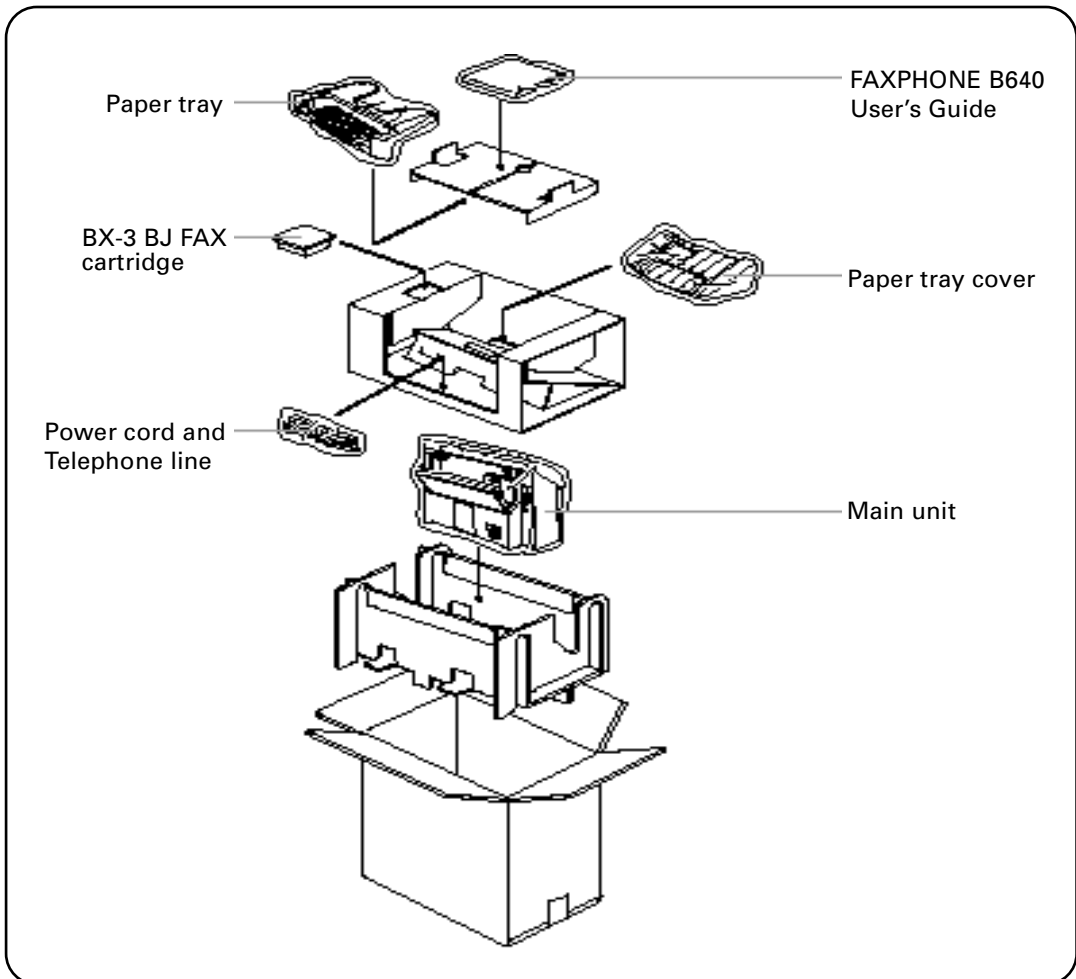

If any of these items are damaged or missing, please contact the Canon Computer Systems Customer Care Center. See p. iii.

z Be sure to fill out your Registration card and send it or fax it to Canon Computer Systems, Inc. (See the Registration card for details.) Also, save your sales receipt for proof of purchase.

Main unit



Paper tray cover

Faceplate
(may be installed on unit)



BX-3 BJ FAX cartridge



Paper tray

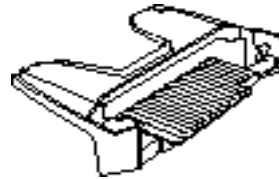

Telephone line



Power cord



Documentation

- FAXPHONE B640 User's Guide (this manual)
- Quick Start Guide
- Registration card
- Warranty card
- Canon Cares card

Removing the shipping materials

Remove the shipping materials as shown below.

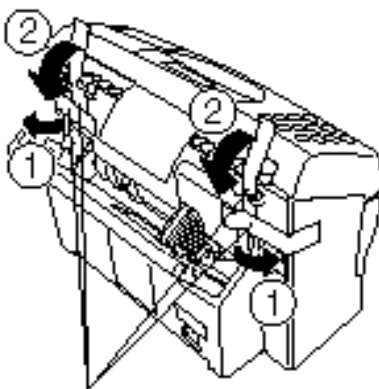

Remove all tape

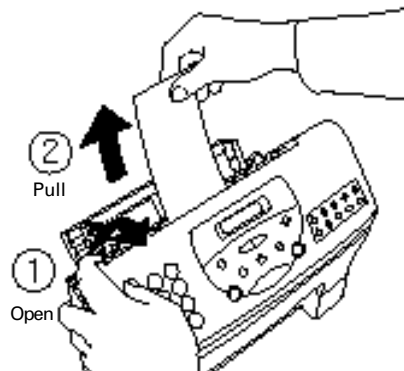

Be sure to also remove any shipping materials from the paper tray cover and the paper tray.

Assembling the FAXPHONE

To see how the FAXPHONE looks fully assembled, see Main components of the FAXPHONE, p. 28.

Attaching components

n Paper Tray

Make sure the paper lever is in the position . Then place the paper tray into the FAXPHONE, making sure the two knobs fit in the appropriate slots on the FAXPHONE.

 This symbol indicates the use of a function (envelope printing) not available with this model.

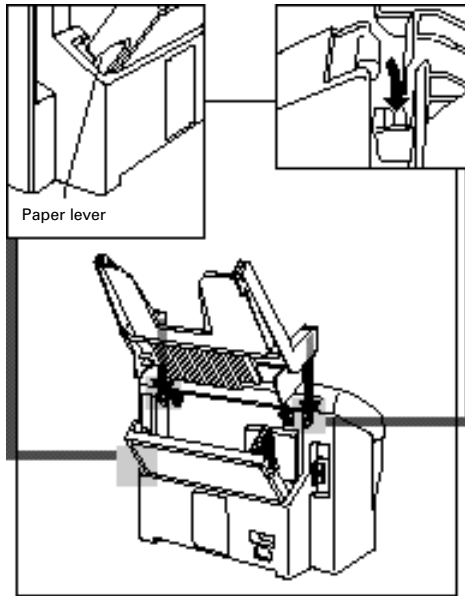

n Paper Tray Cover

Place the paper tray cover over the paper tray, making sure the two tabs fit in the appropriate slots on the FAXPHONE.

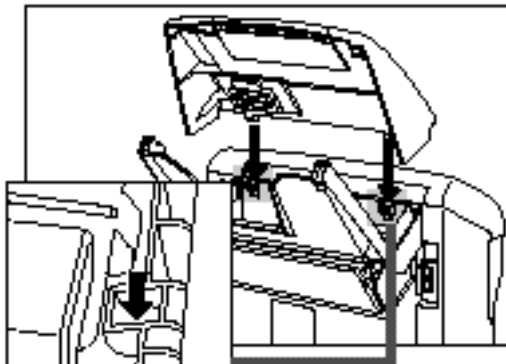

n **Faceplate**

Fit the 4 tabs of the faceplate into the corresponding slots around the One-touch button area.

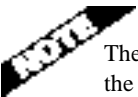
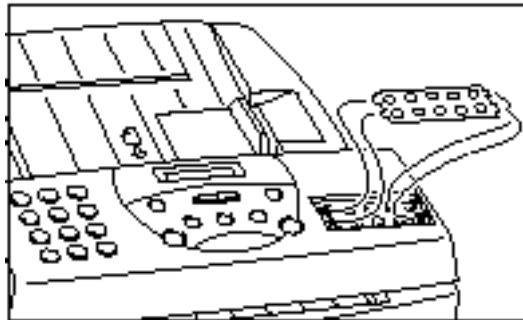

The faceplate may be installed on the FAXPHONE. If you cannot find the faceplate, check the One-touch button area of the FAXPHONE.

Connecting the AC power cord

Plug the FAXPHONE into a 120 volt AC 60 Hz three-wire grounded outlet.

1 Plug the power cord connector into the rear of the unit.

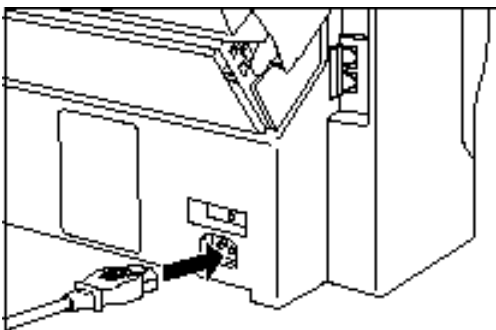

2 Plug the other end of the power cord into a properly grounded AC outlet (three-prong outlet).

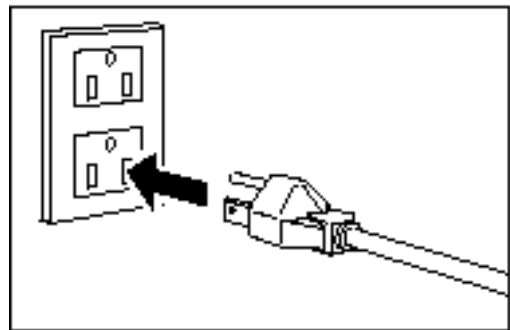

There is no power switch on the FAXPHONE. The power is on as long as the FAXPHONE is plugged in.

Loading the paper

Selecting the right kind of paper

The quality of the paper you use affects the print quality of the FAXPHONE. Using paper that meets the following specifications will ensure the best possible printing results.

Quality	Use plain bond, typewriter quality without curls, folds, or rough edges.
Weight	17–24 lbs (64 g/m ² –90 g/m ²)
Thickness	0.003"–0.005" (0.08 mm–0.12 mm)
Storage	64°F to 75°F (18°C to 24°C) 40% to 60% relative humidity.
Size	Letter, A4, Legal



the plain bond paper you intend to use first to make sure printing results are satisfactory.

- Do not use punched or colored paper.
- Do not use glossy paper.
- Ink drying time will vary depending on the type of paper.
- Using paper other than the above may cause jamming and/or blurred printing.

n Setting the paper size

The paper size setting determines the size of the recording paper in the paper tray. The factory setting is letter size. If you want to use a paper size other than letter, you must change the PAPER SIZE setting. See FAX PRINTER, p. 78.

Loading the paper

1 Remove the paper tray cover.

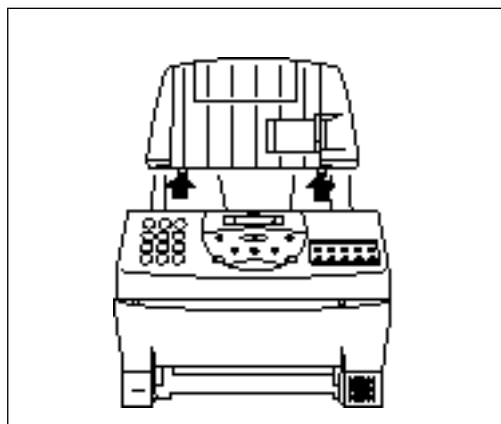

2 Fan a small stack of up to 100 sheets (up to 0.4" (10 mm) thick). Tap the edge of the stack on a flat surface to even the stack.

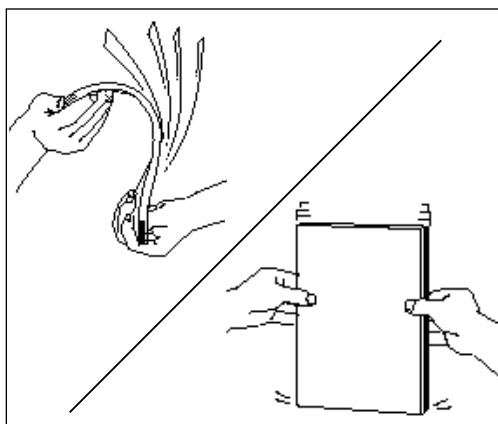

- 3** Line up the right edge of the stack of paper against the right edge of the paper tray and insert it halfway into the paper tray.

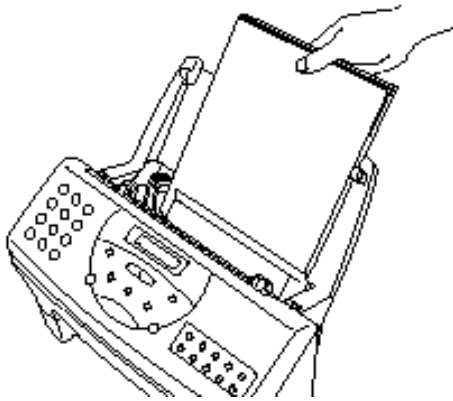

- 4** Holding the stack of paper, squeeze and slide the paper guide until it touches the left edge of the stack of paper.

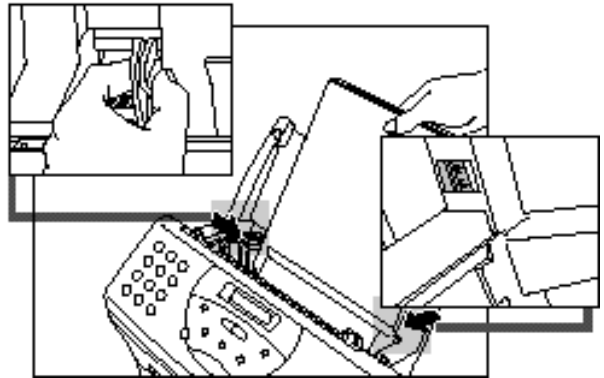

Make sure the stack of paper does not exceed the paper limit mark on the right side of the feeder.

- 5** Complete inserting the stack of paper into the paper tray until it stops.

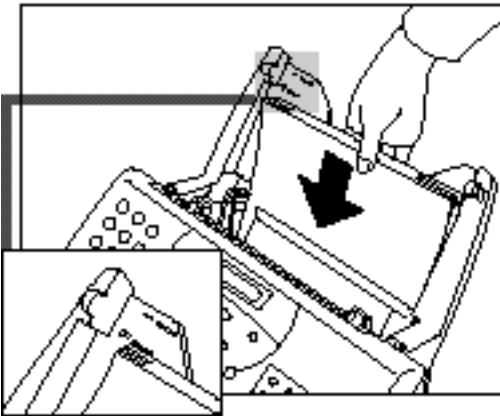

Do not force the paper down into the FAXPHONE.

- 6** Replace the paper tray cover.

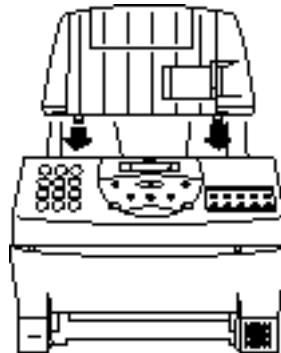

› sure the stack of the paper is flat, held upright and aligned with the left paper guide.

- The top edge of the stack does not need to be even.

Installing the BJ cartridge

The first time you set up the FAXPHONE, you have to install the BX-3 BJ FAX cartridge before you can begin receiving and copying documents.

BJ cartridge guidelines

Use only the Canon BX-3 BJ FAX cartridge with the FAXPHONE B640.



The actual amount of ink that you use will vary depending on the print density of a page. If the majority of your printed output is graphics, you may need to change the ink cartridge more often than when you are receiving or copying text only.

You may need to replace the BJ cartridge when either of the following conditions exist:

- z Your printed output is not crisp and clear, and there are gaps in the characters (missing dots) even after you have cleaned the print head once or twice and you have removed and reinstalled the BJ cartridge.
- z You have been using the BJ cartridge for over one year.



To ensure optimum print quality, Canon recommends the use of the cartridges designated by Canon. Canon accepts no liability or responsibility for damages caused by the use of any cartridge other than those designated by Canon.

- z Canon makes numerous ink cartridges; the BX-3 BJ FAX cartridge is the only one designed to be used with the FAXPHONE B640.

Handling the BJ cartridge

- Leave the BJ cartridge in its packaging until you are ready to use it to prevent it from drying out.
- Store BJ cartridges out of the reach of children; the ink contains isopropyl alcohol 67-63-0.
- Replace the BJ cartridge after one year of use or if the print is not clear or is missing, even after trying five successive head cleanings.
- Never remove the BJ cartridge unless you are going to replace it. When left exposed, the cartridge print head dries out, making it unusable.

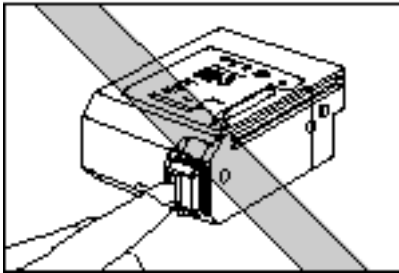

- Do not touch the print head area on the BJ cartridge. Ink may leak out and cause stains.

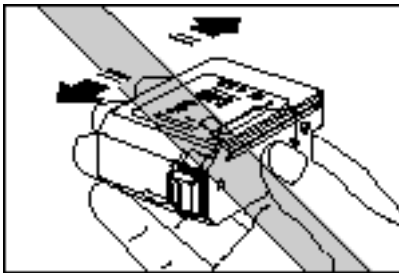

- Never shake the BJ cartridge, especially after removing the protective tape from the print head.

If spilled, the ink is very difficult to clean. Therefore, always follow the above precautions and carefully handle the BJ cartridge.

Installing the BJ cartridge

1 Open the front cover of the FAXPHONE.

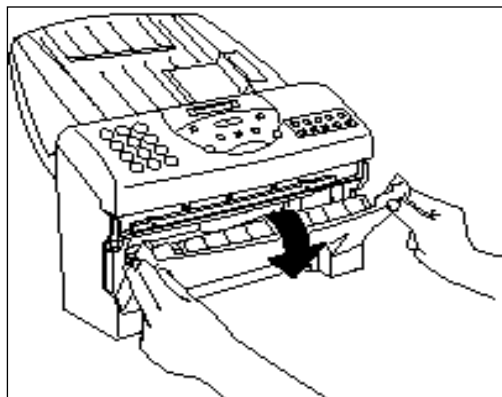

2 Raise the green cartridge release lever up.

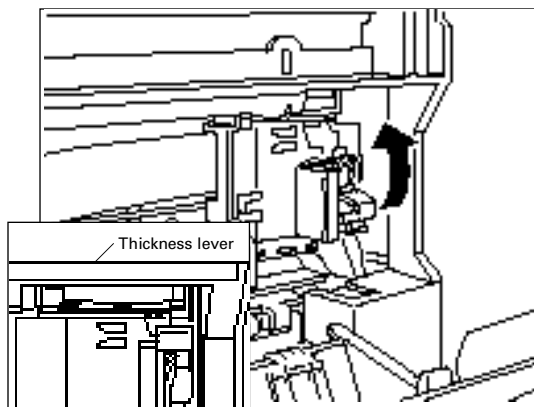

Make sure the paper thickness lever is set to the paper position (left position).

3 Remove the print head cap from the BJ cartridge.

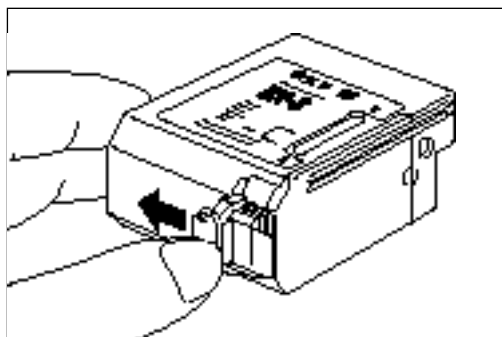

4 Pull off the protective orange tape.

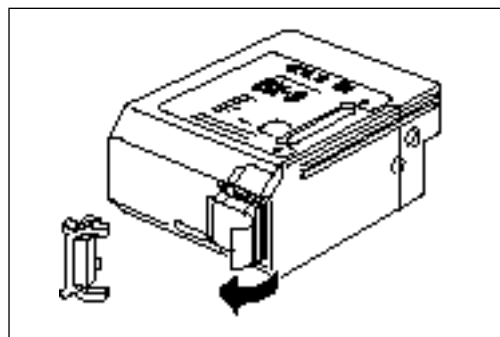

5 Insert the BJ cartridge. Align the slot in the cartridge with the yellow post in the FAXPHONE.

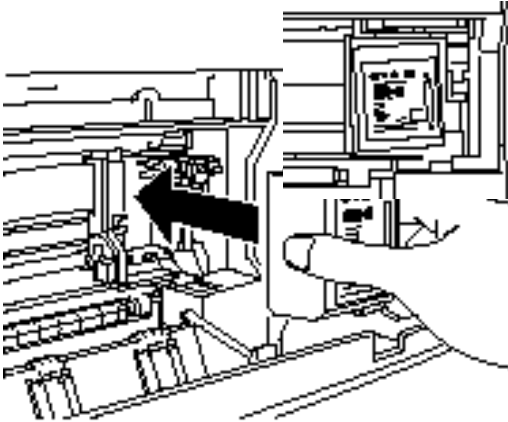

The yellow post (BJ cartridge guide) should be visible through the slot. The BJ cartridge tilts slightly to the left in the loaded position.

6 Lower the cartridge release lever down until you hear a click to lock the cartridge in place.

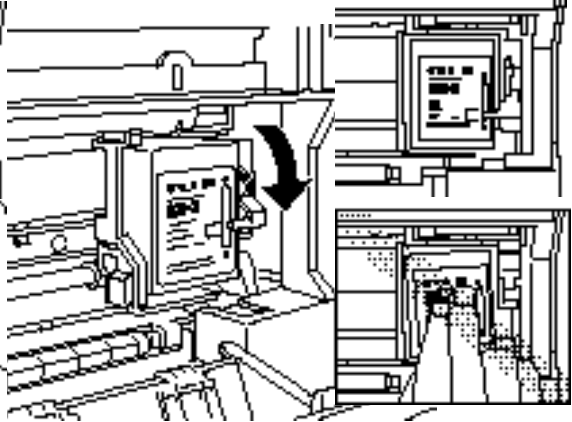

- Z Make sure the arm on the cartridge release lever is aligned with the marking on the BJ cartridge.
- Z If the lever movement is not smooth, release the lever and reload the cartridge.
- Z To avoid cartridge misalignment and an error message to appear, do not press down on the cartridge or try to align it manually while raising and lowering the green lever.

7 Close the front cover of the FAXPHONE.

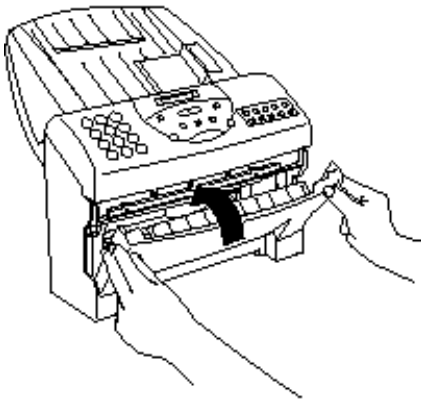

-
- 8** The FAXPHONE automatically prints a test page.
The FAXPHONE prints a test page every time you insert a BJ cartridge.

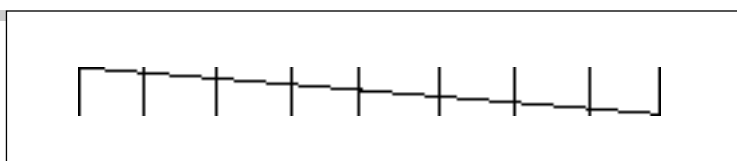
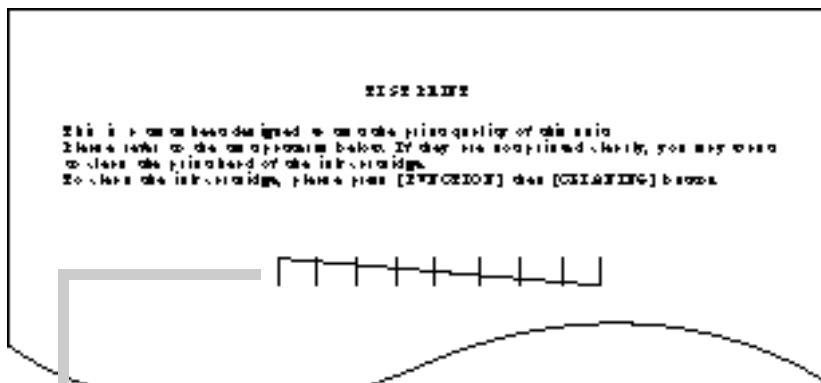

When the BJ cartridge is properly installed, the test printout should look as shown above.

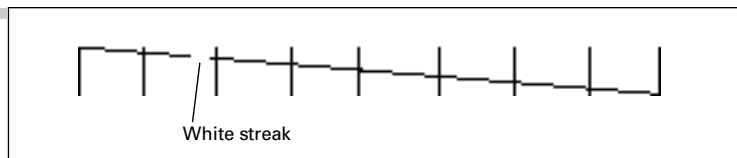

If the printout has white streaks as shown above, try cleaning the print head.
See *Cleaning the BJ cartridge print head*, p. 90.
If the problem persists after cleaning, try reinstalling the BJ cartridge.

- z You can turn off automatic test printing by changing the AUTO TEST PRINT setting. See *SYSTEM SETTINGS*, p. 78.

Connecting the phone line

Connecting to the wall jack

You need an RJ11-C type (modular) wall jack to connect the FAXPHONE to the telephone system. Contact your local telephone company to install this type of jack if you do not have one.

- 1 Connect one end of the supplied telephone line to the jack marked  on the rear of the FAXPHONE.

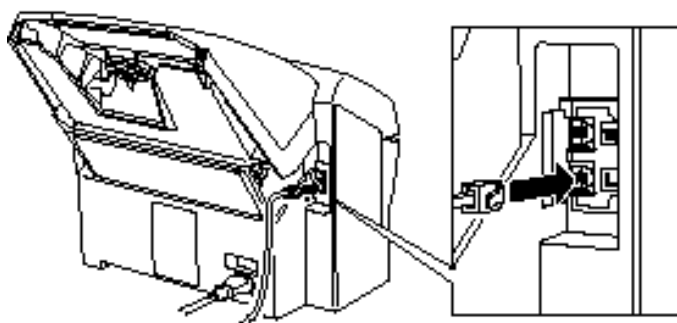

- 2 Connect the other end of the line to your wall telephone jack.

Connecting an extension phone or answering machine (optional)

- 1 Connect an extension phone or answering machine to the jack marked  on the rear of the FAXPHONE.

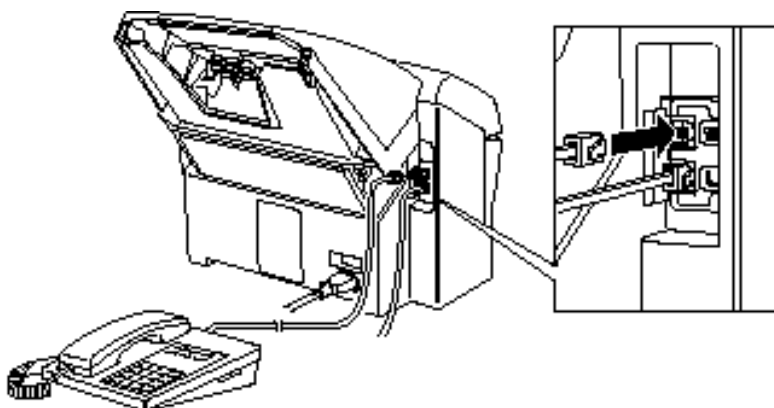

- z To use a phone or answer machine on the same line with the FAXPHONE, the phone and/or answer machine must be attached directly to the FAXPHONE.
- z Be sure to connect an extension phone if you want to use the INCOMING RING feature and you want it to ring when the FAXPHONE receives a call. See pp. 65, 77.
- z If you connect an answering machine, refer to Ans. Machine Mode, p. 19.



Setting the TEL LINE TYPE

Your FAXPHONE is factory set to work with touch tone telephone lines. If you have a pulse line, you will need to change the telephone line setting as follows.

- 1** Press [FUNCTION].
Wait a second for TEL REGISTRATION to appear.

FUNCTION

SELECT MENU
TEL REGISTRATION
TEL REGISTRATION
- 2** Use [←] or [→] to select USER SETTINGS.
^t Press [START/COPY].



 

USER SETTINGS



SET DATE

- 3** Use [←] or [→] to select TEL LINE TYPE.
^t Press [START/COPY].



 

TEL LINE TYPE



TOUCH TONE

- 4** Use [←] or [→] to select ROTARY PULSE.

ROTARY PULSE

- 5** Press [START/COPY].



DATA ENTRY OK

- 6** Press [STOP] to finish.

STOP 

Setting up to receive faxes

Selecting the receiving mode

Before you set up the receiving mode on your FAXPHONE, you should determine how you plan to use your FAXPHONE:

- Z Are you able to dedicate the use of one telephone line to the FAXPHONE only to receive document transmissions from other fax machines? If yes, choose Fax Only Mode (see below).
- Z Do you want to use your FAXPHONE as both a telephone and fax, receiving documents automatically and ringing only for telephone calls? If yes, choose Fax/Tel Mode (see below).
- Z Do you want to use your FAXPHONE mainly as a telephone, and answer every call yourself, whether from a person or a fax unit? If yes, choose Manual Mode (see below).
- Z Do you want to connect an answering machine to your FAXPHONE and receive the other party's document and also record the other party's message? If yes, choose Ans. Machine mode (see below).
- Z Can you use the Distinctive Ring Pattern (DRP) service offered by your telephone company allowing you to have separate numbers for telephone and fax using only one phone line? If yes, use the Distinctive Ring Pattern Detection (DRPD) Feature (see below).

How you answer these questions will determine which receiving method you choose. If you are not satisfied with the mode you select, you can always change it at any time.

n Fax Only Mode (See p. 16)

You may want to use this mode if you have two phone lines in your office, and plan to use one line for the FAXPHONE and the other line for your telephone.

Set the Fax Only Mode if you want to use your FAXPHONE only to receive faxes automatically and do not intend to use it as a telephone.

n Fax/Tel Mode (See p. 17)

If you only have one phone line in your office, you may be planning to use it for both fax and telephone communication. By setting this mode, you will be able to use your FAXPHONE for both fax and telephone communication using only one phone line. You will need to have an extension phone connected to the FAXPHONE so that when it rings to alert you of a call, you can answer the call. The FAXPHONE will automatically receive faxes without ringing.

n Manual Mode (See p. 18)

Use Manual Mode if you receive more telephone calls than faxes. By having telephone connected to your FAXPHONE, you can answer every call, whether from a person or from another fax unit. If you hear a slow beep, simply press [START/COPY] on your FAXPHONE and hang up the phone to receive the fax.

n Ans. Machine Mode (See p. 19)

Use Ans. Machine Mode if you have an answering machine connected to the FAXPHONE. This mode allows you to receive not only documents sent from other fax machines, but also messages from people calling when you are out.

n **Distinctive Ring Pattern Detection (DRPD) Feature** (See p. 21)

Some companies offer a distinctive ring pattern (DRP) service that allows you to assign two or more telephone numbers with distinctive ring patterns to a single telephone line. By subscribing to such a service, you can have both a fax number(s) and a telephone number(s) for your FAXPHONE using only one phone line.

When a call is made, the FAXPHONE checks the incoming ring pattern and knows if the call is from another fax unit or from a telephone.

Fax Only Mode

The FAXPHONE is set up at the factory for both fax transmission and telephone calls. If you have a dedicated fax line, you need to set the FAXPHONE to Fax Only Mode.

n **Setting Fax Only Mode**

When you set the FAXPHONE to Fax Only Mode, the unit picks up every call and automatically treats it as a fax transmission.

The FAXPHONE cannot receive automatically if you are making copies, printing reports, or registering information. See p. 68.

- 1** Press [RECEIVE MODE] until "Fax Only Mode" appears on the LCD.



Fax Only Mode

- 2** Press [START/COPY].
When this mode is set, the LCD will display the date and "FaxOnly".



09/15/97 FaxOnly

n **Receiving documents in Fax Only Mode**

When the FAXPHONE is set to Fax Only Mode, it automatically receives documents whenever a call comes over the fax line.

- 1** Make sure the FAXPHONE is set to "Fax Only Mode" (see above).

The FAXPHONE assumes all incoming calls are from another fax machine sending a document. It receives the documents automatically.

Fax/Tel Mode

If you only have one phone line in your office, you can set the FAXPHONE to receive both documents and telephone calls. You need to have an extension phone connected to your FAXPHONE for this mode. See p. 13.

n Setting Fax/Tel Mode

The FAXPHONE is set up at the factory to this mode. You only need to follow this procedure if you have changed the factory setting.

- 1 Press [RECEIVE MODE] until "Fax/Tel Mode" appears on the LCD.**



- 2 Press [START/COPY].**
When this mode is set, the LCD will display the date and "Fax/Tel".

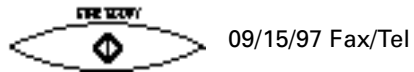

n Receiving documents and calls in Fax/Tel Mode

You can set the FAXPHONE to monitor all incoming calls over the fax/telephone line. When the FAXPHONE receives an incoming call, it checks to see if the call is from another fax machine trying to send a document, or from someone wanting to talk to you.

The FAXPHONE cannot receive a document automatically if you are making copies, printing reports, or registering information. See p. 68.

- 1 Make sure you have connected an extension phone to your FAXPHONE. See p. 13.**
- 2 Make sure the FAXPHONE is set to "Fax/Tel Mode" (see above).**

When the FAXPHONE receives a call, it checks to see whether the call is from another fax machine or from a telephone.

- z If it is a fax call, your FAXPHONE automatically switches to receive mode to accept the fax.
- z If the call is from a person, your FAXPHONE rings to alert you to pick up the handset of the extension phone.

Manual Mode

You may want to set your FAXPHONE to Manual Mode if you want to personally monitor every call, whether from a fax machine or a person.

You need to have an extension phone connected to your FAXPHONE for this mode.
See p. 13.

n **Setting Manual Mode**

Set to Manual Mode if you want to personally monitor every incoming call.

- 1** Press [RECEIVE MODE] until "Manual Mode" appears on the LCD.



Manual Mode

- 2** Press [START/COPY].

When this mode is set, the LCD will display the date and "Manual".



09/15/97 Manual

n **Receiving documents and calls in Manual Mode**

You can set the FAXPHONE to ring every time it received a call so that you can personally check if it is from a fax machine or from a person.

Keep in mind that you cannot use Manual Mode if a document is in the Automatic Document Feeder (ADF) waiting to be sent.

- 1** Make sure you have connected an extension phone to your FAXPHONE. See p. 13.
- 2** Make sure the FAXPHONE is set to "Manual Mode" (see above).
- 3** When the FAXPHONE rings, pick up the handset of the extension phone connected to the FAXPHONE.
- 4** If you hear a person's voice, start your conversation. If the caller wants to send a document after talking to you, press [START/COPY] on the FAXPHONE to receive the document.
or
If you hear a slow beep or silence, another fax is trying to send you a document. Press [START/COPY] on the FAXPHONE.

Your FAXPHONE begins receiving the document.

Ans. Machine Mode

Use Ans. Machine Mode if you have an answering machine connected to the FAXPHONE. By setting this mode, you can receive documents automatically, and messages from people calling when you are out. See p. 13 for details on connecting an answering machine to your FAXPHONE.

n Recording the outgoing message

When recording a message...

- z Try to keep your message to less than 15 seconds long.
- z In the message tell your callers how to send a fax. Here's a sample message:
 "Hello. I'm not in the office right now, but please leave a message after the beep. I'll return your call as soon as possible. If you would like to send a fax, press the start button on your fax after recording your message. Thank you."
- z Leave 4 seconds pause at the beginning of the message (the 4 seconds pause plus the outgoing message should not exceed 15 seconds).
- z Set the answering machine to answer on the first or second ring.

n Setting Ans. Machine Mode

Set Ans. Machine Mode when you have an answering machine connected to your FAXPHONE, and you are going out.

- 1** Press [RECEIVE MODE] until "Ans. Machine Mode" appears on the LCD display.



Ans. Machine Mode

- 2** Press [START/COPY].
 When this mode is set, the LCD will display the date and "AnsMode".



09/15/97 AnsMode

n Receiving documents and messages in Ans. Machine Mode

When the FAXPHONE is set to Ans. Machine Mode, it automatically receives documents, or leaves messages on your answering machine when you are out.

- 1** Make sure you have connected an answering machine to your FAXPHONE. See p. 13.
- 2** Make sure the FAXPHONE is set to "AnsMode" (see above).

3 Set your answering machine to answer.

- z The FAXPHONE allows the answering machine to answer, then listens for a fax tone, and switches to receive mode automatically if it detects the tone.
- z If the FAXPHONE runs out of paper or ink, it receives the document and stores it in memory. To print out documents in memory, see pp. 67 and 68.

4 When not in use, turn the answering machine off and switch to Fax/Tel Mode, Manual Mode, or Fax Only Mode using [RECEIVE MODE].

Distinctive Ring Pattern Detection (DRPD) feature

Some phone companies offer a distinctive ring pattern (DRP) service whereby they assign two or more telephone numbers with distinctive ring patterns to a single telephone line. If your phone company offers such a service, you can have both a fax number(s) and a telephone number(s) for your FAXPHONE using only one telephone line.

Your FAXPHONE will automatically detect incoming calls. Based on the distinctive ring pattern, the FAXPHONE knows if the call is from a fax machine trying to send a document or from a telephone trying to make a voice call.

Use the information in this section to set up the FAXPHONE for use with a DRP service.

This feature is called Distinctive Ring Pattern Detection (DRPD).

For more details on the DRP service, contact your local telephone company. (Your telephone company may have a different name for this service. Also, this service may not be offered in all areas.)

Types of ring patterns

Your telephone company will assign a distinctive ring pattern to each number when you order the DRP service.

The setting you make with the following procedure must match the setting assigned by the telephone company.

You can set the FAXPHONE to select among the following ring patterns:

- | | |
|--------------------|---|
| z Normal ring: | Ring type of normal telephone line |
| z Double ring: | Two short rings at regular intervals |
| z Triple ring: | Short-short-long at regular intervals |
| z Triple ring: | Short-long-short at regular intervals |
| z Other ring type: | Patterns other than those described above |

Turning on DRPD and assigning a setting to a ring pattern

- 1** Press [FUNCTION].
Wait a second for TEL REGISTRATION to appear.

FUNCTION



SELECT MENU





TEL REGISTRATION

- 2** Use [←] or [→] to select RX SETTINGS.
^t Press [START/COPY].



RX SETTINGS







ECM RX

- 3** Use [←] or [→] to select DRPD
^t Press [START/COPY].



DRPD





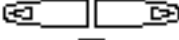

OFF

- 4** Use [←] or [→] to select ON.
^t Press [START/COPY].
Wait a second for NORMAL RING to appear.



ON





DATA ENTRY OK



NORMAL RING

5 Use [←] or [→] to select a ring pattern.

- z NORMAL RING
- z DOUBLE RING
- z SHORT-SHORT-LONG
- z SHORT-LONG-SHORT
- z OTHER RING TYPE



NORMAL RING

^t
When the pattern you want to set is displayed, press [START/COPY].



NORMAL RING

TEL

6 Use [←] or [→] to select TEL, FAX or FAX/TEL SWITCH.

- z TEL
- z FAX
- z FAX/TEL SWITCH



FAX

^t
When the setting you want to set is displayed, press [START/COPY].



DATA ENTRY OK



DOUBLE RING

Wait a second for DOUBLE RING to appear.

7 Press [STOP] to finish.

To make additional assignments, start from step 5.
 To finish, press [STOP].



¹ If DRPD is set to ON, the communication type for each ring pattern defaults to TEL (except for the DOUBLE RING pattern which defaults to FAX). After you select the ring pattern that has been assigned for your fax communications, you need to make sure that the other ring patterns are not set to FAX. Otherwise, the FAXPHONE may answer as a fax for each ring pattern.

How DRPD responds to calls

When there is an incoming call, the FAXPHONE checks the incoming ring pattern and determines the type of pattern being received. The FAXPHONE may require up to 10 seconds to determine the pattern type, and during this time the FAXPHONE does not ring. After the pattern is detected, the FAXPHONE reacts according to how you registered the setting.

Your Setting	Incoming Call	
	From Fax	From Telephone
FAX	Receives the fax document without ringing.	Answers as a fax machine.
TEL	Ignores fax transmissions.	Receives telephone calls, and rings to alert you to pick up the extension phone.
FAX/TEL SWITCH	Switches to receive mode for fax transmission signals and does not ring.	Rings the FAXPHONE so you can pick up the extension phone and take the telephone call.

Communicating using the Distinctive Ring Pattern Detection (DRPD) feature

Using the FAXPHONE with a DRPD service is almost the same as using it with a normal telephone line. When you receive calls, however, the FAXPHONE responds somewhat differently, as described below.

The DRPD service is commonly used with automatic receiving only.

n **FAXPHONE set to Fax Only Mode** **("Fax/Only" displayed on the LCD)**

When the FAXPHONE is set for automatic receiving, the FAXPHONE operates according to the mode set for the registered setting (TEL, FAX, or FAX/TEL SWITCH). If FAX/TEL SWITCH is set, the difference between incoming telephone calls and fax transmissions will be detected.

- z When someone calls using the number assigned for telephone communication, the FAXPHONE rings in the pattern you registered in the above procedure. When you hear the telephone call ring pattern, simply pick up the extension phone connected to the FAXPHONE and talk. If you do not pick it up, the FAXPHONE continues to ring until the other party hangs up.
- z When someone sends a fax using the number assigned for fax communication, the FAXPHONE does not ring. It receives the document automatically.

If you use a receiving mode other than automatic receiving with the DRP service:

**n FAXPHONE set to Manual Mode
("Manual" displayed on the LCD)**

When you receive a call over any of the numbers in the DRP system, the FAXPHONE rings with the appropriate pattern you registered. Pick up the handset of the connected extension phone.

- z If the call is from a person, talk normally.
- z If you hear a slow beep, press [START/COPY] to receive a fax.

**n FAXPHONE set to Ans Machine Mode
("AnsMode" displayed on the LCD)**

- z When someone calls using the number assigned for telephone communication, the FAXPHONE rings with the pattern you registered. When the FAXPHONE rings, the answering machine connects and then takes over the call.
- z When someone sends a fax using the number assigned for fax communication, the FAXPHONE receives the document automatically.

**n FAXPHONE set to Fax/Tel Mode
("Fax/Tel" displayed on the LCD)**

The FAXPHONE monitors all incoming calls for all the numbers with DRPD. The FAXPHONE answers the telephone for you and checks to see if the call is from another fax machine or from a person wanting to talk to you. If the call is from another fax, the FAXPHONE automatically receives the document. If the call is from a person, the FAXPHONE rings to alert you to pick up the phone.

No matter which number receives a call, if you hear a slow beep signifying another fax trying to send you a document, press [START/COPY] to receive the document.

2

PREPARING TO USE YOUR FAXPHONE

Main components of the FAXPHONE	28
Front view	28
Rear view	29
FAXPHONE controls — the Operation Panel	30
Registering your name and number	32
Moving through the main menus	32
Entering a number	33
Entering a name	34
Personalizing your FAXPHONE	35
Registering the date and time	36
Registering your telephone/fax number and name	37
Registering One-touch Speed Dialing numbers and names	39
Registering Coded Speed Dialing numbers and names	41

Main components of the FAXPHONE

Front view

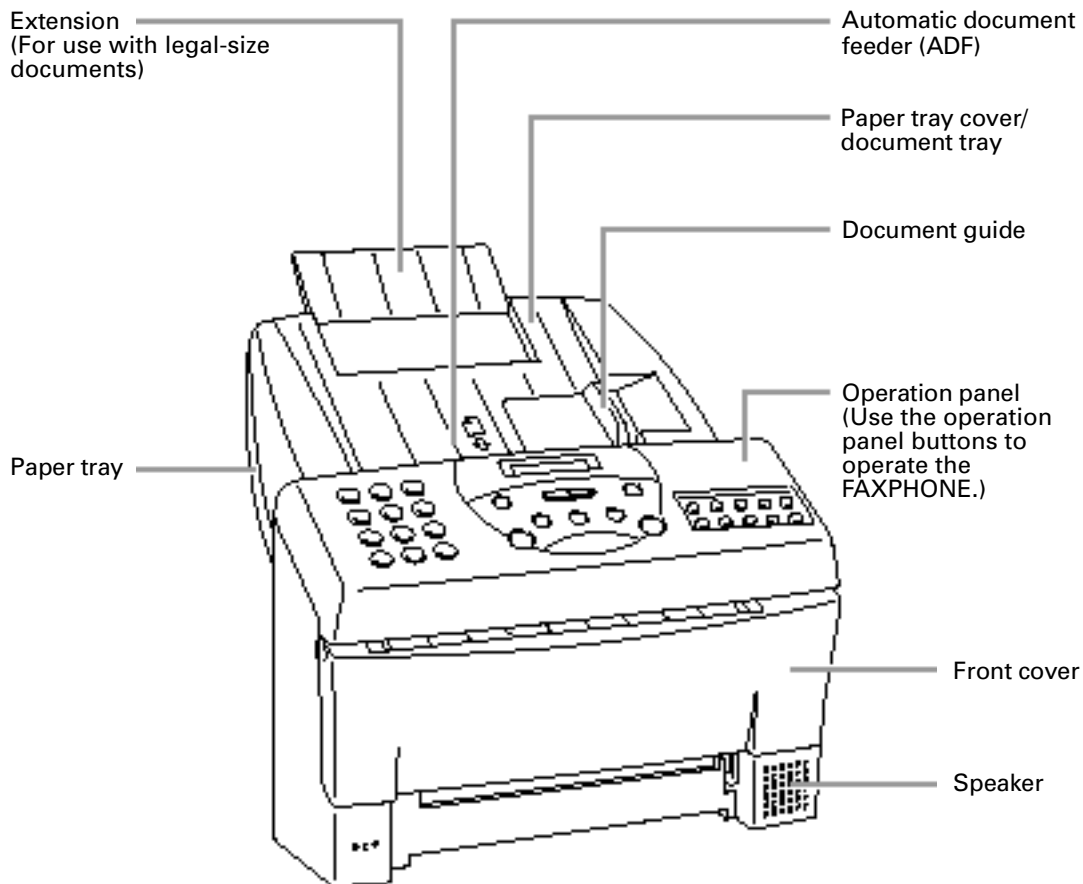

Rear view _____

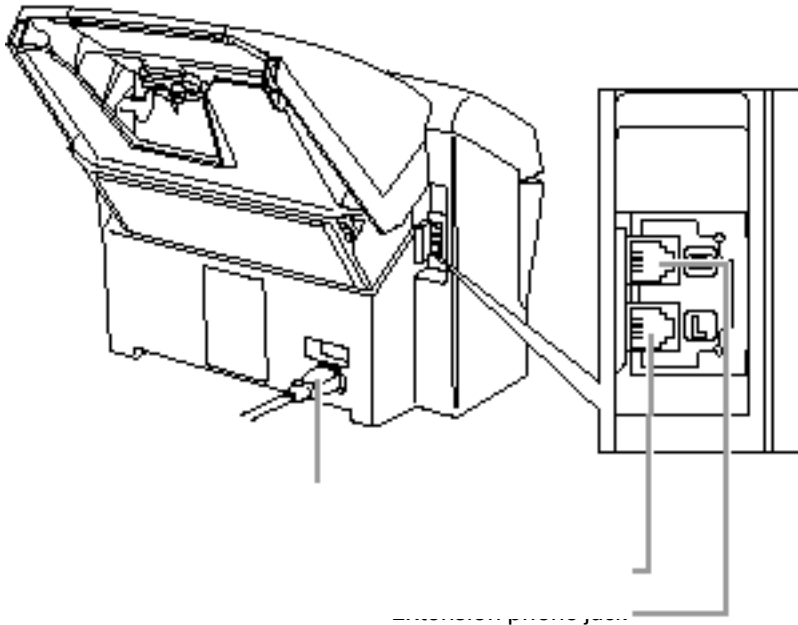

FAXPHONE controls — the Operation Panel

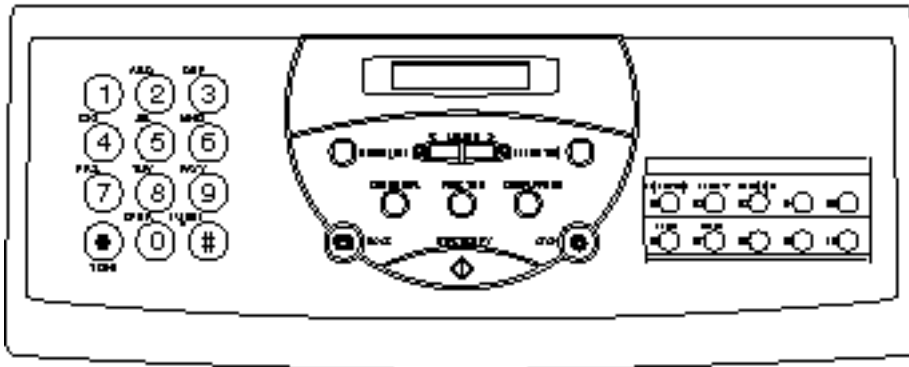

Numeric buttons

Use the numeric buttons to enter phone numbers when dialing. These buttons can also be used to enter text, numbers, and symbols when registering names.

+ (#)

When registering your fax number, press to enter a plus (+).

TO NE

Press to temporarily set your FAXPHONE to send a tone signal when using pulse dialing.

Press  and

CLEANING

Press to clean the BJ cartridge print head.

REPORT

Press to print a transaction report, a list of registered numbers, or a list of settings.

SEND OPTIONS

Press to select a transmission mode.

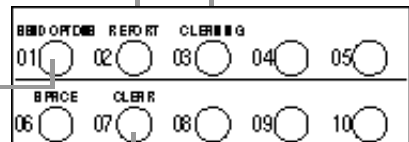

SPACE

Press to enter a space between numbers or letters when you register fax numbers and names.

CLEAR

Press to clear a number or name quickly so you can re-enter it.

LCD Display

Displays messages and prompts during operation. Displays selectable functions, numbers, and names when registering information.

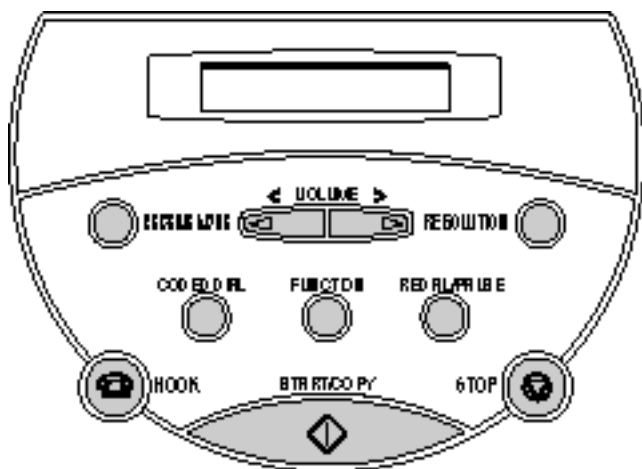

 **HOOK**
Press to engage or disengage the telephone line (hands-free dialing).

 **START/COPY**
Press to start sending, receiving and copying. This button is also used for data entry operations.

 **STOP**
Press to cancel sending, receiving, copying and data entry operations.



RECEIVE MODE
Four modes are available:
Fax Only Mode: Answers calls as fax calls automatically.
Ans. Machine Mode: Receives documents and passes calls to an answering machine.
Fax/Tel Mode: Receives both documents and telephone calls.
Manual Mode: Receives calls manually.



Arrow buttons (←, →)/VOLUME
Use to scroll through menus and lists that appear on the LCD, and to change settings. These buttons also move the cursor in some naming operations and adjust the volume of the monitor speaker.



RESOLUTION
Use to set the resolution for the type of document you want to send. You can select from STANDARD, FINE, and PHOTO.



CODEDIAL
Press this button (followed by a two-digit code) to dial a fax number registered for Coded Speed Dialing.



FUNCTION
Press to start data registration of fax numbers, names, and other important settings for sending and receiving.



REDIAL/PAUSE
Press to dial the last number dialed with the numeric buttons. When dialing or registering fax numbers, press to enter pauses between digits.

Registering your name and number

You should now register the time, date, and your name and fax number, which will appear at the top of every page you send.

NOTE In accordance with recent amendments to the FCC rules governing the use of facsimile equipment, you are now required to include your fax number, your name or company name and the date and time of the fax you are sending every time that you send a fax. Please follow the setting instructions in this manual in order to comply with this requirement.



Moving through the main menus



The FAXPHONE includes a menu system that you use to register information and select fax and telephone operations. The main menu includes these items:



- TEL REGISTRATION
- USER SETTINGS
- REPORT SETTINGS
- TX SETTINGS
- RX SETTINGS
- FAX PRINTER
- SYSTEM SETTINGS

For a complete description of the menu system, see User menu settings, p. 70. In general, follow these steps to access the menus and make selections:

- 1 Press [FUNCTION].**
Wait a second for TEL REGISTRATION to appear.

- 2 Press [←] or [→] to scroll through the menus until you see the menu you wish to access. The LCD displays the menu title.**

- 3 Press [START/COPY].** The LCD displays the first selection for the selected menu.

- 4 You can now make a selection:**
Press the arrow buttons to view the possible selections.



5 After selecting or entering a value, press [START/COPY].



DATA ENTRY OK

6 Repeat steps 4 and 5 as needed.

7 When the operation is complete, press [STOP].
Registration ends and the FAXPHONE returns to standby mode.



• 60 seconds of no operation panel input, the FAXPHONE returns to standby mode and any unregistered changes are lost.

Entering a number

Whenever you are prompted to enter a fax number or a telephone number, follow these procedures.

Use the numeric buttons to enter the number.

TEL=

- z You can enter up to 20 digits for your fax number or 50 digits for a speed dialing number.
- z Be sure to enter 1 and the area code, if necessary, to dial a different area code.
- z Do not enter dashes, slashes, commas, or other punctuation.

Use the One-touch Speed Dialing buttons as follows:

- z To enter a space between numbers, press [SPACE].
- z If you make a mistake, press [CLEAR] and enter the number again.
- z To erase a previously registered number, press [CLEAR]. You can also enter a new number over the old one.

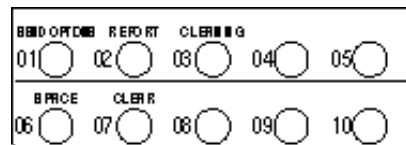

If you need to enter a pause for any reason,

- z Press [REDIAL/PAUSE] at the desired point in the sequence when entering a series of digits.
- z A pause within a number is 2 seconds long. The length of this pause can be adjusted. See MID PAUSE SET in TX SETTINGS, p. 76. A pause at the end of a number is fixed at 10 seconds.

Entering a name

Whenever you register a fax number or a telephone number, you can assign a name to that number. To enter a name from the operation panel, you use the numeric buttons to create alphanumeric characters.

Each button has a certain letter group plus a digit assigned to it; an uppercase set followed by a lowercase set of characters and then a digit. Each press of the button steps to the next character in the group.

Use the chart below to determine which number to press for each character:

To enter	Press this numeric button
0	0
1	1
ABCabc 2	2
DEFdef 3	3
GHIghi 4	4
JKLjkl 5	5
MNOmno 6	6
PQRSpqrs 7	7
TUVtuv 8	8
WXYZwxyz 9	9
-. * # ! " , ; : ^ ` _ = / ' ? \$ @ % & + () [] { } < >	#

Z First press the numeric button corresponding to the character you want.

Z Press the numeric button repeatedly until the character you want appears in the display. For example, to enter BIG 1:

- 1 Press the appropriate numeric button repeatedly until the desired character appears.

Press 2 twice.

- 2 The next character is in a different group, so simply press the new group's numeric button—the cursor moves automatically. Press the numeric button repeatedly to display the desired character.

Press 4 three times.

- 3 The next character is in the same group, so press [→] to move the cursor to the right first. Then press the numeric button repeatedly.

Press [→] once. Then, press 4 once.

- 4 The next character is a space. Simply press [SPACE].

Press [SPACE] once.

- 5 The next character is a digit. Press the numeric button corresponding to the digit. (For digits other than 0 and 1, press repeatedly until the digit appears.)

BIG 1 Press 1 once.

- 6 After entering a name, press [START/COPY].

- Z You can enter up to 16 characters in a name.
- Z To enter a space between characters, press [SPACE] or move the cursor to the right using [➡].
- Z To correct a mistake, use the arrow buttons to move the cursor under the mistake; then enter the correct character. You can also press [CLEAR] to begin again; then simply enter the name again.
- Z To erase a previously registered name, press [CLEAR] or simply enter the new name over the old one.

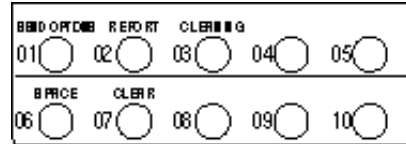

Personalizing your FAXPHONE _____

Identifying your documents

When sending a document, you can have your fax number and your name (known as your ID), and the current date and time printed out by the receiving fax. This information is called your TTI (Transmit Terminal Identification) and appears at the top of the faxed document in small type.

In the United States, you are required to include this information every time you send a fax. So be sure to enter your TTI information in your FAXPHONE now.

By identifying the documents you send, the receiving party will recognize your fax



THE PAGE NUMBER/
THE TOTAL NUMBER
OF PAGES SENT

THE NAME OF THE PARTY WHO IS
RECEIVING THE DOCUMENT

YOUR NAME OR COMPANY NAME

YOUR FAX/TELEPHONE NUMBER

THE DATE AND TIME YOU SENT THE DOCUMENT

The top line includes the name of the receiving party if you send the document using One-touch Speed Dialing or Coded Speed Dialing and you registered the party's name. It also includes the total number of pages sent if you send the document from memory.

Registering the date and time



Follow the steps below to set the date and time for your FAXPHONE. The date and time appear in the LCD display as well as on the documents you send.

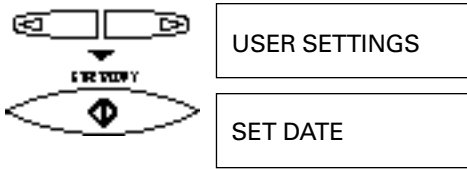
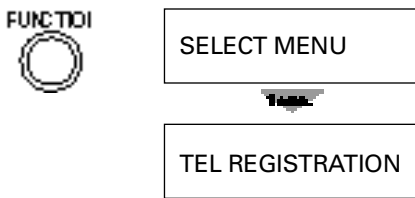

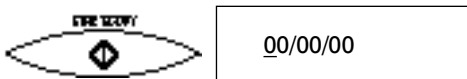
- 1 Press [FUNCTION].**
Wait a second for TEL REGISTRATION to appear.

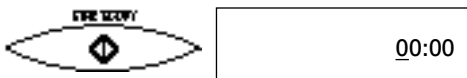
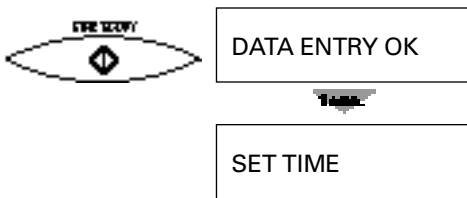

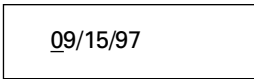
- 2 Use [←] or [→] to select USER SETTINGS.**
Press [START/COPY].

- 3 Press [START/COPY].**

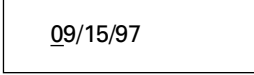
- 4 Enter today's date using the numeric buttons, using the month-day-year format (MM/DD/YY).**
z Precede single digits with a zero.
z To make a correction, press [CLEAR] to return to the previous setting and re-enter the date.
z You can also use [←] or [→] to move the cursor.
z To change the date format. See SYSTEM SETTINGS p. 78.

- 5 Press [START/COPY] when you finish entering the new date.**
Wait a second for SET TIME to appear.

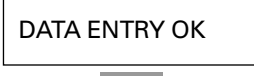
- 6 Press [START/COPY].**



7 Enter the time using the numeric buttons.

Set the time using the 24-hour clock system. Precede single digits with a zero. Example:
 07:30 = 7:30 a.m.
 17:05 = 5:05 p.m.



08:15

8 Press [START/COPY] when you finish entering the new time.



DATA ENTRY OK

9 Press [STOP].

Registration ends and the FAXPHONE returns to standby.



Registering your telephone/fax number and name

Follow the steps below so that your fax number and name appear on the top of each document you send.

1 Press [FUNCTION].

Wait a second for TEL REGISTRATION to appear.



SELECT MENU



TEL REGISTRATION

2 Use [←] or [→] to select USER SETTINGS.

Press [START/COPY].

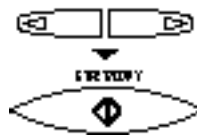

USER SETTINGS

SET DATE

3 Use [←] or [→] to select ENTER YOUR TEL.

Press [START/COPY].

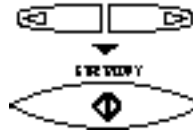

ENTER YOUR TEL

TEL=

4 Enter your fax number (up to 20 digits) using the numeric buttons.

You can enter a plus sign (+) or space to make your number easier to read. To enter a plus sign (+), press [#]. To make a correction, press [CLEAR] and re-enter the number.

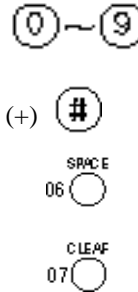

TEL= 1234 5678

5 Press [START/COPY] when you finish entering your fax number.

Wait a second for USER NAME to appear.



DATA ENTRY OK

~~TEL=~~

USER NAME

6 Press [START/COPY].



_

7 Enter your name (up to 16 characters) using the numeric buttons.

See Entering a name, p. 34. Correct errors by moving the cursor to the error using [←] or [→] and entering the correct character..



CANON/CCSI

8 Press [START/COPY] when you finish entering your name.



DATA ENTRY OK

9 Press [STOP].

Registration ends and the FAXPHONE returns to standby.



Registering One-touch Speed Dialing numbers and names

The quickest way to dial a fax number is to use One-touch Speed Dialing. This allows you to dial a number by pressing a single button. Before you can use One-touch Speed Dialing, you must register the receiving number with your FAXPHONE. One-touch Speed Dialing assigns a fax number (up to 50 digits) to a One-touch Speed Dialing button (01 to 10). You can also register the name of the party (up to 16 characters); the name appears on the printout of the One-touch Speed Dialing list. See One-touch Speed Dialing list, p. 80.

1 Press [FUNCTION].
Wait a second for TEL REGISTRATION to appear.



SELECT MENU



TEL REGISTRATION

2 Press [START/COPY].



1-TOUCH DIAL

3 Press [START/COPY].



01=

4 Use [←] or [→] to select the number of the One-touch button you want to use for the number.

If a number is already registered for this One-touch Speed Dialing button, the LCD displays the number.



03=

5 Enter the number (up to 50 digits) using the numeric buttons.

See Entering a number, p. 33.
Correct errors by pressing [CLEAR] and re-entering the number.



03= 1234
5678

6 Press [START/COPY] to register the number.
 Wait a second for 1-TOUCH SPD NAME to appear,
 followed by 03=_.



DATA ENTRY OK

Tab.

1-TOUCH SPD NAME

03=_

7 Enter the party's name (up to 16 characters) using
 the numeric buttons.
 See Entering a name, p. 34.
 Correct errors by pressing [CLEAR] and re-entering
 the name.



03=CANON

8 Press [START/COPY] to register the name.



DATA ENTRY OK

Tab.

04=

9 To assign additional One-touch Speed Dialing
 numbers, start from step 4 . To finish, press [STOP].



NOTE Applying the faceplate

For quick reference, write the names for the
 One-touch Speed Dialing numbers you
 register on the faceplate and attach it ove
 One-touch buttons. Fit the 4 tabs of the
 faceplate into the corresponding slots aro
 the One-touch button area. See Attaching
 components, p. 5.

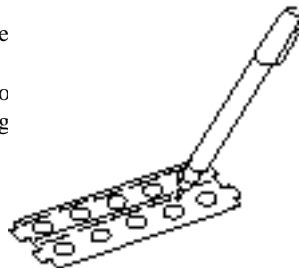

Registering Coded Speed Dialing numbers and names

To dial a fax number at the press of three buttons, use Coded Speed Dialing. Each two-digit (01-20) Coded Speed Dialing number can contain a fax number. You can register up to 20 locations with each number containing up to 50 digits. You can also register the name of the party (up to 16 characters); the name appears on the printout of the Coded Speed Dialing list. See Coded Speed Dialing list, p. 81.

- 1** Press [FUNCTION].
Wait a second for TEL REGISTRATION to appear.



SELECT MENU

TEL

TEL REGISTRATION

- 2** Press [START/COPY].



1-TOUCH DIAL

- 3** Use [←] or [→] to select CODED DIAL.
Press [START/COPY].

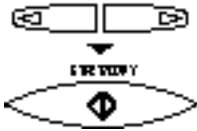

CODED DIAL

*01=

- 4** Use [←] or [→] to select the two-digit code you want to assign to the number.



*15=

- 5** Enter the party's number (up to 50 digits) and name the same way you registered them for One-touch Speed Dialing.
See steps 4 to 8 of registering One-touch Speed Dialing. (See Registering One-touch Speed Dialing numbers and names, p. 39.)

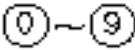

*15= 1234 5678

- 6** To assign additional Coded Speed Dialing numbers, start from step 4. To finish, press [STOP].



3

HANDLING DOCUMENTS

3

Preparing documents	44
Types of documents you can scan	44
Loading the document	45
Setting the resolution and density	47

Preparing documents

Types of documents you can scan _____

n Size

The FAXPHONE can scan standard letter, legal or A4 size documents.

n Thickness

Each sheet of the document should be of the same thickness and between 0.003 inch and 0.005 inch (0.08 mm - 0.13 mm) thick with a paper weight between 20 to 24 lbs (75 to 90 g/m²).

n Effective image size



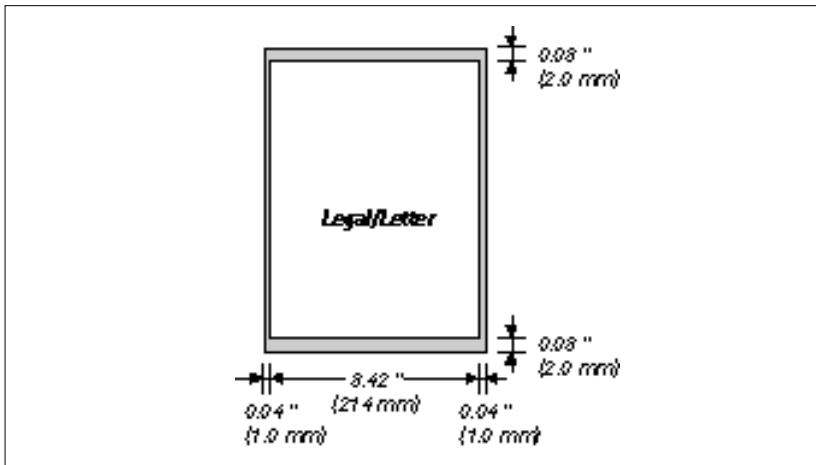



The actual scanned image size for the FAXPHONE is shown below.



The 0.04 inch (1.0 mm) margin on either side of the sheet and the 0.08 inch (2.0 mm) margin on the top and bottom are not picked up by the scanner.

NOTE **Problem Documents**

Do not attempt to feed the following types of documents into the FAXPHONE:

 wrinkled or creased paper	 curled or rolled paper	 torn paper
 carbon paper or carbon-backed paper	 coated paper or glossy paper	 onion skin or thin paper
 envelopes		

- Remove all staples, paper clips and the like before feeding the document.
- Make sure any glue, ink or correction fluid on the paper is completely dry before feeding the document.
- Make a photocopy of any document that will not feed into the FAXPHONE so that you can then feed the copy.

Loading the document

- 1** For a multipage document, tap the document on a flat surface to even the stack.

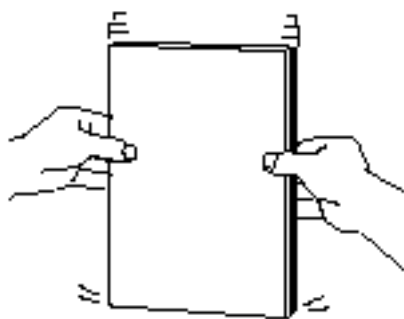

You can load up to 20 letter size, 10 legal size or 20 A4 size sheets at a time into the Automatic Document Feeder (ADF).

- 3** Adjust the right paper guide to the width of the document.



For legal-size documents, flip the extension tray open to accommodate the document.

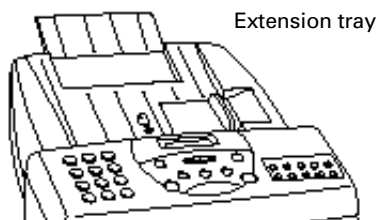

- 2** Insert the document face-down and head first into the Automatic Document Feeder until you hear a beep.

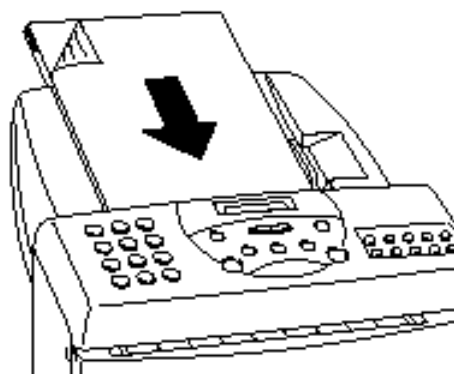

The FAXPHONE automatically feeds the pages one by one from the bottom.

If a page jams or stops while feeding, see Clearing document jams p. 58.

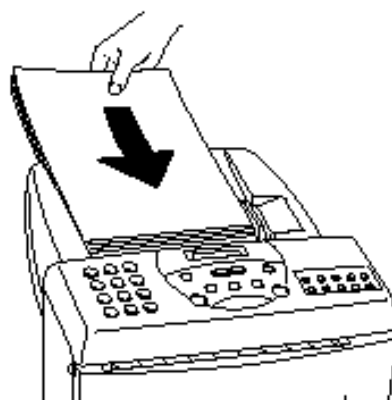

If you are experiencing difficulty feeding multipage documents, slant the edges of the stack and insert the document into the Automatic Document Feeder (ADF).

n Adding pages to the document

You can load up to 20 letter size, 10 legal size or 20 A4 size sheets at a time into the Automatic Document Feeder.

For longer documents, wait until the twentieth sheet has started feeding, then load 20 more sheets (10 for legal size).

If you want to add pages while the FAXPHONE is sending a document, insert the first new page so it overlaps the last page by about 3/4 inch (2 cm).

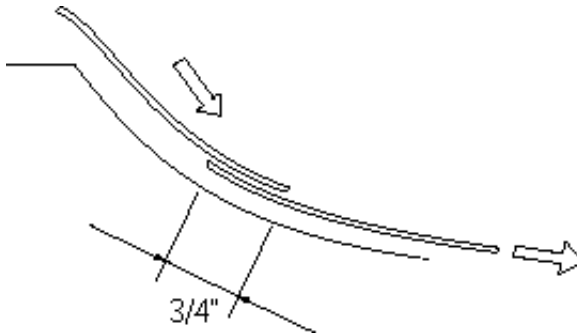

Wait until the last page is being fed into the FAXPHONE before you add new pages.

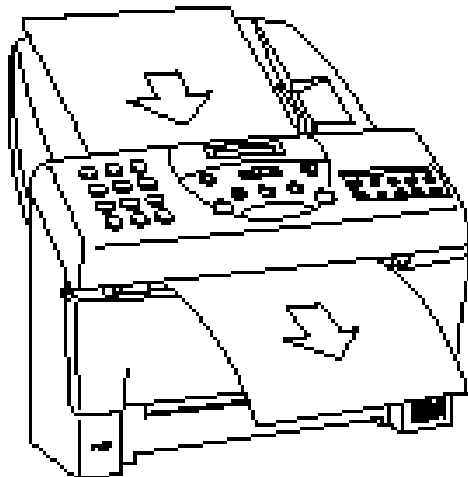

Setting the resolution and density

You can control the resolution and density of the fax reproduction when sending or copying documents.

n What is resolution?

Resolution defines the quality of the document reproduction. STANDARD is enough for most text documents. Documents with very fine print should be set to FINE. Documents with photographs should be set to PHOTO.

n Setting the resolution

To set the resolution, you first have to load the document (See p. 45).

z STANDARD

Press [RESOLUTION] until STANDARD appears.

Standard resolution is 203 dpi × 98 dpi.

When copying, even if you set STANDARD, the document will automatically be scanned in FINE mode.

z FINE

Press [RESOLUTION] until FINE appears.

Fine resolution is 203 dpi × 196 dpi.

z PHOTO

To scan documents that contain photos, use the PHOTO setting. With this setting, areas of the document that contain photos are automatically scanned with 64 levels of gray, rather than just 2 levels, black and white. Photo resolution is 203 dpi × 196 dpi. This results in a much better reproduction of the photograph.

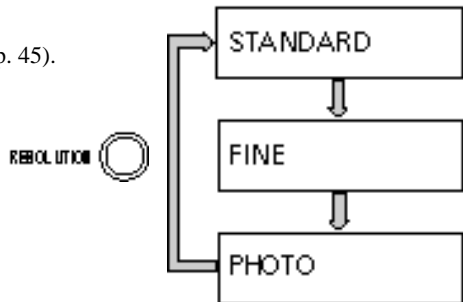

n Density control

You can adjust the scanning density by changing DENSITY CONTROL in the USER SETTINGS (See p. 75). For light originals choose the DARKER setting. For dark originals choose the LIGHTER setting.

4







MAKING COPIES

4

Copying documents 50

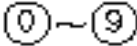
Copying documents

One of the convenient features of the FAXPHONE is its ability to make high quality copies. You can make up to 99 copies of one document at a time.

- 1 Feed the document face-down into the Automatic Document Feeder (ADF).**
See Loading the document, p. 45.
You can select the density. See p. 47.
You can select FINE or PHOTO for the resolution.
(If you set the resolution to STANDARD, your document will automatically be copied in FINE mode.) See p. 47.

- 2 Press [START/COPY].**
To make a single copy, go directly to step 4.

- 3 Enter the number of copies (up to 99) using the numeric buttons.**
To make a correction to the number of copies, press [CLEAR] and re-enter the number.

- 4 Press [START/COPY].**
To stop copying anytime, press [STOP]. Then you may need to lift the operation panel to remove the document. See Clearing document jams, p. 58.



NOTE
f MEMORY FULL displays on the LCD
If MEMORY FULL displays on the LCD while making multiple copies of a document, do not use the multiple copy feature for copying the document. Make single copies of the document instead (as many times as required).

5

SENDING FAXES

5

Preparing to send a document	52
Sending methods	52
Dialing methods	52
Sending documents	53
Direct Sending	53
Manual Sending	53
Automatic Dialing	54
Memory Sending	55
Canceling Sending	56
Redialing	56
Messages displayed during sending	57
Clearing document jams (ejecting a document from the ADF)	58
Delayed Sending	59
Sending other documents while the FAXPHONE is set for Delayed Sending	60
Canceling Delayed Sending	61
Sequential broadcasting	62
Sending a document to more than one location	62

Preparing to send a document

Before you send a document please refer to:

Z Types of documents you can scan, p. 44.

Z Loading the document, p. 45.

Z Adding pages to the document, p. 46.

Z Setting the resolution and density, p. 47.

Sending methods

n **Direct Sending (See p. 53)**

If your document has a large number of pages, you may sometimes get a MEMORY FULL error. To avoid this, use Direct Sending.

To send directly, load the document, dial the fax number and press [START/COPY].

n **Manual Sending (See p. 53)**

If you would like to speak with the other party before sending a fax to them, use Manual Sending. When sending manually, you dial, converse normally and then press [START/COPY] to begin sending.

For manual sending, you need to have an extension phone connected.

n **Memory Sending (See p. 55)**

If you do not want to wait for your document to be scanned page by page during sending (Direct Sending), use Memory Sending. Memory Sending scans the document into memory, then dials and sends the stored image, letting you take away the original immediately after scanning.

Dialing methods

There are several methods of dialing the receiving party's number, depending on how your FAXPHONE is set up.

Manual Dialing: Dial the recipient's fax number using the numeric buttons.

One-touch Speed Dialing: Dial a recipient's fax number that has been assigned to a One-touch Speed Dialing button by simply pressing the corresponding One-touch Speed Dialing button. (See p. 54)

Coded Speed Dialing: Dial a recipient's fax number that has been assigned to a Coded Speed Dialing code by pressing [CODED DIAL] and the 2-digit code assigned to the number. (See p. 54)

Sending documents

Direct Sending

To scan and transmit a document one page at a time without storing it in memory first, follow the steps below. This procedure is called "Direct sending".

Use Direct Sending if you want to visually confirm that the FAXPHONE scans the document. Each page is scanned as it is sent.

1 Feed the document face-down into the Automatic Document Feeder (ADF).

See Loading the document, p. 45.

You can set the resolution and density. See p. 47.

STANDARD

2 Dial the other party's fax number.

Use one of the dialing methods described earlier in this chapter (see p. 52).

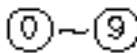

TEL= 3456 7890

3 Press [START/COPY].

The FAXPHONE begins sending the document.



Manual Sending

If you would like to first speak with the person you are sending the fax to, use Manual Sending. You need to connect an extension phone to the FAXPHONE for Manual Sending.

1 Feed the document face-down into the Automatic Document Feeder (ADF).

See Loading the document, p. 45.

You can set the resolution and density. See p. 47.

STANDARD

2 Pick up the handset of the connected extension phone or press [HOOK] and dial the other party's fax number.

zUse one of the dialing methods described earlier in this chapter. See p. 52.

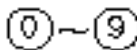

TEL= 3456 7890

3 If a person answers, converse normally, then ask them to press the start button on their fax. Press [START/COPY] and hang up.

If you hear a high pitch tone, press [START/COPY] and hang up.



- z The FAXPHONE beeps once to indicate that the document has been sent successfully.

TRANSMITTING OK

- z If an error occurs during sending, the FAXPHONE beeps intermittently for a few seconds. If this happens, try sending the fax again.
- z The FAXPHONE automatically redials if the receiving fax does not answer or if the line is busy. (You can specify the number of times it redials; see AUTO REDIAL in TX SETTINGS, p. 76.)
- z To stop sending before the fax is finished, press [STOP]. Then you may need to lift the operation panel to remove the document, see Clearing document jams, p. 58.
- z If an error message appears on the LCD, correct the error and then press [STOP]. Refer to Error codes, messages and solutions, p. 98.

Automatic Dialing

n Sending a document using One-touch Speed Dialing or Coded Speed Dialing

After registering the One-touch numbers or Coded Speed Dialing numbers you can send documents as follows:

1 Feed the document face-down into the Automatic Document Feeder (ADF).

See Loading the document, p. 45.

You can set the resolution and the density, p. 47.

FINE

2 Press the One-touch Speed dialing button assigned to the number to which you wish to fax.

01 ~ 10

CANON FAX

or

Press [CODED DIAL] and enter the appropriate two-digit Coded Speed Dialing code.

CODED DIAL

12345678999

Wait a second for the number to appear after the name of the number.

- z If no number is registered for the button or code you pressed, the LCD display shows the NO TEL# message. Make sure you pressed the correct button or entered the correct code and that the number you want to dial is registered correctly.

0 ~ 9

CANON CANADA

- z If you make a mistake, press [STOP]. Then press the correct One-Touch Speed Dialing button or press [CODED DIAL] and re-enter the code.

2345678999

- z If an error message appears on the LCD, correct the error and press [STOP]. If necessary, refer to Frequently Asked Questions, p. 92.

Memory Sending

You can use Memory Sending to send your document. With Memory Sending, the FAXPHONE quickly scans the document into memory. Then, after it dials the receiving party, it sends the document from memory. This means you do not have to wait for the FAXPHONE to finish sending before you can retrieve your original document.

You can send up to 21 letter-size pages (based on the CCITT #1 Chart—standard resolution) at one time with Memory Sending.

z If the memory becomes full while scanning your document, MEMORY FULL is displayed on the LCD. If this should happen, you may need to open the operation panel to remove the document. See Clearing document jams, p. 58. Then try dividing the document into several sections and sending each section individually, or send using Direct Sending or Manual Sending. See p. 53.

The definition of a letter-size page for memory storage purposes is based on the CCITT #1 Chart.

1 Feed the document face-down into the Automatic Document Feeder (ADF).

See Loading the document, p. 45.
You can set the resolution and density. See p. 47.

STANDARD

2 Press [FUNCTION].

Wait a second for TEL REGISTRATION to appear.



SELECT MENU



TEL REGISTRATION

**3 Press [SEND OPTIONS].
Press [START/COPY].**



MEMORY TX



TEL =

4 Dial the other party's fax number.

Use one of the dialing methods described earlier in this chapter (see p. 52).



TEL= 9876543333

5 Press [START/COPY].

The FAXPHONE scans the document into memory and begins sending.



TX/RX NO. XXXX



MEMORY INPUT P01

Canceling Sending

To stop sending before the fax is finished, press [STOP]. Then you may need to open the operation panel to remove the document, see Clearing document jams, p. 58.

Redialing

n **Manual**

To start dialing again, just press [REDIAL/PAUSE]. (When you press [REDIAL/PAUSE], the previous number dialed with the numeric buttons is redialed.)

n **Automatic**

The FAXPHONE automatically redials twice after the first attempt at sending fails (eg. the line was busy).

The time between redials is two minutes.

You can change the number of redials and the time between redials by changing the TX SETTINGS (see p. 76).

If the FAXPHONE fails to get through after the second redial, the FAXPHONE beeps.

The LCD displays REDIALING while the FAXPHONE is in the redialing process.



REDIALING

n **To cancel automatic redialing**

You can cancel automatic redialing anytime by pressing the [STOP] button.

However, when memory is used during sending (including Delayed Sending and Sequential Broadcasting), you cannot cancel redialing while REDIALING is displayed on the LCD. In this case, wait until dialing begins, then press [STOP] to cancel redialing.

Messages displayed during sending _____

When your FAXPHONE sends a document, the following messages are displayed as the call progresses.

The FAXPHONE is dialing the recipient's phone number.

DIALING

The recipient's phone is ringing.

CALLING

The display tells you when transmission begins.

TRANSMIT

After a few moments the display begins changing every 2 seconds. (With Memory Sending, only the other party's number is displayed.)



<XXX



PXX

or TRANSMIT PXX If ECM is off, "TRANSMIT PXX" is displayed.

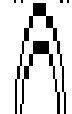

Other party's number

3456

Other party's name

(For some models, the other party's name may also be displayed.)



INC.

After the transmission is completed, the FAXPHONE beeps once and the display tells you when transmission is ended.

TRANSMITTING OK

Clearing document jams (ejecting a document from the ADF)

n Removing a jammed sheet

1 Hold down the FAXPHONE with your left hand, and gently pull the operation panel with your right hand.



z Do not push the LCD display.

2 While holding the operation panel open, pull the sheet out from the top or bottom.

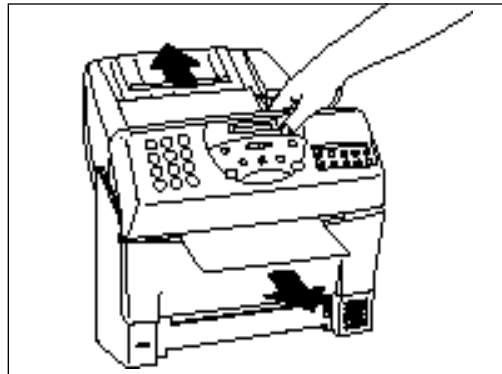

3 Gently push the operation panel shut until it clicks.

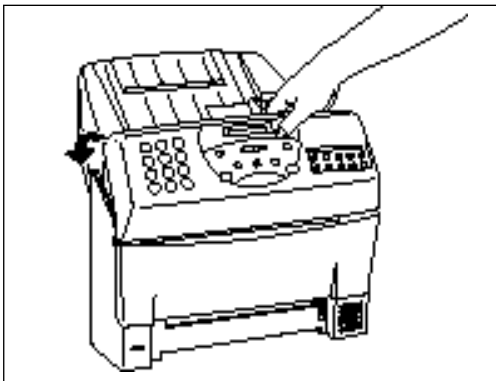

Delayed Sending

Your FAXPHONE can send documents automatically at a preset time. This allows you to take advantage of lower late night long-distance rates offered by some telephone companies.

You can use any dialing method to dial fax numbers to send a document to up to 31 destinations at a preset time. See Sending a document to more than one location for details, p. 62.

1 Feed the document face-down into the Automatic Document Feeder (ADF).

See Loading the document, p. 45.

You can set the resolution and density. See p. 47.

DOCUMENT READY

2 Press [FUNCTION].

Wait a second for TEL REGISTRATION to appear.



SELECT MENU



TEL REGISTRATION

3 Press [SEND OPTIONS].



MEMORY TX

4 Use [←] or [→] to select DELAYED TX.



DELAYED TX



TX/RX NO. XXXX



SET TIME XX:XX

Press [START/COPY].

Wait a second for SET TIME to appear.

5 Enter the desired sending time (24-hour clock) using the numeric buttons.

z Set the time using the 24-hour clock system.

Precede single digits with a zero.

Example:

07:30 = 7:30 a.m.

17:05 = 5:05 p.m.

z Press [CLEAR] if you need to re-enter the time.

z You can also use [←] or [→] to move the cursor.



SET TIME 23:00

6 Press [START/COPY].



TEL=

7 Dial the other party's fax number.

- z You can enter the other party's fax number using the numeric buttons, One-touch Speed Dialing (see p. 54), or Coded Speed Dialing (see p. 54).
- z If you use the numeric buttons, press [START/COPY] after entering the number to register it before going on to the next number.

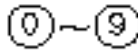

TEL= 3456 7890

8 Press [START/COPY].

The FAXPHONE reads the document into memory.



MEMORY INPUT P01

After reading in the document, the FAXPHONE displays **TIMER** on the LCD. When the set time comes, the FAXPHONE dials and sends the document.

TIMER

Sending other documents while the FAXPHONE is set for Delayed Sending

You can send, receive, and copy other documents even when the FAXPHONE is set for sending at a preset time.

The FAXPHONE can only register one preset sending operation at a time.

To send or copy other documents after setting the FAXPHONE for Delayed Sending, simply send or copy using any other sending procedure in this manual.





Delayed sequential broadcasting

Delayed sequential broadcasting is applicable for sending one document to more than one location at a later time when multiple fax numbers are dialed. See p. 62.

Canceling Delayed Sending



- 1** Press [FUNCTION].
Wait a second for TEL REGISTRATION to appear.

	SELECT MENU
	TEL REGISTRATION

- 2** Press [SEND OPTIONS].

	MEMORY TX
---	-----------

- 3** Use [←] or [→] to select DELAYED TX.
Press [START/COPY].
Wait a second for SET TIME to appear.

	DELAYED TX
	DELAYED TX
	SET TIME 23:00

- 4** Press [CLEAR].

	SET TIME _ :
---	------------------

- 5** Press [START/COPY].
Delayed Sending cancels.

	ERASING END
---	-------------

Sequential broadcasting

Sending a document to more than one location

Sequential broadcasting sends one document to more than one location.

You can send to a total of 31 destinations as follows:

- One-touch Speed Dialing = 10 destinations
- Coded Speed Dialing = 20 destinations
- Regular dialing (Numeric buttons dialing) = 1 destination

You can enter the One-touch Speed Dialing and Coded Speed Dialing destinations in any order. You simply press the One-touch Speed Dialing button, or press [CODED DIAL] followed by the two-digit code (with the numeric buttons).

You can also include one destination using Regular dialing. Remember that when using regular dialing, you must press [START/COPY] after entering the number.

You can send up to 21 letter-size pages (based on the CCITT#1 Chart—standard resolution).

1 Feed the document face-down into the Automatic Document Feeder (ADF).

See Loading the document, p. 45.

You can set the resolution and density. See p. 47.



STANDARD

2 Dial the other party's fax number.

- z You can send to up to 31 destinations.
- z Simply enter the numbers one after the other: press the desired One-touch Speed Dialing button or press [CODED DIAL] followed by the two-digit code (with the numeric buttons).
- z You can enter only one number directly with the numeric buttons using regular dialing. Remember to press [START/COPY] after entering the number.
- z You can also press [REDIAL/PAUSE] to redial the last number dialed with the numeric buttons.
- z You must press each button within 10 seconds of the preceding one. The FAXPHONE begins the operation approximately 10 seconds after you press the last button.

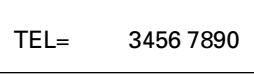
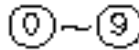

TEL= 3456 7890

3 Press [START/COPY].

- z The FAXPHONE reads the document into memory and begins sending. Between transmissions, MULTI TRANS ON displays on the LCD.
- z To cancel a transmission, press [STOP] during dialing or transmission. All transmissions in the sequence are canceled.

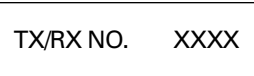

TX/RX NO. XXXX



MEMORY INPUT P01

6

RECEIVING FAXES

Receiving documents	64
Receiving documents in Manual Mode	64
Receiving documents in Fax Only Mode	65
Receiving documents in Fax/Tel Mode	65
Receiving documents in Ans. Machine Mode	66
Receiving documents in memory	67
Printing documents in memory	68
Receiving while registering, copying or printing	68

Receiving documents

Receiving documents in Manual Mode

You may want to set your FAXPHONE to Manual Mode if you want to personally monitor every call, whether from a fax machine or a person.

For Manual Mode, you need to have an extension phone connected to your FAXPHONE. See p. 13.

Keep in mind that you cannot use Manual Receiving if a document is in the Automatic Document Feeder (ADF) waiting to be sent.

1 Make sure you have connected an extension phone to your FAXPHONE. See p. 13.

2 Press [RECEIVE MODE] until "Manual Mode" appears on the LCD.



Manual Mode

3 Press [START/COPY].



09/15/97 Manual

4 When the FAXPHONE rings, pick up the handset of the extension phone.



5 If you hear a person's voice, start your conversation. If the caller wants to send a document after talking to you, press [START/COPY] to receive the document.

or

If you hear a slow beep or silence, another fax is trying to send you a document. Press [START/COPY].

Your FAXPHONE begins receiving the document.

z Hang up the handset after the FAXPHONE displays RECEIVE. If you don't hang up, the FAXPHONE beeps intermittently for a few seconds after you receive the document. To turn off the beeping, see OFF HOOK ALARM in the USER SETTINGS, p. 75.

Receiving documents in Fax Only Mode

When the FAXPHONE is set up for a dedicated line, it automatically receives documents whenever a call comes over the fax line.

The FAXPHONE cannot receive automatically if you are making copies, printing reports, or registering information. See p. 68.

- 1 Press [RECEIVE MODE] until "Fax Only Mode" appears on the LCD.

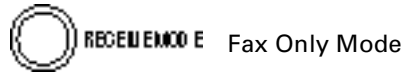

- 2 Press [START/COPY].

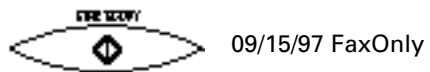

The FAXPHONE assumes all incoming calls are from another fax machine sending a document. It receives the documents automatically.

Receiving documents in Fax/Tel Mode

You can set the FAXPHONE to monitor all incoming calls over the fax/telephone line. When the FAXPHONE receives an incoming call, it checks to see if the call is from another fax machine trying to send a document or from someone wanting to talk to you. You need to have an extension phone connected to your FAXPHONE for this mode. See p. 13.

The FAXPHONE cannot receive automatically if you are making copies, printing reports, or registering information. See p. 68.

- 1 Make sure you have connected an extension phone to your FAXPHONE. See p. 13.

- 2 Press [RECEIVE MODE] until "Fax/Tel Mode" appears on the LCD.

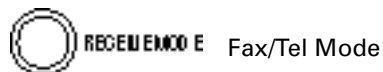

- 3 Press [START/COPY].

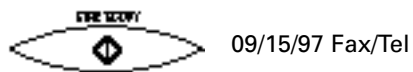

When the FAXPHONE receives a call, it checks to see whether the call is from another fax machine or from a telephone.

- z If the INCOMING RING function is set to OFF, the FAXPHONE does not ring (even if an extension phone is connected) when it receives a call from another fax machine that is trying to send a document. This is so that you are not disturbed when your FAXPHONE is communicating with another fax machine. The FAXPHONE automatically receives the document.
- z In Fax Only Mode or Fax/Tel Mode, if you want the extension phone to ring to make sure that someone is sending you a document, you need to set INCOMING RING to ON and connect an extension phone.
- z If the call is from a person, the FAXPHONE rings to alert you to pick up the extension phone.
- z If you do not pick up the handset of the extension phone within 15 seconds, the FAXPHONE stops ringing. It checks again to make sure the call is not from a fax machine and then hangs up.

NOTE

- z If the paper runs out or if the BJ cartridge runs out of ink, the FAXPHONE receives the rest of the document in memory.
- z To stop receiving before the document is complete, press [STOP].
- z If an error message appears on the LCD, make sure the error is corrected and then press [STOP]. If necessary, see Frequently Asked Questions, p. 92.
- z The FAXPHONE beeps once to show that the document was received. If an error occurs, the FAXPHONE beeps intermittently for a few seconds. If this happens, contact the other party and have them resend the document.

Receiving documents in Ans. Machine Mode _____

Connecting an answering machine to the FAXPHONE allows you to receive not only documents sent from other fax machines, but also messages from people calling when you are out of the office. When the FAXPHONE is connected to an answering machine, all incoming calls are first directed to the answering machine. If the call is from a person, the caller can leave a message. If the call is from a fax machine, your FAXPHONE receives the document automatically. See Connecting the phone line, p. 13 for instructions on how to connect the answering machine to the FAXPHONE.

1 Make sure you have connected an answering machine to your FAXPHONE. See p. 13.

2 Press [RECEIVE MODE] until "Ans. Machine Mode" appears on the LCD display.



Ans. Machine Mode

3 Press [START/COPY].



09/15/97 AnsMode

4 Set your answering machine to answer.

- z The FAXPHONE allows the answering machine to answer, then listens for a fax tone, and switches to receive mode automatically if it detects the tone.
- z If the FAXPHONE runs out of paper or ink, it receives the document and stores it in memory. To print out documents in memory, see pp. 67 and 68.

5 When not in use, turn the answering machine off and switch to Fax/Tel Mode, Manual Mode, or Fax Only Mode using [RECEIVE MODE].

Receiving documents in memory _____

When the FAXPHONE receives documents in memory, you see one of the following messages and you must perform one of the following actions:

CHANGE CARTRIDGE	Cause: You ran out of ink or the BJ cartridge is not set properly. Action: Install a new BJ cartridge or install the BJ cartridge properly. (See Replacing the BJ cartridge, p. 91).
PUT IN CARTRIDGE	Cause: There is no BJ cartridge. Action: Install a BJ cartridge (See Installing the BJ cartridge, p. 10).
CHECK REC PAPER	Cause: You ran out of recording paper. Action: Load paper into the paper tray, then press [STOP] (See Loading the paper, p. 6).
REC. PAPER JAM	Cause: A paper jam has occurred. Action: Clear the jam, then press [STOP] (See Recording paper jams, p. 87).
CHK. FRONT COVER	Cause: The front cover is open. Action: Close the front cover.

- z The FAXPHONE can store up to 15 letter-size pages (based on the CCITT #1 chart).
- z When the memory contains documents, the LCD displays REC'D IN MEMORY alternating with the error message.

Printing documents in memory _____

Except when you run out of paper, the FAXPHONE will automatically print out the contents in memory when you remedy the cause of the problem.

If running out of recording paper caused memory reception, add recording paper and press [STOP] to begin printing the stored page(s).

After printing the page(s) in memory, the FAXPHONE erases the documents from memory.

Receiving while registering, copying or printing _____

If the FAXPHONE rings while you are < entering registration information, > making a copy or fi printing a report manually, lift the handset of the extension phone.

z If you hear a slow beep or nothing at all, someone is trying to send a fax; press [STOP] to cancel < , > or fi . Then, press [START/COPY].

To cancel making a copy to receive a fax, make sure that the document is removed from the Automatic Document Feeder (ADF). Then, press [START/COPY].

z If it is a phone call, you can converse normally.

If you canceled operations < , > or fi , start the procedure again from the beginning after the call.



u are performing operations < , > or fi above, the FAXPHONE will not automatically answer an incoming call, even if the FAXPHONE is in Ans. Machine Mode or Fax/Tel Mode. Follow the above procedure to answer the call.

7

SETTINGS AND ACTIVITY REPORTS

User menu settings	70
Settings	73
How to change a setting	73
Activity reports	79
How to print a report	79
Activity management report	80
One-touch Speed Dialing list	80
Coded Speed Dialing list	81
User's data list	82
Activity report (Sending)	82
Activity report (Receiving)	83
Multi-activity report	83
Memory clear list	84

User menu settings

The following illustrates the user menu settings. The TEL REGISTRATION, USER SETTINGS, REPORT SETTINGS, TX SETTINGS, RX SETTINGS, FAX PRINTER, and SYSTEM SETTINGS menus comprise the items shown on the following pages. Take a few minutes to familiarize yourself with the user menu settings.

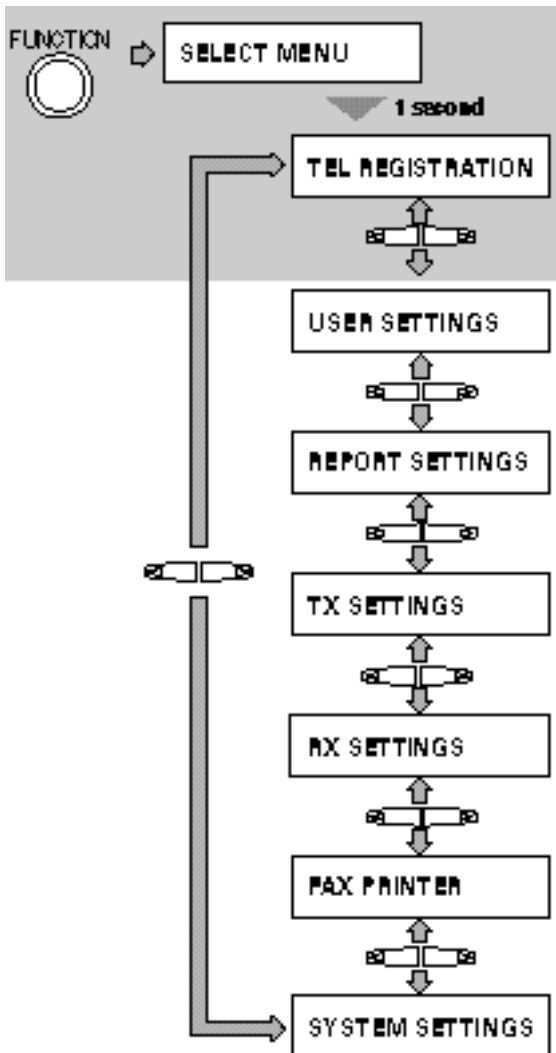



To select the desired menu, complete the procedure as shown in the shaded area. Press [FUNCTION]. SELECT MENU is displayed for approximately 1 second followed by the TEL REGISTRATION menu. Use the arrow buttons to scroll through the menus.

Press  to display the SELECT MENU.

Press  to go to the next menu.

Press  to go to the previous menu.

Press  when you wish to make a change to a setting.

Press  to exit from the user menu settings.

Whenever you make a change to a setting, press [START/COPY] and confirm that DATA ENTRY OK displays on the LCD. Unless this message displays, the setting has not been changed.

When you return to the previous level, press [FUNCTION].

Refer to the following section as a comprehensive guide of the user menu settings.

z The **TEL REGISTRATION** menu contains the following settings.



z The **USER SETTINGS** menu contains the following settings.

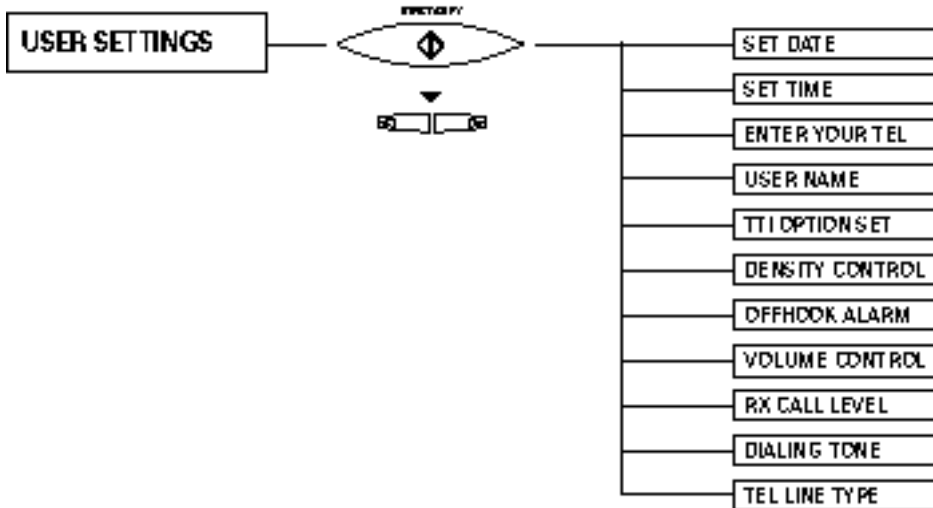

z The **REPORT SETTINGS** menu contains the following settings.

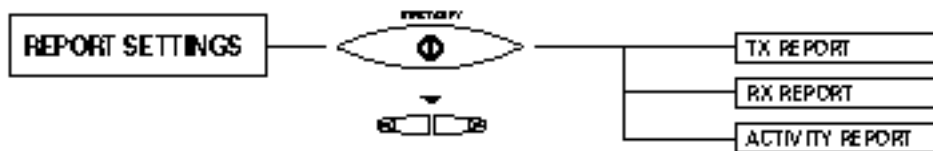

z The **TX SETTINGS** menu contains the following settings.

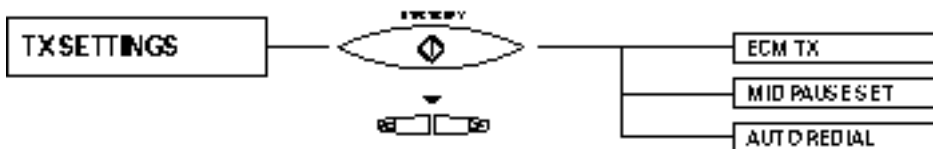

z The **RX SETTINGS** menu contains the following settings.

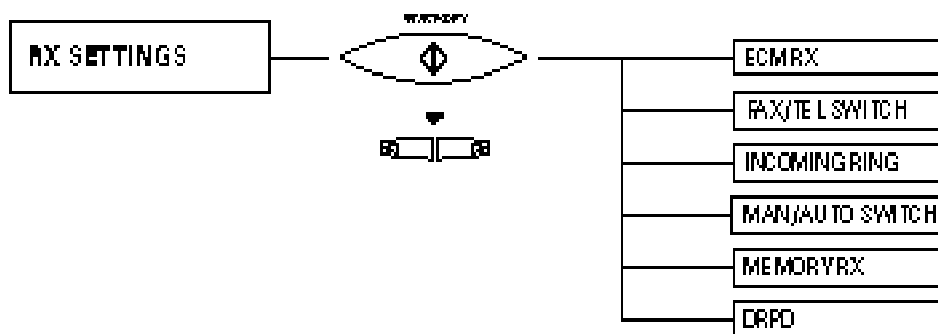

z The **FAX PRINTER** menu contains the following settings.

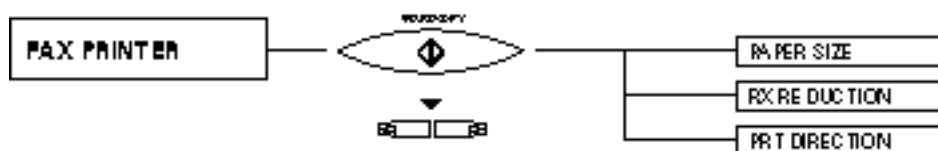

z The **SYSTEM SETTINGS** menu contains the following settings.

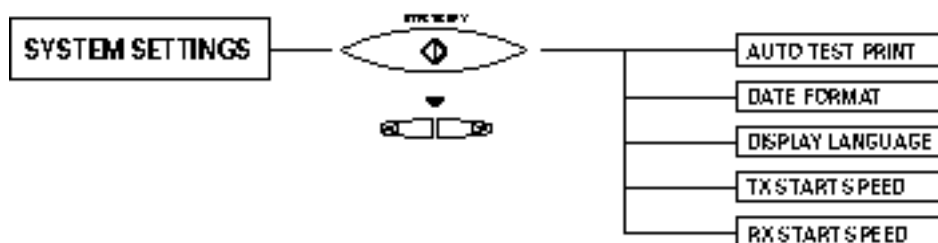

Settings

The FAXPHONE has seven sets of settings that control its various modes of operation. The settings and how to change them are described below.

How to change a setting

There are two basic types of settings, selectable settings and numeric entry settings. The following example shows how to make both types of changes.

Whenever you make a change to a setting, press [START/COPY] and confirm that DATA ENTRY OK displays on the LCD. Unless this message displays, the setting has not been changed.

Example:

Changing INCOMING RING, the number of rings before the FAXPHONE answers.

1

Press [FUNCTION].

Wait a second for TEL REGISTRATION to appear.

FUNCTION



SELECT MENU



TEL REGISTRATION

2

Use [←] or [→] to select RX SETTINGS.



RX SETTINGS

3

Press [START/COPY].



ECM RX

4

Use [←] or [→] to select INCOMING RING.



INCOMING RING

5

Press [START/COPY].



OFF

6 Use [←] or [→] to select ON.



ON

7 Press [START/COPY].



DATA ENTRY OK

RING COUNT



2

8 Use the numeric buttons to enter a new ring count, for example 3.

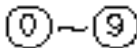

3

9 Press [START/COPY].



DATA ENTRY OK

10 Press [STOP] to finish registration and return to standby mode.



TEL REGISTRATION

Factory settings are in bold. For instructions on how to change a setting, refer to How to change a setting, pp. 73 and 74.

Name	Description	Settings
1-TOUCH DIAL	See Registering One-touch Speed Dialing numbers and names, p. 39.	–
CODED DIAL	See Registering Coded Speed Dialing numbers and names, p. 41.	–

USER SETTINGS

Factory settings are in bold. For instructions on how to change a setting, refer to How to change a setting, pp. 73 and 74.

Name	Description	Settings
SET DATE	Set the date using the numeric buttons.	–
SET TIME	Set the time (24-hour clock) using the numeric buttons.	–
ENTER YOUR TEL	Enter your fax number using the numeric buttons.	–
USER NAME	This is the name that appears at the top of each fax page you send. See Entering a name, p. 34.	–
TTI OPTION SET	This option sets the parameters for the identification header that appears on every page you send.	
TTI POSITION	Select the position of the TTI. OUTSIDE IMAGE: Position the TTI outside the image area. INSIDE IMAGE: Position the TTI inside the image area.	OUTSIDE IMAGE/ INSIDE IMAGE
TTI MARKER	Select the icon for the fax number. FAX: Sets the fax icon. TEL: Sets the telephone icon.	FAX/TEL
DENSITY CONTROL	Set the density of the reproduction. Set to DARKER for light originals and LIGHTER for dark originals.	STANDARD/LIGHTER/ DARKER
OFFHOOK ALARM	Enable/disable the off hook alarm. The alarm alerts you that the telephone is off hook.	ON/OFF
VOLUME CONTROL	Set the audio level of the line monitor, calling signal and alarm.	–
PHONE VOL LEVEL	Set the volume of the line monitor (sound during off hook and dialing conditions)	VOL MIN/ VOL MID/ VOL MAX
CALLING VOLUME	Set the volume of the ring produced when the FAXPHONE detects a voice call during FAX/TEL switchover.	VOL MIN/ VOL MID/ VOL MAX
ALARM VOLUME	Set the volume of the error alarm sound.	VOL MIN/ VOL MID/ VOL MAX
KEYPAD VOLUME	Set the volume of the keypad.	OFF/ VOL MIN/ VOL MID/ VOL MAX
RX CALL LEVEL	Set the ring tone.	LOW/HIGH
DIALING TONE	Turn the dial tone on/off for dialing.	ON/OFF
TEL LINE TYPE	Set the dialing method the FAXPHONE uses to match the type of phone line you have.	TOUCH TONE/ ROTARY PULSE

REPORT SETTINGS

Factory settings are in bold. For instructions on how to change a setting, refer to How to change a setting, pp. 73 and 74.

<i>Name</i>	<i>Description</i>	<i>Settings</i>
TX REPORT	Enable/disable automatic printing of the transmission report. PRINT ERROR ONLY prints only when a transmission error occurs. OUTPUT YES sets the FAXPHONE to print an activity report every time you send a document. OUTPUT NO turns off the activity report feature.	OUTPUT YES/ OUTPUT NO / PRINT ERROR ONLY
TX CONFIRM REP.	When you set TX REPORT to OUTPUT YES or PRINT ERROR ONLY, you can add to the TX report half of the first page of the document that was being sent. This can help remind you which document was being sent. Valid only for memory transmissions.	OUTPUT YES/ OUTPUT NO
RX REPORT	Enable/disable automatic printing of the reception report. PRINT ERROR ONLY prints only when an error occurs during receiving. OUTPUT YES sets the FAXPHONE to print an activity report every time you receive a document. OUTPUT NO turns off the activity report feature.	OUTPUT YES/ OUTPUT NO / PRINT ERROR ONLY
ACTIVITY REPORT	Unless you change the setting, your FAXPHONE is set to print an activity management report for every 20 transactions (sending or receiving).	
AUTO PRINT	Enable/disable automatic printing of the activity report.	OUTPUT YES / OUTPUT NO
TX/RX SEPARATE	Divide the activity management report into sending and receiving transactions.	ON/ OFF

TX SETTINGS

Factory settings are in bold. For instructions on how to change a setting, refer to How to change a setting, pp. 73 and 74.

<i>Name</i>	<i>Description</i>	<i>Settings</i>
ECM TX	Enable/disable error correction during transmission.	ON /OFF
MID PAUSE SET	Set the length of the pause you insert into a dialing sequence.	2 seconds (1 to 15)
AUTO REDIAL	Set the number of times the FAXPHONE will redial a number if it fails to get a response on the first attempt, and the interval between redial attempts.	ON /OFF
REDIAL TIMES	Set the number of retries.	2 times (1 to 10)
REDIAL INTERVAL	Set the period of time between redialings.	2 minutes (1 to 60)

RX SETTINGS

Factory settings are in bold. For instructions on how to change a setting, refer to How to change a setting, pp. 73 and 74.

<i>Name</i>	<i>Description</i>	<i>Settings</i>
ECM RX	Enable/disable error correction during reception.	ON/OFF
FAX/TEL SWITCH	Enable/disable FAX/TEL switchover. When ON, this feature answers calls, and if no fax tone is detected, the FAXPHONE rings to alert you of an incoming call.	
RING START TIME	Set the duration that the FAXPHONE listens for a fax tone before starting to ring.	8 seconds (0 to 30)
F/T RING TIME	Set the length of time the FAXPHONE will ring to alert you of an incoming call.	15 seconds (10 to 45)
F/T SW ACTION	Select the action taken after the F/T RING TIME expires.	DISCONNECT/ RECEIVE
INCOMING RING	When the FAXPHONE is set to Fax Only Mode or Fax/Tel Mode and an extension phone is connected, set the FAXPHONE to ring when it receives a call.	ON/OFF
RING COUNT	Set the number of incoming rings before the FAXPHONE answers.	2 times (1 to 99)
MAN/AUTO SWITCH	Determine if the FAXPHONE switches to document receive mode after the FAXPHONE rings for a specified time when the FAXPHONE is in the manual receive mode.	ON/OFF
RING TIME	Set the amount of time the FAXPHONE will ring before switching to document receive mode.	10 seconds (1 to 99)
MEMORY RX	Turn on/off memory receiving of a document.	ON/OFF
DRPD	Enable/disable the Distinctive Ring Pattern Detection (DRPD) feature and assign a setting mode to each ring pattern. See p. 22.	ON/OFF
NORMAL RING		TEL-FAX-FAX/TEL SWITCH
DOUBLE RING		TEL-FAX-FAX/TEL SWITCH
SHORT-SHORT-LONG		TEL-FAX-FAX/TEL SWITCH
SHORT-LONG-SHORT		TEL-FAX-FAX/TEL SWITCH
OTHER RING TYPE		TEL-FAX-FAX/TEL SWITCH

FAX PRINTER

Factory settings are in bold. For instructions on how to change a setting, refer to How to change a setting, pp. 73 and 74.

<i>Name</i>	<i>Description</i>	<i>Settings</i>
PAPER SIZE	Select the size of the loaded fax paper.	LTR/A4/LEGAL
RX REDUCTION	Select the amount of reduction for received faxes.	ON/OFF
REDUCTION RATE	Set the reduction factor in percent.	STANDARD/A4->LTR/ LGL->LTR
SEL. REDUCE DIR	Select reduction in width only or both width and height.	VERTICAL ONLY/HORIZ & VERTICAL
PRT DIRECTION	Select between unidirectional and bi-directional printing.	BI-DIRECTION PRT/ PRT ONE DIRECT.

SYSTEM SETTINGS

Factory settings are in bold. For instructions on how to change a setting, refer to How to change a setting, pp. 73 and 74.

<i>Name</i>	<i>Description</i>	<i>Settings</i>
AUTO TEST PRINT	Enable/disable auto test printing whenever the BJ cartridge is replaced.	ON/OFF
DATE FORMAT	Set the date format.	MM/DD/YY DD/MM 'YY 'YY MM/DD
DISPLAY LANGUAGE	Set the language of the LCD messages.	ENGLISH/FRENCH/ SPANISH
TX START SPEED	Set the speed at which the FAXPHONE starts transmitting. Set this to a lower speed if you have difficulties connecting over long distance or noisy lines.	14400bps/9600bps/ 7200bps/4800bps
RX START SPEED	Set the speed at which the FAXPHONE starts receiving. Set this to a lower speed if you have difficulties connecting over long distance or noisy lines.	9600bps/7200bps/ 4800bps

Activity reports

Your FAXPHONE keeps track of most of its sending and receiving operations. These operations can be printed out in the form of activity reports that can help you confirm the dates and times of facsimile transmissions and whether or not each transaction was successful.

How to print a report

Depending on the type of report, you can have the FAXPHONE print the report automatically, or you can print it directly. See REPORT SETTINGS (p. 76) on how and when reports are printed automatically. The FAXPHONE prints the Send report, Receive report, and Multi activity report automatically only.

You'll find a sample of each report below.

1 Press [FUNCTION].



2 Press [REPORT].



3 Use [←] or [→] to display the type of report you want to print.

^t Press [START/COPY].

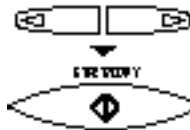

ACTIVITY REPORT

1-TOUCH SPD LIST

CODED SPD LIST

USER'S DATA LIST

Activity management report

Summarizes the information for the sending and receiving activities of your FAXPHONE after 20 transactions. For automatic printing see ACTIVITY REPORT in REPORT SETTINGS, p. 76.

```

12/01/97 10:12 FAX 221 +99 ffff          CANNON/CC#1          P01

*****
**** ACTIVITY REPORT ****
*****

START TIME  CONNECTION TEL  CONNECTION ID  NO.  MODE  PAGE#  RESULT
12/01/11* *  2 1290002  CANNON HONKONG 0017  TRANSMISSION  1  OK 00:21
11* *  212 220 +700  CANNON INC. 0019  TRANSMISSION  1  OK 00:47
12* *  0227+02111  CANNON TOKYO 0018  RECEPTION  1  OK 00:28
12* *  221 220 +700  CANNON INC. 0019  RECEPTION  1  HQ 00:01
                                0# 011
12* *  2+0 09# 1111  DERICHA 0021  TRANSMISSION  1  HQ 00:21
                                0#010
                                Error Code: See Error
                                Codes messages and
                                solutions, p. 98.

12* *  27+02111  CANNON TOKYO 0022  TRANSMISSION  1  OK 00:21
12* *  2 +0+9  CANNON ITALIA 0022
                                [STOP] was pressed during
                                transaction.
                                The number of the page with an
                                error.
                                EOP
  
```

If marked with an asterisk, has already been printed out.

Transaction number

The number of the page with an error.

- z The FAXPHONE prints sending and receiving transactions together in the same report. You can also set the FAXPHONE to print sending and receiving transactions separately. See TX/RX SEPARATE, p. 76.

One-touch Speed Dialing list

Lists the information for each of the registered One-touch Speed Dialing numbers.

```

12/01/97 10:12 FAX 221 +99 ffff          CANNON/CC#1          P01

*****
**** 1-TOUCH SPD LIST ****
*****

# #      CONNECTION TEL      CONNECTION ID
[01] 1 ff2 21f2          CANNON UK
[02] 212 220 +700      CANNON INC.
[02] 2 +0+9            CANNON ITALIA
[0+] 2 1290002          CANNON HONKONG
  
```

Coded Speed Dialing list

Lists information for each of the registered Coded Speed Dialing numbers.

```
12/01/97  10:12  FAX: 221 449 1111  CAMOM/CC#1  P01

          *****
          ***** CODED SPD LIST *****
          *****

#D#      CONNECTION TEL      CONNECTION ID

[*01]  249 029 1111          DERIC MAY
[*02]  001 012 4229 1449     CHARLIE PARKER
[*03]  419 464 1004          ABDEL HIRSHAM
[*04]  2220 2944            TECHNO GRAPHICS
```

User's data list

Lists the name and number you registered during setup and a list of all current settings.

```
12/01/97 10:12 FAX: 221 449 1111 CANON FAX P01

*****
***** USER'S DATA LIST *****
*****

USER SETTINGS

USER TEL #      --- 221 449 1111
USER ID        --- CANON USA
TX OPTION SET   ---
TX POSITION      --- OUTSIDE IMAGE
TX MARKER      --- FAX
DENSITY CONTROL --- STANDARD
OFFHOOK ALARM  --- ON
VOLUME CONTROL ---
PHONE VOL LEVEL --- VOL 1
CALLING VOLUME ---
ALARM VOLUME   ---
KEYPAD VOLUME  ---
PC CALL LEVEL  ---
```

Activity report (Sending)

Normally the FAXPHONE does not print an activity report for sending, but you can set the FAXPHONE to print an activity report every time you send a document. See TX REPORT in REPORT SETTINGS, p. 76.

```
12/01/97 10:12 FAX: 221 449 1111 CANON FAX P01

*****
***** 1-CIVITY REPORT *****
*****

TRANSMISSION OK

TRNSC NO.      0002
CONNECTION TEL 1210224499
CONNECTION ID  CANON FAX
START TIME     12/01 10:11
USER TIME      00:29
PAGE#          1
RESULT         OK
```

- z You can set the FAXPHONE to print an activity report only when an error occurs during sending. See TX REPORT in REPORT SETTINGS, p. 76.
- z You can set the FAXPHONE to print the first page of the documents. Valid only for memory transmissions. See TX CONFIRM REP. in REPORT SETTINGS, p. 76.

Activity report (Receiving)

Normally the FAXPHONE does not print an activity report for receiving, but you can set the FAXPHONE to print an activity report every time you receive a document. See RX REPORT in REPORT SETTINGS, p. 76.

```

12/01/97 10:12 FAX 221 +90 1111          CANON/CC#1          P.01

*****
***** ACTIVITY REPORT *****
*****

RX REPORT

TXRC NO.          0020
CONNECTION TEL    0227+92111
CONNECTION ID    CANON TOKYO
START TIME       12/01 12:49
PAGE TIME        00:21
PAGE#            1
RESULT           OK
    
```

z You can set the FAXPHONE to print an activity report only when an error occurs during receiving. See RX REPORT in REPORT SETTINGS, p. 76.

7

Multi-activity report

Lists the result of a Sequential broadcast.

```

12/01/97 10:12 FAX 221 +90 1111          CANON/CC#1          P.01

*****
***** MULTI TXRC REP. *****
*****

TXRC NO.          0020
INCOMPLETE TXRC  [0+] 2 129002          CANON HONGKONG
TRANSACTION OK    [02] 212 220 +100          CANON INC.
ERROR            [02] 2 +049          CANON ITALIA
    
```

z If you set the FAXPHONE to print activity reports (TX REPORT or RX REPORT) and then use Sequential broadcasting, a Multi-activity report will be printed instead of the activity report (Sending). See TX REPORT in REPORT SETTINGS, p. 76.

Memory clear list

The memory clear list summarizes the documents in memory.

```
12/01/97  10:12  FAX 221 +90 1111          C:\HOMECOM          P.01

*****
**** MEMORY CLEAR REPORT ****
*****

TABLE NO.   MODE                CONNECTION TEL      PAGE#   SET TIME   #PART TIME
0012        TRANSMISSION          212 226 +700       2       12/01 22:00
0012        RECEPTION             022f#02111        2       12/01 12:2f
```

z If you experience a power failure, the documents in the FAXPHONE memory will be lost.

After you turn on the FAXPHONE as soon as power is restored, the FAXPHONE will automatically print out a list of documents that were stored in the memory at the time of the power failure.

8

SOLUTIONS TO COMMON PROBLEMS

Paper Jams	86
Automatic Document Feeder (ADF) jams	86
Recording paper jams	87
Periodic care	88
Cleaning the FAXPHONE exterior	88
Cleaning the glass scanning window	88
Cleaning the printer area	89
Cleaning the BJ cartridge print head	90
Replacing the BJ cartridge	91
Frequently Asked Questions	92
TRANSMITTING	92
RECEIVING	93
TELEPHONE	94
COPYING	95
PAPER LOADING PROBLEMS	95
GENERAL	95
Print quality problems	97
Error codes, messages and solutions	98
In case of a power failure	101
During a power failure	101
Specifications	102
Appendix	104
Document sizes	104
What happens when Fax/Tel Mode is selected	105
Glossary	106
Index	110

Paper jams

Automatic Document Feeder (ADF) jams _____

n To remove a jammed document

1 Hold down the FAXPHONE with your left hand, and gently pull the operation panel with your right hand.

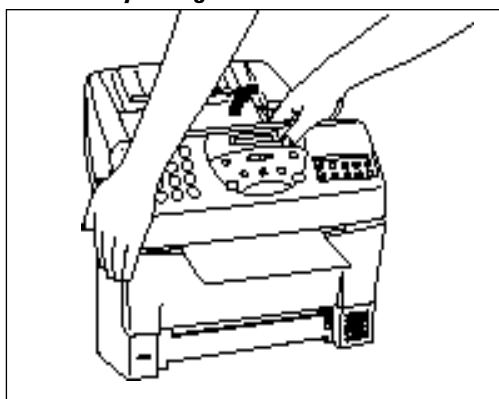

2 While holding the operation panel open, pull the sheet out from the top or bottom.

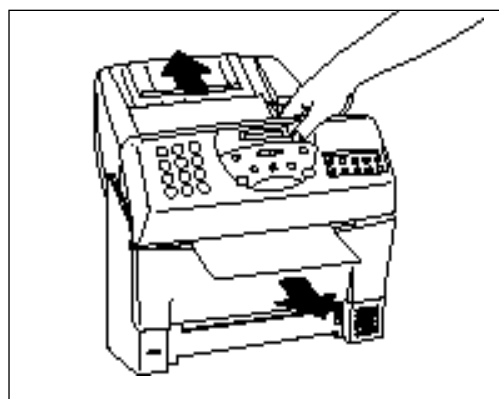

z Do not push the LCD display.

3 Gently push the operation panel shut until it clicks.

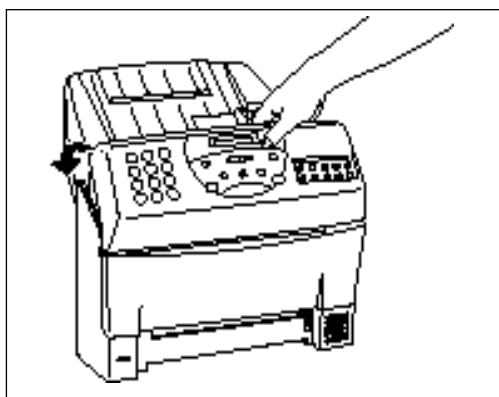

Recording paper jams

n To remove jammed paper

1 Remove the paper tray cover.

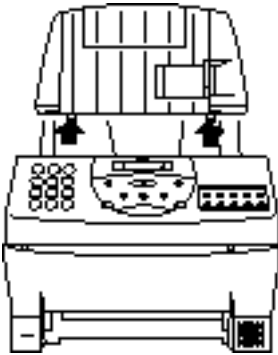

2 Remove the recording paper.

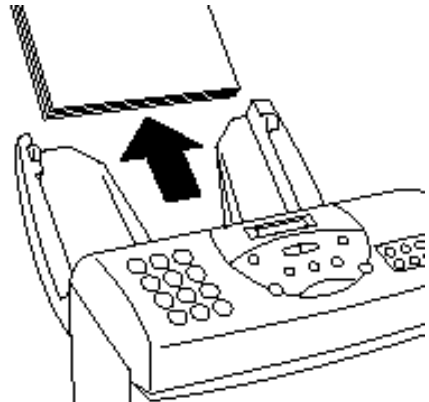

3 Open the front cover.

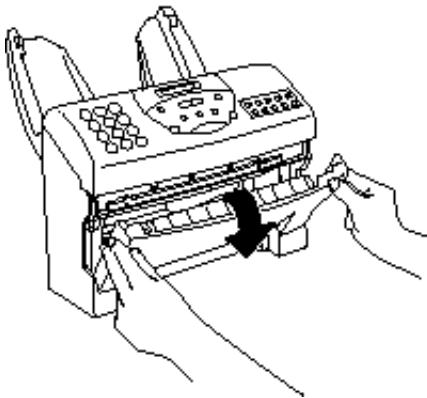

4 Pull the sheet out slowly from the top or bottom.



5 Close the front cover.

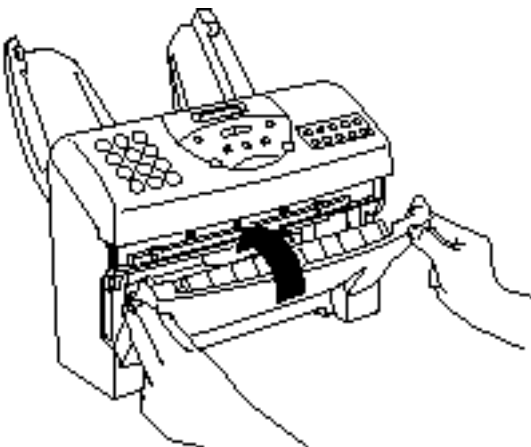

6 Load the paper (see Loading the paper, p. 6), then replace the paper tray cover, and press [STOP].

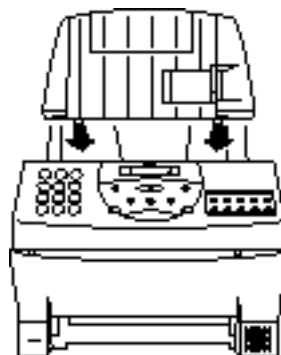

Periodic care

Cleaning the FAXPHONE exterior

To keep the exterior of the FAXPHONE clean, gently wipe the FAXPHONE with a soft cloth lightly moistened with water.

Never use thinner, benzene, alcohol or any other organic solvent, as it may damage the surface of the FAXPHONE.

Cleaning the glass scanning window

The glass scanning window can accumulate dirt with continued use, resulting in spots on faxes and copies.

To clean the glass scanning window

1 Disconnect the power cord.

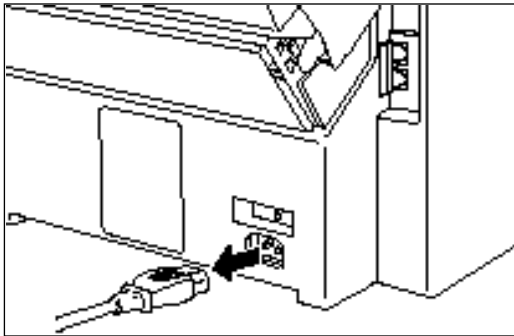

2 Open the front cover.

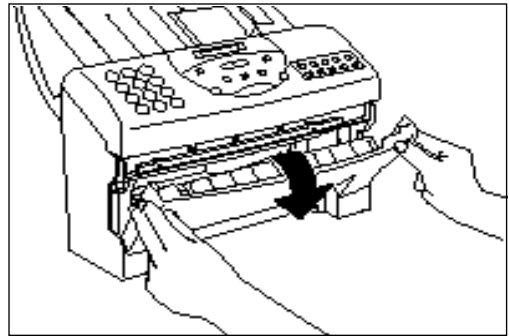

3 Press down on the scanning window assembly and clean the glass window with a dry cotton swab.

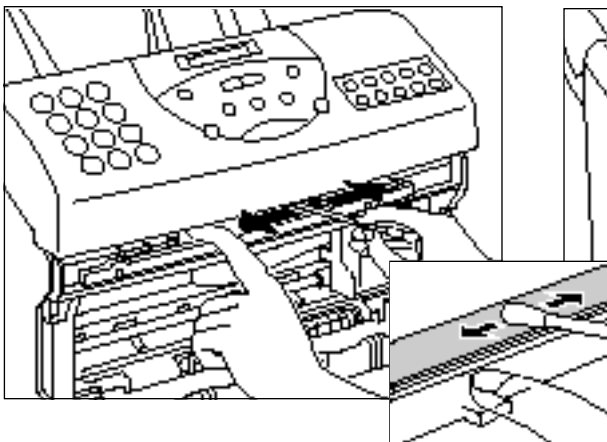

4 Close the front cover.

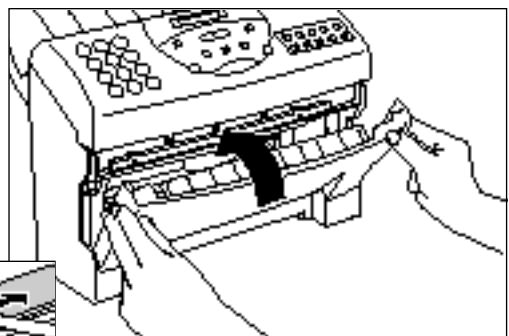

Cleaning the printer area

Clean the printer area regularly to prevent accumulation of paper dust and ink spots.

To clean the printer area

1 Disconnect the power cord.

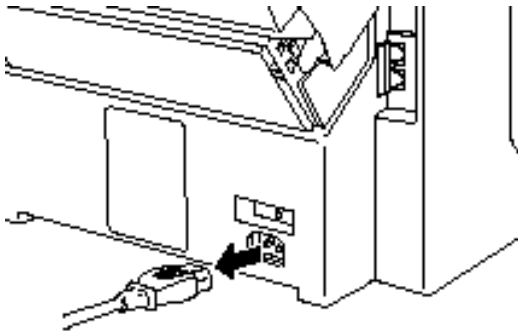

2 Open the front cover.

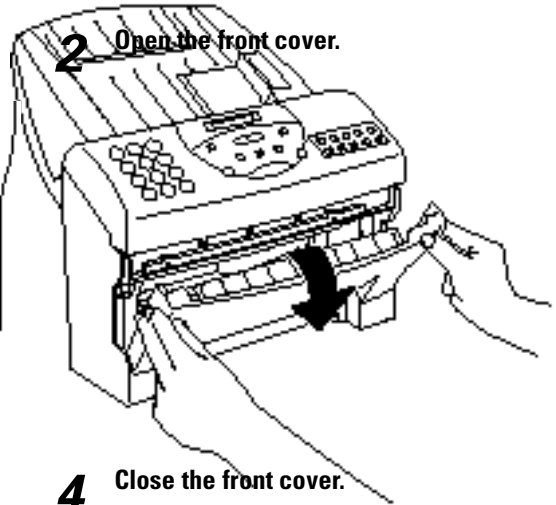

3 Clean the printer area with a soft, dry cloth.

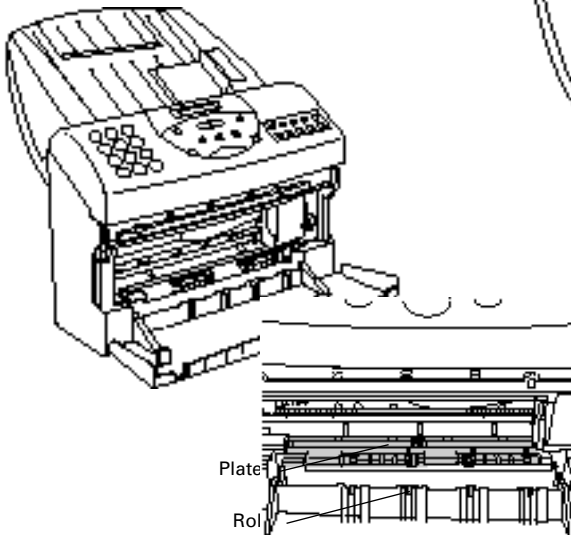

4 Close the front cover.

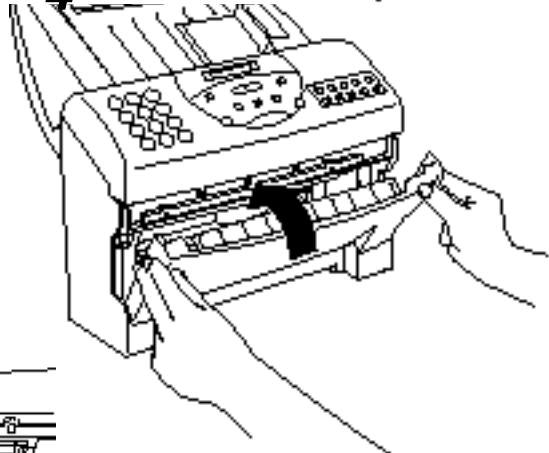

- z Remove any ink mist or paper debris from the interior of the printer using a soft cloth. Clean especially well around the platen area. If the rollers become dirty, you can clean them using a small, soft brush.
- z Never use a solvent, such as thinner or benzene, to clean the printer area.
- z Do not remove the BJ cartridge or attempt to wipe the cartridge print head.

Cleaning the BJ cartridge print head _____

To maintain the best possible print quality, the BJ cartridge print head needs to be cleaned from time to time. If you notice some degradation in the print quality, try cleaning the print head.

Cleaning the print head consumes a small amount of ink. Cleaning too often significantly reduces the amount ink in the cartridge.

1

Press [FUNCTION].

Wait a second for TEL REGISTRATION to appear.

FUNCTION



SELECT MENU



TEL REGISTRATION

2

Press [CLEANING].

CLEANING



HEAD CLEANING

Replacing the BJ cartridge

Replace the BJ cartridge when you see the message CHANGE CARTRIDGE displayed.

- 1** Open the front cover of the FAXPHONE.

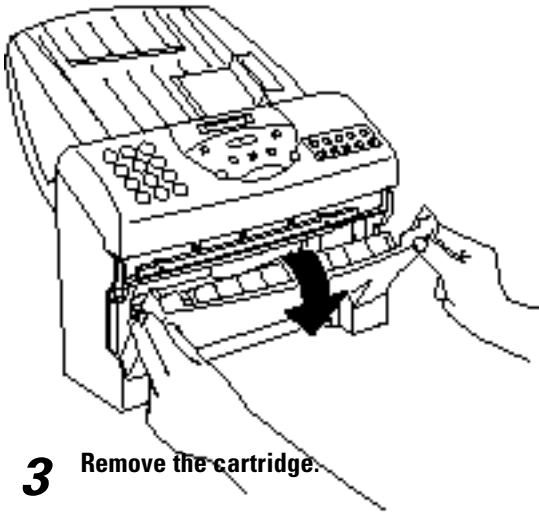

- 2** Raise the green cartridge release lever.

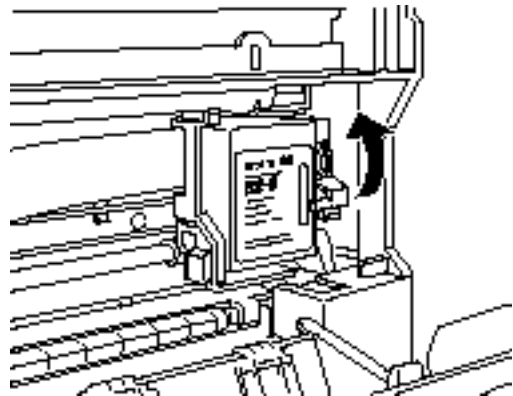

- 3** Remove the cartridge.

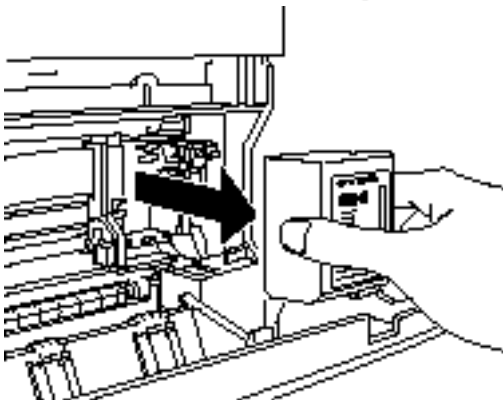

- 4** Insert a new cartridge.
See *Installing the BJ cartridge*, steps 3 to 8, p. 10.

Dispose of the BJ cartridge properly.
You may want to place it in a plastic bag to keep from spilling any residual ink.

Frequently Asked Questions

Refer to this section if you experience trouble operating your FAXPHONE.

TRANSMITTING

o **Cannot send a document?**

- *Is the FAXPHONE set for the type of telephone line in use (pulse/tone)?*
If you have a pulse line, be sure the FAXPHONE is set for pulse dialing. If you are not sure about what type of line you have, contact your local telephone company. See p. 14.
- *Has the document been fed correctly into the FAXPHONE?*
Remove the document, stack it and feed it into the FAXPHONE correctly. See p. 45.
- *Is the One-touch or Coded Speed Dialing number you used registered for the feature you want to use?*
Check the content of the One-touch or Coded Speed Dialing button and be sure it was registered correctly. See pp. 39 and 41.
- *Is the other party's fax out of paper?*
Call the other party and be sure paper is installed in the other party's fax unit.
- *Are there any other documents being sent from memory?*
Allow time for the current document to finish sending.
- *Can you hear a dial tone when you press [HOOK] or when you lift the handset of the extension phone?*
If you cannot hear a dial tone, make sure the telephone line is connected properly. See p. 13
Print an activity report and check for an error code. See pp. 79 and 98.

o **Are the images you send or copy spotted or dirty?**

- *Is the document scanning glass clean?*
If the scanning glass is dirty, clean it. See p. 88.
- *Is the other party's fax working properly?*
To confirm correct operation of your own FAXPHONE, make a copy. If the copy is clear, the other party's fax may have a problem.
- *Is the document fed correctly into the Automatic Document Feeder (ADF)?*
Remove the document and feed it correctly into the feeder. See p. 45.

o **Cannot send using Error Correction Mode (ECM)?**

- *Does the other party's fax support ECM?*
Some fax units do not support ECM transaction. If the other party's fax does not support ECM transaction, then the document is sent in the normal mode without error checking.
- *Is your FAXPHONE set for ECM sending?*
ECM sending for your FAXPHONE can be turned off and on. Check the current setting. See p. 76.

RECEIVING

o **Cannot receive a document automatically?**

- *Is the FAXPHONE set to receive automatically?*

For the FAXPHONE to receive automatically, the LCD must display “Fax/Tel”, “Fax Only” or “AnsMode”. Press [RECEIVE MODE] to display “Fax/Tel Mode” “Fax Only Mode” or “Ans. Machine Mode” on the operation panel. See pp. 65 and 66.

Make sure you have printed out any document received in memory. See p. 68.

Check the LCD for an error message. See p. 98.

Print an activity report and look for an error code. See pp. 79 and 98.

o **The FAXPHONE won't switch automatically between telephone and fax transmissions.**

- *Is “Fax/Tel” displayed on the LCD?*

For the FAXPHONE to switch automatically between telephone and fax reception, “Fax/Tel” must be displayed on the LCD. Press [RECEIVE MODE] on the operation panel to select “Fax/Tel Mode”. See p. 65.

Make sure you have printed out any documents in memory. See p. 68.

Check the LCD for an error message. See p. 98.

Some fax units cannot send the CNG signal that tells your FAXPHONE the incoming signal is from a fax. In such cases, you will have to receive the document manually.

o **Cannot receive a document manually?**

- *Is an extension phone connected to your FAXPHONE?*

You cannot receive manually unless an extension phone is connected.

- *Is a document fed into the FAXPHONE?*

Remove the document. You cannot receive when there is a document fed into your FAXPHONE.

- *Did you press [START/COPY] after hanging up the handset?*

Always press [START/COPY] before hanging up the handset. Don't press [START/COPY] after you hang up the handset.

o **Print quality poor?**

- *Are you using the correct type of paper?*

Be sure you are using stock paper that meets the paper requirements for this FAXPHONE. See p. 6.

- *Is the fax unit's BJ cartridge out of ink?*

Change the BJ cartridge. See p. 91.

Make a copy on your FAXPHONE. If the image is OK, then your FAXPHONE is operating properly.

Contact the other party and have them check their machine.

o **Cannot receive using Error Correction Mode (ECM)?**

- *Does the other party's fax support ECM?*

Some fax units do not support ECM transmission. If the other party's fax does not support ECM, the document is sent in the normal mode without error checking.

- *Is your FAXPHONE set for ECM receiving?*

ECM receiving can be turned off and on. Check the current setting. See p. 77.

o **Nothing prints?**

- *Did you remove the orange tape from the BJ cartridge before you installed it in the FAXPHONE?*

Be sure to remove the orange tape from the BJ cartridge before you install it in the FAXPHONE. See p. 10.

Make sure the BJ cartridge is installed correctly. See pp. 10 and 11.

Clean the print head several times. See p. 90.

Try another BJ cartridge.

o **Are the images you print blotched or uneven?**

- *Are you using ECM sending/receiving?*

ECM sending/receiving should eliminate such problems. However, if the telephone lines are in poor condition, you may have to try again.

- *How is the quality of the other party's fax?*

Remember, the sending fax usually determines document quality. Be sure the other party's back of top cover and scanning glass are clean.

TELEPHONE

o **Cannot dial?**

- *Is the telephone line connected to the FAXPHONE?*

Be sure the telephone line is correctly connected to the FAXPHONE. See p. 13.

- *Is the FAXPHONE set for the type of telephone line in use (pulse/tone)?*

If you have a pulse line, be sure the FAXPHONE is set for pulse dialing. If you are not sure what type of line you have, contact your local telephone company. See p. 14.

o **Does the phone disconnect while you are talking on the line?**

- *Is "AnsMode" displayed on the LCD?*

If "AnsMode" is displayed on the LCD, press [RECEIVE MODE] to select a different mode. The "Ans. Machine Mode" should only be on when an answering machine is connected, turned on, and ready to take messages from telephone callers.

COPYING

o **Cannot make a copy?**

- *Was the [HOOK] button pressed?*

You cannot make copies if [HOOK] was pressed. Press [HOOK] to release it.

Make sure a document is set in the Automatic Document Feeder (ADF) and the LCD displays DOCUMENT READY.

Print an activity report to ensure the FAXPHONE is working properly.

PAPER LOADING PROBLEMS

o **Multiple sheets feed into the FAXPHONE.**

- Make sure the paper is not sticking together. Fan the paper before loading it into the paper tray. Always fan a stack of paper along the edge that will feed into the FAXPHONE first.
- Make sure the paper tray does not contain too much paper. Remove a few sheets of paper from the paper tray.
- If different paper types are loaded in the paper tray, load just one paper type. See Loading the paper, p. 6.

o **Paper is loaded skewed (Printing is skewed).**

- Make sure the paper is loaded properly in the paper tray: the right side of the paper is aligned against the right side of the paper tray and the paper guide rests against the left side of the paper stack, see Loading the paper, p. 6.

GENERAL

o **Sending and receiving documents too slow?**

- *When sending, is the document mode set to FINE or PHOTO?*

Before sending documents, press [RESOLUTION MODE] until STANDARD appears on the display. Sending will be faster, but the image will not be as clear, and photos will be reproduced in black and white only.

- *Is your FAXPHONE set for ECM sending or receiving?*

Because the fax is constantly checking for errors during transmission, ECM sending and receiving require more time. If the transmission speed appears to be extremely slow, you may be able to speed it up by turning ECM off. See pp. 76 and 77.

o **Cannot get faxes from information services?**

- *Is your FAXPHONE connected to a rotary dial telephone line?*
Press [TONE] to receive faxes from information services that require touch-tone telephone lines for transmission.

o **Nothing shows on the display?**

- *Is the power plug firmly plugged in?*
Check the plug and be sure it is firmly plugged into the socket.
- *Cannot solve the problem?*
Disconnect the power. Wait five seconds and reconnect the power again. Check the other party's fax and be sure that it is compatible with your FAXPHONE. There are some compatibility problems between certain types of faxes.
- *Still cannot solve the problem?*
Call for service.

SHARING A TELEPHONE LINE

o **FAXPHONE continues to ring.**

- If you have only one telephone line, you can set the FAXPHONE to receive both faxes and voice calls. This is called Fax/Tel Mode (see page 17). When you receive a voice call, you must pick up the telephone attached to the FAXPHONE. If you pick up another phone attached to the same line but NOT attached to the unit, the FAXPHONE continues to ring.
- If you have only one telephone line, the most efficient way to set up your system is to attach a cordless phone to the FAXPHONE. When the telephone rings, you can pick up the cordless phone anywhere; you don't need to be near the FAXPHONE.
- Another alternative is to use a Distinctive Ring Pattern (DRP) service that may be available from your telephone company. See page 21 for information on DRP service.

Print quality problems

If the printout is unsatisfactory, consider the following suggestions:

- z Most paper has a right side and a wrong side. If the print quality is poor, try turning the paper over and printing on the other side.
- z If characters and images are blurred, check that you are using the correct kind of paper, see p. 6.
- z If ink gets on the printer's platen, the reverse side of the printed page will have smudges. In this case, clean the platen area with a soft dry cloth. See p. 89.
- z If white streaks or missing dots appear on printed pages, perform the print head cleaning operation. See p. 90.
- z If the quality is not crisp and clear after cleaning the print head, repeat the head cleaning procedure again. If output is still not satisfactory after cleaning the print head five consecutive times, replace the BJ cartridge. See p. 91.
- z If the following print quality problems occur in the entire printing area, check for the most probable cause and remedy as listed below.

Print Results	Most Probable Cause	Remedy
Smudged	Paper type	Try a different type. See p. 6.
Blurred	Paper type	Try a different type. See p. 6.
Faded	Print head is clogged or out of ink.	Perform head cleaning or replace the BJ cartridge. See pp. 90 and 91.
White Streaks	Print head is clogged.	Perform head cleaning or reinstall the BJ cartridge. See pp. 10 and 90.
Dots Missing	Print head is clogged.	Perform head cleaning. See p. 90.
Irregular Dots	Print head is clogged.	Perform head cleaning. See p. 90.

Error codes, messages and solutions

The following table summarizes the error codes that appear on Activity reports (see p. 79), the displayed messages and what to do for each error.

<i>Message</i>	<i>Error Code</i>	<i>Cause</i>	<i>Action</i>
BUSY/NO SIGNAL	#005/018	The telephone number you dialed is busy.	Try sending the document at a later time.
		The other party's fax is not working.	Contact the other party and have them check their fax.
		The other party is not using a G3 machine.	Contact the other party and have them send or receive the document using a G3 machine.
		The touch tone/rotary pulse setting on your FAXPHONE is incorrect.	Set your FAXPHONE to the setting that matches your telephone line. (See p. 14)
		The receiving fax did not answer within 35 seconds.	Contact the other party and have them check their fax. You can try to send the document manually. For an overseas call, add pauses to the registered number. (See p. 33)
CHANGE CARTRIDGE	–	The BJ cartridge is empty or the ink has dried out.	Replace the BJ cartridge. (See p. 91)
CHECK REC PAPER	#009	No paper in the FAXPHONE or there is a paper jam.	Add paper or clear the jam, then press [STOP]. (See pp. 6 and 86)
CHK. FRONT COVER	–	The front cover is open.	Close the front cover.
CHECK DOCUMENT	#001	Document is jammed.	Remove the document you are trying to send or copy and start again. (See p. 86)

Error codes, messages and solutions

Message	Error Code	Cause	Action
CHECK PRINTER	–	An error occurred in the printer.	Press [STOP]. Try your operation again.
DOC. TOO LONG	#003	It took more than 32 minutes to send or copy a document. It took more than 32 minutes to receive a document. The document is longer than 39.4 in. (1 m).	Divide the document and send or copy each part separately. Contact the other party. Have them divide the document and send each part separately. Use a copy machine to make a reduced copy of the document and send the copy.
HANG UP PHONE	–	The handset is off hook.	Place the handset properly into its cradle.
MEMORY FULL	#037	The memory of the FAXPHONE is full because it has received too many documents. The memory is full because you tried to send too many pages at once.	Print out any documents that are stored in memory. Then start the operation again. (See p. 68) Divide the documents and send each part separately.
MULTI TRANS. ON	–	Sequential broadcasting is in progress, with a pause between calls.	If you want the FAXPHONE to continue, do nothing. If you want to stop sending, wait until the FAXPHONE starts to dial the number, then press [STOP].
NO RX PAPER	#012	The other party's fax is out of paper.	Contact the other party and have them install paper in their fax.
NO TEL #	#022	The One-touch Dialing or Coded Speed Dialing number has not been registered.	Register the number. (See pp. 39 and 41)
OUT OF RANGE	–	The number you entered is out of range.	Enter numbers that are allowed only.

Message	Error Code	Cause	Action
PUT IN CARTRIDGE	–	The BJ cartridge is not installed.	Install the BJ cartridge (See p. 10).
REC'D IN MEMORY	–	The paper or ink ran out, or a paper jam occurred, so the FAXPHONE received the document in memory.	Add paper to the paper tray, change the BJ cartridge, or clear the paper jam. Print out the document from memory. (See p. 68)
REC.PAPER JAM	#009	There is a paper jam.	Clear the jam, then press [STOP]. (See p. 87)
REDIALING	–	The FAXPHONE is waiting to redial the other party's number because the line was busy or the other party did not answer when you tried to send the document.	Wait for the FAXPHONE to try redialing. If that doesn't work, wait until the FAXPHONE starts to dial the number, then press [STOP] to cancel redialing. Try to send the document again at a later time.
START AGAIN	–	An error has occurred.	Start the procedure again from the beginning.
STOP KEY PRESSED	–	[STOP] is pressed.	Start the procedure again from the beginning.
TALK	–	Fax/Tel Mode is set for the FAXPHONE to ring.	Answer the call.
TIMER	–	Delayed Sending is set and will send at the preset time.	

In case of a power failure

The user data settings and registered data for One-touch Speed Dialing and Coded Speed Dialing are saved during a power failure using a built-in battery. However, documents stored in the FAXPHONE memory will be deleted. If a power failure occurs or the power is turned off, the FAXPHONE will automatically print a Memory Clear List as soon as the power is turned on or the power is restored. This list informs you of the deleted memory files.

During a power failure

The following restrictions apply to the function of the FAXPHONE during a power failure or while the power is turned off:

- z A call can be received with the FAXPHONE during a power failure. However, a call cannot be made since the numeric buttons, One-touch Speed Dialing and Coded Speed Dialing features are not operational.
- z A document can neither be sent nor received during a power failure.



Specifications

Scanning sheet size: Maximum width: 8.5" (216 mm)
Minimum width: 8.3" (210 mm)
Maximum length: 39.4" (1 m)
Minimum length: 5.8" (148 mm)
Maximum thickness: 0.005" (0.13 mm)
Minimum thickness: 0.003" (0.08 mm)

**Effective image size:
(when scanning)** Width (Letter, Legal): 8.4" (214 mm)

Printing paper size: Letter: 8.5" × 11" (216 × 279 mm)
Legal: 8.5" × 14" (216 × 356 mm)
A4: 8.3" × 11.7" (210 × 297 mm)

Transmission time: G3 ECM MMR: Approx. 7 seconds*
G3 MR Standard mode: Approx. 18 seconds*
G3 MH Standard mode: Approx. 19 seconds*

Scanning line density: Horizontal: 203 dots/inch (8.00 dots/mm)
Vertical Standard: 98 lines/inch (3.85 lines/mm)
Fine: 196 lines/inch (7.7 lines/mm)

Scanning method: Solid state electronic scanning by contact image sensor

Recording method: Bubble Jet printing

Paper tray capacity: Maximum: 100 sheets (20 lb or 75 g/m²)
Maximum thickness of stacked paper: 0.39" (10 mm)

Paper type: Plain cut sheet paper (Letter/Legal)
Paper weight: 17 to 24 lb (64 to 90 g/m²)
Paper thickness: 0.003" to 0.005" (0.08 to 0.12 mm)

Image memory: Up to 21 letter-size pages* when sending (standard resolution)
Up to 15 letter-size pages* when receiving (standard resolution)

Applicable lines: Subscriber's telephone circuit (PSTN)

Auto dial functions: One-touch Speed Dialing (Registration for 10 numbers)
Coded Speed Dialing (Registration for 20 numbers)

* Based on the CCITT #1 chart, Standard mode.



Specifications

Ink cartridge: Type: Canon BX-3 (single cartridge ink supply)
Ink color: Black
Print head: 64 bubble jet nozzles

Ink amount: Approx. 29 ml

Power source: 120 V/60 Hz

Power consumption: Standby: Approx. 8 W
68°F (20°C) room temp.
Operation: Approx. 13 W, maximum 30 W
(based on all black copy)

Operating environment: Temperature: 50°F to 90.5°F (10°C to 32.5°C)
Humidity: 20% to 80 % RH

Dimensions: 14.5" (W) × 11.7" (D) × 13.3" (H)
369 mm (W) × 297 mm (D) × 337 mm (H)
(including trays)

Weight: Approx. 12.1 lbs (5.5 kg)

Specifications subject to change without notice.



Appendix

Document sizes

The following illustrations show the maximum and minimum document sizes that can be fed into the FAXPHONE.

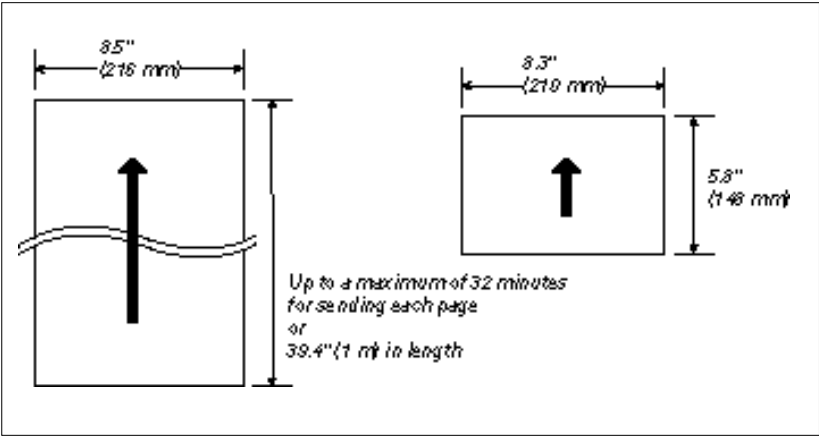

The actual scanned image size for the FAXPHONE is shown below.

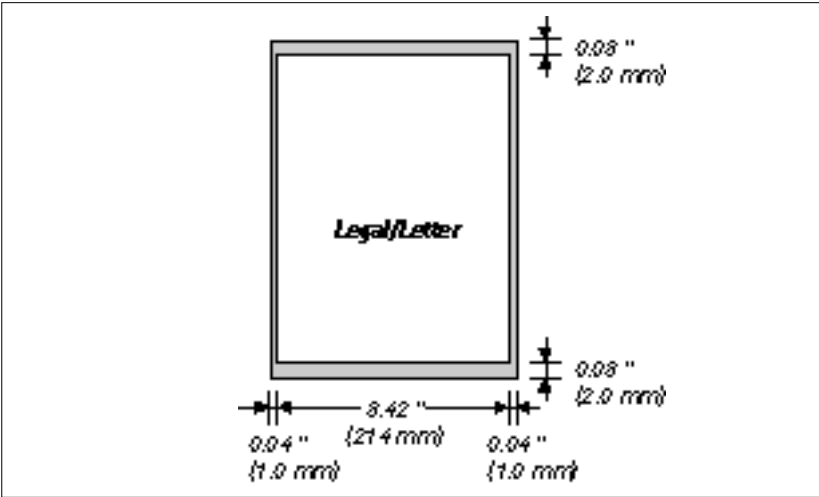

The 0.04" (1.0 mm) margin on either side of the sheet and the 0.08" (2.0 mm) margin on the top and bottom are not picked up by the scanner.

NOTE Document thickness

um 0.005" (0.13 mm)

Minimum 0.003" (0.08 mm)

Appendix

What happens when Fax/Tel Mode is selected

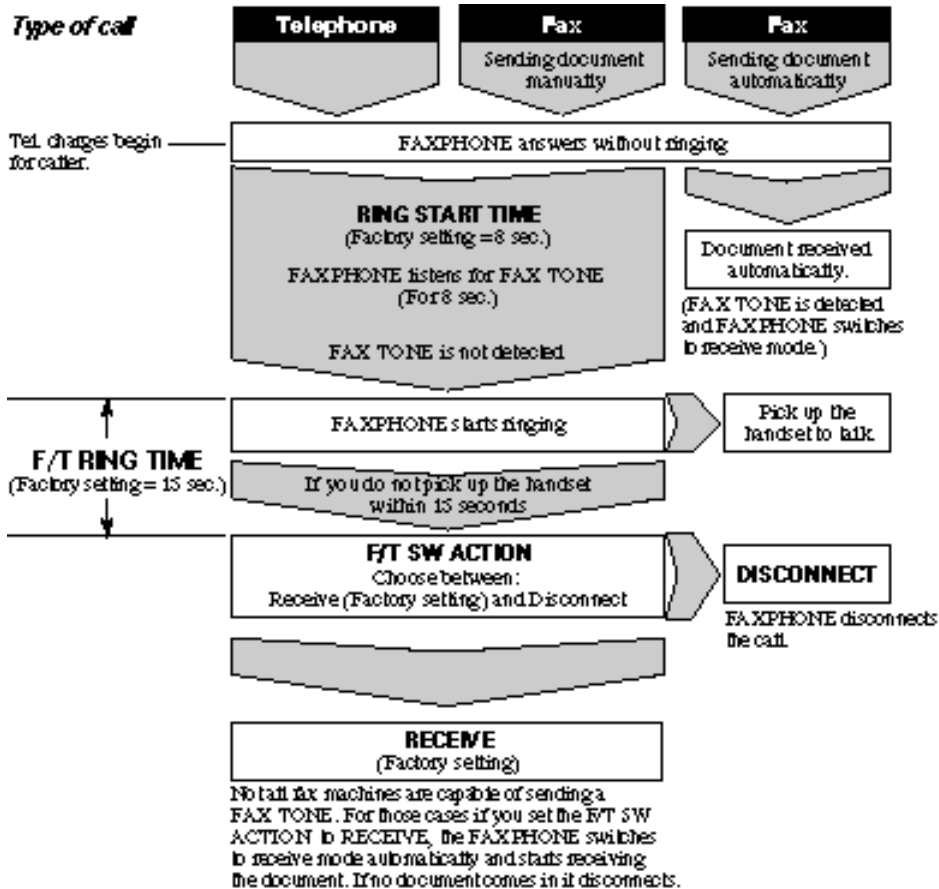

To select Fax/Tel Mode

- 1 Press [RECEIVE MODE] until "Fax/Tel Mode" appears on the LCD.

To change the Fax/Tel Mode settings:

- 1 Press [FUNCTION].
- 2 Press [F] until RX SETTINGS is displayed in the LCD. Press [START/COPY].
- 3 Press [F] until FAX/TEL SWITCH is displayed in the LCD. Press [START/COPY].
- 4 LCD displays RING START TIME. Press [START/COPY]. Choose between 0-30 SECONDS (enter your selection using the numeric buttons) and press [START/COPY] again.
- 5 LCD displays F/T RING TIME. Press [START/COPY]. Choose between 10-45 SECONDS (enter your selection using the numeric buttons) and press [START/COPY] again.
- 6 LCD displays F/T SW ACTION. Press [START/COPY]. Press [←] or [F] to choose between RECEIVE and DISCONNECT. Press [START/COPY].
- 7 Press [STOP] to finish registration and return to the standby mode.

Glossary

A

AC

Alternating current. The type of electrical current available from a wall outlet.

Activity report

Journal of transactions, both sent and received.

ADF

Automatic Document Feeder. The document tray on the FAXPHONE holds 20 sheets of paper.

Ans. Machine Mode

If you connect an answering machine to your FAXPHONE, this option allows you to receive documents sent from other fax machines, as well as messages from people calling when you are out.

Automatic dialing

Dialing fax or telephone numbers by pressing one or three buttons. To use automatic dialing, you must register the numbers in the FAXPHONE's memory. See also One-touch Speed Dialing and Coded Speed Dialing.

B

Bi-directional printing

The ability of the FAXPHONE to print both left to right and right to left. This printing method provides a fast speed. See also Unidirectional printing.

bps

Bits per second. Refers to the speed with which a fax machine sends and receives data.

Broadcasting

Transmitting documents to more than one location (through the FAXPHONE's memory).

Bubble Jet printing

An ink-jet type printing method that heats the ink to the boiling point to form a bubble. When the bubble expands, there is no room left in the nozzle for the ink and the ink is projected onto the paper.

C

CCITT #1 Chart

A test chart, defined by CCITT, used to measure the transmission speed as well as the transmitting and receiving memory capacity of a fax machine.

CCITT/ITU-TS

Formerly known as CCITT, Consultative Committee for International Telegraph and Telephone. CCITT has been replaced by the International Telecommunications Union-Telecommunications Sector (ITU-TS), a committee created to set international standards for telecommunications.

CNG

Calling Tone. This is a signal sent by fax machines to identify the call as an incoming document. When the receiving fax detects this signal, it automatically starts to receive the fax transmission. The majority of fax machines in use today can send and detect CNG signals.

Coded Speed Dialing

An automatic dialing method that allows you to dial a fax or telephone number by pressing three buttons-[CODED DIAL] and a two-digit code using the numeric buttons. You can register up to 20 Coded Speed Dialing numbers in the FAXPHONE.

Cursor

The underline symbol you see on the LCD when you register numbers and names in the FAXPHONE. Press the arrow buttons to move the cursor.

D

Delayed Sending

The ability to send a document at a preset time in the future. You do not have to be in your office to use Delayed Sending to one or more destinations. (You can set up only one delayed transmission at a time on the FAXPHONE.)

Density control

A setting that darkens or lightens the scanning of documents.

Dialing methods

Ways of pressing one or more buttons to access a number to connect to an outside party or fax machine. Dialing methods include One-touch, Coded Speed Dialing, and Manual (Regular).

Glossary

Direct Sending

Transmitting a fax document one page at a time without having the document scanned into memory.

Document

The sheet of paper containing the data that you send to or receive from a fax.

dpi

Dots per inch. A unit of measurement for indicating a printer's resolution.

DRPD

Distinctive Ring Pattern Detection. Allows you to assign up to five different ring patterns to distinguish voice and fax calls using your telephone company's special services.

E

ECM

Error Correction Mode. The ability of your FAXPHONE to reduce system and line errors when sending or receiving from another fax with ECM capability. ECM is most effective in areas where the telephone lines are in poor condition or there is frequent interference on the line. Do not use ECM if you need to send a document quickly and you are sure the other party can read your transmission without it (turning off ECM also turns off MMR).

Extension

A telephone connected to the FAXPHONE.

F

Fax Only Mode

This option allows you to use your FAXPHONE only to receive faxes automatically. If you have a dedicated fax line, you may want to set this mode.

Fax/Tel Mode

This option allows you to set the FAXPHONE to automatically detect whether a call is from a fax or telephone. If the call is from another fax, the transmission is automatically received. If the call is from a telephone, the FAXPHONE rings to let you know, so you can pick up the handset. With this feature, one telephone line can be shared by both the telephone and the fax.

FINE

The setting for documents with very small characters and lines.

G

G3, Group 3 fax machine

Defined by CCITT. Uses encoding schemes to transmit image data while reducing the amount of data that needs to be transmitted, thus reducing transmission time. G3 fax machines can transmit one page in less than one minute. Encoding schemes for G3 fax machines are Modified Huffman (MH), Modified Read (MR), and Modified Modified Read (MMR).

H

HOOK

The button that engages and disengages the telephone line.

I

Ink cartridge

The special type of ink cartridge used with Canon Bubble Jet fax machines. The ink cartridge for the FAXPHONE includes the print head and ink. Use the BX-3 cartridge only.

J

Jack

The telephone receptacles on your wall or in your FAXPHONE used to connect the FAXPHONE to the telephone line, answering machine and extension phone.

Glossary

M

Manual Dialing

Pressing the individual numeric buttons to dial a fax number. Also called regular dialing.

Manual Mode

A setting that allows you to answer all incoming telephone and fax calls. If you hear a slow beep it indicates an incoming fax transmission from another machine. Just press [START/COPY] to receive the incoming fax.

Manual redialing

When you use Regular dialing, you can redial a number manually simply by pressing [REDIAL] on the operation panel. The last number called is the number redialed.

Memory Sending

Scans a document into memory before the FAXPHONE dials the numbers and sends it. This method is faster than direct sending and it allows you to retrieve your original document immediately after scanning.

N

Noise

A term applied to a variety of problems that impair the operation of telephone lines used for faxing.

Numeric buttons

The round numbered buttons on the operation panel marked the same as a standard telephone keypad. Press them to perform Manual Dialing. You also use the numeric buttons to enter numbers and letters when you register numbers and names, and for entering Coded Speed Dialing codes with two or more digits.

O

One-touch Speed Dialing buttons

The rectangular buttons numbered 01 to 10 on the operation panel, each of which may be registered as a fax or telephone number. Once a number is registered, you press one button to dial the entire number.

P

Pause

A timing entry required for registering certain long distance numbers and for dialing out through some telephone systems or switchboards.

PBX

Private branch exchange. See Switchboard.

PHOTO

The document setting you use for sending documents with intermediate tones, such as photographs.

Pulse

See Rotary pulse.

R

Redialing-automatic

When the fax you dial does not answer or a sending error occurs, the FAXPHONE waits for a specified interval and then redials the same fax number. You can adjust the number of redials and the length of time between redialing.

Redialing-manual

When you use the regular dialing method, you can quickly call the last number dialed by pressing [REDIAL].

Reduction mode

The FAXPHONE's automatic feature that slightly reduces the received image to allow room at the top of the page for the sender's ID information. You can also reduce the size of large incoming documents using the RX REDUCTION option.

Resolution

The density of dots for any given output device. Expressed in terms of dots per inch (dpi). Low resolution causes font characters and graphics to have a jagged appearance. Higher resolution means smoother curves and angles as well as a better match to traditional typeface designs. Resolution values are represented by horizontal data and vertical data.

Rotary pulse

A telephone dialing system where a dial is rotated to send pulses to the telephone switching system. When you pulse dial, you hear clicks. When you touch-tone dial, the most common dialing system, you hear tones. Rotary pulse dialing requires certain setting adjustments.

Glossary

S

Sender ID

The identifying information from the sender at the top of a document including: date and time, the sender's fax/telephone number, sender's name, receiver's name or company name, and page number. Also called TTI or Transmit Terminal ID.

Sending speed

The bits per second rate at which documents are sent. See also bps.

STANDARD

A document setting for sending normal typewritten or printed documents containing only text and no drawings, photographs, or illustrations.

Standby

The mode in which the FAXPHONE is on and ready to use. All operations start from standby mode when the LCD displays the date and time.

Switchboard

Also called a PBX (Private Branch Exchange) internal switching system. A telephone system, usually for a large company office with many extensions, whereby you must dial an outside line number along with the regular telephone or fax number. Dialing out through a switchboard sometimes requires use of the [REDIAL/PAUSE] button.

T

Timed sending

Setting the FAXPHONE to transmit documents at a preset time in the future. See also Delayed sending.

TONE

A button that allows you to temporarily switch to touch-tone from pulse dialing. In some countries, on-line data services may require that you use tone dialing.

Tone/pulse setting

The ability to set the FAXPHONE to match the telephone dialing system your telephone line uses: touch-tone or rotary pulse.

TTI

Transmit Terminal ID. See Sender ID.

U

Unidirectional printing

Printing in one direction only, left to right. This printing method on the FAXPHONE provides a higher image quality but slower print speed. See also Bi-directional printing.

Index

A

Activity Management Report

automatic print out of, 76
explanation, 80

Activity Report

automatic print out of, 76
errors and, 98
explanation, 82, 83
turning on/off, 76

Adding

pages when sending, 46

Adjusting

FAXPHONE for different
answering machines, 20
pause time, 76

Alarm

volume of, 75

Answering machine

connecting, 13
receiving documents and,
66
sample message, 19
using with FAXPHONE, 19

Automatic

dialing methods, 52, 54
fax/tel mode, 15
receiving, 15
receiving of documents and
phone calls, 17
redialing, 56
report printout. *See listing
under individual report*
switching to automatic
receiving, 16, 17

B

Bi-directional printing, 78

Bubble-Jet cartridge

cleaning head of, 90
installing, 10
replacing, 91

Buttons

description, 30, 31

C

Cartridge. *See Bubble-Jet
cartridge*

Changing

date format, 78
language of display, 78
pause time, 76
ringing time, 77
time before switching to
receiving, 77

Cleaning

document scanning glass, 88
FAXPHONE, 88
print head, 90
printer area, 89

Clearing document jams, 86

Coded Speed Dialing

explanation, 52, 54
printing list of numbers
registered for, 79, 81
registering, 41

Connecting

answering machine, 13
extension phone, 13
FAXPHONE to telephone
line, 13

Copying, 50

D

Darkening documents, 47, 75

Date

format, 78
on documents you send, 35
registering, 36

Dedicated fax line

explanation, 15
receiving documents over, 16
setting FAXPHONE for use
over, 16

Delayed sending, 59

Deleting.

See Erasing

Density

changing, 47, 75
of documents you send, 47
of copies, 47
customizing default, 75

Dialing

automatic, 52, 54
buttons. *See Numeric buttons*
Coded Speed, 52, 54
numbers that are busy. *See
Redialing
Manual, 53*

One-touch Speed, 54, 62
pauses when, 33
pulse, 14
tone, 14

Direct Sending, 52, 53

Display, 31

Message(s), 98

Document(s)

adding when sending, 46
automatically receiving
telephone calls and, 15, 17,
65
clearing jams with, 58, 86
containing fine lines and
small type, 47
containing photographs or
illustrations, 47
containing text and photo-
graphs, 47
darkening, 47, 75
feeding into the
FAXPHONE, 45
in memory, 67
jam clearing, 86
lightening, 47, 75
maximum size of, 104
minimum size of, 104
preparing for sending, 52
received in memory, 67
scanning glass, 88
storing in memory, 66

DRPD (Distinctive Ring Pattern Detection)

settings for FAXPHONE, 21
using FAXPHONE with, 24

E

ECM (Error Correction Mode)

turning on/off, 76, 77

Erasing

names when registering, 35

Error

Activity Reports and, 80
messages and codes, 98

Extension phone

connecting, 13
jack, 13

Index

F

Facsimile numbers

- dialing, 52
- printing list of registered, 79, 80, 81
- registering your, 37

Fax Only Mode, 16

Fax/Tel Mode

- explanation, 15
- setting FAXPHONE for use, 17
- using, 17, 65

Feeding documents into

FAXPHONE, 45

Frequently Asked Questions, 92

I

Ink

- cartridge. *See Bubble-Jet cartridge*

Installing

- answering machine, 13
- Bubble-Jet cartridge, 10
- extension phone, 13
- paper, 6

J

Jack

- answering machine, 13
- extension phone, 13
- telephone line, 13

Jams

- document, 58, 86
- paper, 58, 86, 87

L

Lightening documents, 47, 75

Loading paper, 6

M

Manual Mode

- receiving, 18, 64
- redialing, 56

Maximum

- document size, 104

- number of documents in memory, 67

Memory

- capacity when receiving, 67
- capacity when sending, 55
- printing documents received in, 68

Memory Sending

- explanation, 52
- using, 55

Minimum document size, 104

N

Name

- entering when registering, 34
- on documents you send, 35
- registering, 37

Numeric buttons

- dialing with, 53
- entering names with, 34

O

One-touch Speed Dialing

- explanation, 52
- printing list of numbers registered for, 79, 80
- registering, 39
- using, 54

P

Packing list, 3

Paper

- loading, 6
- non-usable types for sending, 44
- recommended type for receiving, 6
- size settings, 6, 78

Pause time

- changing length of, 76
- explanation, 33

Photo

- setting, 47

Power

- cord, 5
- requirements, 5

Precautions, vi

Preparing documents, 44

Printer

- Bubble-Jet cartridge and, 8
- cleaning, 89
- testing, 12

Printing

- reports, 79
- documents received in memory, 68
- list of custom settings, 79, 82
- numbers registered for automatic dialing, 79, 80, 81

Pulse dialing

- setting, 14
- switching to tone dialing from, 14

R

Receiving

- answering machine and, 66
- automatically, 15
- dedicated, 15, 16
- documents and telephone calls automatically, 17, 65
- ECM, 77
- manually, 15, 18, 64
- memory, 67
- switching from manual to automatic, 15, 65

Redialing

- automatic, 56
- manual, 56
- setting, 76

Registering

- Coded Speed Dialing, 41
- date, 36
- entering a name when, 34
- One-touch Speed Dialing, 39
- time, 36
- your facsimile number, 37
- your name, 37

Regular Dialing. *See Manual dialing*

Reports

- Activity, 82, 83
- Activity Management, 80
- printing out, 79

Ring pattern, 21

Ring time, 77

Index

S

Sending

- Activity Report when, 82
- adding pages while, 46
- at a preset time, 59
- clearing document jams
 - when, 58
- darkening documents
 - when, 47, 75
- Delayed, 59
- Direct, 53
- documents with fine lines, 47
- documents with photos/
illustrations, 47
- ECM, 76
- feeding documents for, 45
- lightening documents
 - when, 47, 75
- Manual, 53
- Memory, 55
- non-usable types of documents when, 44
- preparing documents before, 52
- redialing and, 56

Setting up

- packing list for, 3
- power requirements for, 5
- telephone line setting, 14

Specifications, 102

Switching (fax/tel)

- settings for, 17
- time, 77
- using, 17, 65

Symbols, 34

T

Telephone

- extension, 13
- extension jack, 13
- line jack, 13
- line setting for, 14

Testing printer, 12

Timer. *See Delayed sending*

Tone dialing

- setting, 14
- switching to temporarily, 30

TTI, 35, 75

V

Volume

- alarm, 75
- calling, 75
- control, 75
- keypad, 75
- phone, 75