

BUBBLE JET PRINTER

i9100

Quick Start Guide

Table of Contents

Preface	1
Shipping Materials	1
Introduction	1
Setting Up	2
Preparing the Printer	2
Connecting the Printer to the Computer	3
Installing the Print Head	4
Loading Paper	7
Installing the Printer Driver	8
Aligning the Print Head	14
Basic Operations	18
Printing with Windows	18
Printing with Macintosh	20
Print Head Maintenance	22
Notes on Handling the USB Interface (for Windows Users)	23
For Further Details...	23

Exif Print

This printer supports Exif 2.2 (also called “Exif Print”).

Exif Print is a standard for enhancing the communication between digital cameras and printers. By connecting to an Exif Print-compliant digital camera, the camera’s image data at the time of shooting is used and optimized, yielding extremely high quality prints.

Canadian Radio Interference Regulations

This digital apparatus does not exceed the Class B limits for radio noise emissions from a digital apparatus as set out in the interference-causing equipment standard entitled “Digital Apparatus,” ICES-003 of the Industry Canada.

Cet appareil numérique respecte les limites de bruits radioélectriques applicables aux appareils numériques de Classe B prescrites dans la norme sur le matériel brouilleur NMB-003 d’Industrie Canada intitulée « Appareils numériques ».

International ENERGY STAR® Program

As an ENERGY STAR® Partner, Canon Inc. has determined that this product meets the ENERGY STAR guidelines for efficiency.



The International ENERGY STAR® Office Equipment Program is a global program that promotes energy saving through the use of computer and other office equipment. The program backs the development and dissemination of products with functions that effectively reduce energy consumption. It is an open system in which business can participate voluntarily. The targeted products are office equipment such as computers, monitors, printers, faxes and copiers. Their standards and logos are uniform among participating nations.

Power Requirements

Never use a power supply voltage other than that supplied in the country of purchase. Using the incorrect voltage could cause a fire or electric shock. The correct power supply voltages and frequencies are as follows:

Europe	AC 230V±10%, 50Hz
USA/Canada	AC 120V, 60Hz
Australia	AC 240V, 50Hz

Preface

Shipping Materials

Thank you for purchasing a Canon Bubble Jet Printer.

Check that all the following items are in the box. If anything is missing or is damaged, contact your Canon Authorized Dealer or Sales Representative.

- Printer
- Setup Software & User's Guide CD-ROM
- Quick Start Guide
- Print Head
- 6 Ink Tanks

* Cables should be purchased separately according to your computer. For details on cable type and specifications, refer to page 3.

Introduction

This Quick Start Guide uses the following symbols to indicate important information. Always observe the instructions indicated by these symbols.

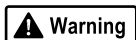

Instructions that, if ignored, could result in death or serious personal injury caused by incorrect operation of the equipment. These must be observed for safe operation.

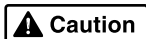

Instructions that, if ignored, could result in personal injury or material damage caused by incorrect operation of the equipment. These must be observed for safe operation.

Also read the Safety Precautions in the User's Guide. Observe the warnings and cautions to avoid personal injury or damage to the printer.

Trademark Notices

- Canon[®] is a registered trademark of Canon Inc.
- BJ[™] is a trademark of Canon Inc.
- Microsoft[®] and Windows[®] are registered trademarks of Microsoft Corporation in the U.S. and other countries.
- Apple, Mac, Macintosh are trademarks of Apple Computer, Inc., registered in the U.S. and other countries.
- All other trademarks and registered trademarks appearing in this Quick Start Guide are the property of their respective owners.

Copyright ©2003 CANON INC.

All rights reserved. No part of this publication may be transmitted or copied in any form whatsoever without the express written permission.

Setting Up

1 Preparing the Printer

- 1 Place the printer on a flat surface.
- 2 Remove the tape and the shipping material from the printer as shown.

The tape position is subject to change.

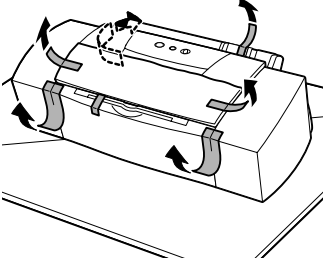

- 3 Attach the paper rest to the sheet feeder.

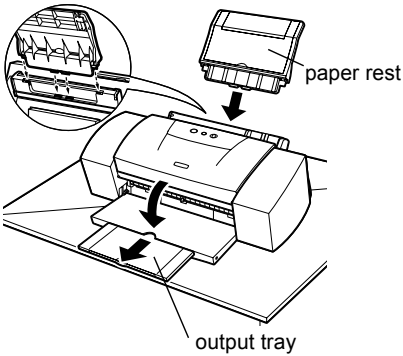

- 4 Lower and pull out the output tray as shown.

2 Connecting the Printer to the Computer

Use a USB cable.

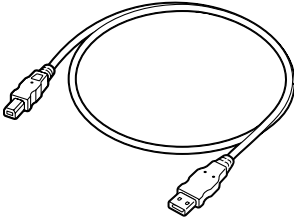

Recommended: Canon or other computer manufacturer cable, up to 2 meters in length.

→ Notes

- If your computer has an earth connection, make sure that this is attached.
- If you do not intend to use the printer for a long period of time, unplug the power cord from the power outlet after turning off the printer.

Follow the steps below to install the printer driver correctly.

- 1 Ensure the printer and the computer are switched off.
- 2 Connect the cable.

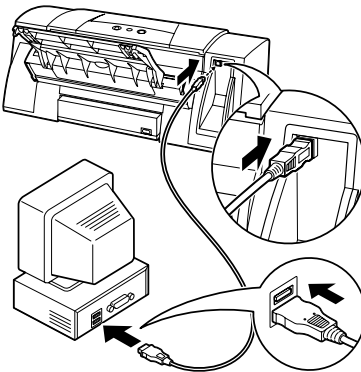

→ Note

If the Add New Hardware Wizard or Found New Hardware Wizard screen appears when carrying out the following operations, click **Cancel** and turn off the computer.



3 Installing the Print Head

Warning

- Never attempt to plug the power cord into the power outlet or unplug the power cord when your hands are wet.
- Never damage, modify, stretch, or excessively bend or twist the power cord. Do not place heavy objects on the power cord.
- Never use any power supply other than the standard power supply available in the country of purchase. Using the incorrect voltage and frequency could cause a fire or electric shock.
- Always push the plug all the way into the power outlet.

■ Installing the Print Head

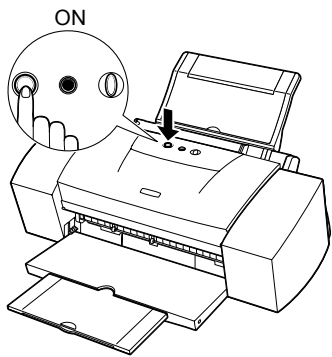

- 1** Plug the printer in.
- 2** Turn on the printer. Do NOT turn on the computer yet.

The POWER lamp flashes and the printer begins to operate. Wait until the POWER lamp remains fully lit.

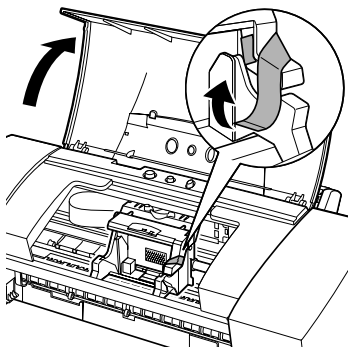

- 3** Open the front cover.
- 4** Remove the tape.

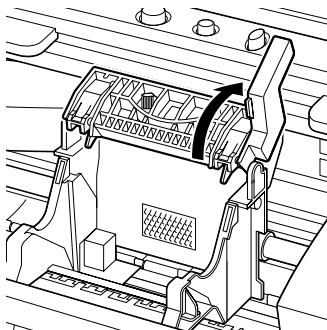

- 5** Raise the lock lever.

Do not touch internal parts other than the lock lever.

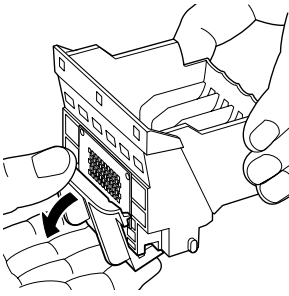

print head print head holder

6 Remove the protective cap from the print head.

→ Notes

- Do not touch the print head nozzles or electrical contacts.
- Do not attempt to reattach the protective cap once it has been removed.

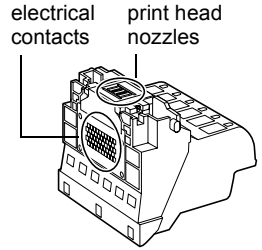

7 Place the print head in the holder.

→ Note

Be careful not to touch any parts inside the printer.

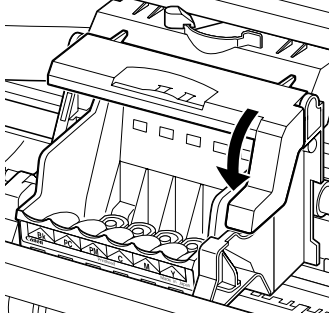
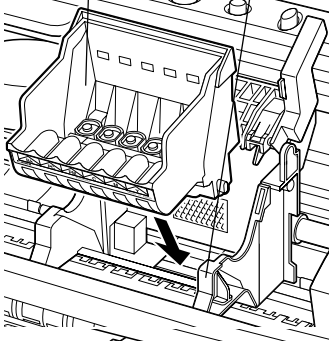

8 Lock the print head into place by lowering the lever.

Do not touch the lock lever once the print head has been installed.

■ Installing the Ink Tanks

⚠ Caution

- For safety reasons, store ink tanks out of the reach of small children.
- Do not drop or shake ink tanks.

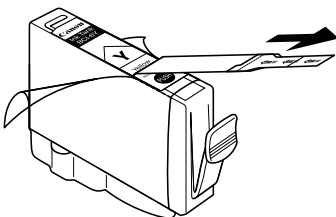

1 Take out the yellow ink tank.

2 Pull the orange tape in the direction of the arrow and remove the clear film.

protective cap

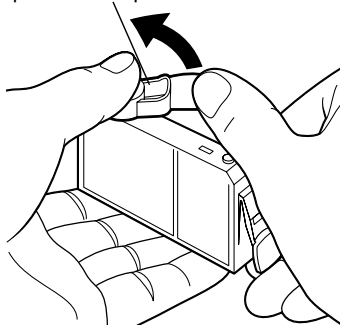

- 3 Hold the ink tank as shown in the diagram and remove the protective cap.

→ **Notes**

- Do not squeeze the sides of the ink tanks as this may cause the ink to leak out and stain your clothes and hands.
- Do not touch the ink port.
- Do not attempt to reattach the protective cap once it has been removed.

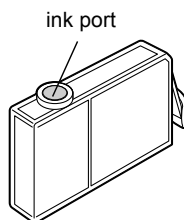

- 4 Insert the yellow ink tank into the right-hand slot. Press the top until it clicks into place.

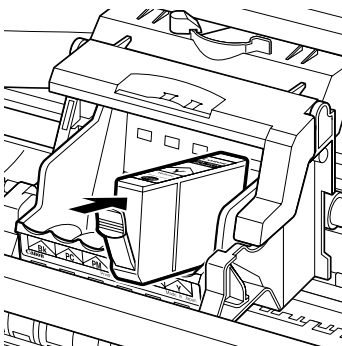

- 5 Use the same procedure to install the other ink tanks in their appropriate slots.

Check the labels to make sure that each tank is in the correct position.

→ **Notes**

- Only install the ink tanks in the positions specified by the labels.
- If ink tanks are not installed in the right position, colors will not be printed correctly. Immediately reinstall the tank in the correct position and carry out print head cleaning. For details, refer to the User's Guide.

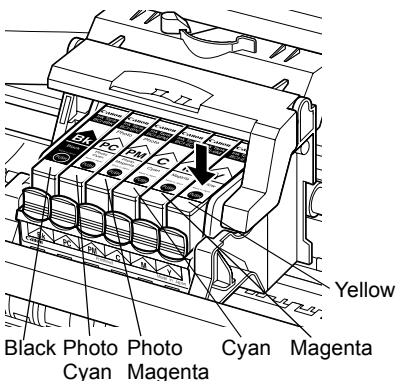

- 6 Close the front cover.

Wait until the POWER lamp remains fully lit (about 60 seconds).

4 Loading Paper

■ Loading A4 (Letter) Size Plain Paper

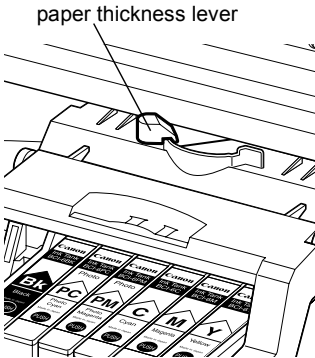

- 1 Open the front cover.
- 2 Move the paper thickness lever at the top of the print head holder to the left position. Close the front cover.

→ **Note**

Set the paper thickness lever to the left when using plain paper, to the right when using thick paper. Refer to the User's Guide for information on loading envelopes and other media.

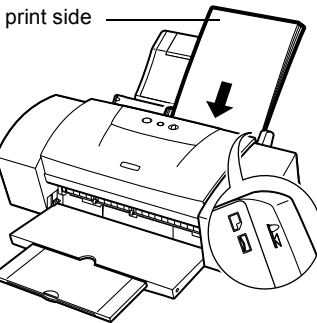

- 3 Load the paper, aligning it with the right side of the sheet feeder.

You can load up to 100 sheets of plain paper. Do not exceed this limit. After printing, do not stack more than 40 sheets in the paper output tray.

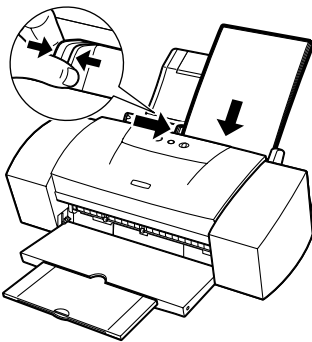

- 4 Press the paper guide and slide it against the left side of the stack of paper.

You now need to install the printer driver:

Windows:	Go to page 8
Mac OS 8.6 - 9.x:	Go to page 10
Mac OS X:	Go to page 12

5 Installing the Printer Driver

■ Installing the Printer Driver – Windows

→ Notes

- Do not disconnect the cable or remove the CD-ROM during the installation. The driver cannot be correctly installed.
- The screens below refer to Windows XP installation. Screen may differ depending on the operating system you are using.
- When installing the printer driver in Windows XP or Windows 2000, log on to the system as a member of the **Administrators** group.

If the following screen appears automatically, click **Cancel** and follow steps 1 to 7 to install the printer driver.



Special Notes for Windows 98 or Windows Me USB Users

Click **Cancel** to quit the screen and turn off the printer. Next, remove and replace the USB cable connected to your computer.

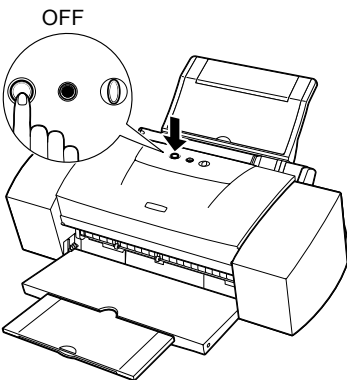

1 Ensure the printer and computer are switched off.

2 Turn on the computer and start Windows. If any applications automatically run, quit them.

Disable any virus detection programs.
Do NOT turn the printer on at this stage.

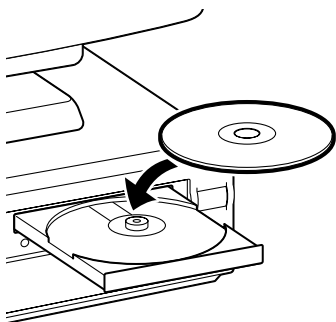

- 3** Place the Setup Software & User's Guide CD-ROM in the CD-ROM drive.

→ **Notes**

- If the CD-ROM does not run automatically, click **Start** and select **My Computer**, then double-click the CD-ROM icon. For non-XP Windows, double-click **My Computer** in the Windows screen, then double-click the CD-ROM icon.
- If the language selection screen appears, select a language, then click **OK**.



- 4** Follow the instructions displayed on screen. When the screen shown on the left is displayed, click **Install**.



- 5** When the screen shown on the left appears, turn the printer on.

If the printer is recognized, the printer driver will be automatically installed.

→ **Note**

If the connection is not recognized, refer to the section “Notes on Handling the USB Interface (for Windows Users)” on page 23.

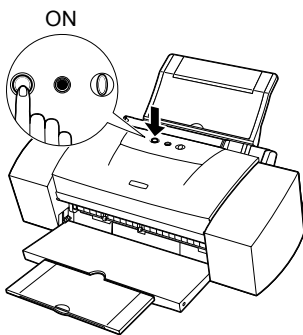

- 6** Click **OK**.

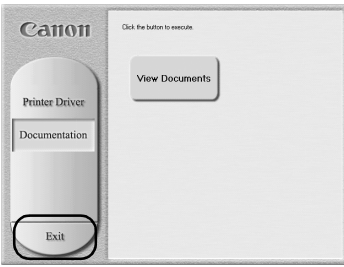

7 When the screen shown on the left appears, click **Exit**.

Before you use the printer, you must carry out print head alignment on page 14.

→ **Notes**

- To view the User's Guide, please refer to page 23.
 - If a message prompting you to restart the computer appears, click **Yes**.
-

■ Installing the Printer Driver – Macintosh

→ **Notes**

- Do not remove or insert the USB cable during installation, as this may result in the computer or printer not operating correctly.
- Before installing the driver, disable all virus detection programs and automatically loading programs or remove them from your system folder.
- The Setup Software & User's Guide CD-ROM contains the application software, ImageBrowser, PhotoStitch and Easy-PhotoPrint. If you want to install these applications, double-click the application folder, then double-click the appropriate folder and then **Installer**. Refer to the Photo Application Guide in your CD-ROM.

For Mac OS 8.6-9.x Users

- 1 Turn on the Mac.
- 2 Place the Setup Software & User's Guide CD-ROM in the CD-ROM drive.
- 3 Double-click the **Mac OS 8.6-9.x** folder.
- 4 Double-click the **Printer Driver** folder, then select a language.
- 5 Double-click **Installer**.
- 6 Read the Licence Agreement and click **Accept** to continue.

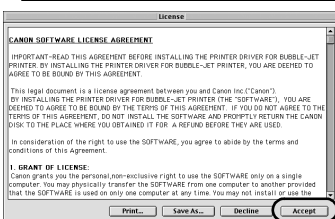
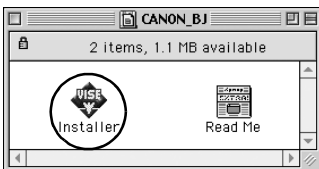
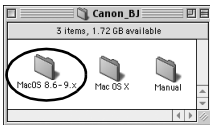

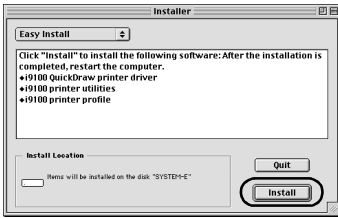

7 Click Install.

Wait for the installation to finish.

➔ **Note**



If the above message appears, check that there are no unsaved documents, then click the **Continue** button. If a document needs to be saved, click **Cancel** then save the document. After saving the document, begin again from step 4.



8 Click Restart.

The computer restarts.

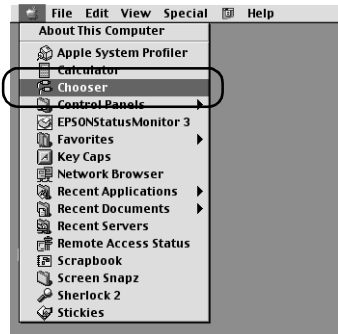

9 Select Chooser in the Apple Menu.

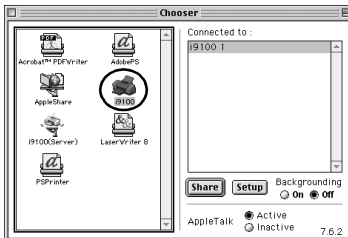

10 Click the icon for the printer you are using and close Chooser.

Before you use the printer, you must carry out print head alignment on page 16.

➔ **Note**

Refer to the User's Guide when using this printer as a network printer.

For Mac OS X Users

- 1 Turn on the Mac.
- 2 Place the Setup Software & User's Guide CD-ROM in the CD-ROM drive.
- 3 Double-click the **Mac OS X** folder, then double-click the printer driver folder.

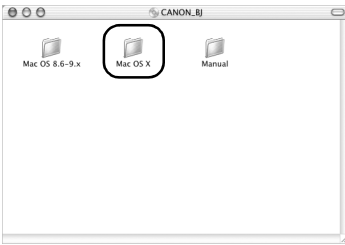

- 4 Double-click **i9100 180.pkg**.

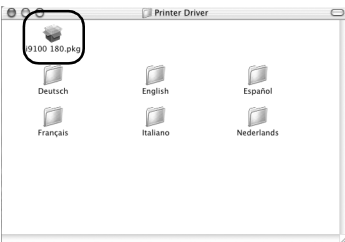

- 5 Enter an administrator name and a password, then click **OK**.



- 6 Click **Continue**.

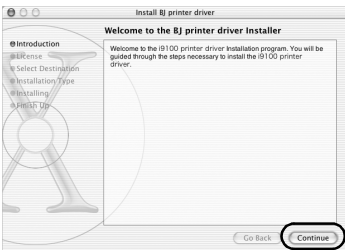

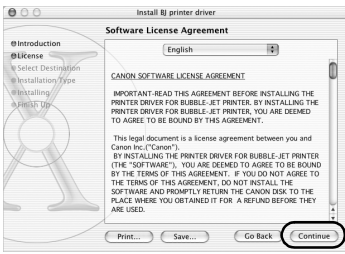

- 7 Read the License Agreement and click **Continue**, then click **Agree**.

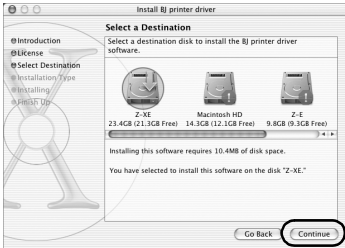

- 8 Select the Operating System to where you want to install the printer driver, and click **Continue**.

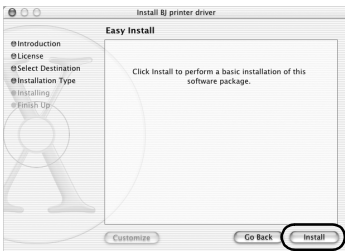

- 9 Click **Install**.

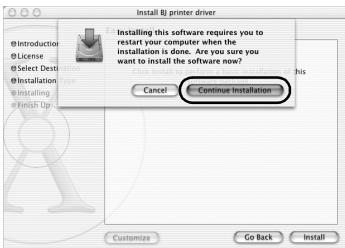

- 10 A message asking for your confirmation to restart your computer appears on the screen. Read the message, then click **Continue Installation**.

Software installation will start.



- 11 Software installation is complete. Restart your computer.

Before you use the printer, you must carry out print head alignment. For instructions on how to align the print head, refer to the *Printer Driver Guide for Mac OS X*. To view the *Printer Driver Guide for Mac OS X*, double-click the **Manual** folder and **Additional Guide for OSX User's** folder and select the language folder that you use as necessary.

You can also refer to the *Printer Driver Guide for Mac OS X* for instructions on how to use the printer driver.

6 Aligning the Print Head

This operation must be carried out when using the printer for the first time. Aligning the print head positions allows you to print without shifts in the color registration.

■ Aligning the Print Head – Windows

- 1 Click **Start** and select **Control Panel, Printers and Other Hardware**, and then **Printers and Faxes**.

↳ **Note**

For non-XP Windows, click **Start**, then select **Settings, Printers**.

- 2 Click the icon for your printer.
- 3 Open the **File** menu and select:
 - Windows XP/Windows 2000 → [Printing Preferences...]
 - Windows Me/Windows 98 → [Properties]to open the setting screen.

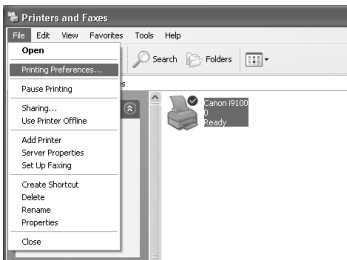

- 4 Click **OK**.



- 5 Click the **Maintenance** tab, and click **Print Head Alignment**.

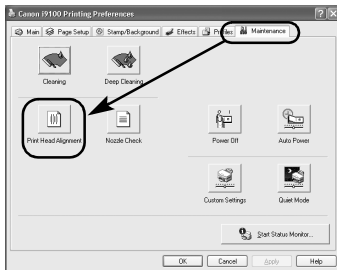

- 6 Check that paper is loaded in the printer and click **OK**. If a message warning you not to perform other operations appears, click **OK**.



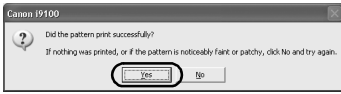

7 After the pattern is printed, click **Yes**.

If the pattern is not printed successfully, open the front cover and ensure that the ink tanks are correctly installed.

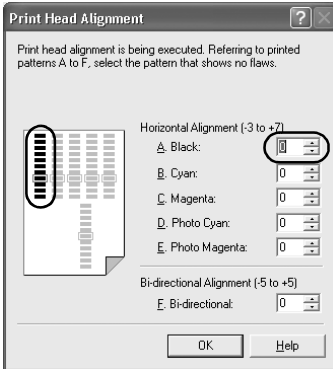

8 Look at the print-out. From the patterns in A, select the most even, least irregular pattern and enter the number.

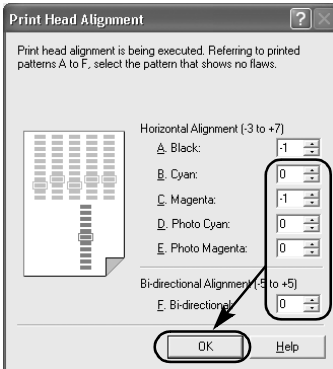

9 In the same way, one by one, select the most even patterns printed with the least irregularities from each of B to F, enter their numbers, and click **OK**.

If it is difficult to pick the best pattern on F, pick the setting that produces the least noticeable vertical white stripes.



Less noticeable white stripes



More noticeable white stripes



10 Click **OK**.

This completes the printer setup. The printer is now ready to use.

■ Aligning the Print Head – Macintosh

↳ Note

For Mac OS X users, refer to the Printer Driver Guide for Mac OS X for instructions on how to align the print head.

- 1 Select **Page Setup** in the **File** menu.
- 2 Click **Utilities**.
- 3 Select **Test Print** from the menu and click **Print Head Alignment**.

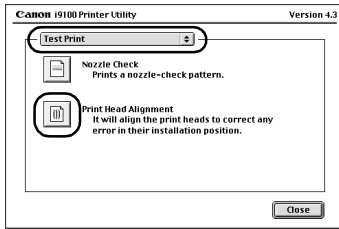
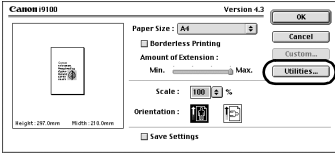

- 4 Check that paper is loaded in the printer and click **OK**.

If the pattern is not printed successfully, open the front cover and ensure that the ink tanks are correctly installed.

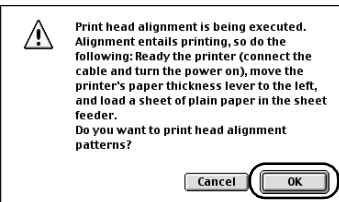

- 5 Look at the print-out. From the patterns in A, select the most even, least irregular pattern and enter the number.

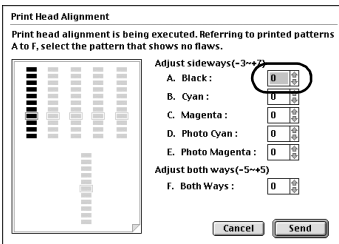

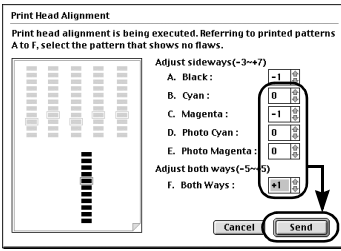

- 6** In the same way, one by one, select the most even patterns printed with the least irregularities from each of B to F, enter their numbers and click **Send**.

If it is difficult to pick the best pattern on F, pick the setting that produces the least noticeable vertical white stripes.



Less noticeable white stripes



More noticeable white stripes

- 7** Click **Close**.

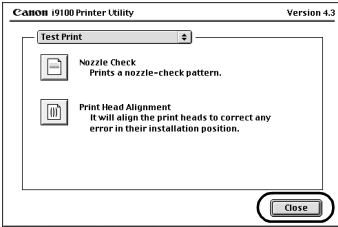

- 8** Click **OK**.

This completes the printer setup. The printer is now ready to use.

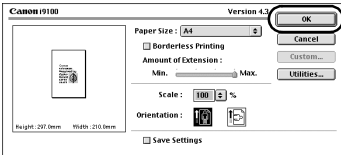

Basic Operations

⚠ Caution

- If you detect smoke, unusual smells or strange noises around the printer, immediately switch the printer off and always unplug the printer. Contact your local Canon service representative.
- To avoid injury, never put your hand or fingers inside the printer while it is printing.

Printing with Windows

Adjusting the print settings according to your needs allows you to produce better quality prints. In this section, we will use WordPad for the purpose of explanation. The procedures you use and the screens that appear on your computer may differ according to the application that you use.

■ Printing

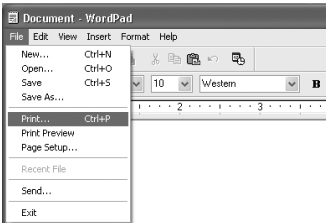

1 Print the document from the application.

On the **File** menu, click **Print**.

Check the application's users manual for the actual procedures.

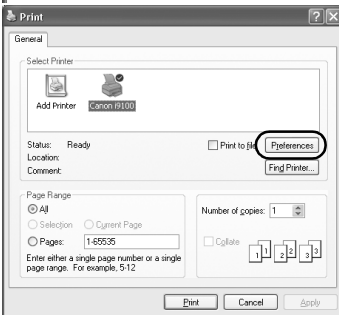

2 Ensure your printer is selected, then click:

- Windows XP →[Preferences]
- Windows Me/Windows 98 →[Properties]
- Windows 2000 →[Main] tab

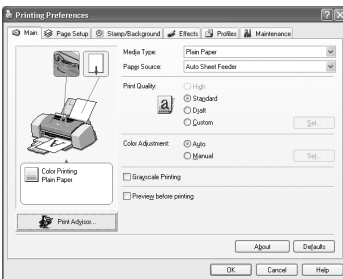

3 Specify the required settings and click **OK**.

↳ **Note**

If you use anything other than plain paper, please refer to “Basic Print Settings” on page 19.

4 To start printing, click **Print**.

Printing will start in a few moments.

■ Basic Print Settings

For the best print quality, specify the minimum requirement settings in the **Main** tab. To get the best results, ensure you select the type of media loaded in the printer when printing on paper other than plain paper.

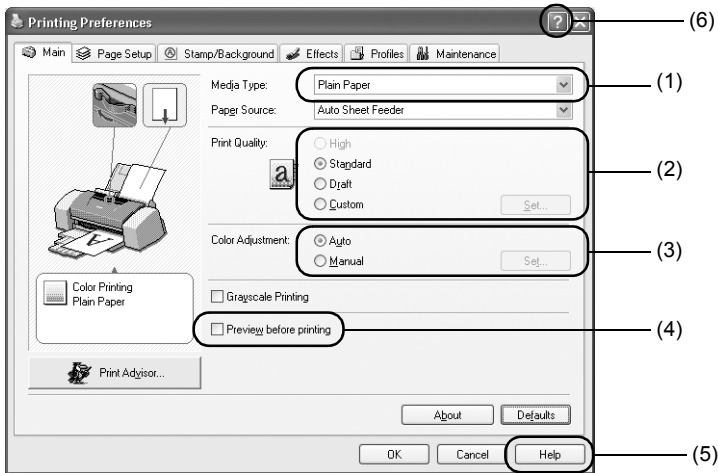

(1) Media Type	Select the type of media loaded in the printer.
(2) Print Quality	Select one option from High , Standard and Draft . Select Custom to set the print quality manually.
(3) Color Adjustment	If you wish to control the color adjustment settings in more detail, select Manual .
(4) Preview before printing	Select this to check the layout before printing.
(5) Help	Click this for a more detailed explanation of the functions in the tab. (This may not appear when using Windows XP or Windows 2000. If this happens, click Start then select All Programs (or Programs) - Canon i9100 - Guide).
(6) ?	Click this to change the cursor shape to ?. By clicking on the item's name with this ? cursor, an explanation will be displayed.

→ Notes

- Clicking the **Print Advisor** allows you to change to the most appropriate print settings simply by answering questions when prompted.
- Use the application to set the paper size and paper orientation. Before printing, open the settings screen and check that the **Page Size** in the **Page Setup** tab is the same as that specified within application.
- Refer to the User's Guide for more information about printer driver functionality.

Printing with Macintosh

Adjusting the print settings according to your needs allows you to produce better quality prints.

■ Printing

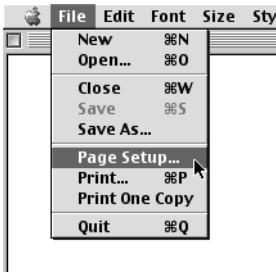

- 1 Open the **Page Setup** dialog box in your application.

On the **File** menu, click **Page Setup**. Check the application's users manual for the actual procedures.

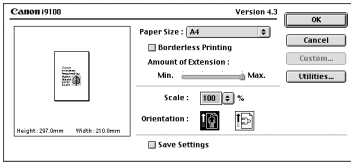

- 2 Specify the page setup.

For details, refer to “Page Setup” on page 21.

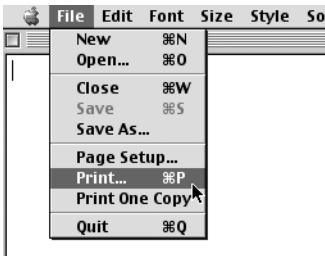

- 3 Open the Print dialog box in your application to print the document.

On the **File** menu, click **Print**. Check the application's users manual for the actual procedures.

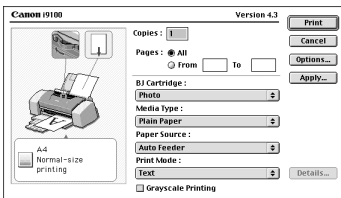

- 4 Specify the print settings according to your requirements.

For details, refer to “Basic Print Settings” on page 21.

- 5 Click **Print**.

Printing will start in a few moments.

■ Page Setup

Use the **Page Setup** dialog box to specify the paper size settings.

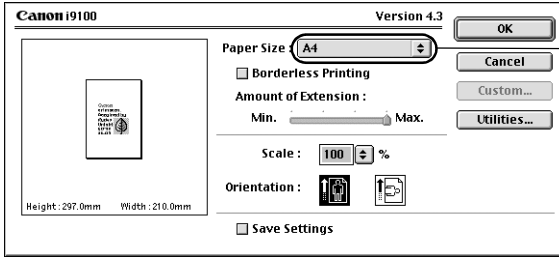

Select paper size you wish to use.

■ Basic Print Settings

For the best print quality, specify the minimum requirement settings in the **Print** dialog box. To get the best results, ensure you select the type of media loaded in the printer when printing on paper other than plain paper.

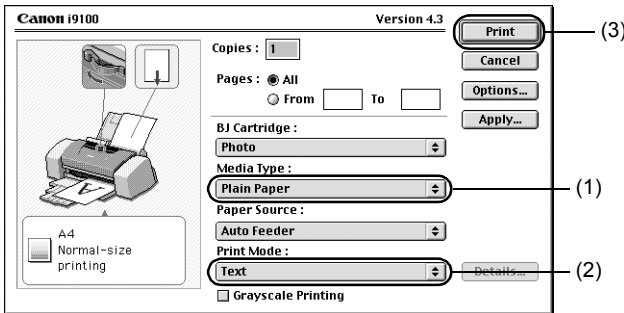

(1) Media Type	Select the type of media loaded in the printer.
(2) Print Mode	Select the type of document you want to print. To specify more detailed settings for the print quality or color, select Manual and click Details .
(3) Print	Click this to start printing.

➔ Notes

- See Balloon Help for more information about other printer driver functions. Select **Show Balloons** in the **Help** menu for an explanation of each of the items in the setting screen. To see the explanation, point to the item with the mouse.
- Refer to the User's Guide for more information about printer driver functionality.

Print Head Maintenance

■ If Blurring Occurs or If a Specific Color Does Not Print

Perform print head cleaning to improve the print quality. Ensure that the printer is turned on and follow the instructions below.

- Windows
Open the printer driver settings screen and click the **Maintenance** tab. Click **Cleaning**. See page 14 for details on how to open the setting screen.
- Macintosh
Open the **Page Setup** dialog box and click **Utilities**. Click **Cleaning**.

■ When the Printer Runs out of Ink

Replace the empty ink tank with a new one.
Specify the following ink tanks when purchasing.

Yellow	BCI-6Y
Magenta	BCI-6M
Cyan	BCI-6C
Photo Magenta	BCI-6PM Photo
Photo Cyan	BCI-6PC Photo
Black	BCI-6BK

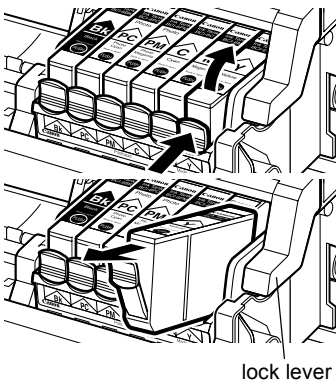

1 Open the front cover and remove the empty ink tank.

Do not touch the lock lever.

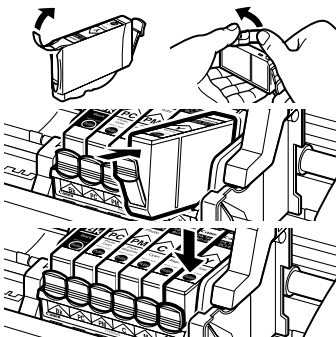

2 Install the new ink tank.

Close the front cover when finished.

→ **Note**

For more details about maintenance, refer to the User's Guide.

Notes on Handling the USB Interface (for Windows Users)

If installation of the printer driver does not proceed as instructed in this Quick Start Guide, there may be a problem with the USB driver installation. Try reinstalling the printer driver.

■ Reinstalling



If you cannot proceed beyond the **Printer Port** screen:

- 1** Click **Cancel**.
- 2** When the **Terminate Installation** screen is displayed, click **OK**.
- 3** Click **Exit**, then remove the CD-ROM.
- 4** Turn the printer off.
- 5** Restart the computer.
- 6** Reinstall the printer driver (see page 8).

For Further Details...

For more information, place the Setup Software & User's Guide CD-ROM in the CD-ROM drive.

■ User's Guide Contents

The "User's Guide" is an HTML manual you can browse through on your computer.

Contents

- How to Use This Manual
- Printer Parts and Their Function
- Further Printing Techniques
- Printing Media
- Checking the Status of the Printer
- Routine Maintenance
- Troubleshooting
- Appendix

■ How to View the User's Guide

For Windows

- (1) Load the CD-ROM in your computer.
- (2) Click **Documentation** at left of the screen.
- (3) Click **View Documents**.
- (4) When a message appears, click
 - **Yes** – to install the User's Guide
 - **No** – only to browse the User's Guide
- (5) Select **User's Guide** and click **OK**.
Follow the instructions on screen.

For Macintosh

- (1) Load the CD-ROM in your computer.
- (2) Double-click the **Manual** folder.
- (3) Select a language folder.
- (4) Double-click the **User's Guide** folder.
- (5) Double-click the icon for the **i9100_UG_ENG.htm** file.

■ BJ Printer Driver Systems Requirements

For Windows

- Use a computer on which Windows XP, Windows 2000, Windows Me or Windows 98 can operate.
- USB* interface
- Available hard-disk space for printer driver installation

Windows XP/Windows 2000 : 50MB

Windows Me/Windows 98 : 15MB

*USB operation can only be guaranteed on a PC with pre-installed Windows XP, Windows 2000, Windows Me, or Windows 98. (This includes Windows XP, Windows 2000 or Windows Me upgraded from pre-installed Windows 98 or later)

For Macintosh

(Macintosh 8.6-9.x)

- Use a Macintosh series computer equipped with USB interface on which Mac OS 8.6-9.x can operate.
- 30MB of available hard-disk space for printer driver installation.

(Macintosh OS X)

- Use a Macintosh series computer equipped with USB interface on which Mac OS X v10.2.1 or later can operate.
- 100MB of available hard-disk space for printer driver installation.
- The following functions are not supported:
 - Shared printer in the network (will be supported as an OS function with Mac OS X v10.2 or later)
 - Duplex Printing
 - Photo Optimizer PRO
- If you want to use an application, first install the application contained in the Mac OS X folder.

Additional Systems Requirements for User's Guide

- Pentium® 75 MHz equivalent or higher processor (Pentium® 133MHz equivalent or higher processor recommended)
- 2x or higher CD-ROM drive (4x or higher recommended)
- 20 MB of available hard-disk space (when installing the User's Guide)
- Microsoft Internet Explorer 5.0 or later

