

imageCLASS
MF3111
Basic Guide

Manuals for the Machine

The manuals for this machine are divided as follows. Please refer to them for detailed information. Depending on the system configuration and product purchased, some manuals may not be needed.



Guides with this symbol are printed manuals.



Guides with this symbol are PDF manuals included on the accompanying CD-ROM. (See footnote.)

- **Setting Up the Machine**
- **Software Installation**

- **Copying and Printing Instructions**
- **Troubleshooting**

- **Software Installation and Instructions**
- **Printing and Scanning Instructions**
- **Troubleshooting**

Set-Up Instructions



**Basic Guide
(This Manual)**



Software Guide



Model Name

- F146600 (imageCLASS MF3111)



How This Manual Is Organized

Chapter 1 Introduction

Chapter 2 Paper Handling

Chapter 3 Document Handling

Chapter 4 Printing from Your Computer

Chapter 5 Copying

Chapter 6 Scanning

Chapter 7 System Monitor

Chapter 8 Maintenance

Chapter 9 Troubleshooting

Chapter 10 Machine Settings

Chapter 11 Appendix

Includes the specifications of this machine and the index.

Contents

Preface	viii
How to Use This Manual	viii
Symbols Used in This Manual	viii
Keys Used in This Manual	viii
Messages Displayed in the LCD	ix
Legal Notices	x
FCC (Federal Communications Commission)	x
Laser Safety	xi
CDRH Regulations	xi
Trademarks	xii
Copyright	xii
Disclaimers	xii
Legal Limitations on the Usage of Your Product and the Use of Images	xiii
About the Part Containing Mercury (Applicable Only to the USA)	xiii
Important Safety Instructions	xiv
Installation	xiv
Power Supply	xv
Handling	xvi
Maintenance and Inspections	xvii
Consumables	xix
Other Warnings	xix

Chapter 1 Introduction

Customer Support	1-1
For Canadian Users	1-1
Main Components of the Machine	1-2
Operation Panel	1-4
Standby Display	1-5
Energy Saver Mode	1-6
Setting the Energy Saver Mode Manually	1-6
Restoring from the Energy Saver Mode Manually	1-7

Chapter 2 Paper Handling

Print Media Requirements	2-1
Printing Areas	2-3
Loading Paper	2-4

Loading Paper in the Cassette	2-4
Loading Paper in the Multi-Purpose Feeder	2-8
Loading an Envelope in the Multi-Purpose Feeder	2-9
Specifying the Paper Size and Type (Common for Cassette and Multi-Purpose Feeder)	2-11
Specifying the Paper Size	2-11
Specifying the Paper Type	2-12
Orientation of the Document and the Paper Loading	2-13
Selecting the Paper Output Area	2-14
Paper Type and Paper Output Area	2-14
Face Down Paper Output Area	2-15
Face Up Paper Output Area	2-16

Chapter 3 Document Handling

Document Requirements	3-1
Scanned Area of a Document	3-2
Placing a Document on the Platen Glass	3-3

Chapter 4 Printing from Your Computer

Before Printing	4-1
Printing Documents	4-3
Canceling Printing	4-4
More Information	4-5

Chapter 5 Copying

Documents You Can Copy	5-1
Making Copies	5-2
Setting Enlarging/Reducing	5-4
Enlarging/Reducing Using Preset Copy Ratios	5-4
Improving Copied Image	5-5
Adjusting the Image Quality (Resolution)	5-5
Adjusting the Exposure (Density)	5-5
Special Features	5-7
Collate Copy	5-7
2 on 1 Copy	5-8
Reserve Copy	5-10

Chapter 6 Scanning

Before Scanning	6-1
Scanning Methods	6-2

More Information	6-3
------------------------	-----

Chapter 7 System Monitor

Checking the Status of the Jobs Stored in the Machine	7-1
Confirming and Deleting a Copy Job	7-1
Confirming and Deleting a Print Job	7-2

Chapter 8 Maintenance

Periodic Cleaning	8-1
Cleaning the Exterior	8-1
Cleaning the Scanning Area	8-2
When to Replace the Cartridge	8-3
Print Yield	8-4
Approximate Print Yield	8-4
Handling and Storing the Cartridge	8-5
Handling Precautions	8-5
Storage Precautions	8-5
Storing Partially Used Cartridges	8-6
Recycling Used Cartridges	8-6
The Clean Earth Campaign	8-7
THE CANON CARTRIDGE RECYCLING PROGRAM	8-7
U.S.A. PROGRAM	8-8
Packaging	8-8
Shipping	8-10
CANADA PROGRAM-CANADA PROGRAMME	8-11
Replacing the Cartridge	8-13
Repacking and Transporting Your Machine	8-16
Carrying the Machine by the Sides	8-17
Transporting the Machine by Car	8-17

Chapter 9 Troubleshooting

Clearing Jams	9-1
LCD Messages	9-8
Paper Feeding Problems	9-11
Copying Problems	9-14
Print Quality Problems	9-15
Printing Problems	9-17
Scanning Problems	9-18
General Problems	9-19
If You Cannot Solve the Problem	9-20

Chapter 10 Machine Settings

- Accessing the Machine Settings 10-1**
- Menu Descriptions 10-2**
 - PAPER SETTINGS 10-2
 - COMMON SETTINGS 10-2
 - COPY SETTINGS 10-3
 - PRINTER SETTINGS 10-4
 - TIMER SETTINGS 10-4

Chapter 11 Appendix

- Specifications 11-1**
- Index 11-3**





Preface

Thank you for purchasing the Canon imageCLASS MF3110. Please read this manual thoroughly before operating the machine in order to familiarize yourself with its capabilities, and to make the most of its many functions. After reading this manual, store it in a safe place for future reference.

How to Use This Manual

Symbols Used in This Manual

The following symbols are used in this manual to explain procedures, restrictions, handling precautions, and instructions that should be observed for safety.

-  **WARNING** Indicates a warning concerning operations that may lead to death or injury to persons if not performed correctly. In order to use the machine safely, always pay attention to these warnings.
-  **CAUTION** Indicates a caution concerning operations that may lead to injury to persons, or damage to property if not performed correctly. In order to use the machine safely, always pay attention to these cautions.
-  **IMPORTANT** Indicates operational requirements and restrictions. Be sure to read these items carefully in order to operate the machine correctly, and to avoid damage to the machine.
-  **NOTE** Indicates a clarification of an operation, or contains additional explanations for a procedure. Reading these notes is highly recommended.

Keys Used in This Manual

The following symbols and key names are a few examples of how keys to be pressed are expressed in this manual. The operation panel keys on the machine are indicated within brackets.



Press [Start].



Press [Image Quality].

Messages Displayed in the LCD

The following are a few examples of how messages in the LCD are expressed in this manual. The messages are indicated within angle brackets.

- If <MEMORY FULL> is displayed, the machine cannot scan the documents.
- <2ON1> appears in the LCD.

Legal Notices

FCC (Federal Communications Commission)

imageCLASS MF3111: Model F146600

This device complies with Part 15 of the FCC Rules. Operation is subject to the following two conditions:

- (1) This device may not cause harmful interference, and
- (2) this device must accept an interference received, including interference that may cause undesired operation.

NOTE

This equipment has been tested and found to comply with the limits for a class B digital device, pursuant to Part 15 of the FCC Rules. These limits are designed to provide reasonable protection against harmful interference in a residential installation. This equipment generates, uses and can radiate radio frequency energy and, if not installed and used in accordance with the instructions, may cause harmful interference to radio communications. However, there is no guarantee that interference will not occur in a particular installation. If this equipment does cause harmful interference to radio or television reception, which can be determined by turning the equipment off and on, the user is encouraged to try to correct the interference by one or more of the following measures:

- Reorient or relocate the receiving antenna.
- Increase the separation between the equipment and receiver.
- Connect the equipment into an outlet on a circuit different from that to which the receiver is connected.
- Consult the dealer or an experienced radio/TV technician for help.

Use of shielded cable is required to comply with class B limits in Subpart B of Part 15 of the FCC Rules.

Do not make any changes or modifications to the equipment unless otherwise specified in this manual. If such changes or modifications should be made, you could be required to stop operation of the equipment.

Canon U.S.A. Inc.
One Canon Plaza, Lake Success, NY 11042, U.S.A.
TEL No. (516) 328-5600



IMPORTANT

- This Class B digital apparatus meets all requirements of the Canadian Interference-Causing Equipment Regulations.
- Cet appareil numérique de la classe B respecte toutes les exigences du Règlement sur le matériel brouilleur du Canada.

Laser Safety

This product complies with 21 CFR Chapter 1 Subchapter J as a Class I laser product under the U.S. Department of Health and Human Services (DHHS) Radiation Performance Standard according to the Radiation Control for Health and Safety Act of 1968. Class I levels of laser radiation are not considered to be hazardous.

Since radiation emitted inside the product is completely confined within protective housings and external covers, the laser beam cannot escape from the machine during any phase of user operation. Do not remove protective housings or external covers, except as directed by this manual.

CDRH Regulations

The Center for Devices and Radiological Health (CDRH) of the U.S. Food and Drug Administration implemented regulations for laser products on August 2, 1976. These regulations apply to laser products manufactured from August 1, 1976. Compliance is mandatory for products marketed in the United States.



CAUTION

Use of controls, adjustments or performance of procedures other than those specified in this manual may result in hazardous radiation exposure.

Trademarks

Canon, the Canon logo, and imageCLASS are trademarks of Canon Inc.

Other product and company names herein may be the trademarks of their respective owners.

Copyright

Copyright 2005 by Canon Inc. All rights reserved.

No part of this publication may be reproduced or transmitted in any form or by any means, electronic or mechanical, including photocopying and recording, or by any information storage or retrieval system without the prior written permission of Canon Inc.

Disclaimers

The information in this manual is subject to change without notice.

CANON INC. MAKES NO WARRANTY OF ANY KIND WITH REGARD TO THIS MATERIAL, EITHER EXPRESS OR IMPLIED, EXCEPT AS PROVIDED HEREIN, INCLUDING WITHOUT LIMITATION, THEREOF, WARRANTIES AS TO MARKETABILITY, MERCHANTABILITY, FITNESS FOR A PARTICULAR PURPOSE OF USE OR AGAINST INFRINGEMENT OF ANY PATENT. CANON INC. SHALL NOT BE LIABLE FOR ANY DIRECT, INCIDENTAL, OR CONSEQUENTIAL DAMAGES OF ANY NATURE, OR LOSSES OR EXPENSES RESULTING FROM THE USE OF THIS MATERIAL.

Legal Limitations on the Usage of Your Product and the Use of Images

Using your product to scan, print or otherwise reproduce certain documents, and the use of such images as scanned, printed or otherwise reproduced by your product, may be prohibited by law and may result in criminal and/or civil liability. A non-exhaustive list of these documents is set forth below. This list is intended to be a guide only. If you are uncertain about the legality of using your product to scan, print or otherwise reproduce any particular document, and/or of the use of the images scanned, printed or otherwise reproduced, you should consult in advance with your legal advisor for guidance.

- Paper Money
- Money Orders
- Certificates of Deposit
- Postage Stamps (canceled or uncanceled)
- Identifying Badges or Insignias
- Selective Service or Draft Papers
- Checks or Drafts Issued by Governmental Agencies
- Motor Vehicle Licenses and Certificates of Title
- Travelers Checks
- Food Stamps
- Passports
- Immigration Papers
- Internal Revenue Stamps (canceled or uncanceled)
- Bonds or Other Certificates of Indebtedness
- Stock Certificates
- Copyrighted Works/Works of Art without Permission of Copyright Owner

About the Part Containing Mercury (Applicable Only to the USA)

(Hg) LAMP(S) INSIDE THIS PRODUCT CONTAIN MERCURY AND MUST BE RECYCLED OR DISPOSED OF ACCORDING TO LOCAL, STATE OR FEDERAL LAWS



Important Safety Instructions

Please read these "Important Safety Instructions" thoroughly before operating the machine. As these instructions are intended to prevent injury to the user or other persons or destruction of property, always pay attention to these instructions. Also, since it may result in unexpected accidents or injuries, do not perform any operation unless otherwise specified in the manual. Improper operation or use of this machine could result in personal injury and/or damage requiring extensive repair that may not be covered under your Limited Warranty.

Installation

WARNING

- Do not install the machine near alcohol, paint thinner, or other flammable substances. If flammable substances come into contact with electrical parts inside the machine, it may result in a fire or electrical shock.
- Do not place the following items on the machine. If these items come into contact with a high-voltage area inside the machine, it may result in a fire or electrical shock. If these items are dropped or spilled inside the machine, immediately disconnect the power cord from the power outlet. Then, contact Canon Authorized Service Facilities or the Canon Customer Care Center.
 - Necklaces and other metal objects
 - Cups, vases, flowerpots, and other containers filled with water or liquids

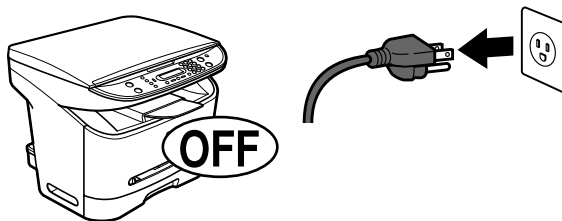

CAUTION

- Do not install the machine in unstable locations, such as unsteady platforms or inclined floors, or in locations subject to excessive vibrations, as this may cause the machine to fall or tip over, resulting in personal injury.
- Never block the ventilation slots and louvers on the machine. These openings are provided for proper ventilation of working parts inside the machine. Blocking these openings can cause the machine to overheat. Never place the machine on a soft surface, such as a sofa or rug.

- Do not install the machine in the following locations:
 - A damp or dusty location
 - A location near water faucets or water
 - A location exposed to direct sunlight
 - A location subject to high temperatures
 - A location near open flames
 - A location near devices that contain magnets or generate magnetic fields, such as speakers
- Avoid poorly ventilated locations.
During use, the machine generates ozone. However, the amount of ozone generated is not enough to affect the human body. Nevertheless, if the machine is used for a prolonged period of time in a poorly ventilated room, or when making a large quantity of prints, be sure to ventilate the room to make the working environment as comfortable as possible.
- Make sure the machine is approximately 4" (10 cm) away from walls and other equipment for proper ventilation.
- Make sure the location is not affected by extreme temperature changes, and always stays between 50°F and 90.5°F (10°C and 32.5°C).
- Make sure the relative humidity of the area is between 20% and 80%.
- Do not use or store the machine outdoors.

Power Supply

WARNING

- Do not damage or modify the power cord. Also, do not place heavy objects on the power cord, or pull on or excessively bend it, as this could cause electrical damage and result in a fire or electrical shock.
- Keep the power cord away from a heat source; failure to do this may cause the power cord coating to melt, resulting in a fire or electrical shock.
- Do not connect or disconnect the power cord with wet hands, as this may result in electrical shock.
- Do not connect the power cord to a multiplug power strip, as this may cause a fire or electrical shock.
- Do not bundle up or tie the power cord in a knot, as this may result in a fire or electrical shock.
- Insert the power plug completely into the power outlet, as failure to do so may result in a fire or electrical shock.
- Do not use power cords other than the power cord provided, as this may result in a fire or electrical shock.
- As a general rule, do not use extension cords. Using an extension cord may result in a fire or electrical shock. If an extension cord must be used, however, use one rated for voltages of 120 V AC and over, untie the cord binding, and insert the power plug completely into the extension cord outlet to ensure a firm connection between the power cord and the extension cord.

CAUTION

- Do not use power supplies with voltages other than those specified herein, as this may result in a fire or electrical shock.
- Always grasp the power plug when disconnecting the power cord. Pulling on the power cord may expose or snap the core wire, or otherwise damage the power cord. If the power cord is damaged, this could cause current to leak, resulting in a fire or electrical shock.
- Leave sufficient space around the power plug so that it can be unplugged easily. If objects are placed around the power plug, you will be unable to unplug it in an emergency.
- During electrical storms, unplug the power cord from the power outlet. Electrical storms may cause damage to the machine and result in a fire or electrical shock.

IMPORTANT

- If dust accumulates around the plug of the power cord when it is connected to a power outlet, unplug the machine and wipe the plug with a clean, dry cloth.
- Do not plug the machine into the same circuit with appliances such as an air conditioner, television or copier. These devices generate an electrical noise, and may interfere with your machine's operation.
- Unplug the machine in the following conditions:
 - When the power cord or plug is damaged or frayed.
 - If liquid has spilled into the machine.
 - If the machine has been exposed to rain or water.
 - If the machine does not operate normally when you have followed the instructions in the guides included with your machine. Adjust only those controls that are covered by the instructions in the guides since improper adjustment of other controls may result in damage and will often require extensive work by a qualified technician to restore the product to normal operation.
 - If the machine has been dropped or damaged.
 - If the machine exhibits a distinct change in performance, indicating a need for servicing.

Handling

WARNING

- Do not attempt to disassemble or modify the machine. There are high-temperature and high-voltage components inside the machine which may result in a fire or electrical shock.
- If the machine makes strange noises, or gives off smoke, heat, or strange smells, immediately disconnect the power cord from the power outlet. Then, contact Canon Authorized Service Facilities or the Canon Customer Care Center. Continued use of the machine in this condition may result in a fire or electrical shock.
- Do not use highly flammable sprays near the machine. If gas from these sprays comes into contact with the electrical components inside the machine, it may result in a fire or electrical shock.

- To avoid damage to the power cord and creating a fire hazard, always disconnect the power cord and the interface cable when moving the machine. Otherwise, the power cord or interface cable may be damaged, resulting in a fire or electrical shock.
- Do not drop paper clips, staples, or other metal objects inside the machine. Also, do not spill water, liquids, or flammable substances (alcohol, benzene, paint thinner, etc.) inside the machine. If these items come into contact with a high-voltage area inside the machine, it may result in a fire or electrical shock. If these items are dropped or spilled inside the machine, immediately disconnect the power cord from the power outlet. Then, contact Canon Authorized Service Facilities or the Canon Customer Care Center.

CAUTION

- Do not place heavy objects on the machine, as they may tip over or fall resulting in personal injury.
- Disconnect the power cord for safety when the machine will not be used for an extended period of time, such as during consecutive holidays.
- The laser beam can be harmful to human bodies. Since radiation emitted inside the product is completely confined within protective housings and external covers, the laser beam cannot escape from the machine during any phase of user operation. Read the following remarks and instructions for safety.
- Close the platen glass cover gently to avoid catching your hand. Failing to do so may result in personal injury.
- Do not press down hard on the platen glass cover when using the platen glass to scan a thick book. This may damage the platen glass and/or result in personal injury.
- Do not subject the machine to strong physical shock or vibration.
- Unplug the machine before moving it.
- Do not lift the machine by any of its attachments.
- If the machine exhibits a distinct change in performance, this indicates a need for servicing.

Maintenance and Inspections

WARNING

- When cleaning the machine, disconnect the power cord. Failure to observe these steps may result in a fire or electrical shock.
- Disconnect the power cord from the power outlet regularly, and clean the area around the base of the power plug's metal pins and the power outlet with a dry cloth to ensure that all dust and grime is removed. If the power cord is connected for a long period of time in a damp, dusty, or smoky location, dust can build up around the power plug and become damp. This may cause a short circuit and result in a fire.
- Clean the machine using a slightly dampened cloth with a mild detergent mixed with water. Do not use alcohol, benzene, paint thinner, or other flammable substances. Check detergent for flammability prior to use. If flammable substances come into contact with a high-voltage area inside the machine, it may result in a fire or electrical shock.

- There are some areas inside the machine which are subject to high-voltages. When removing jammed paper or when inspecting the inside of the machine, do not allow necklaces, bracelets, or other metal objects to touch the inside of the machine, as this may result in burns or electrical shock.
- Do not burn or throw used toner cartridges into open flames, as this may cause the toner remaining inside the cartridge to ignite, resulting in burns or a fire.

⚠ CAUTION

- The toner fixing unit and its surroundings inside the machine may become hot during use. When removing jammed paper or when inspecting the inside of the machine, do not touch the toner fixing unit and its surroundings, as doing so may result in burns or electrical shock.

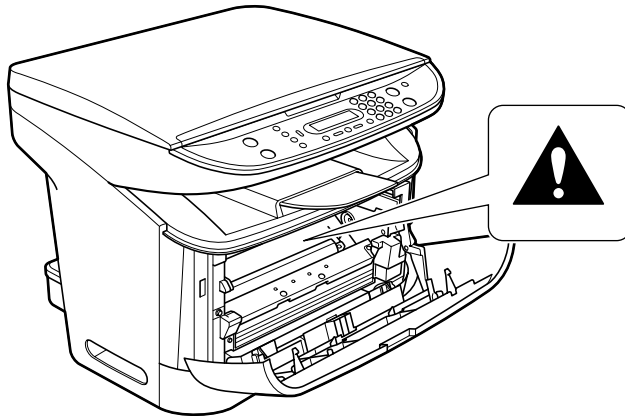

- When removing jammed paper or replacing the toner cartridge, take care not to allow the toner to come into contact with your hands or clothing, as this will dirty your hands or clothing. If they become dirty, wash them immediately with cold water. Washing them with warm water will set the toner, and make it impossible to remove the toner stains.
- When removing paper which has become jammed inside the machine, remove the jammed paper gently to prevent the toner on the paper from scattering and getting into your eyes or mouth. If the toner gets into your eyes or mouth, wash them immediately with cold water and immediately consult a physician.
- When loading paper or removing jammed documents or paper, take care not to cut your hands on the edges of the documents or paper.
- When removing a used toner cartridge from the machine, remove the cartridge carefully to prevent the toner from scattering and getting into your eyes or mouth. If the toner gets into your eyes or mouth, wash them immediately with cold water and immediately consult a physician.

Consumables

WARNING

- Do not burn or throw used toner cartridges into open flames, as this may cause the toner remaining inside the cartridges to ignite, resulting in burns or a fire.
- Do not store toner cartridges or copy paper in places exposed to open flames, as this may cause the toner or paper to ignite, resulting in burns or a fire.
- When discarding used toner cartridges, put the cartridges in a bag to prevent the toner remaining inside the cartridges from scattering, and dispose of them in a location away from open flames.

CAUTION

Keep toner and other consumables out of the reach of small children. If these items are ingested, consult a physician immediately.

Other Warnings

WARNING

For cardiac pacemaker users:

This product generates a low level magnetic field. If you use a cardiac pacemaker and feel abnormalities, please move away from the product and consult a physician.

CAUTION

Follow all warnings and instructions marked on the machine.

Introduction

1

CHAPTER

This chapter describes the main components, the operation panel and the standby display of the machine. It also explains how to set the energy saver function.

Customer Support

Your machine is designed with the latest technology to provide trouble-free operation. If you encounter a problem with the machine's operation, try to solve it by using the information in Chapter 9, "Troubleshooting." If you cannot solve the problem or if you think your machine needs servicing, contact Canon Authorized Service Facilities or the Canon Customer Care Center at 1-800-828-4040 between the hours of 8:00 A.M. to 8:00 P.M. EST Monday through Friday and 10:00 A.M. to 8:00 P.M. on Saturday.

For Canadian Users

Canon Canada Inc., offers a full range of customer technical support* options:

- For interactive troubleshooting, e-mail technical support, the latest driver downloads and answers to frequently asked questions (www.canon.ca)
- Automated interactive telephone support on most current products 24 hours, 7 days a week (1-800-652-2666).
- Free live technical support 9:00 A.M. to 8:00 P.M. EST Monday through Friday (excluding holidays) for products still under warranty (1-800-652-2666)
- The location of the authorized service facility nearest you (1-800-652-2666)

If the problem cannot be corrected by using one of the above technical support options, repair options are available at the time of your call to the Free live technical support number above or via the website at www.canon.ca

* Support program specifics are subject to change without notice.

Main Components of the Machine

This section describes the main components of the machine.

Front View

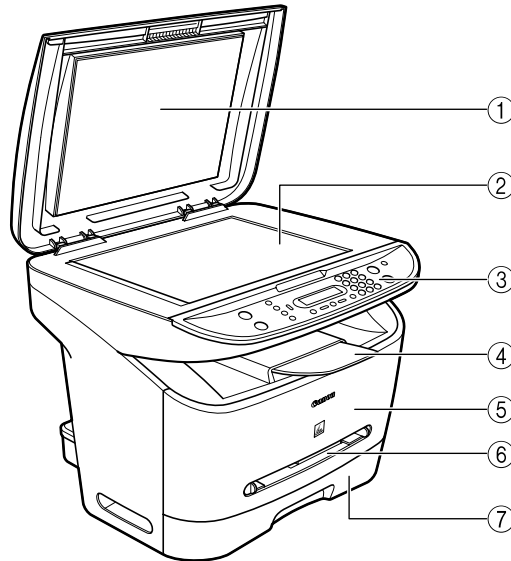

① **Platen glass cover**

Open it when you place documents on the platen glass for copying or scanning.

② **Platen glass**

Place documents.

③ **Operation panel**

Controls the machine.

④ **Output tray**

Outputs printouts.

⑤ **Front cover**

Open it when you install the cartridge, or remove jammed paper.

⑥ **Multi-purpose feeder**

Used when printing paper one by one manually.

⑦ **Cassette**

Holds the paper supply.

Rear View

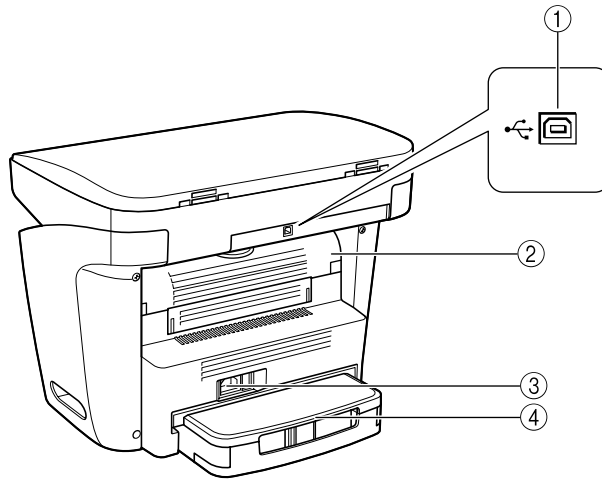

① **USB port**

Connect the USB (Universal Serial Bus) cable.

② **Face up cover**

Open it when you output paper face up, or remove jammed paper.

③ **Power socket**

Connect the power cord.

④ **Extension cover**

Protects paper supply in the cassette from dirt and dust.

Operation Panel

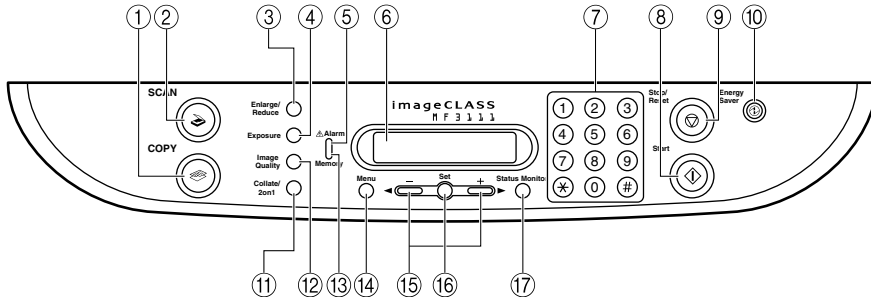

- ① **COPY key**
Switches the standby display to the Copy mode.
- ② **SCAN key**
Switches the standby display to the Scan mode.
- ③ **Enlarge/Reduce key**
Sets an enlargement or reduction ratio of the copy.
- ④ **Exposure key**
Adjusts the copy exposure.
- ⑤ **Alarm indicator**
Flashes red when the machine has a problem such as a paper jam. (The error message is displayed in the LCD.)
- ⑥ **LCD**
Displays messages and prompts during operation. Also displays selections, text, and numbers when specifying settings.
- ⑦ **Numeric keys**
Enter copy quantity and other numerical values.
- ⑧ **Start key**
Starts copying.
- ⑨ **Stop/Reset key**
Cancels copying and other operations, and returns to the standby display.
- ⑩ **Energy Saver key**
Sets or cancels the energy saver mode manually. The key lights green when the energy saver mode is set, and goes off when the mode is canceled.
- ⑪ **Collate/2on1 key**
Sorts copies in order of pages or reduces two documents to fit on a single sheet.
- ⑫ **Image Quality key**
Adjusts the quality of copies.
- ⑬ **Memory indicator**
Lights green during copying or when the copy job is stored in the memory.
- ⑭ **Menu key**
Customizes the way your machine operates.
- ⑮ **[◀(-)] or [▶(+)] keys**
Scroll through the selections so you can see other settings.
- ⑯ **Set key**
Sets or registers the contents you select.
- ⑰ **Status Monitor key**
Checks the status of copy and print jobs.

Standby Display

The standby display differs depending on which mode is selected.

The standby display in the Copy or Scan mode is as follows:

■ Copy Mode

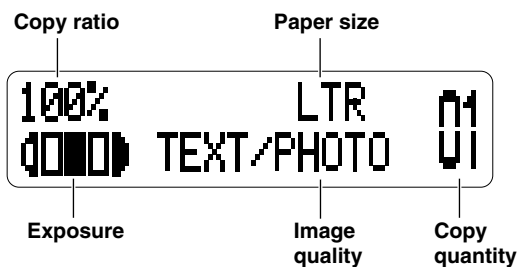

■ Scan Mode

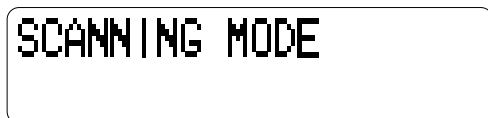

NOTE

When the machine is plugged in, the LCD displays <INITIALIZING...> for a while, then the standby display appears.

Energy Saver Mode

This machine provides an energy saver function. When no operations are performed for about 5 minutes, the machine automatically enters the energy saver mode.

 NOTE

- The time until the machine enters the energy saver mode can be specified in a range of 3 minutes to 30 minutes. You can also turn off the energy saver function. For details on the energy saver mode settings, see <2. ENERGY SAVER> of "Menu Descriptions," on p. 10-4.
- The energy saver function does not activate when the machine is in the following conditions:
 - When printing or copying
 - When scanning
 - While a copy job is saved in the memory or when the collate copy or other functions are operating, or when the Memory indicator lights up
 - When paper jams occur
 - When an error code appears and the Alarm indicator flashes
 - When no paper is loaded in the cassette
 - When paper is loaded in the multi-purpose feeder
- The machine will be restored from the energy saver mode when receiving print jobs from your computer.

Setting the Energy Saver Mode Manually

1 Press [Energy Saver].

The LCD is turned off and the Energy Saver key lights up.

 NOTE

Right after the machine is restored from the energy saver mode, or right after copying finishes, wait about 15 seconds before pressing [Energy Saver].

Restoring from the Energy Saver Mode Manually

1 Press [Energy Saver].

The Energy Saver key goes off and the machine enters the standby mode.

NOTE

The machine can be restored from the energy saver mode immediately. However, it may vary according to room temperature and circumstances.

Paper Handling

2

CHAPTER

This chapter describes the media you can use with this machine, how to load them, and where the documents come out.

Print Media Requirements

For high-quality copies, we recommend using paper and transparencies recommended by Canon. Some types of paper available at office supply stores may not be suitable for this machine. If you have any questions about paper and transparencies, contact Canon Authorized Service Facilities or the Canon Customer Care Center.

■ Paper Storage

In order to prevent paper jams, follow this procedure below:

- To prevent moisture buildup, store remaining paper wrapped tightly in its original package. Store paper in a dry location, out of direct sunlight.
- To prevent curling, store paper flat, not upright.
- If the paper is curled, uncurl it before loading it in the cassette or multi-purpose feeder. Failure to do so will cause paper creases and a paper jam.

■ Unacceptable Paper

Do not copy on the following types of copy stock. Doing so may result in paper jams.

- Severely curled or wrinkled paper
- Transparencies designed for full-color copiers or printers
- Paper which has already been copied using a digital full-color copier (Do not copy on the reverse side.)
- Paper which has been printed on using a thermal transfer printer (Do not copy on the reverse side.)



IMPORTANT

Never attempt to make copies on full-color transparencies. Doing so may result in product malfunction.

■ Acceptable Paper

	Cassette/Multi-Purpose Feeder
Paper Size	A4, B5, A5, Executive, Letter, Legal, Envelope*: COM10, Monarch, DL, ISO-C5
Paper Weight	17 lb to 34 lb (64 g/m ² to 128 g/m ²)
Paper Type	Plain paper, Recycled paper, Heavy paper, Transparency, Envelope

* Only for the multi-purpose feeder.



NOTE

- The printing speed may become slower than usual depending on the paper size, the paper type, and the number of sheets you specify.
This is because the machine's safety function works to prevent the failure due to heat.
- Some types of paper may not feed properly into the cassette or the multi-purpose feeder.

Printing Areas

Please note that the term "printing area" represents both the recommended area for optimum print quality and the entire area where the machine can technically print from your computer.

Printing area (light shade): Canon recommends that you print within this area.

■ Paper

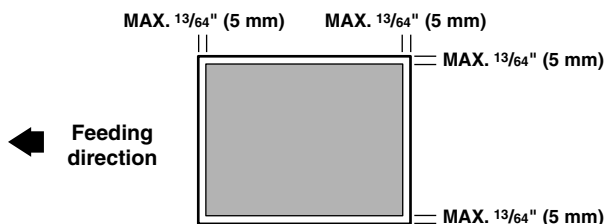

■ Envelope



NOTE

Copying areas are a little larger than printing areas.

Loading Paper

This section describes how to load paper in the cassette and the multi-purpose feeder.

⚠ CAUTION

When loading paper, take care not to cut your hands on the edges of the paper.

🚫 IMPORTANT

Do not load paper from the back of the machine with the cassette in place. Doing so may damage the paper feeding assembly inside the machine.

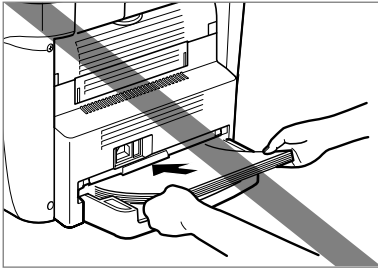

✎ NOTE

- The paper in the multi-purpose feeder is fed prior to the paper in the cassette.
- The cassette holds up to approximately 250 sheets of 17 lb (64 g/m²) paper.

Loading Paper in the Cassette

- 1** Fan the paper stack first, then tap the edges on a flat surface to even the stack.

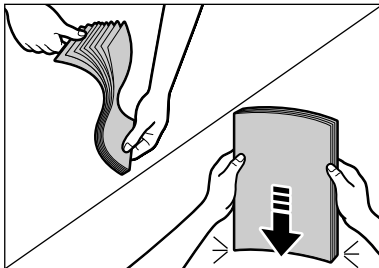

2 Pull out the cassette completely.

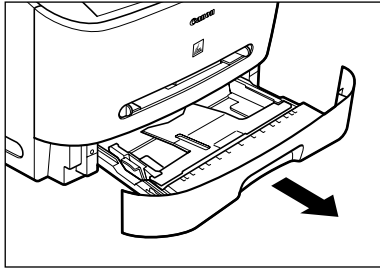

3 While holding the lock release lever on the paper guide at the rear of the cassette, slide the paper guide to the mark indicating the desired paper size.

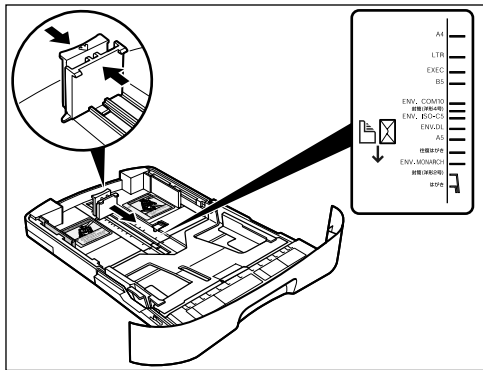

● When Loading Legal Size Paper:

- Pull the blue tab (A) and extend the cassette (B). Set the paper guide to LTR (C).

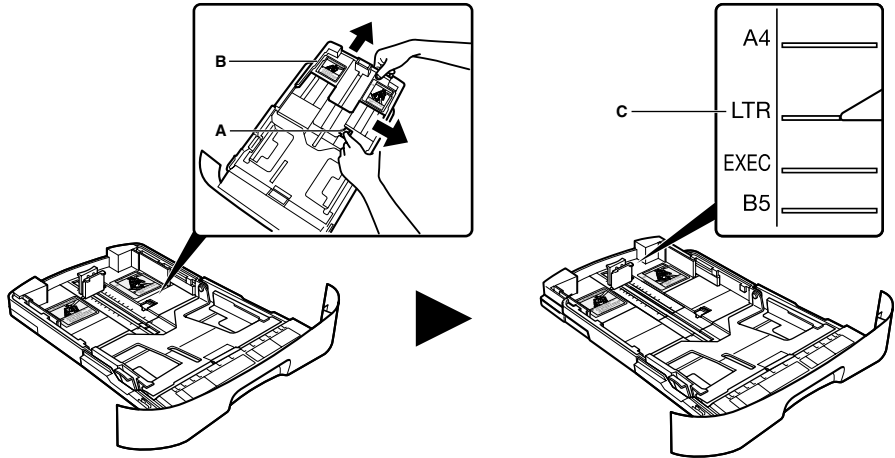

👉 IMPORTANT

If the paper guide is not adjusted correctly for the size of the paper, the quality of your printouts may be adversely affected.

4 Load the paper stack in the cassette with the print side down.

When you load paper with a logo on, position the paper with the print side down (logo side) and load it so that the top of the paper feeds first in the cassette.

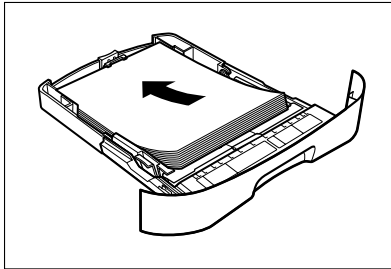

5 While holding the lock release lever on the paper guide on either side of the cassette, slide the paper guide to the mark indicating the desired paper size.

The paper guides on the sides of the cassette move together.

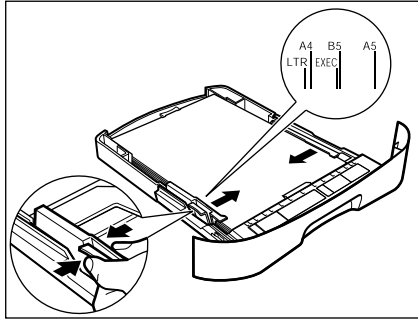

Make sure the paper stack does not exceed the load limit mark (A) and it is loaded under the hooks (B) on the paper guides.

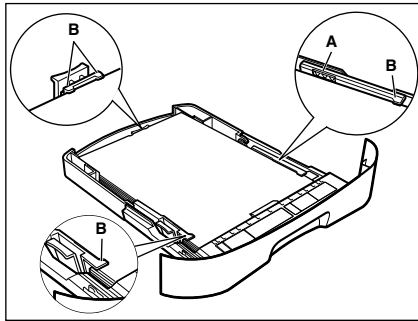

IMPORTANT

- Do not load different size and type of paper at the same time.
- Do not load extra paper when there is still paper left in the cassette.
If you load extra paper while making copies, remove the loaded paper first.
Then put it together with the extra paper and tap the edges. After that, reload it in the cassette.

6 Insert the cassette into the machine.

NOTE

If you do not completely insert the cassette into the machine, paper jams may occur.

7 Specify the size and the type of the paper you load.

For details on how to specify the paper size and type, see "Specifying the Paper Size and Type (Common for Cassette and Multi-Purpose Feeder)," on p. 2-11.

Loading Paper in the Multi-Purpose Feeder

Use the multi-purpose feeder when you want to copy or print on the different paper which is in the cassette. Load paper one by one in the multi-purpose feeder.

NOTE

The paper in the multi-purpose feeder is fed prior to the paper in the cassette.

1 Slide the paper guides to the mark of the desired paper size.

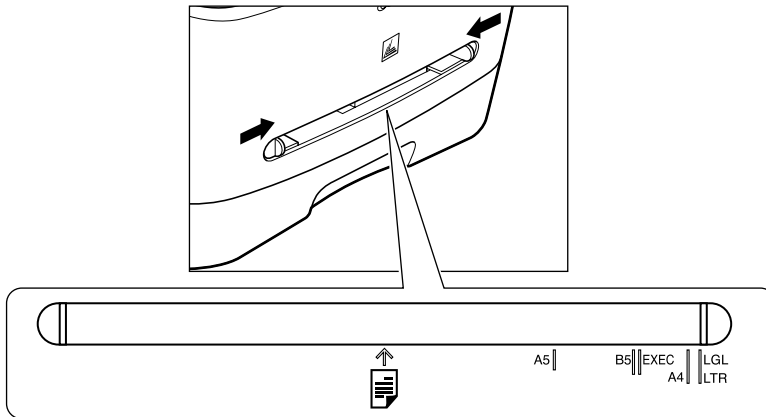

IMPORTANT

If the paper guides are not adjusted correctly for the size of the paper, the quality of your printouts may be adversely affected.

2 Insert the paper square into the multi-purpose feeder with the print side up.

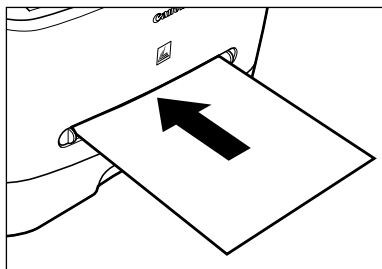

NOTE

When you load paper with a logo on, position the paper with the print side up (logo side) and insert it so that the top of the paper feeds first in the multi-purpose feeder.

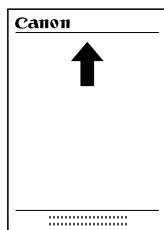

3 Specify the size and the type of the paper you load.

For details on how to specify the paper size and type, see "Specifying the Paper Size and Type (Common for Cassette and Multi-Purpose Feeder)," on p. 2-11.

Loading an Envelope in the Multi-Purpose Feeder

Use the multi-purpose feeder when you want to copy or print an envelope one by one.

IMPORTANT

The recommended envelopes are COM10, MONARCH, DL, and ISO-C5. Using other envelopes may affect the quality of the printout.

NOTE

The envelope in the multi-purpose feeder is fed prior to the paper in the cassette.

- 1** Slide the paper guides to fit the size of the envelope you want to load.

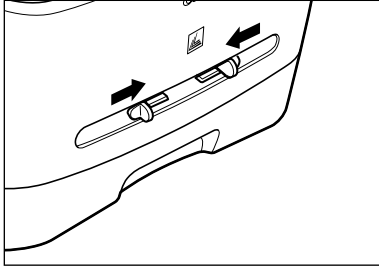

IMPORTANT

If the paper guides are not adjusted correctly for the size of the envelope, the quality of your printouts may be adversely affected.

- 2** Insert the envelope square into the multi-purpose feeder with the print side up and the right edge (i.e., closer to the stamp) first.

If the envelope to be loaded has a flap on the short edge, this edge must enter the machine first. Not loading it this way will result in a paper jam.

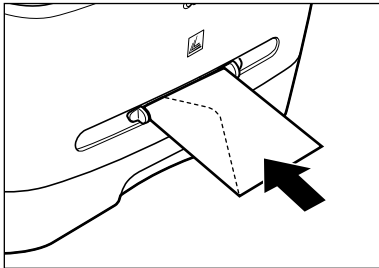

- 3** Specify the size and the type of the paper you load.

For details on how to specify the paper size and type, see "Specifying the Paper Size and Type (Common for Cassette and Multi-Purpose Feeder)," on p. 2-11.

Specifying the Paper Size and Type (Common for Cassette and Multi-Purpose Feeder)

Specifying the Paper Size

At the factory, the paper size has already been set to <LTR>. Each time you change the paper size you load in the cassette or the multi-purpose feeder, it is necessary to specify the paper size according to the following.

- 1** Press [Menu].
- 2** Press [◀(-)] or [▶(+)] to select <PAPER SETTINGS> → press [Set].
- 3** Press [◀(-)] or [▶(+)] to select <CASSETTE> or <MP TRAY> → press [Set].
- 4** Press [◀(-)] or [▶(+)] to select <PAPER SIZE> → press [Set].
- 5** Press [◀(-)] or [▶(+)] to select the appropriate paper size → press [Set].

You can select from the following paper sizes: LTR (Letter), LGL (Legal), A4, B5, A5, EXECUTIV (Executive), COM10, MONARCH, DL, and ISO-C5.



NOTE

Select <COM10>, <MONARCH>, <DL>, or <ISO-C5> for envelopes.

- 6** Press [Stop/Reset] to return to the standby display.

Specifying the Paper Type

<PLAIN PAPER> is selected as the default paper type. When using paper other than plain paper, you can specify the paper type according to the following. Specifying the paper type can prevent poor copy quality, or the printout not being printed correctly.

2

Paper Handling

1 Press [Menu].

2 Press [◀(-)] or [▶(+)] to select <PAPER SETTINGS> → press [Set].

3 Press [◀(-)] or [▶(+)] to select <CASSETTE> or <MP TRAY> → press [Set].

4 Press [◀(-)] or [▶(+)] to select <PAPER TYPE> → press [Set].

5 Press [◀(-)] or [▶(+)] to select the appropriate paper type → press [Set].

You can select from the following paper types:

- Plain paper (17 lb to 24 lb (64 g/m² to 90 g/m²)): <PLAIN PAPER>, <PLAIN PAPER L>*¹
- Heavy paper (25 lb to 34 lb (91 g/m² to 128 g/m²)): <HEAVY PAPER>, <HEAVY PAPER H>*²
- Transparency: <TRANSPARENCY>
- Envelope: <HEAVY PAPER>, <HEAVY PAPER H>*²

*¹ If paper curls excessively when printed with <PLAIN PAPER> selected, select <PLAIN PAPER L>.

*² If print fixing is not sufficient when printed with <HEAVY PAPER> selected, select <HEAVY PAPER H>.

6 Press [Stop/Reset] to return to the standby display.

Orientation of the Document and the Paper Loading

When you place a document on the platen glass, the orientation of the document and the orientation of the paper in the cassette or in the multi-purpose feeder are as shown below.

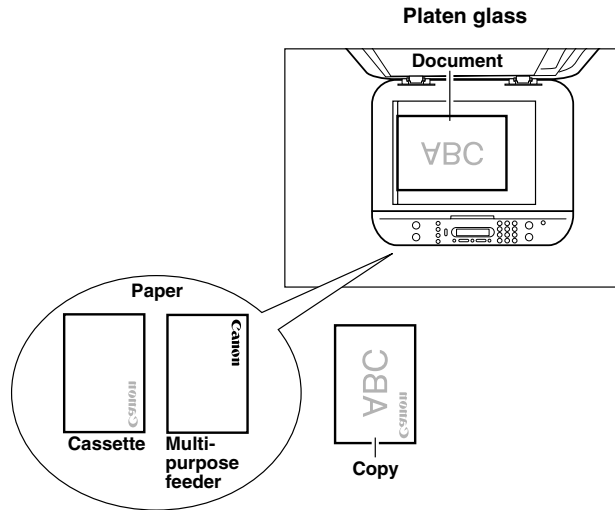

Selecting the Paper Output Area

Face down paper output delivers paper with the printed side down on the output tray. Face up paper output delivers paper with the printed side up from the output area. Select the area depending on your purpose by opening or closing the face up cover.

Open the face up cover for face up paper output, or close the face up cover and pull out the output tray for face down paper output.

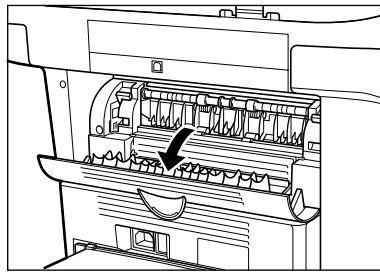

IMPORTANT

Do not open or close the face up cover while copying and printing.

Paper Type and Paper Output Area

Select the suitable paper output area depending on the paper type and your purpose.

Paper Type	Paper Output Area	The Number of Output Sheets
Plain Paper	face up	1 sheet
	face down	approx. 60 sheets (17 lb to 20 lb (64 g/m ² to 75 g/m ²))
Recycled Paper	face up	1 sheet
	face down	approx. 30 sheets (17 lb to 20 lb (64 g/m ² to 75 g/m ²))
Heavy Paper	face up	1 sheet
	face down	approx. 30 sheets (20 lb to 34 lb (75 g/m ² to 128 g/m ²))

Paper Type	Paper Output Area	The Number of Output Sheets
Transparencies	face up	1 sheet
	face down	10 sheets
Envelopes	face up	1 sheet
	face down	10 sheets

Face Down Paper Output Area

The paper is delivered with the printed side down on the output tray. Paper is stacked in printed order.

Close the face up cover, and pull out the output tray.

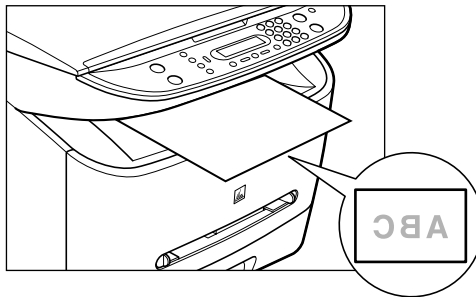

IMPORTANT

- Do not place the delivered paper back on the output tray. Doing so may result in paper jams.
- Do not place objects other than paper on the output tray. Doing so may result in paper jams.

Face Up Paper Output Area

The paper is delivered with the printed side up from the face up paper output at the rear of the machine.

This way is convenient for printing on transparencies, or envelopes which tend to curl, because the paper is delivered straight through out of the machine.

Open the face up cover.

- Remove the delivered paper one by one.

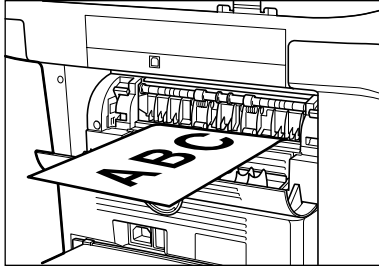

IMPORTANT

- Do not pull the paper forcibly.
- This machine has no face up output tray. Remove the delivered paper with your hand.
- Do not place an object in front of the face up paper output to prevent a paper jam.

Document Handling

3

CHAPTER

This chapter describes the types of documents you can scan or copy with this machine and how to set them on the platen glass.

Document Requirements

The documents you place on the platen glass for copying or scanning must meet these requirements:

	Platen Glass
Type of Document	Plain paper Thick documents Photographs Small documents (e.g., index cards) Special types of paper (e.g., tracing paper*, transparencies*, etc.) Book
Size (W x L)	Max. 8 1/2" x 11 3/4" (216 mm x 297 mm)
Quantity	1 sheet
Weight	Max. 4.4 lb (2 kg)

* When scanning, and copying a transparent document such as tracing paper or transparencies, place a piece of plain white paper behind the document.

NOTE

- When making copies of a small size document, the copy speed may be slightly slower than usual.
- Make sure any glue, ink, or correction fluid on the document is completely dry before placing it on the platen glass.

Scanned Area of a Document

The shaded area in the illustration below shows the scanned area of a document. Make sure your document's text and graphics are within this area.

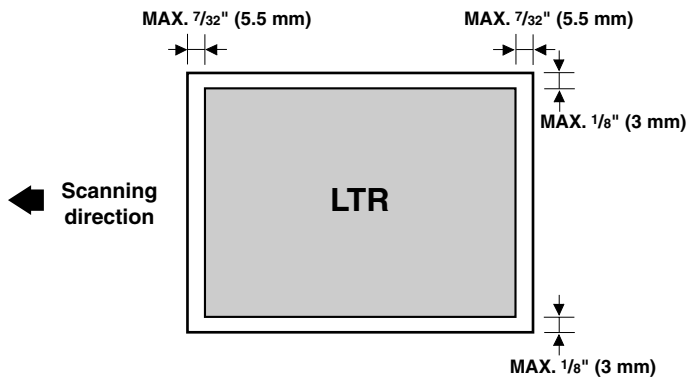

Placing a Document on the Platen Glass

1 Open the platen glass cover.

2 Place your document face down on the platen glass.

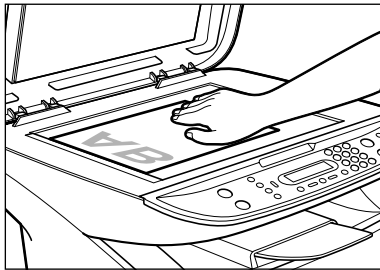

Use the paper size marks on the left side of the platen glass to position a document.

- If your document conforms to a standard paper size (e.g., LTR or A4), align the document between the appropriate paper size marks.
- If you do not know the size of your document, or if your document does not match any of the paper size marks, align the center of your document with the → mark.

The illustration below shows how to place an LTR-size document on the platen glass.

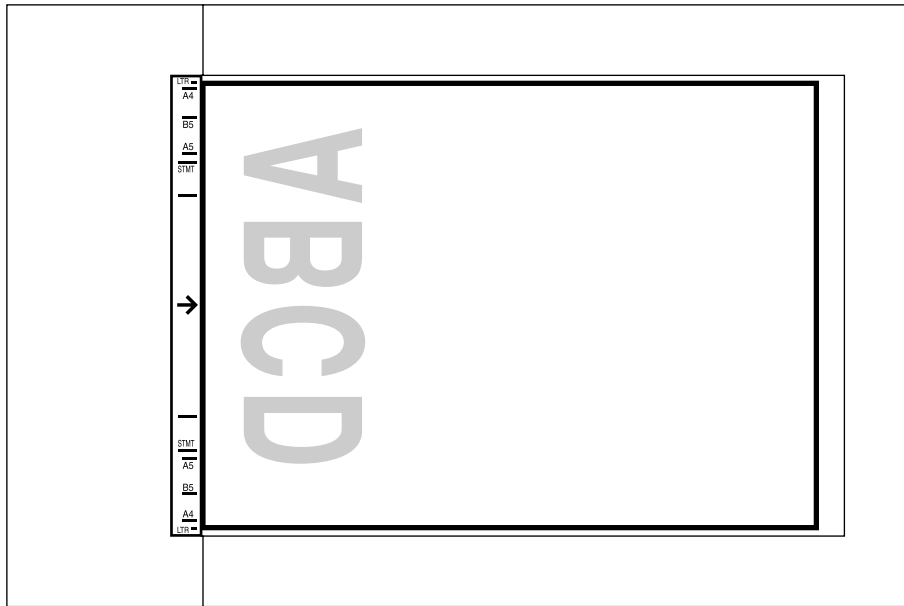

3

Document Handling

3 Gently lower the platen glass cover.

The document is now ready for scanning.

Printing from Your Computer

4

CHAPTER

This chapter explains how to print the documents from your computer using the printer driver included in the CD-ROM.

Before Printing

Before printing, software must be installed in your computer.

- If not, please see the *Set-Up Instructions* or Chapter 1, "Installation," in the *Software Guide*.

Check if the machine is selected as the default printer.

- You can check if your machine is set as the default printer when you open the [Print] dialog box in an application and your machine is selected in the printer box. (See "Printing Documents," on p. 4-3.)

Follow this procedure if it is not selected:

1 Open the [Printers and Faxes] (Windows 98/Me/2000: [Printers]) folder.

● On Windows XP:

- Click [Start] on the Windows task bar → select [Printers and Faxes].

● On Windows 98/Me/2000:

- Click [Start] on the Windows task bar → select [Settings] → [Printers].

2 Click the corresponding printer driver icon.

3 From the [File] menu, click [Set as Default Printer] (Windows 98/Me: [Set as Default]).

Printing Documents

The general steps for printing a document are explained below.

1 Load paper in the cassette or the multi-purpose feeder.

For details on how to load paper, see "Loading Paper," on p. 2-4.

2 Open the document in an application.

3 Select the command to print.

In most cases, click [Print] in the [File] menu.

The [Print] dialog box appears.

4 From the [Select Printer] list box or the [Name] pull-down list in the [Print] dialog box, select the printer to be used.

5 Click [Preference] or [Properties].

NOTE

Depending on the application you are using, select the printer to be used in the [General] tab sheet in the [Print] dialog box, then specify the print settings in the corresponding tab sheet. (Only for Windows 2000.)

6 Specify the required settings → click [OK].

7 Click [Print] or [OK].

Printing starts.

NOTE

To cancel printing, click [Cancel].

Canceling Printing

1 Open the [Printers and Faxes] (Windows 98/Me/2000: [Printers]) folder.

● On Windows XP:

- Click [start] on the Windows task bar → select [Printers and Faxes].

● On Windows 98/Me/2000:

- Click [Start] on the Windows task bar → select [Settings] → [Printers].

2 Double-click the corresponding printer driver icon.

3 Right click the print job → click [Cancel Printing].

NOTE

You can also cancel a print job using [Status Monitor] on the operation panel of the machine. (See "Confirming and Deleting a Print Job," on p. 7-2.)



More Information

For detailed information on all printing features, see Chapter 2, "Printing," in the *Software Guide*.

Copying

5

CHAPTER

This chapter explains how to make copies, adjust scan settings to improve the image quality, and enlarge or reduce the copy sizes. It also describes the special copy features.

Documents You Can Copy

For information on the types of documents you can copy, their requirements, and details on setting up documents, see Chapter 3, "Document Handling."

Making Copies

NOTE

- When making copies on LTR-size paper after having continuously copied on paper smaller than LTR-size paper, the copies may be dirty. To prevent copies from being dirty, wait about 1 minute before making copies.
- When making copies of a small size or heavy paper*, etc., the copy speed may be slightly slower than usual.
* The paper type should be selected in the Menu. (See "Specifying the Paper Type," on p. 2-12.)
- If you intend to make a copy and print with a thermal transfer printer using the same sheet of paper, make the copy first. Failure to do so may make copies dirty or cause a paper jam.
- When copying onto transparencies, remove each transparency from the output tray as it is output.

1 Place the document on the platen glass.

For details on how to place documents, see "Placing a Document on the Platen Glass," on p. 3-3.

2 Press [COPY].

3 Use the numeric keys to enter the number of copies.

You can set up to 99 copies.

4 Adjust any necessary settings for your document.

- Specify the size and the type of the paper you load in the cassette or the multi-purpose feeder. (See "Specifying the Paper Size and Type (Common for Cassette and Multi-Purpose Feeder)," on p. 2-11.)
- Press [Image Quality] to select the scanning resolution. (See "Adjusting the Image Quality (Resolution)," on p. 5-5.)
- Press [Exposure] to select the scanning exposure. (See "Adjusting the Exposure (Density)," on p. 5-5.)
- Press [Enlarge/Reduce] to select the copy ratio. (See "Setting Enlarging/Reducing," on p. 5-4.)

5 Press [Start].



NOTE

To cancel copying, press [Stop/Reset] → follow the instructions in the LCD. You can also cancel copying using [Status Monitor]. (See "Confirming and Deleting a Copy Job," on p. 7-1.)

Setting Enlarging/Reducing

You can enlarge or reduce the copy size using preset copy ratios or using custom copy ratios.

Enlarging/Reducing Using Preset Copy Ratios

1 Press [Enlarge/Reduce].

2 Press [◀(-)] or [▶(+)] to select the copy ratio → press [Set].

You can select from the following:

- 200% MAX.
- 129% STMT → LTR
- 100%
- 78% → LTR
- 64%
- 50% MIN.

 **NOTE**

- If the <PAPER SIZE GROUP> setting of <COPY SETTINGS> menu in the Menu is set to <A> or <AB>, the preset copy ratios will be as follows:
A: 50%, 70%, 100%, 141% and 200%;
AB: 50%, 70%, 81%, 86%, 100%, 115%, 122%, 141% and 200%.
- Enlarging or reducing using preset copy ratio is not available with the 2 on 1 copy function.

Improving Copied Image

Adjusting the Image Quality (Resolution)

You can adjust image quality to the appropriate level best suited for a document with text or photos. Three modes are available for adjusting the image quality.

1 Press [Image Quality].

2 Press [Image Quality] repeatedly until the image quality you want appears.

You can select from the following:

- <TEXT> for text-only documents
- <PHOTO> for photographs
- <TEXT/PHOTO> for documents with text and photographs



NOTE

Copy exposure automatically changes to manual mode when <TEXT/PHOTO> or <PHOTO> is set.

Adjusting the Exposure (Density)

You can adjust the copy exposure automatically or manually according to how light or dark your document is.

■ Adjusting Automatically

1 Press [Exposure] twice to select the auto mode → press [Set].

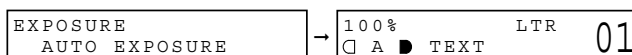

The copy exposure is adjusted automatically.



NOTE

Image quality mode automatically changes to <TEXT> when <AUTO EXPOSURE> is set.

■ Adjusting Manually

1 Press [Exposure] to select the manual mode.

2 Press [◀(-)] or [▶(+)] to adjust the copy exposure → press [Set].

For a lighter copy exposure, press [◀(-)].

For a darker copy exposure, press [▶(+)].

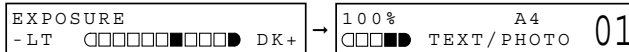

NOTE

When setting the exposure lighter, the indicator moves to the left. When setting the exposure darker, the indicator moves to the right.

Special Features

The machine has the following SPECIAL COPY features. These features allow you to sort copies in page order and create special copies easily.

- Collate Copy
Sorts copies in page order.
- 2 on 1
Reduces two documents to fit on a single paper.
- Reserve Copy
Reserves the next job while the machine is printing out.

Collate Copy

The collate copy allows you to sort copies in page order. It is convenient when you make multiple copies of multiple page documents.

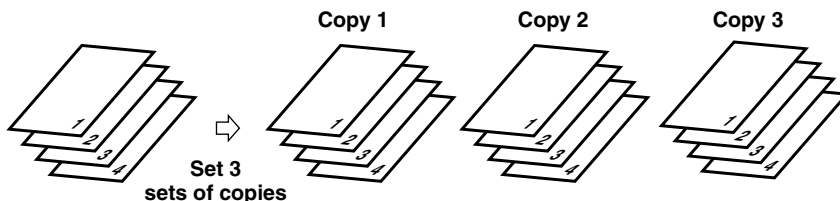

1 Place the first page of a document on the platen glass.

For details on how to place documents on the platen glass, see "Placing a Document on the Platen Glass," on p. 3-3.

2 Press [Collate/2on1].

<COL.> appears in the LCD.

NOTE

If <AUTO SORT> in <COPY SETTINGS> of the Menu is set to <ON>, the collate copy feature is automatically set. (See <4. AUTO SORT> of "Menu Descriptions," on p. 10-3.)

3 Use the numeric keys to enter the number of copies you want.

You can set up to 99 copies.

4 Press [Start].

The machine begins scanning.

5 Place the next page of the document on the platen glass.

NEXT PAGE	: START
END SCANNING	: SET

6 Press [Start].

Repeat step 5 and 6 to scan all documents.

7 Press [Set].

The machine begins printing out.

NOTE

When scanning multiple page documents, <MEMORY FULL> may appear in the LCD and scanning is canceled. In this case, reduce the documents to be scanned. Or, change the image quality mode to <TEXT>.

2 on 1 Copy

Use the 2 on 1 copy function to reduce two sheets to fit on one sheet.

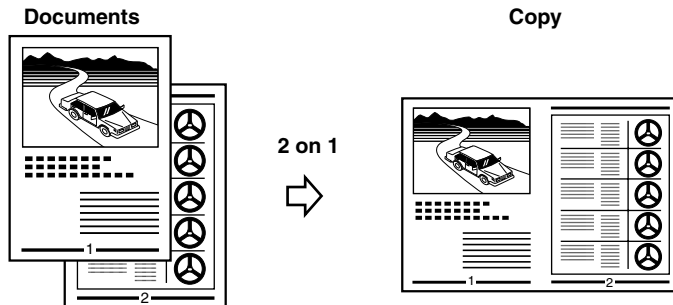

NOTE

- This function is not available with an enlarging or reducing function.
- This function is available only when the paper size setting is set to <LTR> or <A4>.

1 Place the first page of a document on the platen glass.

For details on how to place documents on the platen glass, see "Placing a Document on the Platen Glass," on p. 3-3.

2 Press [Collate/2on1] twice.

<2ON1> appears in the LCD.

3 Use the numeric keys to enter the number of copies you want.

You can set up to 99 copies.

4 Press [Start].

The machine begins scanning.

5 Place the next page of the document on the platen glass.

NEXT PAGE	: START
END SCANNING	: SET

6 Press [Start].

Repeat steps 5 and 6 to scan all documents.

After scanning every two sheets, the quantity of copies of the document specified in step 3 will be printed out.

7 Press [Set].

NOTE

If the image quality mode is set to other than <TEXT> when making a 2 on 1 copy of a document which has many graphics or photos, <MEMORY FULL> will appear in the LCD and copying will be canceled. If this happens, change image quality mode to <TEXT>. Even if you do so, <MEMORY FULL> may appear depending on the document, and copying may be canceled.

Reserve Copy

This feature allows you to reserve the next job while the machine is printing out a current job.



NOTE

The machine can store up to 10 copy jobs in memory.

1 Press [Stop/Reset] twice to return to the standby display while the machine is printing out.



NOTE

It is necessary to return to the standby display in order to reserve the next copy job.

2 Place the document to be reserved on the platen glass.

For details on how to place documents, see "Placing a Document on the Platen Glass," on p. 3-3.

3 Use the numeric buttons to enter the number of copies.

You can set up to 99 copies.

4 Adjust any necessary settings for your document.

- Press [Image Quality] to select the scanning resolution. (See "Adjusting the Image Quality (Resolution)," on p. 5-5.)
- Press [Exposure] to select the scanning exposure. (See "Adjusting the Exposure (Density)," on p. 5-5.)
- Press [Enlarge/Reduce] to select the copy ratio. (See "Setting Enlarging/Reducing," on p. 5-4.)

5 Press [Start].

The machine begins scanning.



NOTE

- After printing of the current copy job is complete, the next copy job begins.
- If the memory becomes full while scanning, <MEMORY FULL> appears in the LCD. All of the scanned documents will be erased if <MEMORY FULL> appears, so divide the document and copy each part separately, or select a lower image quality mode and make copies again.

This chapter briefly explains how to scan documents into your computer using the scanner driver included in the CD-ROM.

Before Scanning

Before scanning, software must be installed in your computer.

- If not, please see "Install the software and connect the machine to your computer," in the *Set-Up Instructions* or Chapter 1, "Installation," in the *Software Guide*.

Check if the scanner driver is installed in your computer by following this procedure.

1 Open the [Scanners and Cameras] folder (Windows 98/Me/2000: the [Scanners and Cameras Properties] dialog box).

● On Windows XP:

- Click [Start] on the Windows task bar → select [Control Panel] → [Printers and Other Hardware] → [Scanners and Cameras].

● On Windows 98/Me/2000:

- Click [Start] on the Windows task bar → select [Settings] → [Control Panel] → double click [Scanners and Cameras].

2 Make sure there is the corresponding scanner driver name or icon.

Scanning Methods

There are two methods of scanning documents to your computer:

- Using a TWAIN- or WIA- (Windows XP) compliant Windows application
- Using [SCAN] on the operation panel of the machine

This section explains how to scan using [SCAN] on the operation panel of the machine. By pressing [SCAN] → [Start] on the operation panel of the machine, you can scan documents to your computer.

1 Place the document on the platen glass.

For details on how to place documents, see "Placing a Document on the Platen Glass," on p. 3-3.

2 Press [SCAN] → [Start] on the machine.

If you are asked to select the program to launch, select "MF Toolbox Ver4.7."

Scanning starts.

The MF Toolbox and the MF Toolbox settings dialog box will open, but the document will be scanned without pressing [Start].

The scanned document will be processed according to your settings.

When you use [Start] for the first time, a folder with the scanning date will be created in the [My Pictures] folder in the [My Documents] folder, and your document will be saved in this folder. If there is no [My Pictures] folder, the folder with the scanning date will be created in the [My Documents] folder and your document will be saved in this folder.



More Information

For detailed information on all scanning features, see Chapter 3, "Scanning," in the *Software Guide*.

This chapter explains how to check the status of the jobs stored in the machine, and to confirm or delete them as needed.

Checking the Status of the Jobs Stored in the Machine

Use [Status Monitor] to confirm or delete copy and print jobs stored in the machine.

When using [Status Monitor], the LCD displays the jobs in the following order.

- COPY STATUS
- PRINT STATUS

 NOTE

[Status Monitor] is disabled in the Scan mode.

Confirming and Deleting a Copy Job

1 Press [Status Monitor].

2 Press [◀(-)] or [▶(+)] to select <COPY STATUS> → press [Set].

 NOTE

- If there is no job, <NO COPY JOBS EXIST> is displayed.
- If there is only one copy job, go to step 4.

3 Press [◀(-)] or [▶(+)] to confirm the job number, and the quantity of copies.

4 If you want to delete the copy job, press [Set].

5 If you decide to delete the job, press [◀(-)] for <YES>.

 NOTE

To cancel deleting the job, press [▶(+)] for <NO>. Once the job is deleted, the job cannot be restored.

Confirming and Deleting a Print Job

1 Press [Status Monitor].

2 Press [◀(-)] or [▶(+)] to select <PRINT STATUS> → press [Set].

 NOTE

- If there is no job, <NO PRINT JOBS EXIST> is displayed.
- If there is only one print job, go to step 4.

3 Press [◀(-)] or [▶(+)] to confirm the file name.

4 If you want to delete the print job, press [Set].

5 If you decide to delete the job, press [◀(-)] for <YES>.

 NOTE

- To cancel deleting the job, press [▶(+)] for <NO>. Once the job is deleted, the job cannot be restored.
- The LCD can display characters in ASCII cord. Using characters other than those in ASCII cord may have the LCD display garbled characters.

Maintenance

8

CHAPTER

This chapter explains how to clean the machine, replace the toner cartridge, and repack and transport the machine.

Periodic Cleaning

Your machine requires little periodic maintenance. This section describes the necessary cleaning procedures for your machine.

CAUTION

- When cleaning the machine's exterior or the platen glass, be sure to disconnect the power cord before cleaning the machine.
- Do not use tissue paper, paper towels, or similar materials for cleaning; they can stick to the components or generate static charges. Use a soft cloth to avoid scratching the components.
- Never use volatile liquids such as thinner, benzene, acetone, or any other chemical cleaner to clean the interior of the machine; these can damage the machine's components.

Cleaning the Exterior

Wipe the machine's exterior with a clean, soft, lint-free cloth moistened with water or diluted dishwashing detergent solution.

Cleaning the Scanning Area

Wipe the scanning area (shaded area) with a clean, soft, lint-free cloth moistened with water, then wipe with a clean, soft, dry, lint-free cloth.

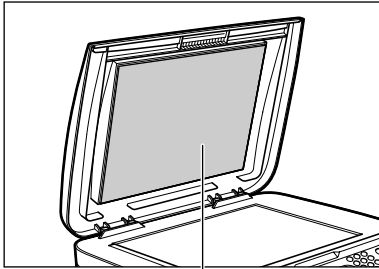

Platen glass cover

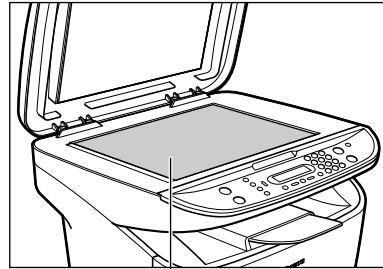

Platen glass

When to Replace the Cartridge

The cartridge is a consumable item and should be replaced when the toner runs out.

If white streaks or light bands appear on the printouts, the toner is running low.

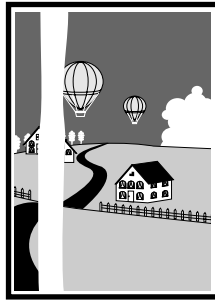

↑
Paper feeding
direction

 NOTE

Before handling the cartridge, see the precautions in "Handling and Storing the Cartridge," on p. 8-5.

- 1** Remove the cartridge from the machine.
- 2** Rock the cartridge 5 or 6 times to distribute the toner evenly.

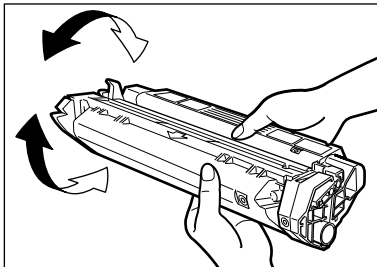

3 Reinstall the cartridge in the machine.

4 Make a few test copies.

- **If the copies appear normal:**

You can keep using the cartridge. However, a new one will be needed soon.

- **If white streaks or light bands are still present:**

- Replace the cartridge with a new one.

For details on how to replace the cartridge, see "Replacing the Cartridge," on p. 8-13.

Print Yield

This section describes the approximate number of printouts that can be made per cartridge.

Approximate Print Yield

Canon Cartridge X25: Approx. 2,500 printouts (A4 at 4% dot coverage*).

* The term "A4 at 4% dot coverage" denotes a document on which the area covered with toner is 4% of the total area of an A4-size sheet.

- The actual number of printouts that can be made per cartridge depends in part on the exposure setting, room temperature, and humidity.
- If you print a large number of documents which contain heavy print or many photographs, toner consumption will increase, and white streaks will appear on printouts sooner than indicated above. Toner consumption will also increase if you print with the platen glass cover left open.
- If you print small size documents or documents with less dot coverage, you may be able to print more sheets of paper than indicated above. However, dark bands might appear on printouts if you keep using the same cartridge for an extended period of time.

Handling and Storing the Cartridge

This section describes the precautions to ensure optimum copy quality.

Handling Precautions

WARNING

- Do not throw the cartridge into open flames, as this may cause the toner to ignite and result in burns or a fire.
- The cartridge emits low level magnetic flux. If you use a cardiac pacemaker and feel abnormalities, please move away from the cartridge, and consult a physician.

IMPORTANT

Never attempt to disassemble the cartridge or open the drum protective shutter.

NOTE

- If the machine is brought from the cold outdoors into a warm room, or if the room is rapidly heated, condensation may form inside the machine. This can adversely effect the quality of your printouts (e.g., copies are completely black). When the machine is exposed to such conditions, allow at least 2 hours for the machine to adjust to room temperature before attempting to use it.
- When handling the cartridge, take care not to allow the toner on the jammed paper to come into contact with your hands or clothing. If they become dirty, wash them immediately with cold water. Washing with warm water will set the toner, and make it impossible to remove the toner stains.
- Always hold the cartridge as shown so that the side with the instructions (A) faces up. Do not forcefully move or push the drum protective shutter (B) in any way.

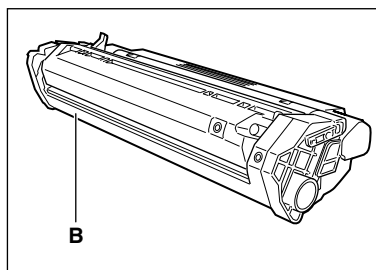
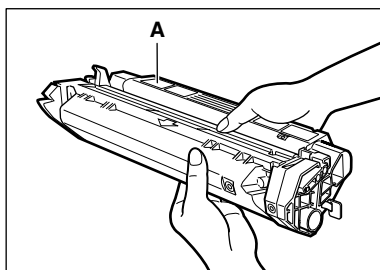

Storage Precautions

WARNING

Do not store cartridges or copy paper in places exposed to open flames, as this may cause the toner or copy paper to ignite, resulting in burns or a fire.

⚠ CAUTION

Keep cartridges and other consumables out of the reach of children. If the contents of these items are ingested, consult a physician immediately.

👤 IMPORTANT

- Place the cartridge in its protective bag so that the side with the written instructions faces up. Then, place the bagged cartridge into its shipping box. Store the unused cartridge out of direct sunlight.
- For partially used/opened cartridges, place the cartridge in its protective bag so that the side with the written instructions faces up. Then place the bagged cartridge into its shipping box and store it away from direct sunlight.
- Avoid storing the cartridge in front of heaters and humidifiers, etc. Store it in a location where the temperature does not exceed 104°F (40°C).
- The recommended storage conditions are as follows:
 - Temperature: 32°F to 95°F (0°C to 35°C)
 - Relative Humidity: 35% to 85%
- Be sure to remove the toner cartridge from the machine when disposing of the machine.
- Do not stand the cartridge on end or turn it upside down.

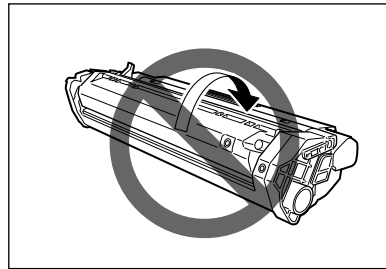
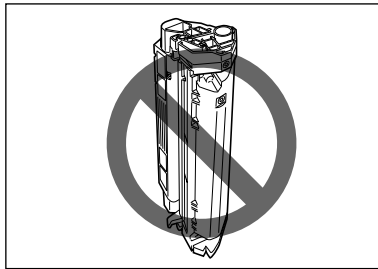
***Storing Partially Used Cartridges***

If you remove a cartridge from the machine, store the cartridge as described below. Place the cartridge in its protective bag so that the side with the written instructions faces up. Then, place the cartridge into its shipping box. Be sure to securely close the lid of the shipping box.

If you do not have the protective bag or shipping box for the cartridge, store the cartridge in a dark location.

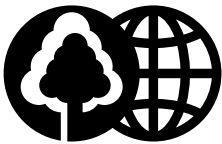
Recycling Used Cartridges

Canon has instituted a worldwide recycling program for cartridges called "The Clean Earth Campaign." This program preserves precious natural resources by utilizing a variety of materials found in the used cartridges that are of no further use, to remanufacture new cartridges which, at the same time, keeps the environment cleaner by reducing landfill waste. Complete details concerning this program are enclosed in each PC Cartridge box.

The Clean Earth Campaign

THE CANON CARTRIDGE RECYCLING PROGRAM

The Canon Cartridge Recycling Program fulfills the first initiative of Canon's Clean Earth Campaign, which supports four critical environmental areas:

- Recycling in the Workplace
- Conserving Environmental Resources
- Scientific Research and Education
- Encouraging Outdoors Appreciation

The remaining "Clean Earth" initiatives are supported in the U.S. through sponsorships of the National Park Foundation, the National Wildlife Federation, and The Nature Conservancy and in Canada through donations to the World Wildlife Fund Canada and The Nature Conservancy of Canada.

Since its inception, The Canon Cartridge Recycling Program has collected millions of cartridges that otherwise would have been discarded into landfills or similar facilities. Instead, this rapidly growing program returns used cartridges to the manufacturing process, thus conserving an array of resources.

Becoming a part of this worthwhile program is easy. When your cartridge is of no further use, simply follow the instructions detailed for U.S. or Canadian residents. We appreciate your support of The Canon Cartridge Recycling Program. Working together we can make a significant contribution to a cleaner planet.

- Cartridges collected through this program are not refilled.
- You are not entitled to a tax deduction or rebate for the return of empty cartridges.
- This program may be modified or discontinued without notice.

The Clean Earth Campaign

Supporting Environmental Initiatives With

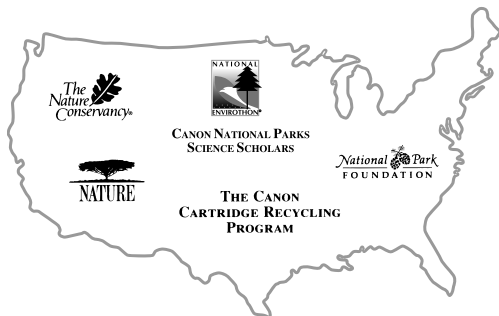

Packaging

■ Option A-1: Single Box Return

- Repackage the empty cartridge utilizing the wrapper and pulp mould end-blocks from the new cartridge's box.
- Place the empty cartridge in the box of your new cartridge. Seal the box.

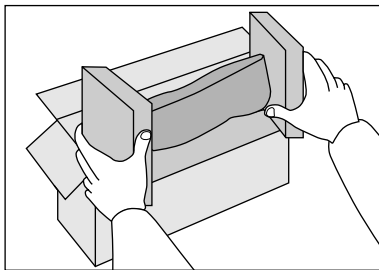

■ Option B: Volume Box Return

We encourage you to use this option as a more efficient way to ship cartridges.

- Place as many cartridges as possible into one box. Carefully seal the box with tape;
- or
- Call **1-800-OK-CANON** to receive your free eight cartridge collection box.

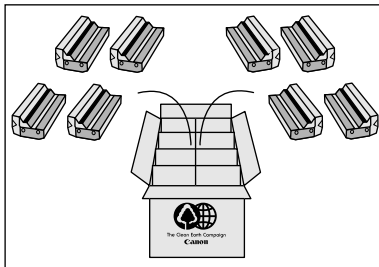

■ Option A-2: Multiple Box Return

We encourage you to use this option as a more efficient way to ship cartridges.

- Complete Option A-1.
- Bundle multiple cartridge boxes together securely with tape.

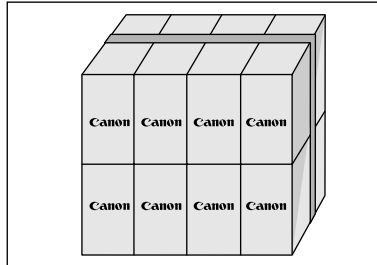

Please be sure that the shipment does not exceed UPS specifications.

Maximum weight = 70 lb (31.8 kg)

Maximum length = 108" (2,743 mm)

Maximum girth (length + 2 × width + 2 × height) = 130" (3,302 mm)

If your shipment exceeds the above limits, please call **1-800-OK-CANON** for special shipping information.

Please Note:

Do not send defective cartridges for replacement.

Defective cartridges under warranty should be exchanged by an authorized dealer or service facility as provided in the warranty.

Shipping

Apply the UPS authorized returning label provided in this guide.

Residents of Alaska and Hawaii: Do not use the UPS authorized returning label. For Alaska and Hawaii Canon set up alternative mail service with the U.S. Postal Service.

Please call **1-800-OK-CANON** to receive U.S. Postal Service merchandise returning label.

■ Option A: UPS Pick-up

- Give the shipment to your UPS driver when you receive your next regular delivery;
or
- Take the shipment to your local UPS receiving point.



■ Option B: MBE Drop off

Take the shipment to a participating MBE (Mail Boxes, Etc.) Center.

For location, please call **1-800-949-6660**.

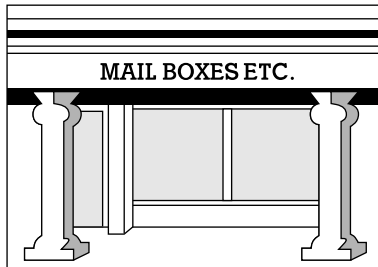

By using either of the above methods of shipment, your used cartridge(s) will be forwarded to the Canon Cartridge Collection Center at no charge to you.

For further information about the Clean Earth Campaign in the United States, please call: **1-800-OK-CANON**

■ **Option A: Single Box Return**

- Repackage the empty cartridge utilizing the wrapper and pulp mould end-blocks from the new cartridge's box.
- Place the empty cartridge in the box of your new cartridge. Seal the box.
- Apply the Canon Canada Inc./Canada Post label provided in this brochure. Canon's labels are specially marked so that Canon pays the postage.
- Deposit your empty cartridge in any full size street mailbox or take it to your local Canada Post outlet or franchise.

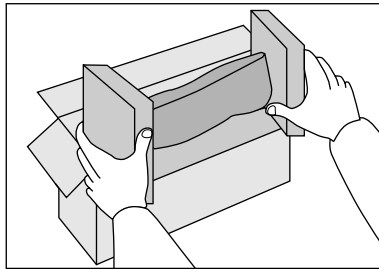

■ **Option B: Volume Box Return (eight or more cartridges)**

We encourage you to use this option as a more efficient way to ship cartridges.

- Call **1-800-667-2666** to receive your free Canon collection box kit. The collection box can accommodate eight individual cartridge boxes.
- Place your eight individually packaged boxes of empty cartridges into the Canon collection box. Seal the box.
- Apply the Canon Canada Inc./Canada Post label provided in this brochure. Canon's labels are specially marked so that Canon pays the postage.
- Deliver to any local Canada Post outlet or franchise. Customers who hold a Commercial pick-up agreement with Canada Post may have their collection box picked up.

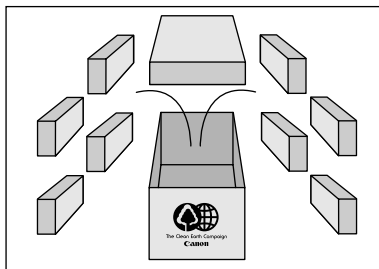

Working to preserve endangered species is a long-standing Canon interest. To this end, for every cartridge collected, Canon Canada donates \$1, shared equally between World Wildlife Fund Canada and the Nature Conservancy of Canada. This donation is utilized in Canada.

For further information about The Clean Earth Campaign in Canada, please call or write to Canon.

1-800-667-2666

Canon Canada Inc.

Corporate Customer Relations

6390 Dixie Road

Mississauga, ON L5T 1P7

Replacing the Cartridge

This section describes how to remove the used cartridge and replace it with a new one. Before replacing the cartridge, be sure to read the section "When to Replace the Cartridge," on p. 8-3.

 **NOTE**

Before handling the cartridge, see the precautions in "Handling and Storing the Cartridge," on p. 8-5.

1 Open the front cover.

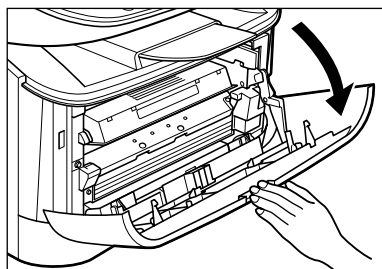

2 Remove the cartridge from the machine.

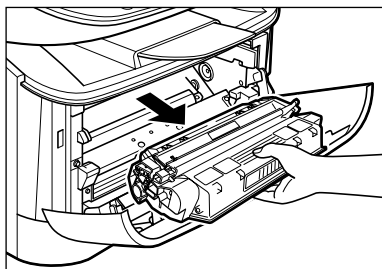

3 Remove the new cartridge from its protective bag.

 **NOTE**

Save the protective bag. You may need it later when you remove the cartridge from the machine.

- 4** Rock the cartridge 5 or 6 times to distribute the toner evenly.

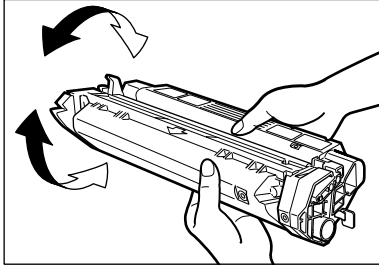

- 5** Place the cartridge on a flat and stable surface. Fold the tab (A) on the sealing tape (B) as shown below, and pull it out straight while supporting the cartridge.

Make sure that the tab itself is detached from the cartridge.

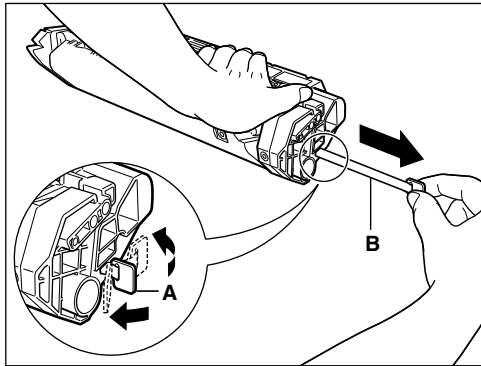

IMPORTANT

To avoid breaking the tape, do not pull out the tape at an upward or downward angle.

6 Hold the cartridge and align the projections (A) on both sides of the cartridge to the guides (B) in the machine, then gently slide the cartridge into the machine as far as it will go.

Be sure to position the arrow mark (C) on the cartridge towards the inside of the machine.

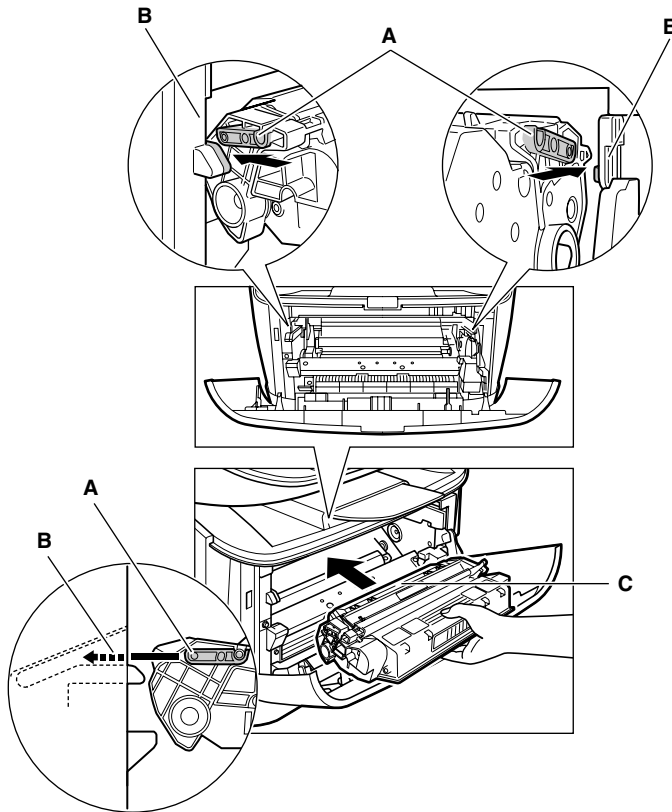

7 Close the front cover.

 NOTE

If the LCD displays <INSTALL CARTRIDGE>, reset the machine by opening the front cover and then closing it.

Repacking and Transporting Your Machine

Be sure to unplug the power cord before transporting the machine. If the machine is likely to be subjected to vibration (e.g., when transporting over long distances), the following precautions should be taken. If you do not follow these precautions, the machine may be damaged or the quality of your printouts may be adversely affected.

- 1** Unplug the power cord.
- 2** If the machine is connected to your computer, remove the printer cable.
- 3** Open the front cover.
- 4** Grip the end of the cartridge, and remove it from the machine. In order to avoid direct sunlight, place the cartridge in the protective bag that the cartridge came in when you purchased it.
- 5** Close the front cover.
- 6** Pull out the cassette completely, and remove the extension cover from the machine.
- 7** Detach the cassette extension from the cassette.
- 8** Insert the cassette in the machine.
- 9** Detach the output tray.

Carrying the Machine by the Sides

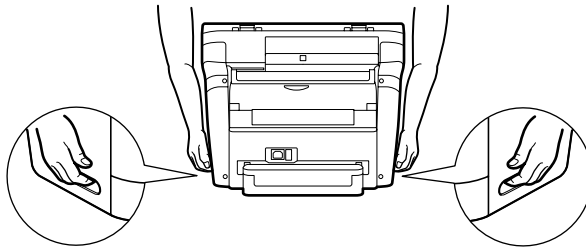

Pull out the cassette completely, and remove the extension cover.

Detach the output tray.

Grip the handles on both sides of the machine and lift it carefully, as shown in the illustration above.

CAUTION

When carrying the machine, be sure to hold it in the designated places as shown in the illustration. Dropping the machine can cause personal injury.

Transporting the Machine by Car

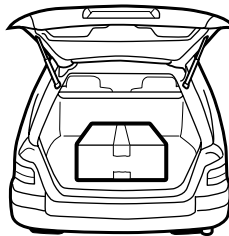

Pack the machine, using the original packing material and box.

Place the machine on a level, stable surface.

IMPORTANT

- Do not leave the machine inside a car for a long period of time; the temperature can become very high or low.
- Avoid rough roads; excessive vibration may damage the machine or adversely affect the quality of your printouts.
- Place a cover over the machine. Do not leave the machine in direct sunlight.
- When moving the machine, use the original shipping box that it was packed in when you purchased it.

Troubleshooting

9

CHAPTER

This chapter describes the problems you might encounter when using the machine and their remedies. It also explains what to do if you cannot solve the problem by yourself.

Clearing Jams

This section describes how to remove jammed paper. When print media jams inside the machine, the LCD displays <REC. PAPER JAM>.

CAUTION

There are some areas inside the machine and cartridge which are subject to high voltages and high temperatures. Take adequate precaution when performing internal inspections to avoid burns or electrical shock.

NOTE

When removing jammed paper from inside the machine, take care not to allow the toner on the jammed paper to come into contact with your hands or clothing. If they become dirty, wash them immediately with cold water. Washing with warm water will set the toner, and make it impossible to remove the toner stains.

1 Open the front cover.

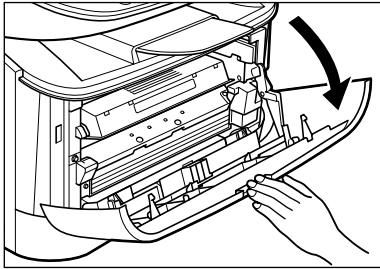

2 Remove the cartridge.

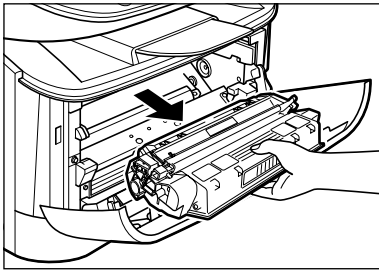

IMPORTANT

- Remove watches and any bracelets or rings when touching the inside of the machine. These items might be damaged if they come into contact with the parts inside the machine.
- To avoid possible damage to the machine, do not touch the pins (A) near the left end of the transfer roller (B).

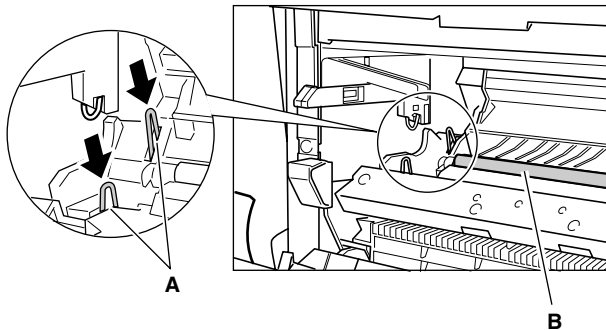

- When removing the jammed paper, do not touch the transfer roller as its surface is very delicate and susceptible to finger oil and scratches, which may lead to print deterioration.

 NOTE

Do not expose the cartridge to light for more than 5 minutes. If necessary, put the cartridge in its original protective bag or wrap it with a thick cloth to prevent exposure to light.

- 3** Open the face up cover (A) and push down the green paper release levers (B) on both sides of the face up paper output.

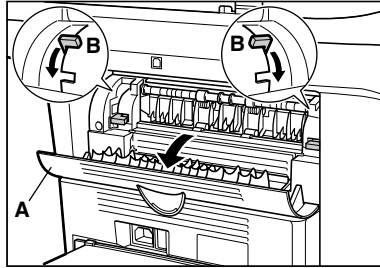

- 4** Hold both sides of the jammed paper and carefully move it inward, then gently pull it out.

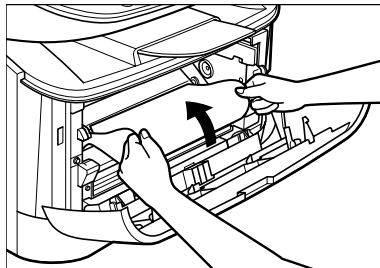

- 5** Gently pull the jammed paper out of the machine.

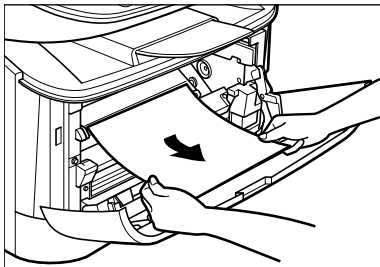

● **If the leading edge of the paper is visible but has not entered the imaging area:**

- Pull the paper forwards and roll it inwards.

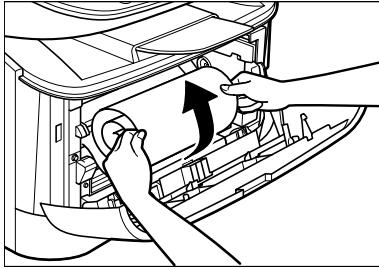

⚠ **IMPORTANT**

- Do not pull the jammed paper forward from the cassette. It may cause a machine malfunction.

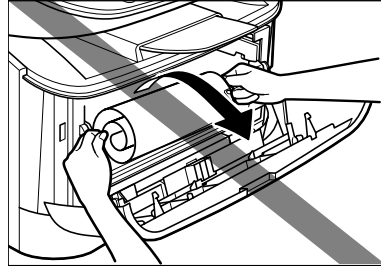
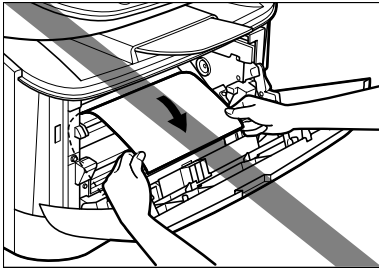

- Do not pull the jammed paper upward; the toner on the paper will stain the machine and cause a permanent reduction in print quality.

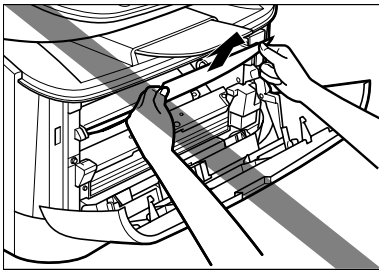

- 6** Gently pull the jammed paper between the output rollers until the leading edge emerges from the machine.

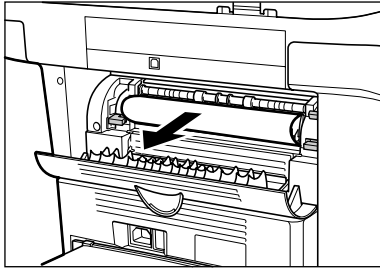

- 7** Carefully pull the jammed paper straight out through the rollers.

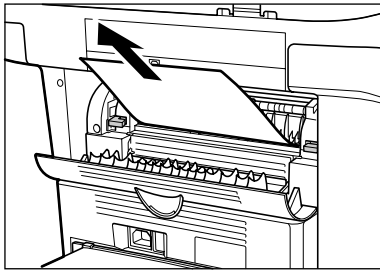

If the jammed paper is badly folded, similar to the folds of an accordion, ease the jammed paper loose and then pull it out of the machine.

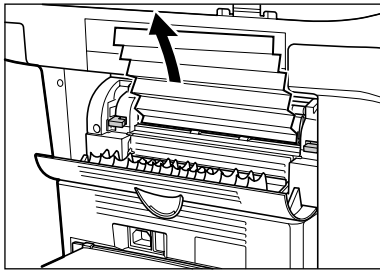

8 Close the front cover.

9 Pull out the cassette completely.

10 Hold both sides of the jammed paper and slowly pull it out in the direction of the arrow.

- When Feeding Paper from the Cassette:

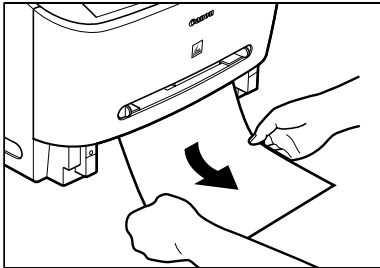

- When Feeding Paper from the Multi-Purpose Feeder:

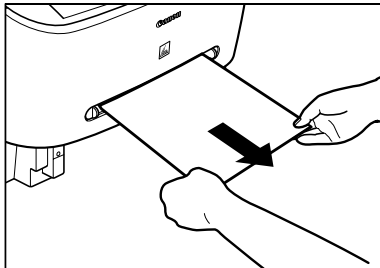

11 Push the paper release levers back to their original position and close the face up cover.

IMPORTANT

- Be sure to push the paper release levers back to their original position. If the levers are left pushed down, the paper jam error will not be resolved.
- Never push down the paper release levers while printing. This could result in damage to the fixing assembly.

12 Insert the cartridge back into the machine, then close the front cover.

For details, see "Replacing the Cartridge," on p. 8-13.



IMPORTANT

After you replace the cartridge and close the front cover, the machine should be ready for operating. If the machine returns to the ready state for operating, troubleshooting has been successful. If the machine does not return to the ready state for operating, confirm that the paper release levers are pushed back to their original position, and check to see that jammed paper is not left in the machine.

13 Insert the cassette into the machine.

LCD Messages

The following messages are displayed in the LCD when the machine performs a function or if it encounters an error.

ADJUSTING

WAITING TO SCAN

Cause The machine is not ready for copying because you have just connected the power cord to the machine.

Remedy Wait for a while. The machine cannot scan documents for copying immediately after the power cord is connected.

CHECK PAPER SIZE

Cause The size of the paper in the cassette or multi-purpose feeder is different from that of the paper specified in <PAPER SETTINGS> of the Menu.

Remedy Load the correct paper size or change <PAPER SIZE> in <PAPER SETTINGS> of the Menu. (See "Loading Paper," on p. 2-4, or "Specifying the Paper Size," on p. 2-11.)
Then reset the machine by opening the front cover and then closing it.

CHECK PRINTER

Cause A problem has occurred in the printer.

Remedy Reset the machine by opening the front cover and then closing it. If the message persists, unplug the machine from the power supply and contact Canon Authorized Service Facilities or the Canon Customer Care Center.

CHECK PRINTER COVER

Cause The front cover is not closed completely.

Remedy Check the front cover, and make sure that it is completely closed.

INSTALL CARTRIDGE

Cause The cartridge is not installed or not installed correctly.

Remedy Install the cartridge correctly. (See "Replacing the Cartridge," on p. 8-13.)

MEMORY FULL

Cause 1 The machine's memory is full because the collate copy or 2 on 1 copy function was set when a large document is loaded.

Remedy Divide the document and copy each part separately.

Cause 2 You tried to reserve more than 11 copy jobs.

Remedy The machine can store up to 10 copy jobs in memory. Wait until the current copy job completes, or use [Status Monitor] to delete the reserved copy jobs in memory.

PRINTER DATA ERROR

Cause When you canceled a job being processed, the next job on the spooled job list may have been also deleted.

Remedy Check if the job that immediately follows the job being processed has been deleted on the spooled job list. Disconnect the USB cable and connect it again, or unplug the machine and plug it in again to clear the error message.

REC. PAPER JAM

Cause There is a paper jam.

Remedy Clear the paper jam (See "Clearing Jams," on p. 9-1) and reload paper in the cassette or multi-purpose feeder. Then reset the machine by opening the front cover and then closing it.

REMOVE MP PAPER

Cause Paper was loaded in the multi-purpose feeder when the machine is scanning a document for copying.

Remedy Remove the paper from the multi-purpose feeder. After removing the paper, the machine will start making a copy automatically. If you want to use paper in the multi-purpose feeder to make a copy, load paper in the multi-purpose feeder first, then press [Start].

SUPPLY REC. PAPER

Cause No paper is loaded in the cassette or multi-purpose feeder.

Remedy Load paper in the cassette or multi-purpose feeder. (See "Loading Paper," on p. 2-4.) Make sure the paper stack in the cassette does not exceed the capacity of the cassette.

Load paper in the multi-purpose feeder one by one.

If you load paper while making copies, do not load a different paper size.

On the second line in the LCD the message <CASSETTE> or <TRAY> and the paper size may appear. In this case, load the corresponding paper in the cassette or multi-purpose feeder.

Paper Feeding Problems

Paper does not feed correctly.

Q Does the cassette or multi-purpose feeder contain an appropriate quantity of sheets?

A Make sure the paper stack in the cassette or the paper in the multi-purpose feeder does not exceed the capacity of the cassette or multi-purpose feeder. (See "Loading Paper," on p. 2-4.)

Q Is paper loaded correctly?

A Make sure the paper stack in the cassette or the paper in the multi-purpose feeder is loaded properly, and that the paper guides are adjusted correctly. (See "Loading Paper," on p. 2-4.)

Q Is the cassette inserted into the machine correctly?

A Push the cassette into the machine as far as it will go, and make sure the cassette is not tilted or inserted at an angle.

Paper feeds skewed. (Printing is skewed.)

Q Is paper loaded correctly?

A Make sure the paper stack in the cassette or the paper in the multi-purpose feeder is loaded properly, and that the paper guides are adjusted correctly. (See "Loading Paper," on p. 2-4.)

A Make sure the paper exit path is clear.

Multiple sheets feed into the machine at the same time.

Q Is paper loaded correctly?

A Make sure the paper stack in the cassette or the paper in the multi-purpose feeder is loaded properly, and that the paper guides are adjusted correctly. (See "Loading Paper," on p. 2-4.)

Q Have you fanned the paper stack before loading it in the cassette?

A Be sure to fan the paper stack before loading it in the cassette. This keeps the sheets of paper from sticking together.

Q Does the cassette or multi-purpose feeder contain an appropriate quantity of sheets?

A Make sure the paper stack in the cassette or the paper in the multi-purpose feeder does not exceed the capacity of the cassette or multi-purpose feeder. (See "Loading Paper," on p. 2-4.)

A Do not force the paper stack into the cassette or the paper into the multi-purpose feeder.

A Load paper one by one in the multi-purpose feeder.

Q Is only one type of paper loaded in the cassette or multi-purpose feeder?

A Load only one type of paper.

A Make sure you load paper that meets the paper requirements for the machine. (See Chapter 2, "Paper Handling.")

Transparencies do not feed correctly.

Q Are the transparencies loaded correctly?

A Make sure the transparencies in the cassette or the transparency in the multi-purpose feeder is loaded properly, and that the paper guides are adjusted correctly. (See "Loading Paper," on p. 2-4.)

Q Is the proper transparency loaded in the multi-purpose feeder?

A Do not use any transparencies designed for color copiers. They will cause a paper jam. Please use transparencies recommended by Canon.

Paper feeds curled.

Q Is the proper paper loaded?

A Check if the proper paper is loaded in the cassette or multi-purpose feeder. (See Chapter 2, "Paper Handling.")

Paper stacked roughly.

Q Is the proper paper loaded?

A Check if the proper paper is loaded in the cassette or multi-purpose feeder. (See Chapter 2, "Paper Handling.")

A Check if the appropriate paper type is selected in <PAPER TYPE> in <PAPER SETTINGS> of the Menu. (See "Specifying the Paper Type," on p. 2-12.)

Repeated paper jams occur.

Q Is the proper paper loaded?

A Check that the size, thickness and type of the paper you are using. (See "Print Media Requirements," on p. 2-1.)

Q Is the proper paper loaded correctly?

A Be sure to fan the paper stack before loading it in the cassette. This keeps the sheets of paper from sticking together.

Q Is the output tray free of obstructions?

A Do not place the delivered paper back on the output tray. (See "Face Down Paper Output Area," on p. 2-15.)

A Do not place objects other than paper on the output tray. (See "Face Down Paper Output Area," on p. 2-15.)

Q Is the machine installed in a proper location?

A Check that the machine is installed in the proper location. (For information about specifications of the machine, see "Specifications," on p. 11-1. For safety warnings and cautions, see "Installation," on p. xiv).

Envelopes do not feed correctly.

Q Are the envelopes loaded correctly?

A Make sure the envelopes are loaded correctly. (See "Loading an Envelope in the Multi-Purpose Feeder," on p. 2-9.) Load an envelope one by one in the multi-purpose feeder.

Q Is the proper envelope loaded?

A Load the recommended envelopes (COM10, MONARCH, DL, or ISO-C5) in the multi-purpose feeder. (See "Loading an Envelope in the Multi-Purpose Feeder," on p. 2-9.)

Copying Problems

The machine will not make a copy.

Q Is the cartridge installed correctly?

A Make sure the cartridge is installed correctly. (See the *Set-Up Instructions*.)

Q Is the sealing tape removed from the cartridge?

A Remove the sealing tape from the cartridge. (See the *Set-Up Instructions*.)

Q Is the cassette inserted completely into the machine?

A Insert the cassette as far as it will go. (See the *Set-Up Instructions*.)

Q Did you connect the power cord to the machine just now?

A Wait for a while. After connecting the power cord, the machine cannot scan documents immediately.

Q Is the energy saver mode off?

A The machine does not scan documents, if it is in the energy saver mode. To restore the machine from the energy saver mode, press [Energy Saver].

Print Quality Problems

The print quality is not what you expect; print is not clear, has missing dots or white streaks.

Q Are the size, thickness and type of the paper you are using within the specifications of the machine?

A Check that the paper you are using is supported by the specifications of the machine. (See "Print Media Requirements," on p. 2-1.)

Q Is the cartridge installed correctly?

A Make sure the cartridge is installed correctly. (See the *Set-Up Instructions*.)

Q Is any toner left in the cartridge?

A See "When to Replace the Cartridge," on p. 8-3, and replace the cartridge if necessary. (See "Replacing the Cartridge," on p. 8-13.)

Q Is the exposure adjusted correctly?

A Adjust the exposure correctly using [Exposure]. (See "Adjusting the Exposure (Density)," on p. 5-5.)

Copies are dirty.

Q Is the platen glass or the platen glass cover clean?

A Clean the platen glass or the platen glass cover. (See "Cleaning the Scanning Area," on p. 8-2.)

Q Is the cartridge free of damage?

A If there is a scratch on the cartridge, replace with a new one. (See "Replacing the Cartridge," on p. 8-13.)

Q Is the machine adjusted to room temperature? If not, condensation might build up inside the machine.

A Allow at least 2 hours for the machine to adjust to room temperature before attempting to use it.

Q Is the machine installed in a stable location?

A Install the machine in a proper location. (See "Installation," on p. xiv.)

Copies are too dark or too light.

Q Is the exposure adjusted correctly?

A Adjust the exposure correctly using [Exposure]. (See "Adjusting the Exposure (Density)," on p. 5-5.)

Q Is the machine in the toner saver mode?

A Set <TONER SAVER MODE> to <OFF> in <COMMON SETTINGS> of the Menu. (See <2. TONER SAVER MODE> of "Menu Descriptions," on p. 10-2.)

The printouts are partly missing or shaded when you make copies on heavy paper.

Q Is the paper type set correctly?

A Select <HEAVY PAPER> or <HEAVY PAPER H> in <PAPER TYPE> in <PAPER SETTINGS> of the Menu. (See "Specifying the Paper Type," on p. 2-12.)

The printouts are missing when you make copies on rough paper.

Q Is the paper type set correctly?

A Select <TRANSPARENCY> in <PAPER TYPE> in <PAPER SETTINGS> of the Menu. (See "Specifying the Paper Type," on p. 2-12.)

The printouts are missing when you make copies using the 2 on 1 copy function.

Q Are the documents LTR-size or A4-size?

A Be sure to use two sheets of LTR-size or A4-size documents when you make copies using the 2 on 1 copy function.

The edges of copies are dirty when you make copies.

Q Is the paper size set correctly?

A Specify the appropriate paper size in <PAPER SIZE> in <PAPER SETTINGS> of the Menu. (See "Specifying the Paper Size," on p. 2-11.)

Printing Problems

The Alarm indicator comes on.

Q Does the machine feed paper correctly, or is there paper in the cassette or multi-purpose feeder?

A Clear the paper jam, or load paper in the cassette or multi-purpose feeder. (For instructions on clearing paper jam, see "Clearing Jams," on p. 9-1. For instructions on loading paper, see "Loading Paper," on p. 2-4.)

A If the machine has no paper jam, or paper is loaded in the cassette or multi-purpose feeder, unplug the machine and wait approximately 3 minutes to 5 minutes, then plug it in again. If the problem is fixed, the Alarm indicator will turn off, and the LCD will return to the standby mode. If the Alarm indicator remains flash, unplug the machine, and contact Canon Authorized Service Facilities or the Canon Customer Care Center.

Printout does not match paper size.

Q Is the paper stack loaded and aligned correctly in the cassette, or is paper loaded in the multi-purpose feeder correctly?

A Make sure the paper is loaded and aligned correctly in the cassette or the paper is loaded correctly in the multi-purpose feeder. (See "Loading Paper," on p. 2-4.)

Scanning Problems

The machine will not scan a document.

Q Did you connect the power cord to the machine just now?

A Wait for a while. After connecting the power cord, the machine cannot scan documents immediately.

Q Is the USB cable connected securely?

A Check that the USB cable is connected securely to the machine and your computer. Disconnect the USB cable, and reconnect it correctly after a while.

Scanned images are dirty.

Q Is the platen glass or the platen glass cover clean?

A Clean the platen glass or the platen glass cover. (See "Cleaning the Scanning Area," on p. 8-2.)

White streaks appear on the left side of the image.

Q Is the document placed on the platen glass correctly?

A Place the document approximately $\frac{1}{8}$ " (3 mm) from the edge of the platen glass.

General Problems

The machine has no power.

Q Is the power cord plugged in securely?

A Check that the power cord is plugged securely into the machine and into the wall outlet. Insert the power cord straight into the power socket on the back of the machine. Do not insert it at an angle. Otherwise, the machine may not be properly connected to the power source and may not turn on. If this happens, disconnect the power cord, and reconnect it correctly after a minute or more. (See the *Set-Up Instructions*.)

Nothing appears in the LCD.

Q Is the power cord plugged in securely?

A Check that the power cord is plugged securely into the machine and into the wall outlet. Insert the power cord straight into the power socket on the back of the machine. Do not insert it at an angle. Otherwise, the machine may not be properly connected to the power source and may not turn on. If this happens, disconnect the power cord, and reconnect it correctly after a minute or more. (See the *Set-Up Instructions*.) If the LCD remains blank, unplug the machine and wait approximately 3 minutes to 5 minutes until the temperature inside the machine lowers, then plug it in again. If the LCD remains blank, unplug the machine, and contact Canon Authorized Service Facilities or the Canon Customer Care Center.

Q Does the Energy Saver key go off?

A When the Energy Saver key lights up, the energy saver mode activates. To restore the machine from the energy saver mode, press [Energy Saver].

If You Cannot Solve the Problem

If you have a problem with your machine and you cannot solve it by referring to the information in this chapter, contact Canon Authorized Service Facilities or the Canon Customer Care Center.

⚠ CAUTION

If the machine makes strange noises, emits smoke or strange smells, unplug the power cord immediately, and then contact Canon Authorized Service Facilities or the Canon Customer Care Center. Do not attempt to disassemble or repair the machine yourself.

🚫 IMPORTANT

Attempting to repair the machine yourself may void the limited warranty.

If you need to contact Canon Authorized Service Facilities or the Canon Customer Care Center, make sure you have the following information:

- **Product name**

MF3111

- **Serial number**

The serial number is on the label located at the back of the machine.

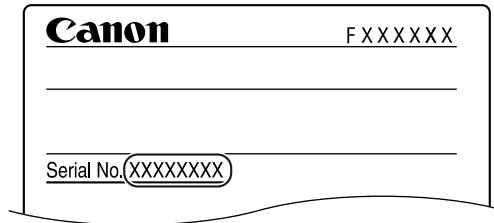

- **Software version number**

- **Place of purchase**

- **Nature of problem**

- **Steps you have taken to solve the problem and the results**

Machine Settings

10

CHAPTER

This chapter explains how to adjust machine settings. The list of all the settings is also provided for your reference.

Accessing the Machine Settings

1 Press [Menu].

2 Press [◀(-)] or [▶(+)] to select the menu you want to change → press [Set].

You have now accessed the settings in the list.

3 Press [◀(-)] or [▶(+)] to select the sub menu you want to change → press [Set].

 NOTE

- For details on sub menus, see "Menu Descriptions," on p. 10-2.
- If you press [Stop/Reset] before [Set] is pressed, the item you have selected will not be registered.
- Press [Stop/Reset] to exit from the Menu.
- If you press [Menu], the display returns to the previous screen.
- The settings changed in the Menu do not return automatically to the settings you set previously. Change to the previous settings again if necessary.

Menu Descriptions

PAPER SETTINGS

Name	Descriptions
1. PAPER SETTINGS	Sets the paper size and paper type.
1. CASSETTE	
1. PAPER SIZE	Selects the paper size for the paper cassette. LTR , LGL, A4, B5, A5, EXECUTIV
2. PAPER TYPE	Selects the paper type to be used in the paper cassette. PLAIN PAPER , PLAIN PAPER L, HEAVY PAPER, HEAVY PAPER H, TRANSPARENCY
2. MP TRAY	
1. PAPER SIZE	Selects the paper size for the MP tray. LTR , LGL, A4, B5, A5, EXECUTIV, COM10, MONARCH, DL, ISO-C5
2. PAPER TYPE	Selects the paper type to be used in the MP tray. PLAIN PAPER , PLAIN PAPER L, HEAVY PAPER, HEAVY PAPER H, TRANSPARENCY

(The factory default setting is in **bold face**.)

COMMON SETTINGS

Name	Descriptions
1. DEFAULT SETTINGS	Selects the Copy, or Scan mode for the machine's default mode. When the power cord is plugged in, or after the auto clear function activates, the standby display of the selected mode appears.
COPY	The Copy mode is selected as default.
SCAN	The Scan mode is selected as default.
2. TONER SAVER MODE	Sets the toner saver mode.
OFF	The toner saver mode is turned off.
ON	The toner saver mode is turned on.

Name	Descriptions
3. DISPLAY LANGUAGE	Shows the language displayed in the LCD. ENGLISH , FRENCH, SPANISH, PORTUGUESE

(The factory default setting is in **bold face**.)

COPY SETTINGS

Name	Descriptions
1. STD. IMAGEQUALITY	Selects the document type. TEXT/PHOTO : Text/photo mode TEXT: Character mode PHOTO: Photo mode
2. STANDARD EXPOSURE	Sets how the exposure is adjusted.
MANUAL	Adjusts the exposure manually. The exposure can be adjusted in 9 increments. (center)
AUTO	The exposure is adjusted automatically.
3. STANDARD COPY QTY	Selects the copy quantity. 1 to 99 (1)
4. AUTO SORT	Sets the auto sort function.
OFF	The auto sort function is turned off.
ON	The auto sort function is turned on.
5. PAPER SIZE GROUP	The paper size group can be selected. If the paper size group is changed, the preset copy ratios will also change.
INCH	Preset copy ratios: 50%, 64%, 78%, 100%, 129%, 200%
A	Preset copy ratios: 50%, 70%, 100%, 141%, 200%
AB	Preset copy ratios: 50%, 70%, 81%, 86%, 100%, 115%, 122%, 141%, 200%
6. SHARPNESS	The sharpness setting of an image can be adjusted. When you want to make characters and lines clear, select a larger value. When you make copies of photographs, select a smaller value. 1 to 9 (5)

(The factory default setting is in **bold face**.)

PRINTER SETTINGS

Name	Descriptions
1. ERROR TIME OUT	Sets the length of time before the machine returns an error when no data is received from the computer.
ON	The error time out is on. Sets the time out period. 5SEC to 300SEC (15SEC)
OFF	The error time out is off.

(The factory default setting is in **bold** face.)

TIMER SETTINGS

Name	Descriptions
1. AUTO CLEAR	Sets the auto clear function. If the machine remains idle for a set amount of time, the display returns to the standby mode.
ON	Sets the time until the machine returns to the standby mode. 1MIN. to 9MIN. (1MIN.)
OFF	The auto clear function is turned off.
2. ENERGY SAVER	Sets the energy saver mode.
ON	Sets the time until the machine enters the energy saver mode. 3MIN. to 30MIN. (5MIN.)
OFF	The auto energy saver function is turned off.

(The factory default setting is in **bold** face.)

This chapter lists the specifications of the machine and the index.

Specifications

Type	Personal Desktop
Platen	Stationary
Photoconductive Material	Organic Photosensitive Conductor
Copying System	Indirect Electrostatic Transfer System
Developing System	Toner Projection System
Fixing System	Canon's RAPID Fusing System™
Resolution	Approx. 600 dpi x 600 dpi
Number of Tones	256
Acceptable Documents	Up to LTR size Sheets, books, and three-dimensional objects (up to 4.4 lb (2 kg))
Acceptable Copy Stock	Cassette Feeding: 17 lb to 34 lb (64 g/m ² to 128 g/m ²) Multi-Purpose Feeder: 17 lb to 34 lb (64 g/m ² to 128 g/m ²) Plain paper, recycled paper, transparencies, envelopes, and heavy paper (up to 34 lb (128 g/m ²))
Copy Sizes	LTR (8 1/2" × 11" (216 mm × 279 mm))
Non-image Area	Paper: Max. 13/64" (5 mm) at each edge Envelope: Max. 13/64" (5 mm) at each edge

Warm-up Time	Approx. 260 sec. * (temperature: 68°F (20°C), humidity: 65%; from when the machine is plugged in until the standby display appears) * Warm-up time may differ depending on the condition and environment of the machine.
First Copy Time	Approx. 13.8 sec. A4 or LTR size, direct, Manual Exposure Control, Cassette Feeding (except just after being restored from energy saver mode)
Copy Speed	Direct: LTR 21 cpm
Magnification	1:1±1.0%, 1:2.000, 1:1.294, 1:0.786, 1:0.647, 1:0.500
Paper Feeding System	Cassette Feeding: 250 sheets of 17 lb (64 g/m ²) Multi-Purpose Feeder: 1 sheet
Multiple Copies	1-99
Power Requirements	120 V, 60 Hz (Power requirements differ depending on the country in which you purchased the product.)
Power Consumption	Approx. 0.7 kw (max.)
Dimensions (W x D x H)	17 ³ / ₄ " × 20 ¹ / ₂ " × 14 ⁵ / ₈ " (449 mm x 520 mm x 369 mm) (when the cassette extended)
Installation Space (W x D)	17 ³ / ₄ " × 20 ¹ / ₂ " (449 mm x 520 mm) (with the cassette attached)
Weight	Approx. 26.5 lb (12 kg) (including cartridge)

Features are subject to change without notice due to product improvements. For high-quality copies, we recommended using paper and transparencies recommended by Canon. Some types of paper available at office supply stores may not be suitable for this machine. If you have any questions about paper and transparencies, consult Canon Authorized Service Facilities or the Canon Customer Care Center.

Symbols

◀ (-), ▶ (+) keys, 1-4

A

ADJUSTING WAITING TO SCAN message, 9-8

Alarm indicator, 1-4

AUTO CLEAR setting, 10-4

AUTO SORT setting, 10-3

C

Cartridge

handling, 8-5

recycling, 8-6

replacing, 8-3, 8-13

storage, 8-5

Cassette, 1-2, 2-4

CHECK PAPER SIZE message, 9-8

CHECK PRINTER COVER message, 9-8

CHECK PRINTER message, 9-8

Cleaning

machine's exterior, 8-1

periodic, 8-1

scanning area, 8-2

Collate

copy, 5-7

Collate/2on1

key, 1-4

COMMON SETTINGS settings, 10-2

COPY key, 1-4

COPY SETTINGS settings, 10-3

Copying

adjusting the exposure, 5-5

adjusting the image quality, 5-5

document requirements, 3-1

making copies, 5-2

paper requirements, 2-1

problems, 9-14

setting enlarging/reducing, 5-4

specifying the paper size, 2-11

specifying the paper type, 2-12

Customer support, 1-1

D

DEFAULT SETTINGS setting, 10-2

DISPLAY LANGUAGE settings, 10-3

Document

orientation, 2-13

placing, 3-3

printing, 4-3

quantity, 3-1

requirements, 3-1

scanned area, 3-2

scanning, 6-2

size, 3-1

type, 3-1

weight, 3-1

Document feed

platen glass, 1-2, 3-3

E

Energy Saver

key, 1-4

restoring, 1-7

setting, 1-6

ENERGY SAVER setting, 10-4

Enlarge/Reduce

key, 1-4

setting, 5-4

Enlargement/Reduction, 5-4

Envelope
 loading, 2-9
 printing area, 2-3
Exposure
 key, 1-4
Extension cover, 1-3

F

Face up cover, 1-3
Feeder
 multi-purpose, 1-2
Front cover, 1-2

G

General problems, 9-19

I

Image Quality
 adjusting, 5-5
 key, 1-4
INSTALL CARTRIDGE message, 9-8

J

Jams clearing, 9-1

L

LCD, 1-4
LCD Messages, 9-8
Loading
 an envelope in the multi-purpose feeder, 2-9
 paper in the cassette, 2-4
 paper in the multi-purpose feeder, 2-8

M

Machine Settings
 accessing, 10-1
Making copies, 5-2
MEMORY FULL message, 9-9
Menu
 descriptions, 10-2
 key, 1-4
Multi-purpose feeder, 1-2
 loading an envelope, 2-9
 loading paper, 2-8
 paper requirements, 2-1

N

Numeric keys, 1-4

O

Operation panel, 1-2, 1-4
Orientation
 document, 2-13
 paper, 2-13
Output tray, 1-2

P

Paper
 acceptable paper, 2-2
 cassette, 1-2
 feeding problems, 9-11
 jam, 2-2
 loading, 2-4
 orientation, 2-13
 output area, 2-14
 printing area, 2-3
 requirements, 2-1
 type, 2-12, 2-14
Paper output area
 face down, 2-15
 face up, 2-16

PAPER SETTINGS settings, 10-2
PAPER SIZE GROUP setting, 10-3
PAPER SIZE settings, 10-2
PAPER TYPE setting, 10-2
Periodic cleaning, 8-1
Placing documents, 3-3
Plain paper, 2-12
Platen
 glass, 1-2
 glass cover, 1-2
Power socket, 1-3
Print media
 requirements, 2-1
 size, 2-2
 type, 2-2
 weight, 2-2
Print quality problems, 9-15
Print yield, 8-4
PRINTER DATA ERROR message, 9-9
Printing
 areas, 2-3
 beforehand, 4-1
 canceling, 4-4
 documents, 4-3
 problems, 9-17
Problems
 cannot solve, 9-20
 copying, 9-14
 general, 9-19
 paper feeding, 9-11
 print quality, 9-15
 printing, 9-17
 scanning, 9-18

Q

Quality
 adjusting the image, 5-5
 print problems, 9-15
Quantity, document, 3-1

R

REC. PAPER JAM message, 9-9
Reduce key, 1-4
REMOVE MP PAPER message, 9-9
Repacking, 8-16
Replacing the cartridge, 8-3, 8-13
Reserve copy, 5-10

S

SCAN key, 1-4
Scanned area, 3-2
Scanning
 areas, 3-2
 beforehand, 6-1
 documents, 6-2
 problems, 9-18
Set key, 1-4
SHARPNESS setting, 10-3
Size
 document, 3-1
 marks, 3-3
 print media, 2-2
Slide guides
 multi-purpose feeder, 2-10
Specifications, 11-1
STANDARD COPY QTY setting, 10-3
STANDARD EXPOSURE setting, 10-3
Standby display, 1-5
Start key, 1-4
Status Monitor
 key, 1-4
 using, 7-1
STD. IMAGEQUALITY setting, 10-3
Stop/Reset key, 1-4
SUPPLY REC. PAPER message, 9-10
System monitor, 7-1

T

Toner in the cartridge, 8-3
TONER SAVER MODE setting, 10-2

Transporting, 8-16
Tray
 output, 1-2
Troubleshooting, 9-1

U

USB port, 1-3

W

Weight
 document, 3-1
 machine, 11-2
 print media, 2-2



MEMO



MEMO
