

Starter Guide

**Please read this guide before operating this product.
After you finish reading this guide, store it in a safe place for future
reference.**



Unpacking the Machine

Remove all shipping tape and packing materials from the machine.

1

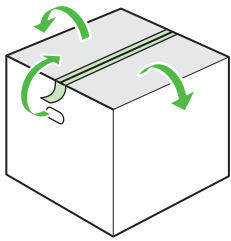

2

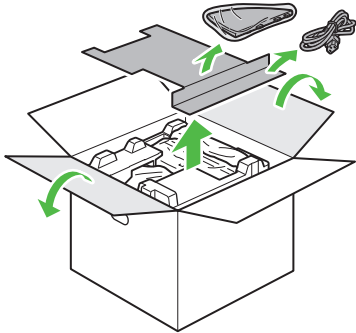

3

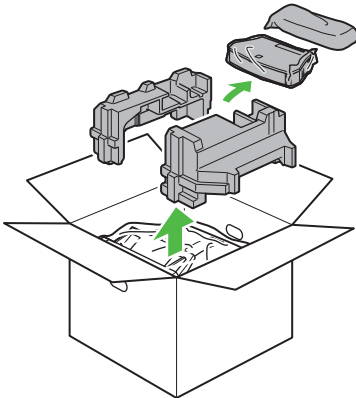

4

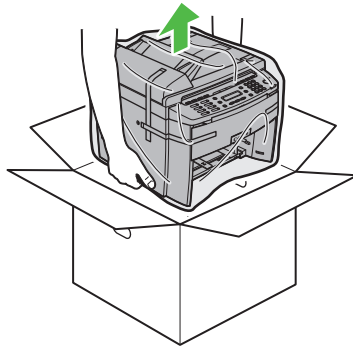

5

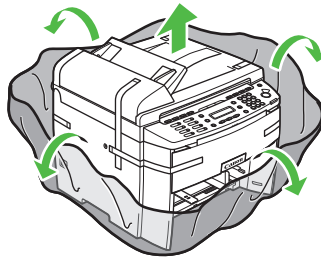

6

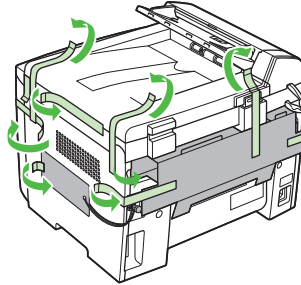

7

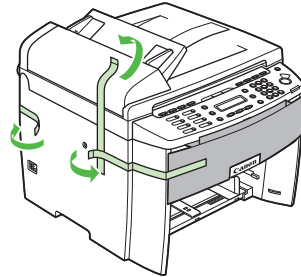

8

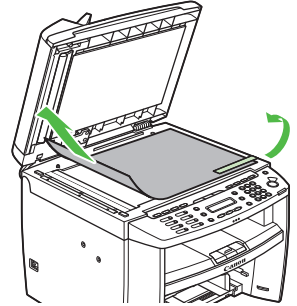

9

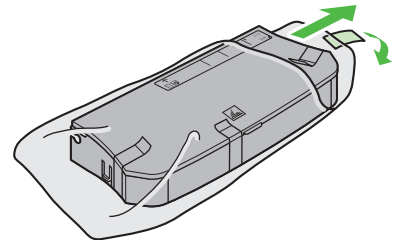

10

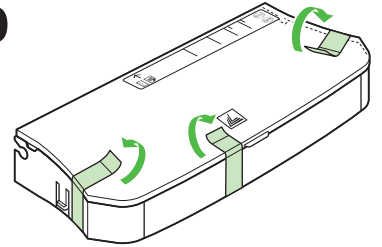

11

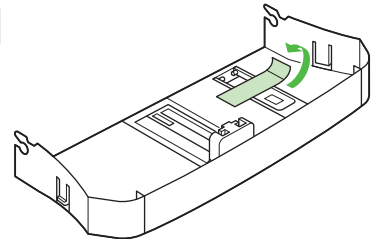

 **NOTE**

When carrying the machine, grip the handles on both left and right sides of the machine and lift it carefully, as shown in the illustration below.

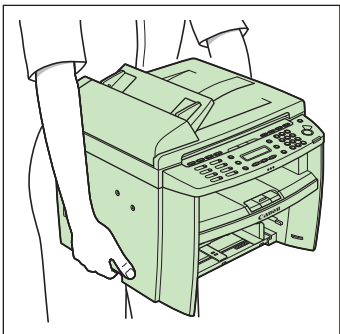

Contents

What You Can Do with the Machine	2
Find Your Purpose on the Machine	3
Set Up the Machine	4
Do You Have Everything?.....	4
Manuals for the machine	4
Install Toner Cartridge.....	5
Set Up the Paper Cassette and Load Paper	8
Connect the Power Cord and Turn On the Machine	10
Set the Date and Time.....	11
Before FAX Setting	12
Connect Telephone Cables.....	12
If Necessary to Use Pulse Dialing	13
Set the Machine for Sending Faxes	14
Entering Information.....	14
Registering Sender Information	15
Guidelines for Entering Information.....	15
Set the Machine for Receiving Faxes	16
Select the Receive Mode that Suits Your Needs	16
Set the Receive Mode.....	16
About the Receiving Modes	17
Software Settings with Computer	18
Types of Connection Between Computer and the Machine.....	18
Network Connection	18
USB Connection	18
About User Software CD	19
MF Driver & Toolbox	19
Bundled Program	20
Manual.....	20
Network Connection	21
Connect the Machine to a Network.....	21
Automatic Setting	21
Manual Setting	22
Installation Procedure.....	23
Checking the Installation.....	26
USB Connection.....	27
Installation Procedure.....	27
Checking the Installation.....	30
Appendix	31
Uninstallation Procedure	31
Uninstalling the MF Toolbox (USB Connection only)	31
Uninstalling the MF Drivers	31
Using Online Help.....	32

What You Can Do with the Machine

You can use the following functions with imageCLASS MF4270.

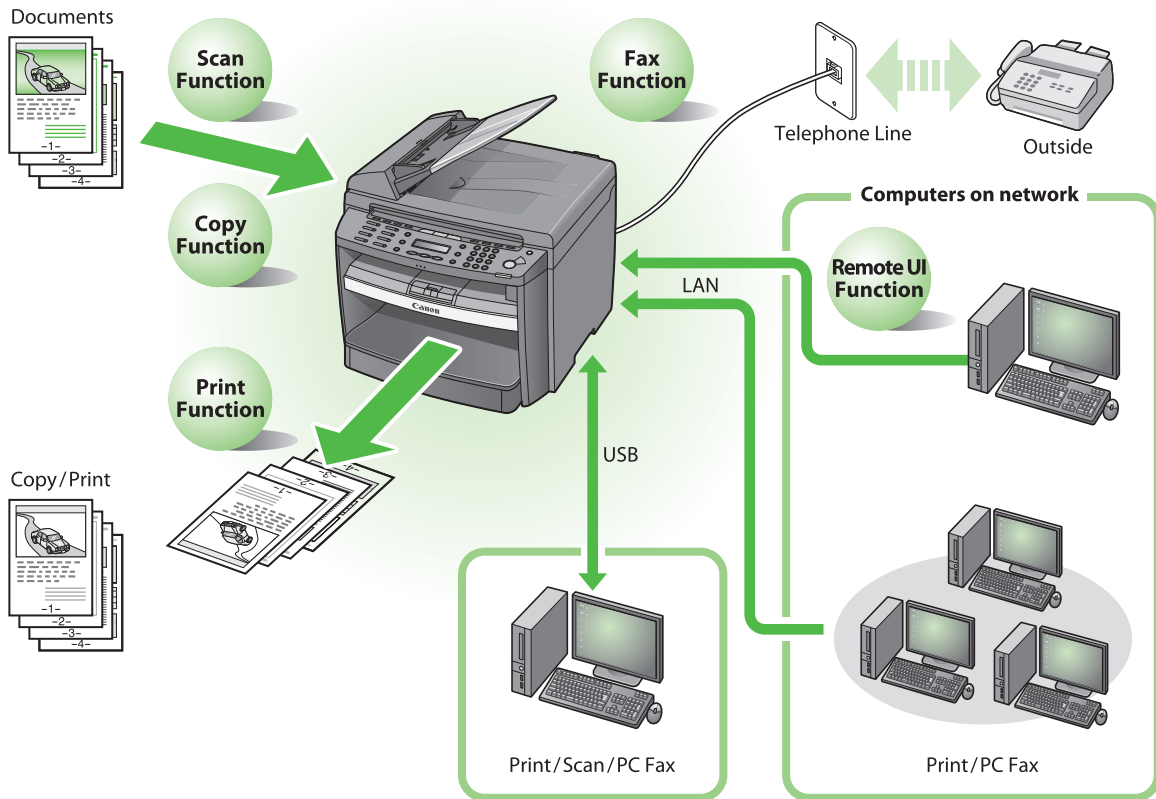

Find Your Purpose on the Machine

For using each function (COPY, FAX, PRINTER, SCANNER, PC FAXING, REMOTE UI), follow the settings in the flowchart below.

For example, when you use copy function only, follow "Necessary Settings". When you use both copy and fax function, follow "Necessary Settings" and "Fax Settings".

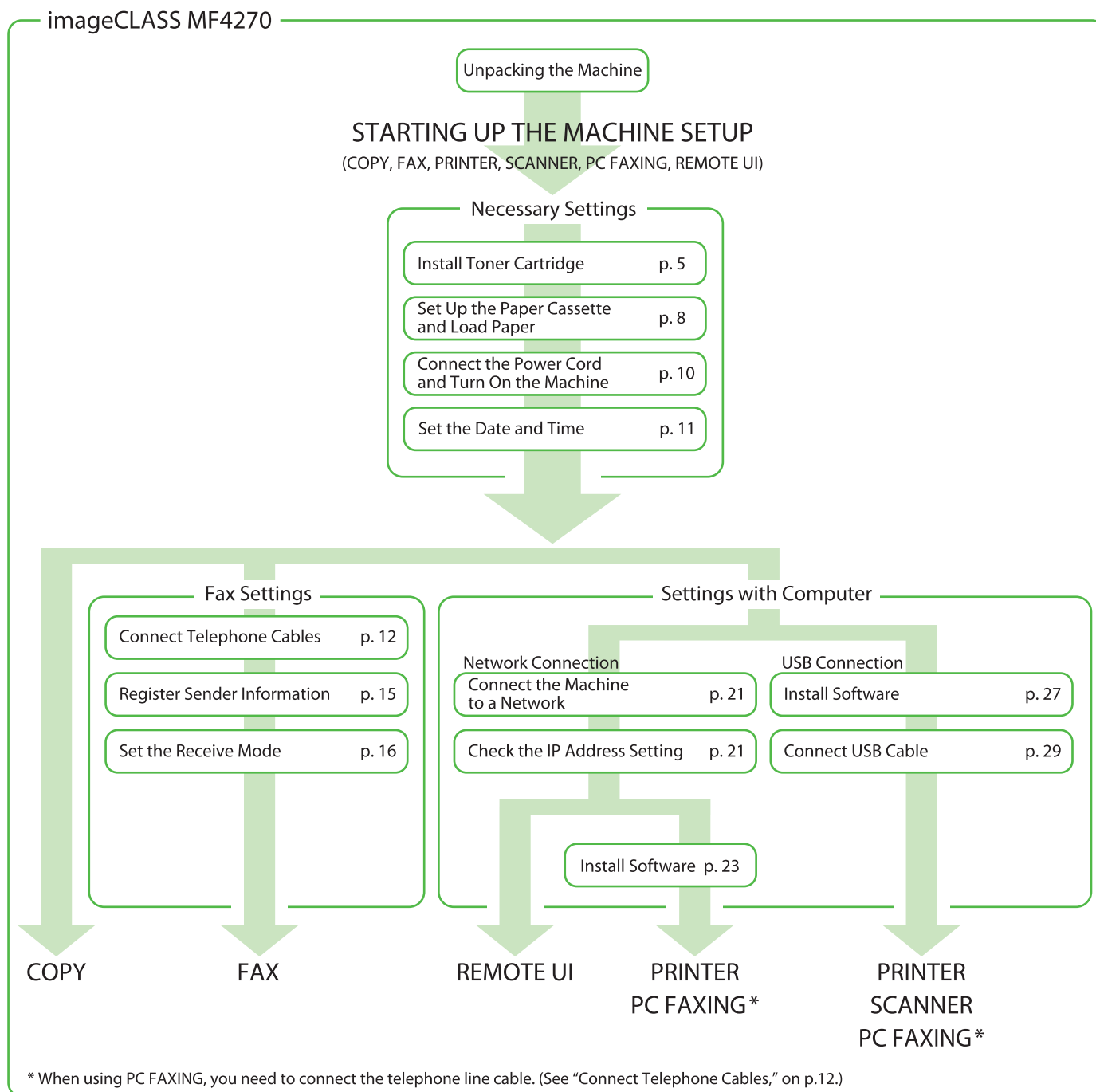

* When using PC FAXING, you need to connect the telephone line cable. (See "Connect Telephone Cables," on p.12.)

Set Up the Machine

Do You Have Everything?

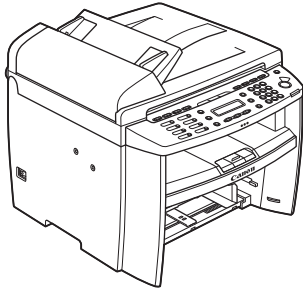

● Machine

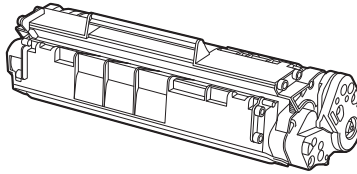

● Toner Cartridge

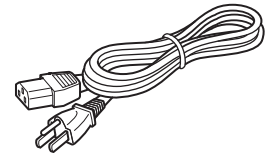

● Power Cord

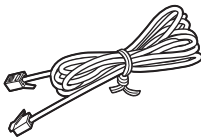

● Telephone Cable

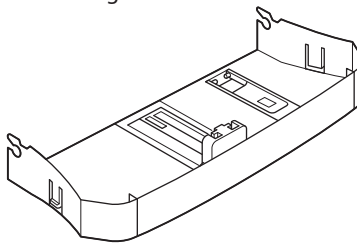

● Paper Cassette

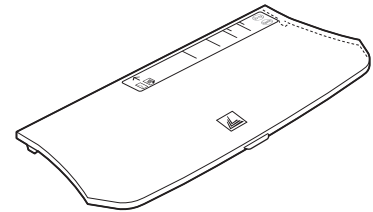

● Dust Cover

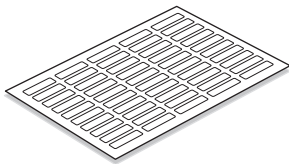

● Destination Labels

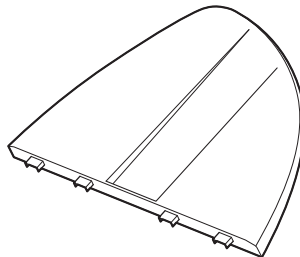

● Document Feeder Tray

● Limited Warranty Notice

● Registration Card

● Starter Guide (This Document)

● Basic Operation Guide

● User Software CD

Manuals for the machine



● Starter Guide: Machine set-up and software installation
(This Document)



● Basic Operation Guide: Basic operation features



(User software CD)

● Reference Guide: Total operation features
(Also includes the basic operation guide contents.)

● Scanner Driver Guide : Scanner settings

Install Toner Cartridge

- 1** Remove the toner cartridge from the bag.

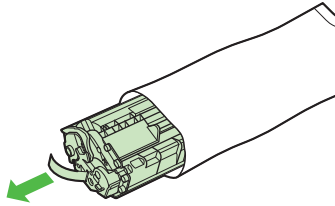

CAUTION

Do not open the drum protective shutter (A).

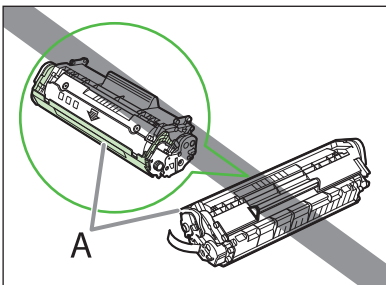

- 2** Gently rock the toner cartridge several times to evenly distribute the toner inside.

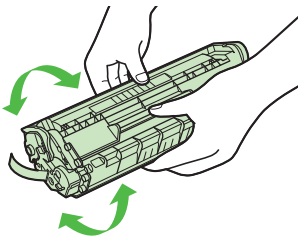

- 3** Place the toner cartridge on a flat surface and pull the seal completely out.

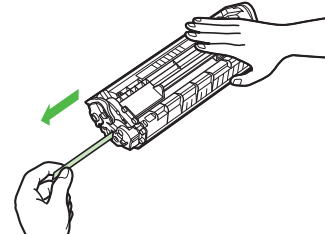

NOTE

Do not pull the seal out at an angle.

CAUTION

- If toner is adhered on the removed seal, be careful that your hands or clothes do not get dirty from touching the toner.
- If your hands or clothes get dirty from touching the toner, wash them immediately in cold water. Do not use hot water. If you do, the toner may be set permanently.

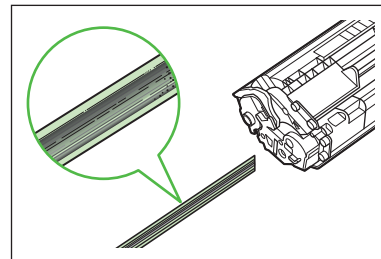

- 4** Hold the front side of the operation panel with your hands.

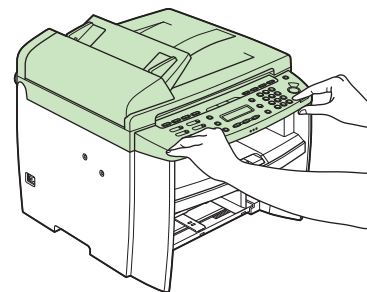

Set Up the Machine

- 5** Lift the scanning platform (A) until it is locked. (You will hear an audible “click.”)

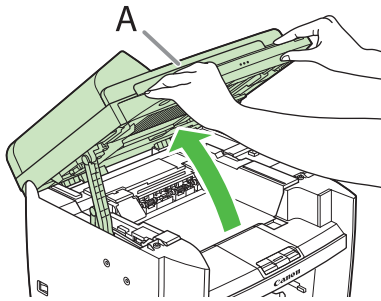

- 6** Hold the grip (A) on the right front side of the toner cover.

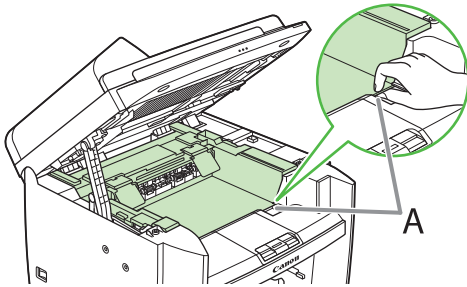

- 7** Open the toner cover.

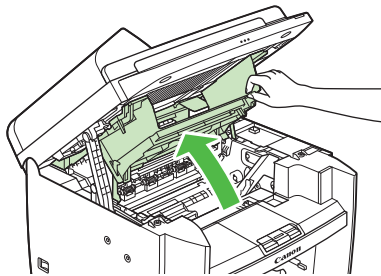

- 8** Hold the toner cartridge by its handle (A).

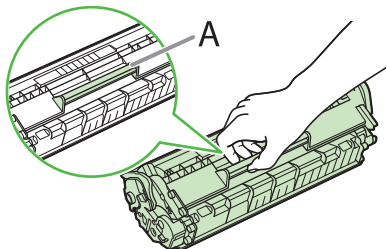

- 9** Insert the toner cartridge so that the protrusion on the right side of the toner cartridge (A) fits into the guide (B) located on the right side of the machine and slide it down parallel to the guide.

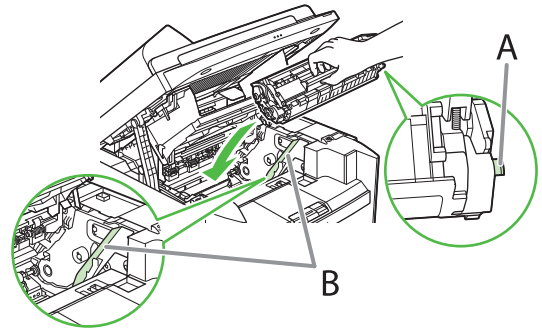

- 10** Push the toner cartridge to make sure it is properly set in the machine.

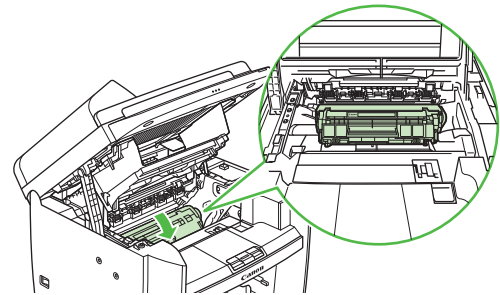

- 11** Hold the grip (A) on the right front side of the toner cover.

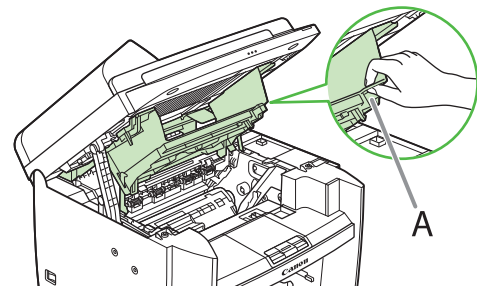

12 Close the toner cover.

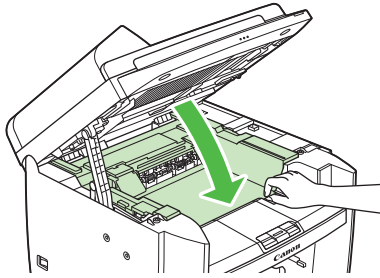

13 Lower the scanning platform.

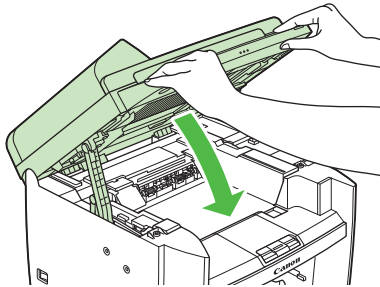

CAUTION

- Be careful not to get your fingers caught.
- If you cannot close the toner cover, do not force it to close. Open the cover and make sure the toner cartridge is properly set in the machine.

Set Up the Paper Cassette and Load Paper

- 1 Align the guides (B) on the both edges of the paper cassette to the protrusions (A) inside the machine.

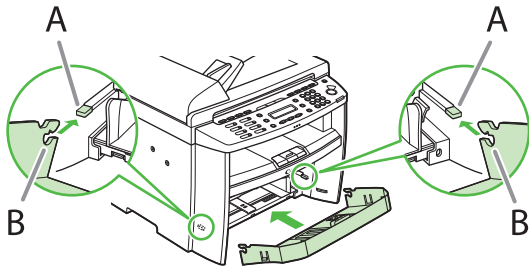

NOTE

Install the paper cassette with the front end tilted upwards.

- 2 Push the paper cassette down until the hooks (A) on both sides of the paper cassette engage the protrusions (B) inside the machine.

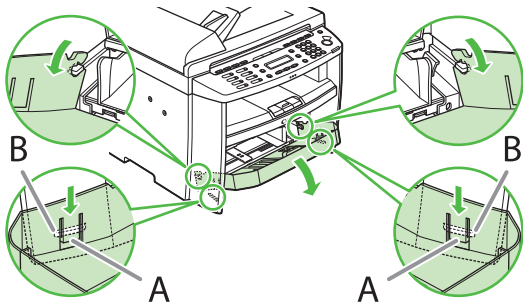

- 3 Open the front panel of the paper cassette.

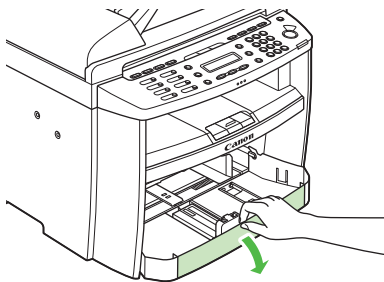

- 4 Slide out the paper guide rail (A).

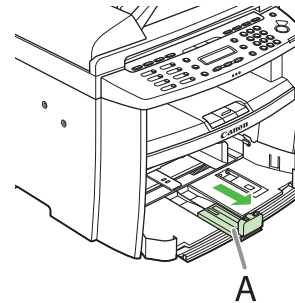

- 5 Slide the side paper guides (A) to match the size of paper.

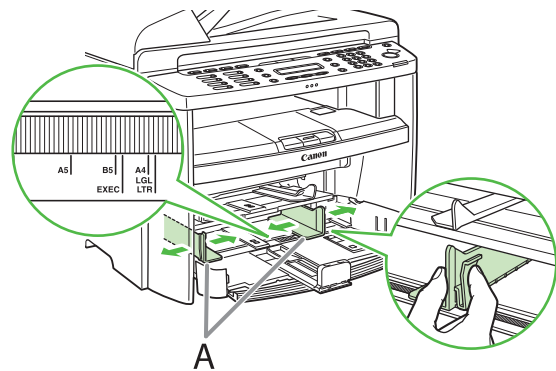

- 6 Fan the paper stack and even the edges.

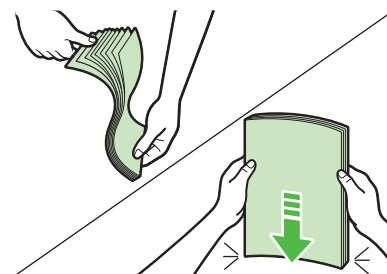

- 7** Load the paper into the paper cassette with the print side up. Make sure the paper stack sits below the small fin (A) on the side paper guide.

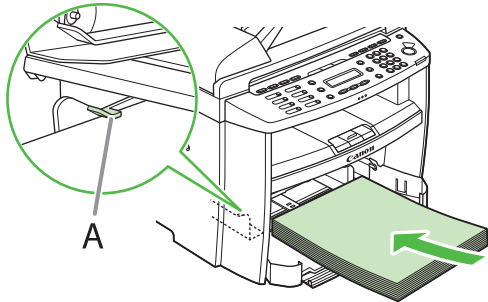

- 8** Adjust the paper guide rail to match the size of paper.

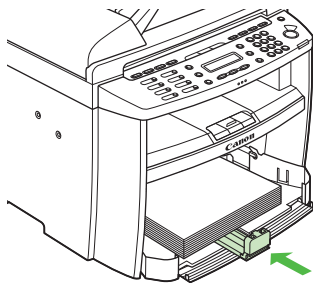

- 9** Close the front panel of the paper cassette.

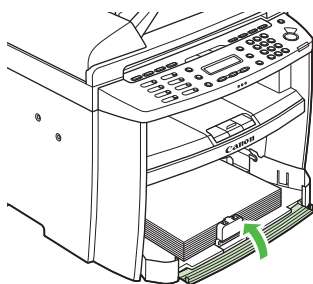

NOTE

To load Legal-size paper, leave the front panel of paper cassette open and adjust the paper guide rail (A) for Legal-size paper.

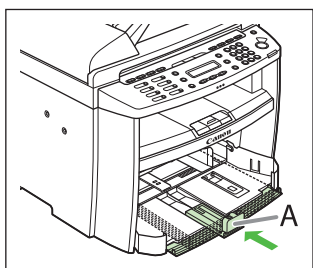

- 10** Match up the edge of the dust cover (A) and the edge of the paper cassette (B), and place the cover on top of the cassette.

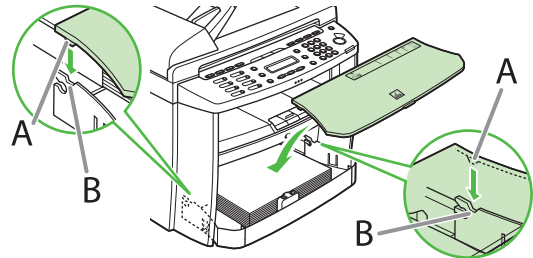

- 11** Attach the document feeder tray on the document feeder.



NOTE

- The default paper size/type setting is <LTR> and <PLAIN PAPER>. When you load other size and/or type of paper, change the paper size/type setting. For details, see Chapter 2, “Document and Paper,” in the Basic Operation Guide.
- For loading paper in the multi-purpose tray, see Chapter 2, “Document and Paper,” in the Basic Operation Guide.
- If a printout falls out of the output tray, extend the output tray extension on the front side of the machine and set the paper stopper upright.

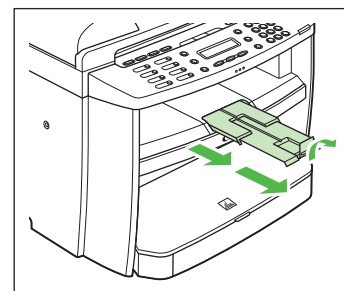

Connect the Power Cord and Turn On the Machine

- 1 Connect the power cord into the rear socket on the back side of the machine and the wall outlet, and press the [I] side of the main power switch (A) to ON.

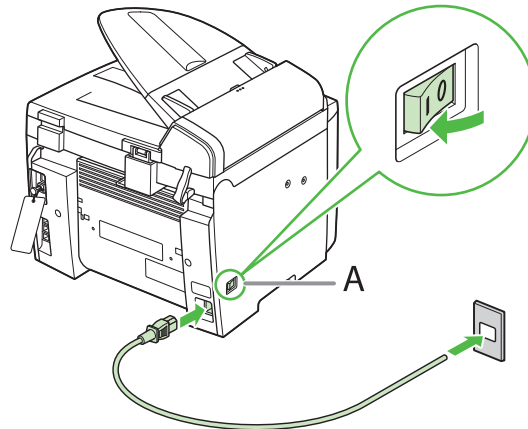

- 2 The machine enters the standby mode.

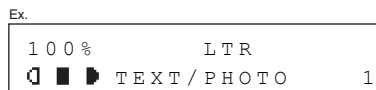

What if...

- **The LCD display turned off:**

The machine may enter the sleep mode while you are setting up the machine. Press [Energy Saver] to turn the machine back on and continue the setup.

- **<CLOSE COVER/TONER COVER> is displayed:**

Make sure that the toner cover and scanning platform are closed properly. (See "Install Toner Cartridge," on p. 5.)

- **<SET PAPER AGAIN/SET TONER AGAIN> is displayed:**

Check the installation of the toner cartridge and the placement of the paper. (See "Install Toner Cartridge," on p. 5 and "Set Up the Paper Cassette and Load Paper," on p. 8.)

NOTE

Any data stored in the memory, including received fax documents, will be deleted if you turn off the main power switch of the machine.

Set the Date and Time

Before using the machine, you **MUST** set the current date and time. The current date and time settings are used as standard timer settings for functions that require them.

● Entering Information

- Numeric keys: Enters numbers.
- [**←**] or [**→**]: Moves the cursor position.
- [**OK**]: Confirms the entry.

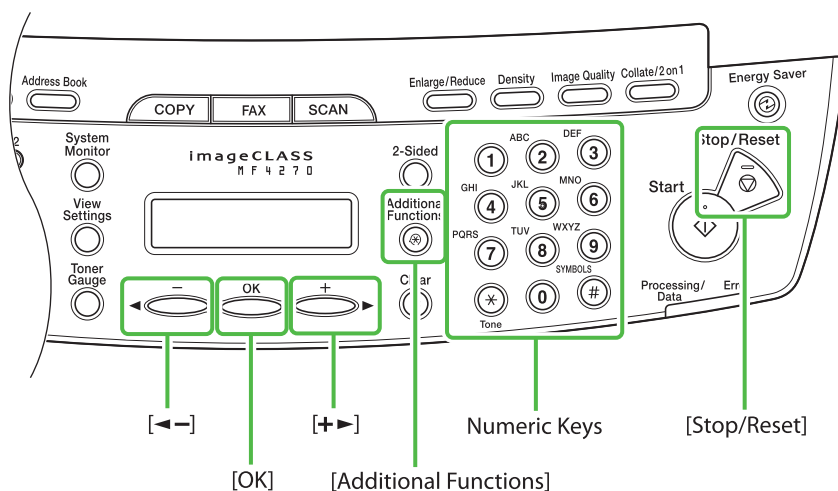

- 1 Press [Additional Functions].
- 2 Press [**←**] or [**→**] to select <9 TIMER SETTINGS>, then press [**OK**].
- 3 Press [**←**] or [**→**] to select <1 DATE&TIME SETTING>, then press [**OK**].
- 4 Use the numeric keys to enter the date (month/day/year) and time (in 24-hour/military time format), then press [**OK**].

Ex.

DATE&TIME	SETTING
15:50	12 31 '07

NOTE

If you accidentally enter an incorrect number, press [**←**] or [**→**] to move the cursor to the number that needs correcting and overwrite it.

- 5 Press [Stop/Reset] to return to the standby mode.

NOTE

- You can select one of the following three date formats in <2 DATE TYPE SELECT>.
 - <MM/DD/YYYY>
 - <DD/MM YYYY>
 - <YYYY MM/DD>
- By default, <4 DAYLIGHT SV.TIME> in the <9 TIMER SETTINGS> menu is set to <OFF>. If you want to set <4 DAYLIGHT SV.TIME> in the <9 TIMER SETTINGS> menu to <ON>, see Chapter 1, "Before Using the Machine," in the Basic Operation Guide.

What if...

● The LCD display turned off:

The machine may enter the sleep mode while you are setting up the machine. Press [Energy Saver] to turn the machine back on and continue the setup.

Before FAX Setting

Connect Telephone Cables

- Connect the supplied telephone cable to the telephone line jack (A) on the back side of the machine and the wall jack.

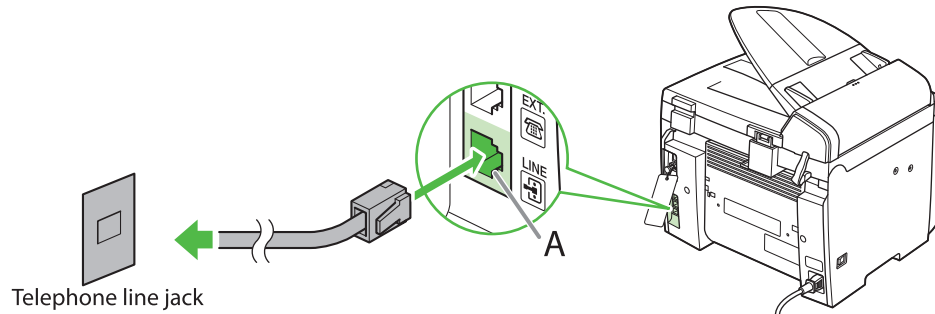

- If you want to connect your own external telephone or telephone with built-in answering machine, connect it to external device jack (B) on the back side of machine.

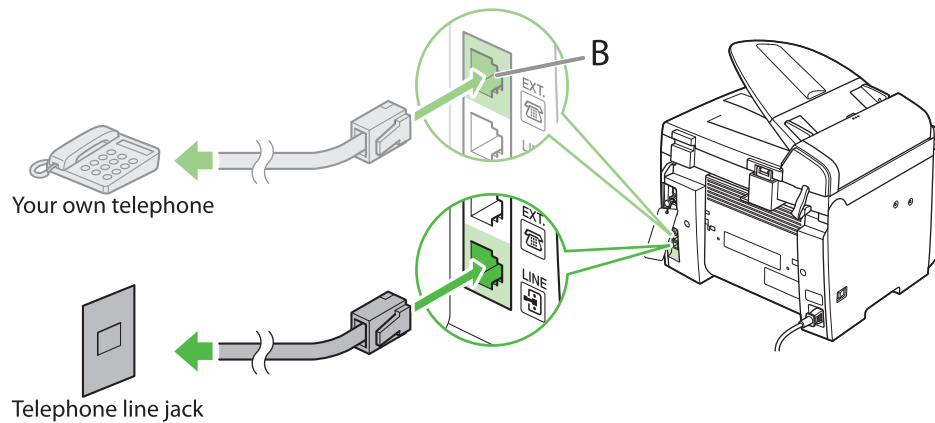

If Necessary to Use Pulse Dialing

By default, telephone line type on the machine is set to tone dialing. When you use tone dialing, skip the following procedure.

When you use pulse dialing, follow the procedure below and change the telephone line type setting to <ROTARY PULSE> on the machine.

If you do not know the type of telephone line you use, contact your local telephone company.

- 1** Press [Additional Functions].
- 2** Press [◀] or [▶] to select <6 FAX SETTINGS>, then press [OK].
- 3** Press [◀] or [▶] to select <2 USER SETTINGS>, then press [OK].
- 4** Press [◀] or [▶] to select <3 TEL LINE TYPE>, then press [OK].
- 5** Press [◀] or [▶] to select the telephone type, then press [OK].
<TOUCH TONE>: Tone dialing (Default)
<ROTARY PULSE>: Pulse dialing
- 6** Press [Stop/Reset] to return to the standby mode.

Set the Machine for Sending Faxes

Entering Information

Use the following keys to enter information in the machine.

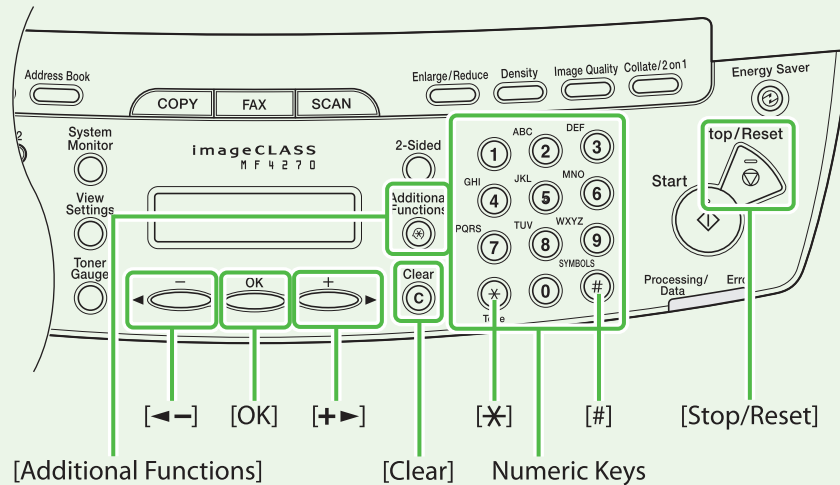

You can enter the following characters in each input mode:

ⓧ	→[A]	[1]
①		1
②	ABCabc	2
③	DEFdef	3
④	GHIghi	4
⑤	JKLjkl	5
⑥	MNOmno	6
⑦	PQRSpqrs	7
⑧	TUVtuv	8
⑨	WXYZwxyz	9
⑩	0	
ⓧ	(space) - . * # ! " , ; : ^ ` _ = / ' ? \$ @ % & + () [] { } < >	#

- Use the numeric keys to enter characters.
Press the numeric key repeatedly until the required character appears.
- Press [#] to enter symbols.
- Press [*] to switch between input modes:
 - [A]: Letter mode
 - [1]: Number mode
- Press [←] or [→] to move the cursor position.
- Press [Clear] to delete the character at the cursor position. Hold [Clear] to delete the entire entry.

Registering Sender Information

Before sending documents, you **MUST** register your fax number, unit name, and the current date and time in the machine.

Guidelines for Entering Information

The sender information you register in the machine appears in the header of each page received by your recipient.

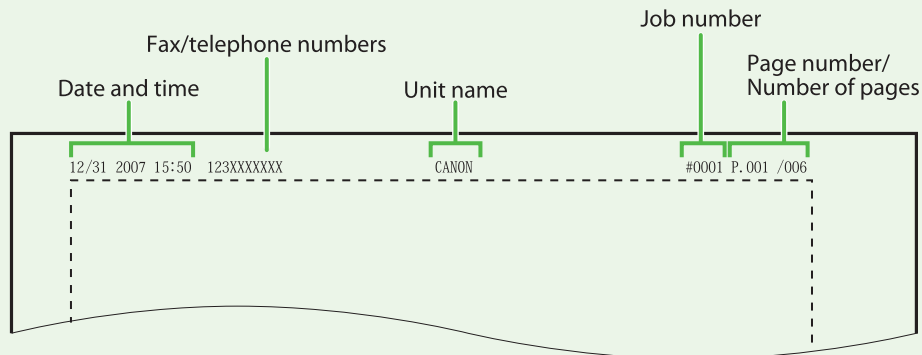

- 1** Press [Additional Functions].
- 2** Press [◀] or [▶] to select <6 FAX SETTINGS>, then press [OK].
- 3** Press [◀] or [▶] to select <2 USER SETTINGS>, then press [OK].
- 4** Press [◀] or [▶] to select <1 UNIT TELEPHONE #>, then press [OK].
- 5** Use the numeric keys to enter your fax number (up to 20 digits including spaces), then press [OK]. (For information on how to enter characters, see p. 14.)
- 6** Press [◀] or [▶] to select <2 USER SETTINGS>, then press [OK].
- 7** Press [◀] or [▶] to select <2 UNIT NAME>, then press [OK].
- 8** Use the numeric keys to enter the unit name (up to 32 characters) (your name, company name, etc.), then press [OK]. (For information on how to enter characters, see p. 14.)
- 9** Press [Stop/Reset] to return to the Standby mode.

Ex.

UNIT TELEPHONE #	
1 2 3 X X X X X X X X _	

Ex.

UNIT NAME	[A]
C a n o n	

NOTE

You can enter a space, -, and + by pressing [#] key in <1 UNIT TELEPHONE #>.

What if...

● The LCD display turned off:

The machine may enter the sleep mode while you are setting up the machine. Press [Energy Saver] to turn the machine back on and continue the setup.

Set the Machine for Receiving Faxes

Select the Receive Mode that Suits Your Needs

The receive mode determines how the machine responds to incoming faxes and voice calls. Select the mode which is most suitable for you from the chart below. For details, see “About the Receiving Modes,” on p. 17.

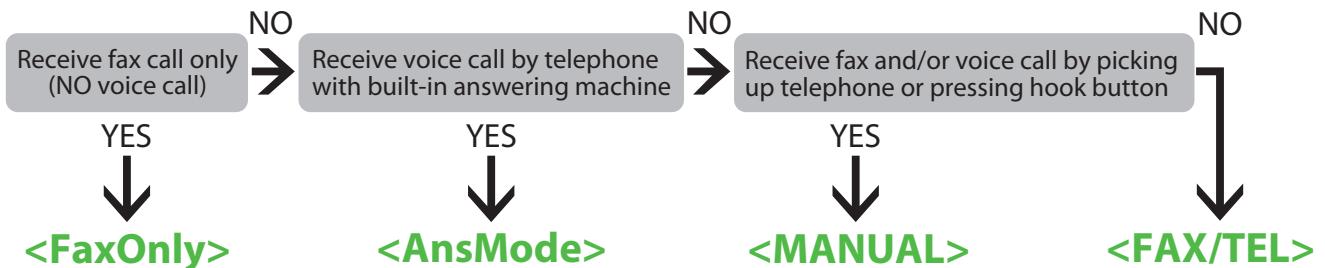

NOTE

- The remote reception function is useful when the receive mode is set to <MANUAL> and connected to an external telephone. You can receive faxes by picking up the external telephone and pressing a two-digit remote reception ID (the default setting is 25). For details, see Chapter 4, “Sending and receiving” in the Reference Guide.
- Your telephone with built-in answering machine or answering machine must be connected directly to the machine for <AnsMode> to work. (See “Connect Telephone Cables,” on p. 12.)
- The external telephone must be connected to the machine for <FAX/TEL> or <MANUAL> to work. (See “Connect Telephone Cables,” on p. 12.)
- By default, <FaxOnly> is selected in <1 RX MODE>. If external telephone is connected to the machine and receives a fax or voice call, the external telephone rings. You can answer the voice call while the external telephone is ringing. For incoming ring to be disabled, press [Additional Functions] → <6 FAX SETTINGS> → <4 RX SETTINGS> → <3 INCOMING RING> then select <OFF>.
- Voice mail is not supported with <AnsMode>.
- DRPD (Distinctive Ring Pattern Detection) service assigns two or more telephone numbers with distinctive ring patterns to a single telephone line, allowing you to have both a fax number(s) and a telephone number(s) using only one telephone line. Your fax will automatically monitor incoming calls and based on the ring pattern, will let you know if the call is a fax or voice call. Set the fax ring pattern that matches the pattern assigned by your telephone company. Contact your telephone company for availability.

Set the Receive Mode

- 1 Press [Additional Functions].
- 2 Press [◀→] or [▶+] to select <6 FAX SETTINGS>, then press [OK].
- 3 Press [◀→] or [▶+] to select <1 RX MODE>, then press [OK].
- 4 Press [◀→] or [▶+] to select the receive mode, then press [OK].

- 5 Press [Stop/Reset] to return to the standby mode.

What if...

● The LCD display turned off:

The machine may enter the sleep mode while you are setting up the machine. Press [Energy Saver] to turn the machine back on and continue the setup.

About the Receiving Modes

<FaxOnly>

Receives faxes automatically. When you use only the fax function, select this mode without connecting to the external telephone.

● Upon Receiving FAX

The machine receives faxes automatically.

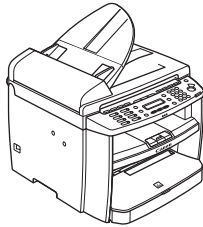

● Upon Receiving VOICE CALL

The machine does not respond.

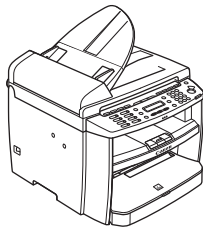

<AnsMode>

Receives faxes automatically and routes voice calls to the telephone with built-in answering machine.

● Upon Receiving FAX

The telephone with built-in answering machine rings and the machine receives fax automatically.

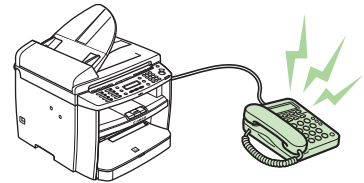

● Upon Receiving VOICE CALL

The telephone with built-in answering machine rings and records voice messages.

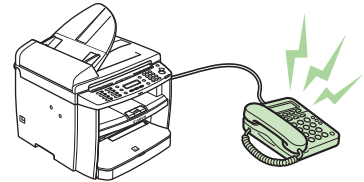

<MANUAL>

Rings for every call, whether it is a fax call or a voice call. For a fax call, you have to manually activate reception of the fax.

● Upon Receiving FAX

The external phone rings. To receive the fax, you can either pick up the receiver and press [Start] key or press [Hook] key and press [Start] key. Alternatively, you can use the remote reception function through the external telephone.

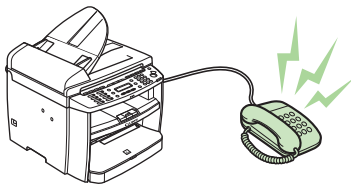

● Upon Receiving VOICE CALL

The external telephone rings. Answer the call.

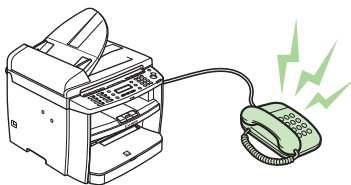

<FAX/TEL>

Automatically switches between fax calls and voice calls. Receives faxes automatically and the machine rings for voice calls.

● Upon Receiving FAX

The machine receives fax automatically.

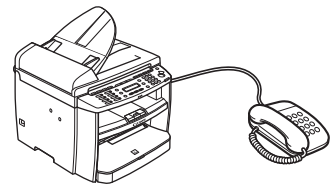

● Upon Receiving VOICE CALL

The machine rings. Answer the call.

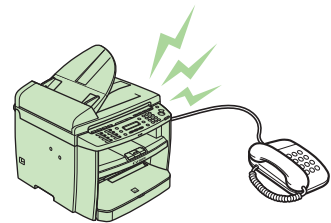

Software Settings with Computer

Types of Connection Between Computer and the Machine

There are two ways to connect the machine and computer: USB connection and Network connection.

Network Connection (For details on how to set up, see p. 21.)

You can print and fax the documents, and change the machine settings from a computer through a network.

For details of each function with Network Connection, see following guides.

- | | | |
|-----------------|---|--|
| Print Documents | → | Chapter 5, "Printing and Scanning," in the Reference Guide |
| Remote UI | → | Chapter 7, "Remote UI," in the Reference Guide |
| PC Faxing | → | Chapter 4, "Sending and receiving," in the Reference Guide |

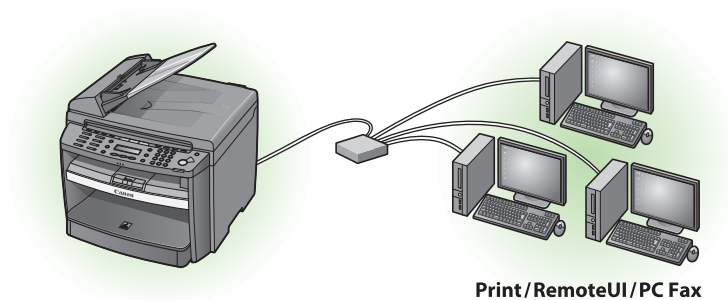

USB Connection (For details on how to set up, see p. 27.)

You can print and fax the documents sent from a computer and scan documents into computer.

For details of each function with USB Connection, see following guides.

- | | | |
|-----------------|---|--|
| Print Documents | → | Chapter 5, "Printing and Scanning," in the Reference Guide |
| PC Faxing | → | Chapter 4, "Sending and receiving," in the Reference Guide |
| Scan Documents | → | Chapter 5, "Printing and Scanning," in the Reference Guide |

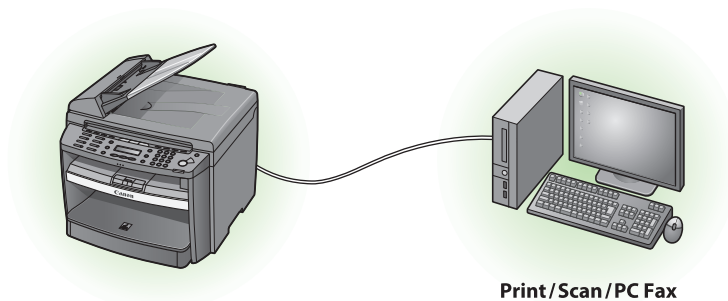

NOTE

- The scanner driver is available only through a USB connection.
- You can use functions for USB connection and network connection together.

System Requirements

Microsoft Windows 2000

CPU: Intel Pentium/133MHz or faster
Memory: 128MB or more

Microsoft Windows XP

CPU: Intel Pentium/Celeron series
300MHz or faster
Memory: 128MB or more

Microsoft Windows Server 2003*

CPU: Intel Pentium/Celeron series
133MHz or faster
Memory: 128MB or more
*Network only

Microsoft Windows Vista

CPU: Intel Pentium 800MHz or faster
Memory: 512MB or more

About User Software CD

MF Driver & Toolbox



UFR II LT Driver

The Canon UFR II LT printer driver enables you to print from any application software to the machine. Taking full advantage of your PC's processing power to compress the print data, this driver executes the high-speed data processing.



FAX Driver

FAX Driver is conceptually akin to a printer driver. A user would select [Print] from any Windows application software, select the Canon fax driver as the printer, and specify its destination(s) and options. The fax driver would then convert this into an image that conforms to standard fax protocols, to be printed or stored on the recipient fax machine(s).



Scanner Driver (Only available using a USB connection)

Scanner Driver enables computer to use the machine as scanner.



MF Toolbox

MF Toolbox is a program that allows you to easily import images scanned with a scanner into an application, attach them to e-mail messages, save them to hard disks, etc.

Bundled Program

To install the following programs, load the User Software CD into a computer, click on the [Easy Installation] or [Custom Installation] button on the CD-ROM Setup (Software Programs) screen, then follow the instructions that appear on the screen. If the CD-ROM Setup (Software Programs) screen is not displayed, click [Start] on the Windows task bar → [My Computer]. (Windows Vista: click [start] on the Windows task bar → [Computer]. Windows 2000: double-click [My Computer] on the Windows desktop.) Open the CD-ROM icon, then double-click [MInst] ([MInst.exe]).

ScanSoft OmniPage

ScanSoft OmniPage makes it easy to convert scanned paper documents and images from image files into editable text for use in your favorite computer applications. For details, see online help for this program.

Manual

Reference Guide

Reference Guide consists of total operation features, network and remote user interface, system manager settings, reports and lists, and trouble shooting. Also includes the basic operation guide contents.



Presto! PageManager

Presto! PageManager makes it easy to scan, share and organize photos and documents. For details, see the online manual and online help for this program.



NetSpot Device Installer (NSDI)

NetSpot Device Installer enables you to set up the machine for network operations. When you start this program, click on the [Additional Software Programs] button in step 2 of "Installation Procedure - For USB Connection" or in step 2 of "Installation Procedure - For Network Connection - Install Software," then follow the instructions that appear on the screen. For details, see the Readme file and online help for this program.



NOTE

ScanSoft OmniPage and Presto! PageManager are not supported on Windows XP 64-bit version.

Scanner Driver Guide

Scanner Driver Guide consists of scanner settings from a computer.

Network Connection

Connect the Machine to a Network

Connect a Category 5 or greater twisted pair LAN cable to the 10Base-T/100Base-TX port on the back of the machine. Connect the other end of the cable to a network router or a hub.

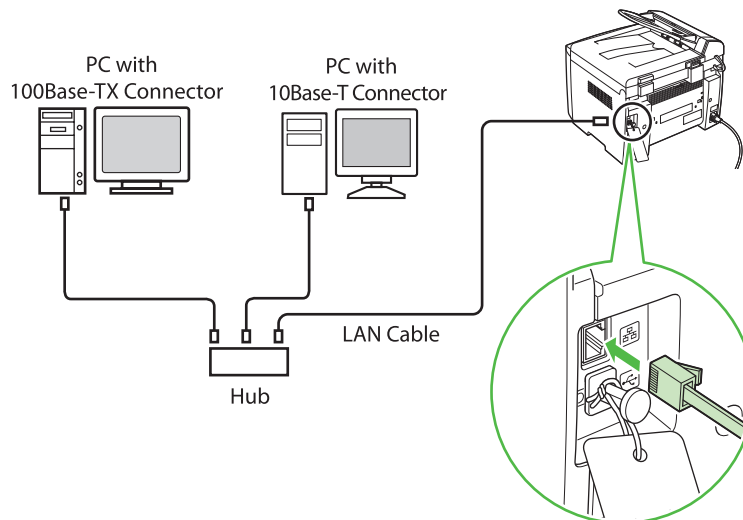

NOTE

- The machine does not come with a LAN cable.
- If you use the machine as a local printer, connect the machine directly to a computer using a USB cable. (See “USB Connection,” on p. 27.)

Automatic Setting

By default, the IP address is assigned to the machine automatically by the DHCP server. Therefore, all you have to do when using DHCP is just to connect the network cable. After connecting the LAN CABLE, wait for 30 seconds until the machine gets the IP address.

● Checking the IP Address Setting

To make sure this machine is communicated with the network properly, follow the procedure on p. 22.

NOTE

- It is recommended that the network administrator perform the procedure on p. 22.
- Before performing the procedure on p. 22, make sure that the machine is turned on and connected to a network.

What if...

● The LCD display turned off:

The machine may enter the sleep mode while you are setting up the machine. Press [Energy Saver] to turn the machine back on and continue the setup.

- 1 Press [Additional Functions].
- 2 Press [◀] or [▶] to select <12 SYSTEM SETTINGS>, then press [OK].
- 3 Press [◀] or [▶] to select <2 NETWORK SETTINGS>, then press [OK].
- 4 Press [◀] or [▶] to select <4 VIEW IP ADDRESS>, then press [OK].

- 5 Press [◀] or [▶] to select <1 IP ADDRESS>, <2 SUBNET MASK>, or <3 GATEWAY ADDRESS>, then press [OK].

If the machine is communicated with the network properly, the IP address, subnet mask and gateway address are displayed.

If not, IP address, subnet mask and gateway address are not displayed.

If the machine does not get the IP address 30 seconds after you connect the LAN cable, turn off the main power switch once, and then turn it on again and wait for another 90 seconds. If the machine still does not get the IP address, ask your network administrator.

NOTE

We recommend you to take a note of the IP address you confirmed here, because you need it for "Using the Remote UI" in the Reference Guide.

- 6 Press [Stop/Reset] to return to the standby mode.

If they are not displayed, that indicates that the machine is not communicated with the network. Please check the setting of the IP address.

Manual Setting

This is the setting for the Static IP. If the machine gets IP address automatically in "Automatic Setting", skip this setting.

In this setting, you enter the IP address, subnet mask, gateway address manually. [Additional Functions] → <12 SYSTEM SETTINGS> → <2 NETWORK SETTINGS> → <1 TCP/IP SETTINGS> → <1 IP ADDRESS AUTO> → <OFF> → <2 IP ADDRESS> → Enter the IP address → <1 TCP/IP SETTINGS> → <3 SUBNET MASK> → Enter the subnet mask → <1 TCP/IP SETTINGS> → <4 GATEWAY ADDRESS> → Enter the gateway address number → Press [Stop/Reset] → Turn off the main power → Restart the machine. For details on this setting, see Chapter 6, "Network," in the Reference Guide. Once you complete the setting, please proceed to "Checking the IP Address Setting," on p. 21.

Before Installation

- For Windows 2000/XP/Server 2003/Vista, logon as Administrator to install the software.
- On the screen shown at each step, click on the circled button to proceed.
- Make sure the machine is turned on.
(See “Connect the Power Cord and Turn On the Machine,” on p. 10.)
- Make sure the network cable is connected to the machine.
(See “Connect the Machine to a Network,” on p. 21.)
- Make sure an IP address is assigned to the machine.
(See “Checking the IP Address Setting,” on p. 21.)

Installation Procedure

1

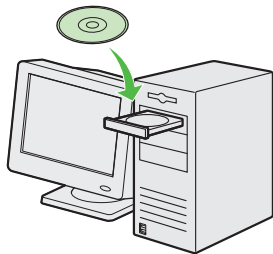

2

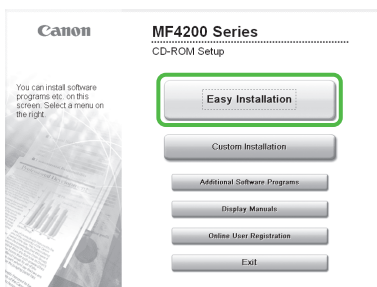

If the MF4200 Series CD-ROM Setup screen is not displayed, click [start] on the Windows task bar → [My Computer].

Windows Vista: click [start] on the Windows task bar → [Computer].

Windows 2000: double-click [My Computer] on the Windows desktop.

Open the CD-ROM icon, then double-click [MInst] ([MInst.exe]).

3

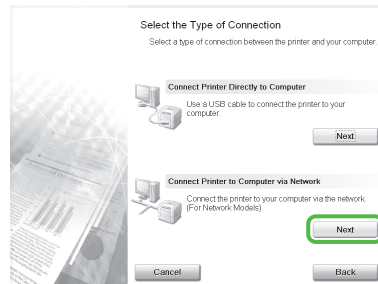

While installing the software on a computer running Windows Server 2003, the display in this step does not appear.

4

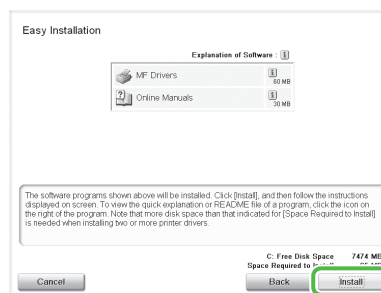

5

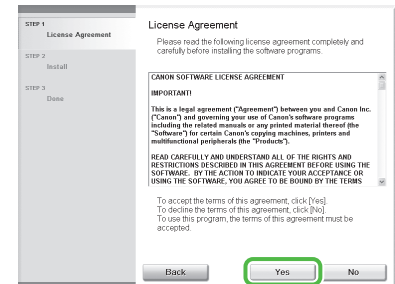

6

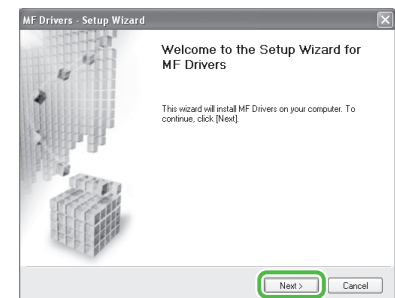

NOTE

If the firewall is applied to the operating system, the dialog box below appears. Click [Yes] and continue the installation.

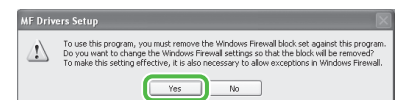

7

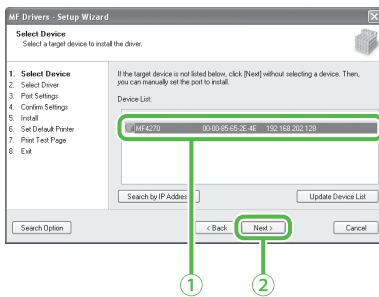

- ① Select your machine on the list. Make sure that the machine name is highlighted.
- ② Click [Next>].

8

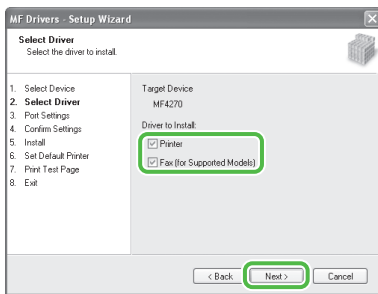

Select [Printer] and [FAX (for Supported Models)].

9

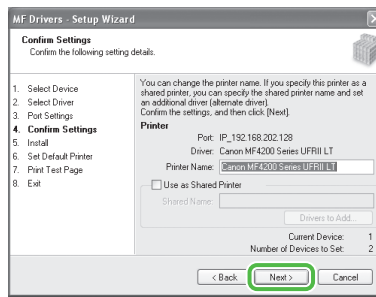

NOTE

When you share the printer with Windows 2000/XP/Server 2003/Vista, select [Use as Shared Printer]. If necessary, you can change the name of shared printer. If you want to set the operating system on which driver will run, click [Driver to add] to install an alternate driver so that a client PC can install the driver via a network.

10

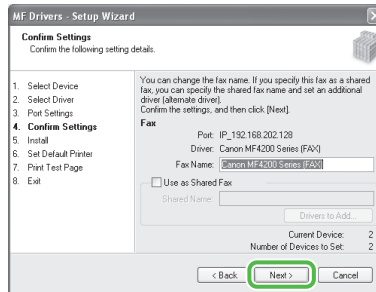

11

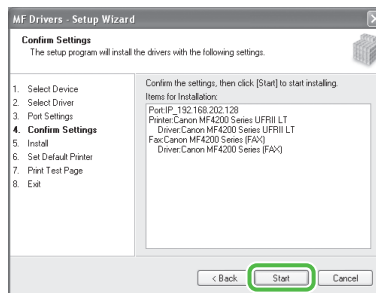

12

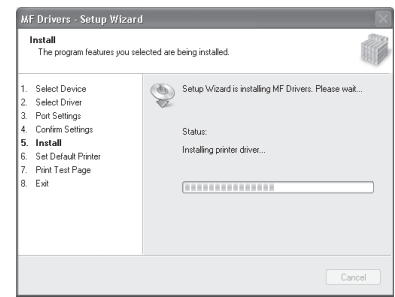

13

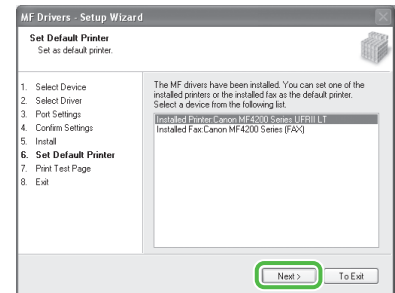

14

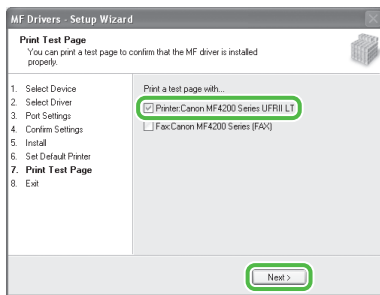

A printer test page is printed out from the machine.

NOTE

If you select the [Fax:Canon MF4200 Series (FAX)], [Fax Sending Settings] screen appears. Specify the necessary information such as name, telephone number, etc then send the test page. If you want to cancel the operation, press [Cancel] on this screen.

15



16

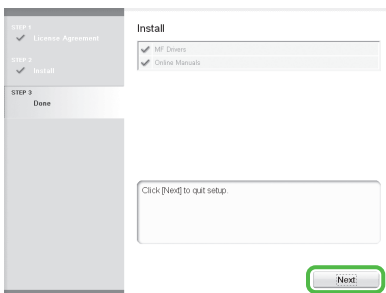

17

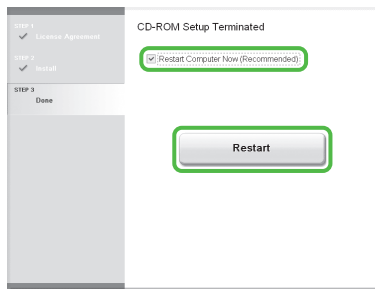

18

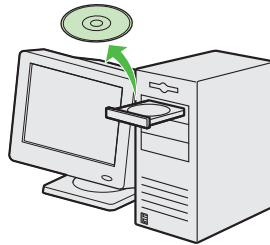

You have now completed installation.

NOTE

If you have several computers that you want to connect to the machine through a network, repeat the procedure from step 1 for each computer.

Checking the Installation

Check if the driver is installed successfully and if this machine has been set as default printer.



NOTE

If the name of your machine is selected on the [printer] screen from an application, it is set as default printer.

1 Open the [Printers and Faxes] folder (Windows 2000: the [Printers] dialog box).

Windows XP/Server2003: Click [start] on the Windows task bar → select [Printers and Faxes].

Windows Vista: Click [start] on the Windows task bar → select [Control Panel] → [Hardware and Sound] → double-click [Printer].

Windows 2000: [Start] → [Settings] → [Control Panel] → double-click [Printers].

Make sure the corresponding printer driver icon is displayed.

2 Set as default printer.

Click the printer icon of this machine. Click [Set as Default Printer] from the [File] menu.

USB Connection

Before Installation

- Do not connect the USB cable before installing the software. If you connect the USB cable before installing the software and the Found New Hardware Wizard screen appears, click [Cancel].
- For Windows 2000/XP/Server 2003/Vista, logon as Administrator to install the software.
- Make sure the machine is turned on before connecting the USB cable.
- On the screen shown at each step, click on the circled button to proceed.
- The machine does not come with a USB cable.

Installation Procedure

1

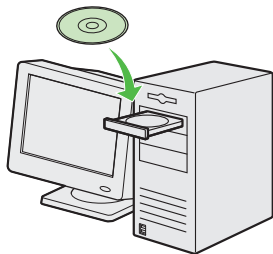

2



If the MF4200 Series CD-ROM Setup screen is not displayed, click [start] on the Windows task bar → [My Computer].

Windows Vista: click [start] on the Windows task bar → [Computer].

Windows 2000: double-click [My Computer] on the Windows desktop.

Open the CD-ROM icon, then double-click [MInst] ([MInst.exe]).

3

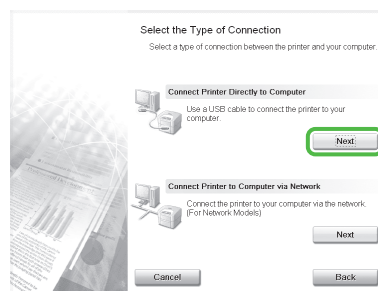

4

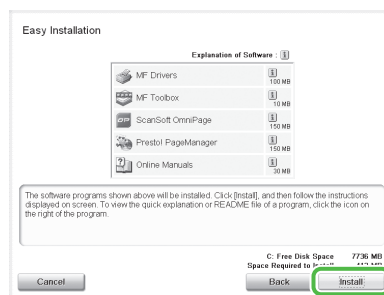

NOTE

If the disk space is insufficient to install the software, an error message is displayed. Free the disk space, and then try again.

5

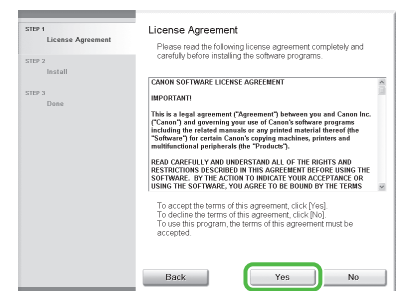

6

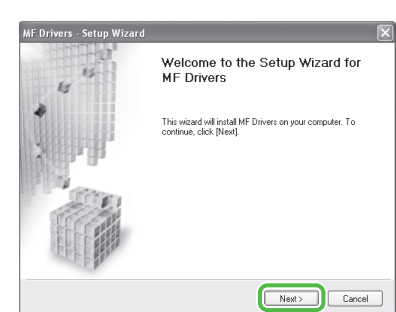

Software Settings with Computer

7



8

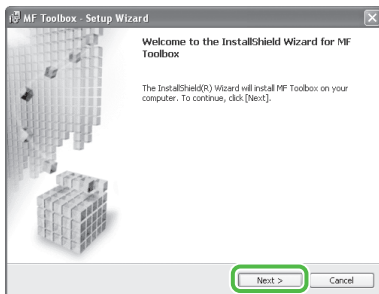

9

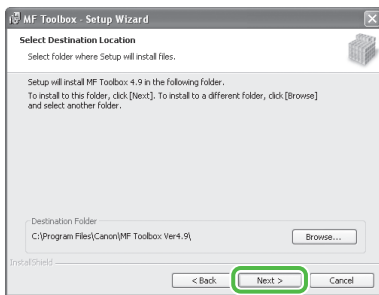

10

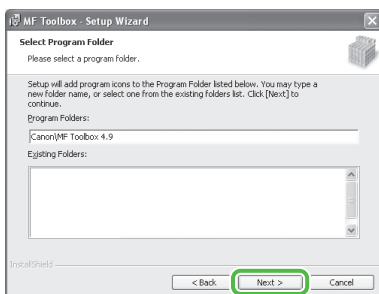

11

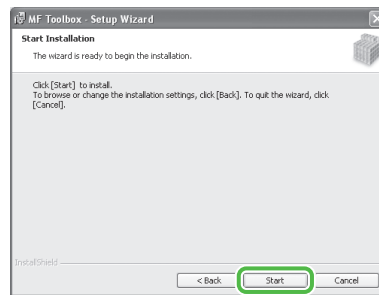

12

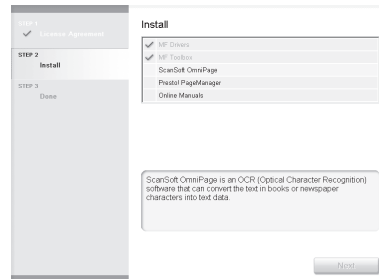
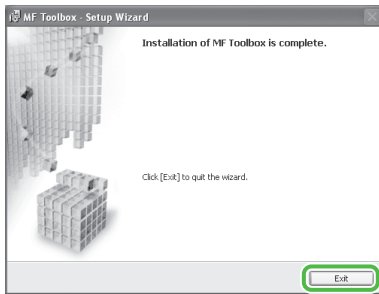

When you install Presto! PageManager and ScanSoft OmniPage, follow the on-screen instructions.

13

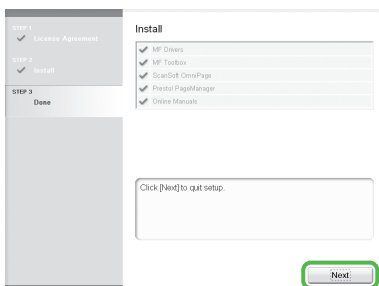

14

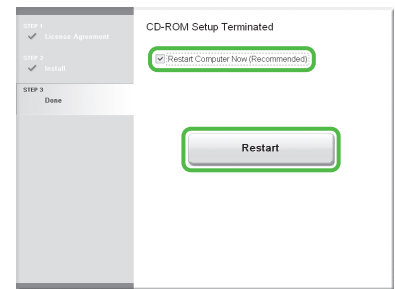

After checking [Restart Computer Now (recommended)] button, you can restart your computer by clicking the [Restart] button.

15

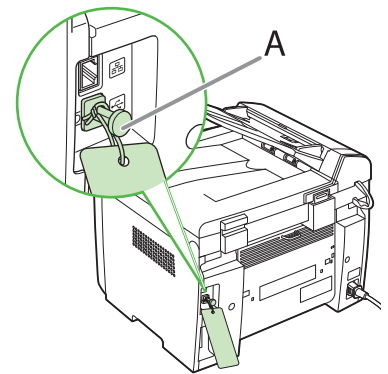

Remove the attachment (A) which covers on the USB port on the back of the machine.

16

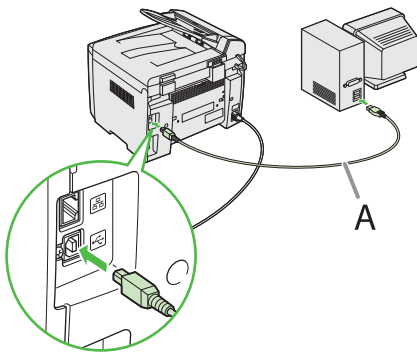

After restarting your computer, connect the machine and your computer with a USB cable (A).

 **NOTE**

Depending on the operation system you use, the dialog box to inform you that new hardware is detected may appear. Follow the on-screen instruction to complete the installation.

17

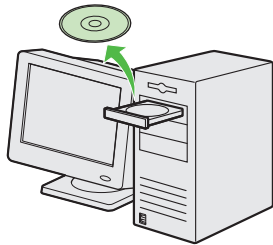

You have now completed installation.

Checking the Installation

Check if the driver is installed successfully and if this machine has been set as default printer.



NOTE

If the name of your machine is selected on the [printer] screen from an application, it is set as default printer.

- 1** Open the [Printers and Faxes] folder (Windows 2000: the [Printers] dialog box).
Windows XP/Server2003: Click [start] on the Windows task bar → select [Printers and Faxes].
Windows Vista: Click [start] on the Windows task bar → select [Control Panel] → [Hardware and Sound] → double-click [Printer].
Windows 2000: [Start] → [Settings] → [Control Panel] → double-click [Printers].

Make sure the corresponding printer driver icon is displayed.
- 2** Set as default printer.
Click the printer icon of this machine. Click [Set as Default Printer] from the [File] menu.
- 3** Open the [Scanners and Cameras] folder (Windows 2000: the [Scanners and Cameras Properties] dialog box).
Windows XP/Server2003: Click [start] on the Windows task bar → select [Control Panel] → [Printers and Other Hardware] → [Scanners and Cameras].
Windows Vista: Click [start] on the Windows task bar → select [Control Panel] → [Hardware and Sound] → double-click [Scanners and Cameras].
Windows 2000: [Start] → [Settings] → [Control Panel] → double-click [Scanners and Cameras].

Make sure the corresponding scanner driver icon is displayed.
- 4** Check if there is the [Canon MF Toolbox 4.9] icon on the Windows desktop.
If the [Canon MF Toolbox 4.9] icon is displayed on the Windows desktop, installation of the MF Toolbox 4.9 has been successful.

Uninstallation Procedure

Before uninstallation, make sure of the following:

- You have the installation software available for installation.
- No application is running on your computer.

NOTE

- For uninstallation in Windows 2000/XP/Server 2003/Vista, you must be the user with administrative privileges.
- For uninstallation, first uninstall the MF Toolbox, and then the MF drivers.
- If you want to remove the manuals installed from [Easy Installation], you can manually uninstall them by selecting the [Additional Software Programs] on the MF4200 Series CD-ROM Setup screen and click the [Uninstall] button for Manual Uninstaller.

Uninstalling the MF Toolbox (USB Connection only)

- 1** Click [start] on the Windows task bar → [(All) Programs] → [Canon] → [MF Toolbox 4.9] → [Toolbox Uninstall].
- 2** Follow the on-screen instructions.
When the Repair or Remove program selection screen is displayed, check [Remove], then click [Next >].
If asked to confirm removal of an application etc., click [Remove].
Restart your computer if asked to do so.
- 3** Click [Exit].

Uninstalling the MF Drivers

- 1** Click [start] on the Windows task bar → [(All) Programs] → [Canon] → [MF4200 Series] → [Uninstall Drivers].
The [MF Drivers Uninstaller] dialog box appears.
- 2** Click [Delete].



- 3** Click [Yes].
Uninstallation proceeds automatically and next dialog box appears.

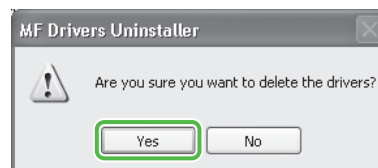

- 4** Click [Exit].



NOTE

Restart your computer if asked to do so.

Using Online Help

The user software CD includes programs (driver software and application software) which the supplied instruction guides do not cover. When you utilize such programs, refer to online help and context sensitive help following the instructions below.

You can locate additional help in the online help file provided with the driver software. In the [Properties] dialog box, you can click [Help] to display information about every feature and option in the drivers.

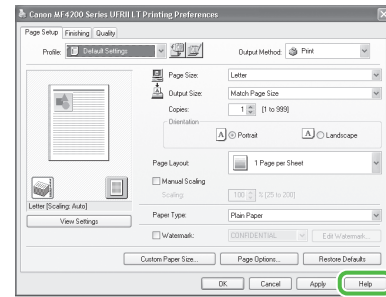

In the help dialog box, you can click [Contents], then double-click your desired title to display information.

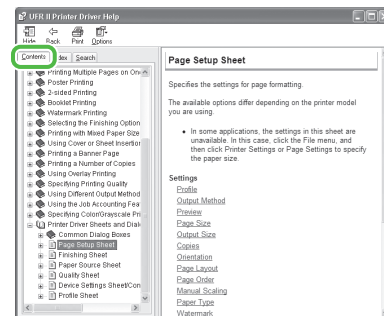

In the help dialog box, you can click [Index], then double-click your desired keyword in the list to display information. To search the desired keyword quickly, enter a keyword in the upper text box. The nearest keyword is located in the list below.

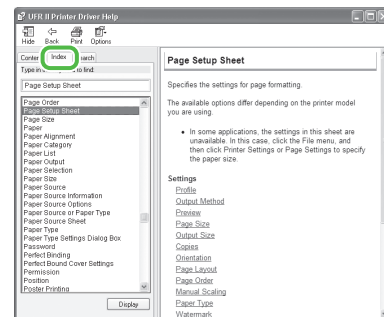

Contacting Service Center

When you have a problem with your machine and you cannot solve it even if you refer to the manuals or online help, please contact our Canon Authorized Service Facilities or the Canon Customer Care Center at 1-800-828-4040 between the hours of 9:00 A.M. to 8:00 P.M. EST Monday through Friday and 10:00 A.M. to 8:00 P.M. on Saturday.

Canadian customer support is available on-line at www.canon.ca or by calling 1-800-652-2666 Monday through Friday from 9:00 A.M. to 8:00 P.M. EST.

Trademarks

Canon, the Canon logo, imageCLASS, and NetSpot are trademarks of Canon Inc. Microsoft, Windows, Windows Server, and Windows Vista are trademarks or registered trademarks of Microsoft Corporation in the U.S. and/or other countries.

All other product and brand names are registered trademarks, trademarks or service marks of their respective owners.

Copyright

Copyright © 2007 by Canon Inc. All rights reserved. No part of this publication may be reproduced, transmitted, transcribed, stored in a retrieval system, or translated into any language or computer language in any form or by any means, electronic, mechanical, magnetic, optical, chemical, manual, or otherwise, without the prior written permission of Canon Inc.

Disclaimers

The information in this document is subject to change without notice.

CANON INC. MAKES NO WARRANTY OF ANY KIND WITH REGARD TO THIS MATERIAL, EITHER EXPRESS OR IMPLIED, EXCEPT AS PROVIDED HEREIN, INCLUDING WITHOUT LIMITATION, THEREOF, WARRANTIES AS TO MARKETABILITY, MERCHANTABILITY, FITNESS FOR A PARTICULAR PURPOSE OF USE OR NON-INFRINGEMENT. CANON INC. SHALL NOT BE LIABLE FOR ANY DIRECT, INCIDENTAL, OR CONSEQUENTIAL DAMAGES OF ANY NATURE, OR LOSSES OR EXPENSES RESULTING FROM THE USE OF THIS MATERIAL.



CANON INC.

30-2, Shimomaruko 3-chome, Ohta-ku, Tokyo 146-8501, Japan

CANON U.S.A., INC.

One Canon Plaza, Lake Success, NY 11042, U.S.A.

CANON CANADA INC.

6390 Dixie Road Mississauga, Ontario L5T 1P7, Canada

CANON EUROPA N.V.

Bovenkerkerweg 59-61 1185 XB Amstelveen, The Netherlands

CANON FRANCE S.A.S.

17, quai du Président Paul Doumer 92414 Courbevoie Cedex, France

CANON COMMUNICATION & IMAGE FRANCE S.A.S.

12, rue de l'Industrie 92414 Courbevoie Cedex, France

CANON (U.K.) LTD.

Woodhatch, Reigate, Surrey, RH2 8BF, United Kingdom

CANON DEUTSCHLAND GmbH

Europark Fichtenhain A10, 47807 Krefeld, Germany

CANON ITALIA S.p.A.

Via Milano, 8 20097 San Donato Milanese (MI) Italy

CANON ESPAÑA, S.A.

c/ Joaquín Costa 41, 28002 Madrid, Spain

CANON LATIN AMERICA, INC.

703 Waterford Way Suite 400 Miami, Florida 33126 U.S.A.

CANON AUSTRALIA PTY. LTD.

1 Thomas Holt Drive, North Ryde, Sydney, N.S.W. 2113, Australia

CANON CHINA CO., LTD.

15F Jinbao Building No.89 Jinbao Street, Dongcheng District, Beijing 100005, China

CANON SINGAPORE PTE. LTD.

1 HarbourFront Avenue #04-01 Keppel Bay Tower, Singapore 098632

CANON HONGKONG CO., LTD.

19/F., The Metropolis Tower, 10 Metropolis Drive, Hunghom, Kowloon, Hong Kong

