

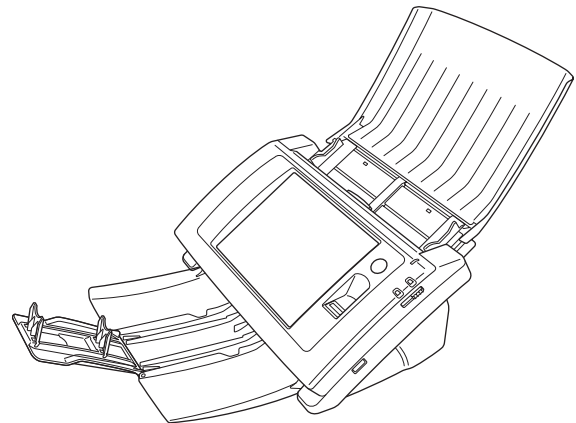

ScanFront 300/300P/330

INSTRUCTIONS

Please read this manual before using the scanner.
After you finish reading this manual, keep it in a safe place
for future reference.



International ENERGY STAR® Office Equipment Program

As an ENERGY STAR® Partner, Canon Electronics Inc. has determined that this machine meets the ENERGY STAR® Program guidelines for energy efficiency.



The International ENERGY STAR® Office Equipment Program is an international program that promotes energy saving through the use of computers and other office equipment.

The program backs the development and dissemination of products with functions that effectively reduce energy consumption. It is an open system in which business proprietors can participate voluntarily. The targeted products are office equipment, such as computers, monitors, printers, fax, machine, copiers, and scanners. The standards and logos are uniform among participating nations.

This model doesn't provide "setting options" for power management.

Under factory default settings, the scanner will enter Low Power mode after 12 minutes of inactivity. Although you can change the period of time before the scanner enters Low Power mode to up to 230 minutes, we recommend using the default setting.

FCC REGULATIONS (For 120 V model)

Network Scanner, Model M11-1041/M11-1051/M11-1053
This device complies with Part 15 of the FCC Rules.

Operation is subject to the following two conditions: (1) This device may not cause harmful interference, and (2) this device must accept any interference received, including interference that may cause undesired operation.

Note: This equipment has been tested and found to comply with the limits for a Class B digital device, pursuant to Part 15 of the FCC Rules. These limits are designed to provide reasonable protection against harmful interference in a residential installation. This equipment generates, uses, and can radiate radio frequency energy and, if not installed and used in accordance with the instructions, may cause harmful

interference to radio communications. However, there is no guarantee that interference will not occur in a particular installation. If this equipment does cause harmful interference to radio or television reception, which can be determined by turning the equipment off and on, the user is encouraged to try to correct the interference by one or more of the following measures:

- Reorient or relocate the receiving antenna.
- Increase the separation between the equipment and receiver.
- Connect the equipment into an outlet on a circuit different from that to which the receiver is connected.
- Consult the dealer or an experienced radio/TV technician for help.

Use of shielded cable is required to comply with class B limits in Subpart B of Part 15 of FCC Rules.

Do not make any changes or modifications to the equipment unless otherwise specified in the manual. If such changes or modifications should be made, you could be required to stop operation of the equipment.

Canon U.S.A. Inc.

One Canon Park, Melville, NY 11747, U.S.A.

Tel. No. (800)652-2666

RADIO INTERFERENCE REGULATIONS (For 120 V models)

This digital apparatus does not exceed the Class B limits for radio noise emissions from digital apparatus as set out in the Interference-causing equipment standard entitled "Digital Apparatus", ICES-003 of the Industry Canada.

RÈGLEMENT SUR LE BROUILLAGE RADIOÉLECTRIQUE (For 120 V models)

Cet appareil numérique respecte les limites de bruits radioélectriques applicables aux appareils numériques de Classe B prescrites dans la norme sur le matériel brouilleur: "Appareils Numériques", NMB-003 édictée par l'Industrie Canada.

For CA, USA Only

Included battery contains Perchlorate Material - special handling may apply.

See <http://www.dtsc.ca.gov/hazardouswaste/perchlorate/> for detail.

European Union (and EEA) only



This symbol indicates that this product is not to be disposed of with your household waste, according to the WEEE Directive (2002/96/EC) and your national law. This product should be handed over to a designated collection point, e.g., on an

authorized one-for-one basis when you buy a new similar product or to an authorized collection site for recycling waste electrical and electronic equipment (EEE). Improper handling of this type of waste could have a possible negative impact on the environment and human health due to potentially hazardous substances that are generally associated with EEE. At the same time, your cooperation in the correct disposal of this product will contribute to the effective usage of natural resources. For more information about where you can drop off your waste equipment for recycling, please contact your local city office, waste authority, approved WEEE scheme or your household waste disposal service. For more information regarding return and recycling of WEEE products, please visit www.canon-europe.com/environment. (EEA: Norway, Iceland and Liechtenstein)

Model Names

The following names may be provided for the safety regulations in each sales region of the Network Scanner.

ScanFront 300: Model M11-1041

ScanFront 300P: Model M11-1051

ScanFront 330: Model M11-1053

Trademarks

- Canon and the Canon logo are registered trademarks of Canon Inc. in the United States and may also be trademarks or registered trademarks in other countries.

- imageFORMULA is a trademark of Canon Electronics Inc.
- Microsoft, Windows, Internet Explorer, and Active Directory are registered trademarks or trademarks of Microsoft Corporation in the United States and other countries.
- Adobe, Acrobat, and Adobe Reader are registered trademarks or trademarks of Adobe Systems Incorporated in the United States and other countries.
- Other product and company names herein may be the trademarks of their respective owners.

Disclaimers

The information in this document is subject to change without notice.

CANON ELECTRONICS INC. MAKES NO WARRANTY OF ANY KIND WITH REGARD TO THIS MATERIAL, EITHER EXPRESS OR IMPLIED, EXCEPT AS PROVIDED HEREIN, INCLUDING WITHOUT LIMITATION, THEREOF, WARRANTIES AS TO MARKETABILITY, MERCHANTABILITY, FITNESS FOR A PARTICULAR PURPOSE OF USE OR NON-INFRINGEMENT. CANON ELECTRONICS INC. SHALL NOT BE LIABLE FOR ANY DIRECT, INCIDENTAL, OR CONSEQUENTIAL DAMAGES OF ANY NATURE, OR LOSSES OR EXPENSES RESULTING FROM THE USE OF THIS MATERIAL.

CANON ELECTRONICS INC. IS NOT LIABLE FOR THE STORAGE AND HANDLING OF DOCUMENTS SCANNED WITH THIS PRODUCT, OR THE STORAGE AND HANDLING OF RESULTING SCANNED IMAGE DATA.

IF YOU INTEND TO DISCARD THE ORIGINALS OF SCANNED DOCUMENTS, YOU THE CUSTOMER ARE RESPONSIBLE FOR INSPECTING THE SCANNED IMAGES AND VERIFYING THAT DATA IS INTACT. THE MAXIMUM LIABILITY OF CANON ELECTRONICS INC. UNDER THIS WARRANTY IS LIMITED TO THE PURCHASE PRICE OF THE PRODUCT COVERED BY THE WARRANTY.

Copyright

libtiff

Copyright (c) 1988-1996 Sam Leffler

Copyright (c) 1991-1996 Silicon Graphics, Inc.

Permission to use, copy, modify, distribute, and sell this software and its documentation for any purpose is hereby granted without fee, provided that (i) the above copyright notices and this permission notice appear in all copies of the software and related documentation, and (ii) the names of Sam Leffler and Silicon Graphics may not be used in any advertising or publicity relating to the software without the specific, prior written permission of Sam Leffler and Silicon Graphics.

THE SOFTWARE IS PROVIDED "AS-IS" AND WITHOUT WARRANTY OF ANY KIND, EXPRESS, IMPLIED OR OTHERWISE, INCLUDING WITHOUT LIMITATION, ANY WARRANTY OF MERCHANTABILITY OR FITNESS FOR A PARTICULAR PURPOSE.

IN NO EVENT SHALL SAM LEFFLER OR SILICON GRAPHICS BE LIABLE FOR ANY SPECIAL, INCIDENTAL, INDIRECT OR CONSEQUENTIAL DAMAGES OF ANY KIND, OR ANY DAMAGES WHATSOEVER RESULTING FROM LOSS OF USE, DATA OR PROFITS, WHETHER OR NOT ADVISED OF THE POSSIBILITY OF DAMAGE, AND ON ANY THEORY OF LIABILITY, ARISING OUT OF OR IN CONNECTION WITH THE USE OR PERFORMANCE OF THIS SOFTWARE.

libjpeg

Portions of this software are based in part on the work of the Independent JPEG Group.

MD5

derived from the RSA Data Security, Inc. MD5 Message-Digest Algorithm

Copyright (c) 1998 - 2002, Paul Johnston & Contributors
All rights reserved.

Redistribution and use in source and binary forms, with or without modification, are permitted provided that the following conditions are met:

Redistributions of source code must retain the above copyright notice, this list of conditions and the following disclaimer. Redistributions in binary form must reproduce the above copyright notice, this list of conditions and the following disclaimer in the documentation and/or other materials provided with the distribution.

Neither the name of the author nor the names of its contributors may be used to endorse or promote products derived from this software without specific prior written permission.

THIS SOFTWARE IS PROVIDED BY THE COPYRIGHT HOLDERS AND CONTRIBUTORS "AS IS" AND ANY EXPRESS OR IMPLIED WARRANTIES, INCLUDING, BUT NOT LIMITED TO, THE IMPLIED WARRANTIES OF MERCHANTABILITY AND FITNESS FOR A PARTICULAR PURPOSE ARE DISCLAIMED. IN NO EVENT SHALL THE COPYRIGHT OWNER OR CONTRIBUTORS BE LIABLE FOR ANY DIRECT, INDIRECT, INCIDENTAL, SPECIAL, EXEMPLARY, OR CONSEQUENTIAL DAMAGES (INCLUDING, BUT NOT LIMITED TO, PROCUREMENT OF SUBSTITUTE GOODS OR SERVICES; LOSS OF USE, DATA, OR PROFITS; OR BUSINESS INTERRUPTION) HOWEVER CAUSED AND ON ANY THEORY OF LIABILITY, WHETHER IN CONTRACT, STRICT LIABILITY, OR TORT (INCLUDING NEGLIGENCE OR OTHERWISE) ARISING IN ANY WAY OUT OF THE USE OF THIS SOFTWARE, EVEN IF ADVISED OF THE POSSIBILITY OF SUCH DAMAGE.

Copyright (c) 1991-2, RSA Data Security, Inc. Created 1991. All rights reserved.

License to copy and use this software is granted provided that it is identified as the "RSA Data Security, Inc. MD5 Message-Digest Algorithm" in all material mentioning or referencing this software or this function.

License is also granted to make and use derivative works provided that such works are identified as "derived from the RSA Data Security, Inc. MD5 Message-Digest Algorithm" in all material mentioning or referencing the derived work.

RSA Data Security, Inc. makes no representations concerning either the merchantability of this software or the suitability of this software for any particular purpose. It is provided "as is" without express or implied warranty of any kind.

These notices must be retained in any copies of any part of this documentation and/or software.

Windows CE 6.0

Depending upon which components you are running, your product may contain the following third party technologies: Portions of this software are based on NCSA Mosaic. NCSA Mosaic was developed by the National Center for Supercomputing Applications at the University of Illinois at Urbana-Champaign. Distributed under a licensing agreement with Spyglass, Inc.

Contains security software licensed from RSA Data Security, Inc.

Portions of IPSec and related services jointly developed by Microsoft Corporation and Cisco Systems, Inc.

The names of actual companies and products mentioned herein may be the trademarks of their respective owners.

(Hg) LAMP(S) INSIDE THIS PRODUCT CONTAIN MERCURY AND MUST BE RECYCLED OR DISPOSED OF ACCORDING TO LOCAL, STATE OR FEDERAL LAWS.

Opera® or Opera Software™ are registered trademarks of Opera Software ASA in Norway or other countries.



OPERA SOFTWARE ASA'S AND THIRD PARTY SUPPLIER'S COPYRIGHT NOTICE AND ACKNOWLEDGEMENTS

I. Opera Software ASAs browser/browser engine Opera®Browser from Opera Software ASA. Copyright 1995-2008 Opera Software ASA. All rights reserved.

This software is being provided on an « as is », basis. Opera and its suppliers disclaim all warranties regarding the software, either express or implied, statutory or otherwise, including without limitation warranties of functionality, fitness for a particular purpose or non-infringement.

II. The required acknowledgements for third party components included in the OperaRBrowser engine are as follows:

1. David Gay's binary/decimal conversion code (dtoa and strtod)

"The author of this software is David M. Gay.

Copyright (c) 1991, 2000, 2001 by Lucent Technologies.

Permission to use, copy, modify, and distribute this software for any purpose without fee is hereby granted, provided that this entire notice is included in all copies of any software which is or includes a copy or modification of this software and in all copies of the supporting documentation for such software.

THIS SOFTWARE IS BEING PROVIDED "AS IS", WITHOUT ANY EXPRESS OR IMPLIED WARRANTY. IN PARTICULAR, NEITHER THE AUTHOR NOR LUCENT MAKES ANY

REPRESENTATION OR WARRANTY OF ANY KIND CONCERNING THE MERCHANTABILITY OF THIS SOFTWARE OR ITS FITNESS FOR ANY PARTICULAR PURPOSE.

2. OpenSSL 0.9.8e (formerly SSLeay)

The OpenSSL toolkit stays under a dual license, i.e. both the conditions of the OpenSSL License and the original SSLeay license apply to the toolkit. See below for the actual license texts. Actually both licenses are BSD-style Open Source licenses. In case of any license issues related to OpenSSL please contact openssl-core@openssl.org.

OpenSSL License

Copyright (c) 1998-2008 The OpenSSL Project. All rights reserved.

Redistribution and use in source and binary forms, with or without modification, are permitted provided that the following conditions are met:

1. Redistributions of source code must retain the above copyright notice, this list of conditions and the following disclaimer.
2. Redistributions in binary form must reproduce the above copyright notice, this list of conditions and the following disclaimer in the documentation and/or other materials provided with the distribution.
3. All advertising materials mentioning features or use of this software must display the following acknowledgment:
"This product includes software developed by the OpenSSL Project for use in the OpenSSL Toolkit.
(<http://www.openssl.org/>)"
4. The names "OpenSSL Toolkit" and "OpenSSL Project" must not be used to endorse or promote products derived

from this software without prior written permission. For written permission, please contact openssl-core@openssl.org.

5. Products derived from this software may not be called "OpenSSL" nor may "OpenSSL" appear in their names without prior written permission of the OpenSSL Project.
6. Redistributions of any form whatsoever must retain the following acknowledgment:
"This product includes software developed by the OpenSSL Project for use in the OpenSSL Toolkit
(<http://www.openssl.org/>)"

THIS SOFTWARE IS PROVIDED BY THE OpenSSL PROJECT ``AS IS" AND ANY EXPRESSED OR IMPLIED WARRANTIES, INCLUDING, BUT NOT LIMITED TO, THE IMPLIED WARRANTIES OF MERCHANTABILITY AND FITNESS FOR A PARTICULAR PURPOSE ARE DISCLAIMED. IN NO EVENT SHALL THE OpenSSL PROJECT OR ITS CONTRIBUTORS BE LIABLE FOR ANY DIRECT, INDIRECT, INCIDENTAL, SPECIAL, EXEMPLARY, OR CONSEQUENTIAL DAMAGES (INCLUDING, BUT NOT LIMITED TO, PROCUREMENT OF SUBSTITUTE GOODS OR SERVICES; LOSS OF USE, DATA, OR PROFITS; OR BUSINESS INTERRUPTION) HOWEVER CAUSED AND ON ANY THEORY OF LIABILITY, WHETHER IN CONTRACT, STRICT LIABILITY, OR TORT (INCLUDING NEGLIGENCE OR OTHERWISE) ARISING IN ANY WAY OUT OF THE USE OF THIS SOFTWARE, EVEN IF ADVISED OF THE POSSIBILITY OF SUCH DAMAGE.

This product includes cryptographic software written by Eric Young (ey@cryptsoft.com). This product includes software written by Tim Hudson (tjh@cryptsoft.com).

Original SSLeay License

Copyright (C) 1995-1998 Eric Young (eay@cryptsoft.com)
All rights reserved.

This package is an SSL implementation written by Eric Young (eay@cryptsoft.com).

The implementation was written so as to conform with Netscapes SSL.

This library is free for commercial and non-commercial use as long as the following conditions are adhered to. The following conditions apply to all code found in this distribution, be it the RC4, RSA, lhash, DES, etc., code; not just the SSL code. The SSL documentation included with this distribution is covered by the same copyright terms except that the holder is Tim Hudson (tjh@cryptsoft.com).

Copyright remains Eric Young's, and as such any Copyright notices in the code are not to be removed.
If this package is used in a product, Eric Young should be given attribution as the author of the parts of the library used. This can be in the form of a textual message at program startup or in documentation (online or textual) provided with the package.

Redistribution and use in source and binary forms, with or without modification, are permitted provided that the following conditions are met:

1. Redistributions of source code must retain the copyright notice, this list of conditions and the following disclaimer.
2. Redistributions in binary form must reproduce the above copyright notice, this list of conditions and the following disclaimer in the documentation and/or other materials provided with the distribution.
3. All advertising materials mentioning features or use of this software must display the following acknowledgement:

"This product includes cryptographic software written by Eric Young (eay@cryptsoft.com)"

The word 'cryptographic' can be left out if the routines [sic] from the library being used are not cryptographic related :-).

4. If you include any Windows specific code (or a derivative thereof) from the apps directory (application code) you must include an acknowledgement:

"This product includes software written by Tim Hudson (tjh@cryptsoft.com)"

THIS SOFTWARE IS PROVIDED BY ERIC YOUNG ``AS IS'' AND ANY EXPRESS OR IMPLIED WARRANTIES, INCLUDING, BUT NOT LIMITED TO, THE IMPLIED WARRANTIES OF MERCHANTABILITY AND FITNESS FOR A PARTICULAR PURPOSE ARE DISCLAIMED. IN NO EVENT SHALL THE AUTHOR OR CONTRIBUTORS BE LIABLE FOR ANY DIRECT, INDIRECT, INCIDENTAL, SPECIAL, EXEMPLARY, OR CONSEQUENTIAL DAMAGES (INCLUDING, BUT NOT LIMITED TO, PROCUREMENT OF SUBSTITUTE GOODS OR SERVICES; LOSS OF USE, DATA, OR PROFITS; OR BUSINESS INTERRUPTION) HOWEVER CAUSED AND ON ANY THEORY OF LIABILITY, WHETHER IN CONTRACT, STRICT LIABILITY, OR TORT (INCLUDING NEGLIGENCE OR OTHERWISE) ARISING IN ANY WAY OUT OF THE USE OF THIS SOFTWARE, EVEN IF ADVISED OF THE POSSIBILITY OF SUCH DAMAGE.

The licence and distribution terms for any publically available version or derivative of this code cannot be changed. i.e. this code cannot simply be copied and put under another distribution licence [including the GNU Public Licence.]

Copyright 2013 by CANON ELECTRONICS INC. All rights reserved.

No part of this publication may be reproduced or transmitted in any form or by any means, electronic or mechanical, including photocopying and recording, or by any information storage or retrieval system without the prior written permission of CANON ELECTRONICS INC.

Introduction

Thank you for purchasing the Canon imageFORMULA ScanFront 300/300P/330 network scanner.

Please read this manual thoroughly before using the scanner to familiarize yourself with its capabilities, and to make the most of its many functions. After reading this manual, store it in a safe place for future reference.

About ScanFront 300/300P/330

The ScanFront 300/300P/330 is a network scanner that you can use without connecting to a computer.

You can transfer the data of an image scanned with the ScanFront 300/300P/330 to a shared folder on a server PC or client PC on the network or to an FTP server*, send it to a printer for printing**, or deliver it to a remote location via e-mail or Internet fax service. When using the scanner without a network environment, you can also save the image files to USB memory.

* To send image files to a shared folder on a computer on a different segment of the network, the supplied ScanFront Service software must be installed on a computer on the network.

** To send image files to a printer, the supplied ScanFront Service software must be installed on a computer on the network.

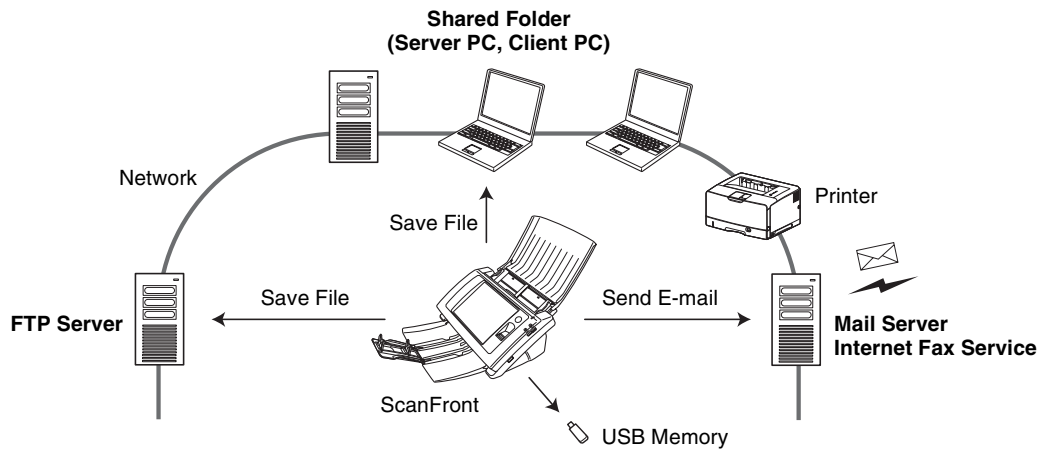

Conceptual Diagram of the ScanFront

About ScanFront 330 Web Application Mode

The ScanFront 330 is equipped with not only an operation mode called Standard Mode that allows you to scan without connecting to a computer just like with the ScanFront 300P but also an operation mode called Web Application Mode, and you can use the scanner in either of these modes.*

With Web Application Mode, the Web application for operating the ScanFront is installed on the server**, and you can access the Web application on the server and operate the ScanFront from the browser installed on the ScanFront.

By revising the Web application, the developer can customize ScanFront operation to match your operating conditions.

If you intend to use Web Application Mode, contact your dealer.

* The ScanFront 330 is set to Standard Mode in the initial state at the time of purchase.

** To use Web Application Mode, you need to provide a separate server on which to run the Web application.

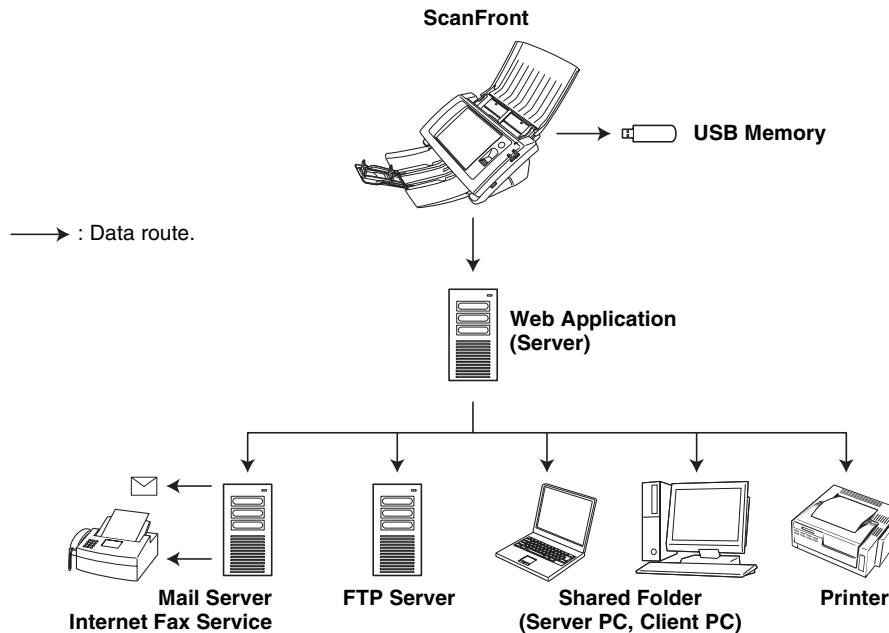

Conceptual Diagram of Web Application Mode

❑ Manuals for the Scanner

The following manuals are provided with the Canon ScanFront 300/300P/330. Be sure to read these manuals thoroughly before using the scanner.

Setup and Operation Guide*

Setup Guide

Describes the procedure for setting up the scanner for scanning. Set up the ScanFront in accordance with the Setup Guide. For details on the ScanFront, refer to the *Operation Guide* and *ScanFront 300/300P/330 INSTRUCTIONS* (electronic manuals).

Operation Guide

Provides an overview of the functions of the scanner, and describes the basic operations for using the ScanFront. For details on the settings of the ScanFront, refer to the *ScanFront 300/300P/330 INSTRUCTIONS* (electronic manual).

* The printed version of Setup and Operation Guide may vary depending on your region. PDF files of the Setup and Operation Guide in other languages can be found on the application disc.

INSTRUCTIONS (Electronic Manual): This Manual

Describes how to use the scanner, and includes instructions for configuring the scanner settings, as well as handling, maintenance, and troubleshooting information. This manual is stored as a PDF file on the supplied application disc and requires Adobe Reader to open. (You can download Adobe Reader from the Adobe Web site.)

❑ Symbols Used in This Manual

The following symbols are used in this manual to explain procedures, restrictions, handling precautions, and instructions that should be observed for safety.

WARNING

Indicates a warning concerning operations that may lead to death or injury to persons if not performed correctly. To use the scanner safely, always pay attention to these warnings.

CAUTION

Indicates a caution concerning operations that may lead to injury to persons, or damage to property if not performed correctly. To use the scanner safely, always pay attention to these cautions.

IMPORTANT

Indicates operational requirements and restrictions. Be sure to read these items carefully to operate the scanner correctly, and avoid damage to the scanner.

Hint

Indicates a clarification of an operation, or contains additional explanations for a procedure. Reading these notes is highly recommended.

❑ How This Manual is Organized

This manual consists of the following chapters.

Chapter 1 Before Use

This chapter provides an overview of the ScanFront.

Chapter 2 Handling

This chapter describes the types of documents that can be scanned, and the basic operations of the scanner.

Chapter 3 ScanFront Setup

This chapter describes the setup procedures and Administrator Settings of the scanner.

Chapter 4 ScanFront Service

This chapter describes the how to use and configure ScanFront Service.

Chapter 5 Operating Procedures

This chapter describes the basic operating procedures for the scanner.

Chapter 6 Web Menu (Administrator Mode)

This chapter describes the Web menu for the administrator to configure settings.

Chapter 7 ScanFront Administration Tool

This chapter describes how to install and use ScanFront Administration Tool.

Chapter 8 Web Menu (User Mode)

This chapter describes the Web menu for the user to configure settings.

Chapter 9 Maintenance

This chapter describes how to clean the scanner and replace the consumable parts such as rollers.

Chapter 10 Troubleshooting

This chapter describes how to respond when problems occur or warning messages appear.

Chapter 11 Appendices

This chapter describes the scanner specifications.

□ Table of Contents

Introduction.....	i
Manuals for the Scanner	iii
Symbols Used in This Manual.....	iii
How This Manual is Organized.....	iv

Chapter 1 Before Use

1. Important Safety Instructions.....	1-2
Installation Location.....	1-2
Power	1-2
Moving the Scanner.....	1-3
Handling	1-3
About the Fingerprint Sensor (ScanFront 300P only).....	1-5
Disposal.....	1-5
2. Features of the ScanFront 300/300P/330	1-6
ScanFront 300/300P/330.....	1-6
ScanFront 300P/330.....	1-7
ScanFront 300P.....	1-8
ScanFront 330	1-8
3. Names and Functions of Parts	1-9
Front and Document Feed and Eject Trays.....	1-9
Side and Rear.....	1-10
4. Network Environment	1-11
Network Environment	1-11
Directory Service Support.....	1-11
Limitations	1-12

Chapter 2 Handling

1. Documents	2-2
Plain Paper.....	2-2
Business Card	2-2
Card.....	2-3
2. Preparing the Scanner	2-4
Preparing the Document Feed Tray and Eject Tray	2-4
Feed Selection Lever.....	2-5
USB Port.....	2-5

3. Placing Documents	2-6
Placing a Document	2-6
Placing a Folded Document	2-7
Placing a Long Document	2-7
Placing a Card.....	2-8
4. Clearing a Paper Jam or Double Feed Error....	2-9
5. Fingerprint Sensor (ScanFront 300P)	2-11
Cautions for Handling the Fingerprint Sensor	2-11
Fingerprint Authentication.....	2-12

Chapter 3 ScanFront Setup

1. Before Setting Up the Scanner	3-2
Installation Location.....	3-2
Connecting the AC Adapter.....	3-3
Connecting the Network Cable.....	3-3
2. Turning the Power ON and OFF	3-4
Turning the Power ON.....	3-4
Turning the Power OFF.....	3-4
3. Configuring the Scanner Settings	3-5
Administrator Settings	3-5
Web Menu (Administrator Mode).....	3-6
4. Configuring Administrator Settings.....	3-8
Logging In to the Administrator Settings.....	3-8
Network Settings	3-9
Administrator Password.....	3-9
Backup/Restore Setting Information.....	3-10
Select Login Type.....	3-10
Roller Counter Reset.....	3-11
Format ScanFront.....	3-11
Touch Panel Adjustment	3-11
Display Language Setting.....	3-12
Network Test	3-12
Switch to Web Application Mode (from Standard Mode of ScanFront 330 Only) ...	3-12

Chapter 4 ScanFront Service

1. About ScanFront Service	4-2
2. Installing ScanFront Service	4-3
System Requirements	4-3
Installation	4-3

3. ScanFront Service Setup	4-6
ScanFront Settings.....	4-6
Changing the Port Number Used for Communication.....	4-6

Chapter 5 Operating Procedures

1. Flow of Scanner Operations	5-2
2. Turning the Power ON and OFF	5-3
Turning the Power ON.....	5-3
Turning the Power OFF.....	5-3
3. Login Screen	5-4
Login Screen Types.....	5-4
When Using Server Authentication.....	5-4
List Type Login.....	5-5
Key in Type Login.....	5-6
Fingerprint Authentication (Only Available with the ScanFront 300P)	5-7
4. Screen Displayed after Login	5-8
Home Screen.....	5-8
Job Button Screen.....	5-8
5. User Settings Screen	5-9
Change Password	5-9
Fingerprint Registration	5-9
6. Fingerprint Registration (Only Available with the ScanFront 300P)	5-10
Fingerprint Authentication.....	5-10
Registering a Fingerprint	5-11
7. Scanning Procedures	5-13
Scanning From the Home Screen	5-13
Scanning From the Job Button Screen.....	5-14
Address Selection Screen	5-15
USB Memory Screen.....	5-17
Print Settings Screen.....	5-18
Scanning.....	5-19
8. Registering and Editing Addresses	5-23
Registering a New Address.....	5-23
Modifying an Address.....	5-25
Copying an Address	5-26

9. Scan/Delivery Options.....	5-27
Scan Settings	5-28
File Formats.....	5-32
Security Settings for PDF Files.....	5-33
Delivery Options	5-34

Chapter 6 Web Menu (Administrator Mode)

1. Web Menu Overview.....	6-2
2. Logging In to the Web Menu	6-5
3. User Administration	6-6
Registering New Users.....	6-7
Restricting User Functions	6-10
Editing Users	6-11
Exporting and Importing Users	6-13
4. Address Book Settings.....	6-14
Registering New Addresses	6-15
Copying Addresses	6-18
Exporting and Importing Address Books	6-18
5. Job Button Settings	6-20
Registering New Job Buttons	6-21
Scan Settings Overview	6-22
Copying Job Buttons	6-26
Editing Jobs	6-27
Exporting and Importing Job Buttons	6-27
6. Device Configuration.....	6-29
Network Setting	6-30
Language/Timezone.....	6-30
Device Operation.....	6-31
Login Options	6-31
Administrator Settings	6-32
7. Server Settings.....	6-33
E-mail Server/Fax Settings.....	6-34
Authentication Server	6-35
Address Book Server.....	6-36
FTP server.....	6-37
NTP Server.....	6-37
ScanFront Service Server	6-37
Certificates.....	6-37

8. System Settings	6-39
Backup and Restore	6-40
Module Version Information/Update	6-41
Log Settings.....	6-42
Screenshot	6-43

Chapter 7 ScanFront Administration Tool

1. About ScanFront Administration Tool.....	7-2
2. Installing ScanFront Administration Tool.....	7-3
System Requirements	7-3
Installation	7-3
3. ScanFront Administration Tool Setup.....	7-5
Starting ScanFront Administration Tool.....	7-5
Registering ScanFront Scanners.....	7-5
4. Managing the ScanFront Scanners.....	7-6
Selecting a ScanFront.....	7-6
Checking ScanFront Connections.....	7-6
Changing Passwords.....	7-6
Changing IP Addresses and Device Names	7-7
Checking Detailed Information on the ScanFront.....	7-7
Displaying the Web Menu.....	7-7
Batch Processing.....	7-7
Importing/Exporting Administration Data.....	7-8

Chapter 8 Web Menu (User Mode)

1. Web Menu Overview	8-2
2. Logging In to the Web Menu	8-3
3. User Settings	8-4
User Settings	8-5
4. Address Book Settings	8-9
Registering New Addresses	8-11
Copying Addresses	8-14
Exporting and Importing Address Books	8-14
5. Job Button Settings	8-16
Registering New Job Buttons	8-18
Scan Settings Overview	8-19
Copying Job Buttons	8-23
Editing Jobs	8-24
Exporting and Importing Job Buttons	8-24

Chapter 9 Maintenance

1. Routine Cleaning.....	9-2
Cleaning the Scanner Unit.....	9-2
Cleaning the Touch Panel	9-2
Cleaning the Fingerprint Sensor (ScanFront 300P)	9-2
Cleaning the Scanning Glass and Rollers	9-3
Cleaning the Retard Roller	9-5
Cleaning the Feed Roller.....	9-6
2. Replacing the Rollers and Document Holding Guide	9-8
Exchange Roller Kit.....	9-8
Replacement Method	9-8
Checking the Page Count and Resetting the Counter.....	9-9

Chapter 10 Troubleshooting

1. Troubleshooting	10-2
2. Error Messages (ScanFront).....	10-6
3. Error Messages (Web Menu)	10-9
4. Adjusting the Touch Panel	10-11
5. Initializing ScanFront.....	10-13

Chapter 11 Appendices

1. Specifications	11-2
Unit Specifications	11-2
Network Specifications	11-3
Transfer Destinations	11-3
AC Adapter (100 to 240 V type)	11-3
Consumable Parts	11-4
External Dimensions.....	11-5
2. Index	11-6

Chapter 1 Before Use

1. Important Safety Instructions	1-2
Installation Location	1-2
Power	1-2
Moving the Scanner	1-3
Handling	1-3
About the Fingerprint Sensor (ScanFront 300P only)	1-5
Disposal	1-5
2. Features of the ScanFront 300/300P/330.....	1-6
ScanFront 300/300P/330	1-6
ScanFront 300P/330	1-7
ScanFront 300P	1-8
ScanFront 330.....	1-8
3. Names and Functions of Parts	1-9
Front and Document Feed and Eject Trays	1-9
Side and Rear	1-10
4. Network Environment	1-11
Network Environment.....	1-11
Directory Service Support	1-11
Limitations	1-12

1. Important Safety Instructions

To ensure the safe operation of this scanner, be sure to read the safety warnings and precautions described below.

□ Installation Location

The performance of this scanner is affected by the environment in which it is installed. Make sure that the location where the scanner is installed meets the following environmental requirements.

- Provide adequate space around the scanner for operation, maintenance, and ventilation.

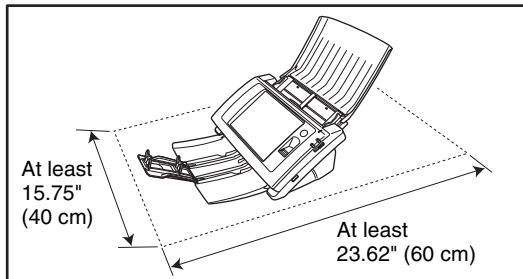

- Avoid installing the machine in direct sunlight. If this is unavoidable, use curtains to shade the scanner.
- Avoid locations where a considerable amount of dust accumulates.
- Avoid warm or humid locations, such as in the vicinity of a water faucet, water heater, or humidifier, and avoid locations where the fumes from ammonia, paint thinner, or other volatile chemicals may be present.
- Avoid locations that are subject to vibration.

- Avoid exposing the scanner to rapid changes in temperature. If the room in which the scanner is installed is cold but rapidly heated, water droplets (condensation) may form inside the scanner. This may result in a noticeable degradation in scanning quality.

The following conditions are recommended for optimal scanning quality:

Room temperature: 10 °C to 32.5 °C (50 °F to 90.5 °F)

Humidity: 20% to 80% RH

- Avoid installing the scanner near equipment that generates a magnetic field (e.g. speakers, televisions, or radios).

□ Power

- Connect only to a power outlet of the rated voltage and power supply frequency (either 120 V, 60 Hz or 220-240 V, 50/60 Hz, depending on your region).
- Do not connect other electrical equipment to the same power outlet to which the scanner is connected. Also, when using an extension cord, make sure that the extension cord is rated for the current requirements of the scanner.
- Never try to disassemble the AC adapter or modify it in any way, as this is extremely dangerous.
- The power cord and AC adapter may become damaged if they are often stepped on or if heavy objects are placed on them. Continued use of a damaged power cord and AC adapter can lead to an accident, such as a fire or electrical shock.
- Do not use the power cord while it is coiled.

- Do not pull directly on the power cord. When disconnecting the power cord, grasp the plug and remove it from the outlet.
- Keep the area around the power plug clear of objects so that the power cord can be disconnected easily in an emergency.
- Use only the AC adapter provided with this scanner. Also, do not use the AC adapter provided with the scanner with any other electrical devices.
Model: MG1-4558
- If you have any questions regarding the power supply, contact your local authorized Canon dealer or service representative for further information.

□ Moving the Scanner

- When moving the scanner, always hold it with both hands to avoid dropping it. The weight of the scanner unit is approximately 7.9 lbs (3.6 kg).
- Before moving the scanner, make sure the document tray is closed and the interface cable and AC adapter are disconnected. If the scanner is transported with these items connected, the plugs and connectors may be damaged due to excessive force applied to them during movement.

□ Handling



WARNING

Note the following precautions whenever using the scanner. Failure to do so may result in a fire or electric shock.

- Never use alcohol, benzene, paint thinner, aerosol sprays, or any other highly flammable substance near the scanner.

- Do not cut, damage, or modify the power cord or AC adapter. Do not place heavy objects on the power cord or AC adapter, and do not pull or excessively bend the power cord.
- Never connect the power cord when your hands are wet.
- Do not connect the scanner to a multiplug power strip.
- Do not knot or coil the power cord, as this may result in a fire or electric shock. When connecting the power cord, make sure that the power plug is securely and completely inserted into the power outlet.
- Do not use power cords and AC adapters other than the power cord and AC adapter provided with this scanner.
- Never try to take the scanner apart or modify it in any way.
- Never try to take the AC adapter apart or modify it in any way, as this is dangerous and may lead to a fire or electric shock.
- Do not use flammable aerosol sprays near the scanner.
- When cleaning the scanner, turn the power OFF and disconnect the power cord from the power supply.
- Clean the scanner using a slightly dampened cloth which has been well wrung out. Never use alcohol, benzene, paint thinner, or any other flammable substances.

- If the scanner makes strange noises, or gives off, smoke, heat, or strange odors, or the scanner does not function or other abnormalities occur when you use the machine, immediately turn the power OFF, and disconnect the power plug from the power outlet. Then, contact your local authorized Canon dealer or service representative for further information.
- Do not drop the scanner, or subject it to impact or strong shock. Should the scanner ever become damaged, immediately turn the power OFF, and disconnect the power plug from the power outlet. Then, contact your local authorized Canon dealer or service representative to have the unit serviced.
- Before moving the scanner, make sure to turn the power OFF, and disconnect the power plug from the power outlet.

**CAUTION**

- Do not install the scanner on a surface that is unstable or tilted, or in an area subject to excessive vibrations, as this may cause the scanner to fall, resulting in personal injury or damage to the scanner.
- Do not block the ventilation openings. Doing so could cause the scanner to overheat, creating a risk of fire.
- Never place small metal objects such as staples, paper clips, or jewelry on the scanner. These items may fall into the scanner, and cause a fire or electric shock. Should such objects ever fall inside the scanner, immediately turn the power OFF, and disconnect the power plug from the power outlet. Then, contact your local authorized Canon dealer or service representative to have the unit serviced.
- Do not install the scanner in a humid or dusty location. Doing so may result in a fire or electric shock.
- Do not place objects on top of the scanner, as they may tip over and fall, resulting in personal injury.
- Do not use the scanner with a power supply voltage other than 120/220-240 VAC. Doing so might cause fire or electric shock.
- When disconnecting the power cord, grasp it firmly by its plug. Do not pull directly on the power cord, as this may damage or expose the cord's internal wiring, resulting in a fire or electric shock.
- Leave sufficient space around the power plug so that it can be disconnected easily. If objects are placed around the power plug, you will be unable to disconnect it in an emergency.
- Do not allow water or flammable substances (alcohol, paint thinner, benzene, etc.) to spill into the scanner, as this may result in a fire or electric shock.
- Turn OFF the power for safety when not using the scanner for a long period of time, such as overnight. Also, turn OFF the power, and disconnect the AC adapter from the scanner and disconnect the power cord from the power outlet for safety when the machine will not be used for an extended period of time, such as during consecutive holidays.
- Do not wear loose clothing or jewelry that may get caught in the scanner while you are using it. This may result in personal injury. Be extra careful of neckties and long hair. If anything becomes caught in the scanner, immediately disconnect the power cord to stop the scanner.
- Be careful when placing paper in the scanner and when removing jammed paper. It is possible to cut your hand on the edge of a sheet of paper.

❑ About the Fingerprint Sensor (ScanFront 300P only)

- The following actions may damage the sensor or cause it to malfunction:
 - Dropping an object on the fingerprint sensor, or otherwise subjecting it to a strong impact
 - Scratching the surface of the fingerprint sensor, or poking it with a pointed object
 - Pressing a hard object such as a fingernail or metal item against the fingerprint sensor
 - Touching the fingerprint sensor with dirty hands
 - Placing a sticker on the surface of the fingerprint sensor, or covering the surface with ink or another substance
- If fingerprint authentication fails frequently, the fingerprint sensor may be dirty. Clean the surface of the fingerprint sensor regularly.
- When cleaning the fingerprint sensor, use a soft dry cloth to wipe dirt off the surface.
- Do not use a pointed object to remove any dirt that accumulates around the fingerprint sensor. Doing so may cause the fingerprint sensor to malfunction.
- Touching the fingerprint sensor while charged with static electricity may cause the fingerprint sensor or scanner unit to malfunction. Before touching the fingerprint sensor, discharge any static electricity by touching a piece of metal. Be especially careful during dry periods, such as the winter season, when the likelihood of being charged with static electricity is high.

❑ Disposal

- Prior to disposing of the scanner, initialize the scanner to ensure that the registered data is deleted.
- When disposing of the scanner, make sure to follow all local ordinances and laws or consult with the retailer who sold you the scanner.

2. Features of the ScanFront 300/300P/330

The main features of the ScanFront 300/300P/330 are described below.

□ ScanFront 300/300P/330

● Compact Network Document Scanner

The network document scanner has a compact design of 12.20" (W) × 8.66" (D) × 6.34" (H) (310 mm (W) × 220 mm (D) × 161 mm (H)). You can scan documents in a range of sizes from business cards to Legal/A4 size.

● Supports Transfer to a Variety of Destinations

- You can transfer scanned image files to the following types of destinations via a network.
- Shared folders (excluding folders on a computer on a different network segment)
 - FTP Servers (excluding FTP servers that require firewall settings)
 - E-mail addresses
 - Fax (via an Internet fax service)

● ScanFront Service

- By installing ScanFront Service on a computer on the network, you can also send scanned images to shared folders and devices, such as the following, for which direct transfer from the scanner is normally unavailable. (Excluding Web Application Mode of ScanFront 330)
- Shared folders on a computer on a different network segment
 - Printers

● Variety of Scanning Modes

The scanner is equipped with five scanning modes: Black and White, Error Diffusion, Text Enhance, Gray, and Color.

● Long Document Scanning

- The scanner is equipped with a scanning mode that can automatically detect long document sizes.
- * The available scanning modes vary depending on the file format of the image to be transferred.

● Fast Document Feeding

- The scanner can scan a maximum of 30 Legal/A4 documents per minute.
- * Scanning conditions: Black and white, simplex, 200 dpi

● Supports USB Memory

- The scanner supports saving image files to USB memory to enable you to move them to destinations not connected to or not using a network.

● Touch Panel Operation

- The 8.4-inch TFT SVGA (800 x 600 dots) screen with a touch panel enables you to perform all scanner operations by touching the screen.

● Configuration via the Web Menu

- A web browser (Web Menu) is used for configuring the basic settings of the ScanFront, user registration, and job button registration. (Excluding Web Application Mode of ScanFront 330)
- * The Web Menu has an Administrator Mode for the administrator to configure settings and a User mode for users to register addresses and job buttons.

● ScanFront Administration Tool

- By installing the supplied ScanFront Administration Tool software, you can simultaneously manage multiple ScanFront scanners on the network.

● Job Buttons

- Pre-registering destinations and scan conditions as jobs enables you to scan by selecting a job button.

● Shared Address Book and Shared Job Button

- The Shared Address Book and Shared Job Buttons are available for use by all users.

● My Address Book and My Job Button

- In addition to the address book and job buttons shared by all users, a My Address Book and My Job Button are available for each user.

- **Supports Mouse and Keyboard**

In addition to touch-panel operation, you can also use a mouse and keyboard to operate the scanner. (See p. 2-5.)

- **Supports Directory Services**

The scanner supports directory services (Active Directory and OpenLDAP), which enables you to reference and use user accounts and e-mail addresses registered on a domain server and LDAP server.

- **Functional Restrictions**

The scanner enables you to restrict, for example, the destinations and Home screen available to each user.

- **Auto Size Detection**

The scanner can detect the size of a scanned document and erase the white space around the image.

- **Auto Color Detection**

The scanner can automatically detect whether a document is color or black and white, and save the scanned images accordingly.

- **Folio Scanning**

The scanner can scan both sides of a document folded in half and create a single scanned image.

- **Text Enhance Mode**

The background color of the text are processed to enhance the text portions and make them easy to read.
* This function may not work effectively for some documents.

- **Double Feed Detection by Length**

When the scanner detects a double feed by comparing the lengths of documents, it stops feeding.

* Using the length of the first document as a reference, the scanner detects a double feed when a document of a different length is fed.

- **Skip Blank Page Function**

The scanner scans both sides of a document and skips saving the image of any side it determines to be a blank page.

- **Deskew**

If the scanner detects from a scanned image that the document was fed askew, the image is straightened.

- **Image Rotation**

The scanner can rotate a scanned image in 90° increments, or detect the text orientation within the document, and then rotate the image in 90° increments so that the orientation of the text is correct.

- **Eliminates Bleed-Through**

The scanner prevents the images on the reverse side of thin documents from appearing on the scanned pages.

- **Dropout and Color Enhancement Functions**

The scanner is equipped with a dropout function that allows you to specify one color (red, blue, or green) to omit, and a function to enhance a specified color when scanning.

- **Card Scanning**

You can scan credit cards and IC cards that conform to ISO standards.

- **Prescan**

This function prescans the first page of a document at the start of scanning, and then stops scanning so that you can view the results to adjust the brightness and contrast before scanning the entire document.

- **ScanFront 300P/330**

- **Double Feed Detection by Ultrasonic Function**

In addition to the double feed detection function that compares the lengths of documents, the scanner is equipped with a double feed detection function that uses an ultrasonic sensor.

❑ ScanFront 300P

● Fingerprint Authentication

The authentication system that uses a fingerprint sensor to authenticate users enables you to log in to the ScanFront 300P without entering your user name and password.

❑ ScanFront 330

● Web Application Mode

The scanner can be switched to Web Application Mode which enables the Web application configured on the server to be accessed via a browser in order to scan documents. By revising the Web application, the developer can customize ScanFront operation.

3. Names and Functions of Parts

The names and functions of the parts of the ScanFront are shown below.

□ Front and Document Feed and Eject Trays

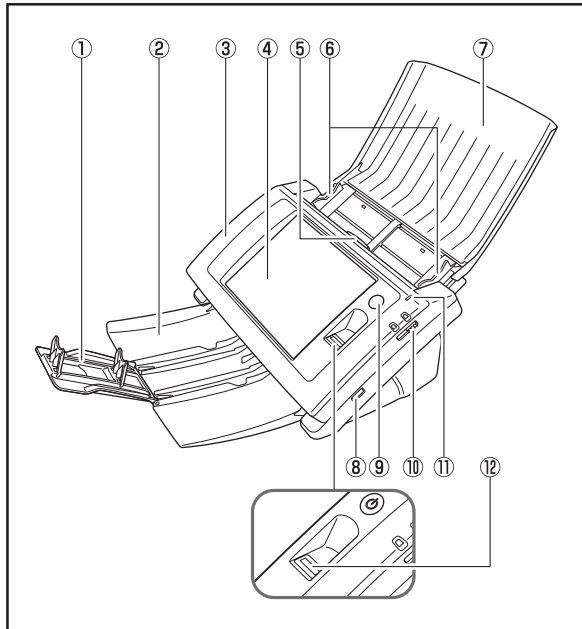

* The illustration above shows the ScanFront 300P.
In this manual, the ScanFront 300P is used in the illustrations of the scanner. Please note that the appearance of some parts of the ScanFront 330 differs.

- ① **Tray Extension**
Open this to prevent scanned documents from slipping off.
- ② **Document Eject Tray**
Open this tray when using the ScanFront. If scanned documents curl in the document eject tray, remove the entire tray. (See p. 2-4.)
- ③ **Panel Unit**
Open this when there is a paper jam or to perform maintenance. (See p. 2-10.)
- ④ **Touch Panel**
Touch this screen to operate the ScanFront.
- ⑤ **Lock Lever**
Locks the panel unit. Pull the lever toward you to unlock the panel unit. (See p. 2-10.)
- ⑥ **Document Guides**
Adjust these to match the width of the document. (See p. 2-6.)
- ⑦ **Document Feed Tray**
Place documents here. (See p. 2-4.)
- ⑧ **USB Port (Front)**
Connect a USB1.1/Hi-Speed USB2.0 compatible USB memory device, USB keyboard, or USB mouse.
- ⑨ **Power Switch**
Use this to turn the power ON. (See p. 3-4.)
* Use the Power OFF button on the touch panel to turn the power OFF.
- ⑩ **Feed Selection Lever**
Use this lever to change the feed method for documents. (See p. 2-5.)
- ⑪ **Power Indicator**
Lights when the power is ON. (See p. 3-4.)
- ⑫ **Fingerprint Authentication Sensor (Only Available with the ScanFront 300P)**
This fingerprint sensor is for fingerprint registration and authentication. (See p. 2-11.)

❑ Side and Rear

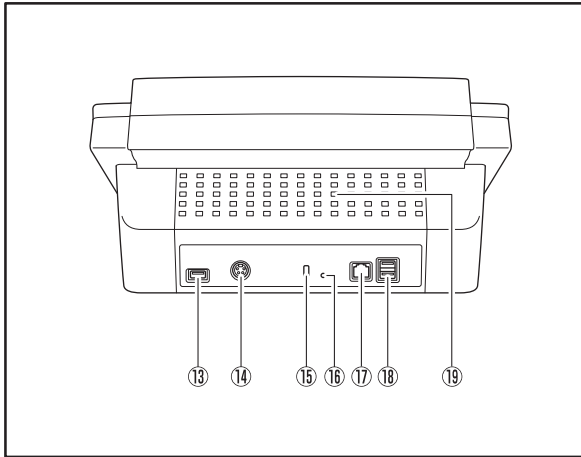

- ⑬ **USB Port (Rear Left)**
Connect a USB1.1/Hi-Speed USB2.0 compatible USB memory device, USB keyboard, or USB mouse.
- ⑭ **Power Connector (24 VDC)**
Connect the plug of the supplied AC adapter. (See p. 3-3.)
- ⑮ **Kensington Slot**
This is an anti-theft slot that enables a key chain or lock to be connected to prevent theft.
- ⑯ **Service Switch**
This is a service switch. Do not insert any object into this hole.
- ⑰ **LAN Port (RJ-45)**
Connect an RJ-45 (10Base-T/100Base-TX) compatible network cable. (See p. 3-3.)
- ⑱ **USB Ports (Rear Right)**
Connect a USB1.1/Hi-Speed USB2.0 compatible USB memory device, USB keyboard, or USB mouse.
- ⑲ **Ventilation Holes**

4. Network Environment

The network environment required to use the ScanFront is described below. To obtain details on your network environment, contact your network administrator.

□ Network Environment

- **Microsoft Windows Network**
Use the scanner in a Microsoft Windows Network environment.
- **Network Protocol**
The scanner uses TCP/IP protocol to connect to the network.
- **IP Address Assignment**
The TCP/IP protocol uses one IP address for each device connected to the network. Consult your network administrator to determine the IP address to assign to the scanner.
- **DHCP Support**
The scanner supports DHCP (Dynamic Host Configuration Protocol). A DHCP server provides a network environment in which IP addresses can be obtained automatically from the DHCP server, so there is no need to set an IP address for the scanner.
* The number of IP addresses that can be obtained using DHCP is managed by the network administrator. For details, consult your network administrator.
- **100Base-TX Support**
The scanner supports 100Base-TX. However, communication may be slower than the communication speed of the network, depending on the other devices connected to the network and the type of hub.
- **SMTP (E-mail) Server**
The scanner supports an SMTP server, so you can send image files directly from the scanner by e-mail.
- **FTP Server**
The FTP server function supports an FTP server configured within the local network, and is unable to send to an FTP server that requires firewall settings.

- **Fax**
Scanned images can be sent to specified addresses as fax documents by sending e-mails that include the scanned images as attachments to an Internet fax service. Therefore, you must specify message formats and addresses in the method prescribed by your Internet fax service.
- **Printer**
By specifying a printer connected to the same network as the ScanFront as the destination, you can print scanned images. In such cases, a computer on which ScanFront Service is installed must exist on the same network as the ScanFront scanner.

□ Directory Service Support

- **Active Directory**
Active Directory is a directory service adopted by Windows 2000, and information registered to Active Directory can be used on other computers. The ScanFront allows user information registered to the domain server registered as the authentication server to be used for authentication to log in to the ScanFront.
* A domain server that uses Windows NT Server for the operating system cannot be registered as an authentication server.
- **OpenLDAP Server**
The scanner supports OpenLDAP servers that can be connected to with the LDAP (Lightweight Directory Access Protocol) protocol.
You can authenticate ScanFront users and reference e-mail addresses for registration to the address book using the user information registered on the OpenLDAP server.

□ Limitations

● Limitations for Network Environments without ScanFront Service

To send image files to destinations and devices, such as the following, the supplied ScanFront Service software must be installed on a computer on the same network as the ScanFront scanner.

- Destinations (folders on computers, printers, etc.) located on a different network segment
- Printers on the network
- Certain NAS (network-attached storage)

Chapter 2 Handling

1. Documents.....	2-2
Plain Paper.....	2-2
Business Card.....	2-2
Card	2-3
2. Preparing the Scanner.....	2-4
Preparing the Document Feed Tray and Eject Tray	2-4
Feed Selection Lever	2-5
USB Port	2-5
3. Placing Documents.....	2-6
Placing a Document	2-6
Placing a Folded Document	2-7
Placing a Long Document	2-7
Placing a Card.....	2-8
4. Clearing a Paper Jam or Double Feed Error ...	2-9
5. Fingerprint Sensor (ScanFront 300P).....	2-11
Cautions for Handling the Fingerprint Sensor	2-11
Fingerprint Authentication	2-12

1. Documents

The ScanFront can scan documents in a range of sizes from business cards to Legal/A4.

It is possible to feed documents of the following sizes and thicknesses depending on the feeding method used.

□ Plain Paper

Size

Width: 2" to 8 1/2" (50.8 mm to 216 mm)

Length: 2 1/8" to 14" (53.9 mm to 355.6 mm)

(up to 39.3" (1,000 mm) in Long Document mode)

Thickness for Page Separation ON

14 lb to 57 lb bond (52 g/m² to 209 g/m²)

Thickness for Page Separation OFF

11 lb to 57 lb bond (40 g/m² to 209 g/m²)

! IMPORTANT

A document must meet the following criteria to be scannable:

- When scanning a multipage document, pages must be grouped together so that they have the same size, thickness, and weight. Scanning different types of paper at one time can cause the scanner to jam.
- Always make sure that the ink on a document is dry before scanning it. Scanning documents with the ink still wet may soil the rollers or scanning glass, cause lines or smudges to appear on images, or dirty other documents.
- Always clean the rollers or scanning glass after scanning a document written in pencil. Scanning documents with pencil written on them may soil the rollers or scanning glass, cause stripes to appear in images, or dirty other documents.
- When scanning a two-sided document that is printed on thin paper, the image on the opposite side of each page may show through. Adjust the brightness in the scanning conditions before scanning the document.

- Note that scanning the following types of documents can cause a paper jam or malfunction. To scan such a document, make a photocopy of the document and then scan the photocopy.



Wrinkled or creased documents



Carbon paper



Curled documents



Coated paper



Torn documents



Extremely thin, translucent paper



Documents with paper clips or staples



Document with square punch holes

□ Business Card

Size

Width: 2" (50.8 mm) and above

Length: 2 1/8" (53.9 mm) and above

Thickness

82 lb Cover (300 g/m²) and below

! IMPORTANT

- If the stack of business cards that you placed is not fed properly, reduce the number business cards.
- Business cards may sometimes be stacked in the wrong order when they are ejected, depending on the size and thickness of the business cards, and the orientation that they are loaded.

❑ Card

Size

2.12" × 3.37" (53.9 × 85.5 mm) (Conforming to ISO Standards)

Thickness

0.0299" (0.76 mm) and below

Insertion orientation

Landscape

IMPORTANT

- Insert cards one at a time.
- Be careful when inserting cards to avoid damaging them.

2. Preparing the Scanner

When placing a document in the scanner, pull out the document eject tray so that it matches the size of the document, and then move the feed selection lever to the appropriate position for the desired feed method (Page Separation ON or OFF) for the document.

□ Preparing the Document Feed Tray and Eject Tray

Prepare the trays in accordance with the type of document.

1. Open the document feed tray ①.
2. Open the document eject tray ②.

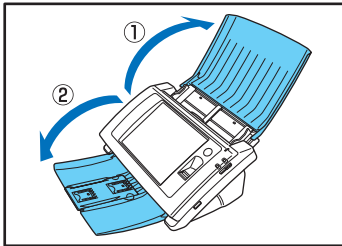

Hint

Open the center tray extension when output documents are likely to fall out of the tray.

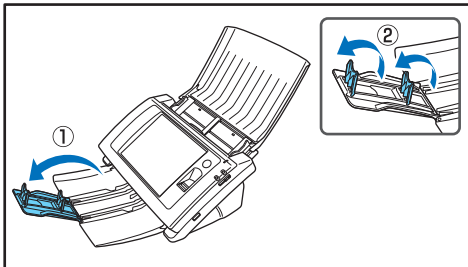

Hint

If the output documents curl in the eject tray when scanning particularly thin documents, remove the eject tray.

To remove the document eject tray, push in on the illustrated portions of the tray on both sides in the direction of the arrows ① and pull out ②.

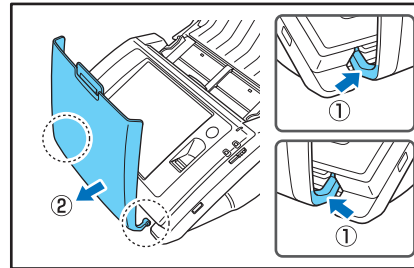

To reattach the eject tray, insert the protrusions on both sides of the tray into the holes on the scanner.

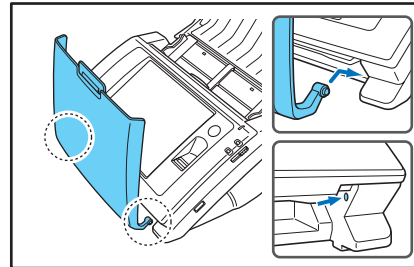

After connecting the tray, make sure that it is attached securely.

❑ Feed Selection Lever

Change the position of the lever to the desired feed method for the document.

Page Separation ON

Move the lever downward to separate a stack of documents one page at a time in order to continuously feed the documents.

Page Separation OFF

Move the lever upward to feed a document with multiple pages attached together such as an invoice one page at a time without separating the pages.

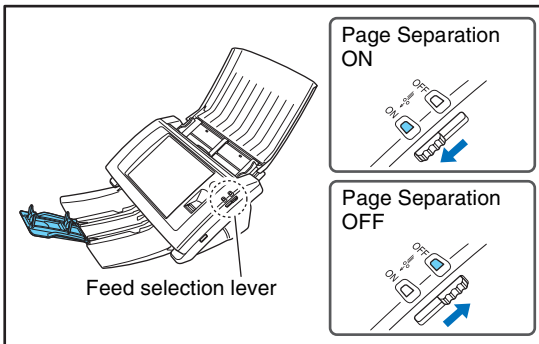

! IMPORTANT

Moving the lever upward (Page Separation OFF) and then scanning a stack of documents will cause multiple pages to be fed at the same time.

❑ USB Port

You can insert a USB memory device to store image files.

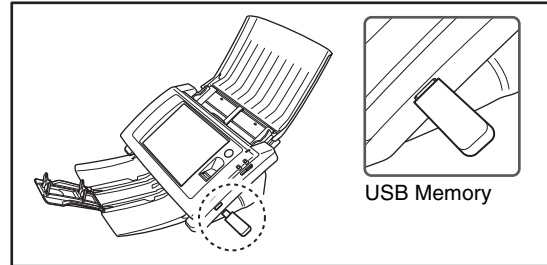

You can also connect a USB keyboard and USB mouse to operate the ScanFront.

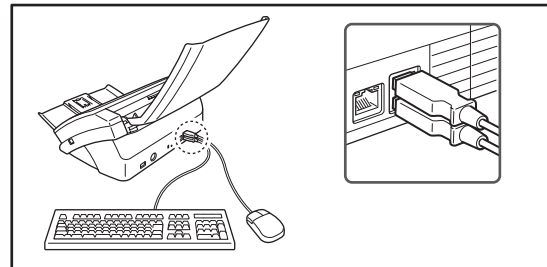

! IMPORTANT

- The scanner will not start if you turn the power ON while a USB memory device is inserted. Insert the USB memory device after the scanner starts up and the Home screen appears.
- Use USB memory that is not write-protected. If the USB memory is write-protected, data cannot be written to the USB memory.
- This scanner does not support USB memory equipped with password security, data encryption, or functions other than data storage.
- Make sure that the USB memory has sufficient space to store images.

3. Placing Documents

When placing documents into the scanner, place them face down into the tray with the top edge of the document at the bottom of tray.

□ Placing a Document

Follow the procedure below to place a document.

1. Adjust the document guides to be wider than the width of the document.

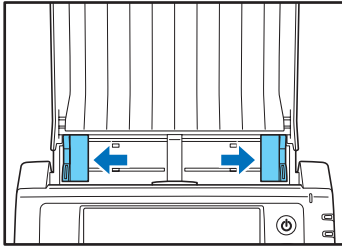

2. Fan the document to offset the pages so that the top edge of the first page is the lowest.

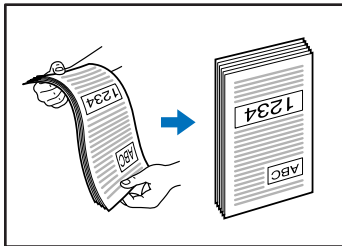

3. Place the document face down with its top edge at the bottom of the tray.

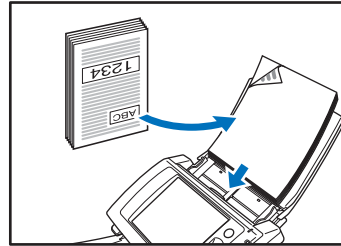

4. Adjust the document guides to fit the width of the document.

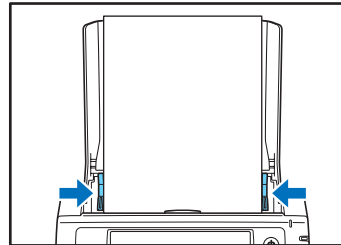

! IMPORTANT

Make sure that document stacks placed in the feed tray do not exceed the document guides.

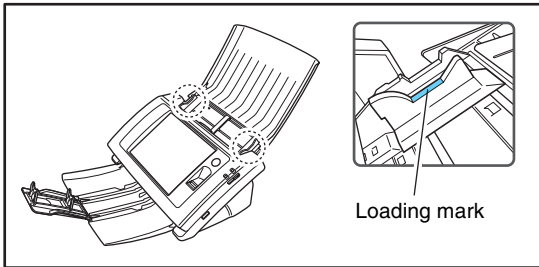

The number of sheets that you can place in the scanner at one time varies by paper size as follows.

Legal/A4 Size or Smaller:

50 sheets (stack 5 mm thick) or less

Sizes Larger than Legal/A4:

30 sheets (stacks 3 mm thick) or less

❑ Placing a Folded Document

Folio Scan enables you to scan documents that are larger than Legal/A4 and therefore do not fit in the feeder. (The maximum size is 11" X 17"/A3.) To use the function, fold the document in half lengthwise and place it into the feeder. The ScanFront will scan both sides and combine the scanned images into a single image.

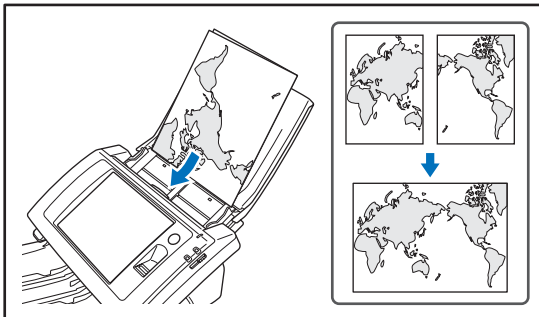
**! IMPORTANT**

- When folding the document, align the right and left sides and create a sharp, straight fold. Otherwise the document may jam or the image may not be aligned properly.
- The fold line itself will not be scanned. Keep this in mind if there is content such as photos, diagrams, or text that spans the fold.
- For Folio scanning, only the Page Separation OFF mode can be used. Place documents one at a time.
- Adjust the document guides to fit the width of the document. Otherwise, the image may scan as skewed or shifted.

💡 Hint

- When scanning folded documents, switch the feed selection lever to OFF. (See p. 2-5.)
- When placing folded documents, place the document into the scanner so that the fold is on the right side. The side of the folded document facing you will become the right side of the combined image.
- When scanning a document that is folded in half, set [Scanning Side] to [Folio].
- The maximum size for combined images is A3. When scanning a folded document of a size other than the standard formats, set [Page Size] to [Auto size].
- When scanning a document that is folded in half, set [Resolution (dpi)] to 300 dpi or less.
- When scanning a document that is folded in half, the [Double feed detection by Ultrasonic] function cannot be used.

❑ Placing a Long Document

You scan documents up to 39.3" (1,000 mm) in length.

! IMPORTANT

- When scanning a long document, set [Page Size] to [Auto size (Long)].
- When scanning a long document, set [Resolution (dpi)] to 200 dpi or less.
- You cannot set [Scanning Side] to [Folio] when scanning a long document.

❑ Placing a Card

When you want to scan a card, follow the procedure below to place the card.

1. Move the feed selection lever upward (OFF).

! IMPORTANT

When scanning cards, set the feed selection lever to OFF and make sure to scan the cards one at a time.

2. Adjust the document guides to match the width of the card.

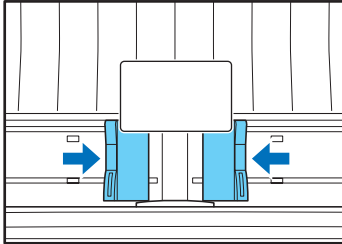

3. Place the card face down with the top edge at the bottom of the tray.

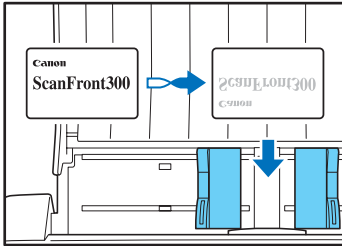

! CAUTION

- A card placed into the document feed tray in the portrait orientation may not be output properly because a load is placed on it during feeding. Furthermore, removing a card that has caused a feeding error may damage the card, so make sure to correctly insert the card.
- Pull the lock lever and open the panel unit before removing a placed card. Inserting a finger into the scanner while the panel unit is closed may result in an injury.

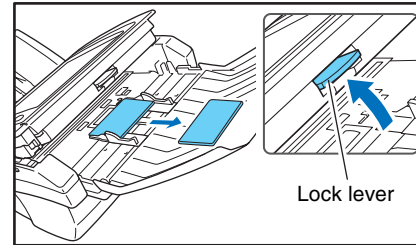

4. Clearing a Paper Jam or Double Feed Error

When a paper jam or double feed error is detected, feeding and scanning stops.

1. Check the displayed message.

If a paper jam or double feed error is detected at the first page of a document, the following messages appear.

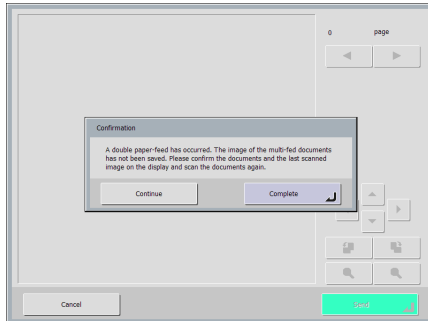
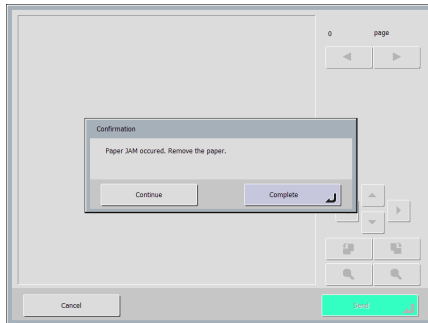

Hint

- If you press [Complete], the display returns to the previous screen.
- If you want to continue scanning, reset the document before progressing with screen operations. Press [Continue] to resume scanning.

If a paper jam or double feed error is detected in the middle of a document, the following messages appear.

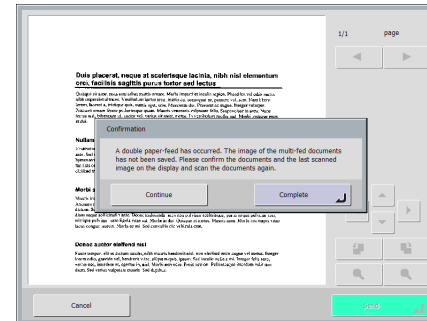
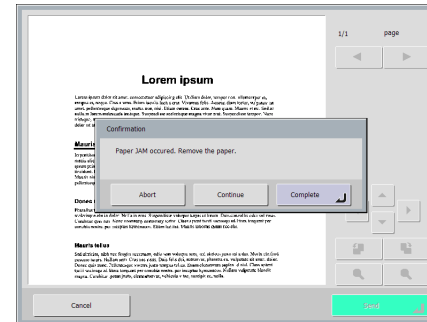

Hint

- If you press [Abort], the scanned images are canceled, and the display returns to the previous screen.
- If you want to continue scanning, clear the document first before touching the screen. After you reset the cleared document, press [Continue] to resume scanning.
- If you press [Complete], the scanned images up until the paper jam or double feed error are saved and scanning completes. The display switches to the Send screen.

! IMPORTANT

When the message above is displayed and the scanner transitions to Low Power Mode, all of the data scanned up until that point is discarded. (See “Low Power Mode” on p. 6-31.)

2. Remove the scanned documents from the document eject tray, and any documents remaining in the document feed tray.
3. Pull the lock lever toward you and then fully open the panel unit.

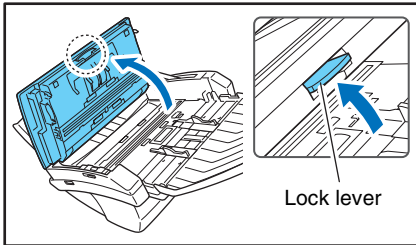
**! CAUTION**

The open/close movement of the panel unit is linked to the up/down movement of the document eject tray. Do not press on the document eject tray when you open the panel unit.

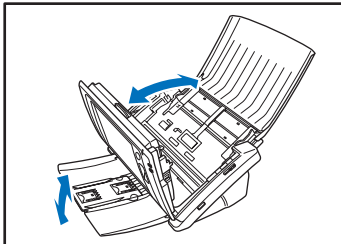

4. Pull out the jammed document in the direction that seems the easiest to remove it.

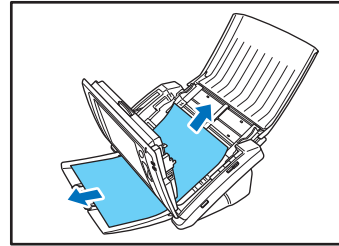

5. Close the panel unit and then place the document again.

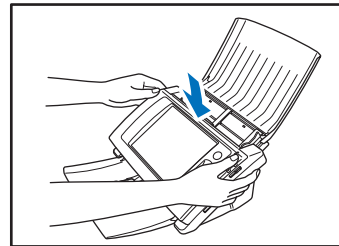

6. Press [Continue] to resume scanning.

! IMPORTANT

- If double feed errors occur repeatedly, reduce the number of sheets you place in the document feed tray to about 10.
- A dirty or worn feed roller, or documents stuck together as a result of static electricity are common causes of paper jams or double feed errors.

If the feed roller is dirty, clean it. If paper jams or double feed errors continue to occur even after cleaning, purchase an Exchange Roller Kit and replace the rollers (feed roller and retard roller), and document holding guides. (See p. 9-8.)

5. Fingerprint Sensor (ScanFront 300P)

The ScanFront 300P is equipped with a fingerprint sensor for registering fingerprints and authenticating users. The fingerprint sensor is a precision component. Be careful when handling this sensor.

□ Cautions for Handling the Fingerprint Sensor

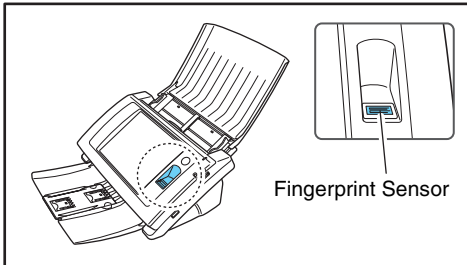

- The following actions may damage the fingerprint sensor or cause it to malfunction. Read this information carefully to avoid damaging the sensor.
 - Dropping an object on the fingerprint sensor, or otherwise subjecting it to a strong impact
 - Scratching the surface of the fingerprint sensor, or poking it with a pointed object
 - Pressing a hard object such as a fingernail or metal item against the fingerprint sensor
 - Touching the fingerprint sensor with dirty hands
 - Placing a sticker on the surface of the fingerprint sensor, or covering the surface with ink or another substance
- If fingerprint authentication fails frequently, the fingerprint sensor may be dirty. Clean the surface of the fingerprint sensor regularly.
- When cleaning the fingerprint sensor, use a soft dry cloth to wipe dirt off the surface.

- Do not use a pointed object to remove any dirt that accumulates around the fingerprint sensor. Doing so may cause the fingerprint sensor to malfunction.
- Touching the fingerprint sensor while charged with static electricity may cause the fingerprint sensor or scanner unit to malfunction. Before touching the fingerprint sensor, discharge any static electricity by touching a piece of metal. Be especially careful during dry periods, such as the winter season, when the likelihood of being charged with static electricity is high.

□ Fingerprint Authentication

- Follow the procedure below to use fingerprint registration and authentication.
 1. Align the first joint of a finger on the sensor and press the finger on the fingerprint sensor.
 2. Keep the finger pressed while slowly sliding it straight at a constant speed to scan the fingerprint.

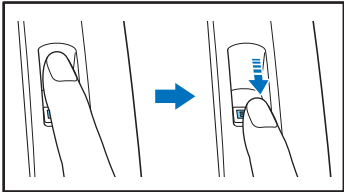

- Fingerprint authentication uses the unique information of fingerprints. The fingerprint authentication function may not work properly for a finger with a fingerprint that is worn down or has few distinguishable features.
- The same finger needs to be scanned three times to register the fingerprint.
- The authentication performance differs depending on the condition of the fingerprint when it is registered and when it is authenticated. The following conditions may cause an error in fingerprint authentication:
 - The finger is wet or sweaty
 - The finger is dirty
 - The grooves of the fingerprint are filled with sweat or oil
 - The finger is dry (dry skin)
 - Part of the fingerprint is missing because of, for example, a wound or burn injury
 - The fingerprint has worn thin

- Authentication performance may improve if the condition of the fingerprint is improved as a result of washing your hands or applying hand cream.
- Authentication may not be performed properly depending on the speed with which you slide your finger over the sensor. In this case, adjust the speed with which you slide your finger in accordance with the message that appears.
- Fingerprint authentication does not necessarily guarantee the authentication and verification of the identity of a person.

Hint

For details on the procedures for fingerprint registration and authentication, see [Chapter 5 "Operating Procedures"](#).

Chapter 3 ScanFront Setup

1. Before Setting Up the Scanner	3-2
Installation Location	3-2
Connecting the AC Adapter	3-3
Connecting the Network Cable	3-3
2. Turning the Power ON and OFF	3-4
Turning the Power ON	3-4
Turning the Power OFF	3-4
3. Configuring the Scanner Settings	3-5
Administrator Settings	3-5
Web Menu (Administrator Mode)	3-6
4. Configuring Administrator Settings	3-8
Logging In to the Administrator Settings	3-8
Network Settings	3-9
Administrator Password	3-9
Backup/Restore Setting Information	3-10
Select Login Type	3-10
Roller Counter Reset	3-11
Format ScanFront	3-11
Touch Panel Adjustment	3-11
Display Language Setting	3-12
Network Test	3-12
Switch to Web Application Mode (from Standard Mode of ScanFront 330 Only)	3-12

1. Before Setting Up the Scanner

Before setting up the scanner, you need to move it to the installation site, and connect the AC adaptor and network cable.

□ Installation Location

The performance of this scanner is affected by the environment in which it is installed. Make sure that the location where the scanner is installed meets the following environmental requirements.

- Provide adequate space around the scanner for operation, maintenance, and ventilation.

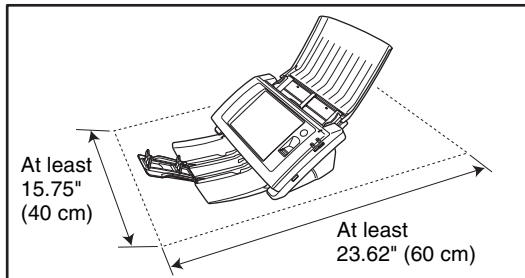

- Avoid installing the machine in direct sunlight. If this is unavoidable, use curtains to shade the scanner.
- Avoid locations where a considerable amount of dust accumulates.
- Avoid warm or humid locations, such as in the vicinity of a water faucet, water heater, or humidifier, and avoid locations where the fumes from ammonia, paint thinner, or other volatile chemicals may be present.
- Avoid locations that are subject to vibration.

- Avoid exposing the scanner to rapid changes in temperature. If the room in which the scanner is installed is cold but rapidly heated, water droplets (condensation) may form inside the scanner. This may result in a noticeable degradation in scanning quality.

The following conditions are recommended for optimal scanning quality:

Room temperature: 10 °C to 32.5 °C (50 °F to 90.5 °F)

Humidity: 20% to 80% RH

- Avoid installing the scanner near equipment that generates a magnetic field (e.g. speakers, televisions, or radios).

❑ Connecting the AC Adapter

Follow the procedure shown below to connect the AC adapter.

⚠ CAUTION

Make sure to use only the AC adapter and power cord included with the scanner.

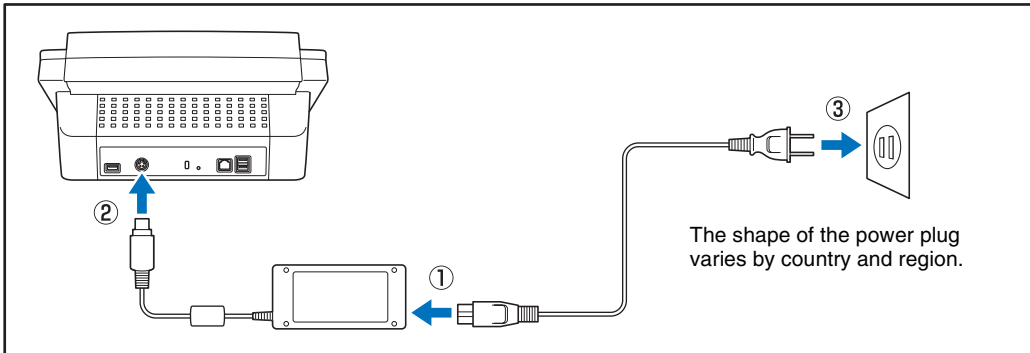

- ① Connect the power cord and AC adapter.
- ② Insert the plug of the AC adapter into the power connector.
- ③ Connect the power cord to the wall outlet.

❑ Connecting the Network Cable

Insert the network cable connector (RJ-45) into the LAN port.

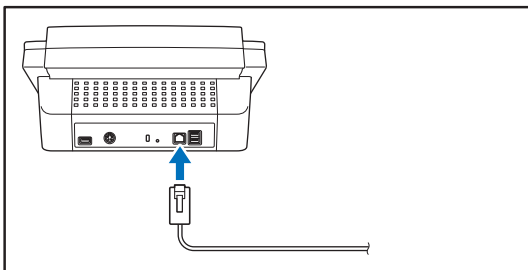

2. Turning the Power ON and OFF

Use the power switch to turn the scanner ON, and press the [Power off] button on the touch panel to turn it OFF.

□ Turning the Power ON

Press the power switch to turn the scanner ON. The power indicator lights, and the Home screen or the login screen appears.

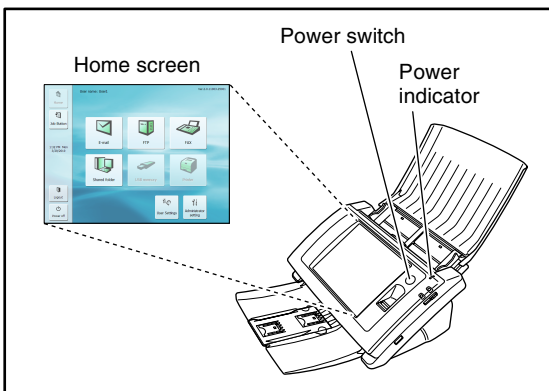

! IMPORTANT

- It takes approximately 40 seconds for the Home screen to appear after the power switch is turned on.
- When the power indicator is lit but nothing appears on the touch panel, Display Off has activated to turn the panel display off. You can touch the panel to restore the display. (See “Display Off” on p. 6-31.)
- When the power indicator is flashing but nothing appears on the touch panel, the Low Power mode has activated to temporarily stop scanner operations. To switch out of Low Power mode, press the power switch or touch the touch panel. (See “Low Power Mode” on p. 6-31.)

□ Turning the Power OFF

Press the [Power off] button displayed at the bottom left of the panel to turn the scanner OFF.

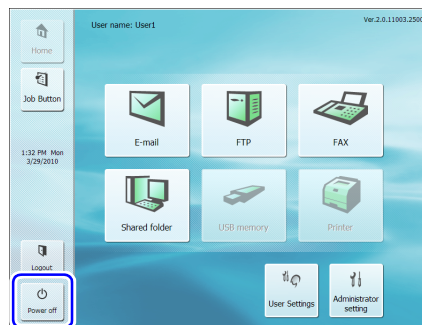

! IMPORTANT

- When restarting the scanner, wait at least 5 seconds after turning the power OFF before turning it ON again.
- If the scanner stops responding, press and hold the power switch to shut down the system, and then press the power switch to turn the scanner ON again. In such cases, settings configured immediately before shutting down may be lost.

3. Configuring the Scanner Settings

The scanner setup consists of configuring the initial network settings from the [Administrator setting] screen, and then configuring the settings needed to use the scanner as described in [Chapter 6 “Web Menu \(Administrator Mode\)”](#).

□ Administrator Settings

The following items are available for administrator settings. For details, see [“Configuring Administrator Settings”](#) on p. 3-8.



Hint

Except for the scanner maintenance items (roller counter reset, touch panel adjustment, and initialization), the administrator setting items can be configured from the Web Menu (Administrator Mode). For details, see [“Web Menu \(Administrator Mode\)”](#) on p. 3-6 or [Chapter 6 “Web Menu \(Administrator Mode\)”](#).

Setting Item	Description	Administrator setting	Web Menu (Administrator Mode)
Network settings	Set the Device Name and IP Address needed to connect to the network.	Yes	Yes
Change administrator password	Set the password required for logging in to [Administrator setting] and the Web Menu.	Yes	Yes
Backup / Restore all settings	Back up or restore the scanner settings.	Yes	Yes
Login type setting	Select the login screen for users.	Yes	Yes
Roller Counter Reset	Reset the counter after replacing the feed roller.	Yes	No
Format ScanFront	Use to delete all of the current settings, such as when changing the operating environment of the scanner.	Yes	No
Touch panel adjustment	Adjust the touch panel when it does not operate as expected.	Yes	No
Display language setting	Set the language displayed on the touch panel.	Yes	Yes
Network Test	Confirm whether communication is enabled between the ScanFront and other devices on the network.	Yes	No
Change to the web application mode (ScanFront 330 only)	Switch to Web Application Mode when using the ScanFront 330 in Standard Mode.	Yes	No

❑ Web Menu (Administrator Mode)

The following setting items are available from the Web Menu (Administrator Mode). For details, see [Chapter 6 “Web Menu \(Administrator Mode\)”](#).



Hint

From the Web Menu (User Mode), which is available to all users, the configuration of some functions is restricted.

Setting Item	Description	Web Menu (Administrator Mode)	Web Menu (User Mode)
User Administration	Register new users and edit user settings. From User Mode, only the editing of user settings is available, and some settings cannot be edited.	Yes (See p. 6-6)	Yes, partially. (See p. 8-4)
Address Book Settings	Register and edit entries in the Shared Address Book. From User Mode, you can register and edit entries in the My Address Book.	Yes (See p. 6-14)	Yes (See p. 8-9)
Job Button Settings	Register and edit the Shared Job Button. From User Mode, you can register and edit the My Job Button.	Yes (See p. 6-20)	Yes (See p. 8-16)
Device Configuration	Configure the scanner settings.		
Network Settings	Confirm the [Device Name] and [IP Address] settings of the scanner.	Yes (See p. 6-30)	No
Language/Timezone	Set the language displayed on the touch panel and the geographic region where it will be used.	Yes (See p. 6-30)	No
Device Operation	Set the Auto Logout and Low Power Mode settings for users.	Yes (See p. 6-31)	No
Login Options	Select the login screen for users.	Yes (See p. 6-31)	No
Administrator Settings	Register the password and e-mail address of the administrator.	Yes (See p. 6-32)	No

Setting Item	Description	Web Menu (Administrator Mode)	Web Menu (User Mode)
Server Settings	Register the mail server, address book server and authorization server.		
E-mail Server / Fax Settings	Register the SMTP server to be used for sending e-mail and faxes.	Yes (See p. 6-34)	No
Authentication Server	Register a domain server that can search users with Active Directory.	Yes (See p. 6-35)	No
Address Book Server	Register an LDAP server that can search e-mail address books.	Yes (See p. 6-36)	No
FTP Server	Configure settings for saving image files to the FTP server.	Yes (See p. 6-37)	No
NTP Server	Register an NTP server to enable automatic adjustment of the scanner's clock.	Yes (See p. 6-37)	No
ScanFront Service Server	Register the computer on the network on which ScanFront Service is installed.	Yes (See p. 6-37)	No
Certificates	Import the root certificate of the LDAP server to the ScanFront.	Yes (See p. 6-37)	No
System Settings	Configure the settings for managing the scanner.		
Backup / Restore	Back up or restore the scanner settings.	Yes (See p. 6-40)	No
Module Version Information	Display the version information, and update the version, of the ScanFront module.	Yes (See p. 6-41)	No
Log Settings	Record usage statistics to a log file.	Yes (See p. 6-42)	No
Screenshot	Saves the ScanFront screen display as a BMP file.	Yes (See p. 6-43)	No

4. Configuring Administrator Settings

Enter the administrator password and log in to configure administrator settings.

□ Logging In to the Administrator Settings

Follow the procedure below to configure the [Device name] and [IP address] needed to connect the scanner to a network.

1. Press [Administrator setting].

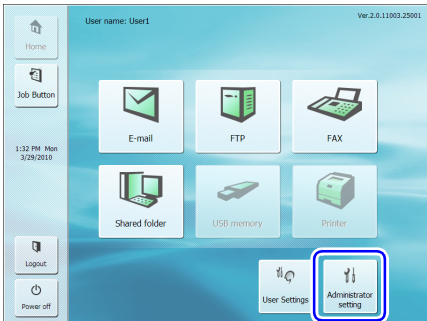

The [Administrator Password] input box appears.

2. Press [OK] to display the [Administrator setting] screen.

No administrator password is set by default.

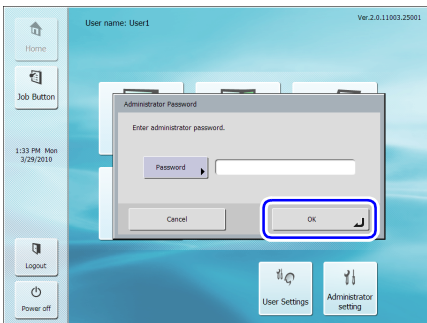

3. Select the setting item to configure.

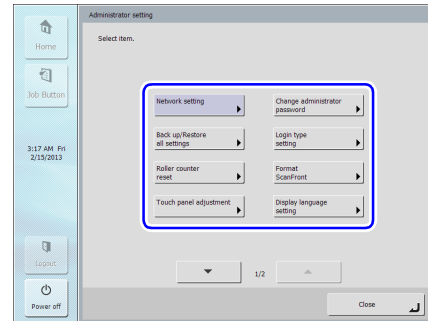

❑ Network Settings

Under Network Settings, configure the device name and IP address needed to connect the scanner to a network.

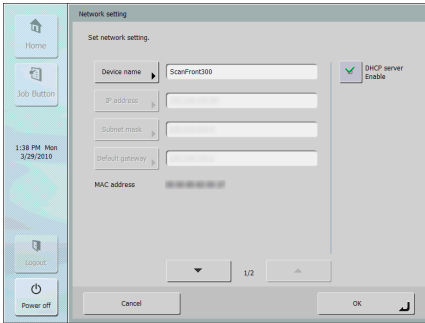

! IMPORTANT

- Configure network settings while the network cable is connected to the scanner. If the network cable is not connected to the scanner, you will not be able to verify or modify settings in the network settings screen.
- The device name is the name for the scanner used on the network. When changing this setting, make sure to select a unique name that is different from those of all other devices.
- The device name can be a combination of letters (A-Z, a-z), numbers (0-9), and hyphens (-) up to 15 characters long.
- The device name must begin with a letter. You cannot end the device name with a hyphen.
- When a DHCP server is not used to assign IP addresses, clear the [DHCP server Enable] check box, and enter a fixed address. For details, contact your network administrator.
- If the DHCP server is enabled and the DNS server and WINS server information is not obtained properly, clear the [Automatic retrieval of DNS (WINS) server] check box, and enter the appropriate server addresses.
- To send image files to devices or shared folders on a different segment of the network, you must incorporate a computer on which ScanFront Service is installed onto the network.

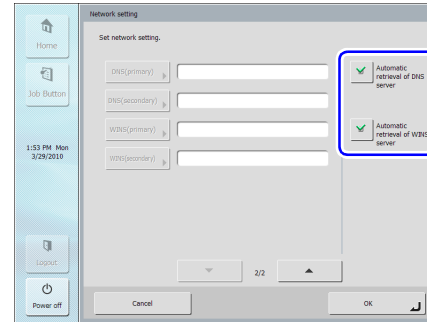

❑ Administrator Password

Set the password required to log in to [Administrator setting] and the Web Menu (Administrator Mode).

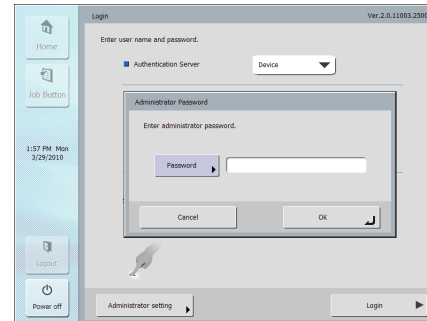

! CAUTION

Be careful with the administrator password. If you forget the password, you will have to reformat the scanner, and all registered data will be lost.

❑ Backup/Restore Setting Information

Back up/restore setting information using a shared folder on the network or USB memory device at the following times.

When adding another ScanFront

When adding, for instance, another ScanFront, back up the setting information that was set on the first ScanFront, and then restore the setting information on the other ScanFront.

When updating the version of the ScanFront

Back up the setting information before you update the version of the ScanFront, and then restore the setting information after the version update is finished.

When submitting the ScanFront for repairs

Before you submit the ScanFront for repairs, back up the setting information of the ScanFront.

! IMPORTANT

Before you submit the ScanFront for repairs, back up the setting information and then initialize the ScanFront. (See “Initializing ScanFront” on p. 10-13.)

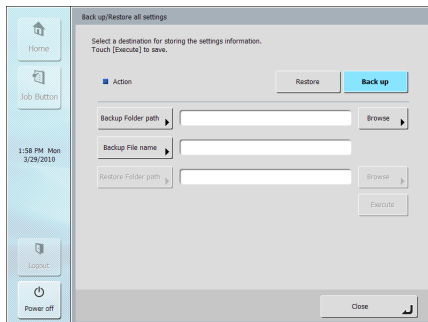

💡 Hint

- Scanner setting information can be backed up to a folder on a USB memory device if the device is inserted when [Backup / Restore all settings] is pressed.
- Backup / Restore all settings can also be configured from the [System Settings] screen (see p. 6-39) of the Web Menu (Administrator Mode).

❑ Select Login Type

Set the screen that appears when users log in. For details, see “Login Screen” on p. 5-4.

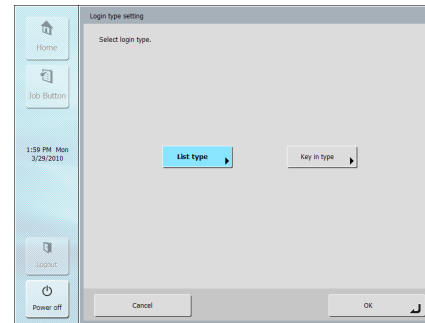

❑ Roller Counter Reset

Reset the counter after replacing the feed roller when the scanner no longer feeds properly. For details, see [“Replacing the Rollers and Document Holding Guide”](#) on p. 9-8.

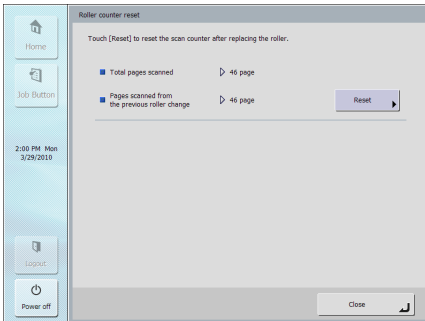

❑ Format ScanFront

Initialize the ScanFront clears all the settings registered to the ScanFront.

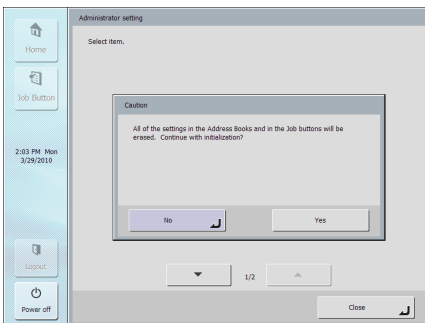

Initialize the ScanFront at the following times. For details, see [“Initializing ScanFront”](#) on p. 10-13.

When submitting the ScanFront for repairs

Before you submit the ScanFront for repairs, initialize the ScanFront to protect the saved user information.

When changing the operating environment

Delete all the user information registered on the ScanFront when, for instance, the users have changed because you have changed the installation location.

❑ Touch Panel Adjustment

You can adjust the touch panel when it does not operate as expected. For details, see [“Adjusting the Touch Panel”](#) on p. 10-11.

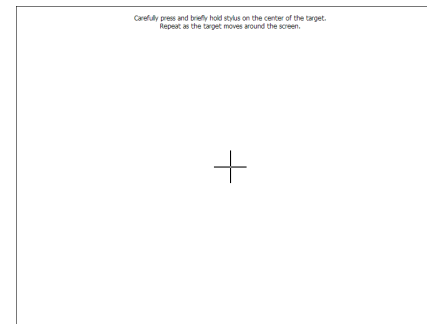

□ Display Language Setting

You can select the language displayed on touch panel. If you change this setting, restart the scanner.

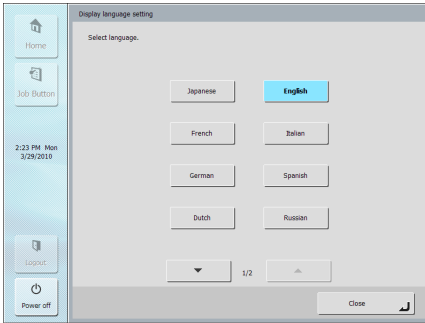

Hint

The display language setting can also be configured in [Language/Timezone] on the Web Menu (Administrator Mode) (see p. 6-30).

□ Network Test

Confirm whether communication is enabled between the ScanFront and other devices on the network. Enter the IP address of a device and press the [Execute] button to ping the specified IP address and confirm whether communication with the device is enabled.

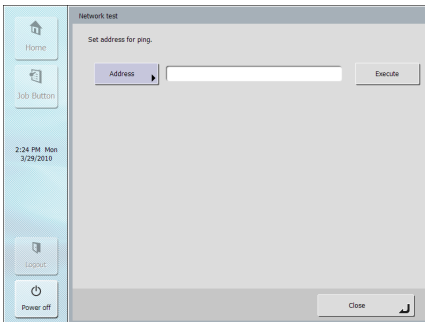

□ Switch to Web Application Mode (from Standard Mode of ScanFront 330 Only)

Switch to Web Application Mode when using the ScanFront 330 in Standard Mode.

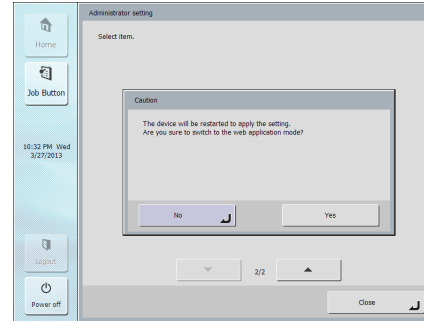

If you execute switching to Web Application Mode, ScanFront restarts and switches to Web Application Mode.

IMPORTANT

There is no data compatibility between Standard Mode and Web Application Mode. Before switching to Web Application Mode, back up the data as a safety precaution.

Chapter 4 ScanFront Service

1. About ScanFront Service.....	4-2
2. Installing ScanFront Service.....	4-3
System Requirements.....	4-3
Installation.....	4-3
3. ScanFront Service Setup.....	4-6
ScanFront Settings.....	4-6
Changing the Port Number Used for Communication	4-6

1. About ScanFront Service

ScanFront Service is software that supplements the network functions of the ScanFront. To use this software, install it on a computer connected to the same network as the ScanFront. (The computer on which ScanFront Service is installed will be herein referred to as the “ScanFront Service Server”.)

By configuring a ScanFront Service Server, you can send scanned images to locations on the network, such as the following, where direct transfer from the ScanFront is disabled.

- Destinations (folders on computers, printers, etc.)
located on a different network segment
- Printers on the network
- Shared folders on a computer that is specified by IP address
- Certain NAS (network-attached storage)

Scanned images from the ScanFront are sent via the ScanFront Service Server to the user specified destination. Up to 100 ScanFront scanners can be connected to a single ScanFront Service Server. However, only up to 15 ScanFront scanners can communicate with the ScanFront Service Server at any one time.

2. Installing ScanFront Service

□ System Requirements

Install ScanFront Service on a computer that is connected to the same network as the ScanFront, and that meets the following requirements.

Operating System

- Windows XP (32 bit/64 bit)
- Windows Server 2003 (32 bit/64 bit)
- Windows Vista (32 bit/64 bit)
- Windows Server 2008 (32 bit/64 bit)
- Windows Server 2008 R2
- Windows 7 (32 bit/64 bit)
- Windows 8 (32 bit/64 bit)
- Windows Server 2012 (64 bit)

□ Installation

1. Insert the application disc into the computer.

2. Start the ScanFront Service installer.

Use Windows Explorer, for example, to locate the installer in the following folder on the disc, and double-click the installer to start it.

Q: \ScanFrontService\setup.exe

("Q" is the letter assignment for the disc drive)

3. Click [Next].

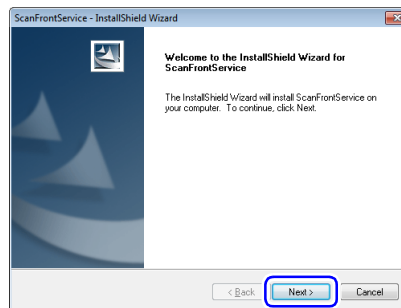

4. Select "I accept the terms of the license agreement" and then click [Next].

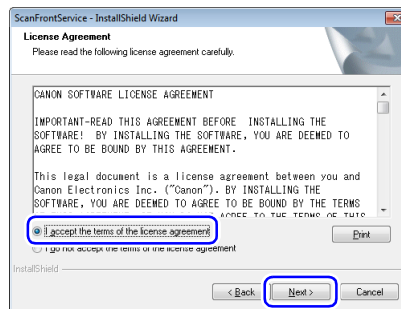

A screen for selecting the installation folder appears.

5. Click [Next].

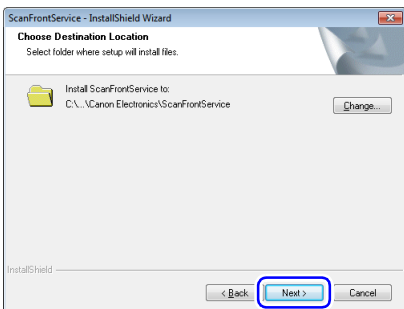

A screen for entering account information appears.

6. Enter the account information, and click [Next].

Use an administrator account on the computer on which the service will be installed.

- When entering a local account on the computer, include “.” at the beginning of the account name.
- If the computer is part of a domain and you are entering the domain account here, enter the account in one of the following formats.

Entry Format	Example
<NetBIOS name>\<domain user name>	area1\SFUser
<domain user name>@<FQDN domain name>	SFUser@area1.example.com

! **IMPORTANT**

Make sure to specify an administrator account. In addition, be aware that ScanFront Service will not function properly with accounts for which a password is not configured.

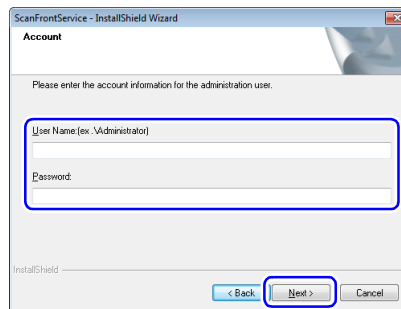

A screen for specifying whether to start the service immediately appears.

7. Specify [Execute now] if you want to start the service immediately, or [Execute later] if you want to start the service after restarting the computer, and then click [Next].

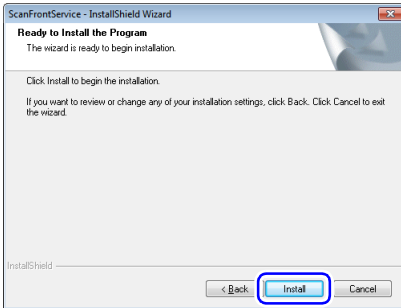

An install confirmation screen appears.

8. Click [Install].

Installation starts. When installation is complete, a screen indicating that installation is complete appears.

9. Click [Close].**Notes on Installing ScanFront Service**

- ScanFront Service creates log files during operations. As a result, these log files and the install destination folder will not be deleted, even after ScanFront Service is uninstalled.

3. ScanFront Service Setup

❑ ScanFront Settings

You must configure the following setting on the ScanFront to send scanned images using the ScanFront Service Server.

1. Log in to the Web Menu in Administrator Mode (see p. 6-5).
2. Click [Server Settings], and then [ScanFront Service Server].
3. Enter the host name (address) of the ScanFront Service Server.

Server Settings > ScanFront Service Server

ScanFront Service Server	
Host Name(Address) :	<input type="text"/>
Port number :	50000
Description of setting :	Start ScanFront Service before turning ON the device.

! IMPORTANT

- ScanFront Service uses port number 50000 to communicate with the ScanFront. Do not change the port number value from 50000.
- To use ScanFront Service, you must start the ScanFront Service Server before turning ON the ScanFront.

❑ Changing the Port Number Used for Communication

If port number 50000 is already in use, for example, and you want to use a different port number for communication with the ScanFront, modify the following ini file before specifying the new port number.

Folder:

C:\Program Files\Canon Electronics Inc\ScanFront Service\etc

File name:

ScanFront.ini

Area to be modified:

Replace the port number that appears in “port=50000” with the port number you want to use.

Settings for Environments with Firewalls

If a firewall is installed on the computer on which ScanFront Service is installed and the firewall is enabled, ScanFront Service will not run. In such cases, you must change the firewall settings and restrictively open the port used by ScanFront Service. For details, refer to the operating instructions for your firewall.

Chapter 5 Operating Procedures

1. Flow of Scanner Operations	5-2	7. Scanning Procedures.....	5-13
2. Turning the Power ON and OFF	5-3	Scanning From the Home Screen	5-13
Turning the Power ON.....	5-3	Scanning From the Job Button Screen.....	5-14
Turning the Power OFF	5-3	Address Selection Screen	5-15
3. Login Screen	5-4	USB Memory Screen.....	5-17
Login Screen Types.....	5-4	Print Settings Screen.....	5-18
When Using Server Authentication.....	5-4	Scanning.....	5-19
List Type Login	5-5	8. Registering and Editing Addresses	5-23
Key in Type Login.....	5-6	Registering a New Address	5-23
Fingerprint Authentication		Modifying an Address	5-25
(Only Available with the ScanFront 300P).....	5-7	Copying an Address	5-26
4. Screen Displayed after Login	5-8	9. Scan/Delivery Options.....	5-27
Home Screen.....	5-8	Scan Settings	5-28
Job Button Screen	5-8	File Formats.....	5-32
5. User Settings Screen	5-9	Security Settings for PDF Files.....	5-33
Change Password	5-9	Delivery Options	5-34
Fingerprint Registration	5-9		
6. Fingerprint Registration			
(Only Available with the ScanFront 300P).....	5-10		
Fingerprint Authentication.....	5-10		
Registering a Fingerprint	5-11		

1. Flow of Scanner Operations

The procedure and screen transitions for the process from turning the scanner ON, to sending an image file are as follows. For descriptions of the various settings, refer to the appropriate reference pages.

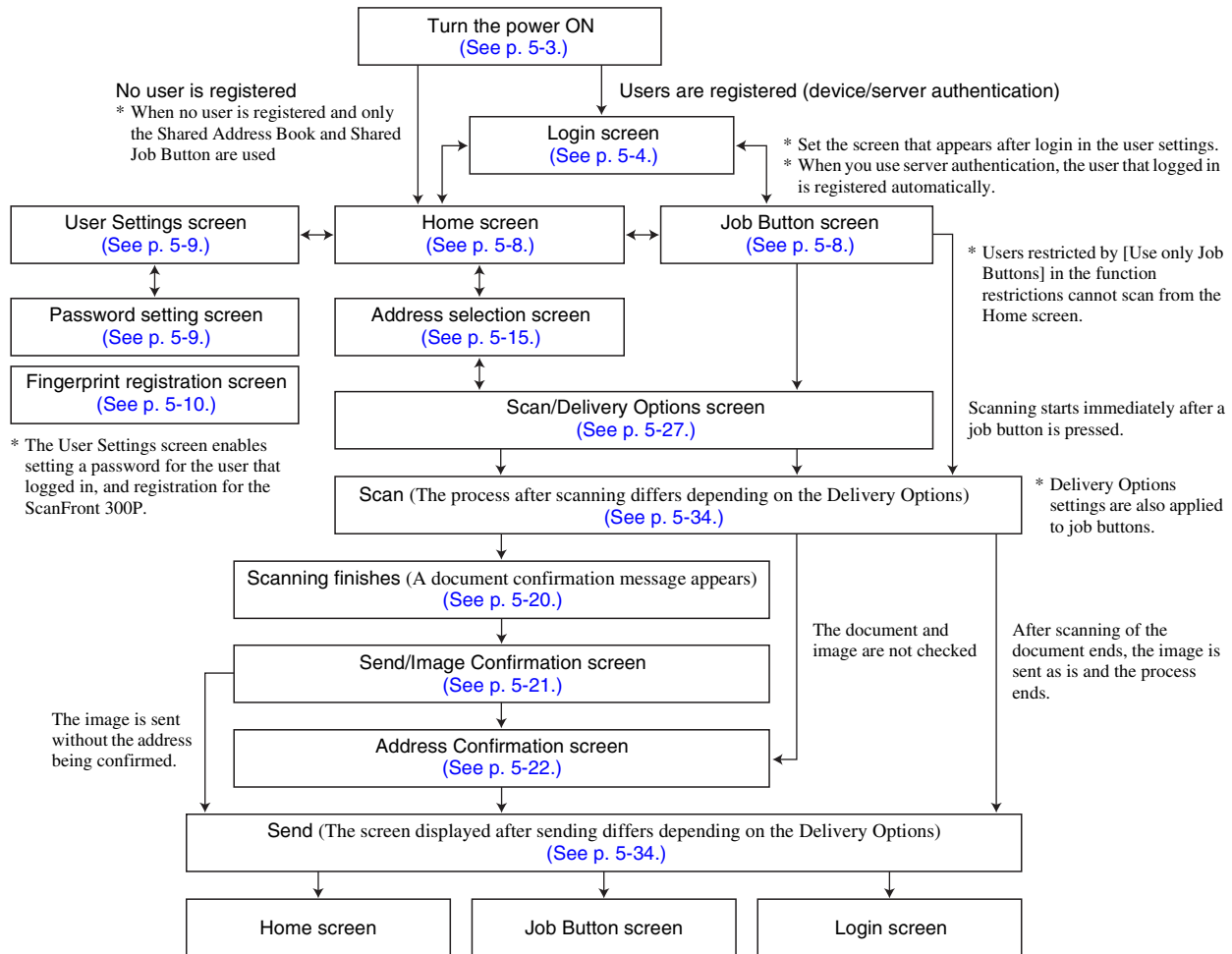

2. Turning the Power ON and OFF

Use the power switch to turn the scanner ON, and press the [Power off] button on the touch panel to turn it OFF.

□ Turning the Power ON

Press the power switch to turn the scanner ON. The power indicator lights, and the Home screen or the login screen appears.

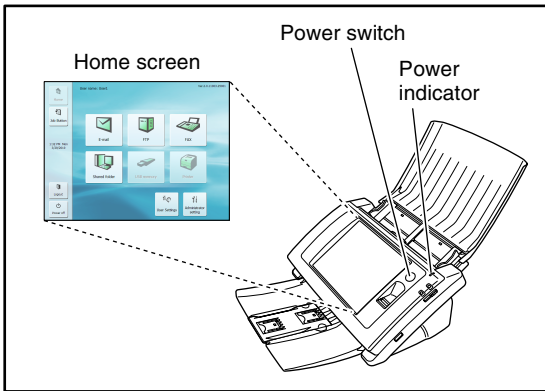

Hint

- It takes approximately 40 seconds for the Home screen to appear after the power switch is turned on.
- If users have been registered, the login screen appears. (See [“Login Screen”](#) on p. 5-4.)
- When the power indicator is lit but nothing appears on the touch panel, Display Off has activated to turn the panel display off. You can touch the panel to restore the display. (See [“Display Off”](#) on p. 6-31.)
- When the power indicator is flashing but nothing appears on the touch panel, the Low Power mode has activated to temporarily stop scanner operations. To switch out of Low Power mode, press the power switch or touch the touch panel. (See [“Low Power Mode”](#) on p. 6-31.)

□ Turning the Power OFF

Press the [Power off] button displayed at the bottom left of the panel to turn the scanner OFF.

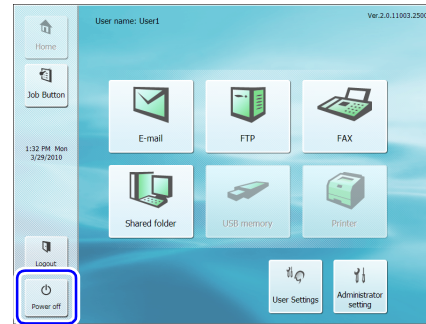

IMPORTANT

- When restarting the scanner, wait at least 5 seconds after turning the power OFF before turning it ON again.
- If the scanner stops responding, press and hold the power switch to shut down the system, and then press the power switch to turn the scanner ON again. In such cases, settings configured immediately before shutting down may be lost.

3. Login Screen

The login screen appears at the startup when the scanner is turned ON.

□ Login Screen Types

There are two types of login screen: a list type login screen for selecting from a list of registered users, and a key in type login screen for entering a user name and password.

List Type Login Screen

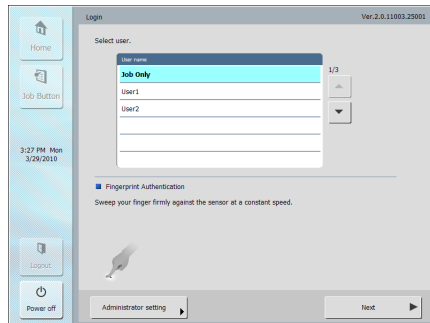

Key in Type Login Screen

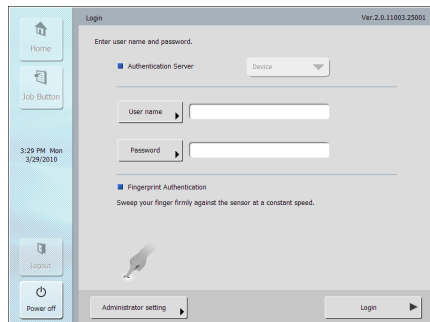

Hint

- Set the type of login screen from [Device Operation] of the Web menu (see p. 6-31) or [Login type setting] in the administrator settings of the ScanFront (see p. 3-10).
- Fingerprint authentication is enabled when you are using the ScanFront 300P. (See "Fingerprint Authentication (Only Available with the ScanFront 300P)" on p. 5-7.)

□ When Using Server Authentication

The login screen when you use server authentication is a key in type, and a list box is displayed for selecting Device Authentication and Server Authentication.

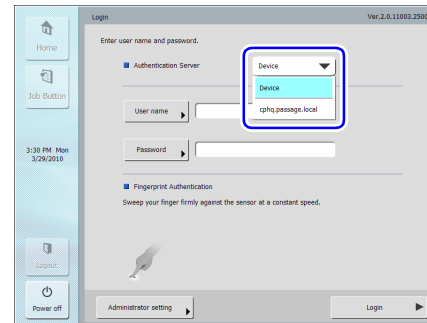

IMPORTANT

When you use server authentication to log in, you are registered as a new user of server authentication.

List Type Login

Use the procedure below to log in to the list type login screen.

1. Select the user to log in as from the list, and then press [Next].

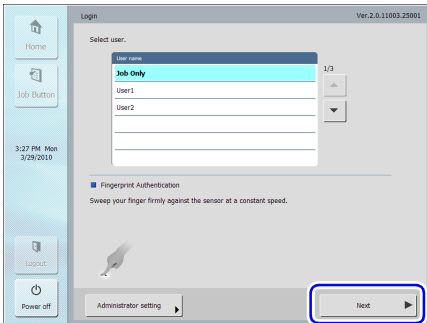

The password input screen appears.

2. Press [Password].

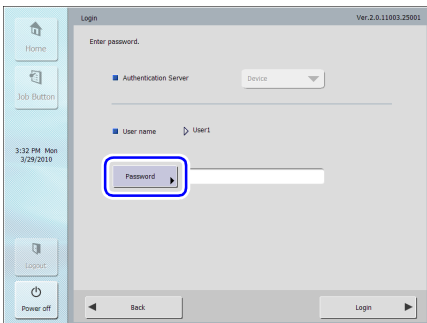

The keyboard screen appears.

3. Enter a password and then press [OK].

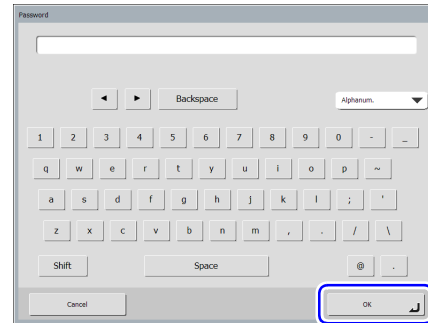

! IMPORTANT

Passwords are case-sensitive. Make sure to enter the password correctly.

4. Press [Login] to log in to the scanner.

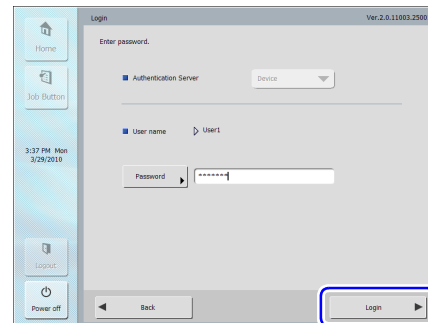

5. The Home screen (or Job Button screen) appears.

❑ Key in Type Login

In the key in type login screen, enter your user name and password to log in.

1. Press [User name] ([Password]).

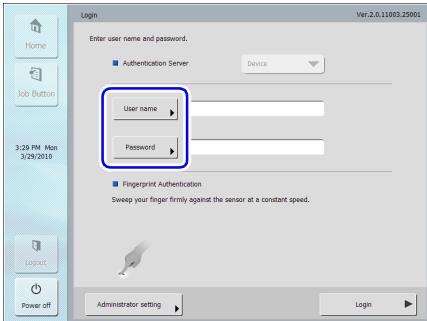

The keyboard screen appears.

2. Enter your user name (password) and then press [OK].

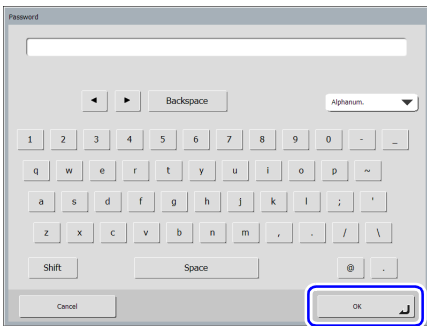

! IMPORTANT

- User names and passwords are case-sensitive. Make sure to enter the user and password registered during device authentication correctly.
- If you do not know the user name and password registered for server authentication, contact the domain server administrator.

3. Press [Login] to log in to the scanner.

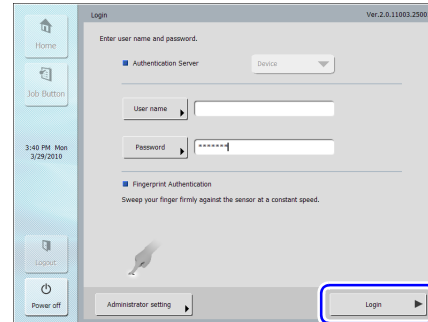

4. The Home screen (or Job Button screen) appears.

❑ Fingerprint Authentication (Only Available with the ScanFront 300P)

Use the procedure below for fingerprint authentication. For details on fingerprint registration, see “Fingerprint Registration (Only Available with the ScanFront 300P)” on p. 5-10.

1. Perform fingerprint authentication using the finger with the registered fingerprint.

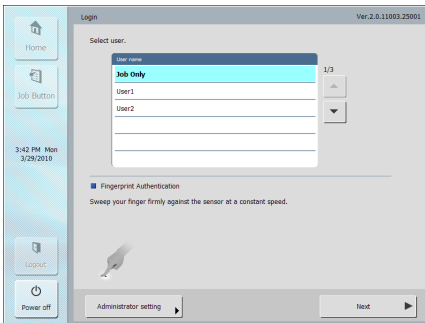

! IMPORTANT

Perform finger authentication by gently pressing the finger while slowly sweeping it at a constant speed to scan the fingerprint.

2. The Home screen (or Job Button screen) appears if the fingerprint is authenticated correctly.

💡 Hint

- When fingerprint authentication fails, the cause of the failure and a solution appear on the screen. Follow the instructions in the solution, and perform fingerprint authentication again.

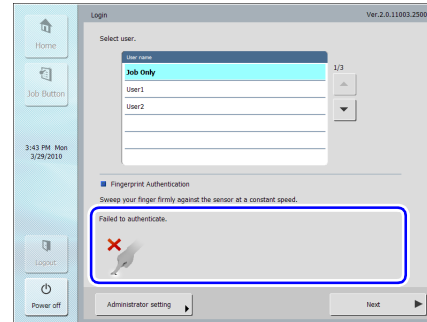

- If a user fingerprint is registered for server authentication, and the user password is changed on the server while the user is logged in via fingerprint authentication, the following message will appear on the screen. In this case, without using fingerprint authentication, enter your user name and changed password to log in, and then re-register your fingerprints.

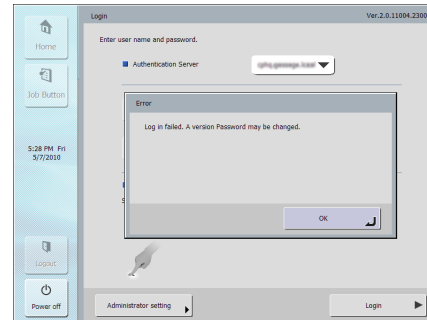

4. Screen Displayed after Login

You can set the screen (Home screen or Job Button screen) that is displayed after a user logs in. (See p. 6-7 and p. 8-4.)

□ Home Screen

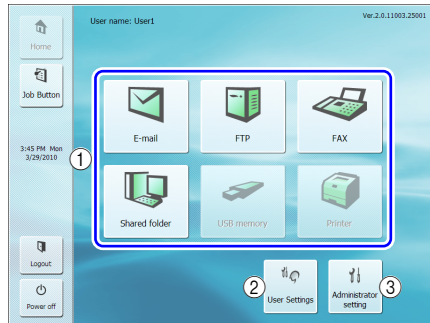

- 1 Select destination (E-mail, FTP, FAX, Shared folder, USB memory, and Printer) buttons
These buttons open an address selection screen. (See “Scanning Procedures” on p. 5-13.)

Hint

- The USB memory button is enabled when USB memory is inserted in a USB port.
 - [Printer] is enabled when the ScanFront is connected to a network environment that is running ScanFront Service.
- 2 [User settings] button
Enables setting of the user password and fingerprint registration (only with the ScanFront 300P). (See “User Settings Screen” on p. 5-9.)
 - 3 [Administrator setting] button
Opens the Administrator Settings screen. For details, see “Configuring Administrator Settings” on p. 3-8.

IMPORTANT

If a user whose use of the Home screen is restricted logs in, the Home screen is not available. For details, contact the administrator.

□ Job Button Screen

This screen enables you to select a job button to scan using the conditions registered to the job button, and then send the image file. (See “Scanning Procedures” on p. 5-13.)

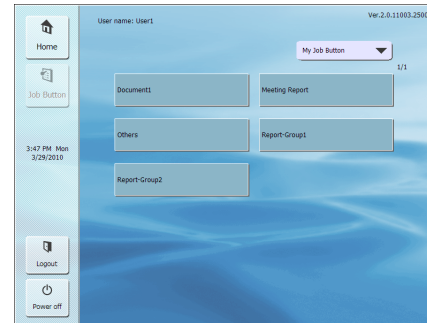

IMPORTANT

- The document is scanned immediately after you press the job button. Make sure to place your document before you press the job button. (See “Placing Documents” on p. 2-6.)
- Perform job button registration and editing via the Web menu.
- If you are unable to edit a job button, the editing of job buttons has been restricted by the ScanFront administrator. For details, contact the administrator.

5. User Settings Screen

The User Settings screen enables you to edit the user password and register a fingerprint (only available with the ScanFront 300P).

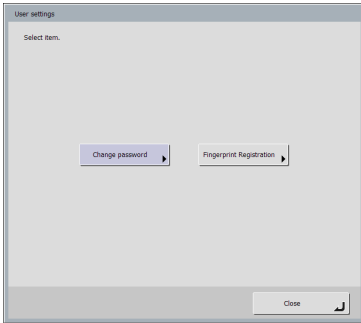

Change Password

You can register a new user password or change a user password registered via the Web menu.

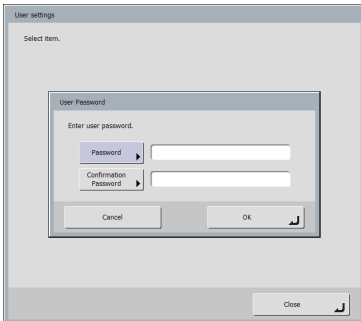

Hint

The old password does not need to be entered in order to change a password. The new password that you entered is registered.

Fingerprint Registration

Fingerprint registration is enabled when you are using the ScanFront 300P. For details on fingerprint registration, see [“Fingerprint Registration \(Only Available with the ScanFront 300P\)”](#) on p. 5-10.

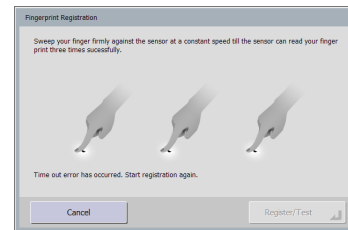

6. Fingerprint Registration (Only Available with the ScanFront 300P)

Fingerprint authentication is a function for registering the fingerprints of users that will log in when the device authentication or server authentication method is used, and enables users to log in by authenticating their fingerprints. When fingerprint authentication is used, there is no need to select a user in the list type login screen or enter a user name and password in the key in type login screen. For details on handling the fingerprint sensor, see “Fingerprint Sensor (ScanFront 300P)” on p. 2-11.

□ Fingerprint Authentication

- Follow the procedure below to use fingerprint registration and authentication.
 1. Align the first joint of a finger on the sensor and press the finger on the fingerprint sensor.
 2. Keep the finger pressed while slowly sliding it straight at a constant speed to scan the fingerprint.

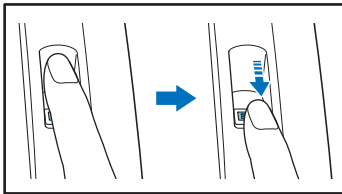

- Fingerprint authentication uses the unique information of fingerprints. The fingerprint authentication function may not work properly for a finger with a fingerprint that is worn down or has few distinguishable features.
- The same finger needs to be scanned three times to register the fingerprint.

- The authentication performance differs depending on the condition of the fingerprint when it is registered and when it is authenticated. The following conditions may cause an error in fingerprint authentication:
 - The finger is wet or sweaty
 - The finger is dirty
 - The grooves of the fingerprint are filled with sweat or oil
 - The finger is dry (dry skin)
 - Part of the fingerprint is missing because of, for example, a wound or burn injury
 - The fingerprint has worn thin
- Authentication performance may improve if the condition of the fingerprint is improved as a result of washing your hands or applying hand cream.
- Authentication may not be performed properly depending on the speed with which you slide your finger over the sensor. In this case, adjust the speed with which you slide your finger in accordance with the message that appears.
- Fingerprint authentication does not necessarily guarantee the authentication and verification of the identity of a person.

❑ Registering a Fingerprint

Register a fingerprint from the User Settings screen accessed from the Home screen.

! IMPORTANT

If the Home screen is not displayed, use of the Home screen has been restricted for the user by the ScanFront administrator. Confirm this with the administrator.

1. Press [User settings].

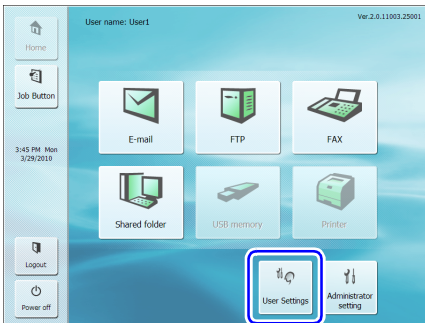

The User Settings screen appears.

2. Press [Fingerprint Registration].

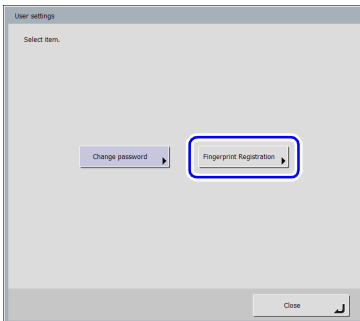

The Fingerprint Registration screen appears.

3. Scan your fingerprint.

Repeat scanning until the same fingerprint has been successfully scanned three times.

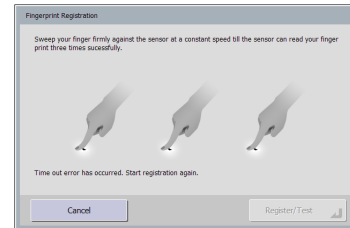

! IMPORTANT

- If any of the messages below appears, there was an error scanning the fingerprint. Try scanning your fingerprint again.
 - Failed to read fingerprint. Please try again.
 - Sweep speed was too fast. Please sweep more slowly.
 - Sweep speed was too slow. Please sweep more faster.
- If any of the messages below appears, start fingerprint registration again from the beginning.
 - Can not verify the fingerprint data. Start registration again.
 - Time out error has occurred. Start registration again.

4. After you have successfully scanned your fingerprint three times, press [Register/Test].

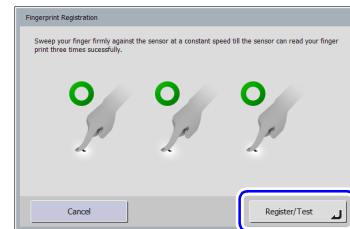

The Test Mode screen appears.

5. Perform an authentication test for the registered fingerprint by scanning your fingerprint.

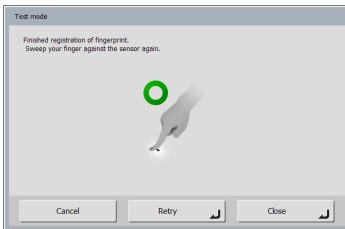

6. Press [Close] to end fingerprint registration.

! IMPORTANT

If you want to change the registered fingerprint, start registration again from the beginning.

7. Scanning Procedures

You can perform scanning from the Home screen or the Job Button screen.

□ Scanning From the Home Screen

Press a destination selection (E-mail, FTP, Fax, Shared folder, or USB memory) button to open an address selection screen and then select an address to send an image file.

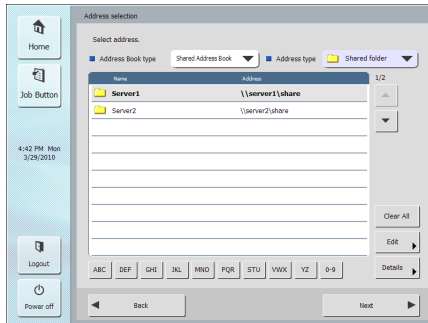

If you press the USB memory destination selection button, press [Downward] and specify the folder in the USB memory to which you want to save the image file.

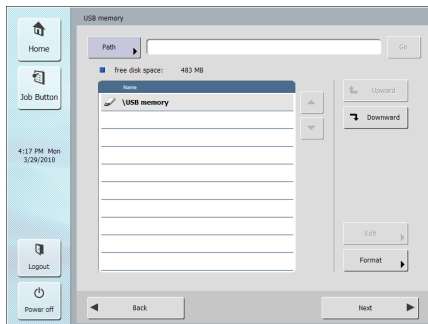

If you press the Printer destination selection button, configure the printer settings.

! IMPORTANT

If the network environment to which the ScanFront is connected is not running ScanFront Service, [Printer] is grayed out and cannot be selected.

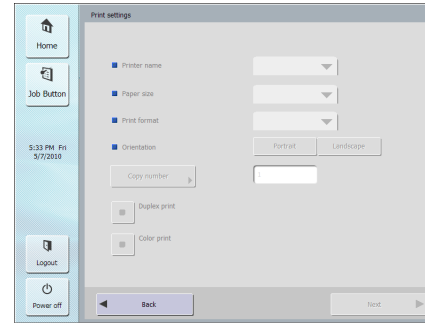

If you select an address and then press [Next], the Scan/Delivery Options screen appears. Set the scanning conditions and then start scanning.

❑ Scanning From the Job Button Screen

If you press a job button, the Scan/Delivery Options screen appears. Confirm the address and scanning settings registered to the job button and then start scanning. For details on the scanning procedure, read from the setting of scanning conditions in Step 5.

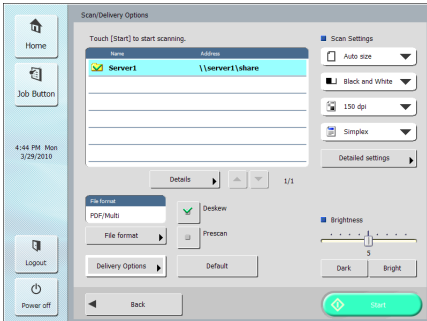

! IMPORTANT

- The settings screen display and the screen displayed after scanning differ depending on the job button settings. For details on the overall flow from configuring settings to sending an image file, see [“Flow of Scanner Operations”](#) on p. 5-2.
- Job buttons cannot be used to save image files to USB memory or send them to printers for printing.

❑ Address Selection Screen

From the address selection screen, you can select the address to send an image file and register addresses.

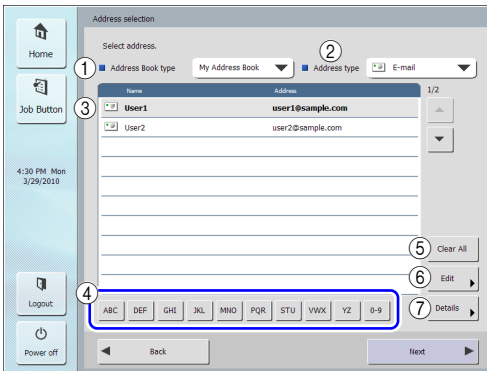

① Address Book type

Selects the address book type (Shared Address Book or My Address Book). If the address book server setting is enabled, [LDAP Address Book] is added.





② Address type

If you select the type of address (e-mail, fax, shared folder, FTP, and groups) to display in the address list, addresses of the selected type are displayed.





③ Address List

Displays registered addresses and enables you to select the address to send an image file.

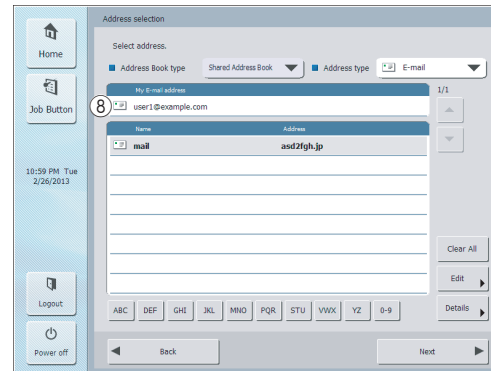
Hint

- The following icons are used to indicate the types of address.
 -  :E-mail
 -  :Shared folder
 -  :Fax
 -  :FTP
 -  :Group
- Pressing an address adds a checkmark (✔) to the icon and selects the address. Pressing a selected address again clears the selection.
- An address is not selected as an address if there is no checkmark added to the icon, even if the background of the address is colored and the address appears selected.



- Each time you press an e-mail or group icon, the send condition changes (To, Cc, Bcc).
 -  :To
 -  :Cc
 -  :Bcc
 -  :Selection cleared

④ Jump Keys

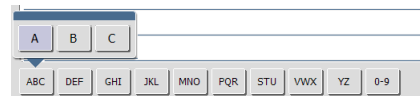

If there are many addresses and the address you want is not displayed in the address list, you can use these keys to specify a keyword to search for and display the address.

⑤ [Clear All] button

Clears all address selections.

⑥ [Edit] button

Enables you to register new addresses and edit addresses.

⑦ [Details] button

Displays detailed information for the address.

⑧ My E-mail address

If “E-mail to my mailbox” is enabled in the user settings of the Web menu, the mail address of the logged in user is displayed. (See “User Settings” on p. 6-7.)

When Sending to Fax Machines Directly Is Enabled

If you are logged in as a user that has the “Permit to send to FAX directly” enabled in the function restrictions in the Web menu (Administrator Mode), a fax can also be sent to an address that is not registered in the address book if you directly enter the fax number in the address selection screen. (See “Restricting User Functions” on p. 6-10.)

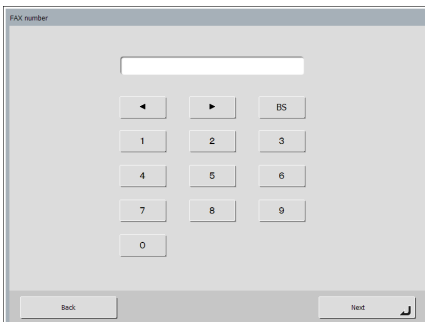
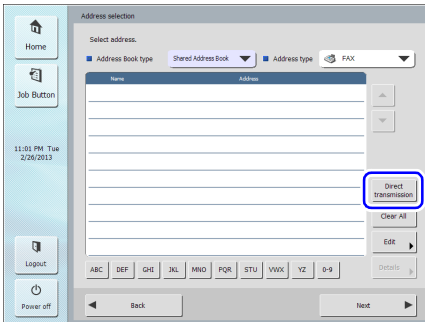

❑ USB Memory Screen

The USB Memory screen enables you to specify the folder in the USB memory to save the image file.

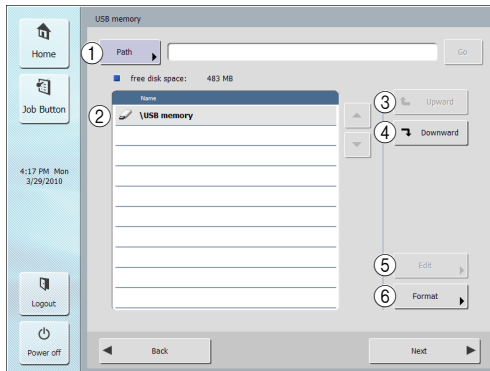

① Path

Enter the folder path of the USB memory. You can also press [Downward] to select a folder.

② USB Memory Display

Displays the inserted USB memory.

Hint

- If you insert two or more USB memory sticks, numbers are allocated to sticks from the second one onwards. For example, the first one that was inserted is displayed as “USB memory”, and the second one inserted is displayed as “USB memory 2”.

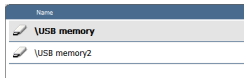

- If you want to insert or replace a USB memory stick while the USB memory screen is open, press the [Back] button to return to the Home screen, update the USB memory information, and then reopen the USB memory screen.

③ [Upward] button

Enables you to move to a higher level folder when a lower level folder is selected in the memory.

④ [Downward] button

Enables you to move to a lower level folder in the USB memory.

⑤ [Edit] button

Enables you to register new folders and edit folders.

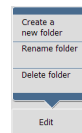

⑥ [Format] button

Enables you to format the USB memory.

Print Settings Screen

The print settings screen enables you to specify the printer, paper size, and other print settings.

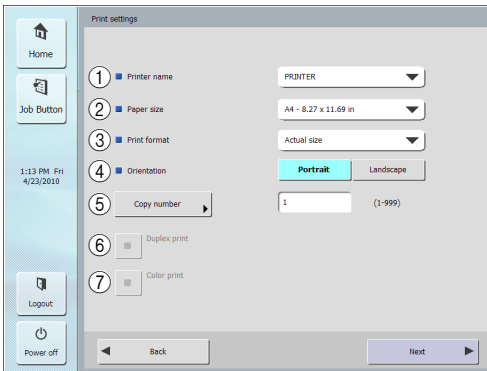

① Printer name

Select the printer that will be used to print the scanned images. Printers that are compatible with the ScanFront Service Server can be selected.

② Paper size

Select the paper size.

③ Print format

Specify the method in which the scanned image is scaled for printing.

- Actual size
Prints the scanned image in the same size as the original document.
- Fit to paper
Prints while expanding or reducing the scanned image to fit the paper size.
- Actual pixel
Prints while matching the resolution of the scanned image.

④ Orientation

Press [Portrait] or [Landscape] to specify the orientation for printing.

⑤ Copy number

Specify the number of copies to print.

⑥ Duplex print

When you want to perform duplex printing, light this button by pressing it.

⑦ Color print

When you want to perform color printing, light this button by pressing it.

! IMPORTANT

The print settings you can configure will vary depending on your printer. Settings and functions that are not supported by your printer cannot be configured in this screen.

❑ Scanning

This section describes the procedure for scanning. If you want to save the image file to USB memory, specify the folder in the USB memory to save the image file in Steps 2 to 4. (See “USB Memory Screen” on p. 5-17.)

1. Select a destination.

Press a destination button to select a destination.

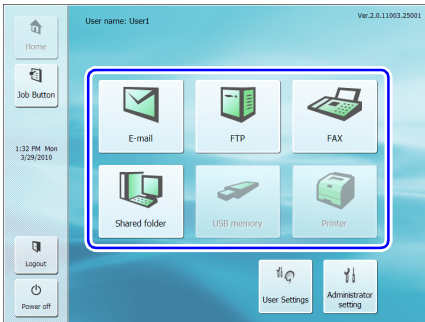

The address selection screen appears.

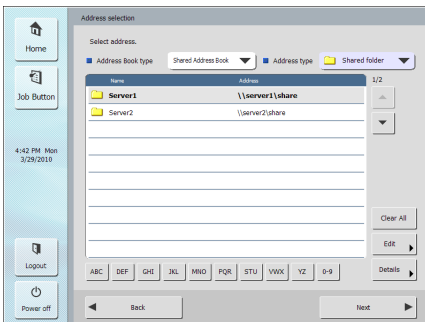

2. Use [Address Book type] and [Address type] to display the address to send the image file.

3. Press a displayed address to select it.

A checkmark (☑) is added to the icon for the selected address. Pressing a selected address again clears the selection.

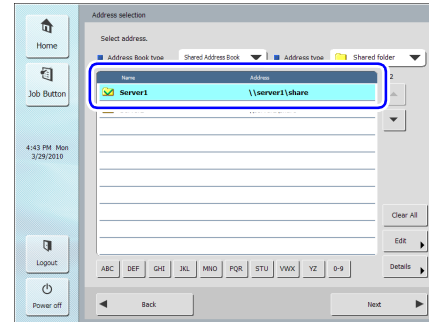

! IMPORTANT

An address is not selected as an address to send data to if there is no checkmark, even if the background is shaded.

4. Make sure the selected address has a checkmark and then press [Next].

💡 Hint

When a different type of address is selected, you can confirm the selected address by pressing [Selected address] in the Address type drop-down list.

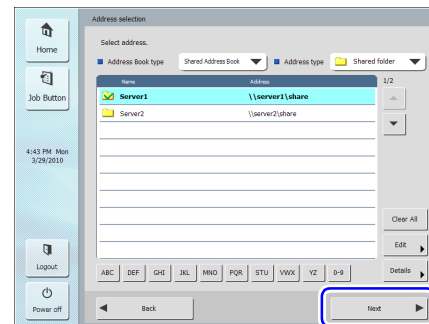

The Scan/Delivery Options screen appears.

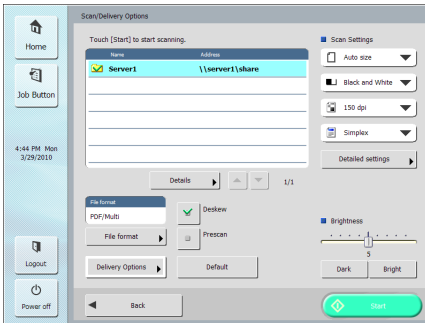

5. Set the scan conditions. (See “Scan/Delivery Options” on p. 5-27.)

! IMPORTANT

When you use a job button for scanning, the subsequent procedure varies as follows in accordance with the job button settings. For details, see “Registering New Job Buttons” on p. 6-21.

- If [When you select this Job Button] is set to [Skip Scan Setting Screen] and you press a job button, scanning is started without displaying the Scan/Delivery Options screen of Step 4.
- If [Send the files immediately after scanning] is set to [ON], scanning ends without displaying the continue to scan confirmation screen of Step 7 and then the address confirmation screen of Step 10 appears.
- If [Confirm addresses before sending] is set to [OFF], the image is sent without displaying the address confirmation screen of Step 10 and the operation ends.

6. Press [Start] to start scanning.
Scanning stops after the document has been scanned.

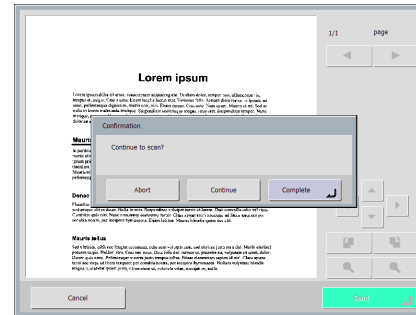

! IMPORTANT

- If [Send the files immediately after scanning] is set to [ON] in Delivery Options of the Scan/Delivery Options screen, scanning ends without displaying the continue to scan confirmation screen, and the address confirmation screen of Step 10 appears.
- When the confirmation message is left displayed and the scanner transitions to Low Power Mode, all of the data scanned up until that point is discarded. (See “Low Power Mode” on p. 6-31.)



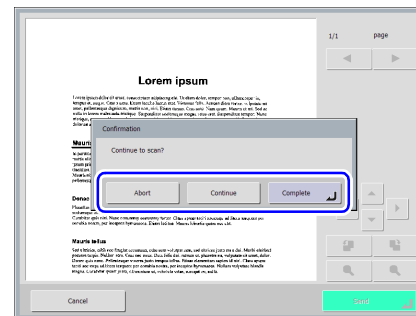



7. Check the document and go to the next step.

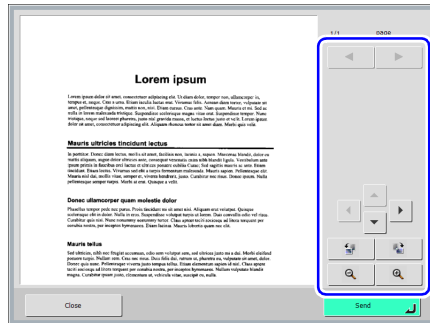

- Press [Abort] to cancel the scanned images and return to the Scan/Delivery Options screen.
- Press the [Continue] button to resume scanning.
- Press [Complete] to go to the Send screen.

8. Check the scanned images.



-  : Display the image of the next page.
-  : Display the image of the previous page.
-  : Move the viewing area around an image when an enlarged view of the image is shown.
-  : Rotate the image 90 degrees counterclockwise.
-  : Rotate the image 90 degrees clockwise.
-  : Enlarge the image.
-  : Reduce the image.

 **Hint**

When the preview image is enlarged, you can drag your finger on the image to scroll.

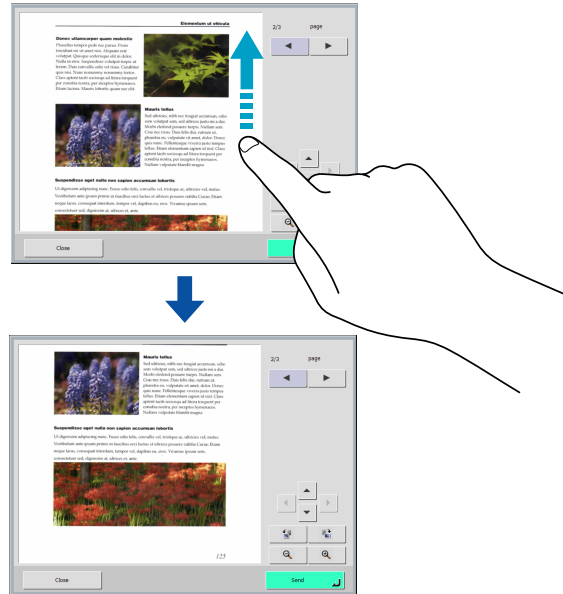

9. Press [Send].

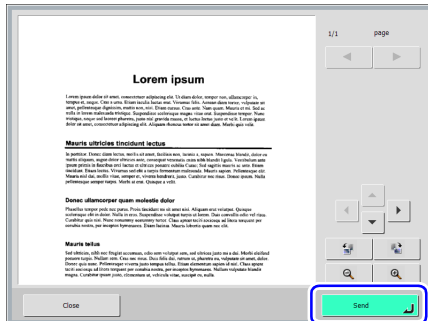

The address confirmation message appears.

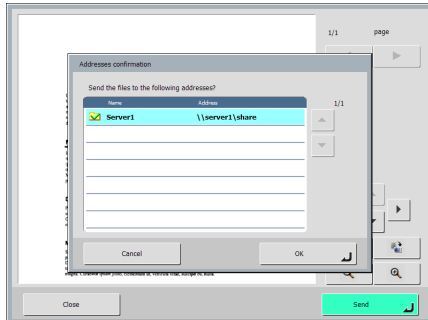

! IMPORTANT

If [Confirm addresses before sending] is set to [OFF] in Delivery Options of the Scan/Delivery Options screen, the image is sent without displaying the address confirmation screen and the operation ends.

10. Confirm the address and press [OK] to send the scanned image.

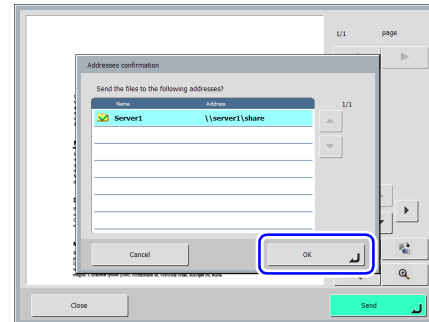

! IMPORTANT

If a send error message appears, check the address settings and send destination and try again.

11. Returns to the screen set for [Screen after sending] in Delivery Options of the Scan/Delivery Options screen.

8. Registering and Editing Addresses

If an address to which you want to send an image file is not registered in the address book or the information of a registered address has not been updated, use the procedure below to register a new address or modify an address in the address book.

□ Registering a New Address

1. Make selections for [Address Book type] and [Address type], press [Edit], and then press [New].

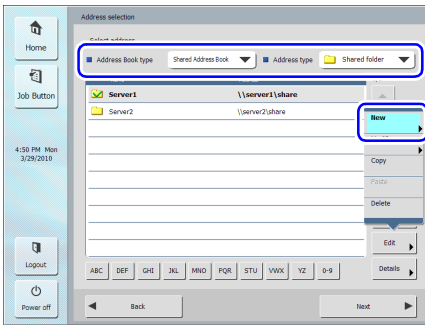

2. Register the address in accordance with the setting conditions of the address type.

E-mail Registration Screen

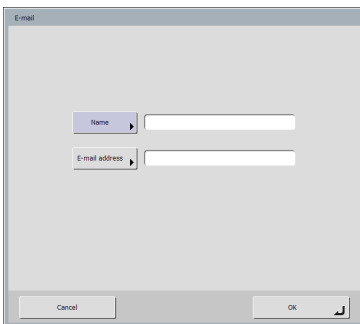

Hint

If the path of the sub-folder is unknown, use the procedure below to specify the sub-folder.

1. Enter the host name, user name, password, and domain, and

- Name
Enter the name to appear in the address book.
- E-mail address
Enter the sender's address for when image files are sent by e-mail.

Shared Folder Registration Screen

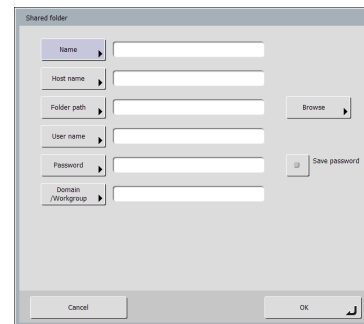

- Name
Enter the name to appear in the address book.
- Host name
Enter the name of the computer containing the publicly shared folder. When the ScanFront Service is running, you can enter the IP address instead of a host name.
- Folder path
Enter the name of the shared folder and the path of the sub-folder to register.

then press [Browse] to access the computer that is making the shared folder public.

2. Specify any sub-folder within the displayed folder.

3. Press [Downward] to move to a level lower than the selected folder, or press [Edit] and [Create a new folder] to create a new folder.
- **User name/Password**
Enter the user name and password of an account with write permission for the shared folder.
 - **Domain/Workgroup**
If the computer containing the shared folder is part of a domain, enter the domain name.
 - **Save password**
Save the entered password.

FTP Registration Screen

- **Name**
Enter the name to appear in the address book.
- **FTP server**
Enter the address of the FTP server.
- **Folder path**
Enter the path of the sub-folder when specifying a sub-folder on the FTP server.

Hint

If the path of the sub-folder is unknown, use the procedure below to specify the sub-folder.

1. Enter the server address, user name, and password, and click [Browse] to log in to the FTP server.
2. Specify any sub-folder at the level of the displayed folder and click [OK].

- **User name/Password**
Enter the user name and password for logging in to the FTP server.

IMPORTANT

Enter the user name and password of an account with write permission for the FTP server.

- **Port number**
Enter the port number. The standard port number is 21.
- **Save password**
Save the entered password.
- **Use passive mode**
Use passive mode for sending to the FTP server.

IMPORTANT

Use passive mode when normal communication with the FTP server cannot be established. However, be aware that communication may not be possible if the network is not functioning properly.

Fax Registration Screen

- **Name**
Enter the name to appear in the address book.
- **Fax number**
Enter the recipient fax number.

Group Registration Screen

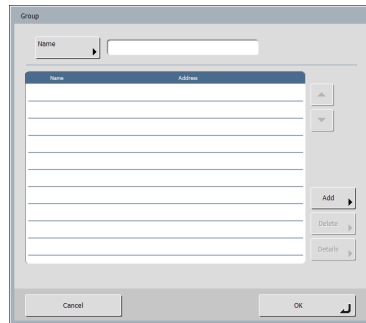

- **Name**
Enter the name that you want to appear in the address book.
- **[Add] button**
Select addresses to register to the group from [Address Book type] and [Address type]. The selected addresses are displayed in the list.

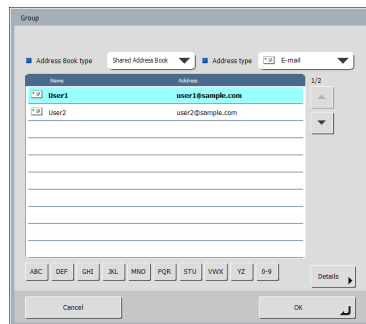

! IMPORTANT

- When you add shared folders to groups, do not add multiple shared folders with different access privileges to one group.
- Using a group to simultaneously send to shared servers and the like and multiple shared folders with different access privileges may result in a send error.

❑ Modifying an Address

Modify an address when there is a send error because the information of the transfer destination registered for the address is wrong or has been changed.

1. Select the type of the address to modify and press [Details].

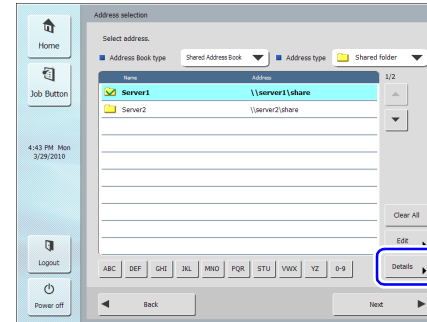

Detailed information for the address appears.

2. Check the detailed information for the selected address.
3. Press [Edit], and then press [Modify].

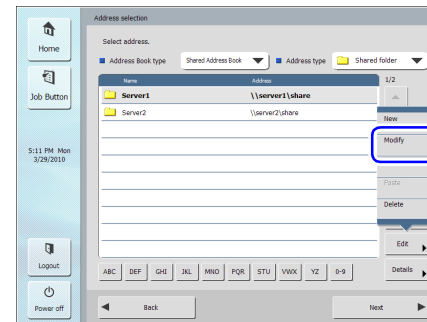

The edit screen for the address appears.

4. Modify the address.



Hint

For details on editing items, see “Registering a New Address” on p. 5-23.

□ Copying an Address

You can copy addresses between My Address Book and Shared Address Book.

1. Select the address book entry to copy.
2. Select the address, press [Edit], and then press [Copy].

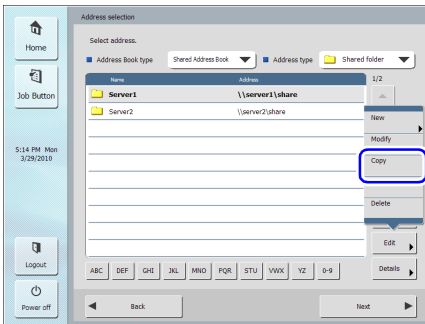

The selected address is copied to memory.

3. Select the address book type, press [Edit], and then press [Paste].

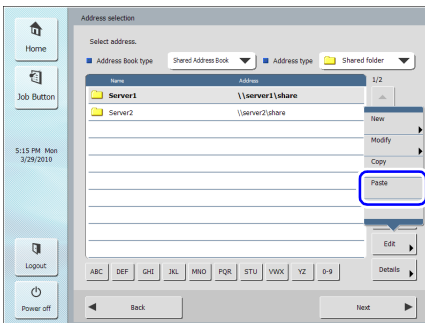

A confirmation message appears.

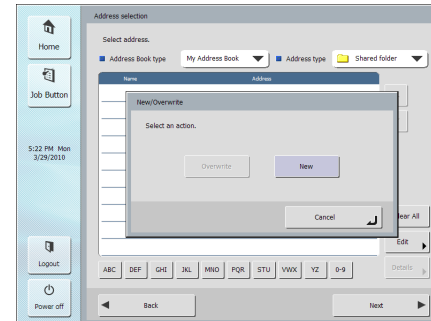

4. Press [New] and paste the address.



Hint

If the address book already has an address with the same name as the pasted one, the following message appears.

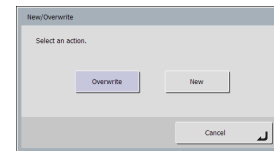

- If you select [New], an address with the same name is created in the address book.
- If you select [Overwrite], the existing address with the same name is overwritten.

9. Scan/Delivery Options

This section describes the scan settings and send settings for the scanner.

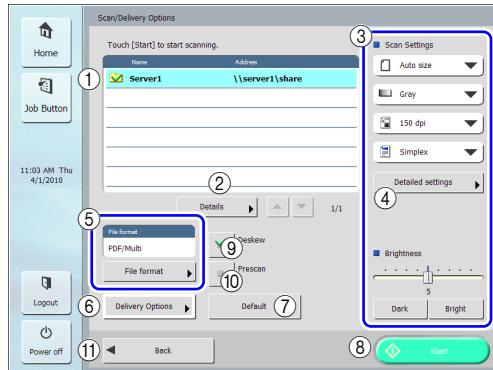

- ① **Address Display Area**
Displays the selection that you made on the address selection screen or the addresses registered to the job button.
- ② **Details**
Displays detailed information for the address with the colored background.
- ③ **Scan Settings**
Sets the scan conditions. (See “Scan Settings” on p. 5-28.)
- ④ **Detailed settings**
Configures detailed settings for scan conditions. (See “Detailed Settings” on p. 5-29.)
- ⑤ **File format**
Checks the displayed file format and press the [File format] button to configure the settings. (See “File Formats” on p. 5-32.)
- ⑥ **Delivery Options**
Sets the send conditions. (See “Delivery Options” on p. 5-34.)

- ⑦ **[Default] button**
Resets any modified settings to the default values of the scanner.
! IMPORTANT
If you press [Default] in the Scan/Delivery Options screen opened from a job button, the settings are reset not to the setting values registered to the job button, but to the default values of the scanner.
- ⑧ **[Start] button**
Starts scanning.
- ⑨ **[Deskew] button**
The scanner detects from the scanned image that the document was fed askew and then straightens the image.
- ⑩ **[Prescan] button**
When scanning starts, the first page of the document is scanned and then scanning stops. You can view the image of the first page to check and adjust the brightness and contrast before scanning the entire document.
💡 Hint
 - Scanning pauses after the first page of the document is scanned, and the image of the first page is displayed.
 - Use the displayed image to confirm and adjust the brightness and contrast. Press [Continue] to confirm the adjusted brightness and contrast for the first image and continue scanning.
- ⑪ **[Back] button**
Returns the display to the previous screen.

Scan Settings

The scan settings include basic condition settings (page size, mode, resolution, scanning side, and brightness) and detailed settings for scanning.

Basic Condition Settings

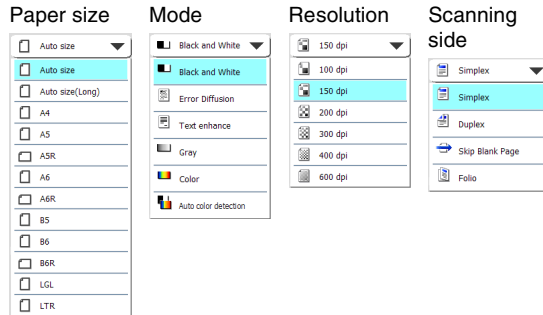

Paper Size

Select the size of the document you want to scan.

Hint

- Select [Auto size] to automatically detect the size of the scanned document.
- When scanning a long document, select [Auto size (Long)].

IMPORTANT

A resolution of [300 dpi] or more cannot be set when [Auto size (Long)] is selected.

Mode

Select the mode for scanning.

IMPORTANT

- The selection of modes is limited depending on the setting set for File Format (see p. 5-32).

TIFF

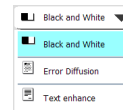

JPEG

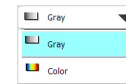

PDF

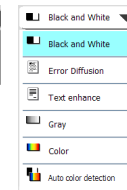

- When [Text enhance] is selected, [Bleed-through reduction] in the Detailed Settings screen is grayed out and cannot be selected.
- The [Auto Color Detection] function cannot be used simultaneously with the color drop-out or prescan function.
- The scanning speed may be reduced when the Auto Color Detection function is used.

Resolution

Select the resolution for scanning.

IMPORTANT

- A resolution of [300 dpi] or more cannot be set when [Auto size (Long)] is selected for [Page Size].
- A resolution of [400 dpi] or more cannot be set when [Folio] is selected for [Scanning Side].
- When you are using the scanner in Web Application Mode (ScanFront 330 only), [Resolution] cannot be set to [600 dpi] when [Mode] is set to [Color].

Scanning Side

Select the method for scanning the document (Simplex, Duplex, Skip Blank Page).

Hint

- The Skip Blank Page option scans both sides of a document and skips saving any image it determines to be a blank page.
- Selecting Skip Blank Page enables the skip blank page setting in the detailed settings. (See “Skip Blank Page” on p. 5-29.)
- When you select Folio, documents that are folded in half for which duplex scanning is performed can be scanned as a single image.

IMPORTANT

- The scanning speed may be reduced when [Skip Blank Page] is selected.

- A resolution of [400 dpi] or more cannot be set when [Folio] is selected. In addition, [Double feed detection by Ultrasonic] is grayed out and cannot be selected.

Brightness

Adjust the brightness to match the density of the document.



Hint

When you want to scan both sides of a document that has front and back sides of different densities, you can change the settings for the brightness of the front side and back side separately in the detailed settings and then perform scanning.

Detailed Settings

Press the [Detailed settings] button to open the Detailed Settings screen.

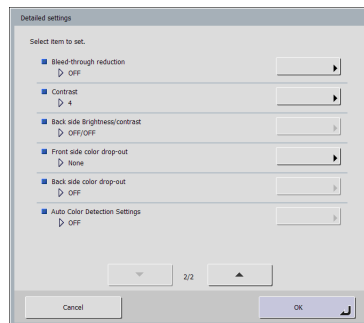
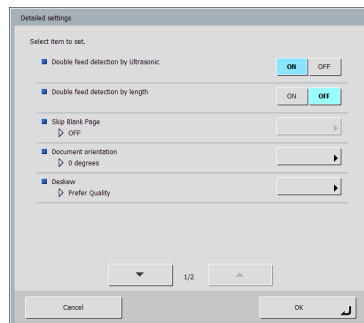

Double feed detection by Ultrasonic (Only Available with the ScanFront 300P/330)

The scanner uses an ultrasonic sensor to detect when two or more documents are fed together, and stops feeding when a double feed is detected.

! IMPORTANT

- This method is effective when documents overlap by 1.97" (50 mm) or more. It does not function if only a slight portion of the document is overlapping.
- When using the ScanFront 300, the [Double feed detection by Ultrasonic] setting is set to [OFF].
- When [Scanning Side] is set to [Folio], [Double feed detection by Ultrasonic] is grayed out and cannot be selected.

Double feed detection by length

The scanner detects by document length when two or more documents are fed together, and stops feeding when a double feed is detected.

! IMPORTANT

- Using the length of the first page of the document as a reference, the scanner determines a double feed when it detects a document with a length at least 1.38" (35 mm) longer or shorter than the reference length.
- Set [Double feed detection by length] to [OFF] when scanning a document that contains pages of different lengths.

Skip Blank Page

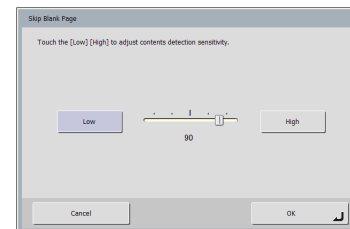

When [Skip Blank Page] is selected in the scanning side settings, this setting is enabled, and you can adjust the sensitivity level for skipping blank pages.

Hint

- The initial value for the Skip Blank Page option is set to “90.”
- As you lower the value from the default setting, pages of the document with text become more likely to be skipped as well.
- As you raise the value from the default setting, pages of the document that are blank become less likely to be skipped.

IMPORTANT

- As you lower the Skip Blank Page value from the default setting, it is then set so that pages of the document with text are more likely to be skipped.
- As you raise the Skip Blank Page value from the default setting, it is then set so that blank pages of the document are less likely to be skipped.

Document orientation

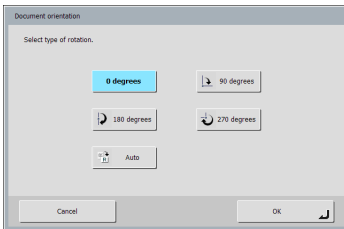

Rotates the scanned image a specified amount.

Hint

If you select [Auto], the orientation of text within the document is detected and the image is rotated so that the orientation of the text is correct.

IMPORTANT

The scanning speed may be reduced when [Auto] is selected.

Deskew

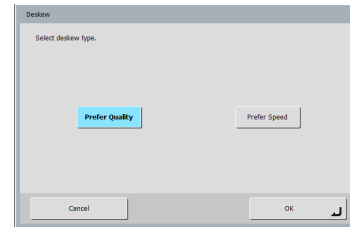

The scanner detects from the scanned image that the document was fed askew and then straightens the image.

• Prefer Quality

Image processing is performed to minimize the loss of quality of an image that has deteriorated as result of deskewing.

• Prefer Speed

The image deteriorates slightly as a result of deskewing.

IMPORTANT

If you select [Prefer Quality], the scanning speed is reduced. If you are scanning a large number of pages, select [Prefer Speed] to prevent a decrease in scanning speed.

Bleed-through reduction

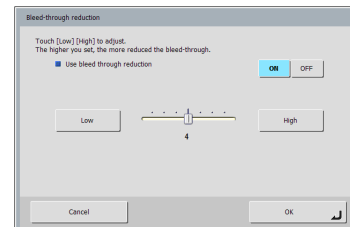

Eliminates bleed-through images, in which images on the reverse side of a scanned document appear on the scanned page, such as when scanning thin documents with text or images on both sides.

IMPORTANT

Bleed-through reduction cannot be set when the [Text enhance] mode is selected.

**Hint**

When using bleed-through reduction, adjust the bleed-through reduction level to match the type of document.

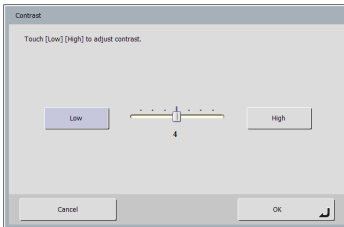
Contrast

Adjust the contrast for the images to scan.

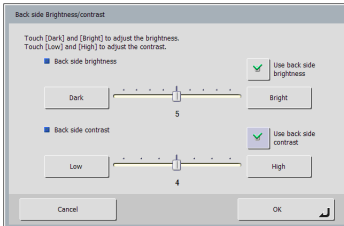
Back side Brightness/contrast

This is enabled when you scan both sides of a document and should be used when the document has front and back sides of different density. Select [Use back side brightness (contrast)] to change the settings for the brightness and contrast of the front and back sides of the document.

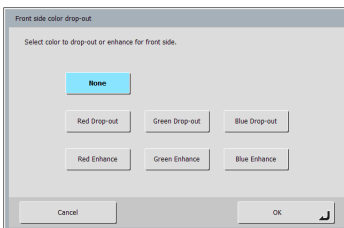
Front side (Back side) color drop-out

The color drop-out function has a “drop-out” effect that leaves out a specified color (red, blue, or green) while scanning, and a “color enhancement” effect that emphasizes a specified color. You can set each of these effects for the front side and back side.

! IMPORTANT

The color drop-out settings are disabled when the scanning mode is set to [Color].

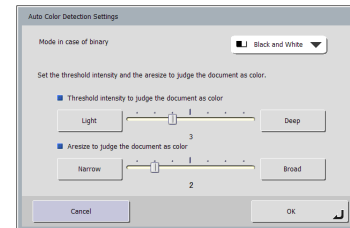
Auto Color Detection Settings

This is enabled when Auto Color Detection is selected, and allows you to configure the following detection settings for determining whether to scan a document in color or black and white.

- **Mode in case of binary**
Specify the scanning mode to use when a black and white document is detected.
- **Threshold intensity to judge the document as color**
Adjust the sensitivity to colors in a document.
- **Aresize to judge the document as color**
Specify the ratio of colored regions in a document.

! IMPORTANT

- The [Auto Color Detection] function cannot be used simultaneously with the color drop-out or prescan function.
- The scanning speed may be reduced when the Auto Color Detection function is used.

File Formats

You can select from the three available file formats TIFF, JPEG, and PDF, and the modes available for scanning vary, depending on the file format setting. (See “Mode” on p. 5-28.)

TIFF format

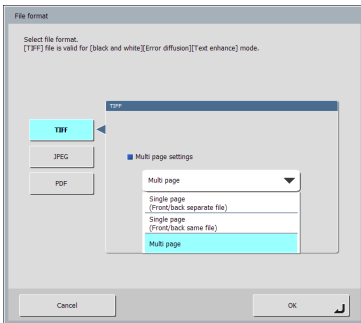

Select [Single page (Front/back separate file)] to save each side of each page as a separate image file, [Single page (Front/back same file)] to save each page as a separate image file, or [Multi page] to save one image file containing multiple pages when scanning multiple pages.

JPEG format

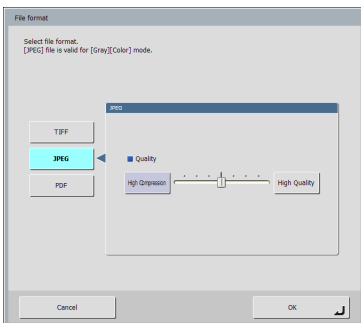

Select the compression rate for JPEG compression.

PDF format

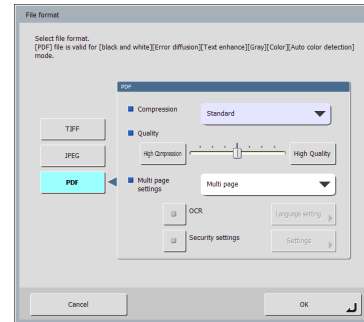

Configure the following settings for saving in PDF format.

- **Compression**
Select the compression method.
- **Quality**
Adjust the quality for the specified compression method.
- **Multi page settings**
Select [Single page (Front/back separate file)] to save each side of each page as a separate image file, [Single page (Front/back same file)] to save each page as a separate image file, or [Multi page] to save one image file containing multiple pages when scanning multiple pages.
- **OCR (Character Recognition)**
If OCR is set to On, character recognition is performed for the text within the scanned document, and the text is embedded in the PDF file as text information. The [Language setting] button enables you to select the language for character recognition.
- **Security settings**
If you set encryption to On and then press the [Settings] button, the Security settings screen appears, and you can configure the security settings for the PDF file. For details, see “Security Settings for PDF Files” on p. 5-33.

❑ Security Settings for PDF Files

Apply security to the PDF file.

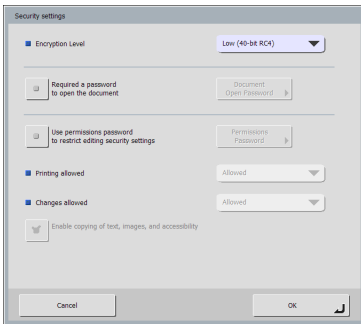

Encryption Level

High (128-bit RC4) and low (40-bit RC4) level settings are available.

! IMPORTANT

Using the High (128-bit RC4) level setting is recommended. The Low (40-bit RC4) level setting provides less security.

Requires a password to open the document

Viewing of the document is restricted by a password.

! IMPORTANT

Take care not to forget the password once it is set. If you forget the password, the document can no longer be opened.

Use permissions password to restrict editing security settings

The following settings are restricted by the permissions password.

- **Printing allowed**
This permits printing of the PDF file with a printer.
- **Changes allowed**
This permits editing of the PDF file; for example, adding and deleting pages.
- **Enable copying of text, images, and accessibility.**
This enables the copying of text information embedded with OCR software and reading of the PDF file with voice software.

! IMPORTANT

- Password protection is recommended when the permissions of the PDF file are restricted.
- You can change the permissions and cancel password protection for a password protected PDF file in an application capable of editing PDF files such as Adobe Acrobat.

□ Delivery Options

E-mail settings (subject, message)

Set the subject and message for sending via e-mail.

File name

Specify a name for the image file to be sent.

Auto file name

The scanner adds 17 digits that indicate the date and time to the file name of the image to be sent.

Ex.) May 14, 2013, 3:40:30 p.m.

yyyyymmdd: File name + 20130514154030123

mmddyyyy: File name + 05142013154030123

ddmmyyyy: File name + 14052013154030123

* The last three digits indicate the number of milliseconds.

When custom file name settings are configured in the Web Menu, you can select [Custom] to add the custom file name to the file name of the scanned image (see p. 6-8).

! IMPORTANT

- Make sure you set either [File name] or [Auto file name]. A message appears if you do not enter a file name and then set [Auto file name] to [None].
- If you select [Single page] of TIFF format, or JPEG format, a 4-digit sequential number starting with "0001" is added automatically to the end of file names.
- The following characters cannot be used to set the custom file name:
/ : ? * " < > |

Action when the same named file exists

Set the action to perform when there is already a file of the same name at the destination.

- Display a message
Display a message to confirm overwriting of the file.
- Abort sending
Cancel sending.
- Overwrite the file
Overwrite the file at the destination.

Send the files immediately after scanning

Send images without checking them when scanning completes.

Confirm addresses before sending

Confirm the addresses before sending images when scanning completes.

Screen after sending

Select the screen to display after sending images.

- **Home screen (Job Button screen)**

Redisplay the Home screen (Job Button screen) after sending images.

 **IMPORTANT**

- The [Screen after Login] setting that is set via the Web menu by the user applies to the Home screen (Job Button screen) setting.
- The Job Button screen is displayed for a user for which use of the Home screen is restricted by the ScanFront administrator.
- **Logout**
The user is logged out after sending images.
- **Select screen after sending**
A dialog box for selecting the screen after sending images is displayed.

 **Hint**

When no user is registered, the Logout option does not appear.

Send index file

Specify whether to send index files (metadata) with images.

When sending index files, enter an index string.

Index files are created according to the settings configured in the Web Menu ([see p. 6-9](#)).

 **IMPORTANT**

The following characters cannot be used in strings contained in the index file:

& " ' < >

Chapter 6 Web Menu (Administrator Mode)

1. Web Menu Overview	6-2	7. Server Settings.....	6-33
2. Logging In to the Web Menu	6-5	E-mail Server/Fax Settings.....	6-34
3. User Administration	6-6	Authentication Server.....	6-35
Registering New Users.....	6-7	Address Book Server.....	6-36
Restricting User Functions	6-10	FTP server.....	6-37
Editing Users	6-11	NTP Server.....	6-37
Exporting and Importing Users.....	6-13	ScanFront Service Server	6-37
4. Address Book Settings	6-14	Certificates.....	6-37
Registering New Addresses	6-15	8. System Settings	6-39
Copying Addresses	6-18	Backup and Restore.....	6-40
Exporting and Importing Address Books	6-18	Module Version Information/Update	6-41
5. Job Button Settings	6-20	Log Settings.....	6-42
Registering New Job Buttons	6-21	Screenshot	6-43
Scan Settings Overview	6-22		
Copying Job Buttons	6-26		
Editing Jobs.....	6-27		
Exporting and Importing Job Buttons	6-27		
6. Device Configuration	6-29		
Network Setting	6-30		
Language/Timezone.....	6-30		
Device Operation.....	6-31		
Login Options	6-31		
Administrator Settings	6-32		

1. Web Menu Overview

The Web Menu function enables you to access and configure the scanner from the Web browser of a remote computer. It can be used to perform tasks such as user registration, basic network communication settings, and job button registration, as well as making scan settings. (See “Web Menu (Administrator Mode)” on p. 3-6.)

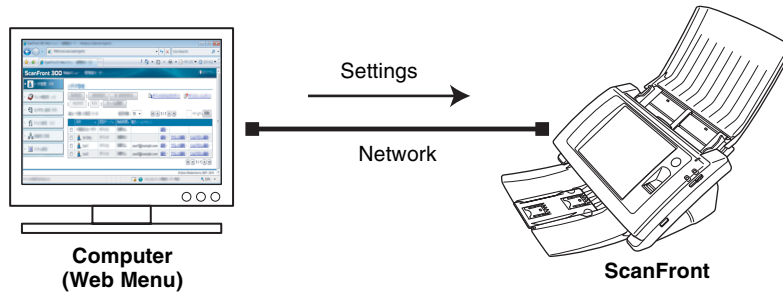

! IMPORTANT

- For a Web browser, use Microsoft Internet Explorer 6.0 or later or Firefox 3.5 or later.
- In some cases, settings cannot be changed from the Web Menu when the ScanFront administrator or another user is logged in to the scanner.
- Use the device name or IP address assigned to the scanner as the URL for logging in to the Web Menu. (See “Logging In to the Web Menu” on p. 6-5.)
- When you open the Web Menu using Internet Explorer 7 or later, an SSL-certificate warning will appear. However, you can proceed and open the Web Menu safely.

💡 Hint

In Web Application Mode (ScanFront 330 only), there is no Web Menu function.

The Web Menu features an Administrator Mode for configuring administrator settings and a User Mode for user access, from which the following settings can be configured.

Administrator Mode

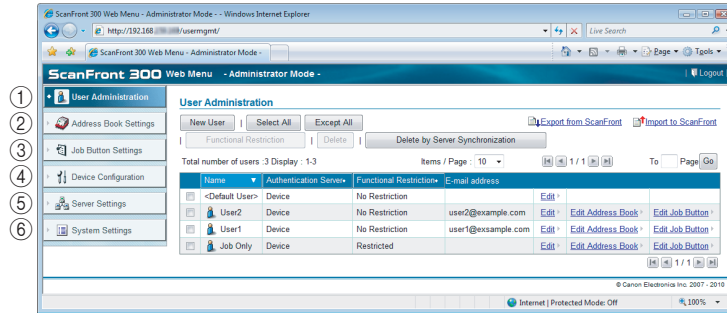

- ① **User Administration** (See “User Administration” on p. 6-6.)
Use to register and manage users and to restrict the functions available to users.
- ② **Address Book Settings** (See “Address Book Settings” on p. 6-14.)
Use to register and manage entries in the Shared Address Book available to all users.
- ③ **Job Button Settings** (See “Job Button Settings” on p. 6-20.)
Use to register and manage the Shared Job Button available to all users.
- ④ **Device Configuration** (See “Device Configuration” on p. 6-29.)
Use to configure the scanner.

- ⑤ **Server Settings** (See “Server Settings” on p. 6-33.)
Use to configure mail server settings for sending e-mail from the scanner, settings for using an authentication server compatible with a directory service, settings for using an address book server compatible with LDAP, settings for using a function that transfers a scan result log during transfer to the FTP server, and settings for using the NTP server, and import the root certificate of the LDAP server.
- ⑥ **System Settings** (See “System Settings” on p. 6-39.)
Use to configure the following settings and perform the following operations for managing the ScanFront.
 - Backing up and restoring all ScanFront settings
 - Checking the ScanFront version and upgrading modules
 - Managing ScanFront logs
 - Saving a screenshot of the ScanFront screen

User Mode

For details on configuring the User Mode settings, see [Chapter 8 “Web Menu \(User Mode\)”](#).

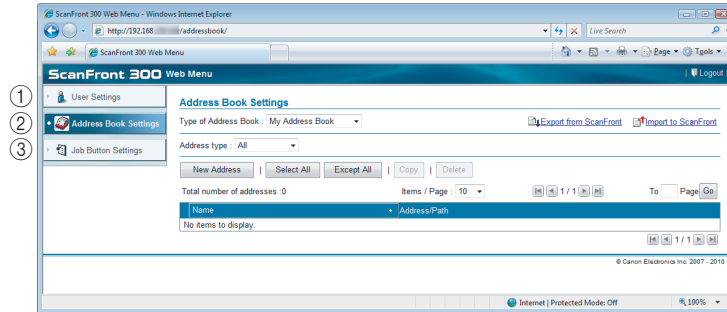

- ① **User Settings** (See “User Settings” on p. 8-4.)
Use to change the user settings.
- ② **Address Book Settings** (See “Address Book Settings” on p. 8-9.)
Use to register and manage entries in the Shared Address Book, and the My Address Book provided for each user.
- ③ **Job Button Settings** (See “Job Button Settings” on p. 8-16.)
Use to register and manage the Shared Job Button, and the My Job Button provided for each user.

2. Logging In to the Web Menu

You can log in to the Web Menu using the following procedure.

! IMPORTANT

Use the device name or the IP address assigned to the scanner as the URL for accessing the Web Menu. For details on the device name and the IP address, see “Configuring Administrator Settings” on p. 3-8.

1. Turn the scanner ON.
2. Log in to [Administrator setting], open the network settings, and confirm the device name or the IP address. (See “Configuring Administrator Settings” on p. 3-8.)

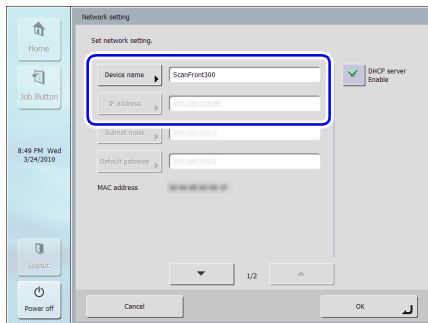

3. Launch the Web browser on the computer.
4. Enter the device name or the IP address as the URL to open the Web Menu.
Ex.) `http://scanfront300` when the device name is ScanFront300, and `http://172.19.xxx.xxx` for the IP address.

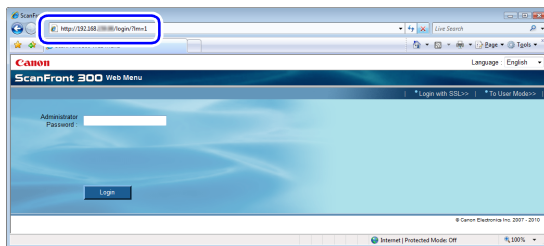

💡 Hint

If the Web Menu does not appear in the desired language, select the desired language in the [Language] box to switch the Web Menu display.

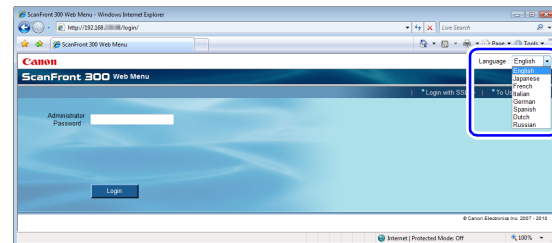

5. Click [Login] to log in to the Web Menu (Administrator Mode).

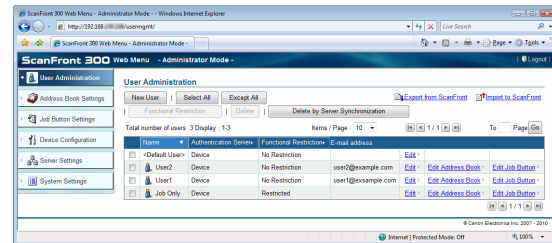

! IMPORTANT

- If a password has been set under [Administrator setting] on the scanner, enter the Administrator password to log in.
- Passwords are case-sensitive. Make sure to enter the password correctly.

3. User Administration

From the User Administration screen, you can register and manage users and restrict the functions available to users.

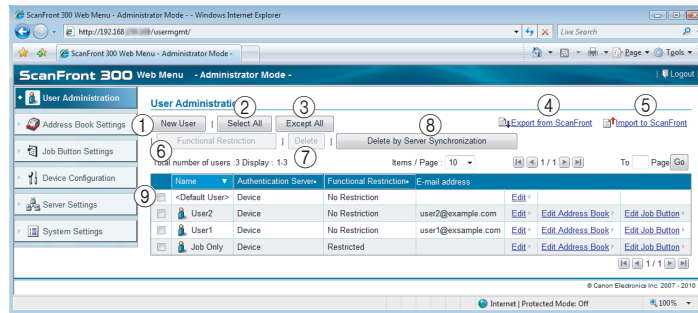

- ① [New User] button
Registers a new user. (See “Registering New Users” on p. 6-7.)
- ② [Select All] button
Selects all of the displayed users.
- ③ [Except All] button
Deselects all of the displayed users.
- ④ Export from ScanFront
Exports the user data as a file. (See “Exporting and Importing Users” on p. 6-13.)
- ⑤ Import to ScanFront
Imports a previously exported user data file. (See “Exporting and Importing Users” on p. 6-13.)
- ⑥ [Functional Restriction] button
Restricts the functions available to the selected user. Only enabled when a user is selected. (See “Restricting User Functions” on p. 6-10.)
- ⑦ [Delete] button
Deletes the selected user. Only enabled when a user is selected. However, <Default User> cannot be deleted.
- ⑧ [Delete by Server synchronization] button
If the authentication server is enabled (see “Server Settings” on p. 6-33), this deletes users that are not

registered on the authentication server from the user list.

- ⑨ User List
 - Check box: Select this check box to select a user. If the check boxes of multiple users are selected, you can set function restrictions or perform the delete operation for all selected users simultaneously.
 - Name: Displays the names of registered users. <Default User> is the default setting when registering a new user.
 - Functional Restriction: Displays whether user functions are restricted.
 - E-mail address: Displays the originating e-mail address for the user when sending by e-mail. If this field is left blank, the administrator’s e-mail address is used as the originating e-mail address.
 - Edit: Click to edit the user’s settings. For the <Default User>, you can change the default setting for the [Screen after Login].
 - Edit Address Book: Registers and edits entries in the My Address Book provided for each user.
 - Edit Job Button: Registers and edits the My Job Button provided for each user.

❑ Registering New Users

Click [New User] to register a new user.

! IMPORTANT

- When using an authentication server (see p. 6-35), users that are logged in from an authentication server account are registered automatically.
- If an e-mail address is registered for the authentication server account, the e-mail address is also registered automatically.
- If an e-mail address is not registered for the authentication server account, the e-mail address is not registered. Register an e-mail address by editing the user settings (see p. 6-11).

User Settings

User Administration > New User

User Settings	
Authentication Server :	Device
User name :	<input type="text"/>
Password :	<input type="password"/>
Password(confirmation) :	<input type="password"/>
Mail Address :	<input type="text"/> (This address becomes 'From' address.)
Screen after Login :	<input checked="" type="radio"/> Home <input type="radio"/> Job Button screen
Default Address Book screen :	<input checked="" type="radio"/> My Address Book <input type="radio"/> Shared Address Book
Default Job Button screen :	<input checked="" type="radio"/> My Job Button <input type="radio"/> Shared Job Button
E-mail to my mailbox :	<input checked="" type="checkbox"/> Enable

• Authentication Server: Device

The authentication method for newly registered users is Devic, and user authentication is performed on the ScanFront (device).

💡 Hint

For users logged in from an authentication server account and automatically registered, the authentication method is the domain name of the authentication server.

• User name/Password

Enter the user name and password to use for login.

• Password (confirmation)

Enter the same password again for confirmation.

• Mail Address

Enter the originating address for e-mail sent from the scanner.

! IMPORTANT

- Users are not permitted to register and change e-mail addresses. Make sure e-mail addresses are registered and changed by the administrator.
- If no e-mail address is registered, the administrator's e-mail address is used as the originating e-mail address. (See "Device Configuration" on p. 6-29.)
- SMTP/POP Before SMTP Authentication
Appears when [Auth Method] is configured to any setting other than [SMTP] in the mail server settings (see p. 6-34). Enter the [User name] and [Password] that will be used for mail server authentication here.

! IMPORTANT

Confirm the [User name] and [Password] with the user before entering them. Otherwise, have the user enter them directly under [User Settings] of the Web Menu (User Mode) (see p. 8-5).

• Screen after Login

Select the Home screen or the Job Button screen as the first screen to appear after the user logs in.

Home Screen

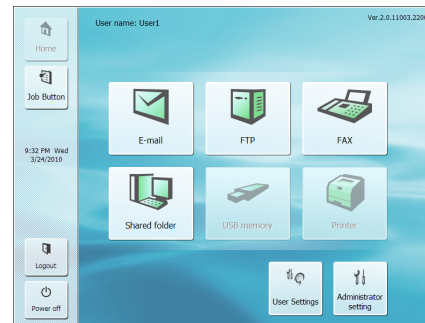

Job Button Screen

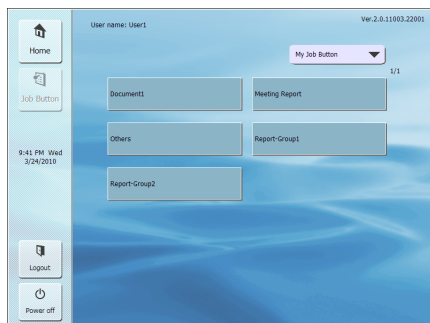

! IMPORTANT

The setting for the startup screen after login also affects which screen appears after a scanned image is sent. (See “Delivery Options” on p. 6-21.)

- **Default Address Book screen**
Select “My Address Book” or “Shared Address Book” for the address book type when the address selection screen is displayed from the Home screen.
- **Default Job Button screen**
Select “My Job Button” or “Shared Job Button” for the job button type when the job button screen is displayed after login.
- **E-mail to my mailbox**
Select the [Enable] check box to display the e-mail address of the logged in user in the address book. If an e-mail address is set for the user, the user’s e-mail address will be displayed even if it has not been registered in the address book. The user’s e-mail address is displayed at the very top of the address list.

Custom File Name Settings

Specify the method in which file names used for saving scanned images are created. When you select to use custom file names during a scanning procedure, the image files will be saved under file names that are determined by the settings configured here. Components of the custom file name will be included in the order that they appear on this screen.

Custom file name Settings	
Custom file name	
Description of setting :	Various information can be added to the sending image file name.
Separator :	<input type="checkbox"/> Enable (hyphen) -
1. String :	
2. User name :	<input type="checkbox"/> Enable
3. Date :	<input type="checkbox"/> Enable mmddyyyy -
4. Time :	<input type="checkbox"/> Enable hhmmss -
5. Device name :	<input type="checkbox"/> Enable
6. Counter :	<input type="checkbox"/> Enable (Counter settings become effective only when using a single page setting)
Start number :	1
Number of digits :	4

! IMPORTANT

The following characters cannot be used to set the custom file name:

/ : ? * " < > |

- **Separator**
Select the [Enable] check box to include a separator between character strings in the file name, and select a character to use as the separator in the list box.
- **String**
Specify a string to include in the file name.
- **User name**
Select the [Enable] check box to include the user name in the file name.
- **Date**
Select the [Enable] check box to include the date in the file name, and select a format for the date in the list box.
- **Time**
Select the [Enable] check box to include the time in the file name, and select a format for the time in the list box.

- **Device name**
Select the [Enable] check box to include the device name in the file name.
- **Counter/Start number/Number of digits**
Select the [Enable] check box to include a counter in the file name. When this is enabled, you can specify the starting value and number of digits used for the counter.

Index Settings

Specify the content of index files (metadata) that are attached to scanned image files. Components of the index file will be included in the order that they appear on this screen.

Index settings	
Description of setting :	Various information when the scanning is executed at the same time as transmitting the scanned image file can be transmitted as a file of the index of the xml or csv form.
Index string :	
Field name :	String
User name :	<input type="checkbox"/> Enable
Field name :	User
Date :	<input type="checkbox"/> Enable
Format :	mmddyyyy
Field name :	Date
Time :	<input type="checkbox"/> Enable
Format :	hhmmss
Field name :	Time
Device name :	<input type="checkbox"/> Enable
Field name :	Device
Counter :	<input type="checkbox"/> Enable
Start number :	1
Number of digits :	4
Field name :	Counter
File name :	<input type="checkbox"/> Enable
Field name :	FileName
File size :	<input type="checkbox"/> Enable
Field name :	FileSize
Number of Pages :	<input type="checkbox"/> Enable
Field name :	PageNumber
Destination path :	<input type="checkbox"/> Enable
Field name :	Folder
Index file format :	<input type="radio"/> XML <input checked="" type="radio"/> CSV

IMPORTANT

The following characters cannot be used in strings contained in the index file:

& " ' < >

- **Index string/Field name**
Enter a string for the index. You can change the default field name (“String”) as necessary.

- **User name**
Select the [Enable] check box to include the user name in the index file. You can change the default field name (“User”) as necessary.
- **Date**
Select the [Enable] check box to include the date in the index file, and select a format for the date in the [Format] list box. You can change the default field name (“Date”) as necessary.
- **Time**
Select the [Enable] check box to include the time in the index file, and select a format for the time in the [Format] list box. You can change the default field name (“Time”) as necessary.
- **Device name**
Select the [Enable] check box to include the device name in the index file. You can change the default field name (“Device”) as necessary.
- **Counter/Start number/Number of digits**
Select the [Enable] check box to include a counter in the index file. When this is enabled, you can specify the starting value and number of digits used for the counter. You can change the default field name (“Counter”) as necessary.
- **File name**
Select the [Enable] check box to include the file name in the index file. You can change the default field name (“FileName”) as necessary.
- **File size**
Select the [Enable] check box to include the file size in the index file. You can change the default field name (“FileSize”) as necessary.
- **Number of Pages**
Select the [Enable] check box to include the number of pages that are in the scanned image in the index file. You can change the default field name (“PageNumber”) as necessary.

- **Destination path**
Select the [Enable] check box to include the destination path in the index file. You can change the default field name (“Folder”) as necessary.
- **Index file format**
Specify a file format for the index files.

[OK] button

Registers a user with the specified parameters, and updates the display on the scanner.



Hint

- When a user is registered, the startup display on the scanner switches from the Home screen to the Login screen. (See “Login Screen” on p. 5-4.)

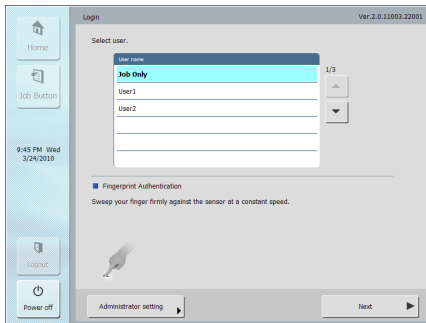

- When a user is registered, the link for User Mode login is added to the Web Menu login screen.

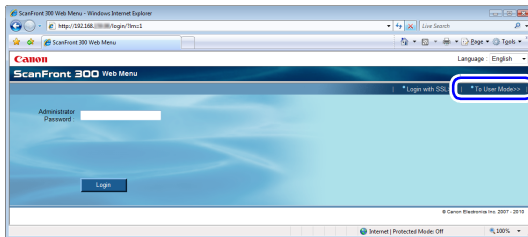

Restricting User Functions

To restrict the functions available to a user, select the user and click [Functional Restriction].

! IMPORTANT

If you restrict the functions of the <Default User>, the function restrictions are applied to newly registered users and users registered automatically by server authentication.



Hint

If multiple users are selected, function restrictions are set for all selected users simultaneously.

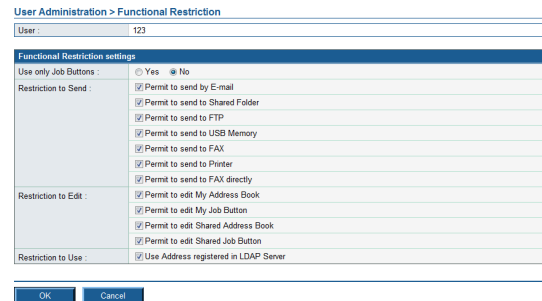

Use only Job Buttons

Disables scanning from the Home screen and displays the Job Button screen when the user logs in.

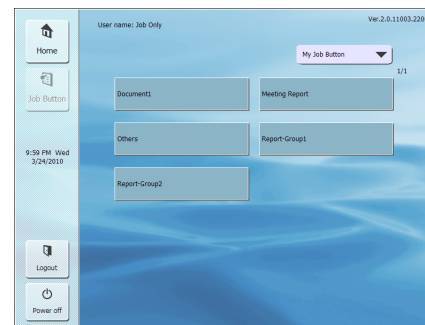

Restriction to Send

Restricts the destinations to which the scanner can send images. Deselect a destination to disable it.

Ex.) When the destinations are restricted to shared folders only:

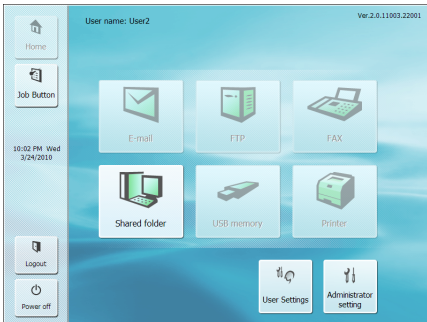

Hint

If you select the “Permit to send to FAX directly” check box, a fax can be sent to an address that is not registered in the address book by directly entering the fax number when sending the fax.

However, “Permit to edit My Address Book” needs to be enabled in the editing restrictions.

Restriction to Edit

Restricts the ability to edit address books and job buttons. Deselect an address book or job button to disable editing for it.

Hint

Configure the following settings to make only the existing address books and job buttons available to the user.

Restriction to Use

Restricts the use of the LDAP Address Book when use of an address book server is enabled in the Server Settings. (See p. 6-33.)

[OK] button

Sets the specified usage restrictions for the user.

Editing Users

You can change the settings of registered users.

Name	Authentication Server	Functional Restrictions	E-mail address			
<Default User>	Device	No Restriction		Edit		
Job Only	Device	Restricted		Edit	Edit Address Book	Edit Job Button
User1	Device	Restricted	user1@example.com	Edit	Edit Address Book	Edit Job Button
User2	Device	Restricted	user2@example.com	Edit	Edit Address Book	Edit Job Button

Edit

Enables you to edit a user’s settings.

User Administration > User Settings>Edit

User Settings	
Authentication Server :	Device
User name :	User1
Change password :	<input type="checkbox"/> Change Password
Password :	<input type="text"/>
Password(confirmation) :	<input type="text"/>
Mail Address :	user1@example.com (This address becomes 'From' address.)
Screen after Login :	<input checked="" type="radio"/> Home <input type="radio"/> Job Button screen
Default Address Book screen :	<input checked="" type="radio"/> My Address Book <input type="radio"/> Shared Address Book
Default Job Button screen :	<input checked="" type="radio"/> My Job Button <input type="radio"/> Shared Job Button
E-mail to my mailbox :	<input checked="" type="checkbox"/> Enable

Custom file name Settings	
Description of setting :	Various information can be added to the sending image file name.
Separator :	<input type="checkbox"/> Enable (-hyphen-)
1. String :	<input type="text"/>
2. User name :	<input type="checkbox"/> Enable
3. Date :	<input type="checkbox"/> Enable mmddyyyy
4. Time :	<input type="checkbox"/> Enable hhmmss
5. Device name :	<input type="checkbox"/> Enable
6. Counter :	<input type="checkbox"/> Enable (Counter settings become effective only when using a single page setting.)
Start number :	1
Number of digits :	4

Index settings	
Description of setting :	Various information when the scanning is executed at the same time as transmitting the scanned image file can be transmitted as a file of the index of the xml or csv form.
Index string :	
Field name :	String
User name :	<input type="checkbox"/> Enable
Field name :	User
Date :	<input type="checkbox"/> Enable
Format :	mmddyyyy
Field name :	Date
Time :	<input type="checkbox"/> Enable
Format :	hhmmss
Field name :	Time
Device name :	<input type="checkbox"/> Enable
Field name :	Device
Counter :	<input type="checkbox"/> Enable
Start number :	1
Number of digits :	4
Field name :	Counter
File name :	<input type="checkbox"/> Enable
Field name :	FileName
File size :	<input type="checkbox"/> Enable
Field name :	FileSize
Number of Pages :	<input type="checkbox"/> Enable
Field name :	PageNumber
Destination path :	<input type="checkbox"/> Enable
Field name :	Folder
Index file format :	<input type="radio"/> XML <input checked="" type="radio"/> CSV

OK Cancel

When you edit <Default User>, the only settings that can be changed in the user settings are the default settings for “Screen after Login,” “Default address book screen,” “Default Job button screen,” and “E-mail to my mailbox”.

User Administration > Edit Default User

User Settings	
Screen after Login :	<input checked="" type="radio"/> Home <input type="radio"/> Job Button screen
Default Address Book screen :	<input checked="" type="radio"/> My Address Book <input type="radio"/> Shared Address Book
Default Job Button screen :	<input checked="" type="radio"/> My Job Button <input type="radio"/> Shared Job Button
E-mail to my mailbox :	<input checked="" type="checkbox"/> Enable



Hint

When [Use only Job Buttons] is enabled as a functional restriction, only [Job Button screen] is available for the [Screen after Login] setting.

By editing a user automatically registered by server authentication, you can set the user’s e-mail address in the user settings.

User Administration > User SettingsEdit

User Settings	
Authentication Server :	
User name :	
Mail Address :	<input checked="" type="checkbox"/> Use Address registered in LDAP Server address. (This address becomes 'From')
Screen after Login :	<input checked="" type="radio"/> Home <input type="radio"/> Job Button screen

Edit Address Book

Enables you to register and edit entries in the user’s My Address Book. For details on configuring address books, see “Address Book Settings” on p. 6-14.

User Administration > (User1)

Address Book Settings					
Type of Address Book :	My Address Book Export from ScanFront Import to ScanFront				
Address type :	All				
<input type="button" value="New Address"/> <input type="button" value="Select All"/> <input type="button" value="Except All"/> <input type="button" value="Copy"/> <input type="button" value="Delete"/>					
Total number of addresses :	0 Items / Page : 10 <input type="button" value="1/1"/> <input type="button" value="To"/> <input type="button" value="PageGo"/>				
<table border="1"> <thead> <tr> <th>Name</th> <th>AddressPath</th> </tr> </thead> <tbody> <tr> <td colspan="2">No items to display.</td> </tr> </tbody> </table>		Name	AddressPath	No items to display.	
Name	AddressPath				
No items to display.					

Back

Edit Job Button

Enables you to register and edit the user’s My Job Button. For details on configuring job buttons, see “Job Button Settings” on p. 6-20.

User Administration > (User1)

Job Button Settings			
Job Button Type :	My Job Button Export from ScanFront Import to ScanFront		
<input type="button" value="New Job Button"/> <input type="button" value="Select All"/> <input type="button" value="Except All"/> <input type="button" value="Copy"/> <input type="button" value="Delete"/>			
Total number of jobs :	0 Items / Page : 10 <input type="button" value="1/1"/> <input type="button" value="To"/> <input type="button" value="PageGo"/>		
<table border="1"> <thead> <tr> <th>Name of Job Button</th> </tr> </thead> <tbody> <tr> <td>No items to display.</td> </tr> </tbody> </table>		Name of Job Button	No items to display.
Name of Job Button			
No items to display.			

Back

❑ Exporting and Importing Users

You can back up your users as files, and import the backed up user data to another ScanFront unit.

Hint

If you have multiple ScanFront units, you can use the same users on all of them by importing the user settings file registered on one ScanFront unit to the other units.

Exporting from the Scanner

You can save the user data to a specified folder.

1. Select the user to export.
2. Click [Export from ScanFront].

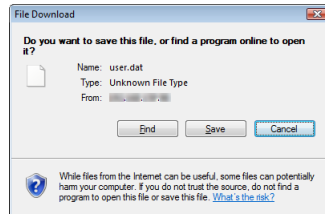

3. Click [Save], specify a save location, and save the user data.

Importing to the Scanner

You can import previously exported user data to the scanner.

1. Click [Import to ScanFront].

User Administration > Import User Settings

User Settings	
Users Setting file :	<input type="text"/> <input type="button" value="Browse..."/>
Action when the same username exists :	<input type="radio"/> Overwrite the file <input checked="" type="radio"/> Abort sending

2. Click [Browse] and specify a previously exported user settings file.

3. Select a processing method for importing the user settings file.
 - Replaces the whole data: Deletes the currently registered user and overwrites it with the imported user data.
 - Appends data: Adds the imported user data to the currently registered user.
4. Click [Execute].
Confirm the message that appears, and click [OK] to import the data.

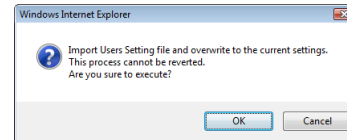

Hint

When importing is completed, the following message appears. Click [OK] to return to User Settings and confirm the imported address data.

Information

Importing of the "D:\work\user.dat" file is complete.



4. Address Book Settings

From the Address Book Settings screen, you can register entries in the Shared Address Book, which is available to all users.

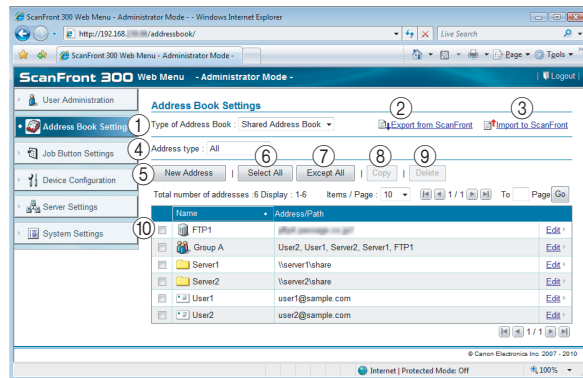

① Type of Address Book

Under normal conditions, you can only select the Shared Address Book here. If you enable the address book server settings, however, the LDAP Address Book becomes selectable. The address type is set to [E-mail] when the LDAP Address Book is selected. (You can manage the My Address Book provided for each user from the User Administration menu.)

② Export from ScanFront

Exports the address book data as a file in CSV format. (See “Exporting and Importing Address Books” on p. 6-18.)

③ Import to ScanFront

Imports a previously exported address book data file. (See “Exporting and Importing Address Books” on p. 6-18.)

④ Address type

Selects the type of addresses (E-mail, FTP Server, Shared folder, Group, or All) to display.

⑤ [New Address] button

Registers a new address entry. (See “Registering New Addresses” on p. 6-15.)

⑥ [Select All] button

Selects all of the displayed addresses.

⑦ [Except All] button

Deselects all of the displayed addresses.

⑧ [Copy] button





Copies the selected address. Only enabled when an address is selected. (See “Copying Addresses” on p. 6-18.)

⑨ [Delete] button

Deletes the selected address. Only enabled when an address is selected.

⑩ Address List

Displays the registered addresses.

- Check box: Select this check box to select an address.
- Address type (icon)
 -  : FTP
 -  : Shared folder
 -  : E-mail
 -  : Fax
 -  : Group
 - Edit: Click to edit an address.

❑ Registering New Addresses

Click [New Address] to register a new address.



Hint

- The number of addresses that can be registered to the Shared Address Book is up to 1000 in combination with the total number of addresses included in the Shared Job Button.
- For the number mentioned above, the count for a group is the number of addresses registered to the group (maximum of 99 addresses) plus the group name, so a group with 99 addresses registered to it is counted as having 100 addresses.
- The available settings vary, depending on the type of address (E-mail, FTP Server, Shared folder, Fax, or Group).

Address type: E-mail

This option registers an e-mail address.

[Address Book Settings > Shared Address Book > New Address](#)

Address type :	E-mail
----------------	--------

Address Book Settings - E-mail	
Name :	<input type="text"/>
E-mail Address :	<input type="text"/>

OK	Cancel
----	--------

Name

Enter the name to display on the scanner.

E-mail Address

Enter the destination e-mail address.

[OK] button

Registers a new e-mail address with the specified parameters.

Address type: FTP Server

This option registers a network FTP server.



IMPORTANT

FTP servers that require firewall settings cannot be registered.

[Address Book Settings > Shared Address Book > New Address](#)

Address type :	FTP Server
----------------	------------

Address Book Settings - FTP Server	
Name :	<input type="text"/>
FTP server :	<input type="text"/>
Folder path :	<input type="text"/> <input type="button" value="Browse..."/>
Port number :	21
User name :	<input type="text"/>
Password :	<input type="password"/>
Save Password :	<input checked="" type="checkbox"/> Save Password
Passive Mode :	<input type="checkbox"/> Passive Mode

OK	Cancel
----	--------

Name

Enter the name to display on the scanner.

FTP server

Enter the IP address or host name of the FTP server.

Folder path

To specify a subfolder on the FTP server, enter the path to the subfolder.



Hint

If you are unsure of the subfolder's path, use the following procedure to specify the subfolder:

1. After entering the [FTP server], [User name], and [Password], click [Browse] and log in to the FTP server.
2. In the folder that appears, specify any subfolder and click [OK].

User name/Password

Enter the user name and password required to log in to the FTP server.

! IMPORTANT

Make sure to enter the user name and password of an account with the authority to write data to the FTP server.

Port number

Enter the port number. The standard port number is 21.

Save Password

Saves the entered password.

Passive Mode

Uses passive mode to send transmissions to the FTP server.

IMPORTANT

Use passive mode when normal communication with the FTP server cannot be established. However, be aware that communication may not be possible if the network is not functioning properly.

[OK] button

Registers a new FTP server with the specified parameters.

Address type: Shared folder

This option registers a folder shared publicly on the network.

Address Book Settings > Shared Address Book > New Address

Address type :	Shared folder ▾
Address Book Settings - Shared folder	
Name :	<input type="text"/>
Computer Name (Host Name) :	<input type="text"/>
Folder path :	<input type="text"/> <input type="button" value="Browse..."/>
	<small>In order to display the list of all computers in a certain domain, please enter "User name" and "Password" to log in that domain, then click the "Browse" button.</small>
User name :	<input type="text"/>
Password :	<input type="password"/>
Domain / Workgroup :	<input type="text"/>
Save Password :	<input checked="" type="checkbox"/> Save Password
<input type="button" value="OK"/> <input type="button" value="Cancel"/>	

Name

Enter the name to display on the scanner.

Computer Name (Host Name)

Enter the name of the computer containing the publicly shared folder. When the ScanFront Service is running, you can enter the IP address instead of a host name.

Folder path

Enter the path to the subfolder that you want to register as the name of the shared folder.

[Browse] button

Shows a list of computers connected to the network for you to specify a shared folder.

Hint

You can display the shared folders using the following procedure.

1. After entering the computer name, user name, password, and domain/workgroup, click [Browse]. Access the computer containing the publicly shared folder.
2. Specify any subfolder from the displayed computer and click [OK].

IMPORTANT

- If you click [Browse] without entering the user account information, only computers and workgroups within the same network address will display.
- When displaying workgroups that are not part of a domain, you cannot display computers or workgroups with different network addresses.
- Not all workgroups and computers in the network can be displayed immediately after the ScanFront is started. If some workgroups and computers are not displayed, wait a few minutes and then press [Browse].
- A new folder cannot be created in a specified folder via the Web Menu. If you want to create a new folder, use the computer set as the FTP server or the address editing functions of the ScanFront to create a folder beforehand.

User name/Password

Enter the user name and password of an account with the authority to write data to the shared folder.

Domain/Workgroup

If the computer containing the shared folder is part of a domain, enter the domain name.

IMPORTANT

- If the computer containing the publicly shared folder is part of a domain, enter the user name and password registered with the domain, and the domain name.
- If the computer containing the publicly shared folder is not part of a domain, there is no need to enter a [Domain/Workgroup].

Save Password

Select this check box to save the password to the address.

IMPORTANT

If you do not save the password, password entry will be required each time you send.

[OK] button

Registers a new shared folder with the specified parameters.

Address type: Fax

This option registers a fax destination.

Address Book Settings > Shared Address Book > New Address

Address type :	Fax
----------------	-----

Address Book Settings - Fax	
Name :	<input type="text"/>
Fax number :	<input type="text"/>

Fax number

Enter the fax number of the destination.

[OK] button

Registers a new fax destination with the specified parameters.

Address type: Group

This option registers several registered addresses together as a group.



Hint

Different types of address, such as e-mail addresses and shared folders, can be registered as a group, and up to 99 addresses can be registered to 1 group.

Address Book Settings > Shared Address Book > New Address

Address type :	Group
----------------	-------

Address Book Settings - Group	
Name :	<input type="text"/>

Address Settings		Add from Address Book	
Total number of addresses : 0	Items / Page : 10	To	Page Go
Name			
+ Address/Path			
No items to display.			

Name

Enter the name to display on the scanner.

Add from Address Book

Allows you to select an address from an address book, add it to the group, and display it in the list.

[OK] button

Registers a new group with the specified parameters.

❑ Copying Addresses

You can copy an address and register it as a new address.



Hint

- Use this function when you want to copy an address from the Shared Address Book and register it as a different address after changing some of the settings.
- By copying addresses from User Administration, you can copy addresses between the Shared Address Book and the My Address Book.

1. Add a checkmark to the check box of the address you want to copy and then click [Copy].

Address Book Settings

Type of Address Book : Shared Address Book [Export from ScanFront](#) [Import to ScanFront](#)

Address type : All

Total number of addresses : 8 Display : 1-8 Items / Page : 10 To

Name	Address/Path	Edit
<input type="checkbox"/> FTP1		Edit
<input type="checkbox"/> Group A	User2, User1, Server2, Server1, FTP1	Edit
<input type="checkbox"/> Server1	\\server1\share	Edit
<input type="checkbox"/> Server1	\\server1\share	Edit
<input type="checkbox"/> Server2	\\server2\share	Edit
<input type="checkbox"/> Server2	\\server2\share	Edit
<input type="checkbox"/> User1	user1@sample.com	Edit
<input type="checkbox"/> User2	user2@sample.com	Edit

2. Click [OK] to copy the address.

Address Book Settings > Address Copy

Copy to : Shared Address Book

Total number of addresses : 2 Display : 1-2 Items / Page : 10 To

Name	Address/Path	Edit
<input checked="" type="checkbox"/> Server1	\\server1\share	Edit
<input checked="" type="checkbox"/> Server2	\\server2\share	Edit



Hint

A duplicate address with the same name as the copy source is created.

Total number of addresses : 8 Display : 1-8 Items / Page : 10 To

Name	Address/Path	Edit
<input type="checkbox"/> FTP1		Edit
<input type="checkbox"/> Group A	User2, User1, Server2, Server1, FTP1	Edit
<input type="checkbox"/> Server1	\\server1\share	Edit
<input type="checkbox"/> Server1	\\server1\share	Edit
<input type="checkbox"/> Server2	\\server2\share	Edit
<input type="checkbox"/> Server2	\\server2\share	Edit
<input type="checkbox"/> User1	user1@sample.com	Edit
<input type="checkbox"/> User2	user2@sample.com	Edit

3. Change the name and settings of the copied address, and register it as a new address.

❑ Exporting and Importing Address Books

You can back up your address books as files in CSV format, and import the backed up address book data to another ScanFront unit.



Hint

If you have multiple ScanFront units, you can use the same address books on all of them by importing the address book settings file registered on one ScanFront unit to the other units.

Exporting from the Scanner

You can save the address book data to a specified folder.

1. Click [Export from ScanFront].

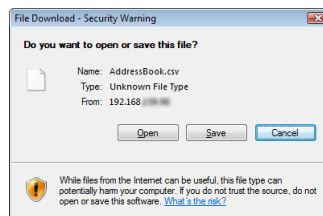

- Click [Save], specify a save location, and save the address book data.

 **Hint**

- You can open the saved CSV file with software that supports CSV files such as spread sheet software in order to check the structure of the file.
- You can match the structure of a CSV file created in another mailer to that of a CSV file saved on the ScanFront, and then import the address book of the other mailer and use it on the ScanFront.

Importing to the Scanner

You can import previously exported address book data to the scanner.

- Click [Import to ScanFront].

[Shared Address Book > Import Address Book](#)

Address Book Settings	
Address Book file :	<input type="text"/> <input type="button" value="Browse..."/>
How to write data :	<input type="radio"/> Replaces the whole data <input checked="" type="radio"/> Appends data

- Click [Browse] and specify a previously exported address book settings file.
- Select a processing method for importing the address book settings file.
 - Replaces the whole data:** Deletes the currently registered address book and overwrites it with the imported address book data.
 - Appends data:** Adds the imported address book data to the currently registered address book.

- Click [Execute].

Confirm the message that appears, and click [OK] to import the data.

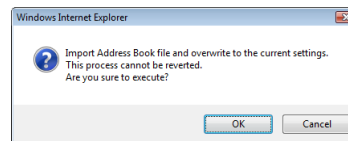

 **Hint**

When importing is completed, the following message appears. Click [OK] to return to Address Book Settings and confirm the imported address data.

Information

Importing of the "D:\work\AddressBook.csv" file is complete.

5. Job Button Settings

From the Job Button Settings screen, you can register the Shared Job Button, which is available to all users.

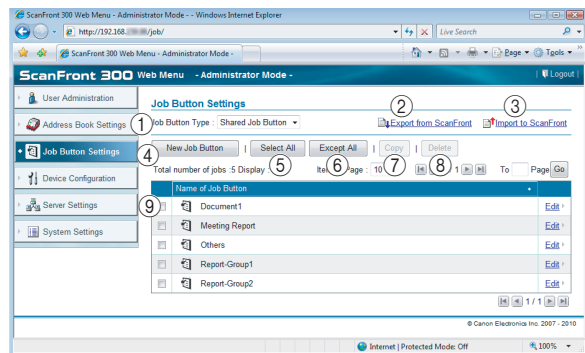

- ① **Job Button Type**
You can only select Shared Job Button here. You can manage the My Job Button, provided for each user, from the User Administration menu.
- ② **Export from ScanFront**
Exports the job button data as a file in DAT format. (See “Exporting and Importing Job Buttons” on p. 6-27.)
- ③ **Import to ScanFront**
Imports a previously exported job button data file. (See “Exporting and Importing Job Buttons” on p. 6-27.)
- ④ **[New Job Button] button**
Registers a new job button. (See “Registering New Job Buttons” on p. 6-21.)
- ⑤ **[Select All] button**
Selects all of the displayed job buttons.
- ⑥ **[Except All] button**
Deselects all of the displayed job buttons.
- ⑦ **[Copy] button**
Copies the selected job button. Only enabled when a job button is selected. (See “Copying Job Buttons” on p. 6-26.)
- ⑧ **[Delete] button**
Deletes the selected job button. Only enabled when a job button is selected.
- ⑨ **Job Button List**
Displays the registered job buttons.
 - **Check box:** Select this check box to select a job button.
 - **Edit:** Click to edit a job button.

❑ Registering New Job Buttons

Click [New Job Button] to register a new job button.

Job Button Settings

Job Button Settings > Shared Job Button > New Job Button

Job Button Settings	
Name of Job Button :	0 / 48 characters : 1 / 2 lines
Color of Job Button :	<input checked="" type="radio"/> Blue <input type="radio"/> Yellow <input type="radio"/> Pink <input type="radio"/> Red <input type="radio"/> Orange <input type="radio"/> Purple <input type="radio"/> Skyblue
When you select this Job Button :	Display Scan Setting Screen ▾

Name of Job Button

Enter the job button name to display on the touch panel.



Hint

- Job buttons are sorted and displayed by job button name. If you want to set to display job buttons in a particular order, insert sequential letters or numbers before the name when registering each job button. Ex.) 01_xxxx
- If you enter a job button name that is two lines long, the job button display will be two lines long.

Color of Job Button

Specify a color for the job button.

When you select this Job Button

- Display Scan Setting Screen
Displays the Scan Setting screen when the job button is pressed.
- Skip Scan Setting Screen
Starts scanning without displaying the Scan Setting screen when the job button is pressed.



IMPORTANT

If you select [Skip Scan Setting Screen], scanning starts as soon as the job button is pressed, whether a document is inserted or not.

Address

Address	
Total number of addresses : 0	Items / Page : 10
<input type="button" value="Home"/> <input type="button" value="1 / 1"/> <input type="button" value="Next"/>	
Name	To/Cc/Bcc
Address/Path	
No items to display.	
<input type="button" value="Home"/> <input type="button" value="1 / 1"/> <input type="button" value="Next"/>	

Click [Add from Address Book], open the Address page, and select the address to send to.



IMPORTANT

- You can register up to 100 addresses to a job button.
- For the number mentioned above, the count for a group is the number of addresses registered to the group (maximum of 99 addresses) plus the group name, so a group with 99 addresses registered to it is counted as having 100 addresses.

Scan Settings/Detailed settings

For details on Scan Settings/Detailed settings, see “Scan Settings Overview” on p. 6-22.

E-mail settings

E-mail settings	
Subject :	From ScanFront300
Message :	
0 / 1024 characters	

Subject

Enter a subject for the e-mail message.

Message

Enter the text of the e-mail message.

Delivery Options

Delivery Options	
Action when the same named file exists :	Display a message ▾
Send the files immediately after scanning :	<input type="radio"/> ON <input checked="" type="radio"/> OFF
Confirm addresses before sending :	<input checked="" type="radio"/> ON <input type="radio"/> OFF
Screen after sending :	Initial Screen ▾

Action when the same named file exists

Select the action to take when a file of the same name exists at the destination.

- **Display a message**
Displays a message confirming that the file will be overwritten.
- **Abort sending**
Cancels sending.
- **Overwrite the file**
Overwrites the identically named file without displaying a confirmation message.

Send the files immediately after scanning

- **ON**
Starts sending when scanning completes.
- **OFF**
Starts sending after you confirm the scanned image when scanning completes.

Confirm addresses before sending

- **ON**
Displays the Address Confirmation screen, and then starts sending after you confirm the address.
- **OFF**
Sends the image without confirming the address.

Screen after sending

Select the screen to display after an image is sent.

- **Initial Screen**
Returns to the startup screen set for [Screen after Login] in the User Settings.
- **Logout**
Logs out after the images are sent.
- **Select screen after sending**
Displays a message dialog for selecting from the above actions after the images are sent.

Index Settings

Specify whether to attach metadata (index files) to scanned images.

Index settings	
Description of setting :	Various information when the scanning is executed at the same time as transmitting the scanned image file can be transmitted as a file of the index of the xml or csv form.
Send index file :	<input type="radio"/> ON <input checked="" type="radio"/> OFF

OK Cancel Default

Scan Settings Overview

The scan settings include basic and detailed settings for scanning parameters and individual settings by file format.

Scan Settings

Scan Settings	
Page Size :	Auto size
Mode :	Black and White
Resolution(dpi) :	150
Scanning Side :	Simplex
Skip Blank Page Contents detection sensitivity :	90 (0 - 100) 0 Low 100 High
Prescan :	<input type="radio"/> ON <input checked="" type="radio"/> OFF
File name :	
When you select this Job Button :	Skip the file name entry screen
Add Date to File name :	mmddyyyy
File format :	<input checked="" type="radio"/> TIFF <input type="radio"/> JPEG <input type="radio"/> PDF
Multi page settings :	Multi page

Page Size

Select the size of the document to scan from the list.



Hint

- The [Auto size] option automatically detects the size of the scanned document during scanning.
- When scanning a long document, select [Auto size (Long)]

! IMPORTANT

A resolution of [300 dpi] or more cannot be set when [Auto size (Long)] is selected.

Mode

Select the scanning mode (Black and White, Error Diffusion, Text enhance, Gray, Color, Auto Color Detection).

When [Auto Color Detection] is selected, the scanner automatically detects whether the document is color or black and white. When this option is selected, you can also configure the following settings.

Mode :	Auto color detection ▾
Auto Color Detection Settings :	
Mode in case of binary :	Black and White ▾
Threshold intensity to judge the document as color :	3 ▾
Aresize to judge the document as color :	2 ▾
Resolution(dpi) :	150 ▾
Scanning Side :	Simplex ▾
Skip Blank Page Contents detection sensitivity :	90 (0 - 100) 0 : Low 100 : High
Prescan :	<input type="radio"/> ON <input checked="" type="radio"/> OFF

- **Mode in case of binary**

Specify the scanning mode to use when a black and white document is detected.

- **Threshold intensity to judge the document as color**
Adjust the sensitivity to colors in a document.
- **Aresize to judge the document as color**
Specify the ratio of colored regions in a document.

- **! IMPORTANT**

- The [Auto Color Detection] function cannot be used simultaneously with the color drop-out or prescan function.
- Depending on the selected mode, the file formats available for saving may be limited. A warning message appears when an unavailable combination is selected.

	TIFF	JPEG	PDF
Black and White	Yes	No	Yes
Error Diffusion	Yes	No	Yes
Text enhance	Yes	No	Yes
Gray	No	Yes	Yes
Color	No	Yes	Yes
Auto Color Detection	No	No	Yes

- When [Text enhance] is selected, [Bleed-through reduction] cannot be selected.

Resolution (dpi)

Select the scanning resolution (100, 150, 200, 300, 400, or 600 dpi).

Scanning Side

Select the method for scanning the document (Simplex, Duplex, Skip blank page, Folio).

Hint

- The Skip Blank Page option scans both sides of a document and skips saving any image it determines to be a blank page.
- You can adjust the sensitivity of the Skip Blank Page option under [Contents detection sensitivity].
- The initial value for the Skip Blank Page option is set to “90.” As you lower the value from the default setting, pages of the document with text become more likely to be skipped as well. As you raise the value from the default setting, pages of the document that are blank become less likely to be skipped.

IMPORTANT

- The scanning speed may be reduced when [Skip Blank Page] is selected.
- A resolution of [400 dpi] or more cannot be set when [Folio] is selected. In addition, [Double feed detection by Ultrasonic] cannot be selected.

Prescan

Enables you to preview an image of the first page of the document before scanning the entire document.

Hint

- Scanning pauses after the first page of the document is scanned, and the image of the first page is displayed.
- Use the displayed image to confirm and adjust the brightness and contrast. Press [Continue] to confirm the adjusted brightness and contrast for the first image and continue scanning.

File name

Specify a name for the image file to be sent.

Add Date to File name

The scanner adds 17 digits that indicate the date and time to the file name of the image to be sent.

Ex.) May 14, 2013, 3:40:30 p.m.

yyyymmdd: File name + 20130514154030123

mmddyyyy: File name + 05142013154030123

ddmmyyyy: File name + 14052013154030123

* The last three digits indicate the number of milliseconds.

You can select [Custom] to configure additional file name settings. The additional settings are identical to those in “Custom File Name Settings” on p. 6-8.

When you select this Job Button

Specify whether the file name entry screen appears when you start scanning using the job button.

File format

Select a file format for the image file, and configure the corresponding settings.

TIFF: Multi page settings

File format :	<input checked="" type="radio"/> TIFF <input type="radio"/> JPEG <input type="radio"/> PDF
Multi page settings :	Multi page

Select [Single page (Front/back separate file)] to save each side of each page as a separate image file, [Single page (Front/back same file)] to save each page as a separate image file, or [Multi page] to save one image file containing multiple pages when scanning multiple pages.

JPEG: Compression

File format :	<input type="radio"/> TIFF <input checked="" type="radio"/> JPEG <input type="radio"/> PDF
Compression :	4(normal)
Detailed settings	1(High Compression) 2 3 4(normal) 5 6 7(High Quality)
Brightness(Front) :	4(normal)
Brightness(Back) :	5 front
Contrast(Front) :	7(High Quality)

Select a compression ratio for images saved in JPEG format.

PDF:

Configure the settings for compression ratio, multi page, OCR (optical character recognition), and security.

File format :	<input type="radio"/> TIFF <input type="radio"/> JPEG <input checked="" type="radio"/> PDF
Compression Method :	<input checked="" type="radio"/> Standard <input type="radio"/> High Compression
Compression :	4(normal)
Multi page settings :	Multi page
OCR :	<input checked="" type="radio"/> ON <input type="radio"/> OFF
OCR language setting :	English
Encryption :	<input checked="" type="radio"/> ON <input type="radio"/> OFF
Encryption Level :	<input checked="" type="radio"/> Low (40-bit RC4) <input type="radio"/> High(128-bit RC4)
Protect Document :	<input checked="" type="checkbox"/> Required a password to open the document
Document Open Password :	(confirmation)
Protect Permission :	<input checked="" type="checkbox"/> Use permissions password to restrict editing security settings
Permissions Password :	(confirmation)
Printing allowed :	<input type="radio"/> Allowed <input checked="" type="radio"/> Not allowed
Changes allowed :	<input type="radio"/> Allowed <input checked="" type="radio"/> Not allowed
Enable copying of text, images, and accessibility :	<input type="radio"/> ON <input checked="" type="radio"/> OFF

Compression Method

Specify a compression level by selecting [Standard] or [High Compression] as the compression method.

OCR (Optical Character Recognition)

When OCR is set to [ON], the scanner performs character recognition on textual portions of the document, and embeds the detected characters as editable text information in the PDF file.

Hint

When you set OCR to [ON], make sure to select the OCR language that matches the document text.

Encryption

Apply security to the PDF file.

IMPORTANT

Using the High (128-bit RC4) level setting is recommended. The Low (40-bit RC4) level setting provides less security.

Protect Document

The ability to view the document is protected by a password.

! IMPORTANT

Take care not to forget the password once it is set. If you forget the password, the document can no longer be opened.

Protect Permission

Permissions for printing and editing the PDF file are protected by a password.

Printing allowed

Enables the PDF file to be printed from a printer.

Changes allowed

Enables editing of the PDF file, such as adding or deleting pages.

Enable copying of text, images, and accessibility

Enables text information embedded by OCR to be copied and the PDF file to be read aloud by text-to-speech software.

! IMPORTANT

- Protecting PDF file permissions is recommended when the permissions have been restricted.
- You can change the permissions and cancel password protection for a password protected PDF file in an application capable of editing PDF files such as Adobe Acrobat.

Detailed settings

Detailed settings	
Brightness(Front) :	5(normal) ▾
Brightness(Back) :	5(normal) ▾ <input checked="" type="checkbox"/> Same as front
Contrast(Front) :	4(normal) ▾
Contrast(Back) :	4(normal) ▾ <input checked="" type="checkbox"/> Same as front
Double feed detection by Ultrasonic :	<input type="radio"/> ON <input checked="" type="radio"/> OFF
Double feed detection by length :	<input type="radio"/> ON <input checked="" type="radio"/> OFF
Document orientation :	<input checked="" type="radio"/> 0 <input type="radio"/> 90 <input type="radio"/> 180 <input type="radio"/> 270 <input type="radio"/> Auto
Deskew :	<input checked="" type="radio"/> Prefer Quality <input type="radio"/> Prefer Speed <input type="radio"/> OFF
Bleed-through reduction :	<input type="radio"/> ON <input checked="" type="radio"/> OFF
Bleed Through Reduction Level :	4(normal) ▾
Color drop-out	
Front side color drop-out :	None ▾
Back side color drop-out :	None ▾

! IMPORTANT

The [Double feed detection by Ultrasonic] setting only appears when using the ScanFront 300P/330.

Brightness (Front)

Adjusts the brightness of the image to be scanned.

Brightness (Back)

Enabled for duplex scanning. Use this option when the front and back sides of a document are shaded differently. To change the brightness settings for the front and back sides, clear the [Same as front] check box.

Contrast (Front)

Adjusts the contrast of the image to be scanned.

Contrast (Back)

Enabled for duplex scanning. Use this option when the front and back sides of a document are shaded differently. To change the contrast settings for the front and back sides, clear the [Same as front] check box.

Double feed detection by Ultrasonic (Only available with the ScanFront 300P/330)

The scanner uses an ultrasonic sensor to detect when two or more documents are fed together, and stops feeding when a double feed is detected.

! IMPORTANT

- This method is effective when documents overlap by 1.97" (50 mm) or more. It does not function if only a slight portion of the document is overlapping.
- When [Scanning Side] is set to [Folio], [Double feed detection by Ultrasonic] cannot be selected.

Double feed detection by length

The scanner detects by document length when two or more documents are fed together, and stops feeding when a double feed is detected.

! IMPORTANT

- Using the length of the first document page as a reference, the scanner detects a double feed when a subsequent page is longer or shorter than the reference page by 1.38" (35 mm) or more.
- Set [Double feed detection by length] to [OFF] when scanning a document that contains pages of different lengths.

Document orientation

Rotates the scanned image to the specified angle.

Hint

When [Auto] is selected, the scanner detects text orientation within the document and rotates the image so that the orientation of the text is correct.

! IMPORTANT

The scanning speed may be reduced when [Auto] is selected.

Deskew

Detects when a document has been fed askew from the scanned image, and then straightens the image.

- Prefer Quality**

Image processing is performed to minimize the loss of quality of an image that has deteriorated as result of deskewing.

- Prefer Speed**

The image deteriorates slightly as a result of deskewing.

! IMPORTANT

If you select [Prefer Quality], the scanning speed is reduced. If you are scanning a large number of pages, select [Prefer Speed] to prevent a decrease in scanning speed.

Bleed-through reduction

Eliminates bleed-through images, in which images on the reverse side of a scanned document appear on the scanned page, such as when scanning thin documents with text or images on both sides.

! IMPORTANT

The bleed-through reduction setting is disabled when the scanning mode is set to [Text enhance].

Hint

When using bleed-through reduction, adjust the bleed-through reduction level to match the type of document.

Color drop-out

The color drop-out function has a “drop-out” effect that leaves out a specified color (red, blue, or green) while scanning, and a “color enhancement” effect that emphasizes a specified color.

! IMPORTANT

The color drop-out setting is disabled when the scanning mode is set to [Color].

Hint

The OCR recognition rate is sometimes improved by deleting colored ruled lines and other objects with the color drop-out function.

Copying Job Buttons

You can copy the settings of a job button and register it as a new job button.

Hint

- Use this function when you want to copy a Shared Job Button and register it as a different job button after changing some of the settings.
- By copying job buttons from User Administration, you can copy job buttons between the Shared Job Button and the My Job Button.

- Select the job button you want to copy, and click the [Copy] button.

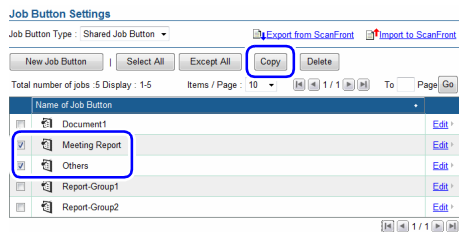

- Click [OK] to copy the job button.

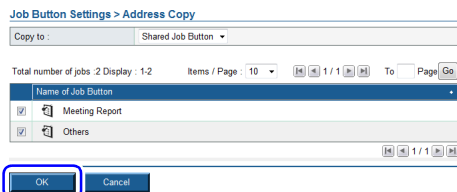

Hint

A duplicate job button with the same name as the copy source is created.

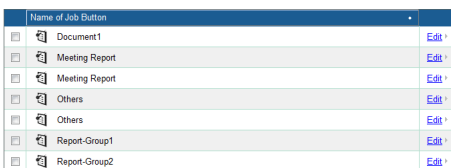

- Change the name and settings of the copied job button, and register it as a new job button.

Editing Jobs

You can edit the settings of a registered job by clicking [Edit] in the job button list. The settings that can be edited are identical to those in “Registering New Job Buttons” on p. 6-21.

Exporting and Importing Job Buttons

You can back up your job button data as a settings file in DAT format, and import the backed up job button settings file to another ScanFront unit.



Hint

If you have multiple ScanFront units, you can use the same job buttons on all of them by importing the job button settings file registered on one ScanFront unit to the other units.

Exporting from the Scanner

You can save the job button settings file to a specified folder.

- Click [Export from ScanFront].

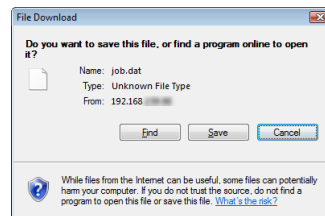

- Click [Save], specify a save location, and save the job button settings file.

Importing to the Scanner

You can import a previously exported job button settings file to the scanner.

- Click [Import to ScanFront].

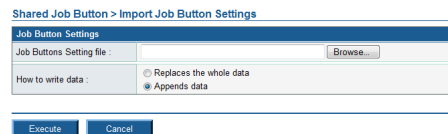

- Specify a previously exported job button settings file.
- Select a processing method for importing the job button settings file.
 - Replaces the whole data: Deletes all currently registered job buttons and overwrites them with the imported job buttons.
 - Appends data: Adds the imported job button to the currently registered job button.

4. Click [Execute].

Confirm the message that appears, and click [OK] to import the data.

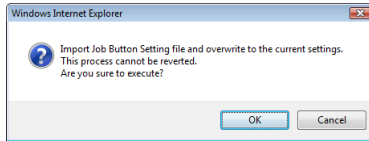
**Hint**

When importing is completed, the following message appears. Click [OK] to return to Job Button Settings and confirm the imported job button.



6. Device Configuration

From the Device Configuration screen, you can configure the scanner settings.

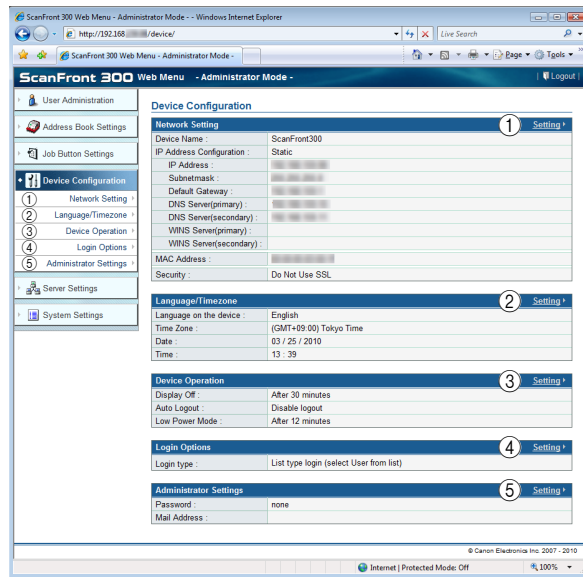

① Network Setting

Confirm or change the network settings of the scanner.
(See “Network Setting” on p. 6-30.)

② Language/Timezone

Configure the language displayed on the touch panel and the region where it is being used. (See “Language/Timezone” on p. 6-30.)

! IMPORTANT

The time zone setting also effects the time stamp on sent e-mail.

③ Device Operation

Configure the settings for [Display off], [Auto Logout] and [Low Power Mode]. (See “Device Operation” on p. 6-31.)

④ Login Options

Select the type of screen that appears when users log in.
(See “Login Options” on p. 6-31.)

⑤ Administrator Settings

Set the password and e-mail address of the Administrator.
(See “Administrator Settings” on p. 6-32.)

! IMPORTANT

The e-mail address of the Administrator is used as the originating address when a user without a registered e-mail address sends an e-mail message.

❑ Network Setting

You can confirm the network settings configured under [Administrator setting] on the scanner.

Device Configuration > Network Setting

Network Setting	
Device Name :	ScanFront200
IP Address Configuration :	<input checked="" type="radio"/> DHCP(Auto) <input type="radio"/> Static
IP Address :	<input type="text"/>
Subnetmask :	<input type="text"/>
Default Gateway :	<input type="text"/>
DNS Server :	<input type="checkbox"/> Automatically obtain the DNS server address
DNS Server(primary) :	<input type="text"/>
DNS Server(secondary) :	<input type="text"/>
WINS Server :	<input type="checkbox"/> Automatically obtain the WINS server address
WINS Server(primary) :	<input type="text"/>
WINS Server(secondary) :	<input type="text"/>
MAC Address :	<input type="text"/>
Security of Web Menu	
Security :	<input type="checkbox"/> Be sure to use SSL

OK Cancel

Network Setting

Confirm or change the network settings configured under [Administrator setting] on the scanner.

! IMPORTANT

- The device name can be a combination of letters (A-Z, a-z), numbers (0-9), and hyphens (-) up to 15 characters long.
- The device name must begin with a letter. You cannot end the device name with a hyphen.
- You must restart the scanner after changing the device name.

Security of Web Menu

Add a checkmark to always use SSL for communication with the Web Menu.

Hint

- If you add a checkmark for [Be sure to use SSL], [Login with SSL] and [Do Not Use SSL] are no longer displayed in the login screen for the Web menu.
- When you open the Web Menu using Internet Explorer 7 or later, an SSL-certificate warning will appear. However, you can proceed and open the Web Menu safely.

❑ Language/Timezone

You can confirm or change the language and regional settings that appear on the scanner.

Device Configuration > Language/Timezone

Language/Timezone	
Language on the device :	English
Time Zone :	(GMT+09:00) Tokyo Time
Date :	<input type="checkbox"/> Change Date 03 / 25 / 2010
Time :	<input type="checkbox"/> Change Time 14 : 02

OK Cancel

Language on the device

Set the language displayed on the touch panel.

! IMPORTANT

You must restart the scanner after changing the display language setting.

Time Zone

Set the region in which the scanner will be used.

Enable daylight saving time

Select this check box to apply the Daylight Saving Time for the specified region set in the Time Zone.

! IMPORTANT

- If the correct time zone is not set, the time stamps that are saved for the send time of e-mail messages, and for the saved image files will be incorrect.
- When the daylight saving time mode is enabled, the correct time may not be reflected. In this case, set the correct time.

❑ Device Operation

You can configure the operation conditions of the scanner.

Device Configuration > Device Operation

Device Operation	
Display Off	
Waiting Time till Display Off :	After 30 minutes ▾
Auto Logout :	<input type="checkbox"/> Enable
Waiting Time till Logout :	After 30 minutes ▾
Low Power Mode :	
Waiting Time till Low Power Mode :	After 12 minutes ▾

OK Cancel

Display Off

Set the scanner to turn off the touch panel display after a specified period of inactivity.

! IMPORTANT

When Display Off activates and the touch panel display turns off, touch the panel to restore the display.

Auto Logout

Set the scanner to automatically log users out after a specified period of inactivity.

Low Power Mode

Set the scanner to switch to Low Power mode after a specified period of inactivity.

! IMPORTANT

- When the scanner switches to Low Power mode, the touch panel display turns off and the power indicator flashes. To switch out of Low Power mode, press the power switch or touch the touch panel.
- The scanner does not transition to Low Power mode during the flow of data on the network when connected to a network.
- Note that if the scanner transitions to Low Power mode when the placed documents run out after scanning is started, or scanning is suspended because of a paper jam or double feed, all the images that were scanned prior to the suspending of scanning and that were not yet transmitted are discarded.
- You will not be able to operate the scanner immediately after power is restored from Low Power mode. Operation will be enabled after about 15 seconds, so please wait a moment before attempting operation.

❑ Login Options

You can set the type of user login screen that appears.

💡 Hint

The login setting can also be changed under [Administrator setting] on the scanner.

Device Configuration > Login Options

OK Cancel

List type login

Log in by selecting a user from the list.

Key in type login

Log in by entering a user name and password.

! IMPORTANT

When using an authentication server, the login type is set to [Key in type login], and users log in by selecting [Device Authentication] and [Server Authentication]. (See "Authentication Server" on p. 6-35.)

□ Administrator Settings

You can set the password and e-mail address of the Administrator.

Device Configuration > Administrator Password

Administrator Password	
Change password :	<input type="checkbox"/> Change Password
New Password :	<input type="text"/>
New Password (Confirmation) :	<input type="text"/>

Administrator Address	
Mail Address :	<input type="text"/>

<input type="button" value="OK"/>	<input type="button" value="Cancel"/>
-----------------------------------	---------------------------------------

Administrator Password

Change the Administrator password.

Administrator Address

Register the Administrator e-mail address.

IMPORTANT

- The e-mail address of the Administrator is used as the originating address when a user without a registered e-mail address sends an e-mail message.
- When a sent e-mail message results in an error due to, for example, an incorrect e-mail address, an error notification is delivered from the mail server to the e-mail address of the administrator.

7. Server Settings

From the Server Settings screen, you can configure mail server settings for sending images via e-mail, and settings for accessing a network authentication server compatible with a directory service.

! IMPORTANT

- You can simplify user administration on the scanner by using e-mail addresses registered on an LDAP server, or by logging in from user accounts that are registered on a domain server and are compatible with Active Directory or LDAP servers.
- Configure the server settings only after consulting your network administrator.

The screenshot shows the ScanFront 300 Web Menu Administrator Mode interface. The left sidebar contains navigation options: User Administration, Address Book Settings, Job Button Settings, Device Configuration, and Server Settings. The Server Settings section is expanded, showing a list of sub-sections: 1. E-mail Server/FAX Settings, 2. Authentication Server, 3. Address Book Server, 4. FTP Server, 5. NTP Server, 6. ScanFront Service Server, and 7. Certificates. The main content area displays the configuration for each of these sections, with numbered callouts (1-7) pointing to a 'Setting' link for each section.

① E-mail Server / Fax Settings

Configure the mail server to be used for sending e-mail, or the Internet fax service provider to be used for sending fax. For details, consult your e-mail system administrator. (See “E-mail Server/Fax Settings” on p. 6-34.)

② Authentication Server

Configure the domain server (authentication server) on which user accounts have been registered with Active Directory. (See “Authentication Server” on p. 6-35.)

③ Address Book Server

Configure these settings when using an LDAP server. (See “Address Book Server” on p. 6-36.)

④ FTP server

Configure this function to transfer a scan result log along with an image file during transfer to the FTP server. (See “FTP server” on p. 6-37.)

⑤ NTP Server

Configure the NTP server to synchronize the ScanFront with the correct time. (See “NTP Server” on p. 6-37.)

⑥ ScanFront Service Server

When a ScanFront Service Server (i.e., a computer on which ScanFront Service is installed) exists on the network, use this to specify the host name of the server and the port number used for transmission. (See “ScanFront Service Server” on p. 6-37.)

⑦ Certificates

Import the root certificate of the LDAP server to the ScanFront. (See “Certificates” on p. 6-37.)

❑ E-mail Server/Fax Settings

You can configure the mail server settings for sending e-mail messages and the fax server settings for sending faxes.



Hint

The scanner sends a large volume of data by e-mail. Make sure to confirm the mail server settings with your e-mail system administrator before configuring the settings.

Server Settings > E-mail Server/FAX Settings

E-mail Server	
E-mail Host Name(Address) :	<input type="text"/>
Port number :	25
Divided E-mail Size :	5MB
Mail Server Authentication Method :	<input checked="" type="radio"/> SMTP <input type="radio"/> POP before SMTP <input type="radio"/> SMTP (LOGIN) <input type="radio"/> SMTP (PLAIN) <input type="radio"/> SMTP (CRAM-MD5)
POP Server :	<input type="text"/>
Port number :	110
Time of after POP Authorization :	0 msec(Max:5000msec)
FAX Settings	
Set sending format specified by the provider for FAX.	
Provider name :	<input type="text"/> (Not required.)
User name :	<input type="text"/> (Not required.)
Password :	<input type="text"/> Register / Change password
<input type="text"/> (Not required.)	
Set sending format to To, Subject or Message for FAX. (n: FAX number, h: Provider name, u: User name, pw: Password) (ex. FAX number@Provider name) %n%@%h%	
To :	<input type="text"/>
Subject :	<input type="text"/>
Message :	<input type="text"/>
0 / 1024 characters	

E-mail Server

- **E-mail Host Name (Address)**
Enter the name or address of the SMTP server (for sending e-mail messages).
- **Port number**
Change the port number if necessary. The standard port number is 25.
- **Divided E-mail Size**
If the image file attached to an e-mail message is too large to send, the file is divided into pieces of the specified size before being sent.

! IMPORTANT

If the destination mail server does not support divided attachments, it may not be possible to reconstitute a divided image file sent by the scanner. In such cases, turn off this setting, and divide the scanned documents manually before sending.

- **E-mail Server Authentication Method**
Configure this setting based on the authentication method of your mail server. For details on the mail server authentication method, consult your e-mail system administrator.

! IMPORTANT

- If any setting other than [SMTP] is selected for the authentication method, the authentication settings for the mail server must be configured for each user (see p. 6-7).
- If you select a setting other than [SMTP], be sure to register users.
- When [POP before SMTP] is selected, make sure to specify the host name (or address) and port number of the POP server being used, and the wait time that follows POP authentication.

FAX Settings

Configure the following settings concerning the Internet fax service you are using.

- **Provider name**
If you are using an Internet fax service and provider name specification is necessary, enter the provider name specified by your provider here.
- **User name**
If you are using an Internet fax service and user information specification is necessary, enter the user name registered with your provider here.
- **Password**
To use the password of the user specified in [User name], select [Change Password] and enter the password.
- **To, Subject, Message**
Enter the e-mail address (To), subject, and message for e-mails that will be sent to the Internet fax service.

If you enter the following substitution strings for these settings, the strings will be replaced with the following strings when the fax is sent.

Substitution String	Replacement String
%n%	Fax number that is registered in the address book and selected before sending the image file.
%h%	Provider name
%u%	User name
%pw%	Password

For example, the substitution strings that you enter will be replaced as follows when the fax number is “00111222”, the provider name is “FaxService”, and the user name is “SFUser”.

Entered String	Replacement String
%n%@%h%	001112222@FaxService
Fax delivery notification (from %u%)	Fax delivery notification (from SFUser)

❑ Authentication Server

When using a domain server compatible with Active Directory or OpenLDAP, you can log in to the scanner with a user account registered on the domain server. In the authentication server settings, you can register the domain server to use as the authentication server. If the account information includes e-mail addresses, you can configure settings for referring e-mail addresses. You can register up to four authentication servers.

! IMPORTANT

- After configuring an authentication server, restart the scanner to update its display.
- When the authentication server and address book server (LDAP server) are the same, enter values for all of the settings.

- For details on the use and configuration of an authorization server, consult your server administrator.

Server Settings > Authentication Server

Authentication Server1	
Enable authentication server:	<input checked="" type="checkbox"/> Enable
Authentication Method:	Active Directory
Search Base:	(example: cn=users,dc=country,dc=domain,ou=org_unit)
Host Name(Address):	192.111.1.1
Domain:	aa
SSL:	<input type="checkbox"/> Enable
Port number:	389
User name:	
Password:	<input type="checkbox"/> Register / Change password

Enable Authentication Server

Select this check box to permit users registered on the authentication server to log in.

Authentication Method

Select one of the following based on the directory service used by the authentication server.

- Select [Simple] if the directory service used by the authentication server is OpenLDAP.
- Select [Active Directory] if the directory service used by the authentication server is Active Directory.

Search Base

Enter the search base for referring e-mail addresses registered on the authentication server.

! IMPORTANT

For information on the character strings to enter for the search base, consult your system administrator.

Host Name (Address)

Enter the host name or address of the authentication server. For SSL communication, enter the fully qualified domain name (FQDN).

Domain

Enter a NetBIOS domain name supported by Active Directory.

SSL

Select this check box to use SSL communication.

Port number

Enter the port number used for the LDAP protocol. The standard port number is 389.

For SSL communication, the standard port number is 636.

User name

When using the authentication server as an address book server, enter a user name for referring e-mail addresses.

Change Password

When you want to enter a password for the above user, add a checkmark and enter a password.



Hint

Changing the password updates the password information saved on the scanner, but does not alter the password registered on the server.

When server authentication is configured, list boxes for selecting device authentication or server authentication are added to the login screens of the ScanFront scanner and Web Menu (User Mode).

• Web Menu (User Mode) Login Screen

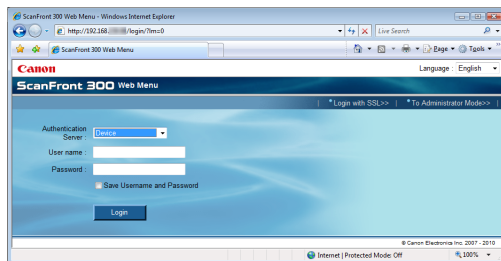

• ScanFront Login Screen

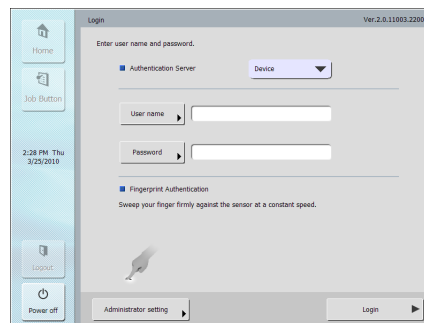

□ Address Book Server

You can configure the settings for using an address book server (LDAP server). You can configure up to four address book servers.

Server Settings > Address Book Server

Address Book Server1	
Address Book Server Setting :	<input checked="" type="radio"/> Not Use <input type="radio"/> Same as Authentication Server <input type="radio"/> Another Server from Authentication Server
Authentication Method :	Anonymous
Search Base :	(example: cn=users,dc=country,dc=domain,ou=org_unit)
Host Name(Address) :	
Port number :	389
User name :	
Password :	<input type="checkbox"/> Register / Change password

Address Book Server Setting

Select one of these options when using an address book server (LDAP server). If the authentication server and address book server are different, make sure to enter values for all of the settings.

For details on each setting, see the settings under “Authentication Server” on p. 6-35.



Hint

When using an address book server that is different from the authentication server, select [Anonymous] for [Authentication Method].

FTP server

You can use a function that transfers a scan result log along with an image file during transfer to the FTP server. When this function is enabled, a scan result log with the same file name as the image file is transferred to the same FTP folder as the image file. The extension for the log file is “.log”.

Server Settings > FTP Server

FTP Server	
<input type="checkbox"/> Enable	
Make "End-of-Batch" log file :	Description : The "End-of-Batch" log file(*.log) will be created in the same directory with the same file name as the image file.
<input type="button" value="OK"/> <input type="button" value="Cancel"/>	

NTP Server

You can configure the NTP server settings to synchronize the ScanFront with the correct time.

Server Settings > NTP Server

NTP Server	
NTP Server Setting :	<input checked="" type="checkbox"/> Enable
NTP Server(primary) :	tock.usno.navy.mil
NTP Server(secondary) :	time.windows.com
<input type="button" value="OK"/> <input type="button" value="Cancel"/>	

NTP Server Setting

Select this check box to synchronize with the NTP server.

NTP Server(primary)

Enter the host name or IP address of the main NTP server.

NTP Server(secondary)

Enter the host name or IP address of the secondary NTP server.

! IMPORTANT

The NTP server and ScanFront are synchronized when [OK] is clicked on the settings screen to complete the settings and every time the ScanFront is started.

ScanFront Service Server

When a ScanFront Service Server (i.e., a computer on which ScanFront Service is installed) exists on the network, use this to specify the host name of the server and the port number used for transmission.

Server Settings > ScanFront Service Server

ScanFront Service Server	
Host Name(Address) :	
Port number :	50000
Description of setting :	Start ScanFront Service before turning ON the device.

💡 Hint

ScanFront Service uses port number 50000 to communicate with the ScanFront by default. If the default port number used by ScanFront Service has been changed (see p. 4-6), make sure to specify the changed port number here.

Certificates

Import the root certificate of the LDAP server to the ScanFront.

! IMPORTANT

The certificates need to be managed by a different system administrator.

💡 Hint

- Only certificates in the CER file format can be imported.
- Up to 50 certificates can be imported.

Importing a Certificate

1. Click [Import certificate].

Server Settings > Certificates

Certificates	
<input type="button" value="Import certificate..."/>	<input type="button" value="Select All"/> <input type="button" value="Except All"/> <input type="button" value="Delete"/>
Total number of certificates: 0 Items / Page : 10 <input type="button" value="Home"/> <input type="button" value="Previous"/> 1 / 1 <input type="button" value="Next"/> <input type="button" value="End"/>	
Name	Expires date
No items to display.	

2. Specify the certificate file to import.

Server Settings > Certificates > Import certificate

Import certificate	
Certificate file :	<input type="button" value="Browse..."/>
<input type="button" value="Update"/> <input type="button" value="Cancel"/>	

3. Click [Update].

Deleting a Certificate

In the certificate list screen, select the check box at the beginning of the line of the certificate you want to delete, and then click [Delete].

8. System Settings

From the System Settings screen, you can backup and restore setting information, update module versions, and configure logs used by the scanner.



① Backup/Restore

Backs up or restores the scanner settings. (See “Backup and Restore” on p. 6-40.)

Be aware that the following settings are not backed up:

- IP address
- Device name
- Touch panel adjustment values
- Imported certificates

② Module Version Information/Version Up

Displays the OS and module version information of the scanner. You can also acquire a version update file to update the ScanFront version. (See “Module Version Information/Update” on p. 6-41.)

! IMPORTANT

For details on acquiring version update files, contact your dealer or a Canon service representative.

③ Log Settings

Records usage statistics to a log file. (See “Log Settings” on p. 6-42.)

④ Screenshot

Saves the ScanFront screen display as a BMP file. (See “Screenshot” on p. 6-43.)

❑ Backup and Restore

You can backup or restore the scanner settings using the following procedure.

Backup All Settings

This option saves all the ScanFront settings to a specified folder.

! IMPORTANT

The following settings are not included in the backup data because they are unique to the scanner unit:

- IP address
- Device name
- Touch panel adjustment values

1. Click [Backup All Settings].



2. Click [Save].

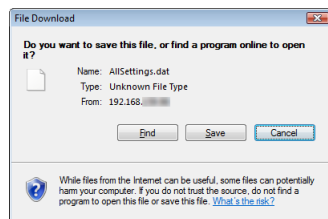

3. Specify a save location for the backup data, and save the backup data.

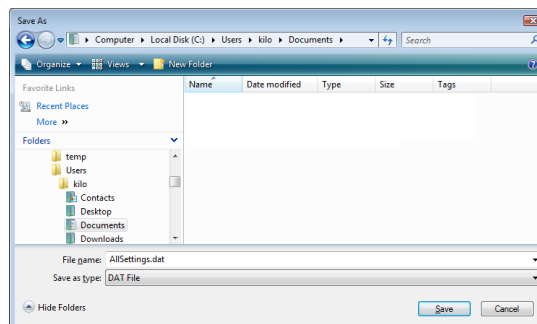

Restore All Settings

This option restores backed up data to the scanner.

1. Confirm that no administrator or user is logged in to the scanner.



Hint

If a user or administrator is logged in to the scanner, an error will occur when the restoration is performed.

2. Click [Browse], and specify the backup data to use.

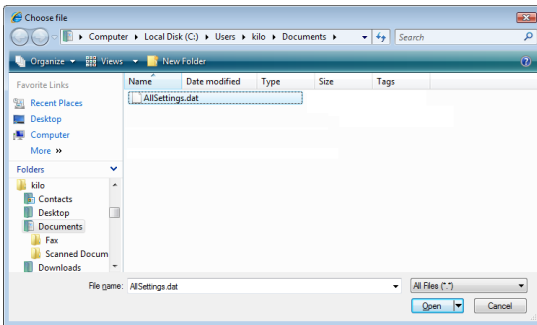

3. Click [Restore].

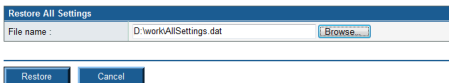

4. Confirm the message that appears, and click [OK] to perform the restoration.

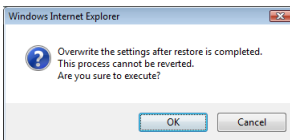

5. Click [OK] to complete the restoration.



6. Confirm the restored settings.

Module Version Information/Update

You can display the version information, and update the version, of the module in use on the scanner.

! IMPORTANT

If the scanner malfunctions, the version information is required when contacting support services.

Acquiring Update Files

For details on acquiring the update files needed to update the scanner, consult your dealer or a Canon service representative.



Hint

For ScanFront 330, only the update files of Standard Mode can be applied.

Updating the Scanner

You can update the scanner with an acquired update file.

! IMPORTANT

- Make sure to back up your scanner data before performing a version update.
- Use the following procedure to update the scanner. Once the version update starts, do not touch the scanner until it restarts.
 1. Transfer the update file to the scanner.
 2. Update the version of the scanner.
 3. Restart the scanner (automatic).

1. Confirm that no one is using the scanner.
2. Back up all settings. (See "Backup and Restore" on p. 6-40.)

3. Click [Browse], and specify the update file to use.

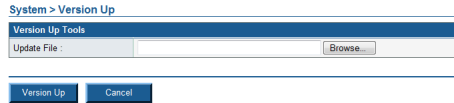

4. Click [Version Up].



5. Confirm the message that appears, and click [OK] to perform the version update.

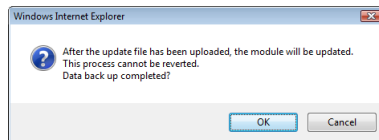

! IMPORTANT

- It takes several minutes to transfer the update file to the scanner. Do not operate the Web Menu or scanner until the Web Menu changes to the following display.

Information

Module upgrade started. Confirm that the device is being upgraded.
Logging in to the Web menu will be enabled after the upgrade is complete.

- Version update may take longer if a large quantity of setting information is set on the scanner.

6. Click [OK] to close the Web Menu.

! IMPORTANT

When the update file finishes transferring, the version update starts. Do not operate the scanner until the version update is complete and the scanner restarts.

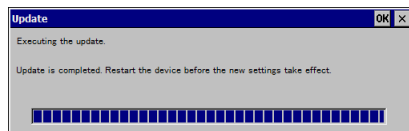

7. Configure the IP address, and then restore the backup file from the Web Menu.

Log Settings

You can configure settings for log files.



Hint

- ScanFront Service is not used for log settings.
- The log file is a text file in CSV format. You can view the information of the log file in an application that supports CSV format.

System > Log Settings

Log Settings	
Make Log File :	<input type="checkbox"/> Make
PC Name (Host Name) :	<input type="text"/>
Location :	<input type="text"/> <input type="button" value="Browse..."/>
User name :	<input type="text"/>
Password :	<input type="text"/>
Domain / Workgroup :	<input type="text"/>
File name :	0000582001* <input type="button" value="(plus Date)"/>

OK Cancel

Make Log File

Select this check box to create a log file.

PC Name (Host Name)

Enter the name of the computer containing the publicly shared folder where the log file will be saved.

Location

Enter the name of the shared folder. You can also press [Browse] to select a folder to save.

User name/Password

Enter the name and password of a user with the authority to write data to the shared folder.

Domain/Workgroup

If the computer containing the shared folder is part of a domain, enter the domain name.

! IMPORTANT

If the computer containing the shared folder is part of a domain, enter the user name and password registered with the domain, and the domain name.

File name

Enter a name for the log file.

**Hint**

The date and time that the log file was created are added to the entered file name.

❑ Screenshot

Save the ScanFront screen display as a BMP file.

1. Click [Execute] when the screen you want to save is displayed.

[System > Capture a screen shot](#)

Click Execute button to capture screen shot of the device.

Execute

2. Open or save the screenshot as described in the message.

Chapter 7 ScanFront Administration Tool

1. About ScanFront Administration Tool	7-2
2. Installing ScanFront Administration Tool	7-3
System Requirements	7-3
Installation	7-3
3. ScanFront Administration Tool Setup	7-5
Starting ScanFront Administration Tool	7-5
Registering ScanFront Scanners	7-5
4. Managing the ScanFront Scanners	7-6
Selecting a ScanFront	7-6
Checking ScanFront Connections	7-6
Changing Passwords	7-6
Changing IP Addresses and Device Names	7-7
Checking Detailed Information on the ScanFront	7-7
Displaying the Web Menu	7-7
Batch Processing	7-7
Importing/Exporting Administration Data	7-8

1. About ScanFront Administration Tool

ScanFront Administration Tool is software that allows you to manage multiple ScanFront scanners at one time. To use this software, install it on a computer connected to the same network as the ScanFront scanners.

The following operations can be performed for ScanFront scanners on the same network.

- Checking the current status of the ScanFront and network configuration information
- Changing passwords
- Configuring the ScanFront
- Checking connections
- Updating software
- Backing up and restoring configuration data
- Removing users
- Importing certificates

2. Installing ScanFront Administration Tool

□ System Requirements

Install ScanFront Administration Tool on a computer that is connected to the same network as the ScanFront scanners, and that meets the following requirements.

Operating System

- Windows XP (32 bit/64 bit)
- Windows Server 2003 (32 bit/64 bit)
- Windows Vista (32 bit/64 bit)
- Windows Server 2008 (32 bit/64 bit)
- Windows Server 2008 R2
- Windows 7 (32 bit/64 bit)
- Windows 8 (32 bit/64 bit)
- Windows Server 2012 (64 bit)

□ Installation

1. Insert the application disc into the computer.
2. Start the ScanFront Administration Tool installer. Use Windows Explorer, for example, to locate the installer in the following folder on the disc, and double-click the installer to start it.
Q: \AdministrationTool\setup.exe (“Q” is the letter assignment for the disc drive)

3. Click [Next].

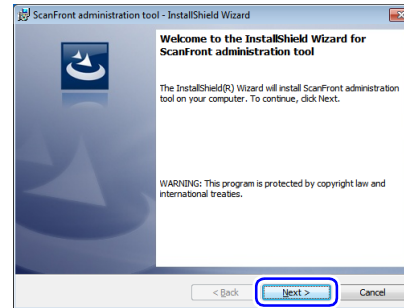

4. Select “I accept the term in the license agreement” and then click [Next].

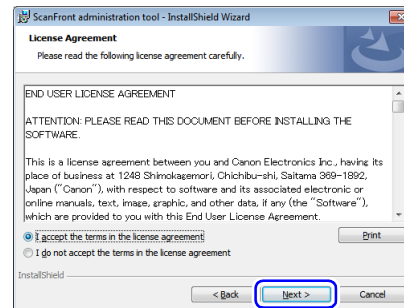

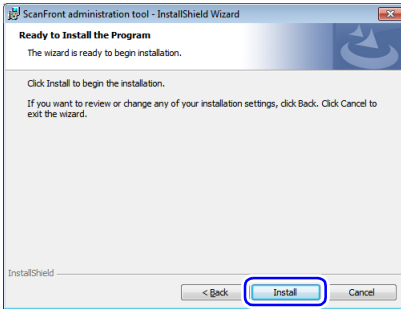
5. Click [Install].

Installation starts. When installation is complete, a screen indicating that installation is complete appears.

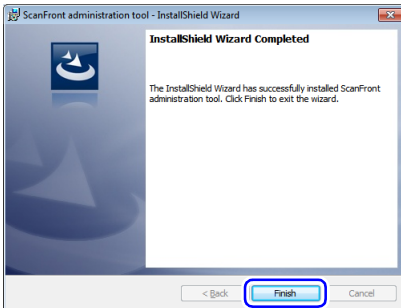
6. Click [Finish].

3. ScanFront Administration Tool Setup

□ Starting ScanFront Administration Tool

Click the [Start] button, [All Programs], [ScanFront Administration Tool], and then [ScanFront Administration Tool]. ScanFront Administration Tool starts.

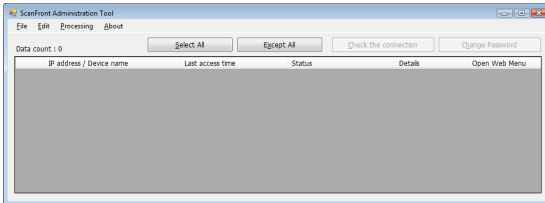

□ Quitting ScanFront Administration Tool

Click [Close] in the [File] menu.

□ Registering ScanFront Scanners

To manage a ScanFront scanner using ScanFront Administration Tool, add the ScanFront to the ScanFront Administration Tool list as follows.

1. Click [Add] in the [Edit] menu.
The [Create new items] window appears.

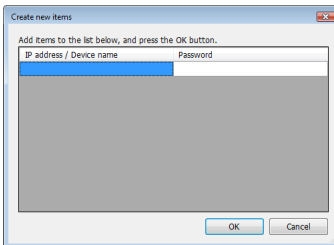

2. Enter information for the ScanFront you want to register.
 - Enter the IP address of the ScanFront in [IP address/ Device name].
 - If an administrator password is configured for the ScanFront, enter it in [Password].
 - After you enter an IP address for a ScanFront, another information entry row will be added below. This allows you to enter information for multiple ScanFront scanners.
3. Click [OK].

The registered ScanFront scanners are added to the ScanFront Administration Tool list.

Deleting Registered ScanFront Scanners

In the ScanFront Administration Tool list, select the check box at the far left of the row for the ScanFront you want to delete, and then click [Delete] in the [Edit] menu.

4. Managing the ScanFront Scanners

You can change administrator passwords, check connections, and manage users for ScanFront scanners registered in ScanFront Administration Tool.

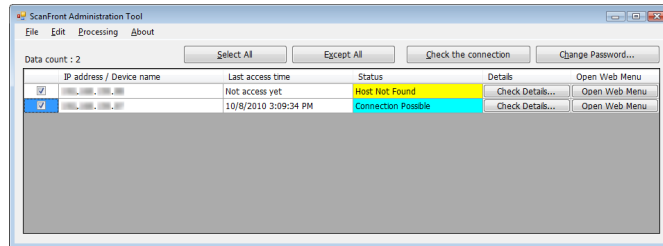

❑ Selecting a ScanFront

To manage a ScanFront scanner with ScanFront Administration Tool, select it in the ScanFront Administration Tool list. Selecting a check box at the far left of each row in the list selects the corresponding ScanFront.

If you click [Select All], all of the ScanFront scanners in the list will be selected. If you select [Except All], all of the selections in the list will be cleared.

❑ Checking ScanFront Connections

Select a ScanFront scanner in the list, and click [Check the connection] to check the connection of the selected ScanFront.

The results of the check appear in the [Status] column. For example, “Connection Possible” appears when the ScanFront is properly connected.

❑ Changing Passwords

Select a check box at the far left of each row in the list, click the [Change Password] button to display the [Password] dialog box, and then change the password for the selected ScanFront.

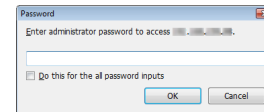

After you enter the new password and click [OK], the [Password] dialog box will close, and the password will be changed.

Hint

If multiple ScanFront scanners are selected, a dialog box for changing the password of the first selected ScanFront in the list appears. A dialog box for changing the password of the next ScanFront appears when you click [OK]. To configure the same password for all the ScanFront scanners, select the [Do this for the all password input] check box before clicking [OK].

❑ Changing IP Addresses and Device Names

Double-click a ScanFront scanner in the list to display the [IP Address / Device Name] dialog box, and then change the IP address or device name of the selected ScanFront.

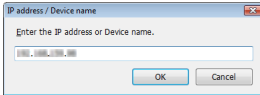

After you enter the IP address or device name and click [OK], the dialog box will close, and the specified IP address or device name will be applied.

❑ Checking Detailed Information on the ScanFront

Click the [Check Details] button that appears for the ScanFront scanners registered in the list to display the [Details] window.

! IMPORTANT

You can only perform this operation for ScanFront scanners to which ScanFront Administration Tool is able to connect.

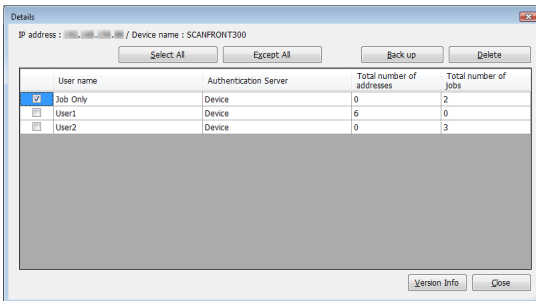

A list of users registered to the ScanFront appears in the [Details] window.

You can use the following buttons in the window to manage the users registered to the ScanFront.

- To select a user for an operation, select the check box that appears at the far left of each row. Clicking [Select All] or [Except All] selects or clears all of the user check boxes in the list, respectively.
- Click [Back up] to backup configuration data for users selected in the list to any location on the computer.
- Click [Delete] to delete the users selected in the list.
- Click [Version Info] to display version information for the ScanFront.
- Click [Back] to close the [Details] window.

❑ Displaying the Web Menu

When you select a ScanFront scanner in the list and click the [Open Web Menu] button, the Web browser starts and the Web Menu for the selected ScanFront is displayed.

! IMPORTANT

You can only perform this operation for ScanFront scanners to which ScanFront Administration Tool is able to connect.

❑ Batch Processing

You can select multiple ScanFront scanners in the list, and select a command in the [Processing] menu to perform the same operation all of the selected ScanFront scanners at one time.

The following commands are available in the [Processing] menu.

[Restore All Settings]

Load backed up ScanFront data stored on the computer, and restore settings on all selected ScanFront scanners.

[Backup All Settings]

Save the backup data of all selected ScanFront scanners to any location on the computer.

[Import User Data]

Load ScanFront user data stored on the computer, and register it to all selected ScanFront scanners.

[Export User Data]

Save the user data of all selected ScanFront scanners to any location on the computer.

[Version Up]

Load ScanFront firmware stored on the computer, and update the firmware version of all selected ScanFront scanners.

[Import Certificate]

Import the SSL certificate for the LDAP server.

□ Importing/Exporting Administration Data

You can export administration data for ScanFront Administration Tool to any location on the computer, and import exported administration data.

Exporting Administration Data

Click [Export] in the [Edit Data] menu, specify a destination and file name for the administration data in the dialog box that appears, and then click [Save].

Importing Administration Data

Click [Import] in the [Edit Data] menu, specify the storage location and file name for the administration data in the dialog box that appears, and then click [Open].

Chapter 8 Web Menu (User Mode)

1. Web Menu Overview	8-2
2. Logging In to the Web Menu.....	8-3
3. User Settings	8-4
User Settings.....	8-5
4. Address Book Settings	8-9
Registering New Addresses.....	8-11
Copying Addresses	8-14
Exporting and Importing Address Books	8-14
5. Job Button Settings.....	8-16
Registering New Job Buttons.....	8-18
Scan Settings Overview	8-19
Copying Job Buttons	8-23
Editing Jobs.....	8-24
Exporting and Importing Job Buttons	8-24

1. Web Menu Overview

The Web Menu function enables you to access and configure the scanner from the Web browser of a remote computer. From the Web Menu, you can register address books and job buttons.

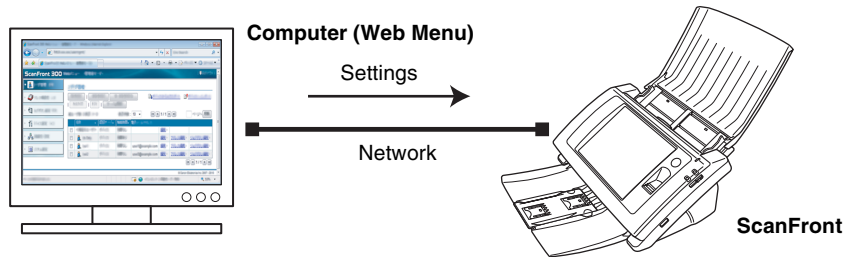

! IMPORTANT

- For a Web browser, use Microsoft Internet Explorer 6.0 or later or Firefox 3.5 or later.
- In some cases, settings cannot be changed from the Web Menu when the ScanFront administrator or another user is logged in to the scanner.
- Use the device name or IP address assigned to the scanner as the URL for logging in to the Web Menu. (See p. 8-3.)
- When you open the Web Menu, an SSL-certificate warning will appear. However, you can proceed and open the Web Menu safely.

Web Menu (User Mode)

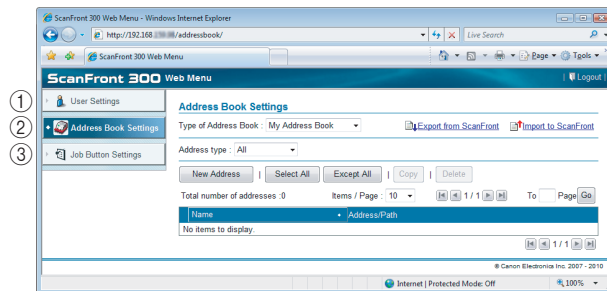

- ① **User Settings** (See "User Settings" on p. 8-5)
Use to change the user settings.
- ② **Address Book Settings** (See "Address Book Settings" on p. 8-9)
Use to register and manage entries in the Shared Address Book available to all users, and the My Address Book provided for each user.

- ③ **Job Button Settings** (See "Job Button Settings" on p. 8-16)
Use to register and manage the Shared Job Button available to all users, and the My Job Button provided for each user.

2. Logging In to the Web Menu

You can log in to the Web Menu using the following procedure.



Hint

Use the device name or the IP address assigned to the scanner as the URL for accessing the Web Menu. Contact the ScanFront administrator for the device name and the IP address.

1. Turn the scanner ON.
2. Confirm the IP address with the administrator.
3. Launch the Web browser on the computer.
4. Enter the device name or the IP address as the URL to open the Web Menu.

Ex.) `http://scanfront300` when the device name is ScanFront300,
and `http://172.19.xxx.xxx` for the IP address.

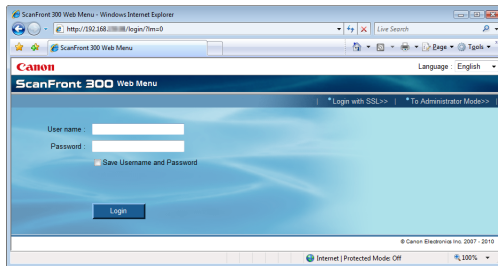

Hint

If the Web Menu is set to Administrator Mode, click [To User Mode].

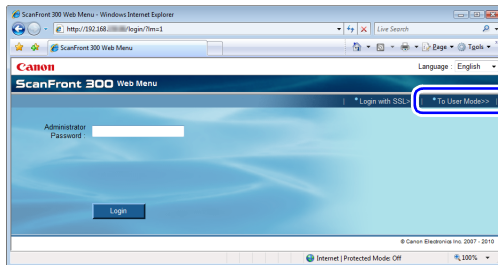

! IMPORTANT

If [Authentication Method] appears above [User name] on the login screen, users can log in from an account registered on a domain server (Server Authentication), instead of logging in from an account registered on the scanner (Device Authentication). For details, consult the ScanFront administrator.

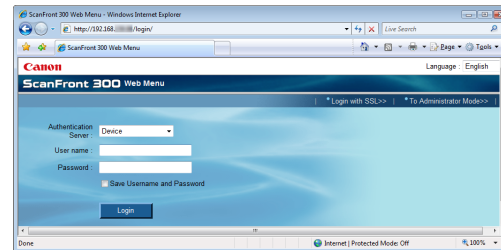

5. Enter a user name and password to log in to the Web Menu.

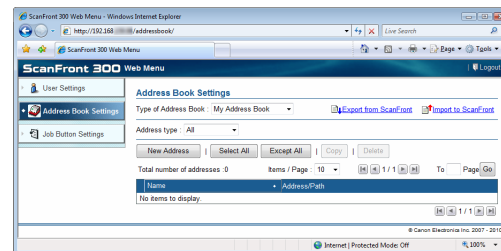

! IMPORTANT

User names and passwords are case-sensitive. Make sure to enter them correctly.

3. User Settings

From the User Settings screen, you can change the information of a user logged in by Device Authentication.

ScanFront 300 Web Menu - Windows Internet Explorer

http://.../user/

ScanFront 300 Web Menu

ScanFront 300 Web Menu | Logout

User Settings

User Settings

User name : user1

Password : none

Mail Address : user@example.com

Initial Screen : Home

Default Address Book screen : My Address Book

Default Job Button screen : My Job Button

E-mail to my mailbox : Enable

Custom file name Settings

Description of setting : Various information can be added to the sending image file name.

Separator : Disable

1. String :

2. User name : Disable

3. Date : Disable

4. Time : Disable

5. Device name : Disable

6. Counter : Disable

Index settings

Description of setting : Various information when the scanning is executed at the same time as transmitting the scanned image file can be transmitted as a file of the index of the xml or csv form.

Index string :

Field name : String

User name : Disable

Date : Disable

Time : Disable

Device name : Disable

Counter : Disable

File name : Disable

File size : Disable

Number of Pages : Disable

Destination path : Disable

Index file format : CSV

© Canon Electronics Inc. 2007 - 2010

- ① Setting (See “User Settings” on p. 8-4)
Allows you to edit a user’s settings.

❑ User Settings

Click [Setting] to edit the user information.

User Settings

User Settings > Edit

User Settings	
Authentication Server :	Device
User name :	user1
Change password :	<input type="checkbox"/> Change Password
Password :	<input type="text"/>
Password(confirmation) :	<input type="text"/>
Mail Address :	user1@example.com
Screen after Login :	<input checked="" type="radio"/> Home <input type="radio"/> Job Button screen
Default Address Book screen :	<input checked="" type="radio"/> My Address Book <input type="radio"/> Shared Address Book
Default Job Button screen :	<input checked="" type="radio"/> My Job Button <input type="radio"/> Shared Job Button
E-mail to my mailbox :	<input checked="" type="checkbox"/> Enable

• User name

Enter a new user name.

• Change Password

Select the [Change Password] check box, and then enter the new password and confirmation password.

• Mail Address (Not Changeable)

To change the e-mail address, contact the ScanFront administrator.

• SMTP/POP Before SMTP Authentication

Appears when [Auth Method] is configured to any setting other than [SMTP] by the administrator in the mail server settings (see p. 6-34). Enter the [User name] and [Password] that will be used for mail server authentication here.

! IMPORTANT

- When entering a [Password], select the [Change Password] check box before entry.
- [Change Password] updates the password information saved on the scanner, but does not alter the password registered on the server.
- For a user logged in by Server Authentication, you can only select a setting for [Screen after Login].

- E-mail address may not be registered for a user logged in by Server Authentication. For details on e-mail address settings, consult the ScanFront administrator.
- Screen after Login
Select the Home screen or the Job Button screen as the first screen to appear after the user logs in.

Home Screen



Job Button Screen

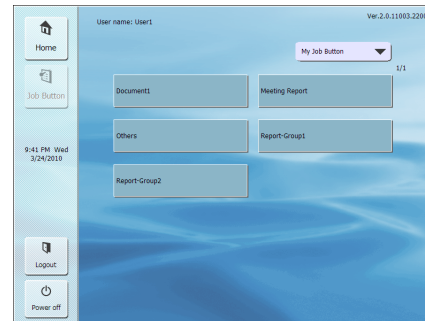

! IMPORTANT

- The setting for the startup screen after login also affects which screen appears after a scanned image is sent. (See "Delivery Options" on p. 8-18.)
- If the ScanFront administrator has restricted use of the Home screen, only [Job Button screen] is available for the [Screen after Login] setting. For details, consult the ScanFront administrator.

- **Default Address Book screen**
Select “My Address Book” or “Shared Address Book” for the address book type when the address selection screen is displayed from the Home screen.
- **Default Job Button screen**
Select “My Job Button” or “Shared Job Button” for the job button type when the job button screen is displayed after login.
- **E-mail to my mailbox**
Select the [Enable] check box to display the e-mail address of the logged in user in the address book.
If an e-mail address is set for the user, the user’s e-mail address will be displayed even if it has not been registered in the address book.
The user’s e-mail address is displayed at the very top of the address list.

Custom File Name Settings

Specify the method in which file names used for saving scanned images are created. When you select to use custom file names during a scanning procedure, the image files will be saved under file names that are determined by the settings configured here. Components of the custom file name will be included in the order that they appear on this screen.

Custom file name Settings	
Custom file name	
Description of setting :	Various information can be added to the sending image file name.
Separator :	<input type="checkbox"/> Enable (-Hyphen) ▾
1. String :	<input type="text"/>
2. User name :	<input type="checkbox"/> Enable
3. Date :	<input type="checkbox"/> Enable yyyyymmdd ▾
4. Time :	<input type="checkbox"/> Enable hhmmss ▾
5. Device name :	<input type="checkbox"/> Enable
6. Counter :	<input type="checkbox"/> Enable (Counter settings become effective only when using a single page setting.)
Start number :	<input type="text" value="0"/>
Number of digits :	<input type="text" value="0"/>

! IMPORTANT

The following characters cannot be used to set the custom file name:

/ : ? * " < > |

- **Separator**
Select the [Enable] check box to include a separator between character strings in the file name, and select a character to use as the separator in the list box.
- **String**
Specify a string to include in the file name.
- **User name**
Select the [Enable] check box to include the user name in the file name.
- **Date**
Select the [Enable] check box to include the date in the file name, and select a format for the date in the list box.
- **Time**
Select the [Enable] check box to include the time in the file name, and select a format for the time in the list box.
- **Device name**
Select the [Enable] check box to include the device name in the file name.
- **Counter/Start number/Number of digits**
Select the [Enable] check box to include a counter in the file name. When this is enabled, you can specify the starting value and number of digits used for the counter.

Index Settings

Specify the content of index files (metadata) that are attached to scanned image files. Components of the index file will be included in the order that they appear on this screen.

Index settings	
Description of setting :	Various information when the scanning is executed at the same time as transmitting the scanned image file can be transmitted as a file of the index of the xml or csv form.
Index string :	<input type="text"/>
Field name :	String <input type="text"/>
User name :	<input type="checkbox"/> Enable
Field name :	<input type="text"/>
Date :	<input type="checkbox"/> Enable
Format :	yyyyMMdd <input type="text"/>
Field name :	<input type="text"/>
Time :	<input type="checkbox"/> Enable
Format :	hhmmss <input type="text"/>
Field name :	<input type="text"/>
Device name :	<input type="checkbox"/> Enable
Field name :	<input type="text"/>
Counter :	<input type="checkbox"/> Enable
Start number :	0 <input type="text"/>
Number of digits :	0 <input type="text"/>
Field name :	<input type="text"/>
File name :	<input type="checkbox"/> Enable
Field name :	<input type="text"/>
File size :	<input type="checkbox"/> Enable
Field name :	<input type="text"/>
Number of Pages :	<input type="checkbox"/> Enable
Field name :	<input type="text"/>
Destination path :	<input type="checkbox"/> Enable
Field name :	<input type="text"/>
Index file format :	<input type="radio"/> XML <input checked="" type="radio"/> CSV

IMPORTANT

The following characters cannot be used in strings contained in the index file:

& " ' < >

- **Index string/Field name**
Enter a string for the index. You can change the default field name (“String”) as necessary.
- **User name**
Select the [Enable] check box to include the user name in the index file. You can change the default field name (“User”) as necessary.

- **Date**
Select the [Enable] check box to include the date in the index file, and select a format for the date in the [Format] list box. You can change the default field name (“Date”) as necessary.
- **Time**
Select the [Enable] check box to include the time in the index file, and select a format for the time in the [Format] list box. You can change the default field name (“Time”) as necessary.
- **Device name**
Select the [Enable] check box to include the device name in the index file. You can change the default field name (“Device”) as necessary.
- **Counter/Start number/Number of digits**
Select the [Enable] check box to include a counter in the index file. When this is enabled, you can specify the starting value and number of digits used for the counter. You can change the default field name (“Counter”) as necessary.
- **File name**
Select the [Enable] check box to include the file name in the index file. You can change the default field name (“FileName”) as necessary.
- **File size**
Select the [Enable] check box to include the file size in the index file. You can change the default field name (“FileSize”) as necessary.
- **Number of Pages**
Select the [Enable] check box to include the number of pages that are in the scanned image in the index file. You can change the default field name (“PageNumber”) as necessary.
- **Destination path**
Select the [Enable] check box to include the destination path in the index file. You can change the default field name (“Folder”) as necessary.
- **Index file format**
Specify a file format for the index files.

[OK] button

Updates the user information with the changed settings.

4. Address Book Settings

From the Address Book Settings screen, you can register entries in the Shared Address Book, which is available to all users, and the My Address Book, which is provided for each user.

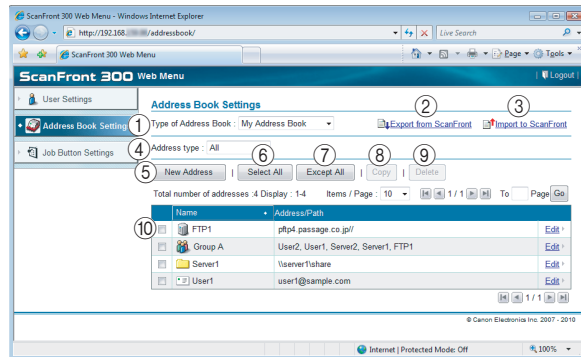

① Type of Address Book

Selects the address book (Shared Address Book or My Address Book) to edit.

The LDAP Address Book is also selectable if the address book server settings are enabled and permission to use the LDAP address book has been granted to the user. The address type is set to [E-mail] when the LDAP Address Book is selected.

② Export from ScanFront

Exports the address book data as a file in CSV format. (See “Exporting and Importing Address Books” on p. 8-14.)

③ Import to ScanFront

Imports a previously exported address book data file. (See “Exporting and Importing Address Books” on p. 8-14.)

④ Address type

Selects the type of addresses (E-mail, FTP Server, Shared folder, Group, or All) to display.

⑤ [New Address] button

Registers a new address book entry. (See “Registering New Addresses” on p. 8-11.)

⑥ [Select All] button

Selects all of the displayed addresses.

⑦ [Except All] button

Deselects all of the displayed addresses.

⑧ [Copy] button

Copies the selected address. Only enabled when an address is selected. (See “Copying Addresses” on p. 8-14.)

⑨ [Delete] button

Deletes the selected address. Only enabled when an address is selected.

⑩ Address List

Displays the registered addresses.

- Check box: Select this check box to select an address.
- Address type (icon)

 : FTP

 : Shared folder

 : E-mail

 : Fax

 : Group

- Edit: Click to edit an address.

! IMPORTANT

If the ScanFront administrator has restricted editing of the address books, the following Address Book settings apply. For details, consult the ScanFront administrator.

- If editing is restricted for only one address book (either the My Address Book or the Shared Address Book), users can only copy addresses from the restricted address book and paste them into the unrestricted address book.

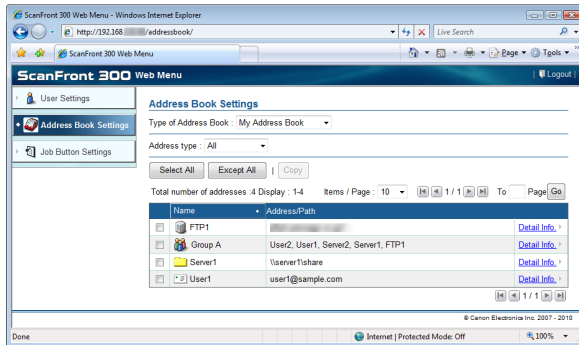

- If editing is restricted for both the My Address Book and the Shared Address Book, users can only view detailed address information.

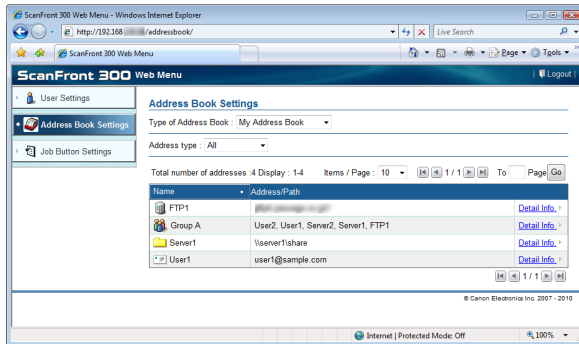

❑ Registering New Addresses

Select the type of address book (Shared Address Book or My Address Book), and click [New Address] to register a new address.



Hint

- The number of addresses that can be registered to the Shared Address Book (My Address Book) is up to 1000 in combination with the total number of addresses included in the Shared Job Button (My Job Button).
- For the number mentioned above, the count for a group is the number of addresses registered to the group (maximum of 99 addresses) plus the group name, so a group with 99 addresses registered to it is counted as having 100 addresses.
- The available settings vary, depending on the type of address (E-mail, FTP Server, Shared folder, Fax, or Group).

Address type: E-mail

This option registers an e-mail address.

Address Book Settings > My Address Book > New Address

Address type : E-mail

Address Book Settings - E-mail

Name :

E-mail Address :

OK Cancel

Name

Enter the name to display on the scanner.

E-mail Address

Enter the destination e-mail address.

[OK] button

Registers a new e-mail address with the specified parameters.

Address type: FTP Server

This option registers a network FTP server.

! IMPORTANT

FTP servers that require firewall settings cannot be registered.

Address Book Settings > My Address Book > New Address

Address type : FTP Server

Address Book Settings - FTP Server

Name :

FTP server :

Folder path : Browse

Port number :

User name :

Password :

Save Password : Save Password

Passive Mode : Passive Mode

OK Cancel

Name

Enter the name to display on the scanner.

FTP server

Enter the IP address or host name of the FTP server.

Folder path

To specify a subfolder on the FTP server, enter the path to the subfolder.



Hint

If you are unsure of the subfolder's path, use the following procedure to specify the subfolder:

1. After entering the [FTP server], [User name], and [Password], click [Browse] and log in to the FTP server.
2. In the folder that appears, specify any subfolder and click [OK].

User name/Password

Enter the user name and password required to log in to the FTP server.

! IMPORTANT

Make sure to enter the user name and password of an account with the authority to write data to the FTP server.

Port number

Enter the port number. The standard port number is 21.

Save Password

Saves the entered password.

Passive Mode

Uses passive mode to send transmissions to the FTP server.

! IMPORTANT

Use passive mode when normal communication with the FTP server cannot be established. However, be aware that communication may not be possible if the network is not functioning properly.

[OK] button

Registers a new FTP server with the specified parameters.

Address type: Shared folder

This option registers a folder shared publicly on the network.

Address Book Settings > My Address Book > New Address

Address type : Shared folder ▾

Address Book Settings - Shared folder

Name :	<input type="text"/>
Computer Name (Host Name) :	<input type="text"/>
Folder path :	<input type="text"/> <input type="button" value="Browse..."/>
User name :	<input type="text"/>
Password :	<input type="password"/>
Domain / Workgroup :	<input type="text"/>
Save Password :	<input type="checkbox"/> Save Password

In order to display the list of all computers in a certain domain, please enter "User name" and "Password" to log in that domain, then click the "Browse" button.

Name

Enter the name to display on the scanner.

Computer Name (Host Name)

Enter the name of the computer containing the publicly shared folder. When the ScanFront Service is running, you can enter the IP address instead of a host name.

Folder path

Enter the path to the subfolder that you want to register as the name of the shared folder.

[Browse] button

Shows a list of computers connected to the network for you to specify a shared folder.

Hint

You can display the shared folders using the following procedure.

1. After entering the computer name, user name, password, and domain/workgroup, click [Browse]. Access the computer containing the publicly shared folder.
2. Specify any subfolder from the displayed computer and click [OK].

! IMPORTANT

- If you click [Browse] without entering the user account information, only computers and workgroups within the same network address will display.
- When displaying workgroups that are not part of a domain, you cannot display computers or workgroups with different network addresses.
- Not all workgroups and computers in the network can be displayed immediately after the ScanFront is started. If some workgroups and computers are not displayed, wait a few minutes and then press [Browse].
- A new folder cannot be created in a specified folder via the Web Menu. If you want to create a new folder, use the computer set as the FTP server or the address editing functions of the ScanFront to create a folder beforehand.

User name/Password

Enter the user name and password of an account with the authority to write data to the shared folder.

Domain/Workgroup

If the computer containing the shared folder is part of a domain, enter the domain name.

! IMPORTANT

- If the computer containing the publicly shared folder is part of a domain, enter the user name and password registered with the domain, and the domain name.
- If the computer containing the publicly shared folder is not part of a domain, there is no need to enter a [Domain/Workgroup].

Save Password

Select this check box to save the password to the address.

IMPORTANT

If you do not save the password, password entry will be required each time you send.

[OK] button

Registers a new shared folder with the specified parameters.

Address type: Fax

This option registers a fax destination.

Address Book Settings > My Address Book > New Address

Address type : Fax

Address Book Settings - Fax

Name :

Fax number :

OK Cancel

Fax number

Enter the fax number of the destination.

[OK] button

Registers a new fax destination with the specified parameters.

Address type: Group

This option registers several registered addresses together as a group.

Hint

Different types of address, such as e-mail addresses and shared folders, can be registered as a group, and up to 99 addresses can be registered to 1 group.

Address Book Settings > My Address Book > New Address

Address type : Group

Address Book Settings - Group

Name :

Address Settings Add from Address Book

Total number of addresses: 0 Items / Page: 10 To: Page: Go

Name	Address/Path
No items to display.	

OK Cancel

Name

Enter the name to display on the scanner.

Add from Address Book

Allows you to select an address from an address book, add it to the group, and display it in the list.

[OK] button

Registers a new group with the specified parameters.

❑ Copying Addresses

You can copy an address and register it as a new address. You can also copy an address from one address book to another.

As an example, this section describes how to copy from the Shared Address Book to the My Address Book.

Hint

Use this function when you want to copy an address between the Shared Address Book and My Address Book or copy an address and register it as a different address in the same address book after changing some of the settings.

1. Select Shared Address Book for the [Type of Address Book].
2. Add a checkmark to the check box of the address you want to copy and then click [Copy].

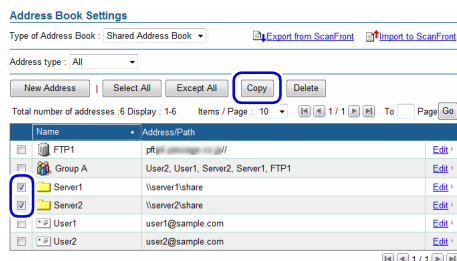

3. Select My Address Book for the copy destination, and click [OK].

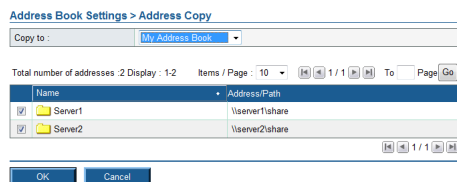

4. Confirm the copied address.

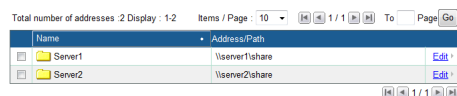

❑ Exporting and Importing Address Books

You can back up your address books as files in CSV format, and import the backed up address book data to another ScanFront unit.

Hint

If you have multiple ScanFront units, you can use the same address books on all of them by importing the address book settings file registered on one ScanFront unit to the other units.

Exporting from the Scanner

You can save the address book data to a specified folder.

1. Click [Export from ScanFront].

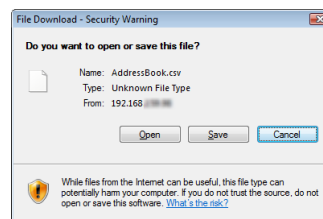

2. Click [Save], specify a save location, and save the address book data.

Hint

- You can open the saved CSV file with software that supports CSV files such as spread sheet software in order to check the structure of the file.
- You can match the structure of a CSV file created in another mailer to that of a CSV file saved on the ScanFront, and then import the address book of the other mailer and use it on the ScanFront.

Importing to the Scanner

You can import previously exported address book data to the scanner.

1. Click [Import to ScanFront].

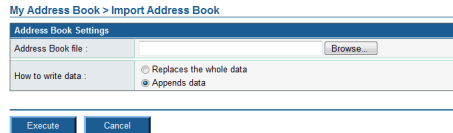

2. Click [Browse] and specify a previously exported address book settings file.

3. Select a processing method for importing the address book settings file.

- **Replaces the whole data:** Deletes all currently registered address book entries and overwrites them with the imported address book data.
- **Appends data:** Adds the imported address book data to the currently registered address book.

4. Click [Execute].

Confirm the message that appears, and click [OK] to import the data.

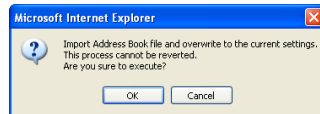

Hint

When importing is completed, the following message appears. Click [OK] to return to Address Book Settings and confirm the imported address data.

Information

Importing of the "D:\work\MyAddressBook.csv" file is complete.



5. Job Button Settings

From the Job Button Settings screen, you can register the Shared Job Button, which is available to all users, and the My Job Button, which is provided for each user.

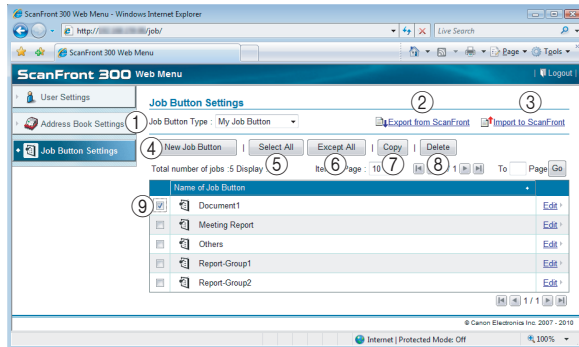

- ① **Job Button Type**
Select the job button (Shared Job Button or My Job Button) that you want to edit.
- ② **Export from ScanFront**
Exports the job button data as a file in DAT format. (See “Exporting and Importing Job Buttons” on p. 8-24.)
- ③ **Import to ScanFront**
Imports a previously exported job button data file. (See “Exporting and Importing Job Buttons” on p. 8-24.)
- ④ **[New Job Button] button**
Registers a new job button. (See “Registering New Job Buttons” on p. 8-18.)
- ⑤ **[Select All] button**
Selects all of the displayed job buttons.
- ⑥ **[Except All] button**
Deselects all of the displayed job buttons.
- ⑦ **[Copy] button**
Copies the selected job button. Only enabled when a job button is selected. (See “Copying Job Buttons” on p. 8-23.)
- ⑧ **[Delete] button**
Deletes the selected job button. Only enabled when a job button is selected.
- ⑨ **Job Button List**
Displays the registered job buttons.
 - **Check box:** Select this check box to select a job button.
 - **Edit:** Click to edit a job button.

! IMPORTANT

If the ScanFront administrator has restricted editing of the job buttons, the following Job Button settings apply. For details, consult the ScanFront administrator.

- If editing is restricted for only one set of job buttons (either the My Job Button or the Shared Job Button), users can copy job buttons from the restricted set of job buttons and paste them into the unrestricted set.

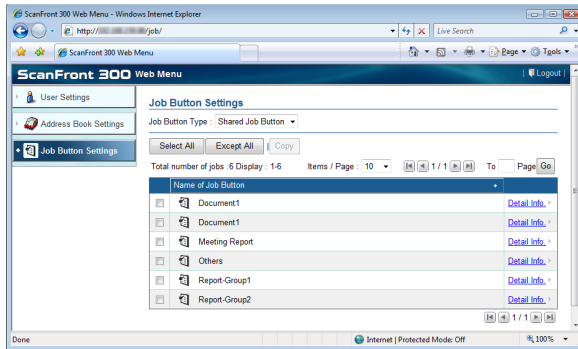

- If editing is restricted for both the My Job Button and the Shared Job Button, users can only view detailed job button information.

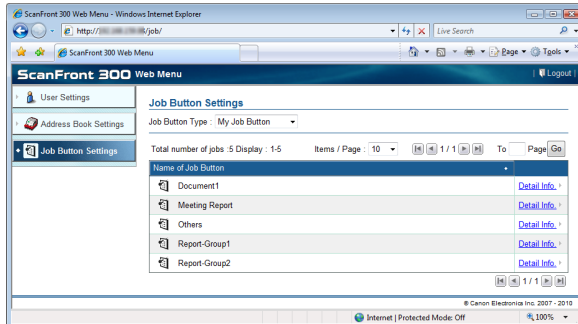

❑ Registering New Job Buttons

Click [New Job Button] to register a new job button.

Job Button Settings

Job Button Settings > Shared Job Button > New Job Button

Job Button Settings	
Name of Job Button :	0 / 48 characters · 1 / 2 lines
Color of Job Button :	<input checked="" type="radio"/> Blue <input type="radio"/> Yellow <input type="radio"/> Pink <input type="radio"/> Red <input type="radio"/> Orange <input type="radio"/> Purple <input type="radio"/> Skyblue
When you select this Job Button :	Display Scan Setting Screen ▾

Name of Job Button

Enter the job button name to display on the touch panel.



Hint

- Job buttons are sorted and displayed by job button name. If you want to set to display job buttons in a particular order, insert sequential letters or numbers before the name when registering each job button. Ex.) O1_xxxx
- If you enter a job button name that is two lines long, the job button display will be two lines long.

Color of Job Button

Specify a color for the job button.

When you select this Job Button

- **Display Scan Setting Screen**
Displays the Scan Setting screen when the job button is pressed.
- **Skip Scan Setting Screen**
Starts scanning without displaying the Scan Setting screen when the job button is pressed.



IMPORTANT

If you select [Skip Scan Setting Screen], scanning starts as soon as the job button is pressed, whether a document is inserted or not.

Address

Address	
Total number of addresses : 0	Items / Page : 10
Name	To/Co/Bcc
No items to display.	

Click [Add from Address Book], open the Address page, and select the address to send to.



IMPORTANT

- You can register up to 100 addresses to a job button.
- For the number mentioned above, the count for a group is the number of addresses registered to the group (maximum of 99 addresses) plus the group name, so a group with 99 addresses registered to it is counted as having 100 addresses.

Scan Settings/Detailed settings

For details on Scan Settings/Detailed settings, see “Scan Settings Overview” on p. 8-19.

E-mail settings

E-mail settings	
Subject :	From ScanFront300
Message :	0 / 1024 characters

Subject

Enter a subject for the e-mail message.

Message

Enter the text of the e-mail message.

Delivery Options

Delivery Options	
Action when the same named file exists :	Display a message ▾
Send the files immediately after scanning :	<input type="radio"/> ON <input checked="" type="radio"/> OFF
Confirm addresses before sending :	<input checked="" type="radio"/> ON <input type="radio"/> OFF
Screen after sending :	Initial Screen ▾

Action when the same named file exists

Select the action to take when a file of the same name exists at the destination.

- **Display a message**
Displays a message confirming that the file will be overwritten.
- **Abort sending**
Cancels sending.
- **Overwrite the file**
Overwrites the identically named file without displaying a confirmation message.

Send the files immediately after scanning

- **ON**
Starts sending when scanning completes.
- **OFF**
Starts sending after you confirm the scanned image when scanning completes.

Confirm addresses before sending

- **ON**
Displays the Address Confirmation screen, and then starts sending after you confirm the address.
- **OFF**
Sends the image without confirming the address.

Screen after sending

Select the screen to display after an image is sent.

- **Initial Screen**
Returns to the startup screen set for [Screen after Login] in the User Settings.
- **Logout**
Logs out after the images are sent.
- **Select screen after sending**
Displays a message dialog for selecting from the above actions after the images are sent.

Index Settings

Specify whether to attach metadata (index files) to scanned images.

Index settings	
Description of setting :	Various information when the scanning is executed at the same time as transmitting the scanned image file can be transmitted as a file of the index of the xrdi or csv form.
Send index file :	<input type="radio"/> ON <input checked="" type="radio"/> OFF
<div style="text-align: right;"> <input type="button" value="OK"/> <input type="button" value="Cancel"/> <input type="button" value="Default"/> </div>	

Scan Settings Overview

The scan settings include basic and detailed settings for scanning parameters and individual settings by file format.

Scan Settings

Scan Settings	
Page Size :	Auto size ▾
Mode :	Black and White ▾
Resolution(dpi) :	150 ▾
Scanning Side :	Simplex ▾
Skip Blank Page Content detection sensitivity	90 (0 - 100) 0 Low 100 High
Prescan :	<input type="radio"/> ON <input checked="" type="radio"/> OFF
File name :	<input type="text"/>
When you select this Job Button :	Skip the file name entry screen ▾
Add Date to File name :	mmddyyyy ▾
File format :	<input checked="" type="radio"/> TIFF <input type="radio"/> JPEG <input type="radio"/> PDF
Multi page settings :	Multi page ▾

Page Size

Select the size of the document to scan from the list.



Hint

- The [Auto size] option automatically detects the size of the scanned document during scanning.
- When scanning a long document, select [Auto size (Long)]



IMPORTANT

A resolution of [300 dpi] or more cannot be set when [Auto size (Long)] is selected.

Mode

Select the scanning mode (Black and White, Error Diffusion, Text enhance, Gray, Color, Auto Color Detection).

When [Auto Color Detection] is selected, the scanner automatically detects whether the document is color or black and white. When this option is selected, you can also configure the following settings.

Mode :	Auto color detection ▾
Auto Color Detection Settings :	
Mode in case of binary :	Black and White ▾
Threshold intensity to judge the document as color :	3 ▾
Aresize to judge the document as color :	2 ▾
Resolution(dpi) :	150 ▾
Scanning Side :	Simplex ▾
Skip Blank Page Contents detection sensitivity :	90 (0 - 100) 0 Low 100 High
Prescan :	<input type="radio"/> ON <input checked="" type="radio"/> OFF

- **Mode in case of binary**
Specify the scanning mode to use when a black and white document is detected.
- **Threshold intensity to judge the document as color**
Adjust the sensitivity to colors in a document.
- **Aresize to judge the document as color**
Specify the ratio of colored regions in a document.

IMPORTANT

- The [Auto Color Detection] function cannot be used simultaneously with the color drop-out or prescan function.
- Depending on the selected mode, the file formats available for saving may be limited. A warning message appears when an unavailable combination is selected.

	TIFF	JPEG	PDF
Black and White	Yes	No	Yes
Error Diffusion	Yes	No	Yes
Text enhance	Yes	No	Yes
Gray	No	Yes	Yes
Color	No	Yes	Yes
Auto Color Detection	No	No	Yes

- When [Text enhance] is selected, [Bleed-through reduction] cannot be selected.

Resolution (dpi)

Select the scanning resolution (100, 150, 200, 300, 400, or 600 dpi).

Scanning Side

Select the method for scanning the document (Simplex, Duplex, Skip blank page, Folio).

Hint

- The Skip Blank Page option scans both sides of a document and skips saving any image it determines to be a blank page.
- You can adjust the sensitivity of the Skip Blank Page option under [Contents detection sensitivity].
- The initial value for the Skip Blank Page option is set to “90.” As you lower the value from the default setting, pages of the document with text become more likely to be skipped as well. As you raise the value from the default setting, pages of the document that are blank become less likely to be skipped.

IMPORTANT

- The scanning speed may be reduced when [Skip Blank Page] is selected.
- A resolution of [400 dpi] or more cannot be set when [Folio] is selected. In addition, [Double feed detection by Ultrasonic] cannot be selected.

Prescan

Enables you to preview an image of the first page of the document before scanning the entire document.

Hint

- Scanning pauses after the first page of the document is scanned, and the image of the first page is displayed.
- Use the displayed image to confirm and adjust the brightness and contrast. Press [Continue] to confirm the adjusted brightness and contrast for the first image and continue scanning.

File name

Specify a name for the image file to be sent.

Add Date to File name

The scanner adds 17 digits that indicate the date and time to the file name of the image to be sent.

Ex.) May 14, 2013, 3:40:30 p.m.

yyyymmdd: File name + 20130514154030123

mmddyyyy: File name + 05142013154030123

ddmmyyyy: File name + 14052013154030123

* The last three digits indicate the number of milliseconds.

You can select [Custom] to configure additional file name settings. The additional settings are identical to those in “Custom File Name Settings” on p. 8-6.

When you select this Job Button

Specify whether the file name entry screen appears when you start scanning using the job button.

File format

Select a file format for the image file, and configure the corresponding settings.

TIFF: Multi page settings

File format :	<input checked="" type="radio"/> TIFF <input type="radio"/> JPEG <input type="radio"/> PDF
Multi page settings :	Multi page

Select [Single page (Front/back separate file)] to save each side of each page as a separate image file, [Single page (Front/back same file)] to save each page as a separate image file, or [Multi page] to save one image file containing multiple pages when scanning multiple pages.

JPEG: Compression

File format :	<input type="radio"/> TIFF <input checked="" type="radio"/> JPEG <input type="radio"/> PDF
Compression :	4(normal)
Detailed settings	<input checked="" type="radio"/> 1(High Compression) <input type="radio"/> 2 <input type="radio"/> 3 <input checked="" type="radio"/> 4(normal) <input type="radio"/> 5 <input type="radio"/> 6 <input type="radio"/> 7(High Quality)
Brightness(Front) :	5
Brightness(Back) :	6
Contrast(Front) :	7(High Quality)

Select a compression ratio for images saved in JPEG format.

PDF:

Configure the settings for compression ratio, multi page, OCR (optical character recognition), and security.

File format :	<input type="radio"/> TIFF <input type="radio"/> JPEG <input checked="" type="radio"/> PDF
Compression Method :	<input checked="" type="radio"/> Standard <input type="radio"/> High Compression
Compression :	4(normal)
Multi page settings :	Multi page
OCR :	<input checked="" type="radio"/> ON <input type="radio"/> OFF
OCR language setting :	English
Encryption :	<input checked="" type="radio"/> ON <input type="radio"/> OFF
Encryption Level :	<input checked="" type="radio"/> Low (40-bit RC4) <input type="radio"/> High(128-bit RC4)
Protect Document :	<input checked="" type="checkbox"/> Required a password to open the document
Document Open Password :	(confirmation)
Protect Permission :	<input checked="" type="checkbox"/> Use permissions password to restrict editing security settings
Permissions Password :	(confirmation)
Printing allowed :	<input type="radio"/> Allowed <input checked="" type="radio"/> Not allowed
Changes allowed :	<input type="radio"/> Allowed <input checked="" type="radio"/> Not allowed
Enable copying of text, images, and accessibility :	<input type="radio"/> ON <input checked="" type="radio"/> OFF

Compression Method

Specify a compression level by selecting [Standard] or [High Compression] as the compression method.

OCR (Optical Character Recognition)

When OCR is set to [ON], the scanner performs character recognition on textual portions of the document, and embeds the detected characters as editable text information in the PDF file.

Hint

When you set OCR to [ON], make sure to select the OCR language that matches the document text.

Encryption

Apply security to the PDF file.

IMPORTANT

Using the High (128-bit RC4) level setting is recommended. The Low (40-bit RC4) level setting provides less security.

Protect Document

The ability to view the document is protected by a password.

IMPORTANT

Take care not to forget the password once it is set. If you forget the password, the document can no longer be opened.

Protect Permission

Permissions for printing and editing the PDF file are protected by a password.

Printing allowed

Enables the PDF file to be printed from a printer.

Changes allowed

Enables editing of the PDF file, such as adding or deleting pages.

Enable copying of text, images, and accessibility

Enables text information embedded by OCR to be copied and the PDF file to be read aloud by text-to-speech software.

! IMPORTANT

- Protecting PDF file permissions is recommended when the permissions have been restricted.
- You can change the permissions and cancel password protection for a password protected PDF file in an application capable of editing PDF files such as Adobe Acrobat.

Detailed settings

Detailed settings	
Brightness(Front) :	5(normal) ▾
Brightness(Back) :	5(normal) ▾ <input checked="" type="checkbox"/> Same as front
Contrast(Front) :	4(normal) ▾
Contrast(Back) :	4(normal) ▾ <input checked="" type="checkbox"/> Same as front
Double feed detection by Ultrasonic :	<input type="radio"/> ON <input checked="" type="radio"/> OFF
Double feed detection by length :	<input type="radio"/> ON <input checked="" type="radio"/> OFF
Document orientation :	<input checked="" type="radio"/> 0 <input type="radio"/> 90 <input type="radio"/> 180 <input type="radio"/> 270 <input type="radio"/> Auto
Deskew :	<input checked="" type="radio"/> Prefer Quality <input type="radio"/> Prefer Speed <input type="radio"/> OFF
Bleed-through reduction :	<input type="radio"/> ON <input checked="" type="radio"/> OFF
Bleed Through Reduction Level :	4(normal) ▾
Color drop-out	
Front side color drop-out :	None ▾
Back side color drop-out :	None ▾

! IMPORTANT

The [Double feed detection by Ultrasonic] setting only appears when using the ScanFront 300P/330.

Brightness (Front)

Adjusts the brightness of the image to be scanned.

Brightness (Back)

Enabled for duplex scanning. Use this option when the front and back sides of a document are shaded differently. To change the brightness settings for the front and back sides, clear the [Same as front] check box.

Contrast (Front)

Adjusts the contrast of the image to be scanned.

Contrast (Back)

Enabled for duplex scanning. Use this option when the front and back sides of a document are shaded differently. To change the contrast settings for the front and back sides, clear the [Same as front] check box.

Double feed detection by Ultrasonic (Only available with the ScanFront 300P/330)

The scanner uses an ultrasonic sensor to detect when two or more documents are fed together, and stops feeding when a double feed is detected.

! IMPORTANT

- This method is effective when documents overlap by 1.97" (50 mm) or more. It does not function if only a slight portion of the document is overlapping.
- When [Scanning Side] is set to [Folio], [Double feed detection by Ultrasonic] cannot be selected.

Double feed detection by length

The scanner detects by document length when two or more documents are fed together, and stops feeding when a double feed is detected.

! IMPORTANT

- Using the length of the first document page as a reference, the scanner detects a double feed when a subsequent page is longer or shorter than the reference page by 1.38" (35 mm) or more.
- Set [Double feed detection by length] to [OFF] when scanning a document that contains pages of different lengths.

Document orientation

Rotates the scanned image to the specified angle.



Hint

When [Auto] is selected, the scanner detects text orientation within the document and rotates the image so that the orientation of the text is correct.



IMPORTANT

The scanning speed may be reduced when [Auto] is selected.

Deskew

Detects when a document has been fed askew from the scanned image, and then straightens the image.

- **Prefer Quality**

Image processing is performed to minimize the loss of quality of an image that has deteriorated as result of deskewing.

- **Prefer Speed**

The image deteriorates slightly as a result of deskewing.



IMPORTANT

If you select [Prefer Quality], the scanning speed is reduced. If you are scanning a large number of pages, select [Prefer Speed] to prevent a decrease in scanning speed.

Bleed-through reduction

Eliminates bleed-through images, in which images on the reverse side of a scanned document appear on the scanned page, such as when scanning thin documents with text or images on both sides.



IMPORTANT

The bleed-through reduction setting is disabled when the scanning mode is set to [Text enhance].



Hint

When using bleed-through reduction, adjust the bleed-through reduction level to match the type of document.

Color drop-out

The color drop-out function has a “drop-out” effect that leaves out a specified color (red, blue, or green) while scanning, and a “color enhancement” effect that emphasizes a specified color.



IMPORTANT

The color drop-out setting is disabled when the scanning mode is set to [Color].



Hint

The OCR recognition rate is sometimes improved by deleting colored ruled lines and other objects with the color drop-out function.

Copying Job Buttons

You can copy the settings of a job button and register it as a new job button.

As an example, this section describes how to copy from the Shared Job Button to the My Job Button.



Hint

Use this function when you want to copy a job button between the Shared Job Button and My Job Button or register it as a different job button after changing some of the settings.

1. Select Shared Job Button for the [Job Button Type].
2. Select the job button you want to copy, and click [Copy].

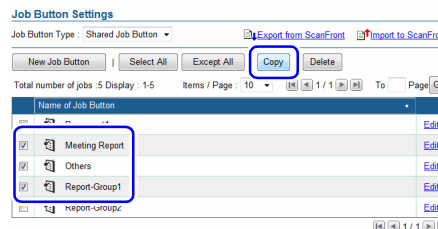

3. Select My Job Button for the copy destination, and click [OK].

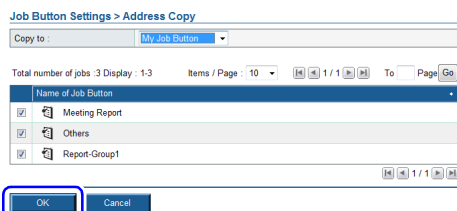

4. Confirm the copied job button.

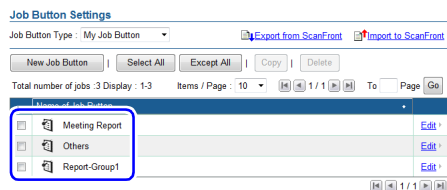

□ Editing Jobs

You can edit the settings of a registered job by clicking [Edit] in the job button list. The settings that can be edited are identical to those in “[Registering New Job Buttons](#)” on p. 8-18.

□ Exporting and Importing Job Buttons

You can back up your job button data as a settings file in DAT format, and import the backed up job button settings file to another ScanFront unit.



Hint

If you have multiple ScanFront units, you can use the same job buttons on all of them by importing the job button settings file registered on one ScanFront unit to the other units.

Exporting from the Scanner

You can save the job button settings file to a specified folder.

1. Click [Export from ScanFront].

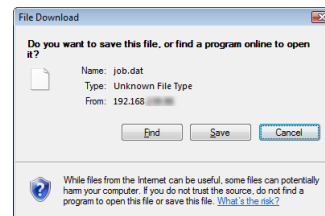

2. Click [Save], specify a save location, and save the job button settings file.

Importing to the Scanner

You can import a previously exported job button settings file to the scanner.

1. Click [Import to ScanFront].

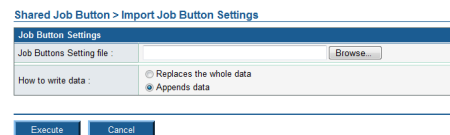

2. Specify a previously exported job button settings file.
3. Select a processing method for importing the job button settings file.
 - Replaces the whole data: Deletes all currently registered job buttons and overwrites them with the imported job buttons.
 - Appends data: Adds the imported job buttons to the currently registered job buttons.

4. Click [Execute].

Confirm the message that appears, and click [OK] to import the data.

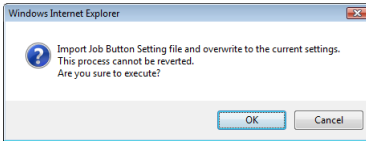
 **Hint**

When importing is completed, the following message appears. Click [OK] to return to Job Button Settings and confirm the imported job button.

Information

Importing of the "D:\work\job.dat" file is complete.

OK

Chapter 9 Maintenance

1. Routine Cleaning	9-2
Cleaning the Scanner Unit	9-2
Cleaning the Touch Panel	9-2
Cleaning the Fingerprint Sensor (ScanFront 300P)	9-2
Cleaning the Scanning Glass and Rollers	9-3
Cleaning the Retard Roller	9-5
Cleaning the Feed Roller	9-6
2. Replacing the Rollers and Document Holding Guide	9-8
Exchange Roller Kit	9-8
Replacement Method	9-8
Checking the Page Count and Resetting the Counter	9-9

1. Routine Cleaning

Clean the scanner on a regular basis, as described below, to maintain scanning performance.

⚠ CAUTION

- When cleaning the scanner, do not spray water or detergent directly on the scanner. Doing so may damage precision mechanisms, such as the light source.
- To clean the fingerprint sensor, use a dry commercially available cotton swab or a dry cloth to wipe off any dirt. If a cloth containing water or another liquid is used, the scanner may malfunction as a result of liquid getting inside the scanner.
- Never use thinner, alcohol, or other organic solvents to clean the touch panel. Such solvents may deform, discolor, or melt the touch panel, thus causing a malfunction.

□ Cleaning the Scanner Unit

To clean the surface of the scanner unit, use a cloth slightly dampened with water and well wrung out, to remove any dirt, and then use a clean, dry cloth to wipe the scanner.

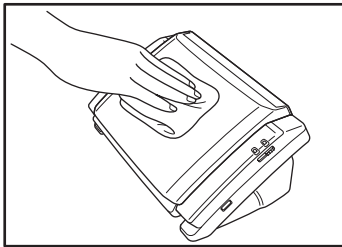

□ Cleaning the Touch Panel

When cleaning the touch panel, use a soft, dry cloth to gently wipe the surface of the panel without applying pressure.

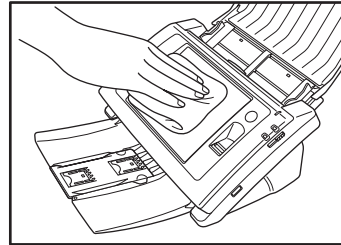

□ Cleaning the Fingerprint Sensor (ScanFront 300P)

To clean the fingerprint sensor, use a soft, dry cloth to wipe off any dirt.

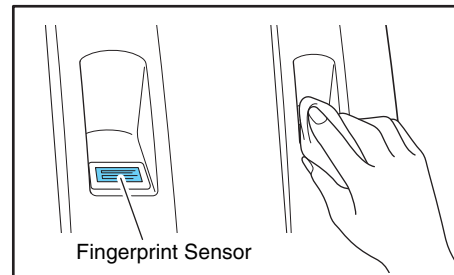

ⓘ IMPORTANT

The portion of the sensor where the fingers touch during fingerprint authentication can get particularly dirty. A dirty sensor may cause fingerprint authentication errors. Clean the sensor and its surrounding area regularly, regardless of how dirty they are.

❑ Cleaning the Scanning Glass and Rollers

If scanned images contain streaks or scanned documents become dirty, the scanning glass and rollers inside the scanner may be dirty. Use the procedure below to clean them on a regular basis.

1. Pull the lock lever toward you and then fully open the panel unit.

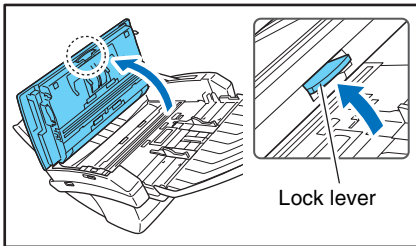

⚠ CAUTION

The open/close movement of the panel unit is linked to the up/down movement of the document eject tray. Do not press on the document eject tray when you open the panel unit.

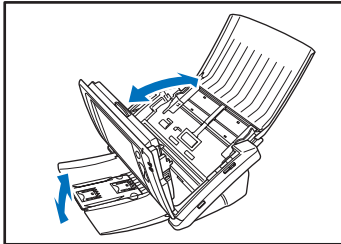

2. Use a commercially available air blower to remove any dust and paper particles that have accumulated inside the scanner.
3. Use a clean, dry cloth to wipe any dirt off the scanning glass.

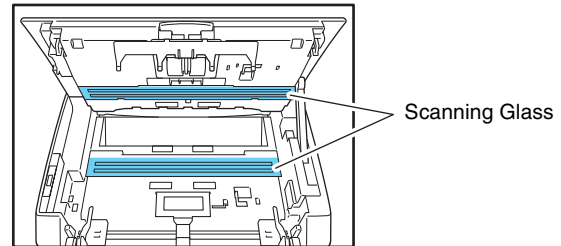

💡 Hint

There is one scanning glass for the front side of documents, and another for the back side. Wipe both of them clean.

⚠ CAUTION

Do not spray water or detergent directly on the scanner. Doing so may damage precision mechanisms, such as the light source.

❗ IMPORTANT

Scratches on the scanning glass may cause streaks on scanned images, as well as feeding errors. If there are scratches on a scanning glass, contact your local authorized Canon dealer.

4. Remove any dirt from the rollers using a cloth that has been soaked in water and thoroughly wrung out.

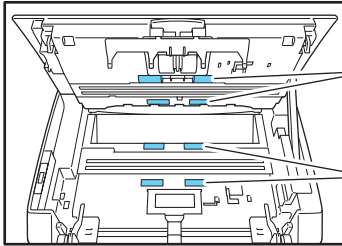

Clean the rollers while rotating them

Clean the visible portions

! IMPORTANT

Rotate the rollers on the panel unit side while cleaning them. Do not rotate the rollers on the opposite side, and remove dirt on the visible portions only. Forcefully rotating the rollers on this side may cause feed errors.

5. Remove any dirt from the document holding guide using a cloth that has been soaked in water and thoroughly wrung out.

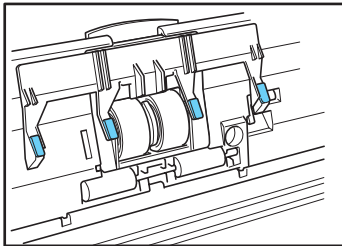

6. Remove the retard roller and feed roller, and remove any dirt from them.

See "Cleaning the Retard Roller" on p. 9-5.

See "Cleaning the Feed Roller" on p. 9-6.

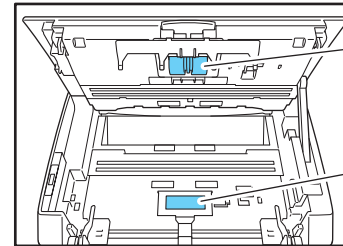

Retard Roller



Feed Roller



! IMPORTANT

After you remove the retard roller and feed roller and finish cleaning them, make sure to reattach them to the scanner.

7. Gently close the panel unit. Press on both sides of the unit until you hear a click, which indicates the unit is locked.

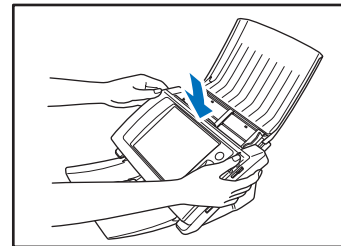

8. Gently close the document eject tray.

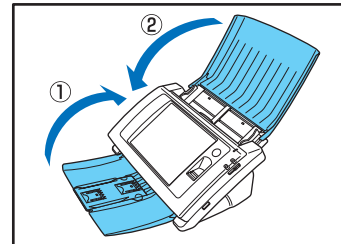

□ Cleaning the Retard Roller

Use the procedure below to remove and attach the retard roller during cleaning or replacement.

⚠ CAUTION

Do not use excessive force when removing or attaching the retard roller. Doing so may cause the roller to become deformed, resulting in feed errors.

1. Open the roller cover.

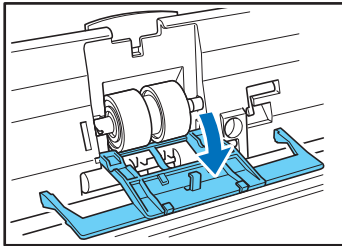

2. Lift up the roller lock lever ①, and slide it in the direction of the arrow ②.

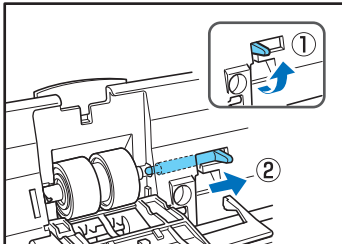

3. Move the retard roller in the direction of the arrow ①, and then remove it from the shaft ②.

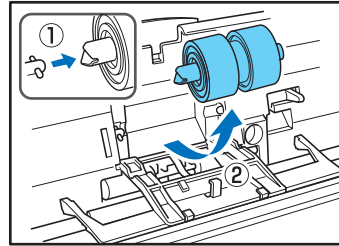

4. Remove any dirt from the roller using a cloth that has been soaked in water and thoroughly wrung out.

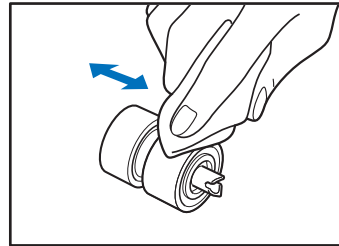

5. Place the roller in the roller compartment inside the roller cover, and then align the notch in the roller with the shaft of the scanner.

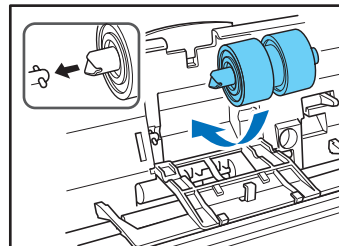

6. Slide the roller lock lever in the direction of the arrow, and then insert it into the hole of the retard roller.

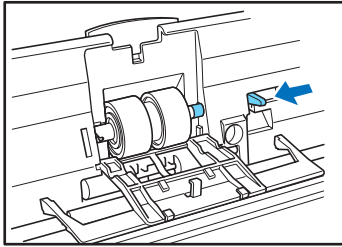

7. Lower the lever to lock the shaft of the retard roller into position.

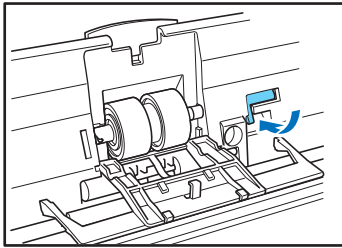

8. Close the roller cover. Make sure that you hear a click, which indicates the cover has returned to its original position.

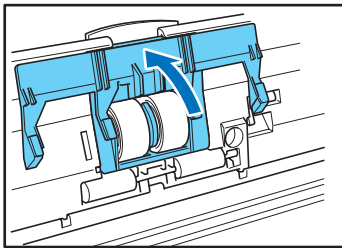

□ Cleaning the Feed Roller

Use the procedure below to remove and attach the feed roller during cleaning or replacement.

⚠ CAUTION

Do not use excessive force when removing or attaching the feed roller. Doing so may cause the roller to become deformed, resulting in feed errors.

1. Open the roller cover.

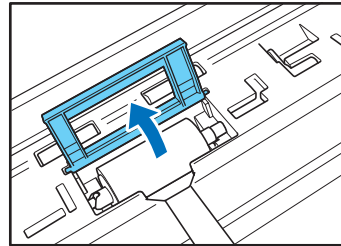

2. Lift up the roller lock lever ①, and slide it in the direction of the arrow ②.

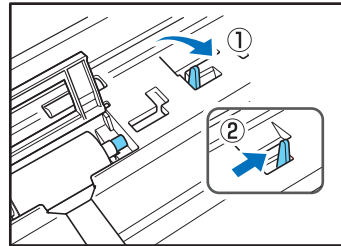

3. Move the feed roller in the direction of the arrow ①, and then remove it from the shaft ②.

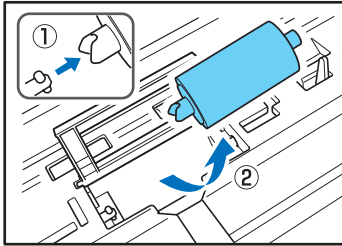

4. Remove any dirt from the roller using a cloth that has been soaked in water and thoroughly wrung out.

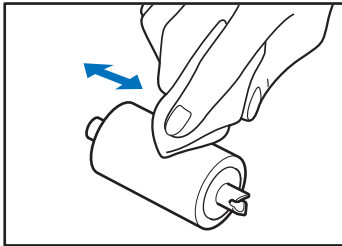

5. Align the notch in the shaft of the roller with the shaft of the scanner, and place the feed roller into position.

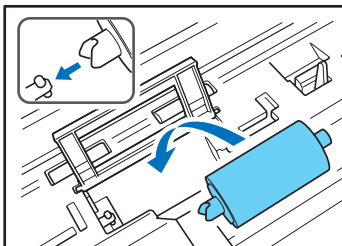

6. Move the roller lock lever in the direction of the arrow, and then insert it into the hole in the feed roller.

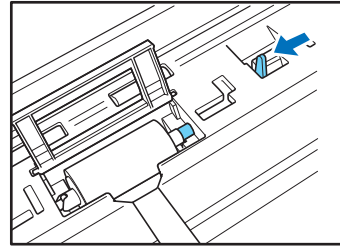

7. Lower the roller lock lever to lock the feed roller into position.

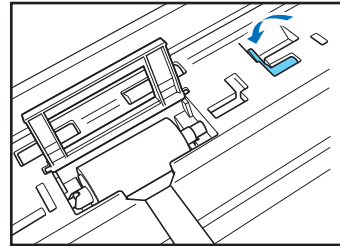

8. Close the roller cover. Make sure that you hear a click, which indicates the cover has returned to its original position.

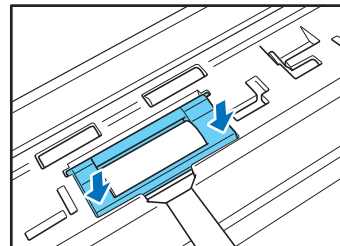

2. Replacing the Rollers and Document Holding Guide

When the rollers start to wear out, document feed errors such as paper jams are more likely to occur.

If document feed errors continue to occur even after cleaning the rollers, purchase an Exchange Roller Kit, and replace the rollers (feed roller and retard roller) and the document holding guide.

Exchange Roller Kit

The Exchange Roller Kit is a kit consisting of replacements for the feed roller, retard roller, and document holding guide. For details, contact your local authorized Canon dealer or service representative.

Product name: Exchange Roller Kit

Product code: 4593B005

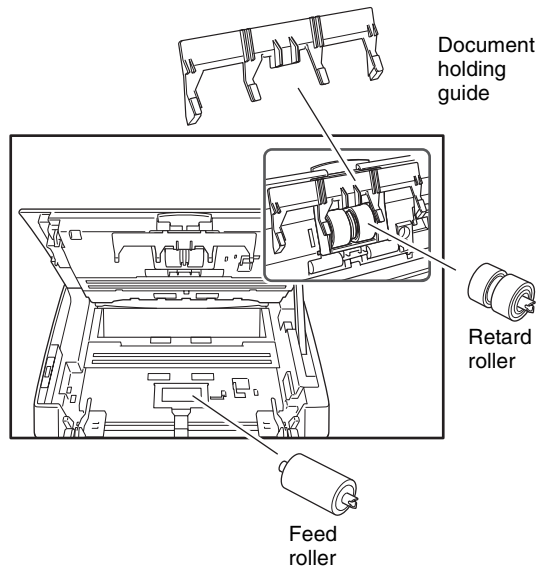

! IMPORTANT

- The rollers and the document holding guide are consumable parts. When the total number of pages scanned with the rollers reaches 100,000 pages, purchase an Exchange Roller Kit and replace the parts. (See “Checking the Page Count and Resetting the Counter” on p. 9-9.)
- When the rollers start to wear out, problems such as paper jams and improper document feeding become more likely to occur. If this happens, replace the rollers regardless of the page count.
- Make sure to reset the roller counter after replacing the rollers.

Replacement Method

For details on how to replace the feed roller and retard roller, see p. 9-5 and p. 9-6.

Replacing the Document Holding Guide

1. Open the retard roller cover, and pull it out straight.

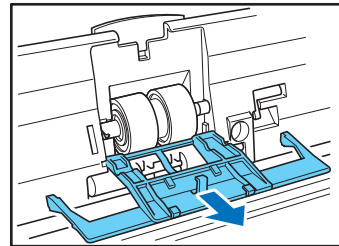

- Remove the document holding guide from the roller cover by sliding it up.

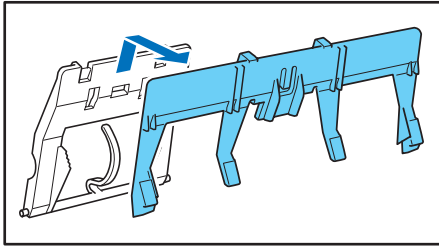

- Hook the new document holding guide (four hooks) onto the roller cover, and slide it down to set it in place.

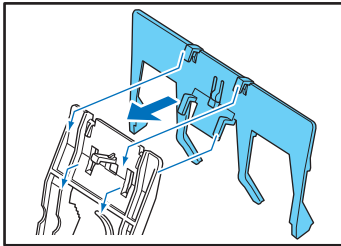

- Insert the retard roller cover straight with the document holding guide attached.

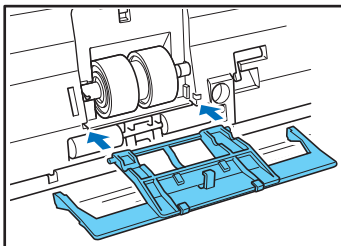

❑ Checking the Page Count and Resetting the Counter

Check the page count on the Roller Counter Reset screen of the Administrator Setting screen.

! IMPORTANT

The roller counter counts the number of pages fed by replaced rollers. Make sure to reset the counter when you replace the rollers since this enables a warning telling you when the page number limit has nearly been reached and the roller needs to be replaced.

- Log in to the Administrator setting screen.

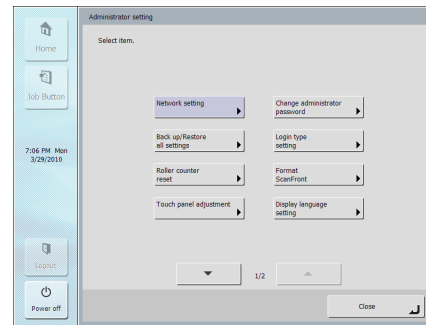

- Press the [Roller counter reset] button to display the [Roller counter reset] screen.

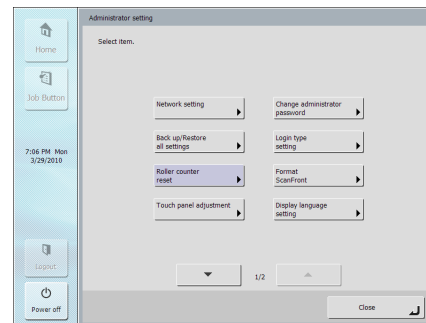

[Roller counter reset] screen

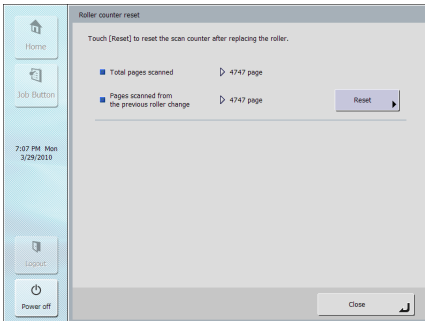

Total pages scanned

This counter is for the total number of document pages fed by the scanner.

Pages scanned from the previous roller change

This counter is for the number of document pages fed by the scanner since the roller was replaced and the counter was reset.

3. Press the [Reset] button to reset the counter.

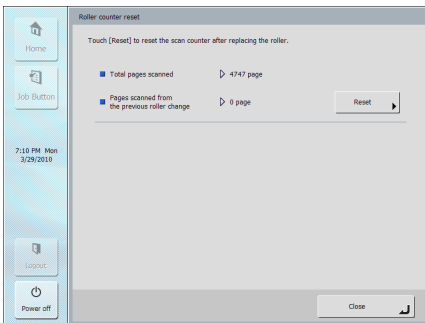

4. Press [Close] to log out of the Administrator setting screen.

Chapter 10 Troubleshooting

1. Troubleshooting	10-2
2. Error Messages (ScanFront)	10-6
3. Error Messages (Web Menu).....	10-9
4. Adjusting the Touch Panel.....	10-11
5. Initializing ScanFront	10-13

1. Troubleshooting

If any of the following problems occurs, solve the problem as described in the corresponding solution.

Network, Web Menu		
Cannot log in to the Web menu	Cause	JavaScript is disabled in the Web browser.
	Solution	Enable JavaScript.
Cannot use an LDAP address book (certain users only)	Cause	The administrator has set user function restrictions. See “Restricting User Functions” on p. 6-10.
	Solution	Contact the administrator of the ScanFront.
Cannot update the settings in the Web menu	Cause	The ScanFront is being used or a user has not logged out.
	Solution	Check the ScanFront status and then try again.
	Cause	The Web browser has become unstable.
	Solution	Delete the cache and cookies and reset the settings of the Web browser.
Cannot access the Web menu	Cause	The IP address assigned from the DHCP server has changed.
	Solution	Contact the administrator of the ScanFront, and check the IP address assigned to the ScanFront.
Cannot create a new folder (shared folder/FTP server)	Cause	Permission to write to the shared folder has not been granted for the user name and password that were entered.
	Solution	Contact the administrator of the shared folder.
Specifying a mail address as the address and then starting scanning results in an error	Cause	The mail server settings have not been registered, or have been deleted.
	Solution	Contact the administrator of the ScanFront.
Cannot edit the address book/job buttons (certain users only)	Cause	The administrator has set user function restrictions. See “Restriction to Edit” on p. 6-11.
	Solution	Contact the administrator of the ScanFront.
Can only select certain destinations. For example, can only select shared folders (certain users only)	Cause	The administrator has set user function restrictions.
	Solution	Contact the administrator of the ScanFront.
Cannot connect to an FTP server that can be accessed from outside the company	Cause	The scanner cannot connect to an FTP server that requires firewall settings to be configured.
	Solution	Use an FTP server that does not require firewall settings to be configured.

The wrong send time is displayed for an e-mail message received at the destination	Cause	(1) The date and time settings are incorrect. (2) The time zone is set to a different country.
	Solution	Contact the administrator, and check the “Language/Timezone” setting. (See p. 6-30.)
The sender’s address is not displayed at the destination of an e-mail message	Cause	The e-mail addresses of the user and administrator have not been registered. (See p. 6-7 and p. 6-32.)
	Solution	Contact the administrator, and register the e-mail addresses.
Cannot connect to the network (IP address conflict problem)	Cause	The IP address that was set is already being used by another device.
	Solution	Contact the system administrator of the network, and change the IP address setting.
Cannot connect to the network (LAN cable connection problem)	Cause	The LAN cable is not connected properly.
	Solution	Check the connections of the LAN cable.
Cannot connect to the network (device name conflict problem)	Cause	The device name that was set is already being used by another device.
	Solution	Contact the system administrator of the network, and change the device name setting. When you install two or more ScanFront scanners, take care to ensure duplicate device names are not set.
Cannot delete a folder	Cause	Data has been saved to the folder.
	Solution	Contact the administrator of the shared folder.
	Cause	Permission to change the shared folder has not been granted for the user name and password that were entered.
	Solution	Contact the administrator of the shared folder.
Cannot scan from the Home screen (certain users only)	Cause	The administrator has set user function restrictions. See “Use only Job Buttons” on p. 6-10.
	Solution	Contact the administrator of the ScanFront.
Cannot log in	Cause	Uppercase and lowercase letters were not entered correctly. (See p. 8-3 and p. 5-5.)
	Solution	Enter the uppercase and lowercase letters for the user name and password correctly.
Cannot browse shared folders during address registration.	Cause	You are attempting to browse folders on a computer running Windows 7 or Windows Server 2008 R2.
	Solution	Enter the full path of the shared folder manually.

Cannot send image files to devices and folders on different segments of the network.	Cause	A ScanFront Service Server does not exist on the network. (A ScanFront Service Server has not been configured or is not running.)
	Solution	Install ScanFront Service on a computer on the same network as the scanner. (See p. 4-3.) If a ScanFront Service Server has been implemented, check the necessary settings. In addition, you must start the ScanFront Service Server before turning ON the ScanFront. (See p. 4-6.)
Scan		
Streaks appear in images	Cause	The scanning glass is dirty.
	Solution	Clean the scanning glass. (See p. 9-3.) If there are scratches on a scanning glass, contact your local authorized Canon dealer.
Paper becomes jammed	Cause	The rollers are dirty.
	Solution	Clean the rollers. (See p. 9-3.)
Paper jams occur frequently	Cause	The rollers (consumable parts) have worn out.
	Solution	Purchase an Exchange Roller Kit and then replace the rollers. (See p. 9-8.)
Documents are double fed	Cause	Static electricity is causing the pages of the document to stick to each other.
	Solution	Before you load a stack of documents, fan the documents.
	Cause	The type of paper of the documents is causing a paper feed error.
	Solution	Load no more than ten pages of documents. (See p. 2-10.) Use bypass feeding to scan the pages one by one.
A stack of documents are fed together	Cause	The feed selection lever is set to Page Separation OFF. (See p. 2-5.)
	Solution	Set the feed selection lever to page separation feeding.
Scanning starts immediately after I press a job button (certain users only)	Cause	The job buttons are designed to work that way. See “Skip Scan Setting Screen” on p. 6-21 and p. 8-18.
	Solution	Place the document and then press a job button.

Hardware		
Cannot turn on the power	Cause	The AC adapter is not connected properly or the power plug is not inserted.
	Solution	Check the connections of the AC adapter and power plug. If the problem is not resolved after checking the connections, contact your local authorized Canon dealer.
The scanner does not turn ON when the power switch is pressed.	Cause	A USB memory device is inserted in the scanner.
	Solution	Remove the USB memory device, and restart the scanner.

2. Error Messages (ScanFront)

If any of the following error messages appears, solve the problem as described in the corresponding solution.

If you are unsure about any other message that appears, contact the support services.

Failed to connect FTP server.	Cause	The settings of the registered FTP server are incorrect.
	Solution	Check the settings of the FTP server. (See p. 6-15, p. 8-11 and p. 5-24.)
	Cause	The computer that is being used as the FTP server is not running.
	Solution	Check the computer that is being used as the FTP server.
Please set SMTP server address.	Cause	The mail server settings have not been registered, or have been deleted.
	Solution	Contact the administrator of the ScanFront, and check the settings of "Mail Server" in the Web menu. (See p. 6-34.)
This is restricted item.	Cause	The administrator has set send restrictions for the selected e-mail address. (See p. 6-11.)
	Solution	Contact the administrator of the ScanFront.
Paper JAM occurred. Remove the paper.	Cause	The rollers are dirty or worn out.
	Solution	Clean the rollers. If the problem is not resolved by cleaning the rollers, replace the rollers. (See p. 9-8.)
A double paper-feed has occurred.	Cause	The pages of the document are sticking together because of, for example, static electricity, too many documents were loaded, the rollers are dirty, etc.
	Solution	Fan the documents before you load them, and reduce the number of pages that you load at times when double feeding occurs repeatedly. (See p. 2-9.)
You cannot paste the copied address to the different address type.	Cause	The copy source and the paste address are of a different type.
	Solution	Make sure the copied address and paste address are of the same type.
Restricted address is included.	Cause	The job button settings include an address that has been restricted by the administrator. (See p. 6-11.)
	Solution	Contact the administrator of the ScanFront.
Confirm Password doesn't match. (New password and confirmation password do not match.)	Cause	The new password and confirmation password do not match.
	Solution	Enter the same password for the new password and the confirmation password.

Password is incorrect.	Cause	The password that was entered is incorrect.
	Solution	Enter the uppercase and lowercase letters for the password correctly.
There is no file name specified. Enter a file name or enable the 'Auto file name' setting.	Cause	A file name was not entered and "Auto file name" is set to [None].
	Solution	Enter a file name or set "Auto file name" to other than [None]. (See p. 5-34.)
Log in failed. Settings may currently be in the process of being edited via the Web.	Cause	User settings are being edited via the Web menu.
	Solution	Contact the administrator of the ScanFront.
Log in failed. A version upgrade may currently be in the process of being executed.	Cause	The version of the ScanFront is being updated via the Web menu.
	Solution	Contact the administrator of the ScanFront.
Cannot write logfile. Sending files will be aborted.	Cause	Write permission has not been granted for the shared folder specified as the save destination of the log file.
	Solution	Check the settings and access permissions of the shared folder.
You can't use following character for File name.	Cause	Invalid characters have been used to set the customer file name.
	Solution	Make sure the custom file name does not contain any of the following characters: / : ? * " < >
The character string includes invalid character.	Cause	Invalid characters have been used to set the index file.
	Solution	Make sure none of the following characters are used in strings contained in the index file: & " ' < >
Not enough memory to execute current scanner settings. Please see "Troubleshooting" section at "INSTRUCTIONS" or "Operation Guide".	Cause	There was not enough memory available for the set scanning conditions.
	Solution	Reset the scanning conditions. Refer to "Not enough memory to execute scanner settings" below.
Log in failed. A version Password may be changed.	Cause	User password was changed on the authentication server while server authentication and fingerprint authentication are both used to log in.
	Solution	Without using fingerprint authentication, enter your user name and changed password to log in, and then re-register your fingerprints.
Log in failed. Authentication server is not found.	Cause	The user specified when logging in does not exist in the authentication server.
	Solution	Make sure you correctly enter your user name and password. Contact the administrator of the ScanFront if this problem persists.

Installation of the certificate file failed.	Cause	The file format of the certificate file is invalid.
	Solution	Use a file in CER format.
Maximum certificates exceeded. You can't register any more.	Cause	The number of registered certificates has reached the limit of 50.
	Solution	Delete at least one registered certificate.

Not enough memory to execute scanner settings

ScanFront uses internal memory to scan documents. This memory usage increases when you use high-resolution or large page size settings, for example. If the internal memory capacity exceeded, an error message saying “Not enough memory to execute current scanner settings” may appear and you may not be able to scan the document.

The following table details scanning conditions that may cause ScanFront to run out of memory. If scanning cannot be executed due to insufficient memory, refer to this table to reset scanning conditions.

Mode	Resolution	Scanning Side	Prescan	Bleed-through reduction	Page Size
Auto color detection	600dpi	Duplex	(Cannot be set)	—	All page sizes
		Simplex			
	400dpi	Duplex			A4, legal
Color	600dpi	Duplex	OFF	—	Legal
		Simplex	ON		All page sizes
	400dpi	Duplex	ON		B5, A4, legal
		Duplex			A4, legal
Gray	600dpi	Duplex	OFF	ON	Legal
		Simplex	ON		All page sizes
	400dpi	Duplex	ON		B5, A4, legal
		Duplex			A4, legal
Black and White Error Diffusion Text enhance	600dpi	Duplex	OFF	ON	Legal
		Simplex	ON		All page sizes
	400dpi	Duplex	ON		B5, A4, legal
		Duplex			A4, legal

3. Error Messages (Web Menu)

If any of the following error messages appears, solve the problem as described in the corresponding solution.

If you are unsure about any other message that appears, contact the support services.

Same Username exists. Please change Username, and try again.	Cause	A user that has the same name as the user name to be registered is already registered.
	Solution	Check the user name prior to registration.
Blank field exists.	Cause	An operation such as address book/job button importing, restoring, or version updating was executed without specifying the setting file to be loaded on the ScanFront.
	Solution	Specify the setting file and then execute the operation.
The scanner is busy. Please try again.	Cause	The ScanFront is being used.
	Solution	End use of the ScanFront and then try again.
Settings cannot be changed or stored. A user may be logged in to the device. Check the status of the device.	Cause	Modifying settings and registration are not possible because a user is logged in.
	Solution	Try again after the user logs off.
Settings cannot be changed. The device may currently be displaying an administrator settings page. Check the status of the device.	Cause	The ScanFront is being used.
	Solution	End use of the ScanFront and then try again.
Maximum address has been registered. You can't register any more.	Cause	The limit for the number of addresses has been exceeded.
	Solution	Delete addresses that are no longer used and then try again.
Maximum Job Buttons has been registered. You can't register any more.	Cause	The limit for the number of job button registrations has been exceeded.
	Solution	Delete job button registrations that are no longer used and then try again.
Maximum users has been registered. You can't register any more.	Cause	The limit for the number of user registrations has been exceeded.
	Solution	Delete user registrations that are no longer used and then try again.
Password is not registered. OK to proceed?	Cause	A password has not been set for the user to be registered.
	Solution	Check the password prior to registration.

You can't choose TIFF when Gray or Color or Auto color detection is selected.	Cause	The scanner cannot be used with the selected mode and file format combination.
	Solution	Check which mode and file format combinations can be used. (See p. 6-21 and p. 8-20.)
You can't choose JPEG when Binary Mode is selected.	Cause	The scanner cannot be used with the selected mode and file format combination.
	Solution	Check which mode and file format combinations can be used. (See p. 6-21 and p. 8-20.)
You can't choose Text enhance when Bleed-through reduction is selected.	Cause	The scanner cannot be used with the selected mode and setting combination.
	Solution	Check which mode and setting combinations can be used. (See p. 6-21 and p. 8-20.)
ScanFront Service is not running.	Cause	A ScanFront Service Server does not exist on the network. (A ScanFront Service Server has not been configured or is not running.)
	Solution	Check the ScanFront Service Server settings. In addition, you must start the ScanFront Service Server before turning ON the ScanFront. (See p. 4-6.) Configure the ScanFront Service Server settings again in the Web Menu after checking that the ScanFront Service Server is turned ON to renewable use of the service.
User is now operating the device. Please try again after the user completes operations.	Cause	The ScanFront is being used.
	Solution	Try again after the ScanFront has finished being used.
An user has logged in. Operation is invalid.	Cause	Modifying settings is not possible because a user is logged in.
	Solution	Make the user log off and then try again.
Please select user.	Cause	User data is trying to be exported from the scanner without a user being selected at the user settings screen.
	Solution	Select a user name to export.
The character string includes invalid character.	Cause	Invalid characters have been used to set the custom file name or index file.
	Solution	Make sure none of the following characters are used: Custom file name: / : ? * " < > Index file strings: & ' ' < >

4. Adjusting the Touch Panel

If there is no response when you press a button on the touch panel but there is a response when you press somewhere other than a button, the panel needs to be adjusted. Use the procedure below to adjust the touch panel.

! IMPORTANT

- A commercially available touch-panel pen (or the equivalent) is required to adjust the touch panel. Provide a touch-panel pen before attempting to adjust the touch panel.
- Adjustment of the touch panel involves one cycle of tapping five places, but adjustment may sometimes not end after one cycle if any of the tapped places was not a target.
- To cancel touch panel adjustment, connect a USB keyboard and press the [Esc] key.

1. Log in to the Administrator setting screen.

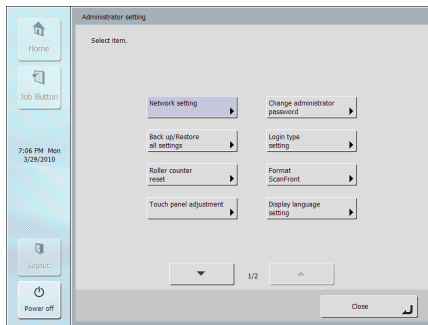

2. Press the [Touch panel adjustment] button to display the adjustment screen of the touch panel.

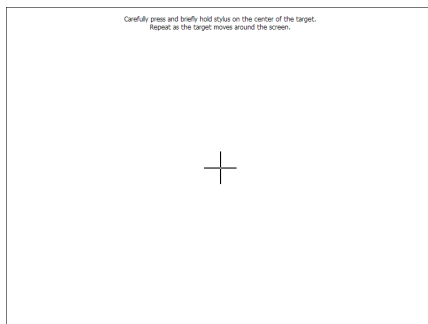

3. Press the center of the displayed targets (+) with the touch-panel pen in the order of ① to ⑤.

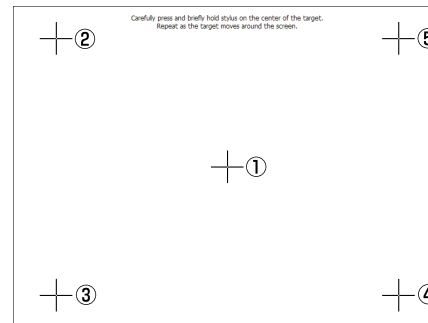

4. After you finish adjustment, tap the panel to end touch panel adjustment.

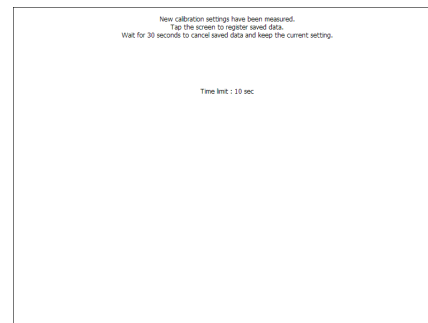

! **IMPORTANT**

If you do not tap the panel within a period of 30 seconds after adjustment of the touch panel ends, the adjustment values will not take effect and the touch panel will return to the state prior to adjustment.

5. Initializing ScanFront

Initialize the ScanFront to protect user information when you submit the ScanFront for repairs or when you want to delete the user information because, for example, you are changing the operating location. This initializes all the information registered to the ScanFront, including user information, address books, and job buttons.

! IMPORTANT

- Initializing the ScanFront deletes all registered information. Always back up the data prior to initialization.
- It takes about 5 minutes for initialization to complete. Do not turn OFF the scanner before initialization is complete. (The Home screen appears when initialization is complete.)
- For ScanFront 330, initializing only deletes the data of Standard Mode. The data of Web Application Mode is not deleted.

1. Log in to the Administrator setting screen.

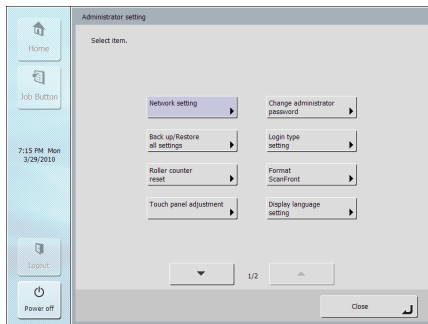

2. Press the [Format ScanFront] button.

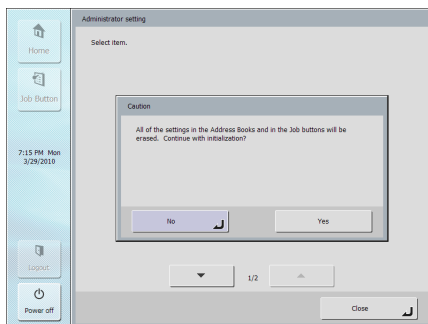

3. Confirm the message, and then press [Yes].

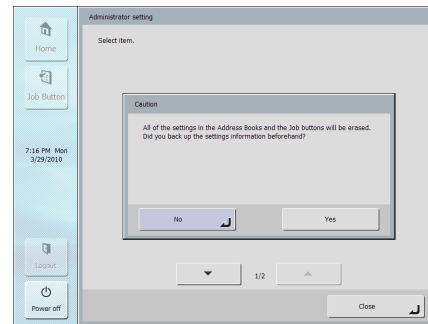

4. Confirm the message, and then press [Yes].

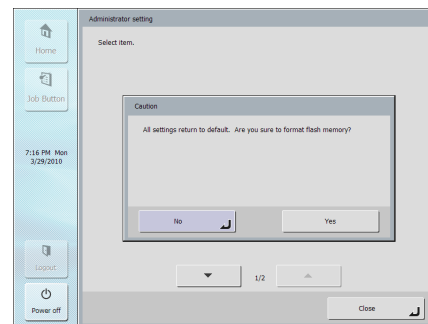

- 5.** Confirm the message and press [Yes] to perform initialization, and the scanner will turn OFF.
- 6.** Turn the scanner ON, and set up the scanner again.

Chapter 11 Appendices

1. Specifications.....	11-2
Unit Specifications.....	11-2
Network Specifications.....	11-3
Transfer Destinations	11-3
AC Adapter (100 to 240 V type)	11-3
Consumable Parts.....	11-4
External Dimensions	11-5
2. Index.....	11-6

1. Specifications

□ Unit Specifications

Type

Pass-through desktop scanner with network compatibility

Operation Panel

8.4" TFT-LCD touch panel
SVGA (800 × 600 dot) display

Scanning Document Specifications

Width: 2" to 8 1/2" (50.8 mm to 216 mm)
Length: 2 1/8" to 14" (53.9 mm to 355.6 mm)
(up to 39.3" (1,000 mm) in Long Document mode)
Thickness:
(Feeding with Page Separation ON)
14 to 57 lb bond (52 g/m² to 209 g/m²)
(Feeding with Page Separation OFF)
11 to 57 lb bond (40 g/m² to 209 g/m²)

Scanning Card Specifications

Size: 2.12" × 3.37" (53.9 × 85.5 mm)
Card Thickness: Not more than 0.0299" (0.76 mm)

Document Feeding Method

Automatic (feeding with Page Separation ON)
Manual (feeding with Page Separation OFF)

Loadable Sheets

Legal/A4 Size or Smaller:
50 high-quality sheets, or stacks no thicker than 5 mm
(including curls)
Sizes Larger than Legal/A4:
30 high-quality sheets, or stacks no thicker than 3 mm
(including curls)

Scanning Sensor

Contact image sensor

Light Source

LED

Scanning Side

Simplex/Duplex

Scanning Modes

Black and White, Error Diffusion, Text Enhance,
Gray, Color, and Auto Color Detection

Scanning Resolution (Primary Scan Lines × Secondary Scan Lines)

100 × 100 dpi / 150 × 150 dpi / 200 × 200 dpi
300 × 300 dpi / 400 × 400 dpi / 600 × 600 dpi

Scanning Speed (For A4 size page) (ScanFront 300P and Standard Mode of ScanFront 330)

ScanFont 300

Black and White

Simplex	200 × 200 dpi	30 pages/min.
	300 × 300 dpi	30 pages/min.
Duplex	200 × 200 dpi	60 images/min.
	300 × 300 dpi	50 images/min.

Gray

Simplex	200 × 200 dpi	30 pages/min.
	300 × 300 dpi	30 pages/min.
Duplex	200 × 200 dpi	56 images/min.
	300 × 300 dpi	38 images/min.

Color

Simplex	150 × 150 dpi	25 pages/min.
	200 × 200 dpi	25 pages/min.
Duplex	150 × 150 dpi	43 images/min.
	200 × 200 dpi	25 images/min.

ScanFont 300P/330

Black and White

Simplex	200 × 200 dpi	30 pages/min.
	300 × 300 dpi	30 pages/min.
Duplex	200 × 200 dpi	60 images/min.
	300 × 300 dpi	60 images/min.

Gray

Simplex	200 × 200 dpi	30 pages/min.
	300 × 300 dpi	30 pages/min.
Duplex	200 × 200 dpi	60 images/min.
	300 × 300 dpi	54 images/min.

Color		
Simplex	150 × 150 dpi	25 pages/min.
	200 × 200 dpi	25 pages/min.
Duplex	150 × 150 dpi	50 images/min.
	200 × 200 dpi	40 images/min.

Network Connector

RJ-45 (10Base-T/100Base-TX)

Interface

Hi-Speed USB 2.0 ports (4)

Other

Double Feed Detection, Deskew, Folio, Long Document scanning, Skip Blank Page, Document orientation, Bleed-through reduction, Color drop-out/enhancement, Fingerprint authentication (only available with the ScanFront 300P)

External Dimensions

12.2" × 8.46" × 6.34" (W × D × H)

310 × 215 × 161 mm (W × D × H)

Maximum External Dimensions (with Document Feed Tray and Eject Tray Open)

12.2" × 22.48" × 11.73" (W × D × H)

310 × 571 × 298 mm (W × D × H)

Weight (excluding AC adapter)

Approximately 7.9 lb (3.6 kg)

Power Supply

DC24V 1.2A

Power Consumption

Scanning: 30W

Display Off mode: 7.0W

Low Power mode: 1.0W

Power Turned Off: less than 0.5W

Noise

Not more than 68 dB

Operating Environment

Temperature: 10 °C to 32.5 °C (50 °F to 90.5 °F)

Humidity: 20%-80%RH

Network Specifications**Network**

Microsoft Windows Network

Protocol

TCP/IP

IP Address

Obtained automatically (DHCP supported) or fixed address

Other

Active Directory (NTLM authentication) and OpenLDAP (simple authentication) supported

Transfer Destinations**E-mail**

Fax (via Internet fax service)

FTP Server

Shared Folder

USB Memory

Printer

AC Adapter (100 to 240 V type)**Model Number**

MG1-4558

Input

AC100 to 240V, 50/60 Hz, 1.1 to 0.58 A

Output

DC24V 2.0A

Weight

Approximately 0.31kg (0.69 lb) (excluding power cord)

Specifications are subject to change without notice.

❑ Consumable Parts

Exchange Roller Kit (product code: 4593B005)

Replacement kit for the rollers (feed roller and retard roller) and the document holding guide. (See “Replacing the Rollers and Document Holding Guide” on p. 9-8.)

! IMPORTANT

- Rollers are consumable parts. When the rollers start to wear out, problems such as paper jams and improper document feeding become more likely to occur. If this happens, replace the rollers regardless of the page count.
- For information about the Exchange Roller Kit, contact your local authorized Canon dealer or service representative.

External Dimensions

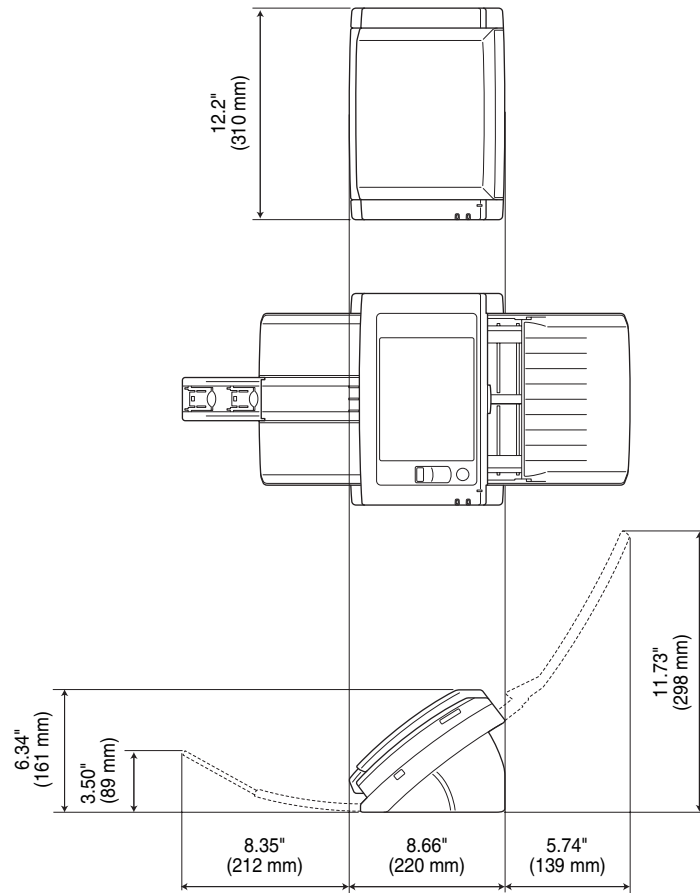

2. Index

A

AC Adapter	1-10
Connecting	3-3
Address	
Copying	5-26, 6-18, 8-14
Modifying	5-25
New	5-23, 6-15, 8-11
Address Book Server	6-36
Address Book Settings	6-14, 8-9
Address Selection Screen	5-15
Address Type	
E-mail	5-23, 6-15, 8-11
Fax	6-17, 8-13
FTP Server	5-24, 6-15, 8-11
Group	5-25, 6-17, 8-13
Shared Folder	5-23, 6-16, 8-12
Adjusting the Touch Panel	10-11
Administrator Password	6-32
Administrator Settings	3-5
Administrator Password	3-9
Backup / Restore Setting Information	3-10
Display Language Setting	3-12
Logging In to the Administrator Settings	3-8
Network Settings	3-9
Roller Counter Reset	3-11
ScanFront 300 Initialization	3-11
Select Login Type	3-10
Touch Panel Adjustment	3-11
Authentication Server	6-35
Auto Logout	6-31

B

Backup	6-40
--------------	------

C

Card	2-3
Cleaning	
Fingerprint Sensor	9-2
Rollers	9-3
Scanner Unit	9-2
Scanning Glass	9-3
Touch Panel	9-2
Conceptual Diagram of the ScanFront	i
Connecting the AC Adapter	3-3
Connecting the Network Cable	3-3
Consumable Parts	11-4
Copying Job Buttons	6-26, 8-23
Custom File Name Settings	6-8, 8-6

D

Delivery Options	5-34
Detailed Settings	5-29, 6-25, 8-22
Device Authentication	5-4, 8-3
Device Configuration	6-29
Device Operation	6-31
Display Off	6-31
Disposal	1-5
Document Holding Guide	9-8
Documents	2-2
Double Feed Error	2-9

E

Editing Users	6-11
Eject Tray	2-4
Error Messages	
ScanFront	10-6
Web Menu	10-9
Exchange Roller Kit	9-8
Exporting and Importing Address Books	6-18, 8-14
Exporting and Importing Job Buttons	6-27, 8-24
External Dimensions	11-5

F

Fax Server	6-34
Features	1-6
Feed Roller	9-6
Feed Selection Lever	2-5
Feed Tray	2-4
File Formats	5-32, 6-24, 8-21
Fingerprint Authentication	2-12, 5-7
Fingerprint Registration	5-10
Fingerprint Sensor	1-9, 2-11
Flow Up Until Sending an Image File	5-2

H

Handling	1-3
Home Screen	5-8

I

Index Settings	6-9, 8-7, 8-19
Initializing ScanFront	10-13
Installation Location	1-2, 3-2
Installing	
ScanFront Administration Tool	7-3
ScanFront Service	4-3
Introduction	i

J

Job Button Screen	5-8
Job Button Settings	6-20, 8-16, 8-18
Address	6-21
Address Settings	8-18
Delivery Options	6-21, 8-18
Detailed Settings	6-21, 8-18
E-mail Settings	6-21, 8-18
Scan Settings	6-21, 8-18

K

Key in Type Login	5-6, 6-31
-------------------------	-----------

L

Language	6-30
List Type Login	5-5, 6-31
Loading Mark	2-7
Lock Lever	2-10, 9-3
Log Settings	6-37, 6-42
Logging In to the Web Menu	6-5, 8-3
Login Options	6-31
Login Screen	
Key in Type	5-4
List Type	5-4
Server Authentication	5-4
Low Power Mode	6-31

M

Managing the ScanFront Scanners	7-6
Moving the Scanner	1-3

N

Names and Functions of Parts	1-9
Network Cable	3-3
Network Environment	1-11
Network Setting (Web Menu)	6-30

P

Paper Jam	2-9
Placing a Card	2-8
Placing a Folded Document	2-7
Placing a Long Document	2-7
Placing Documents	2-6
Plain Paper	2-2
Preparing the Scanner	2-4

R

Registering New Job Buttons	6-21, 8-18
Registering New Users	6-7
Restore	3-10, 6-40
Restricting User Functions	6-10
Restriction to Edit	6-11
Retard Roller	9-5
Roller Counter	9-9
Routine Cleaning	9-2

S

Safety Instructions	1-2
Scan Settings	5-28, 8-19
Basic Condition Settings	5-28
Detailed Settings	5-29
Scan Settings (Job Button)	6-22
Scan/Delivery Options	5-27
ScanFront Administration Tool	7-2
ScanFront Service	4-2
ScanFront Service Server	4-2
Scanning	5-19
Scanning Glass	9-3
Security Settings	5-33
Server Authentication	5-4, 8-3
Server Settings	6-33
Setting Up	3-5
ScanFront Administration Tool	7-5
Specifications	11-2

T

Timezone	6-30
Troubleshooting	10-2
Turning Off the Power	3-4, 5-3
Turning On the Power	3-4, 5-3

U

Update	6-41
Update Files	6-41
Update the Version	6-41
USB Memory	5-17
USB Memory Screen	5-17
USB Port	2-5
User Administration	6-6
User Settings	8-4
User Settings Screen	5-9
Change Password	5-9
Fingerprint Registration	5-9

V

Version Information	6-41
---------------------------	------

W

Web Menu	
User Mode	8-2
Web Menu (Administrator Mode)	3-6, 6-3
Web Menu (User Mode)	6-4
Web Menu Overview	6-2, 8-2



CANON ELECTRONICS INC.

1248, SHIMOKAGEMORI, CHICHIBU-SHI, SAITAMA 369-1892, JAPAN

CANON U.S.A. INC.

ONE CANON PARK, MELVILLE, NY 11747, U.S.A.

CANON CANADA INC.

6390 DIXIE ROAD, MISSISSAUGA, ONTARIO L5T 1P7, CANADA

CANON EUROPA N.V.

BOVENKERKERWEG 59, 1185 XB AMSTELVEEN, THE NETHERLANDS

CANON LATIN AMERICA, INC.

703 WATERFORD WAY, SUITE 400 MIAMI, FLORIDA 33126, U.S.A.

CANON AUSTRALIA PTY. LTD.

1 THOMAS HOLT DRIVE, NORTH RYDE, SYDNEY. N.S.W, 2113. AUSTRALIA

CANON SINGAPORE PTE. LTD.

1 HARBOUR FRONT AVENUE #04-01, KEPPEL BAY TOWER, SINGAPORE 098632

CANON HONGKONG COMPANY LTD.

19TH FLOOR, THE METROPOLIS TOWER, 10 METROPOLIS DRIVE, HUNGHOM, KOWLOON, HONG KONG.

CANON KOREA BUSINESS SOLUTIONS INC.

168-12 SAMSEONG-DONG, GANGNAM-GU, SEOUL, KOREA

CANON INDIA PVT. LTD

7TH FLOOR, TOWER B DLF CYBER TERRACES DLF PHASE III GURGAON - 122002 HARYANA, INDIA