

Canon

imageCLASS

MF4570dw

Basic Operation Guide

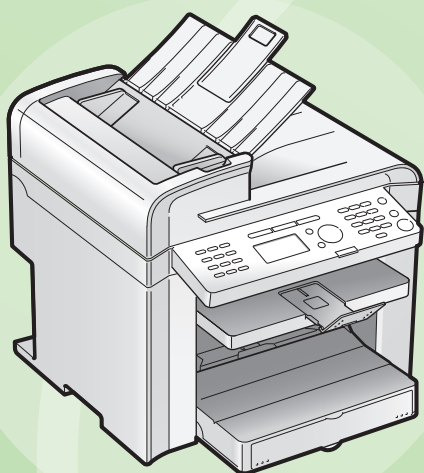

Quick View- Perform Useful Tasks [Next Page](#)

1

[Before Using the Machine](#) [P.1-1](#)

2

[Document and Paper Handling](#) [P.2-1](#)

3

[Copying](#) [P.3-1](#)

4

[Printing from a Computer](#) [P.4-1](#)

5

[Registering Destinations in the Address Book](#) [P.5-1](#)

6

[Using the Fax Functions](#) [P.6-1](#)

7

[Using the Scan Functions](#) [P.7-1](#)

8

[Maintenance](#) [P.8-1](#)

9

[Troubleshooting](#) [P.9-1](#)

10

[Registering/Setting the Various Functions](#) [P.10-1](#)

11

[Appendix](#) [P.11-1](#)

- Network Setting Procedure
- Security Functions
- Searching in Detail

See the e-Manual.
 User Software CD-ROM

- Searching the Installation and Connection Procedure

See the Starter Guide.

Be sure to read the manual before using the machine.
Keep the manual for future reference.

Copy

Print

Fax

Scan

Network Settings & Remote UI

There are a variety of print functions that are explained in later pages of this manual as well as in the e-Manual. Enlarge or reduce documents and print multiple-page data onto one sheet. You can also perform 2-sided printing.

Below is a quick overview of highlighted print features that you can utilize in your everyday use.

● Various Printing Functions ● ● ● ● For details, see "Printing from a Computer" from p. 4-1.

● Enlarged/Reduced Printing

You can enlarge or reduce standard size documents to copy on standard size paper or specify the copy ratio in percentage.

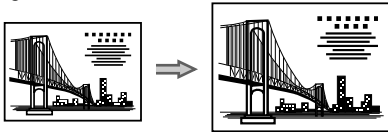

● 2-Sided Printing

You can print on both sides of paper.

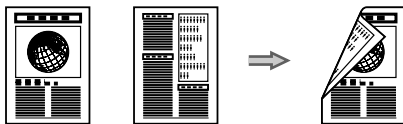

● Reduced Layout

You can reduce multiple documents to print them onto one sheet.

2 on 1

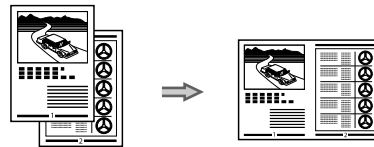

4 on 1

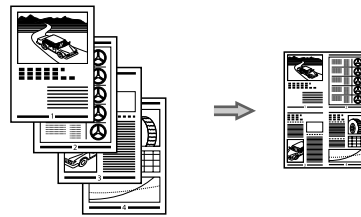

● Miscellaneous Printing Functions ● ● ● ● For details, see "Print" in the e-Manual.

● Booklet Printing

Booklet printing allows you to make a booklet by folding printouts in half.

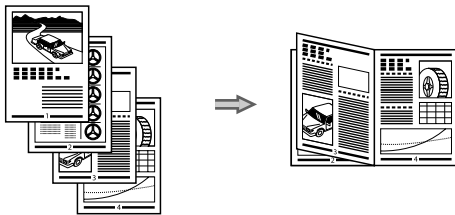

● Poster Printing

You can magnify and divide a single page image to print it out on multiple sheets of paper. You can make one large poster by joining these printouts together.

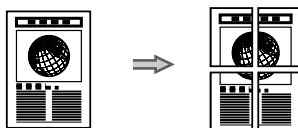

● Watermark Printing

You can superimpose watermarks (such as [COPY] and [DRAFT]) over the documents created by an application.

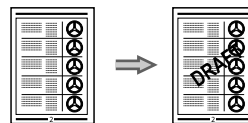

● Displaying a Preview before Printing

You can check the printout result on a computer display.

● Selecting a "Profile"

Some printer driver settings are provided as "Profiles" beforehand.

You can perform printing which suits your needs only by selecting a "Profile."

Quick View- Perform Useful Tasks

Copy

Print

Fax

Scan

Network Settings & Remote UI

There are a variety of fax functions that are explained in later pages of this manual as well as in the e-Manual. The machine is equipped with a Super G3 fax, with high transmission speeds as well as the PC function which can send a document from a computer directly, which reduces paper costs.

Below is a quick overview of highlighted fax features that you can utilize in your everyday use.

● Sending a Document Directly from a Computer (PC Fax) ● ● ● For details, see "Fax" in the e-Manual.

You can send a document or image created in an application as a fax directly using the fax driver from a computer on a network. Because you do not need to print the document, you can reduce the paper cost as well as send a clear document which has little dirt or blur.

You can import the address book using the fax driver, enabling you to send a fax to a destination easily without mistakes.

You can also create a cover sheet for when sending a fax.

* You need to install the fax driver in a computer.

* If you are a Macintosh user, see the following.

- To install the Fax Driver
→ Starter Guide or Mac Fax Driver Installation Guide
- To view how to use each function
→ Fax Driver's Help

To view how to display the Mac Fax Driver Installation Guide or Fax Driver's Help, see "For Macintosh Users" (→P.11-4).

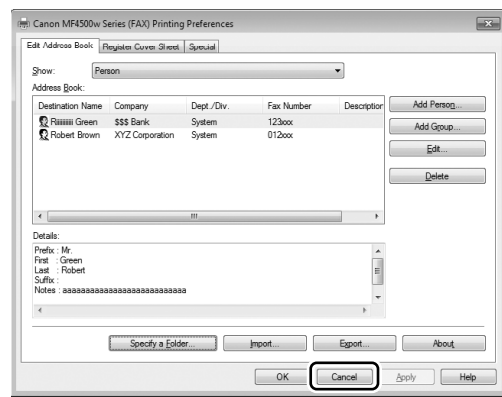

▲ Fax driver screen

Data is created
in a computer

Send



● Forwarding the Received Fax (Manual Forwarding) ● ● ● ● ● For details, see "Using the Fax Functions" from p. 6-1.

You can forward received faxes stored in the memory to a specified destination.

Received Fax

Forward

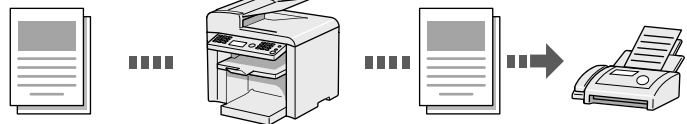

● Registering Destinations in the Address Book ● ● For details, see "Registering Destinations in the Address Book" from p. 5-1.

By registering destinations for sending faxes beforehand, you can save many steps to enter the destinations when sending the documents.

- One-touch keys
- Coded dialing
- Group dialing

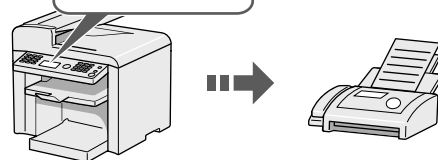

● **Various Sending/Receiving Functions** ● ● ● For details, see "Using the Fax Functions" from p. 6-1.

Various Sending Functions

Various Methods for Specifying a Destination

You can register fax destinations in the address book. You can specify the destinations using various methods, enabling you to send documents quickly and easily.

● **Destination search**

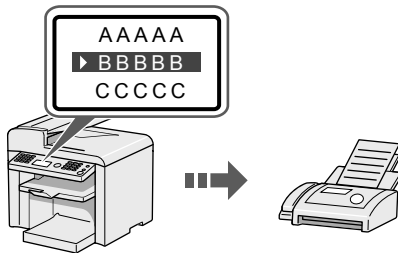

● **One-touch keys**

By registering destinations in one-touch keys, you can specify a destination in one step. You can register up to 4 destinations in one-touch keys.

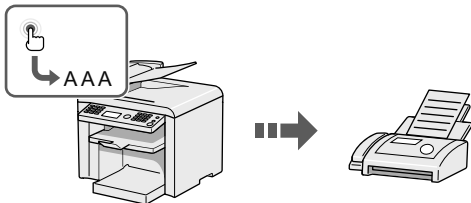

● **Coded dialing**

Because you can register up to 100 destinations under coded dial codes, you can register destinations which cannot be registered under one-touch keys. If you forget the coded dial codes, you can specify the destination by searching it in the address book.

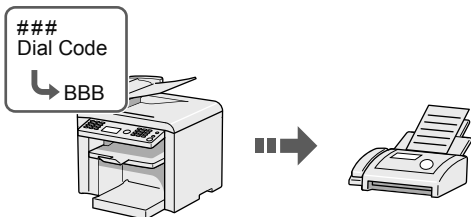

● **Destination Group**

You can combine multiple destinations and register them as a group. Up to 50 destinations can be combined.

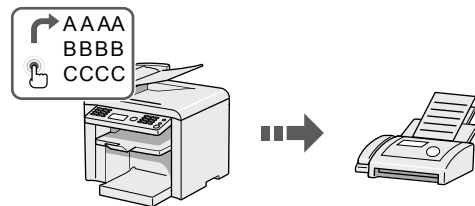

● **Specifying from the sending history**

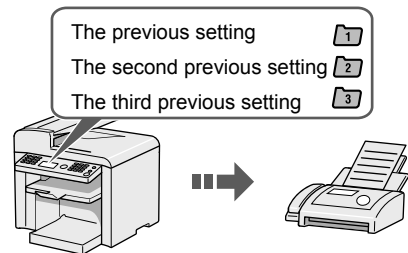

● **Sequential broadcast**

By scanning a document once, you can send the same document to multiple destinations.

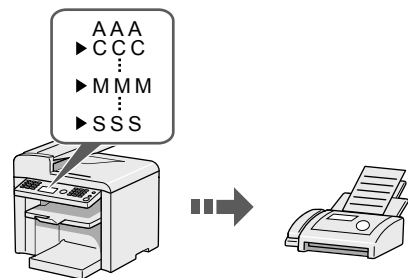

Various Receiving Functions

● **Receiving in the Memory**

Received documents are normally printed immediately. However, you can store the documents temporarily in the memory without printing. You can print the stored documents at any time. If you do not need them, you can delete them, saving paper to be used.

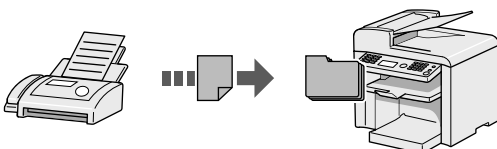

● **Remote Receiving**

If an external telephone is connected, you can switch to the fax receiving mode immediately by dialing the ID number for fax receiving using the dial buttons of the telephone during a phone call.

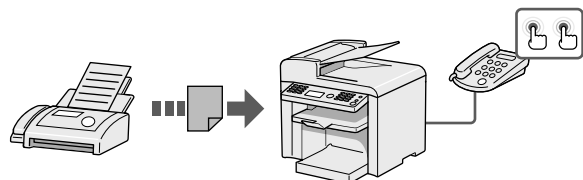

Quick View- Perform Useful Tasks

Copy

Print

Fax

Scan

Network Settings & Remote UI

There are a variety of scan functions that are explained in later pages of this manual as well as in the e-Manual. You can easily send scanned documents to your computer.

Below is a quick overview of highlighted scan features that you can utilize in your everyday use.

● Saving in a Computer

There are two methods for saving scanned documents in a computer.

■ Saving the Documents Using the Operation Panel of the Machine

For details, see "Using the Scan Functions" from p. 7-1.

You can easily save scanned documents in a computer only by operating the operation panel of the machine. Various scanning settings have been prepared for your purposes. Therefore, you can create a "Searchable PDF" file, which can be used for text retrieval or as text data, without specifying special settings.

* If you are using Macintosh, you may not create "Searchable PDF."

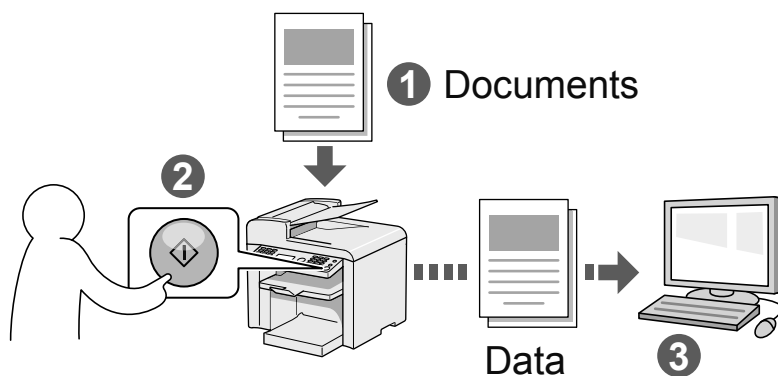

■ Saving the Documents Using Operations from a Computer

For details, see "Scan" in the  e-Manual.

● Scanning with the MF Toolbox

Scanning is performed by operating the software supplied with the machine.

* MF Toolbox for Macintosh and MF Toolbox for Windows may be different in some features.

For details, see the Mac Scanner Driver Guide

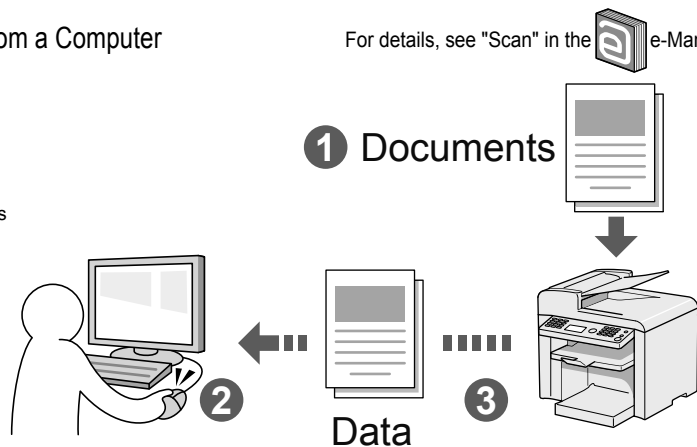

● Scanning from an Application

Scanning is performed using your application.

This allows you to open the scanned data as is in your application.

● Scanning with the WIA Driver (Windows XP/Vista/7 Only)

Scanning is performed using the driver system supplied with Windows operating systems.

There are various scanning methods.

- Scanning from the [Scanner and Camera Wizard] dialog box
- Scanning from the [Windows Fax and Scan] dialog box
- Scanning from Windows Photo Gallery
- Scanning from an Application

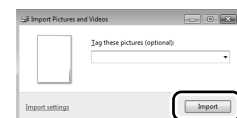

Contents

Contents	viii
Manuals for the Machine	xi
Available Features	xii
How to Use This Manual	xii
Important Safety Instructions	xiii
Installation Requirements and Handling	xvii
Legal Notices	xix
Laser Safety	xxiii

1. Before Using the Machine 1-1

Names and Functions on Each Part of the Machine	1-2
Front Side	1-2
Back Side	1-3
Interior	1-3
Multi-purpose Tray	1-4
Paper Cassette	1-4
Operation Panel	1-5
LCD (Standby Mode)	1-6
Copy Mode	1-6
Fax Mode	1-6
Scan Mode	1-6
Navigating the Menu	1-7
Entering the Menu Screen	1-7
Scrolling Through Menu Items	1-7
Selecting a Menu Item	1-7
Specifying values using the navigation keys	1-8
Returning to the Default Screen	1-8
Text Input Method	1-9
Entering Text Except for IP Address	1-9
Changing the Entry Mode	1-9
Entering Text, Symbols, and Numbers	1-9
Moving the Cursor (Entering a Space)	1-9
Deleting text, symbols, or numbers	1-9
Entering IP Address	1-10
Setting the Sleep Timer	1-11
Setting the Current Date and Time	1-12

2. Document and Paper Handling 2-1

Document Requirements	2-2
Scanning Range	2-2
Copy	2-2
FAX	2-3
Scan	2-3

Placing Documents	2-4
Placing Documents on the Platen Glass	2-4
Loading Document in the Feeder	2-4
Paper Requirements	2-6
Paper Size	2-6
Paper Type	2-7
Printable Range	2-8
Loading Paper	2-9
In the Paper Cassette	2-9
In the Multi-Purpose Tray	2-11
Precautions when Loading Paper	2-12
Paper Loading Capacity	2-12
Paper Loading Orientation	2-13
When printing paper with a letterhead or logo (previously printed paper)	2-13
Printing on Envelopes	2-13
Setting a Paper Size and Type	2-14
Setting a Custom Paper Size	2-14
Selecting Print Side	2-16
When setting this item to <Print Speed Priority> (the default setting)	2-16
When setting this item to <Print Side Priority>	2-16

3. Copying 3-1

Basic Copying Method	3-2
Checking and Canceling Copy Jobs	3-3
Canceling using the Stop Key	3-3
Checking and Canceling using the Status Monitor/Cancel Key	3-3
Copy Settings	3-4
Adjusting the Density	3-4
Selecting Image Quality (Copy)	3-4
2-Sided Copying	3-5
Enlarging/Reducing Copies	3-6
Multiple Documents onto One Sheet (N on 1)	3-6
Collating Copies	3-7
Emphasize the Outline of an Image (Sharpness)	3-7
Copying an ID Card	3-8
Changing the Default Values	3-9

4. Printing from a Computer 4-1

Installing the Printer Driver	4-2
Printing from a Computer	4-3
Scaling Documents	4-3
Printing Multiple Pages on One Sheet	4-3
2-sided Printing	4-4
Checking and Canceling Print Jobs	4-5

5. Registering Destinations in the Address Book 5-1

Address Book	5-2
One-touch Keys	5-2
Coded Dialing	5-2
Group Dialing	5-2
Registering and Editing One-Touch Keys	5-3
Registering and Editing via the Operation Panel	5-3
Registering and Editing One-Touch Keys via the Remote UI	5-5
Registering and Editing Coded Dial Codes	5-6
Registering and Editing via the Operation Panel	5-6
Registering and Editing a coded Dial Code via the Remote UI	5-8
Registering and Editing Recipients for Group Dialing	5-9
Registering and Editing a Destination Group via the Operation Panel	5-9
Registering and Editing a Destination Group via the Remote UI	5-12

6. Using the Fax Functions 6-1

Basic Method for Sending Faxes	6-2
Fax Settings	6-3
Image Quality Settings	6-3
Density Settings	6-3
Sharpness Settings	6-3
Specifying Destinations	6-4
Specifying Destinations by Entering a Fax Number	6-4
Specifying Destinations with the One-Touch Keys	6-4
Specifying Destinations Using Coded Dialing	6-4
Specifying Destinations Using Group Dialing	6-5
Specifying Destinations Using the Address Book	6-5
Redialing (Manual Redialing)	6-6
Useful Fax Sending Methods	6-7
Sending a Fax after Making a Phone Call (Manual Sending)	6-7
Push-button Telephone Service Using a Dial-line	6-7
Sending a Fax Abroad (Adding Pauses)	6-8
Sending to Multiple Destinations at a Time (Sequential Broadcast)	6-9
Receiving Faxes	6-10
Receive Mode	6-10
Changing the Receive Mode	6-12
Detailed Settings for the Fax/Tel Auto Switch Mode	6-13
Forwarding Received Fax Documents in Memory to Other Destinations (Manual Forwarding)	6-14
Checking and Managing Fax Documents in Memory	6-15
Checking and Canceling Fax Jobs	6-15
Printing Received Fax Documents	6-15
Checking and Deleting Received Fax Documents	6-16
Checking the History of Received/Sent Fax Documents	6-17

Changing the Default Values for Fax 6-18

Changing the Fax Settings (Items Specified Using the [Menu] Button)	6-19
Setting Procedure for Sending Faxes	6-19
Setting Items	6-19
Register Unit Name	6-20
Register Unit Telephone Number	6-20
Select Line Type	6-20
Public Line Connection	6-20
Off-Hook Alarm	6-20
Sender ID	6-20
Change Defaults	6-20
ECM TX	6-20
Pause Time	6-21
Auto Redial	6-21
Check Dial Tone Before Sending	6-21
Setting Procedure for Receiving Faxes	6-21
Setting Items for the Receive Settings	6-22
2-Sided Printing	6-22
Reduce RX Size	6-22
RX Page Footer	6-22
Continue Print. When Toner Is Nearly Out	6-22
ECM RX	6-22
Incoming Ring	6-23
Remote RX	6-23
Auto RX Switch	6-23
System Settings Procedure	6-23
Setting Items	6-24
TX Start Speed	6-24
RX Start Speed	6-24
Memory Lock Settings	6-24
Select Country/Region	6-24
Address Book PIN	6-25
Restrict New Destinations	6-25
Allow Driver Faxing	6-25
Restrict Sending From History	6-25
Fax No. Confirmation Re-Entry	6-25
Restrict Sequential Broadcast	6-25
Canceling Fax Jobs	6-26

7. Using the Scan Functions 7-1

Basic Operation Methods for Scanning	7-2
---	------------

8. Maintenance 8-1

Cleaning the Machine	8-2
Cleaning the Exterior	8-2
Cleaning the Interior	8-2
Cleaning the Fixing Unit	8-3
Cleaning the Platen Glass	8-4
Cleaning the Feeder	8-4
Precautions When Cleaning the Machine	8-4
Replacing Toner Cartridges	8-6
When a Message Appears	8-6
When White Streaks Appear On the Printouts or Some Parts Are Faded	8-6

About the Supplied Toner Cartridge	8-7
About Replacement Toner Cartridge	8-7
Handling Toner Cartridge	8-7
Checking the Toner Level	8-8
Using the Toner Saver Mode	8-8
Before Replacing the Toner Cartridge	8-9
Replacing the Toner Cartridge	8-10
Precautions when Replacing Toner Cartridge	8-11
Purchase Consumables	8-12
Recycling Used Cartridges	8-13
The Clean Earth Campaign	8-13
U.S.A. PROGRAM	8-13
Packaging	8-13
Shipping	8-14
CANADA PROGRAM-CANADA PROGRAMME	8-15
Transporting the Machine	8-16
Precautions when Transporting the Machine	8-17

9. Troubleshooting 9-1

Clearing Jams	9-2
Document Jams in the Feeder	9-3
Paper Jams Inside the Machine	9-3
Display Message	9-6
Error Codes	9-6
If <Incorrect Size/Setting> Appears	9-8
Troubleshooting	9-9
Check the Following First	9-9
Is the power switched ON?	9-9
Has the power switch been just turned ON?	9-9
Is the machine in Sleep mode?	9-9
Are the settings proper?	9-9
Is the Error indicator on or blinking?	9-9
Does a message appear on the display?	9-10
Is the telephone line connected or configured properly?	9-10
If You Cannot Solve a Problem	9-10
If a Power Failure Occurs	9-11
If You Cannot Solve a Problem	9-12
Customer Support (U.S.A.)	9-12
Customer Support (Canada)	9-12
Print Result Is Not Good	9-13
Paper Curls	9-13
Paper Creases	9-14
Printing Is Uneven	9-14
White Specks Appear	9-15
The Toner Does Not Fix onto the Paper Well	9-16
The Printed Paper Has Vertical Streaks	9-16
Smudge Marks of Spattering Toner Appear around the Text or Patterns	9-17
The Overall Print Result Is Dark	9-17
Copied Lines and Text Appear Faded	9-18
Printed Bar Codes Cannot Be Scanned	9-18
Paper Jams Occur Frequently When Performing 2-Sided Printing	9-18

10. Registering/Setting the Various Functions 10-1

Setting Menu List	10-2
Printing a User Data List	10-2
Contents of the Setting Menu	10-2

11. Appendix 11-1

Main Specifications	11-2
Machine Specifications	11-2
Wireless LAN Specification	11-2
Copy Specifications	11-2
Printer Specification	11-3
Scanner Specifications	11-3
Fax Specifications	11-3
Telephone Specifications	11-3
For Macintosh Users	11-4
Displaying Driver Guides (HTML Files)	11-4
Displaying a Driver's Help System	11-4
Content of the e-Manual about Features that Are Unavailable on the Macintosh	11-4
Index	11-5

● Manuals for the Machine

Read this manual first.

This manual describes the settings for setting up the machine and installing the software. Be sure to read this manual before using the machine.

Starter Guide



- Preface
- Installing the Machine
- Configuring and Connecting the Fax
- Connecting to a Computer and Installing the Drivers
- Appendix

Read this manual with Starter Guide.

This manual describes Wireless LAN setup procedures and causes and countermeasures for troubles you might face during the setup. Be sure to read this manual before using the machine.

Wireless LAN Setting Guide



- Setting the wireless LAN
- Troubleshooting
- Appendix

Read this manual next.

This manual describes the basic use of the machine.

Basic Operation Guide

This manual

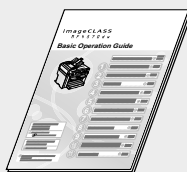

- Before Using the Machine
- Document and Paper Handling
- Copying
- Printing from a Computer
- Registering Destinations in the Address Book
- Using the Fax Functions
- Using the Scan Functions
- Maintenance
- Troubleshooting
- Registering/Setting Functions
- Appendix

Read the desired chapter to suit your needs.

The e-Manual is categorized by subject to find desired information easily.

e-Manual

* The e-Manual is included in the User Software CD-ROM.



- Important Safety Instructions
- Basic Operation
- Copy
- Fax *
- Print *
- Scan *
- Network Settings
- Security
- Setting and Managing from Computer
- Troubleshooting
- Maintenance
- Setting Menu List
- Specifications

* If you are using Macintosh, see the following Driver Guides or Help for more details on these functions.

You can find the driver guides in the following locations on the User Software CD-ROM.

- Mac Fax Driver Installation Guide:
User Software CD-ROM → [Manuals] → [GUIDE-FAX-US.pdf]
- Mac UFR II Printer Driver Installation Guide:
User Software CD-ROM → [Manuals] → [GUIDE-UFR II-US.pdf]
- Mac Scanner Driver Guide:
User Software CD-ROM → [Manuals] → [GUIDE-SCAN-US.pdf]

Available Features

The following features are available for each model.

○ : available

— : not available

	Copy	Print	2-sided Printing	Fax (PC Fax)	Scan (USB)	Scan	Remote UI	ADF (1-sided)	ADF (2-sided)	Wireless LAN
MF4570dw	○	○	○	○	○	○	○	○	—	○

How to Use This Manual

Symbols Used in This Manual



WARNING

Indicates a warning concerning operations that may lead to death or injury to persons if not performed correctly. To use the machine safely, always pay attention to these warnings.



CAUTION

Indicates a caution concerning operations that may lead to injury to persons if not performed correctly. To use the machine safely, always pay attention to these cautions.



IMPORTANT

Indicates operational requirements and restrictions. Be sure to read these items carefully to operate the machine correctly, and avoid damage to the machine or property.



NOTE

Indicates a clarification of an operation, or contains additional explanations for a procedure. Reading these notes is highly recommended.



Indicates an operation that must not be performed. Read these items carefully, and make sure not to perform the described operations.

Keys and Buttons Used in This Manual

The following symbols and key names are a few examples of how keys to be pressed are expressed in this manual.

- Operation panel keys: [Key icon] + (Key name)
Example: [] (Stop)
- Display: <Specify destination.>
- Buttons and items on the computer display: [Preferences]

Displays Used in This Manual

The display used in this manual is the factory preset display for the machine. Depending on the system configuration, the appearance of the display may differ.

Important Safety Instructions

Please read these "Important Safety Instructions" thoroughly before operating the machine.

As these instructions are intended to prevent injury to the user and other persons or to prevent destruction of property, always pay attention to these instructions and operational requirements.

Also, as it may result in unexpected accidents or injuries, do not perform any operation unless otherwise specified in the manual.

Installation

! WARNING

- Do not install the machine in a location near alcohol, paint thinner, or other flammable substances. If flammable substances come into contact with electrical parts inside the machine, this may result in a fire or electrical shock.
- Do not place the following items on the machine.
 - Necklaces and other metal objects
 - Cups, vases, flowerpots, and other containers filled with water or liquids

If these items come into contact with a high-voltage area inside the machine, this may result in a fire or electrical shock. If these items are dropped or spilled inside the machine, immediately turn off the power switches of the machine and computer (1) and disconnect the interface cable if it is connected (2). Then, unplug the power plug from the AC power outlet (3) and contact your local authorized Canon dealer.

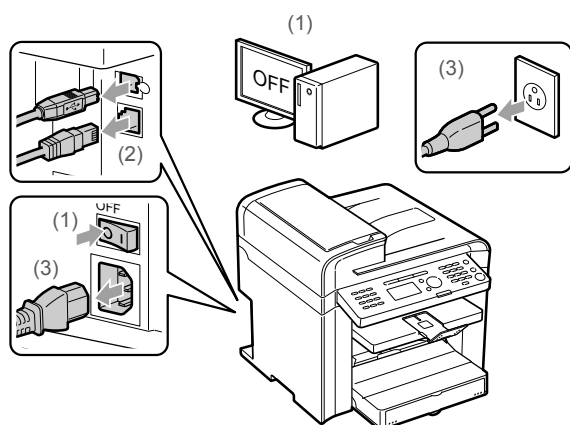

- Do not use this product near any medical electric equipments. Radiowave emitted from this product may influence those medical electric equipments. This may result in accidents caused by malfunction.

! CAUTION

- Do not install the machine in unstable locations, such as on unsteady platforms or inclined floors, or in locations subject to excessive vibrations, as this may cause the machine to fall or tip over, resulting in personal injury.
- The ventilation slots are provided for proper ventilation of working parts inside the machine. Never place the machine on a soft surface, such as a bed, sofa, or rug. Blocking the slots can cause the machine to overheat, resulting in a fire.

- Do not install the machine in the following locations, as this may result in a fire or electrical shock.
 - A damp or dusty location
 - A location exposed to smoke and steam, such as near a cookery or humidifier
 - A location exposed to rain or snow
 - A location near a water faucet or water
 - A location exposed to direct sunlight
 - A location subject to high temperatures
 - A location near open flames
- When installing the machine, gently lower the machine to the installation site so as not to catch your hands between the machine and the floor or between the machine and other equipment, as this may result in personal injury.
- When connecting the interface cable, connect it properly by following the instructions in this manual. If not connected properly, this may result in malfunction or electrical shock.
- When moving the machine, follow the instructions in this manual to hold it correctly. Failure to do so may cause you to drop the machine, resulting in personal injury.
 - ☒ "Transporting the Machine" (→P.8-16)

Power Supply

! WARNING

- Do not damage or modify the power cord. Also, do not place heavy objects on the power cord or pull on or excessively bend it. This can cause electrical damage, resulting in fire or electrical shock.
- Keep the power cord away from all heat sources. Failure to do so can cause the power cord insulation to melt, resulting in a fire or electrical shock.
- The power cord should not be taut, as this may lead to a loose connection and cause overheating, which could result in a fire.
- The power cord may become damaged if it is stepped on, fixed with staples, or if heavy objects are placed on it. Continued use of a damaged power cord can lead to an accident, such as a fire or electrical shock.
- Do not plug or unplug the power plug with wet hands, as this can result in electrical shock.
- Do not plug the power cord into a multiplug power strip, as this can result in a fire or electrical shock.
- Do not bundle up or tie up the power cord in a knot, as this can result in a fire or electrical shock.
- Insert the power plug completely into the AC power outlet. Failure to do so can result in a fire or electrical shock.
- If excessive stress is applied to the connection part of the power cord, it may damage the power cord or the wires inside the machine may disconnect. This could result in a fire. Avoid the following situations:
 - Connecting and disconnecting the power cord frequently.
 - Tripping over the power cord.

- The power cord is bent near the connection part, and continuous stress is being applied to the power outlet or the connection part.
- Applying a shock to the power connector.
- Do not use power cords other than the one provided, as this can result in a fire or electrical shock.
- As a general rule, do not use extension cords. Using an extension cord may result in a fire or electrical shock.
- Remove the power plug from the AC power outlet and refrain from using the machine during a thunder storm. Lightning can result in a fire, electrical shock or malfunction.

! CAUTION

- Do not use a power supply voltage other than that listed herein, as this may result in a fire or electrical shock.
- Always grasp the power plug when unplugging the power plug. Do not pull on the power cord, as this may expose the core wire of the power cord or damage the cord insulation, causing electricity to leak, resulting in a fire or electrical shock.
- Leave sufficient space around the power plug so that it can be unplugged easily. If objects are placed around the power plug, you may be unable to unplug it in an emergency.

Handling

! WARNING

- Do not disassemble or modify the machine. There are high-temperature and high-voltage components inside the machine which may result in a fire or electrical shock.
- Electrical equipment can be hazardous if not used properly. Do not allow children to touch the power cord, cables, internal gears, or electrical parts.
- If the machine makes an unusual noise or emits smoke, heat, or an unusual smell, immediately turn off the power switches of the machine and computer and disconnect the interface cable if it is connected. Then, unplug the power plug from the AC power outlet and contact your local authorized Canon dealer. Continued use can result in a fire or electrical shock.
- Do not use flammable sprays near the machine. If flammable substances come into contact with electrical parts inside the machine, this may result in a fire or electrical shock.
- Always turn off the power switches of the machine and computer, and then unplug the power plug and interface cables before moving the machine. Failure to do so can damage the cables or cords, resulting in a fire or electrical shock.
- Confirm that the power plug or power connector is inserted completely after moving the machine. Failure to do so can result in an overheating and fire.
- Do not drop paper clips, staples, or other metal objects inside the machine. Also, do not spill water, liquids, or other flammable substances (alcohol, benzene, paint thinner, etc.) inside the machine. If these items come into contact with a high-voltage area inside the machine, this may result in a fire or electrical shock. If these items are dropped or spilled inside the machine, immediately turn off the power switches of the machine and computer and disconnect the interface cable if it is connected. Then, unplug the power plug from the AC power outlet and contact your local authorized Canon dealer.
- When plugging or unplugging a USB cable when the power plug is plugged into an AC power outlet, do not touch the metal part of the connector, as this can result in electrical shock.

! CAUTION

- Do not place heavy objects on the machine. The object or the machine may fall, resulting in personal injury.
- Turn off the power switch when the machine will not be used for a long period of time, such as overnight. Turn off the machine and unplug the power plug if the machine will not be used for an extended period of time, such as for several days.
- Open or close covers and install or remove cassettes gently and carefully. Be careful not to hurt your fingers.
- Keep your hands and clothing away from the roller in the output area. Even if the machine is not printing, the roller may suddenly rotate and catch your hands or clothing, resulting in personal injury.
- The output slot is hot during and immediately after printing. Do not touch the area surrounding the output slot, as this may result in burns.
- Printed paper may be hot immediately after being output. Be careful when removing the paper and aligning the removed paper, especially after continuous printing. Failure to do so may result in burns.
- When performing copy with a thick book placed on the platen glass, do not press the feeder forcefully. This may damage the platen glass and cause personal injury.
- Be careful not to drop a heavy object, such as a dictionary, on the platen glass. This may damage the platen glass and cause personal injury.
- Close the feeder gently so as not to catch your hand. This may result in personal injury.
- The laser beam can be harmful to the human body. The laser beam is confined in the laser scanner unit by a cover, so there is no danger of the laser beam escaping during normal machine operation. Read the following remarks and instructions for safety.
 - Never open covers other than those indicated in this manual.
 - Do not remove the caution label attached to the cover of the laser scanner unit.

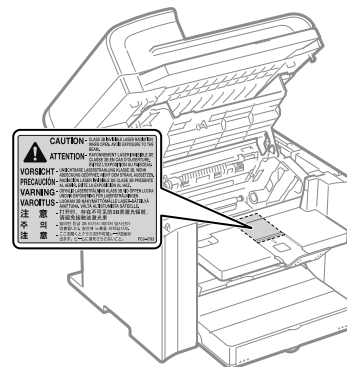

- If the laser beam should escape and enter your eyes, exposure may cause damage to your eyes.
- If you operate this machine in manners other than the control, adjustment, and operating procedures prescribed in this manual, this may result in hazardous radiation exposure.
- This machine is confirmed as the class 1 laser product in IEC60825-1:2007.

Maintenance and Inspections

WARNING

- When cleaning the machine, turn off the machine and computer, and unplug the interface cables and power plug. Failure to do so can result in a fire or electrical shock.
- Unplug the power plug from the AC power outlet periodically and clean the area around the base of the power plug's metal pins and the AC power outlet with a dry cloth to remove all dust and grime. In damp, dusty, or smoky locations, dust can build up around the power plug and become damp, which can cause a short circuit, resulting in a fire.
- Clean the machine with a well wrung out cloth dampened with water or mild detergent diluted with water. Do not use alcohol, benzene, paint thinner, or other flammable substances. If flammable substances come into contact with electrical parts inside the machine, this may result in a fire or electrical shock.
- Some areas inside the machine are subject to high voltage. When removing jammed paper or when inspecting inside of the machine, be careful not to allow necklaces, bracelets, or other metal objects to touch the inside of the machine, as this can result in burns or electrical shock.
- Do not dispose of used toner cartridges in open flames. This may cause the toner remaining inside the cartridges to ignite, resulting in burns or fire.
- Confirm that the power plug or power connector is inserted completely after cleaning the machine. Failure to do so can result in an overheating and fire.
- Check the power cord and plug regularly. The following conditions may result in fire, so please contact your local authorized Canon dealer or the Canon help line.
 - There are burn marks on the power plug.
 - The blade on the power plug is deformed or broken.
 - The power is turned OFF or ON when bending the power cord.
 - The coating of the power cord is damaged, cracked, or dented.
 - A part of the power cord becomes hot.
- Check regularly that the power cord and plug are not handled in the following manner. Failure to do so can result in a fire or electrical shock.
 - The power connector is loosened.
 - Stress is being applied to the power cord by a heavy object or by fixing it with staples.
 - The power plug is loosened.
 - The power cord is tied in a bundle.
 - A part of the power cord is put in an aisle.
 - The power cord is put in front of the heating appliance.

CAUTION

- The fixing unit and its surroundings inside the machine become hot during use. When removing jammed paper or when inspecting the inside of the machine, do not touch the fixing unit and its surroundings, as this may result in burns.

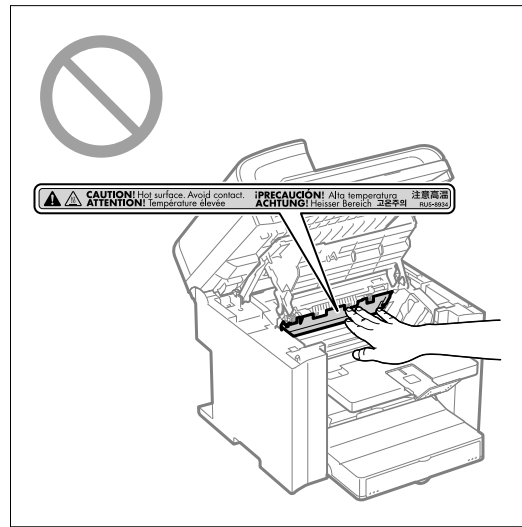

- When removing jammed paper or when inspecting the inside of the machine, do not expose yourself to the heat emitted from the fixing unit and its surroundings for a prolonged period of time. Doing so may result in low temperature burns, even though you did not touch the fixing unit and its surroundings directly, as this may result in burns.
- If paper is jammed, remove the jammed paper so that any pieces of paper do not remain inside the machine according to the displayed message. Also, do not put your hand in an area other than indicated areas, as this may result in personal injuries or burns.
- When removing jammed paper or replacing a toner cartridge, be careful not to get any toner on your hands or clothing, as this will dirty your hands or clothing. If toner gets on your hands or clothing, wash them immediately with cold water. Washing with warm water sets the toner, making it impossible to remove the toner stains.
- When removing jammed paper, be careful not to allow the toner on the paper to scatter. The toner may get into your eyes or mouth. If toner gets into your eyes or mouth, wash them immediately with cold water and consult a physician.
- When loading paper or removing jammed documents or paper, be careful not to cut your hands with the edges of the paper.
- When removing a toner cartridge, remove the toner cartridge carefully so as to prevent the toner from scattering and getting into your eyes or mouth. If toner gets into your eyes or mouth, wash them immediately with cold water and consult a physician.
- Do not attempt to disassemble the toner cartridge. The toner may scatter and get into your eyes or mouth. If toner gets into your eyes or mouth, wash them immediately with cold water and consult a physician.
- If toner leaks from the toner cartridge, be careful not to inhale the toner or allow it to come into direct contact with your skin. If the toner comes into contact with your skin, wash with soap. If the skin becomes irritated or you inhale the toner, consult a physician immediately.

Consumables

WARNING

- Do not dispose of used toner cartridges in open flames. This may cause the toner to ignite, resulting in burns or fire.
- Do not store toner cartridges or paper in a location exposed to open flames. This may cause the toner or paper to ignite, resulting in burns or fire.
- When disposing of a toner cartridge, place the toner cartridge into a bag to prevent the toner from scattering, and then dispose of the toner cartridge according to local regulations.

CAUTION

- Keep the toner cartridges and other consumables out of the reach of small children. If the toner or other parts are ingested, consult a physician immediately.
- Do not attempt to disassemble the toner cartridge. The toner may scatter and get into your eyes or mouth. If toner gets into your eyes or mouth, wash them immediately with cold water and consult a physician.
- If toner leaks from the toner cartridge, be careful not to inhale the toner or allow it to come into direct contact with your skin. If the toner comes into contact with your skin, wash with soap. If the skin becomes irritated or you inhale the toner, consult a physician immediately.
- Do not pull out the sealing tape forcefully or stop at midpoint, as this may cause toner to spill out. If toner gets into your eyes or mouth, wash them immediately with cold water and consult a physician.

Others

WARNING

- If you are using a cardiac pacemaker
This machine generates a low level magnetic field. If you use a cardiac pacemaker and feel abnormalities, please move away from this machine and consult your physician immediately.

Telephone Equipment

When using telephone equipment, basic safety precautions should always be followed to reduce the risk of fire, electric shock, and injury to persons, including the following:

1. Do not use this machine near water (i.e., near a bathtub, kitchen sink, or laundry tub), or in a wet basement or near a swimming pool.
2. Avoid using the telephone during an electrical storm, as there may be a remote risk of electric shock from lightning.
3. Do not use the telephone to report a gas leak in the vicinity of the leak.

Installation Requirements and Handling

In order to use this machine in a safe and trouble-free manner, install the machine in a place that fulfills the following conditions. Also, read the remarks carefully.

Temperature and Humidity Conditions

- Temperature range: 50 to 86°F (10 to 30°C)
- Humidity range: 20 to 80 % RH (no condensation)

IMPORTANT

Protecting the machine from condensation

- To prevent condensation from forming inside the machine in the following cases, let the machine adjust to the ambient temperature and humidity for at least two hours before use.
 - When the room where the machine is installed is heated rapidly
 - When the machine is moved from a cool or dry location to a hot or humid location
- If water droplets (condensation) form inside the machine, this can result in paper jams or poor print quality.

When using an ultrasonic humidifier

When you are using an ultrasonic humidifier, it is therefore recommended that you use purified water or other water that is free of impurities.

If you use tap water or well water, impurities in the water will be dispersed through the air. This can be trapped inside the machine, causing degradation in print quality.

Power Supply Requirements

120 to 127 V, 60 Hz

IMPORTANT

Precautions when connecting the power cord

- Do not connect this machine to an uninterruptible power source.
- Use an AC power outlet exclusively for the machine. Do not use the other sockets of the AC power outlet.
- Do not plug the power plug into the auxiliary outlet on a computer.
Do not use the same AC power outlet for both the machine and any of the following equipment.
 - Copy machine
 - Air conditioner
 - Shredder
 - Equipment that consumes a large amount of electricity
 - Equipment that generates electrical noise
- When unplugging the power cord, keep interval of 5 seconds or more before plugging it again.

Miscellaneous precautions

- The maximum power consumption of the machine is 1,130 W or less.
- Electrical noise or a dramatic drop in supplied voltage may cause the machine or computer to operate incorrectly or lose data.

Installation Requirements

- A location with sufficient space
- A location with good ventilation
- A location with a flat, even surface
- A location able to fully support the weight of the machine

IMPORTANT

Do not install the machine in the following locations, as this may result in damage to the machine.

- A location subject to dramatic changes in temperature or humidity
- A location subject to condensation
- A poorly ventilated location
(If you use the machine for a long time or to perform a large amount of printing in a poorly ventilated room, the ozone or other odors generated by the machine may create an uncomfortable working environment. In addition, chemical particles are dispersed during printing; therefore, it is important to provide adequate ventilation.)
- A location near equipment that generates magnetic or electromagnetic waves
- A laboratory or location where chemical reactions occur
- A location exposed to salt air, corrosive gases, or toxic gases
- A location, such as on a carpet or mat, that may warp from the weight of the machine or where the machine is liable to sink.

Notes on wireless LAN

- This product is designed for indoor use 5 m or less away from an access point. Keep it at an appropriately close distance.
- Check if masking is found or not. Communications across walls or between floors are generally deteriorated. Arrange appropriate installment.
- Radio wave interference may occur if any radiowave emitting equipment (i.e. microwave) is found near the product and its radiowave is in the same frequency band as the radiowave used by a wireless LAN. Keep the product away from those radio wave interference sources as much as possible.

Installation Space

Required installation space

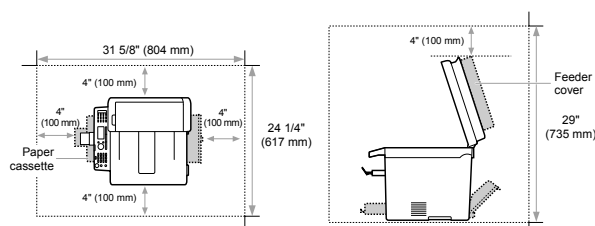

Maintenance and Inspections



IMPORTANT

- Follow the instructions in the caution label attached to this machine.
- Avoid shaking or applying a shock to this machine.
- To prevent a paper jam, do not turn the power ON/OFF, open/close the operation panel or rear cover, and load/unload paper in the middle of printing operation.
- Be sure to remove the toner cartridge from the machine when transporting the machine to a distance.
- To avoid exposing the toner cartridge to light, place it in the protective bag included with this machine or wrap it in a thick cloth.
- Clean this machine regularly. If this machine becomes dusty, it may operate improperly.
- Use a modular cable of 3 m or shorter in length.
- Depending on your locale or your telephone connection, you may be unable to perform data communication. In this case, contact your local authorized Canon dealer or the Canon help line.
- The repairing parts and toner cartridges for the machine will be available for at least seven (7) years after production of this machine model has been discontinued.

Customer Support

Customer Support (U.S.A.)

Your machine is designed with the latest technology to provide trouble-free operation. If you encounter a problem with the machine's operation, try to solve it by using the information in Chapter 9. If you cannot solve the problem or if you think your machine needs servicing, contact Canon Customer Care Center at 1-800-OK-CANON between the hours of 8:00 A.M. to 8:00 P.M. EST Monday through Friday. On-line support for 24 hours is also available at the website. <http://www.canontechsupport.com/>

Customer Support (Canada)

Canon Canada Inc., offers a full range of customer technical support options*:

- For step-by-step troubleshooting, e-mail technical support, the latest driver or document downloads, and answers to frequently asked questions, visit <http://www.canon.ca/>
- Free live technical support 9 A.M. to 8 P.M. EST Monday through Friday (excluding holidays) for products still under warranty 1-800-OK-CANON
- For the location of the authorized service facility nearest you, visit <http://www.canon.ca/> or 1-800-OK-CANON
- If the problem cannot be corrected by using one of the above technical support options, repair options are available at the time of your call to the live technical support number above or via the website at <http://www.canon.ca/>

* Support program specifics are subject to change without notice.

Legal Notices

International ENERGY STAR Program



As an ENERGY STAR® Partner, Canon U.S.A., Inc. has determined that this product meets the ENERGY STAR Program for energy efficiency. The International ENERGY STAR Office Equipment Program is an international program that promotes energy saving through the use of computers and other office equipment. The program backs the development and dissemination of products with functions that effectively reduce energy consumption. It is an open system in which business proprietors can participate voluntarily. The targeted products are office equipment, such as computers, displays, printers, facsimiles, and copiers. The standards and logos are uniform among participating nations.

IPv6 Ready Logo



The protocol stack included in this machine has obtained the IPv6 Ready Logo Phase-1 established by the IPv6 Forum.

Trademarks

Canon, the Canon logo, and imageCLASS are registered trademarks of Canon Inc. in the United States and may also be trademarks or registered trademarks in other countries. Apple, Mac OS, and Macintosh are trademarks or registered trademarks of Apple Inc. in the U.S. and/or other countries. Microsoft, Windows and Windows Vista are either trademarks or registered trademarks of Microsoft Corporation in the United States and/or other countries. All other product and brand names are registered trademarks, trademarks or service marks of their respective owners.

Copyright

© 2011 by Canon Inc. All rights reserved. No part of this publication may be reproduced, transmitted, transcribed, stored in a retrieval system, or translated into any language or computer language in any form or by any means, electronic, mechanical, magnetic, optical, chemical, manual, or otherwise, without the prior written permission of Canon Inc.

Third Party Software

This Canon product (the "PRODUCT") includes third-party software modules. Use and distribution of these software modules (the "SOFTWARE") are subject to the conditions below.

(1) You agree that you will comply with any applicable export control laws, restrictions or regulations of the countries involved in the event that this product including the SOFTWARE is shipped, transferred or exported into any country.

- (2) Rights holders of the SOFTWARE retain in all respects the title, ownership and intellectual property rights in and to the SOFTWARE. Except as expressly provided herein, no license or right, expressed or implied, is hereby conveyed or granted by rights holders of the SOFTWARE to you for any intellectual property of rights holders of the SOFTWARE.
- (3) You may use the SOFTWARE solely for use with the PRODUCT.
- (4) You may not assign, sublicense, market, distribute, or transfer the SOFTWARE to any third party without prior written consent of rights holders of the SOFTWARE.
- (5) Notwithstanding the foregoing, you may transfer the SOFTWARE only when (a) you assign to a transferee all of your rights to the PRODUCT and all rights and obligations under the conditions governing the SOFTWARE and PRODUCT and (b) such transferee agrees in writing to be bound by all these conditions.
- (6) You may not decrypt, decompile, reverse engineer, disassemble or otherwise reduce the code of the SOFTWARE to human readable form.
- (7) You may not modify, adapt, translate, rent, lease or loan the SOFTWARE or create derivative works based on the SOFTWARE.
- (8) You are not entitled to remove or make separate copies of the SOFTWARE from the PRODUCT.
- (9) The human-readable portion (the source code) of the SOFTWARE is not licensed to you.
- Notwithstanding (1) through (9) above, in case any other license conditions accompany third-party software modules, these software modules are subject to these other conditions, as well.

ACCEPTANCE

THE TERMS OF THIS THIRD PARTY SOFTWARE STATED HERE OR IN RELATED WARRANTY PROVISIONS SHALL BE DEEMED ACCEPTED UPON YOUR USE OF THE PRODUCT FOR ONE OR MORE OF ITS NORMAL PURPOSES, IF THERE HAS BEEN NO OTHER PRIOR EXPRESS ACCEPTANCE. THE TERMS OF THIS THIRD PARTY SOFTWARE GOVERN THE THIRD PARTY SOFTWARE AS DELIVERED WITH THE PRODUCT AND ALL UPDATED VERSIONS OF THE THIRD PARTY SOFTWARE PROVIDED UNDER MAINTENANCE AGREEMENTS OR OTHER SERVICE ARRANGEMENTS FOR THE PRODUCT WITH CANON USA OR CANON CANADA OR THEIR RESPECTIVE AUTHORIZED SERVICE ORGANIZATIONS.

The Software Subjected to Other Conditions

Please refer to the eManual on a CD-ROM bundled with this product, for more detail and corresponding license conditions.

Disclaimers

The information in this document is subject to change without notice.

CANON INC. MAKES NO WARRANTY OF ANY KIND WITH REGARD TO THIS MATERIAL, EITHER EXPRESS OR IMPLIED, EXCEPT AS PROVIDED HEREIN, INCLUDING WITHOUT LIMITATION, THEREOF, WARRANTIES AS TO MARKETABILITY, MERCHANTABILITY, FITNESS FOR A PARTICULAR PURPOSE OF USE OR NON-INFRINGEMENT. CANON INC. SHALL NOT BE LIABLE FOR ANY DIRECT, INCIDENTAL, OR CONSEQUENTIAL DAMAGES OF ANY NATURE, OR LOSSES OR EXPENSES RESULTING FROM THE USE OF THIS MATERIAL.

For CA, USA only

Included battery contains Perchlorate Material - special handling may apply.

See <http://www.dtsc.ca.gov/hazardouswaste/perchlorate/> for details.

Legal Limitations on the Usage of Your Product and the Use of Images

Using your product to scan, print or otherwise reproduce certain documents, and the use of such images as scanned, printed or otherwise reproduced by your product, may be prohibited by law and may result in criminal and/or civil liability.

A non-exhaustive list of these documents is set forth below. This list is intended to be a guide only. If you are uncertain about the legality of using your product to scan, print or otherwise reproduce any particular document, and/or of the use of the images scanned, printed or otherwise reproduced, you should consult in advance with your legal advisor for guidance.

- Paper Money
- Money Orders
- Certificates of Deposit
- Postage Stamps (canceled or uncanceled)
- Identifying Badges or Insignias
- Selective Service or Draft Papers
- Checks or Drafts Issued by Governmental Agencies
- Motor Vehicle Licenses and Certificates of Title
- Travelers Checks
- Food Stamps
- Passports
- Immigration Papers
- Internal Revenue Stamps (canceled or uncanceled)
- Bonds or Other Certificates of Indebtedness
- Stock Certificates
- Copyrighted Works/Works of Art without Permission of Copyright Owner

FCC (Federal Communications Commission)

imageCLASS MF4570dw: F163402

Contains Transmitter Module FCC ID: AZDFM48944

This device complies with Part 15 of the FCC Rules. Operation is subject to the following two conditions:

- (1) This device may not cause harmful interference, and
- (2) This device must accept any interference received, including interference that may cause undesired operation.

FCC WARNING

Changes or modifications not expressly approved by the party responsible for compliance could void the user's authority to operate the equipment.

- Properly shielded and grounded cables and connectors must be used for connection to host computers and/or peripherals in order to meet FCC emission limits.
- AC adaptor with ferrite core must be used for RF interference suppression.

NOTE

This equipment has been tested and found to comply with the limits for a class B digital device, pursuant to Part 15 of the FCC Rules. These limits are designed to provide reasonable protection against harmful interference in a residential installation. This equipment generates, uses and can radiate radio frequency energy and, if not installed and used in accordance with the instructions, may cause harmful interference to radio communications. However, there is no guarantee that interference will not occur in a particular installation. If this equipment does cause harmful interference to radio or television reception, which can be determined by turning the equipment off and on, the user is encouraged to try to correct the interference by one or more of the following measures:

- Reorient or relocate the receiving antenna.
- Increase the separation between the equipment and receiver.
- Connect the equipment to an outlet on a circuit different from that to which the receiver is connected.
- Consult the dealer or an experienced radio/TV technician for help.

This transmitter must not be co-located or operated in conjunction with any other antenna or transmitter. This equipment complies with FCC radiation exposure limits set forth for an uncontrolled environment and meets the FCC radio frequency (RF) Exposure Guidelines in Supplement C to OET65. This equipment should be installed and operated keeping the radiator at least 20cm or more away from person's body (excluding extremities: hands, wrists, feet and ankles). Use of shielded cable is required to comply with class B limits in Subpart B of Part 15 of the FCC Rules. Do not make any changes or modifications to the equipment unless otherwise specified in this manual. If you make such changes or modifications, you could be required to stop operation of the equipment.

Canon U.S.A., Inc.

One Canon Plaza, Lake Success, NY 11042, U.S.A.

TEL No. 1-800-OK-CANON

Users in the U.S.A.

Pre-Installation Requirements for Canon Facsimile Equipment

A. Location

Supply a suitable table, cabinet, or desk for the machine. See Chapter 11, "Appendix," for specific dimensions and weight.

B. Order Information

1. A single telephone line (touch-tone or rotary) should be used.
2. Order an RJ11-C telephone wall jack (USOC), which should be installed by the telephone company. If the RJ11-C wall jack is not present, telephone/facsimile operation is not possible.
3. Order a normal business line from your telephone

company's business representative. The line should be a regular voice grade line or an equivalent one. Use one line per unit.

DDD (Direct Distance Dial) line

-or-

IDDD (International Direct Distance Dial) line if you communicate overseas

NOTE

Canon recommends an individual line following industry standards, i.e., 2,500 (touch-tone) or 500 (rotary/pulse dial) telephones. A dedicated extension off a PBX (Private Branch eXchange) unit without "Call Waiting" can be used with your facsimile unit. Key telephone systems are not recommended because they send nonstandard signals to individual telephones for ringing and special codes, which may cause a facsimile error.

C. Power Requirements

The machine should be connected to a standard 120 volt AC, three-wire grounded outlet only.

Do not connect this machine to an outlet or power line shared with other appliances that cause "electrical noise." Air conditioners, electric typewriters, copiers, and machines of this sort generate electrical noise that often interferes with communications equipment and the sending and receiving of documents.

Connection of the Equipment

This equipment complies with Part 68 of the FCC rules and the requirements adopted by the ACTA. On the rear panel of this equipment is a label that contains, among other information, a product identifier in the format of US:AAAEQ##TXXXX. If requested, this number must be provided to the telephone company.

The REN (Ringer Equivalence Number) is used to determine the number of devices that may be connected to a telephone line. Excessive RENs on a telephone line may result in the devices not ringing in response to an incoming call. In most, but not all areas, the sum of the RENs should not exceed five (5.0).

To be certain of the number of devices that may be connected to a line, as determined by the total RENs, contact the local telephone company. The REN for this product is part of the product identifier that has the format US: AA AEQ##TXXXX. The digits represented by ## are the REN without a decimal point (e.g., 10 is a REN of 1.0).

An FCC compliant telephone line cable and modular plug is provided with this equipment. This equipment is designed to be connected to the telephone network or premise wiring using a compatible modular jack that is Part 68 compliant. This equipment may not be used on coin service provided by the telephone company. Connection to party lines is subjected to state tariffs.

In Case of Equipment Malfunction

Should any malfunction occur which cannot be corrected by the procedures described in this guide or the e-Manual, disconnect the equipment from the telephone line cable and disconnect the power cord.

The telephone line cable should not be reconnected or the power switch turned ON until the problem is completely resolved. Users should contact Canon Authorized Service Facilities for servicing of equipment. Information regarding Authorized Service Facility locations can be obtained by calling Canon Customer Care Center (1-800-OK-CANON).

Rights of the Telephone Company

If this equipment (imageCLASS MF4570dw) causes harm to the telephone network, the telephone company may temporarily disconnect service. The telephone company also retains the right to make changes in facilities and services that may affect the operation of this equipment. When such changes are necessary, the telephone company is required to give adequate prior notice to the user.

However, if advance notice is not possible, the telephone company will notify the customer as soon as possible. Also, the customer will be advised of his/her right to file a complaint with the FCC if he/she believes it is necessary.

WARNING

The Telephone Consumer Protection Act of 1991 makes it unlawful for any person to use a computer or other electronic device, including FAX machines, to send any message unless such message clearly contains in a margin at the top or bottom of each transmitted page or on the first page of the transmission, the date and time it is sent and an identification of the business or other entity, or other individual sending the message and the telephone number of the sending machine or such business, other entity, or individual.

(The telephone number provided may not be a 900 number or any other number for which charges exceed local or long-distance transmission charges.)

NOTE

In order to program this information into your machine, you should complete the procedure for registering your name, unit's telephone number, time, and date in the Starter Guide.

Users in Canada

Pre-Installation Requirements for Canon Facsimile Equipment

A. Location

Supply a suitable table, cabinet, or desk for the machine. See Chapter 11, "Appendix," for specific dimensions and weight.

B. Order Information

1. A single telephone line (touch-tone or rotary) should be used.
2. Order a CA11A modular jack, which should be installed by the telephone company. If the CA11A jack is not present, installation cannot occur.
3. Order a normal business line from your telephone company's business representative. The line should be a regular voice grade line or an equivalent one. Use one line per unit.

DDD (Direct Distance Dial) line

-or-

IDDD (International Direct Distance Dial) line if you communicate overseas

NOTE

Canon recommends an individual line following industry standards, i.e., 2,500 (touch-tone) or 500 (rotary/pulse dial) telephones. A dedicated extension off a PBX (Private Branch eXchange) unit without "Call Waiting" can be used with your facsimile unit. Key telephone systems are not recommended because they send nonstandard signals to individual telephones for ringing and special codes, which may cause a facsimile error.

C. Power Requirements

The power outlet should be a three-prong grounded receptacle (Single or Duplex). It should be independent from copiers, heaters, air conditioners, or any electric equipment that is thermostatically controlled. The rated value is 115 volts and 15 amperes. The CA11A modular jack should be relatively close to the power outlet to facilitate installation.

Notice

- This product meets the applicable Industry Canada technical specifications.
- The Ringer Equivalence Number is an indication of the maximum number of devices allowed to be connected to a telephone interface. The termination of an interface may consist of any combination of devices subject only to the requirement that the sum of the RENs of all the devices does not exceed five.
- The REN of this product is 1.0.
- Before installing this equipment, users should ensure that it is permissible to be connected to the facilities of the local telecommunications company. The equipment must also be installed using an acceptable method of connection. In some cases, the company's inside wiring associated with a single line individual service may be extended by means of a certified connector assembly (telephone extension cord). The customer should be aware that compliance with the above conditions may not prevent deterioration of service in some situations.
- Repairs to certified equipment should be made by an authorized Canadian maintenance facility designated by the supplier. Any repairs or alterations made by the user to this equipment, or equipment malfunctions, may give the telecommunications company cause to request the user to disconnect the equipment.
- Users should ensure for their own protection that the electrical ground connections of the power utility, telephone lines, and internal metallic water pipe system, if present, are connected together. This precaution may be particularly important in rural areas.

CAUTION

Users should not attempt to make such connections themselves, but should contact the appropriate electric inspection authority, or electrician, as appropriate.

NOTE

This equipment complies with the Canadian ICES-003 Class B limits.

Utilisation au Canada

Conditions à Remplir Préalablement à L'installation d'un Télécopieur Canon

A. Emplacement

Prévoir une table, un meuble, ou un bureau suffisamment solide et de taille appropriée (voir le chapitre 11, Annexe (Appendix), pour les indications de poids et dimensions).

B. Installation téléphonique

1. Une seule ligne téléphonique (tonalités ou impulsions) doit être utilisée.
2. Il faut commander un jack modulaire CA11A qui sera installé par la compagnie téléphonique. Sans ce jack, la mise en place serait impossible.
3. Si vous vous abonnez à une nouvelle ligne, demandez une ligne d'affaires normale de qualité téléphonique courante ou équivalente. Prenez un abonnement d'une ligne par appareil.

Ligne automatique interurbaine

ou

Ligne automatique internationale (si vous communiquez avec les pays étrangers)

NOTE

Canon vous conseille d'utiliser une ligne individuelle conforme aux normes industrielles, à savoir: ligne téléphonique 2,500 (pour appareil à clavier) ou 500 (pour appareil à cadran/impulsions). Il est également possible de raccorder ce télécopieur à un système téléphonique à poussoirs car la plupart de ces systèmes émettent des signaux d'appel non normalisés ou des codes spéciaux qui risquent de perturber le fonctionnement du télécopieur.

C. Condition d'alimentation

Raccordez le télécopieur à une prise de courant plus terre à trois branches, du type simple ou double, et qui ne sert pas à alimenter un copieur, un appareil de chauffage, un climatiseur ou tout autre appareil électrique à thermostat. L'alimentation doit être de 115 volts et 15 ampères. Pour faciliter l'installation, le jack CA11A doit être assez proche de la prise de courant.

Remarques

- Le présent matériel est conforme aux spécifications techniques applicables d'Industrie Canada.
- Avant d'installer cet appareil, l'utilisateur doit s'assurer qu'il est permis de le connecter à l'équipement de la compagnie de télécommunication locale et doit installer cet appareil en utilisant une méthode de connexion autorisée. Il se peut qu'il faille étendre la circuiterie intérieure de la ligne individuelle d'abonné, qui a été installée par la compagnie, au moyen d'un jeu de connecteurs homologués (rallonge téléphonique).
- L'attention de l'utilisateur est attirée sur le fait que le respect des conditions mentionnées ci-dessus ne constitue pas une garantie contre les dégradations de qualité du service dans certaines circonstances.
- L'indice d'équivalence de la sonnerie (IES) sert à indiquer le nombre maximal de terminaux qui peuvent être raccordés à une interface téléphonique. La terminaison d'une interface peut consister en une combinaison quelconque de dispositifs, à la seule condition que la somme d'indices d'équivalence de la sonnerie de tous les dispositifs n'excède pas 5.
- Le nombre d'équivalents sonnerie (REN) de ce produit est 1,0.
- Les réparations sur un appareil certifié doivent être faites par une société d'entretien canadienne autorisée par le Gouvernement canadien et désignée par le fournisseur. Toute réparation ou modification qui pourrait faire l'utilisateur de cet appareil, ou tout mauvais fonctionnement, donne à la compagnie de télécommunication le droit de débrancher l'appareil.
- Pour sa propre protection, l'utilisateur doit s'assurer que les prises de terre de l'appareil d'alimentation, les lignes téléphoniques et les tuyaux métalliques internes, s'il y en a, sont bien connectés entre eux. Cette précaution est particulièrement importante dans les zones rurales.

CAUTION

Au lieu d'essayer de faire ces branchements eux-mêmes, les utilisateurs sont invités à faire appel à un service d'inspection faisant autorité en matière d'électricité ou à un électricien, selon le cas.

NOTE

Respecte les limites de la classe B de la NMB-003 du Canada.

● Laser Safety

This machine complies with 21 CFR Chapter 1 Subchapter J as a Class 1 laser product under the U.S. Department of Health and Human Services (DHHS) Radiation Performance Standard according to the Radiation Control for Health and Safety Act of 1968. This means that the machine does not produce hazardous radiation.

Since radiation emitted inside the machine is completely confined within protective housings and external covers, the laser beam cannot escape from the machine during any phase of user operation.

CDRH Regulations

The Center for Devices and Radiological Health (CDRH) of the U.S. Food and Drug Administration implemented regulations for laser products on August 2, 1976. These regulations apply to laser products manufactured from August 1, 1976. Compliance is mandatory for products marketed in the United States.

CAUTION

Use of controls, adjustments, or performance of procedures other than those specified in this manual may result in hazardous radiation exposure.

The label is attached to the laser scanner machine inside the machine and is not in a user access area.



Before Using the Machine

This category describes the features of the machine and its useful functions.

Names and Functions on Each Part of the Machine **1-2**

Front Side	1-2
Back Side	1-3
Interior	1-3
Multi-purpose Tray	1-4
Paper Cassette	1-4
Operation Panel	1-5
LCD (Standby Mode)	1-6
Copy Mode	1-6
Fax Mode	1-6
Scan Mode	1-6

Navigating the Menu **1-7**

Entering the Menu Screen	1-7
Scrolling Through Menu Items	1-7
Selecting a Menu Item	1-7
Specifying values using the navigation keys	1-8
Returning to the Default Screen	1-8

Text Input Method **1-9**

Entering Text Except for IP Address	1-9
Changing the Entry Mode	1-9
Entering Text, Symbols, and Numbers	1-9
Moving the Cursor (Entering a Space)	1-9
Deleting text, symbols, or numbers	1-9
Entering IP Address	1-10

Setting the Sleep Timer **1-11**

Setting the Current Date and Time **1-12**

Names and Functions on Each Part of the Machine

This section describes the parts and functions of the machine.

Front Side

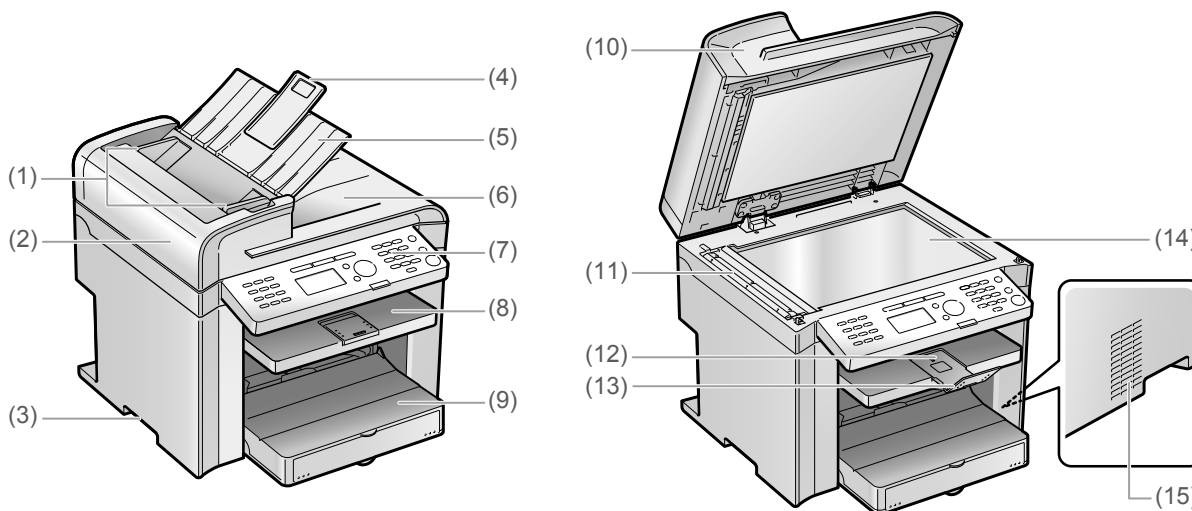

(1) Document guides

Adjust to the width of the document.

(2) Feeder cover

Open this cover to clear paper jams.

(3) Lift handles

Hold this handle to lift or transport the machine.

(4) Tray extension

Pull out the tray extension when the paper is hanging out of the document feeder tray such as Legal size paper.

(5) Document feeder tray

Place documents here.

(6) Document return tray

Documents are returned here.

(7) Operation panel

Controls the machine using this panel.

▶ "Operation Panel" (→P.1-5)

(8) Output tray

Copies, printed documents, and faxes are output here.

(9) Paper cassette

Load paper here.

▶ "Paper Cassette" (→P.1-4)

(10) Feeder

The feeder can automatically scan documents continuously.

(11) Scanning area

Scans documents from the feeder.

(12) Output tray extension

Extends the tray for large paper sizes.

(13) Paper stopper

Prevents paper from falling from the output tray.

(14) Platen glass

Place a document here.

(15) Ventilation slots

Allows inside of the machine to cool down.

Leave enough space around the machine to allow heat to escape sufficiently.

Back Side

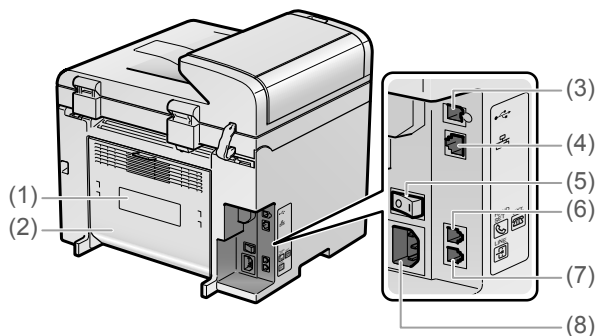

(1) Rating label

The average values of the required voltage and current are specified.

(2) Rear cover

Open this cover to clear paper jams.

(3) USB port

Connect to a computer via a USB cable.

(4) LAN port

Connect to a network via a LAN cable.

(5) Power switch

Turn the power ON or OFF.

(6) External device jack

Connect an external telephone.

(7) Telephone line jack

Connect a telephone line.

(8) Power socket

Connect the power cord.

Interior

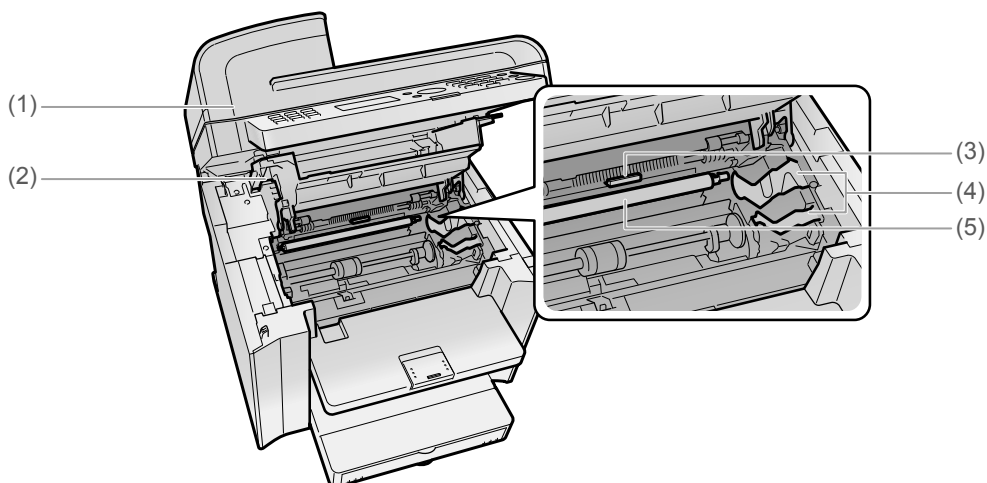

(1) Scanning platform

Open this platform to replace the toner cartridge or clear paper jams.

(2) Toner cover

Open this cover to replace the toner cartridge or clear paper jams.

(3) Paper exit guide

Open this guide to clear paper jams.

(4) Toner guides

When inserting the toner cartridge, fit the protrusions on the toner cartridge into these guides.

(5) Transfer roller

Transfers toner onto paper.

Multi-purpose Tray

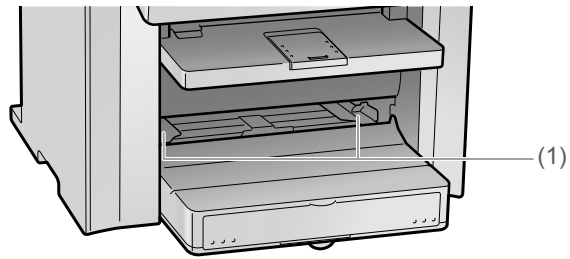

- (1) **Paper guides**
Adjust to the width of the paper.

Paper Cassette

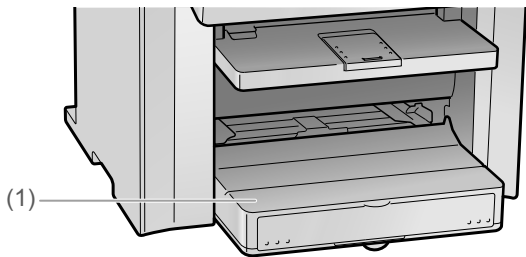

- (1) **Dust cover**
Protects paper in the paper cassette from dirt and dust.

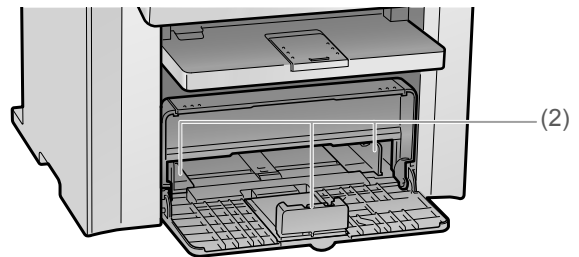

- (2) **Paper guides**
Adjust the paper guides to the width and length of the paper.

Operation Panel

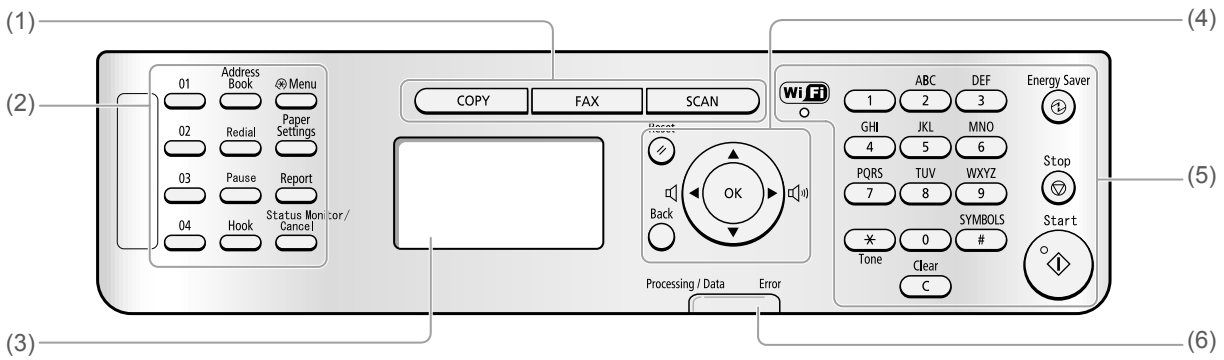

(1)	Mode switching keys	Press to switch the mode to copy, fax, or scan.
(2)	[One-touch Speed Dial] keys ([01]/[02]/[03]/[04] keys)	Press to specify recipients registered under one-touch keys.
	[Address Book] key	Press to search recipients registered under one-touch keys or coded dial codes.
	[Redial] key	When faxing, press to redial the last number.
	[Pause] key	When entering a fax number, press to insert a pause.
	[Hook] key	Press to dial a number without lifting the telephone handset.
	[Menu] key	Press to specify or register various settings.
	[Paper Settings] key	Press to specify paper size and type for the paper cassette or multi-purpose tray.
	[Report] key	Press to manually print reports and lists. You can also specify whether to print a report automatically.
(3)	[Status Monitor/Cancel] key	Press to view or cancel jobs. You can also check the status of the network and machine.
	LCD	During normal operation, displays messages and prompts. When adjusting the settings, displays your selections, text, and numbers.
(4)	[Reset] key	Press to reset the settings. (Press to reset the copy/scan/fax mode to the standard mode.)
	[Back] key	Press to return to the previous screen.
	[▲] key	Press to scroll up or to increase a value.
	[▼] key	Press to scroll down or to decrease a value.
	[◀] key	Press to return to the previous screen or move the cursor to the left. While fax communication sound is ringing, press to decrease the volume.
	[▶] key	Press to proceed to the next screen or move the cursor to the right. While fax communication sound is ringing, press to increase the volume.
	[OK] key	Press to confirm an action or setting.
(5)	[Wi-Fi] indicator	Turns on when the machine is connected to Wireless LAN.
	Numeric keys ([0]-[9] keys)	Enter letters and numbers.
	[*] key	Press to switch the character entry mode. When sending a fax, press to switch between pulse and tone dialing.
	[#] key	Press to enter symbols.
	[Clear] key	Deletes letters and numbers.
	[Energy Saver] key	Press to manually set or cancel the Sleep mode. The Energy Saver light will be green when in Sleep mode.
	[Stop] key	Press to cancel jobs.
	[Start] key	Press to start copying, scanning, or sending a fax.
(6)	[Processing/Data] indicator	The indicator blinks while sending or receiving faxes and remains lit when jobs are waiting in memory.
	[Error] indicator	The indicator blinks when an error occurs.

LCD (Standby Mode)

This section describes the following screens.

- Copy Mode
- Fax Mode
- Scan Mode



NOTE

Display of the standby mode

- You can change the standby display which appears when the power switch is turned ON.
 - ☞ e-Manual → Basic Operation → Customizing Display Settings → Setting the Default Screen
- When the machine is idle for 2 minutes, the display returns to standby mode.
 - ☞ e-Manual → Basic Operation → Customizing Timer Settings → Specifying the Auto Reset Timer

Copy Mode

When using the copy function, press [**COPY**] to switch to the standby display.

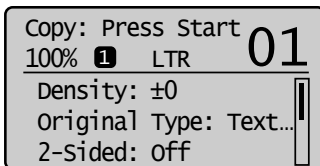

When the copy mode screen is displayed, you can select items by pressing [▲] or [▼]. The currently selected item will be highlighted with a black background, and pressing [OK] will advance to the next screen.

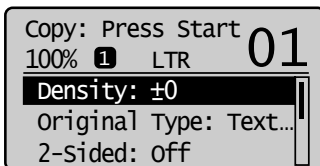

Fax Mode

When using the fax function, press [**FAX**] to switch to the standby display.

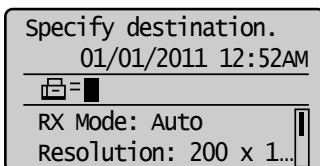

When the fax mode screen is displayed, you can select items by pressing [▲] or [▼]. The currently selected item will be highlighted with a black background, and pressing [OK] will advance to the next screen.

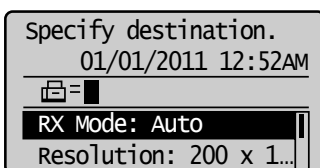

Scan Mode

When using the scan function, press [**SCAN**] to switch to the standby display.

When the scan mode screen is displayed, you can select items by pressing [▲] or [▼].

The currently selected item will be highlighted with a black background, and pressing [OK] will advance to the next screen.

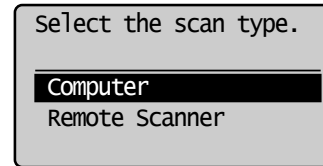

Navigating the Menu

This section describes how to navigate the menu and specify values on the menu screen.

Keys to be used for this operation

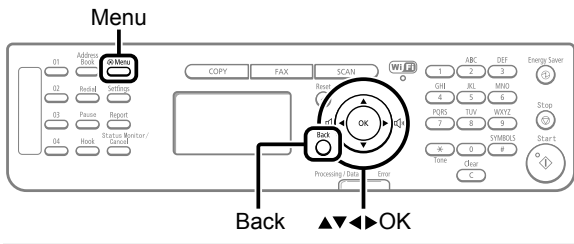

Entering the Menu Screen

Press [] (Menu) to enter the menu screen.

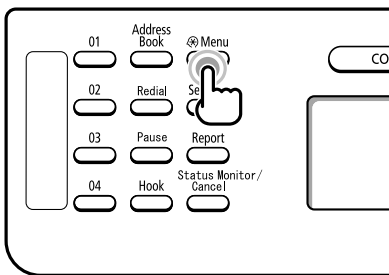

Scrolling Through Menu Items

The scroll bar at the right side of the screen indicates that more items are available.

To select an item that is not shown on the screen, press [▲] or [▼] to scroll through menu items.

The currently selected item is highlighted with a black background.

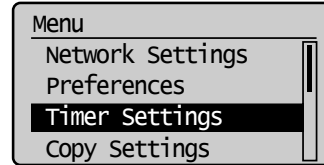

Selecting a Menu Item

Press [OK] to select a highlighted menu.

If there are submenus available, you can also press [▶] to select the item and proceed to the next screen.

You can return to the previous screen by pressing [○] (Back) or [◀].

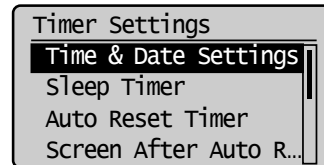
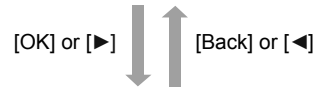
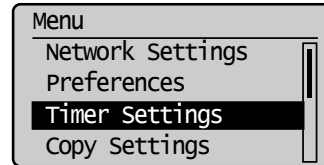

Specifying values using the navigation keys

Specifying values

Situation	Screen example	Procedure
When moving through the bars to adjust levels such as density		Press [◀] or [▶] to adjust the level.
When selecting a value to set a timer		Press [▲] or [▼] to specify the value. NOTE Available values You can specify any value shown in the parentheses at the bottom of the screen. When the numeric key icon is displayed on the screen You can also enter values with the numeric keys. <input type="checkbox"/> "Text Input Method" (→P.1-9)
When entering a series of numbers or letters such as PIN		Press [◀], [▶], [▲], or [▼] to select a number or character, and then press [OK] to enter the number or character. To clear a number or character, select <BS>, and then press [OK]. NOTE You can also use the numeric keys You can also enter values with the numeric keys. <input type="checkbox"/> "Text Input Method" (→P.1-9)

Confirming the input

To confirm the input:

- Press [OK].
- When <Apply> appears on the display, press [▲] or [▼] to select <Apply>, and then press [OK].

Returning to the Default Screen

From the menu screen, press [] (Menu) to exit the menu screen and return to the default screen.

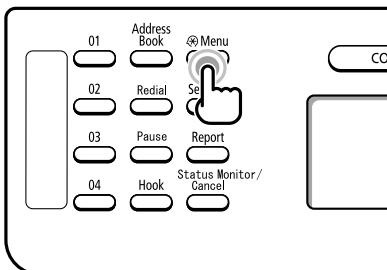

NOTE

If you press [] (Menu) before you press [OK]

The specified settings will not be saved.

Text Input Method

- * When entering the followings, see "Entering IP Address."
 - IP address
 - Subnet mask
 - Gateway address
 - DNS server address

Entering Text Except for IP Address

Enter information (text, symbols, and numbers) into the machine using the following keys.

Keys to be used for this operation

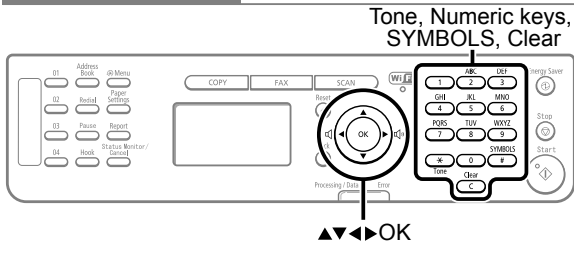

Changing the Entry Mode

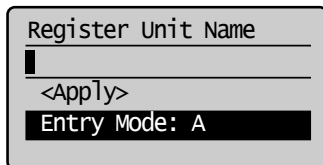

Press [▼] to select <Entry Mode>, and then press [OK]. You can also press [Ⓢ] (Tone) to change the entry mode.

Entry mode	Available text
<A>	Alphabet (capital letters) and symbols
<a>	Alphabet (small letters) and symbols
<12>	Numbers

Entering Text, Symbols, and Numbers

Enter with the numeric keys or [Ⓢ] (Symbols)

Keys used	Entry mode: <A>	Entry mode: <a>	Entry mode: <12>
1	@ . - _ /		1
2	ABC	abc	2
3	DEF	def	3
4	GHI	ghi	4
5	JKL	jkl	5
6	MNO	mno	6
7	PQRS	pqrs	7
8	TUV	tuv	8
9	WXYZ	wxyz	9
0	(Not available)		0
Ⓢ	- . * # ! " , ; : ^ ` _ = / ' ? \$ @ % & + \ () [] { } < >		(Not available)

Moving the Cursor (Entering a Space)

Move the cursor by pressing [◀] or [▶].
To enter a space, move the cursor to the end of the text and press [▶].

Deleting text, symbols, or numbers

To delete text, numbers, or symbols, press [C] (Clear).
To delete all text, numbers, or symbols, press and hold [C] (Clear).

Example: Enter <CANON>.

- 1 Ensure that the input mode is <A>.
- 2 Press [2] until the letter "C" appears on the display.

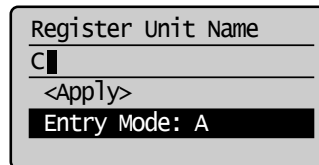

- 3 Press [2] until the letter "A" appears on the display.

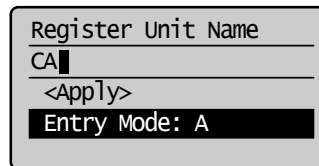

- 4 Press [6] until the letter "N" appears on the display.

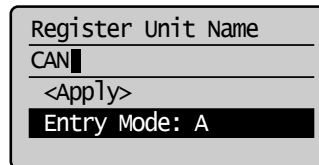

- 5 Press [6] until the letter "O" appears on the display.

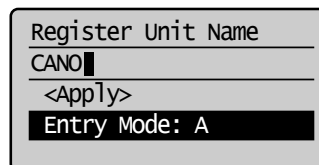

- 6** Press [**6**] until the letter “N” appears on the display.

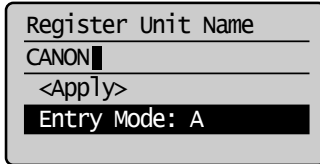

- 7** Press [**▲**] or [**▼**] to select <Apply>, and then press [**OK**].

The entry is applied.

Entering IP Address

Enter numbers using the following keys.

Keys to be used for this operation

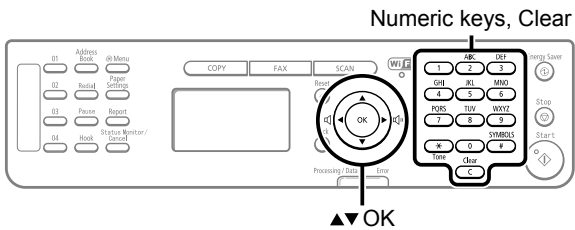

- 1** Use the numeric keys to enter numbers.

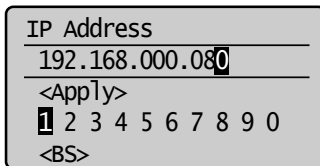

- * Enter numbers by three digits.
To specify “192.168.0.80,” enter “192.168.000.080.”
(If the number is less than three digits, add “0” before the number.)

Deleting numbers

- To delete a number, press [**C**] (Clear).
To delete all numbers, press and hold [**C**] (Clear).

- 2** When you are finished entering, press [**▲**] or [**▼**] to select <Apply>, and then press [**OK**].

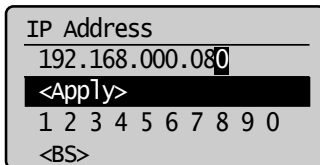

Setting the Sleep Timer

The machine returns to sleep mode automatically when it is idle for a specified length of time.

Keys to be used for this operation

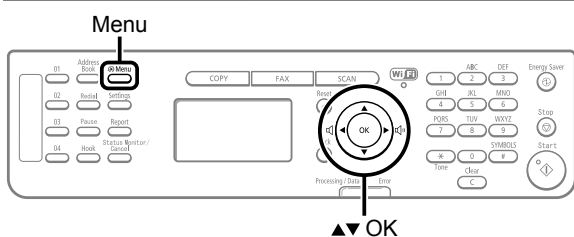

- 1 Press [] (Menu).
- 2 Press [▲] or [▼] to select <Timer Settings>, and then press [OK].

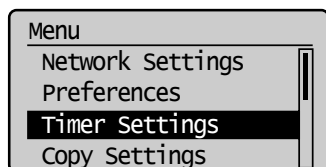

- 3 Press [▲] or [▼] to select <Sleep Timer>, and then press [OK].

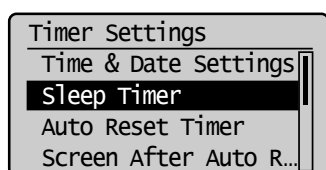

- 4 Press [▲] or [▼] to specify the time, and then press [OK].

You can also enter values using the numeric keys.

* We recommend that you use this option in the default setting.

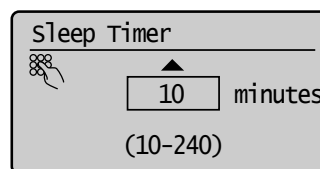

NOTE

Specifying the auto sleep timer

You may specify the auto sleep timer between <10> minutes and <240> minutes, in one minute interval. The default value for this setting is <10> minutes.

- 5 Press [] (Menu) to close the menu screen.



NOTE

When entering sleep mode

[] (Energy Saver) will be lit green.

To enter sleep mode manually

Press [] (Energy Saver).

* The machine does not enter the sleep mode, if you press

[] (Energy Saver) in 10 seconds after the machine resumes from the sleep mode.

The machine will not enter sleep mode when

- the machine is in operation
- the Processing/Data indicator is lit or blinking
- a message appears on the display and the Error indicator blinks (except when <Prepare toner cartridge.> is displayed)
- the machine is performing adjustment or cleaning
- there is a paper jam
- the handset of the external telephone is off the hook
- documents are set in the feeder
- The menu screen is displayed

The machine will wake from sleep mode when

- you press [] (Energy Saver)
- receiving a fax or phone call
- the external telephone is off the hook
- a print job from a computer begins
- documents are set in the feeder
- the machine is connected to a computer via a USB cable

Setting the Current Date and Time

Specify a display format for the date and time and set the current date and time.
The specified date and time are used for some fax functions and reports.

Keys to be used for this operation

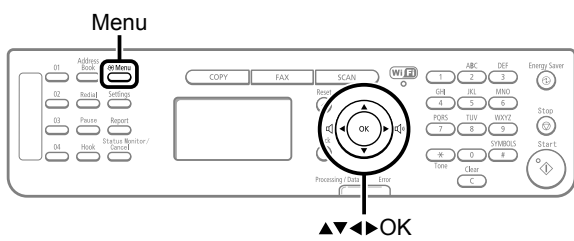

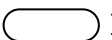
- 1 Press [] (Menu).
- 2 Press [▲] or [▼] to select <Timer Settings>, and then press [OK].

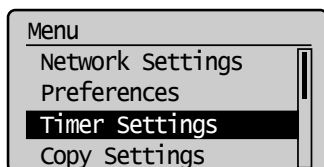

- 3 Press [▲] or [▼] to select <Time & Date Settings>, and then press [OK].

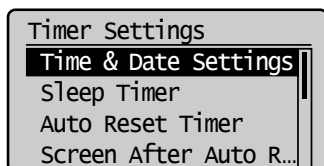

- 4 Press [▲] or [▼] to select a setting item, and then press [OK].

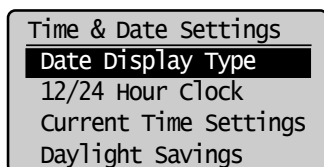

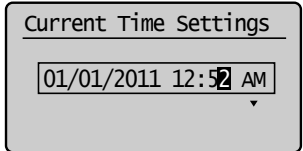
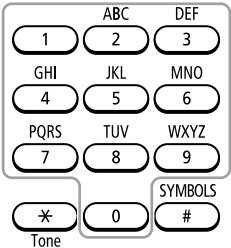
Settings	Overview	Operation
<Date Display Type>	Specifies the display format for dates.	Press [▲] or [▼] to select one of following display formats, and then press [OK]. You can select a display format from the following three options. • MM/DD/YYYY • DD/MM/YYYY • YYYY MM/DD
<12/24 Hour Clock>	Specifies the display format for time.	Press [▲] or [▼] to select a display format, and then press [OK]. You can select a display format from the following two options. • 12 Hour (AM/PM) • 24 Hour
<Current Time Settings>	Specifies the current time and date.	Use the numeric keys to enter the date and time, and then press [OK]. You can also enter the date and time by pressing [◀] or [▶] to move the cursor, and then pressing [▲] or [▼] to select a number. Press [▲] or [▼] to switch between <AM> and <PM>. 
<Daylight Savings>	Specifies the daylight savings time.	To use daylight savings time, 1. Press [▲] or [▼] to select <On>, and then press [OK]. 2. Specify the starting date of the daylight savings time. - Press [▲] or [▼] to select <Month>, and then press [OK]. - Select the starting month, and then press [OK]. - Press [▲] or [▼] to select <Day>, and then press [OK]. - Select the starting week, and then press [OK]. - Select the starting day, and then press [OK]. - Press [▲] or [▼] to select <Apply>, and then press [OK]. 3. Repeat step 2 to specify the ending date. 

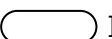
- 5 Press [] (Menu) to close the menu screen.

Document and Paper Handling

Document Requirements	2-2
Scanning Range	2-2
Copy	2-2
FAX	2-3
Scan	2-3
Placing Documents	2-4
Placing Documents on the Platen Glass	2-4
Loading Document in the Feeder	2-4
Paper Requirements	2-6
Paper Size	2-6
Paper Type	2-7
Printable Range	2-8
Loading Paper	2-9
In the Paper Cassette	2-9
In the Multi-Purpose Tray	2-11
Precautions when Loading Paper	2-12
Paper Loading Capacity	2-12
Paper Loading Orientation	2-13
When printing paper with a letterhead or logo (previously printed paper)	2-13
Printing on Envelopes	2-13
Setting a Paper Size and Type	2-14
Setting a Custom Paper Size	2-14
Selecting Print Side	2-16
When setting this item to <Print Speed Priority> (the default setting)	2-16
When setting this item to <Print Side Priority>	2-16

Document Requirements

	Platen glass	Feeder
Document type	<ul style="list-style-type: none"> • Plain paper • Heavy paper • Photograph • Small documents (e.g., index cards) • Special types of paper (e.g., tracing paper, transparencies, etc.) ^{*1} • Booklet (Up to 3/4" (20 mm) thickness) 	Plain paper (Multi-page documents of the same size, thickness and weight/one page documents)
Size (W x L)	Maximum 8 1/2" x 11 3/4" (215.9 mm x 297 mm)	Maximum 8 1/2" x 14" (216 mm x 356 mm) Minimum 5 7/8" x 4 1/8" (148 mm x 105 mm)
Weight	Maximum 4.4 lb (2 kg)	13.3 to 27.9 lb Bond (50 to 105 g/m ²)
Paper Capacity	1 sheet	Maximum 35 sheets ^{*2}

^{*1} When copying transparent documents such as tracing paper or transparencies, use a piece of plain white paper to cover the document after placing it face-down on the platen glass.

^{*2} 21 lb Bond (80 g/m²) paper



IMPORTANT

When placing document

Place the document after glue, ink or correction fluid on the document is completely dry.

To prevent paper jams in the feeder

Do not use any of the following.

- Wrinkled or creased paper
- Carbon paper or carbon-backed paper
- Curled or rolled paper
- Coated paper
- Torn paper
- Onion skin or thin paper
- Documents with staples or paper clips attached
- Paper printed with a thermal transfer printer
- Transparency

Scanning Range

Ensure your document's text and graphics fall within the area specified in the following diagram.

* Note that the margin widths listed below are rough standards and there may be slight variations in actual use.

* The loading orientation of documents is as follows.

- Platen glass: With the document facing down
- Feeder: With the document loaded in the document feeder tray

Copy

Platen Glass	Feeder

FAX

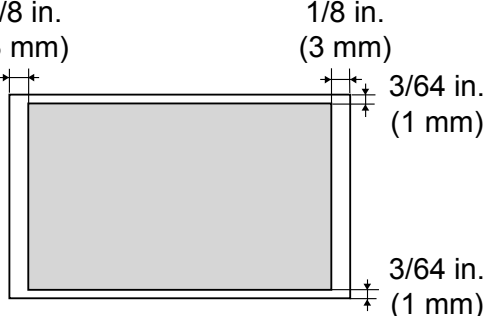
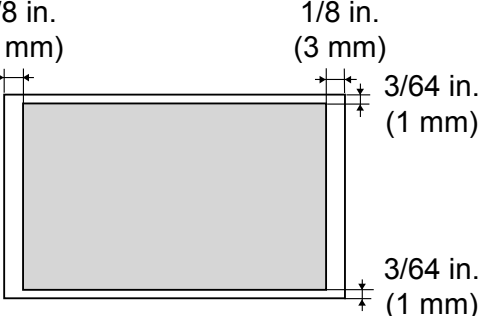
Platen Glass	Feeder
 <p>1/8 in. (3 mm) 1/8 in. (3 mm)</p> <p>3/64 in. (1 mm)</p> <p>3/64 in. (1 mm)</p> <p>The diagram shows a rectangular document area with a gray fill. Dimension lines indicate a top margin of 1/8 in. (3 mm) and a right margin of 1/8 in. (3 mm). On the right side, there are two vertical dimension lines: the outer one is labeled 3/64 in. (1 mm) and the inner one is also labeled 3/64 in. (1 mm).</p>	 <p>1/8 in. (3 mm) 1/8 in. (3 mm)</p> <p>3/64 in. (1 mm)</p> <p>3/64 in. (1 mm)</p> <p>The diagram shows a rectangular document area with a gray fill. Dimension lines indicate a top margin of 1/8 in. (3 mm) and a right margin of 1/8 in. (3 mm). On the right side, there are two vertical dimension lines: the outer one is labeled 3/64 in. (1 mm) and the inner one is also labeled 3/64 in. (1 mm).</p>

Scan

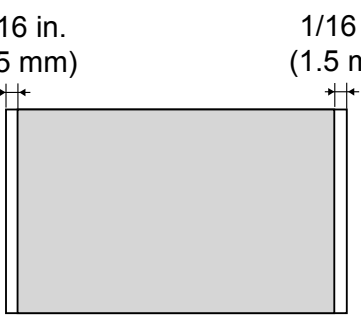
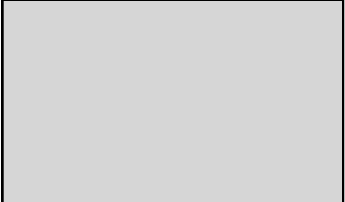
Platen Glass	Feeder
 <p>1/16 in. (1.5 mm) 1/16 in. (1.5 mm)</p> <p>The diagram shows a rectangular document area with a gray fill. Dimension lines indicate a top margin of 1/16 in. (1.5 mm) and a right margin of 1/16 in. (1.5 mm).</p>	 <p>* The whole document can be scanned without any margins.</p> <p>The diagram shows a rectangular document area with a gray fill. Below the diagram is a note: "* The whole document can be scanned without any margins."</p>

Placing Documents

This section describes placing the documents on the platen glass or loading them in the feeder.

Placing Documents on the Platen Glass

- 1 Open the feeder.

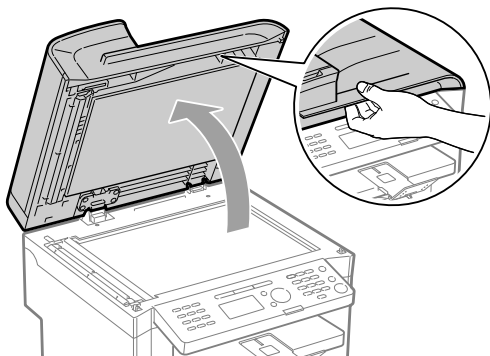

- 2 Place a document face down.

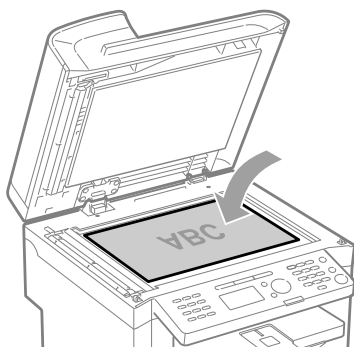

- 3 Align the document with the appropriate paper size marks.

If your document does not match any of the paper size marks, align the center of your document with the arrow mark.

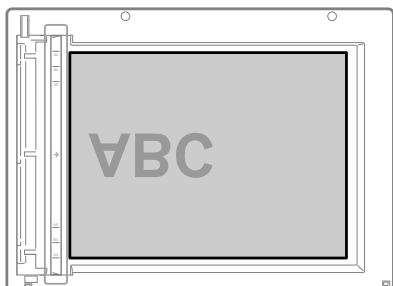

- 4 Close the feeder gently.

The machine is ready to scan the document.

When scanning is complete, remove the document from the platen glass.

CAUTION

Precautions when closing the feeder

- Be careful not to get your fingers caught. This may cause personal injury.
- Do not press down the feeder forcefully. This may damage the platen glass and cause personal injury.

Loading Document in the Feeder

- 1 Open the document feeder.

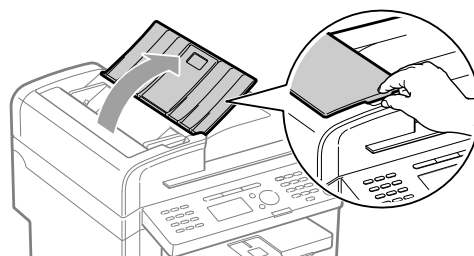

- 2 Spread the document guides a little wider than the document width.

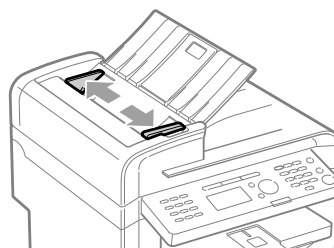

- 3 If loading large-sized documents, pull out the tray extension.

Pull out the tray extension when the document is hanging out of the document feeder tray.

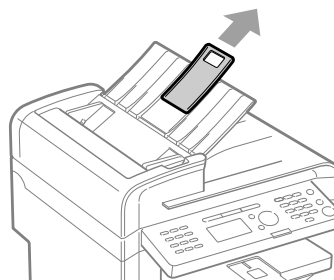

4 Fan the document stack and align the edges of the pages.

Thoroughly fan in small batches

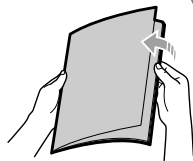

Align the edges on a flat surface a few times

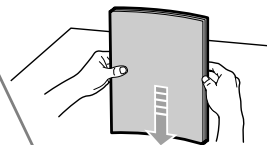

5 Neatly place the documents face up.

- Load the document under the load limit guides (A).
- Ensure that the paper stack does not exceed the load limit marks (B).

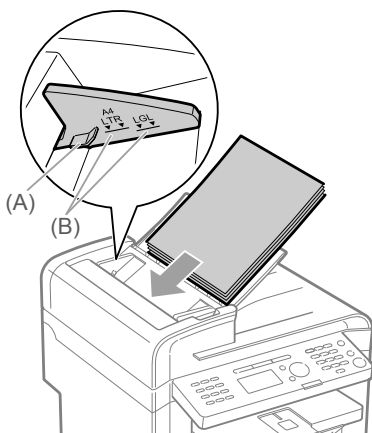

6 Align the document guides to fit the width of the document.

The machine is ready to scan the document.

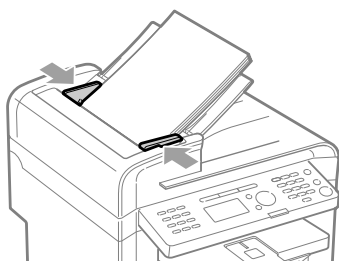

IMPORTANT

Up to 35 documents can be loaded

If more than 35 documents are loaded, paper jams may occur, or the documents may not be scanned.

While scanning a document

Do not add or remove documents.

When scanning documents is complete

Remove the documents from the document delivery tray to avoid paper jams.

Avoid scanning the same document more than 30 times.

When scanned repeatedly, documents can become folded or torn, which may cause paper jams.

Be sure to align the document guides with the width of the paper

- If the document guides are too loose or too tight, this may result in misfeeds or paper jams.
- Printouts may be askew depending on the printing environment. Properly load paper to reduce the symptom.

Paper Requirements

Paper Size

The available paper sizes are as follows.

○ : Available — : Not available

Paper size	Paper source	
	Paper cassette	Multi-purpose tray
A4 (8 1/4" x 11 3/4" (210 mm x 297 mm)) ^{*1 *2 *3}	○	○
B5 (7 1/8" x 10 1/8" (182 mm x 257 mm)) ^{*2}	○	○
A5 (5 7/8" x 8 1/4" (148 mm x 210 mm)) ^{*2}	○	○
Legal (8 1/2" x 14" (216 mm x 356 mm)) ^{*1 *2}	○	○
Letter (8 1/2" x 11" (216 mm x 279 mm)) ^{*1 *2 *3}	○	○
Statement (5 1/2" x 8 1/2" (140 mm x 216 mm)) ^{*2}	○	○
Executive (7 1/4" x 10 1/2" (184 mm x 267 mm)) ^{*2}	○	○
Officio (8 1/2" x 12 1/2" (216 mm x 318 mm)) ^{*1}	○	○
B-officio (8 1/2" x 14" (216 mm x 355 mm)) ^{*1}	○	○
M-officio (8 1/2" x 13 3/8" (216 mm x 341 mm)) ^{*1}	○	○
Government - Letter (8" x 10 1/2" (203 mm x 267 mm))	○	○
Government - Legal (8" x 13" (203 mm x 330 mm))	○	○
Foolscap (8 1/2" x 13" (216 mm x 330 mm)) ^{*1}	○	○
A-foolscap (8 1/8" x 13 3/8" (206 mm x 338 mm))	○	○
Envelope COM10 (4 1/8" x 9 1/2" (104.7 mm x 241.3 mm)) ^{*4}	○	○
Envelope Monarch (3 7/8" x 7 1/2" (98.4 mm x 190.5 mm)) ^{*4}	—	○
Envelope C5 (6 3/8" x 9" (162 mm x 229 mm)) ^{*4}	○	○
Envelope B5 (6 7/8" x 9 7/8" (176 mm x 250 mm)) ^{*4}	○	○
Envelope DL (4 3/8" x 8 5/8" (110 mm x 220 mm)) ^{*4}	○	○
Index Card (3" x 5" (76 mm x 127 mm))	—	○
Custom Paper Size	○ ^{*5}	○ ^{*6}

^{*1} Auto 2-sided print is available.

^{*2} Received documents can be printed.

^{*3} Reports or lists can be printed.

^{*4} Use envelopes with the flap closed.

^{*5} You can load paper of the following custom paper sizes.

* Width 3" to 8 1/2" (76.2 to 216 mm); Length 8 1/4" to 14" (210 to 356 mm)

^{*6} You can load paper of the following custom paper sizes.

* Width 3" to 8 1/2" (76.2 to 216 mm); Length 5" to 14" (127 to 356 mm)



NOTE

Default paper size

The default paper size is Letter. If you use a different paper size, change the paper size settings.

"Setting a Paper Size and Type" (→P.2-14)

Paper Type

The available paper types are as follows.

Paper Type		Printer Driver Setting	Paper Source	
			Paper Capacity (Paper Cassette)	Paper Capacity (Multi-purpose Tray)
Plain paper ^{*1}	16 to 24 lb Bond (60 to 90 g/m ²)	[Plain Paper] [Plain Paper L] ^{*2}	250 sheets	1 sheet
Heavy paper	24 to 32 lb Bond (90 to 120 g/m ²)	[Heavy Paper 1]	170 sheets	1 sheet
	45 to 60 lb Cover (120 to 163 g/m ²)	[Heavy Paper 2]	100 sheets	1 sheet
Rough paper	45 to 60 lb Bond (120 to 163 g/m ²)	[Rough Paper 3]	100 sheets	1 sheet
Recycled paper ^{*1}	16 to 24 lb Bond (60 to 90 g/m ²)	[Recycled Paper]	250 sheets	1 sheet
Color paper ^{*1}	16 to 24 lb Bond (60 to 90 g/m ²)	[Color Paper]	250 sheets	1 sheet
Transparency ^{*3}		[Transparency]	50 sheets	1 sheet
Label		[Labels]	100 sheets	1 sheet
Index Card		[Index Card]	Not available	1 sheet
Envelope ^{*4}		[Envelope]	20 envelopes	1 envelope

^{*1} Auto 2-sided print is available.

^{*2} If printed paper curls when [Plain Paper] is selected, set paper type to [Plain Paper L]. However, the toner fixation may be not as good when [Plain Paper L] is set.

^{*3} Use only the transparencies designed for laser printers.

^{*4} You can set Envelope Monarch only in the multi-purpose tray.

To prevent paper jams, do not use the following types of paper.

- Wrinkled or creased paper
- Curled or rolled paper
- Torn paper
- Damp paper
- Very thin paper
- Paper printed with a thermal transfer printer (Do not copy on the reverse side.)

The following types of paper do not print well:

- Highly textured paper
- Very smooth paper
- Glossy paper

Make sure the paper is free from dust, lint, and oil stains.

Make sure to test paper before purchasing large quantities.

Store all paper wrapped and on a flat surface until ready

for use. Keep opened packs in their original packaging in a cool, dry location.

Store paper at 64.4 to 75.2°F (18 to 24°C), 40 % to 60 % RH.

CAUTION

If you print on damp paper

The following problems may occur.

- Steam is emitted from the printer output area.
- Water droplets form on the back side of the operation panel and in the output area.

Because moisture in the paper is evaporating due to the heat generated when toner fixes, this is not a malfunction. (This is likely to occur when the room temperature is low.)

If you smell a burnt odor, however, immediately turn OFF the machine, unplug the power plug from the AC power outlet, and then contact your local authorized Canon dealer or the Canon help line. Continued use can result in a fire or electrical shock.



Printable Range

The shaded area indicates the approximate printable area of A4 paper. Note that the margin widths listed below are rough standards and there may be slight variations in actual use.

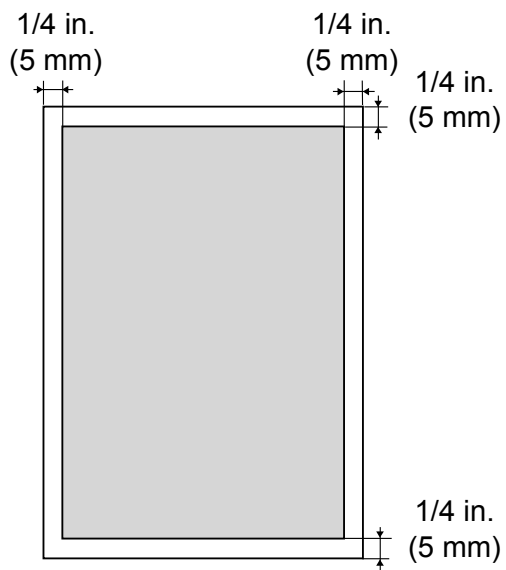

Loading Paper

This section describes how to load paper in the paper cassette and the multi-purpose tray.

NOTE -----

If you use paper of a different size or type

The default paper size/type is set to <Letter> and <Plain (16 lb Bond-24 lb Bond)> in the setting menu. If you use a different paper size or paper type, you need to change the paper settings.

▶ "Setting a Paper Size and Type" (→P.2-14)

In the Paper Cassette

Before loading paper in the paper cassette, see "Precautions when Loading Paper" (→P.2-12).

1 Lift the dust cover.

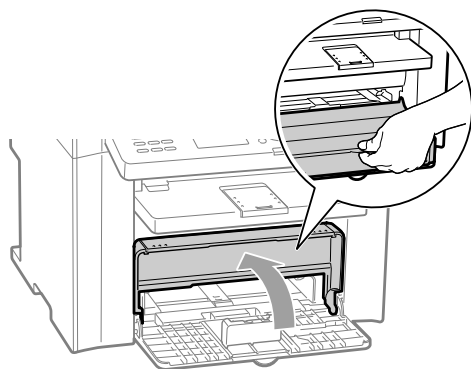

2 Spread the paper guides a little wider than the paper size.

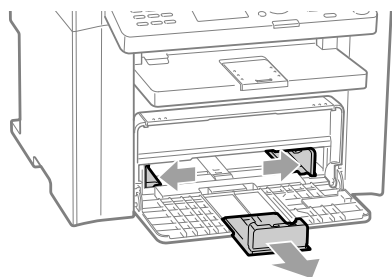

* If you want to change the size of the paper to be loaded, be sure to register the paper size in "Setting a Paper Size and Type" (→P.2-14).

3 Gently load the paper into the paper cassette with the print side face up, until the edge of the paper stack meets the back of the paper cassette.

- ▶ "Paper Loading Capacity" (→P.2-12)
- ▶ "Paper Loading Orientation" (→P.2-13)

Ensure that the paper stack does not exceed the load limit guides (A).

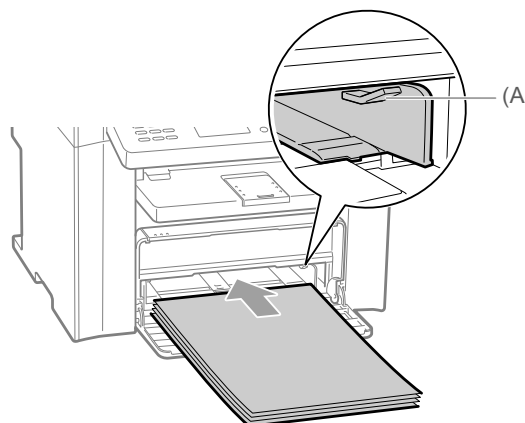

When loading envelopes

- (1) Close the envelope flap.

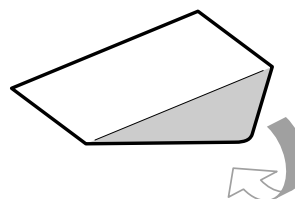

- (2) Place the stack of envelopes on a flat surface, flatten them to release any remaining air, and ensure that the edges are pressed tightly.

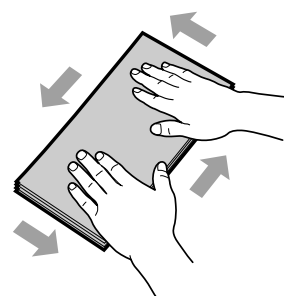

- (3) Loosen any stiff corners of the envelopes and flatten curls as shown in the figure.

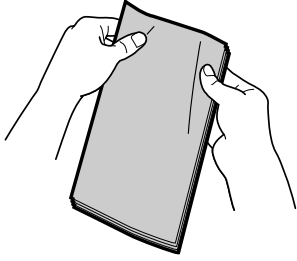

- (4) Align the edges of the envelopes on a flat surface.

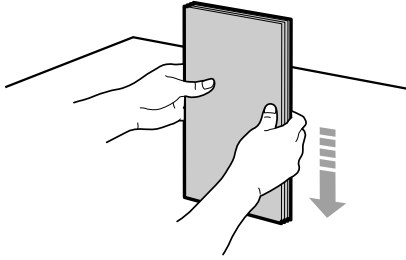

- (5) Gently load the envelopes into the paper cassette with the print side face up, until the edge of the envelope stack meets the back of the paper cassette.

4 Adjust the paper guides tightly to the width of the paper.

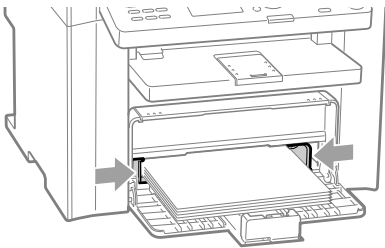

5 Adjust the paper guide tightly to the length of the paper.

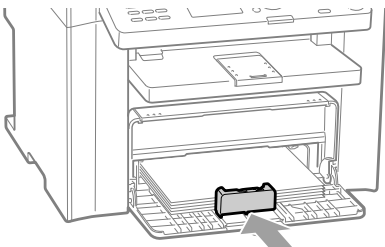

IMPORTANT

Adjust the paper guides to the paper width without space.

If the paper guides are loose or tight, this may result in misfeeds or paper jams.



6 Close the dust cover.

When loading paper that is longer than the length of the paper cassette

Lift the dust cover extension.

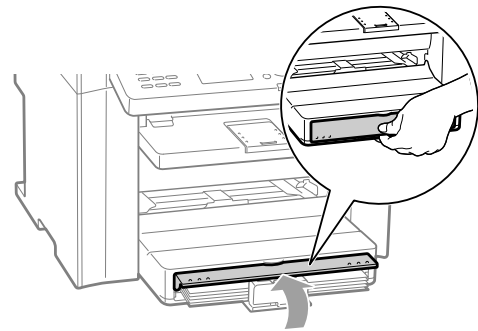

7 Pull out the output tray extension, and then lift the paper stopper.

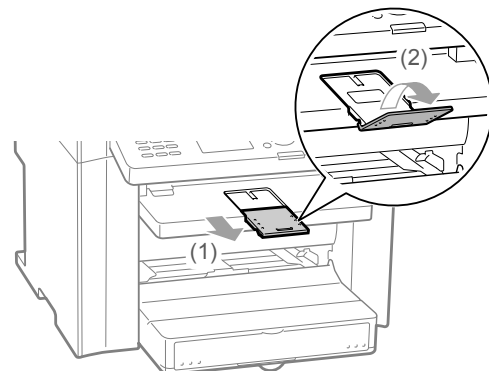

8 Specify the loaded paper size and type.

▶ "Setting a Paper Size and Type" (→P.2-14)

In the Multi-Purpose Tray

Before loading paper in the multi-purpose tray, see "Precautions when Loading Paper" (→P.2-12).

Use the multi-purpose tray when you want to copy or print on a paper that is different from what is in the paper cassette. You can load a single sheet of paper in the multi-purpose tray.

- 1 Spread the paper guides a little wider than the paper.

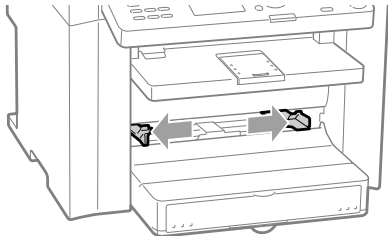

- 2 Gently insert the paper into the multi-purpose tray with the print side face up.

▶ "Paper Loading Capacity" (→P.2-12)

▶ "Paper Loading Orientation" (→P.2-13)

Ensure that the paper stack does not exceed the load limit guides (A).

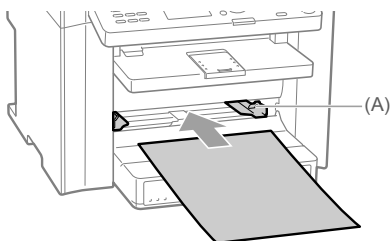

When loading envelopes

- (1) Close the envelope flap.

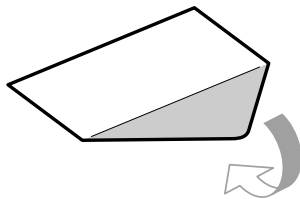

- (2) Loosen any stiff corners of the envelope and flatten curls as shown in the figure.

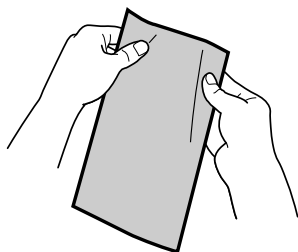

- (3) Gently insert the envelope into the multi-purpose tray with the print side face up.

- 3 Adjust the paper guides tightly to the width of the paper.

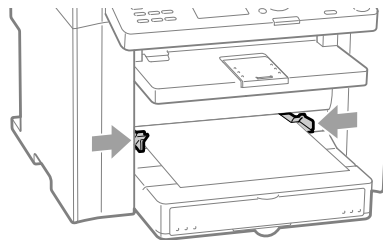

IMPORTANT

Adjust the paper guides to the paper width without space.

If the paper guides are loose or tight, this may result in misfeeds or paper jams.



- 4 Pull out the output tray extension, and then lift the paper stopper.

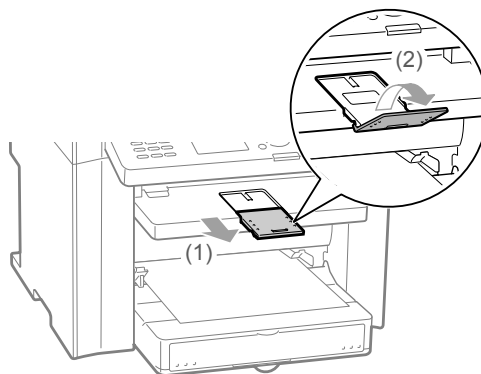

- 5 Specify the loaded paper size and type.

▶ "Setting a Paper Size and Type" (→P.2-14)

Precautions when Loading Paper

CAUTION

Be careful when handling paper

Handle paper carefully not to cut your hands with the edges of the paper.

Precautions when inserting the paper cassette

Be careful not to catch your fingers.

IMPORTANT

Adjust the paper guides to the paper width without space.

- If the paper guides are too loose or too tight, this may result in misfeeds or paper jams.
- Printouts may be askew depending on the printing environment. Properly load paper to reduce the symptom.

When using paper that has been poorly cut

If you use paper that has been poorly cut, multiple sheets of paper may be fed at once. In this case, fan the paper thoroughly, and then align the edges of the stack properly on a hard, flat surface.

Do not exceed the load limit mark when loading paper.

Ensure that the paper stack does not exceed the line of the load limit mark. If the paper stack exceeds the load limit mark lines, this may result in misfeeds.

When printing on envelopes

Load envelopes with the front side (non-glued side) facing up. You cannot print on the reverse side of envelopes.

Also, be sure to close the flap before loading envelopes.

NOTE

Detailed information about usable paper

▶ "Paper Requirements" (→P.2-6)

Size abbreviation on the paper guides of the paper cassette

Paper size	Paper guide
Legal	LGL
Letter	LTR
Executive	EXEC

Paper Loading Capacity

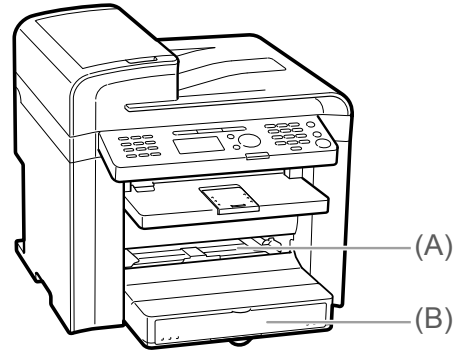

Paper type	Paper source	
	(A) Multi-purpose tray	(B) Paper cassette
Plain paper (Ex. 21 lb Bond (80 g/m ²))	1 sheet	Approx. 250 sheets
Heavy paper (Ex. 25 lb Bond (91 g/m ²))	1 sheet	Approx. 170 sheets
Heavy paper (Ex. 34 lb Bond (128 g/m ²))	1 sheet	Approx. 100 sheets
Recycled paper (Ex. 21 lb Bond (80 g/m ²))	1 sheet	Approx. 250 sheets
Color paper (Ex. 21 lb Bond (80 g/m ²))	1 sheet	Approx. 250 sheets
Transparency	1 sheet	Approx. 50 sheets
Label	1 sheet	Approx. 100 sheets
Envelope	1 envelope	Approx. 20 envelopes

Paper Loading Orientation



NOTE

Paper loading orientation when loading in the multi-purpose tray

Paper loading orientation for the multi-purpose tray is same as which for the paper cassette.

When printing paper with a letterhead or logo (previously printed paper)

Load the paper as shown below.

(➡: Feeding direction)

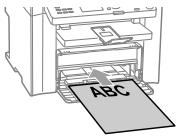
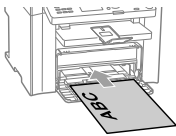
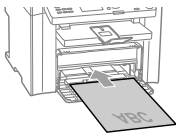
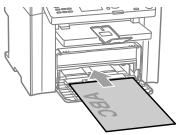
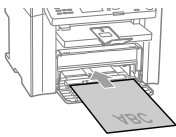
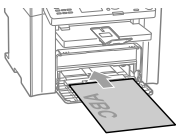
	Portrait layout	Landscape layout
1-sided printing ^{*1}	 <p>(with the printed side face up)</p>	 <p>(with the printed side face up)</p>
1-sided printing ^{*2}	 <p>(with the printed side face down)</p>	 <p>(with the printed side face down)</p>
Automatic 2-sided printing	 <p>(with the front side face down)</p>	 <p>(with the front side face down)</p>

^{*1} When <Paper Feed Method Switch> is set to <Print Speed Priority> (the default setting)

☑ "Selecting Print Side" (→P.2-16)

^{*2} When <Paper Feed Method Switch> is set to <Print Side Priority>

☑ "Selecting Print Side" (→P.2-16)

Printing on Envelopes

Load envelopes with the front side (non-glued side) facing up as follows.

(➡: Feeding direction)

Envelope, No.10, DL, ISO-C5

Load the envelopes so that the flap is toward the left of the paper cassette when they are viewed from the front.

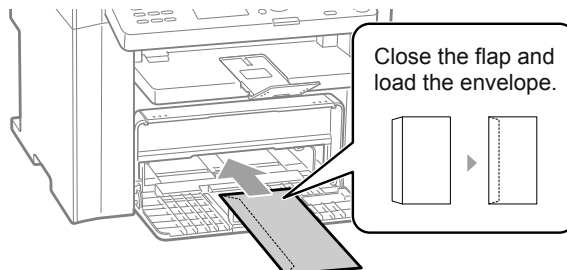

Envelope ISO-B5

Load the envelopes so that the flap is toward the back of the paper cassette when they are viewed from the front.

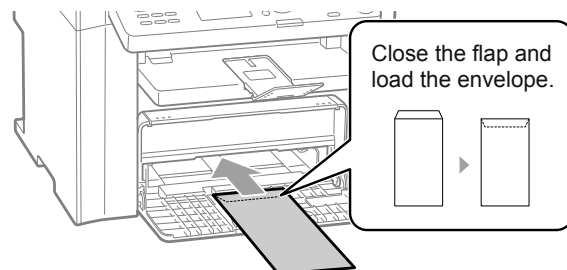

Setting a Paper Size and Type

Whenever you change the paper size and type loaded in the cassette or tray, follow the procedure in this section to adjust the paper size and type settings.



IMPORTANT

If the setting is different from the size of the loaded paper

An error message appears, or printing is not performed correctly.

Keys to be used for this operation

Paper Settings

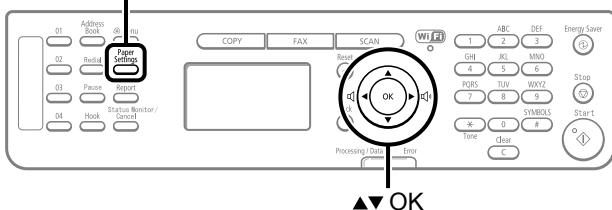

- 1 Press [] (Paper Settings).
- 2 Press [▲] or [▼] to select <MP Tray> or <Drawer 1>, and then press [OK].

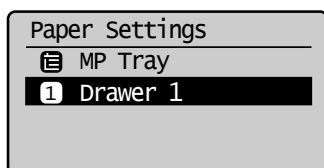

- 3 Press [▲] or [▼] to select a paper size, and then press [OK].

☞ "Paper Requirements" (→P.2-6)

* When registering the custom paper, see "Setting a Custom Paper Size" (→P.2-14).

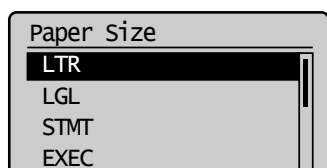

- 4 Press [▲] or [▼] to select a paper type, and then press [OK].

☞ "Paper Requirements" (→P.2-6)

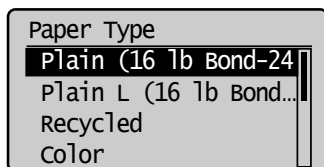



- 5 Press [] (Paper Settings) to close <Paper Settings> screen.

Setting a Custom Paper Size

To use custom paper, you must specify a paper size and type.

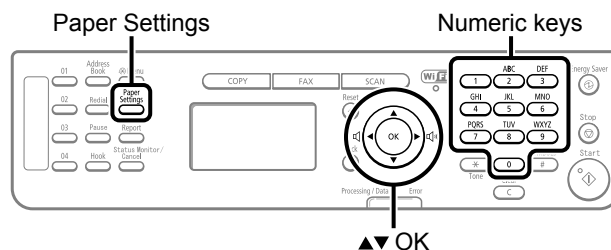
Keys to be used for this operation



- 1 Press [] (Paper Settings).
- 2 Press [▲] or [▼] to select <MP Tray> or <Drawer 1>, and then press [OK].

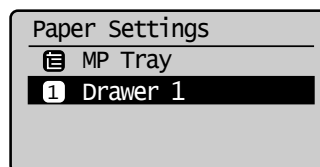

- 3 Press [▲] or [▼] to select <Custom Size>, and then press [OK].

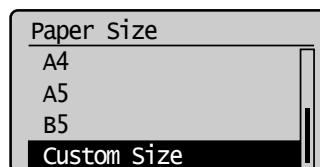

4 Specifies the size of <X> direction and <Y> direction.

(1) Press [▲] or [▼] to select the direction, and then press [OK].

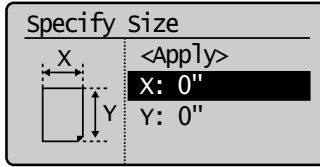

(2) Press [▲] or [▼] to specify the size, and then press [OK].
You can also enter values using the numeric keys.

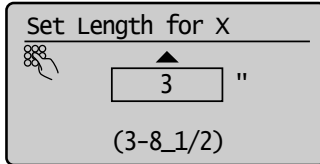

(3) Press [▲] or [▼] to select <Apply>, and then press [OK].

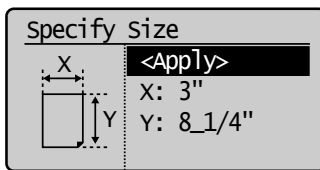

5 Press [▲] or [▼] to select a paper type, and then press [OK].

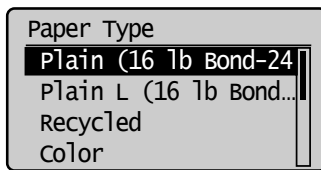

6 Press [] (Paper Settings) to close <Paper Settings> screen.

Selecting Print Side

You can specify whether to match the sides to be printed for 2-sided printing and 1-sided printing. Depending on the setting for this item, the side to be printed changes. When using previously printed paper, read "Paper Loading Orientation" (→P.2-13) thoroughly to load the paper in the proper orientation.

When setting this item to <Print Speed Priority> (the default setting)

Because the sides to be printed for 2-sided printing and 1-sided printing are different, the printing sides do not match.

- * When using previously printed paper, you need to switch the sides of loaded paper between 2-sided printing and 1-sided printing.

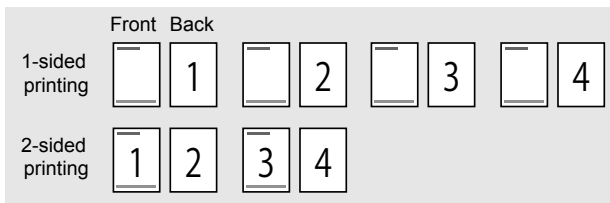

Specify the setting in the following cases.

- When not using previously printed paper
- When performing only 1-sided printing on previously printed paper

When setting this item to <Print Side Priority>

The sides to be printed for 2-sided printing and 1-sided printing match.

- * Even when using previously printed paper, you do not need to switch the sides of loaded paper between 2-sided printing and 1-sided printing.

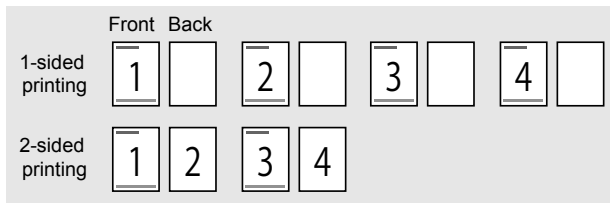

Specify the setting in the following case.

- When performing 2-sided printing and 1-sided printing on previously printed paper

Keys to be used for this operation

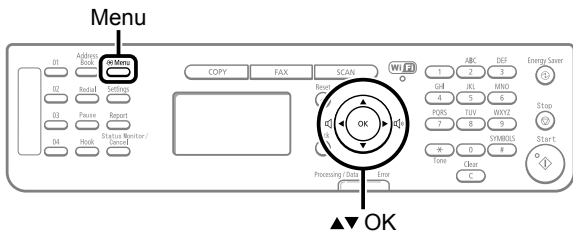

1 Press [] (Menu).

2 Press [▲] or [▼] to select <Preferences>, and then press [OK].

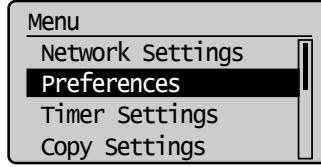

3 Press [▲] or [▼] to select <Paper Feed Method Switch>, and then press [OK].

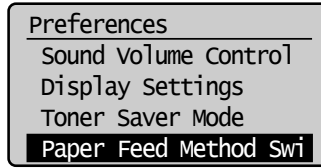

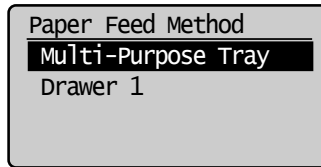

4 Press [▲] or [▼] to select a paper source, and then press [OK].

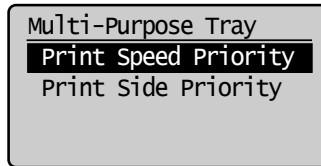

5 Press [▲] or [▼] to select <Print Speed Priority> or <Print Side Priority>, and then press [OK].

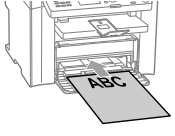
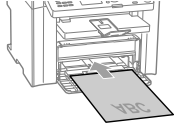
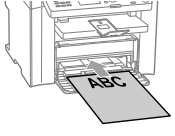
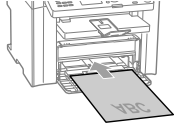
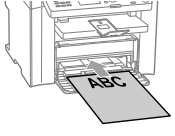
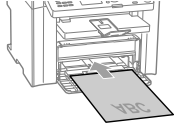
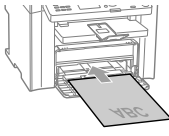

<p><Print Speed Priority></p>	<p>When specifying <Print Speed Priority>, load paper as follows.</p> <p>(➡: Feeding direction)</p> <p>* For details on the procedure for loading paper when printing pages of the landscape layout, see "Paper Loading Orientation" (→P.2-13).</p> <table border="1" style="width: 100%; border-collapse: collapse;"> <thead> <tr> <th style="width: 50%; padding: 5px;">When performing 1-sided printing</th> <th style="width: 50%; padding: 5px;">When performing 2-sided printing</th> </tr> </thead> <tbody> <tr> <td style="padding: 5px;">Load paper with the printed side face up.</td> <td style="padding: 5px;">Load paper with the front side (first page) face down.</td> </tr> <tr> <td style="text-align: center; padding: 5px;"></td> <td style="text-align: center; padding: 5px;"></td> </tr> </tbody> </table>	When performing 1-sided printing	When performing 2-sided printing	Load paper with the printed side face up.	Load paper with the front side (first page) face down.		
When performing 1-sided printing	When performing 2-sided printing						
Load paper with the printed side face up.	Load paper with the front side (first page) face down.						
							
<p><Print Side Priority></p>	<p>When specifying <Print Side Priority>, load paper as follows.</p> <p>(➡: Feeding direction)</p> <p>* For details on the procedure for loading paper when printing pages of the landscape layout, see "Paper Loading Orientation" (→P.2-13).</p> <div style="border: 1px solid black; padding: 10px; margin: 10px 0;"> <p>The procedure for loading paper is the same for 2-sided printing and 1-sided printing.</p> <ul style="list-style-type: none"> • When performing 1-sided printing, load paper with the printed side face down. • When performing 2-sided printing, load paper with the front side (first page) face down. </div> <div style="text-align: center; margin-top: 10px;">  </div>						

6 Press [] (Menu) to close the menu screen.

Copying

This category describes the copying features.

Basic Copying Method **3-2**

Checking and Canceling Copy Jobs	3-3
Canceling using the Stop Key	3-3
Checking and Canceling using the Status Monitor/Cancel Key	3-3

Copy Settings **3-4**

Adjusting the Density	3-4
Selecting Image Quality (Copy)	3-4
2-Sided Copying	3-5
Enlarging/Reducing Copies	3-6
Multiple Documents onto One Sheet (N on 1)	3-6
Collating Copies	3-7
Emphasize the Outline of an Image (Sharpness)	3-7

Copying an ID Card **3-8**

Changing the Default Values **3-9**

Basic Copying Method

This section describes the basic procedure for copying.

1 Place documents.

▶ "Placing Documents" (→P.2-4)

▶ "Document Requirements" (→P.2-2)

* A maximum of 35 pages can be loaded into the feeder.

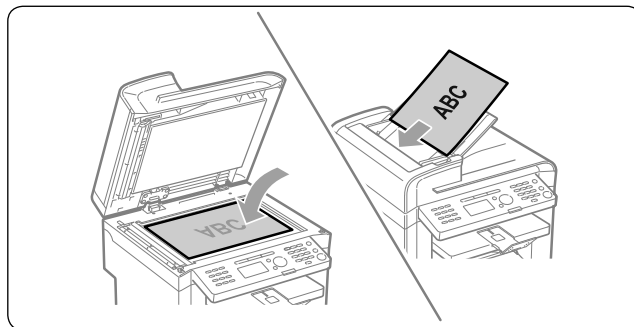

2 Press [COPY].

4 Use numeric keys to enter the desired copy quantity (1 to 99).

* Press [C] (Clear) to delete a number.

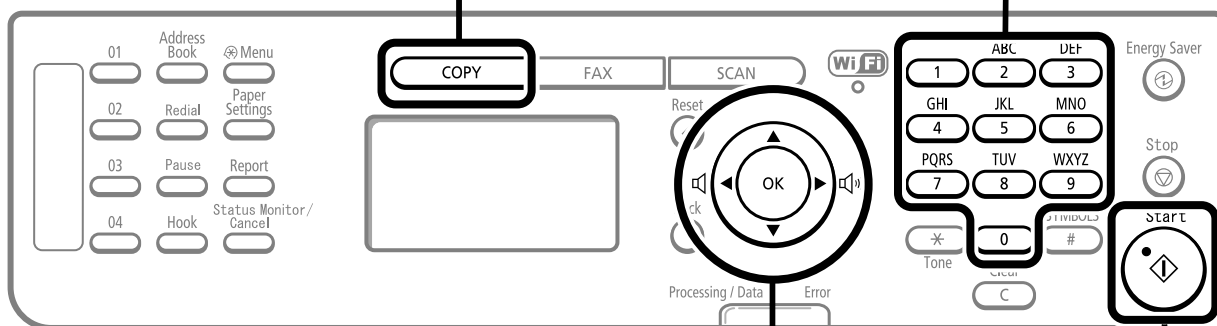

3 Specify the copy settings as needed.

You can specify up to 7 items.
(for details, see P.3-3 to P.3-6.)

- | | |
|---------------------------|-------------------------|
| 1 Density | 5 Reduced layout |
| 2 Image quality | 6 Collating |
| 3 2-Sided | 7 Sharpness |
| 4 Enlarged/reduced | |

5 Press [Start].

The settings that are specified here apply only to copy operation which you are currently performing. To apply the valid settings for all copy operations, see "Changing the Default Values" (→P.3-9).

Checking and Canceling Copy Jobs

You can check detailed information about copy jobs. Also, you can cancel copy jobs while the jobs are in process.

NOTE

If the processing/Data indicator on the operation panel is:

Turned on/blinking	A job is being processed.
Turned off	No jobs are in the memory.

Canceling using the Stop Key

1 Press [] (Stop).

* If only one job is processing or waiting, you can stop the job by pressing [] (Stop) twice.

2 When multiple jobs are being processed, press [▲] or [▼] to select a job to be canceled, and then press [OK].

3 When <Cancel?> appears, press [▲] or [▼] to select <Yes>, and then press [OK].

You can cancel the print job also by pressing [] (Stop).
The copy job is canceled.

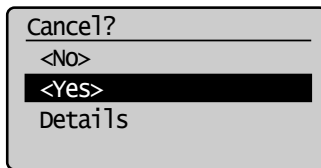

* To check the job before canceling, press [▲] or [▼] to select <Details>, and then press [OK].

Checking and Canceling using the Status Monitor/Cancel Key

1 Press [] (Status Monitor/Cancel).

2 Press [▲] or [▼] to select <Copy Job Status>, and then press [OK].

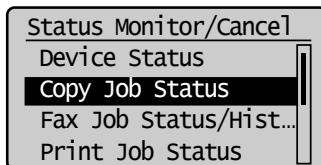

The detailed information is displayed.

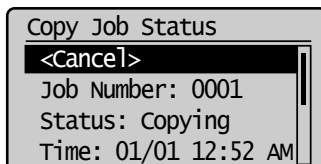

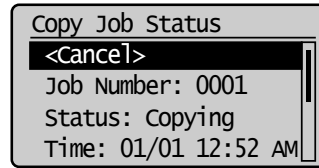

● For canceling

- Press [▲] or [▼] to select <Cancel>, and then press [OK].

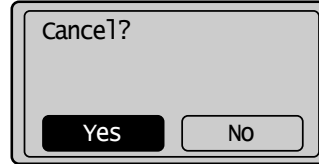

- Press [◀] or [▶] to select <Yes>, and then press [OK].
The copy job is canceled.



- Press [] (Status Monitor/Cancel) to close the screen.

● For checking only

- Press [] (Status Monitor/Cancel) to close the screen.

Copy Settings

1 Adjusting the Density

Copy mode screen

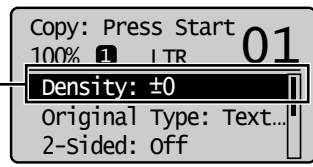

Press [▲] or [▼] to select <Density>



Setting screen

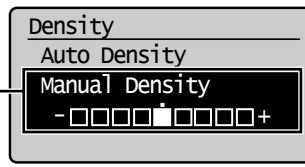

Press [◀] or [▶] to adjust the density → [OK]

[◀]	Makes the copy density lighter.
[▶]	Makes the copy density darker.

- * Select <Auto Density> to copy with the density that is suitable for the document. If other than <Text> is set as <Original Type>, <Original Type> will be changed to <Text> when you select <Auto Density>.
- * You can adjust <Manual Density> by pressing [◀] or [▶], when either of <Auto Density> or <Manual Density> is selected.

2 Selecting Image Quality (Copy)

Copy mode screen

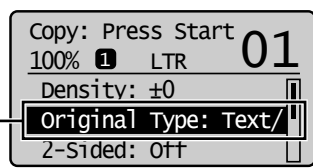

Press [▲] or [▼] to select <Original Type>



Setting screen

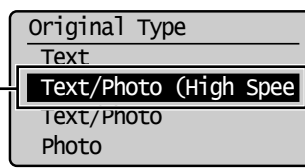

Press [▲] or [▼] to select the appropriate settings for the document → [OK]

<Text>	This setting is suitable for documents that contain text without photos or illustrations.
<Text/Photo (High Speed)>	This setting is suitable for documents that contain text and photos. This setting scans the document at a low resolution. This setting scans the document at a low resolution.
<Text/Photo>	This setting is suitable for documents that contain text and photos.
<Photo>	This setting is suitable for the documents that contain photos printed in a magazine.

- * If <Density> is set to <Auto Density>, <Density> will be changed to <Manual Density> when you select <Text/Photo (High Speed)>, <Text/Photo>, <Photo>.

Copy Settings

3 2-Sided Copying

Copy mode screen

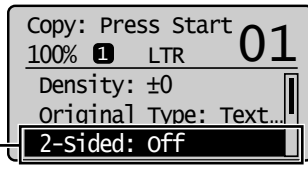

Press [▲] or [▼] to select <2-Sided>

Setting screen

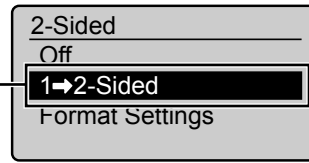

Press [▲] or [▼] to select <1→2-Sided> → [OK]

If you want to specify 2-Sided copying format

- (1) Press [▲] or [▼] to select <Format Settings> → [OK]

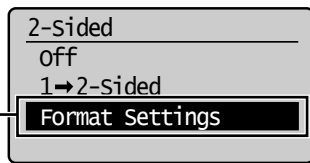

- (3) Press [▲] or [▼] to select the orientation of the document → [OK]

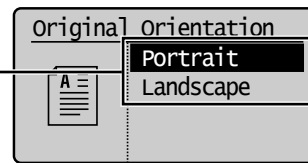

- (2) Press [▲] or [▼] to select <1 → 2-Sided> → [OK]

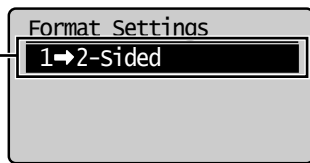

- (4) Press [▲] or [▼] to select the finishing format → [OK]

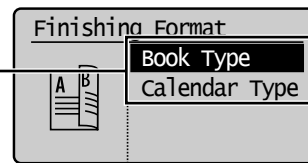

If you place documents on the platen glass

- (1) Place the next document, and then press [Start] (Start).
(2) Press [▲] or [▼] to select <Start Copying>, and then press [OK].

* Repeat the procedure until all documents are scanned.

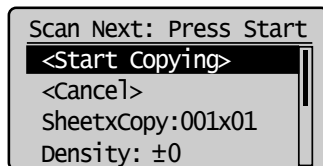

Copy Settings

4 Enlarging/Reducing Copies

Copy mode screen

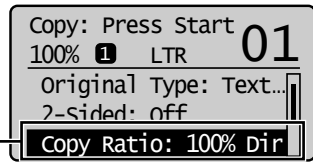

Press [▲] or [▼] to select <Copy Ratio>

Setting screen

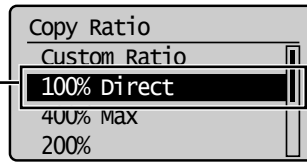

Press [▲] or [▼] to select the copy ratio → [OK]

Load paper of the output size (→P.2-9)

Register the output paper size (→P.2-14)

For the preset zoom, you can select from the following setting values.

- 100% Direct
- 400% Max
- 200%
- 129% STMT → LTR
- 78% LGL → LTR
- 64% LTR → STMT
- 50%
- 25% Min

For custom ratio

(1) Press [▲] or [▼] to select <Custom Ratio> → [OK]

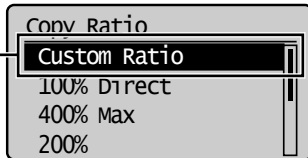

(2) Press [▲] or [▼] to specify the ratio → [OK]

You can also enter the copy ratio using the numeric keys.

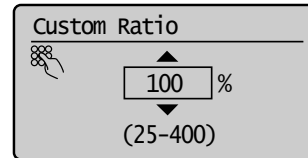

5 Multiple Documents onto One Sheet (N on 1)

Copy mode screen

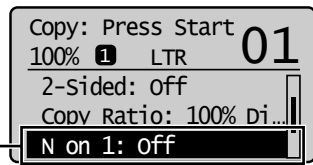

Press [▲] or [▼] to select <N on 1>

Setting screen

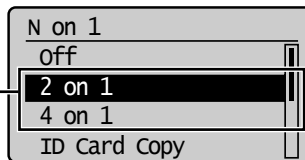

Press [▲] or [▼] to select <2 on 1> or <4 on 1>

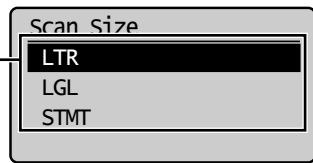

Press [▲] or [▼] to select the size of the original document → [OK]

About margins among documents

When you copy in an N on 1 layout, margins are created among the reduced documents.

<2 on 1>	Reduce two-page documents to fit on one sheet of paper.
<4 on 1>	Reduce four-page documents to fit on one sheet of paper.

When specifying the layout

(1) Press [▲] or [▼] select <Select Layout> → [OK]

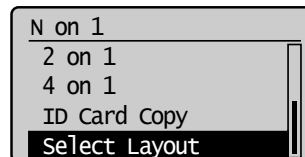

(2) Press [▲] or [▼] select the layout → [OK]

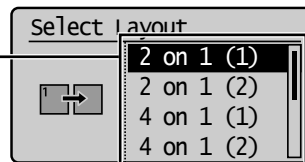

Copy Settings

6 Collating Copies

Copy mode screen

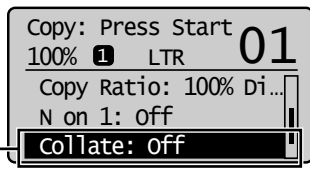

Press [▲] or [▼] to select <Collate>

Setting screen

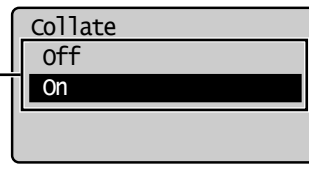

Press [▲] or [▼] to select <On> → [OK]

<Off>	<p>Printouts of a complete job are grouped. For example, if you are copying three copies of a three-page document, printouts of a complete job are grouped and arranged in this page order: "1, 1, 1," "2, 2, 2," "3, 3, 3".</p>	
<On>	<p>Printouts of a complete job are collated. For example, if you are printing three copies of a three-page document, printouts of a complete job are grouped and arranged in this page order: "1, 2, 3," "1, 2, 3," "1, 2, 3".</p>	

7 Emphasize the Outline of an Image (Sharpness)

Copy mode screen

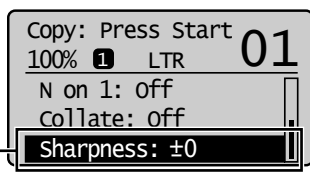

Press [▲] or [▼] to select <Sharpness>

Setting screen

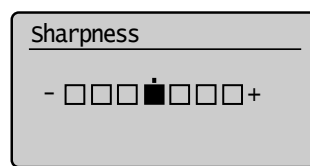

Press [◀] or [▶] to adjust the sharpness → [OK]

[◀]	<p>Reduces distorted pattern (moire). It is appropriate for documents that contain halftone such as printed photos.</p>
[▶]	<p>Raise the sharpness and emphasize the outline of text or lines. It is appropriate for documents which are blueprints or thinly penciled.</p>

Copying an ID Card

You can make a copy of a 2-sided card onto one side of a paper.

Keys to be used for this operation

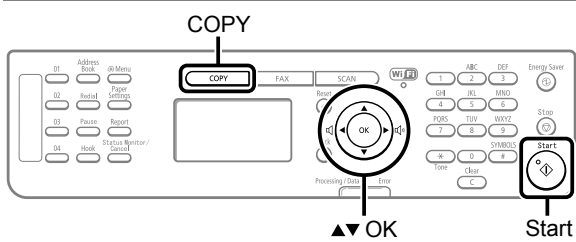

1 Place a card on the platen glass, and then close the feeder.

Place the card with a 1/4" (5 mm) space created from the left edge of the platen glass. Additionally, align the center of the card with the arrow mark.

If you want to arrange the cards horizontally

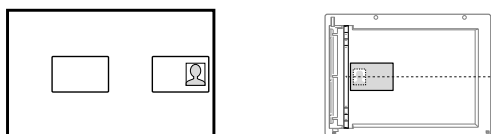

If you want to arrange the cards vertically

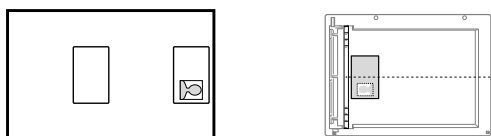

2 Press [COPY].

3 Press [▲] or [▼] to select <N on 1>, and then press [OK].

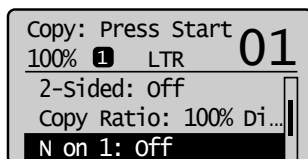

4 Press [▲] or [▼] to select <ID Card Copy>, and then press [OK].

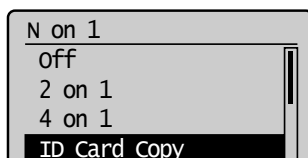

5 Press [Start].

After scanning the document completely, proceed to the next step.

6 Turn and place the card.

Place the card with a 1/4" (5 mm) space created from the left edge of the platen glass. Additionally, align the center of the card with the arrow mark.

If you want to arrange the cards horizontally

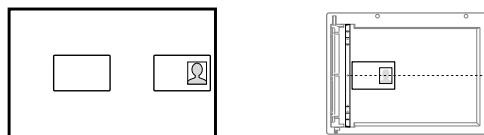

If you want to arrange the cards vertically

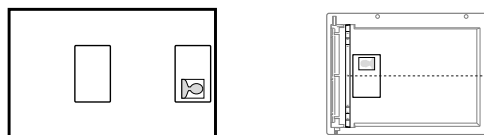

7 Press [Start].



NOTE

Placing a document (card)

Place a card on the left half of the platen glass.

Copy ratio

The copy ratio will automatically be set to <100%>.

Usable paper size

A size larger than A4 or Letter

Unavailable functions in combination

You cannot use an ID card copy together with the following functions.

- 2 on 1/4 on 1
- Collating
- 2-Sided
- Copy ratio

Changing the Default Values

The default values of the copy are the function which is applied when [] (Reset) is pressed or the power is turned ON. You can change the default values to suit your needs. You can register the following types of settings as the default values.

- Quantity
- Density
- Original type
- 2-Sided
- Copy ratio
- N on 1
- Collating
- Sharpness

Keys to be used for this operation

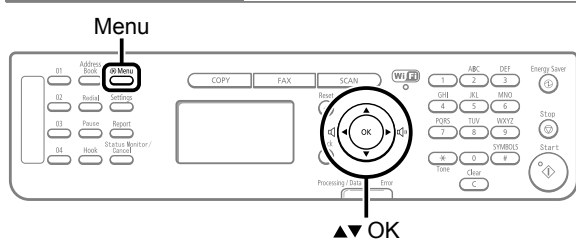

1 Press [] (Menu).

2 Press [▲] or [▼] to select <Copy Settings>, and then press [OK].

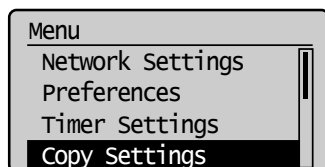

3 Press [▲] or [▼] to select <Change Defaults>, and then press [OK].

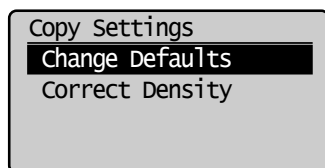

4 Press [▲] or [▼] to select a setting item, and then press [OK].

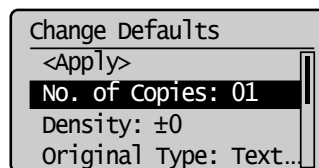

For details on the settings, see the following items.

- ▶ "Adjusting the Density" (→P.3-4)
- ▶ "Selecting Image Quality (Copy)" (→P.3-4)
- ▶ "2-Sided Copying" (→P.3-5)
- ▶ "Enlarging/Reducing Copies" (→P.3-6)
- ▶ "Multiple Documents onto One Sheet (N on 1)" (→P.3-6)
- ▶ "Collating Copies" (→P.3-7)
- ▶ "Emphasize the Outline of an Image (Sharpness)" (→P.3-7)

5 After you are finished press [▲] or [▼] to select <Apply>, and then press [OK].

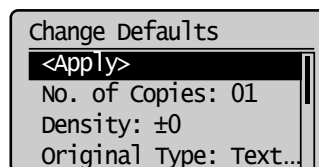

6 Press [] (Menu) to close the menu screen.

Printing from a Computer

This category describes how to print from computers.

* If you are a Macintosh user, see the following.

- To install the Print Driver
→ Starter Guide or Mac UFR II Printer Driver Installation Guide
- To view how to use each function
→ Print Driver's Help

To view how to display the Mac UFR II Printer Driver Installation Guide or Print Driver's Help, see "For Macintosh Users" (→P.11-4).

Installing the Printer Driver	4-2
--------------------------------------	------------

Printing from a Computer	4-3
---------------------------------	------------

Scaling Documents	4-3
Printing Multiple Pages on One Sheet	4-3
2-sided Printing	4-4
Checking and Canceling Print Jobs	4-5

● Installing the Printer Driver

The following procedures are required as the preparations for printing.

Step 1	Select USB or network connection.	☞ Starter Guide → 4 Connecting to a Computer and Installing the Drivers
Step 2	Install the printer driver.	



NOTE

When changing the port number of the machine

Change the port number of the machine.

☞ e-Manual → Security → Restricting Network Connection → Setting the Print Port Number

Change the computer settings.

☞ e-Manual → Network Settings → Setting Up a Computer for Printing/Sending a Fax → Specifying Computer Settings

About the printer driver

The printer driver is software required for printing from an application. The printer driver will convert application software's print data to print data for the printer.

The printer driver for this machine has the following features.

- The printer driver for this machine enables you to output print data at an optimum speed by dividing the workload using a computer and the printer.
- As well as providing faster and more stable printing than conventional models, the printer driver for this machine uses less memory to operate.
- In addition to the conversion of print data, the printer driver for this machine is equipped with the functions capable of spooling print data and configuring the print condition, and various types of print finishing can be set such as scaling or gutter adjustment.

Printing from a Computer

Scaling Documents

You can enlarge or reduce documents to match the output paper size.

There are two methods for scaling a document: select the output size of the document to scale it automatically, or specify the scaling value manually.

1 Click [Page Setup].

For instructions on how to display the printer driver screen, see "Printing" or "Configuring the Default Print Settings" in the e-Manual.

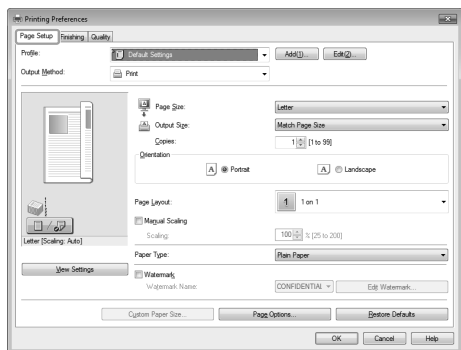

2 Select paper size of the document you created in the application from [Page Size].

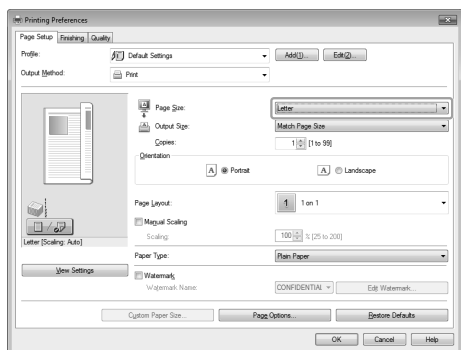

3 Select output size of the document from [Output Size].

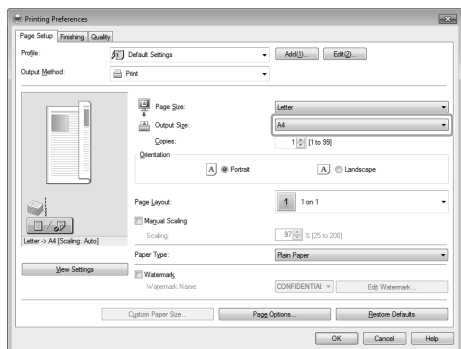

The document is scaled automatically according to the settings made in [Page Size] and [Output Size].

4 If you want to increase or decrease the magnification manually, select [Manual Scaling] → specify the scaling ratio for [Scaling].

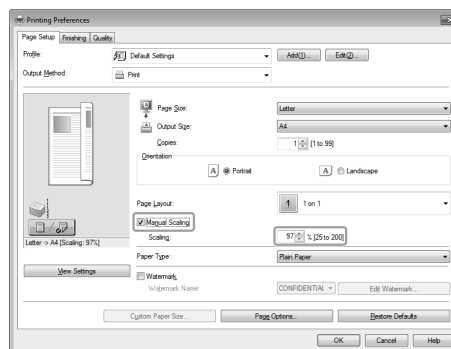

5 Click [OK].



NOTE

- Depending on the printer model you are using, you may not be able to magnify the document to the optimum ratio for the selected page size.
- The display may differ according to the operating system, as well as the type and version of the printer driver.

Printing Multiple Pages on One Sheet

You can reduce and print multiple pages on a single sheet of paper. You can place 2, 4, 6, 8, 9, and 16 pages of documents on a single sheet of paper. Using this feature, you can make materials that are easy to view. Also, this feature helps you to save paper, and save space when storing.

1 Click [Page Setup].

For instructions on how to display the printer driver screen, see "Printing" or "Configuring the Default Print Settings" in the e-Manual.

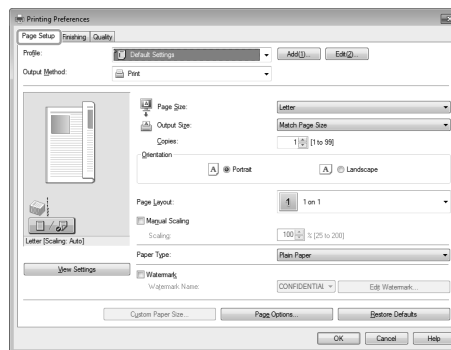

2 Select the page layout from [Page Layout].

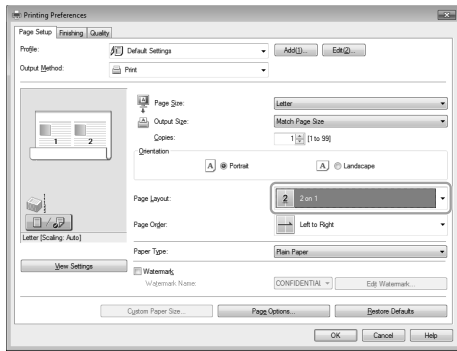

3 Select the page order from [Page Order].

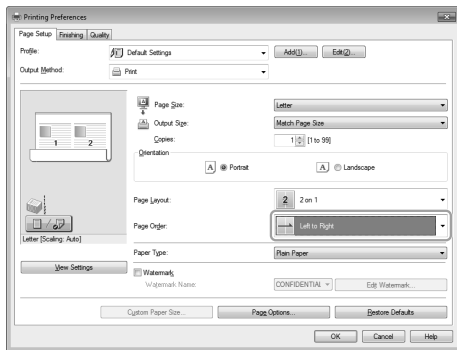

The output image is displayed in the preview area.

4 Click [OK].

NOTE

- You cannot enlarge and reduce manually when using this function.
- Although there may be a function for printing multiple copies depending on the application you are using, do not use it together with this function. If you do, printing may not be executed correctly.
- The display may differ according to the operating system, as well as the type and version of the printer driver.

2-sided Printing

Two-sided printing prints a document on both sides of the paper. You can reduce paper consumption by half.

1 Click [Finishing].

For instructions on how to display the printer driver screen, see "Printing" or "Configuring the Default Print Settings" in the e-Manual.

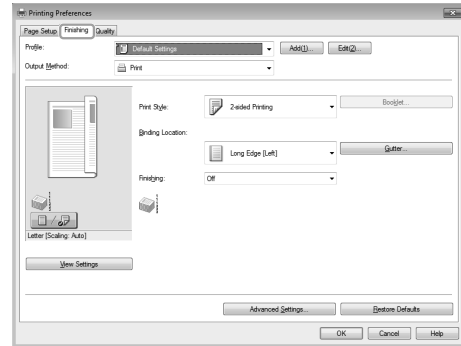

2 Select [2-sided Printing] from [Print Style].

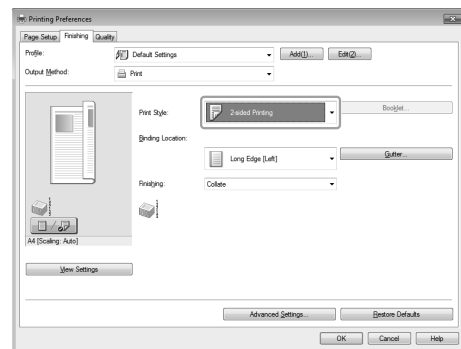

3 Select the binding edge from [Binding Location].

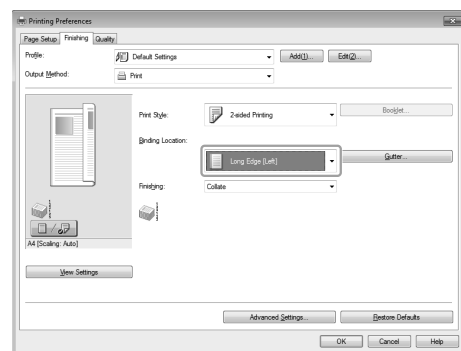

The output image is displayed in the preview area.

4 Click [OK].

NOTE

- The page sizes for which two-sided printing is available differ according to printer model. For details, view the online help.
- The display may differ according to the operating system, as well as the type and version of the printer driver.

Checking and Canceling Print Jobs

You can check detailed information about print jobs in the middle of currently printing or waiting.

NOTE

Document name and user name displayed in the operation panel

Some file name may be displayed incorrectly depending on the type of the file to be printed.

If the Processing/Data Indicator on the operation panel is:

Turned on/blinking	A job is being processed.
Turned off	No jobs are in the memory.

Keys to be used for this operation

Status Monitor/Cancel

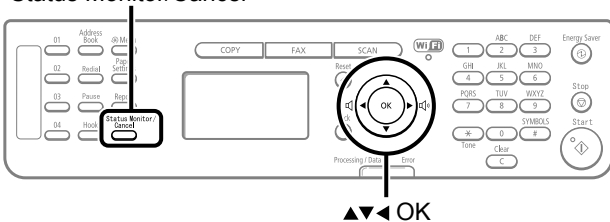

- 1 Press [] (Status Monitor/Cancel).
- 2 Press [▲] or [▼] to select <Print Job Status> and then press [OK].

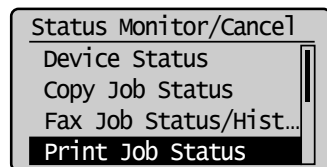

- 3 Press [▲] or [▼] to select a job to be checked or canceled, and then press [OK].

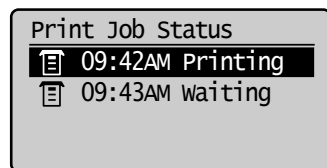

The detailed information is displayed.

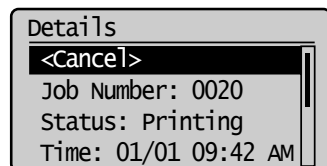

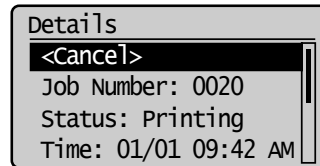

● For canceling

- (1) Press [▲] or [▼] to select <Cancel>, and then press [OK].

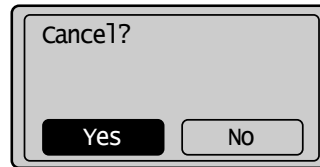

- (2) Press [◀] to select <Yes>, and then press [OK].
The print job is canceled.



- (3) Press [] (Status Monitor/Cancel) to close the screen.

NOTE

Pressing [] (Stop) can also delete the print jobs

You can delete the print jobs also by pressing [] (Stop).

* If only one print job is processing or waiting, you can stop the job by pressing [] (Stop) twice.

● For checking only

Press [] (Status Monitor/Cancel) to close the screen.

Registering Destinations in the Address Book

This section describes the procedures for registering destinations in the address book and changing or deleting the registered settings.

Address Book	5-2
One-touch Keys	5-2
Coded Dialing	5-2
Group Dialing	5-2
Registering and Editing One-Touch Keys	5-3
Registering and Editing via the Operation Panel	5-3
Registering and Editing One-Touch Keys via the Remote UI	5-5
Registering and Editing Coded Dial Codes	5-6
Registering and Editing via the Operation Panel	5-6
Registering and Editing a coded Dial Code via the Remote UI	5-8
Registering and Editing Recipients for Group Dialing	5-9
Registering and Editing a Destination Group via the Operation Panel	5-9
Registering and Editing a Destination Group via the Remote UI	5-12

Address Book

When faxing documents, you can specify a destination by manually entering characters with the numeric keys or by selecting a pre-registered destination from the address book. You can register frequently used destinations under one-touch keys and coded dial codes.

You can also save one-touch keys and coded dial codes as a group.

You can register destinations using the operation panel.

* You can also use the Remote UI to register destinations.

One-touch Keys

You can register up to 4 destinations to one-touch keys. Once registered, pressing the appropriate one-touch key will recall the destination number.

☞ "Registering and Editing One-Touch Keys" (→P.5-3)

Coded Dialing

You can register up to 100 destinations to coded dial codes. Once registered, entering the coded dial code will recall the destination number.

☞ "Registering and Editing Coded Dial Codes" (→P.5-6)

Group Dialing

You can group the registered recipients (up to 50 recipients) under one-touch keys and coded dial codes. Group addresses are to be registered for an unused one-touch key or coded dial code. Simply specifying the one-touch key or coded dial code allow you to specify multiple addresses registered as a group.

☞ "Registering and Editing Recipients for Group Dialing" (→P.5-9)



NOTE

Saving/Reading the address book

The address book can be saved as a file in your computer using the Remote UI, and the saved file can be read in the machine.

☞ e-Manual → Setting and Managing from Computer → Managing the Address Book

However, you cannot edit the address book saved as a file.

Viewing destinations registered in the address book

You can view destinations by printing destination lists.

☞ e-Manual → Basic Operation → Printing a List → Printing an Address Book List

Registering and Editing One-Touch Keys

This section describes the following procedure.

- Registering one-touch keys
- Editing one-touch keys
- Deleting one-touch keys

Registering and Editing via the Operation Panel

Keys to be used for this operation

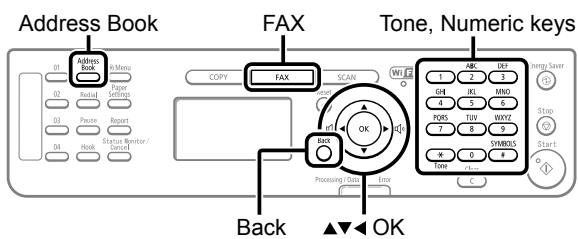

1 Press [**FAX**].

2 Press [**Address Book**].

When registering a one-touch key newly

- (1) If there are destinations registered, press [**Left Arrow**].
If you are registering a destination for the first time, proceed to step (2).
- (2) Press [**Up Arrow**] or [**Down Arrow**] to select <Register New Destination to Address Book>, and then press [OK].

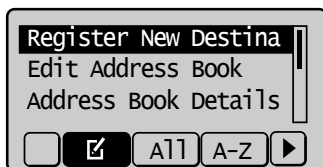

When the address book PIN is specified

Use the numeric keys to enter the PIN, and then press [OK].

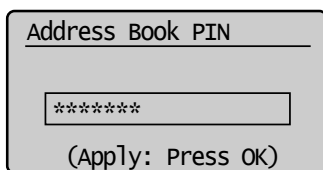

- (3) Press [**Up Arrow**] or [**Down Arrow**] to select <One-Touch>, and then press [OK].

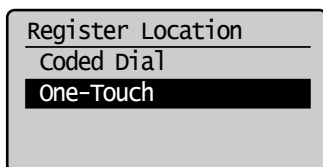

- (4) Press [**Up Arrow**] or [**Down Arrow**] to select <Fax>, and then press [OK].

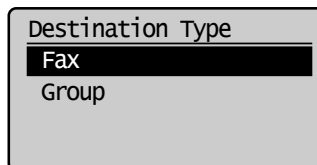

- (5) Press [**Up Arrow**] or [**Down Arrow**] to select the number to be registered, and then press [OK].

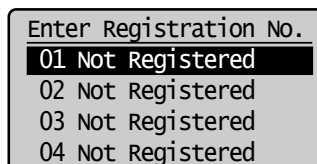

- (6) Press [**Up Arrow**] or [**Down Arrow**] to select <Name>, and then press [OK].

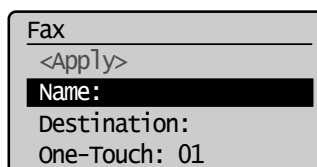

- (7) Use the numeric keys to specify <Name>.
☞ "Text Input Method" (→P.1-9)

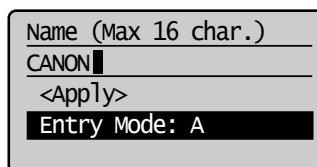

- (8) Press [**Up Arrow**] or [**Down Arrow**] to select <Apply>, and then press [OK].

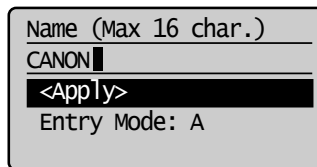

- (9) Press [**Up Arrow**] or [**Down Arrow**] to select <Destination>, and then press [OK].

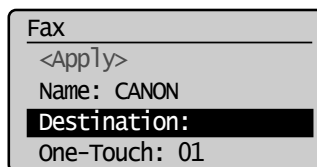

- (10) Use the numeric keys to specify <Destination>.
Press [OK] to specify <Settings> as needed.

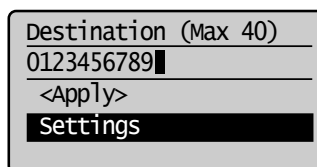

- (11) Press [▲] or [▼] to select <Apply>, and then press [OK].

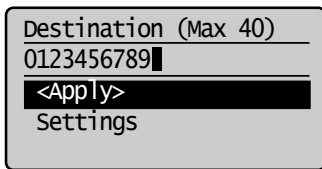

- (12) Press [▲] or [▼] to select <Apply>, and then press [OK].

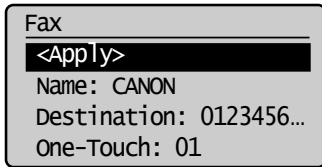

● Editing a one-touch key

- (1) Press [◀].

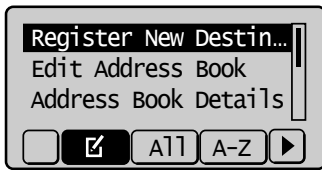

- (2) Press [▲] or [▼] to select <Edit Address Book>, and then press [OK].

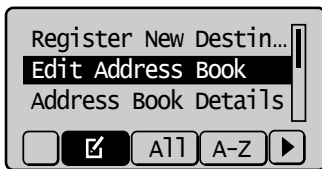

When the address book PIN is specified

Use the numeric keys to enter the PIN, and then press [OK].

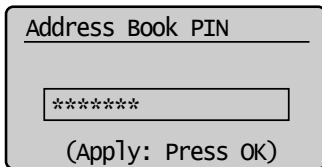

- (3) Press [▲] or [▼] to select a destination that you want to edit, and then press [OK].

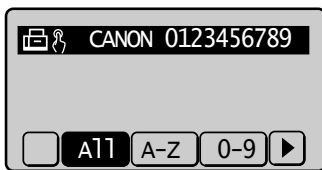

- (4) Press [▲] or [▼] to select an item that you want to edit, and then press [OK].

- Name
- Destination
- One-Touch

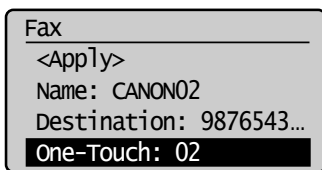

- (5) When you finish editing, press [▲] or [▼] to select <Apply>, and then press [OK].

- (6) Press [▲] or [▼] to select <Apply>, and then press [OK].

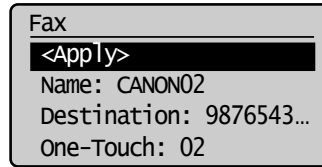

● Deleting a one-touch key

- (1) Press [◀].

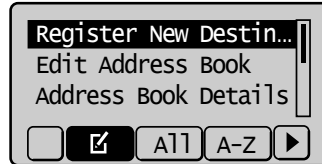

- (2) Press [▲] or [▼] to select <Delete From Address Book>, and then press [OK].

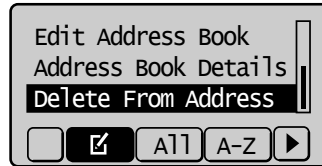

When the address book PIN is specified

Use the numeric keys to enter the PIN, and then press [OK].

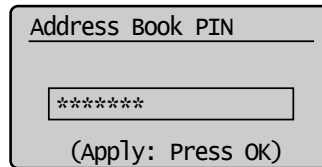

- (3) Press [▲] or [▼] to select a destination that you want to delete, and then press [OK].

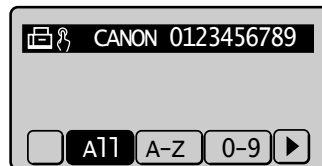

- (4) Press [◀] to select <Yes>, and then press [OK].

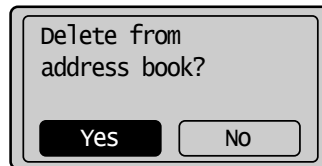

3 Press [○] (Back) to close the menu screen.

Registering and Editing One-Touch Keys via the Remote UI

- 1 Start the web browser.
- 2 Enter "http://<the IP address of the machine>/" in the address field, and then press the [ENTER] key on your keyboard.

Input Example: "http://192.168.0.215/"

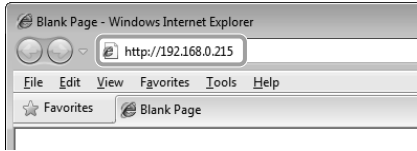

3 Log on to the Remote UI.

- (1) Select [System Manager Mode].
- (2) Enter [System Manager PIN].
- (3) Click [OK].

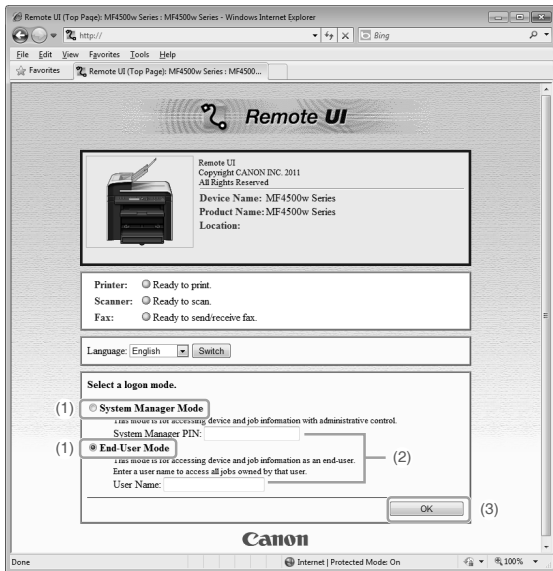

4 Click [Address] → [One-Touch].

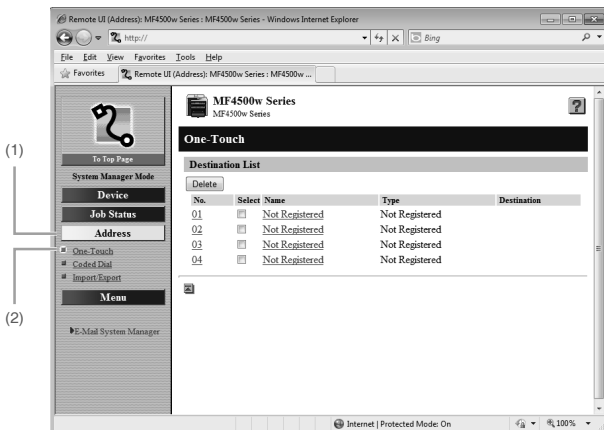

5 Storing a one-touch key newly

Proceed to Step 5.

Editing a one-touch key

- (1) Click the number or name.
- (2) Click [Edit].
- (3) Specify the required settings in the edit screen for destinations, and then click [OK].

Deleting a one-touch key

- (1) Select the check box for which you want to delete the number, and then click [Delete].

5 Click [Not Registered] or the number which is not registered.

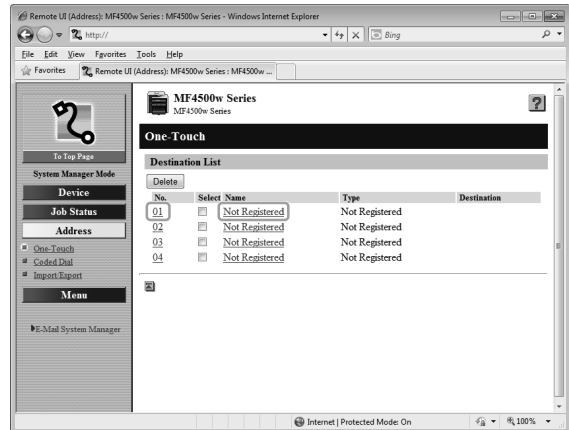

6 Select [Fax] from the drop-down list.



7 Specify the required settings, and then click [OK].

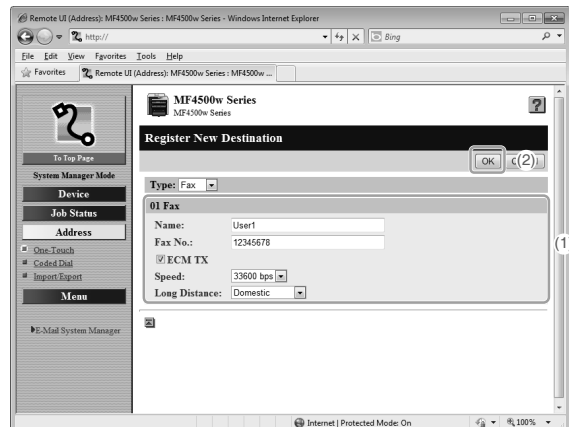

Registering and Editing Coded Dial Codes

This section describes the following procedure.

- Registering coded dial codes
- Editing coded dial codes
- Deleting coded dial codes

Registering and Editing via the Operation Panel

Keys to be used for this operation

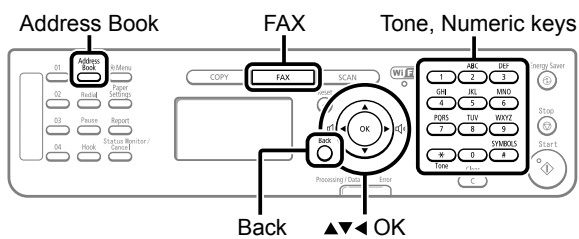

1 Press [**FAX**].

2 Press [**Address Book**].

● Registering a coded dial code newly

- (1) If there are destinations registered, press [**Left Arrow**].
If you are registering a destination for the first time, proceed to step (2).
- (2) Press [**Up Arrow**] or [**Down Arrow**] to select <Register New Destination to Address Book>, and then press [OK].

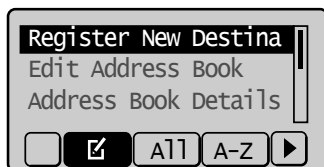

When the address book PIN is specified

Use the numeric keys to enter the PIN, and then press [OK].

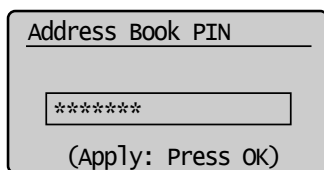

- (3) Press [**Up Arrow**] or [**Down Arrow**] to select <Coded Dial>, and then press [OK].

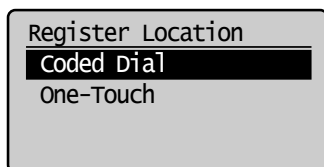

- (4) Press [**Up Arrow**] or [**Down Arrow**] to select <Fax>, and then press [OK].

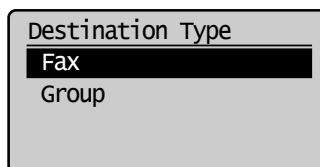

- (5) Press [**Up Arrow**] or [**Down Arrow**] to select <Name>, and then press [OK].

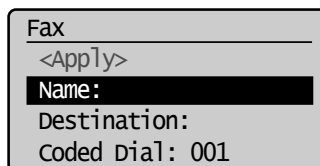

- (6) Use the numeric keys to specify <Name>.
☑ "Text Input Method" (→P.1-9)

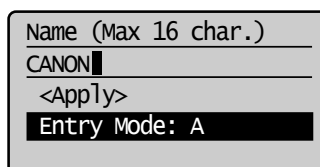

- (7) Press [**Up Arrow**] or [**Down Arrow**] to select <Apply>, and then press [OK].

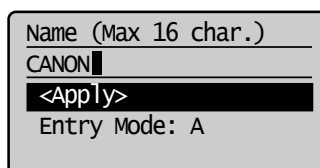

- (8) Press [**Up Arrow**] or [**Down Arrow**] to select <Destination>, and then press [OK].

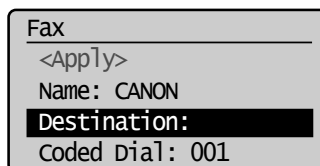

- (9) Use the numeric keys to specify <Destination>.
Press [OK] to specify <Settings> as needed.

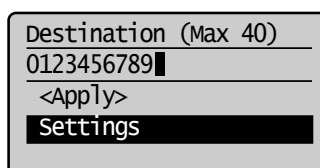

- (10) Press [**Up Arrow**] or [**Down Arrow**] to select <Apply>, and then press [OK].

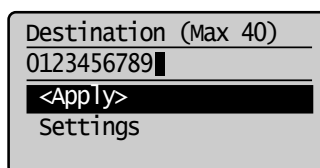

- (11) Press [▲] or [▼] to select <Coded Dial>, and then press [OK].

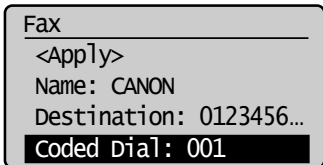

- (12) Press [▲] or [▼] to select the number to be registered, and then press [OK].

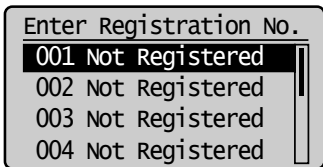

- (13) Press [▲] or [▼] to select <Apply>, and then press [OK].

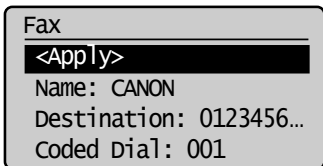

● **Editing a coded dial code**

- (1) Press [◀].

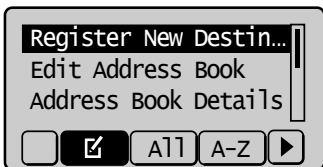

- (2) Press [▲] or [▼] to select <Edit Address Book>, and then press [OK].

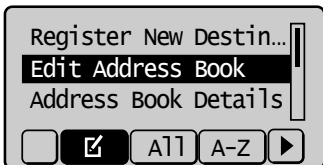

When the address book PIN is specified

Use the numeric keys to enter the PIN, and then press [OK].

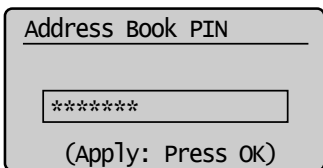

- (3) Press [▲] or [▼] to select a destination that you want to edit, and then press [OK].



- (4) Press [▲] or [▼] to select an item that you want to edit, and then press [OK].

- Name
- Destination
- Coded Dial

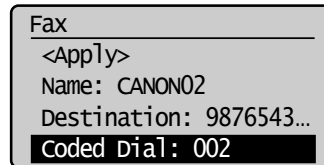

- (5) When you finish editing, press [▲] or [▼] to select <Apply>, and then press [OK].
 (6) Press [▲] or [▼] to select <Apply>, and then press [OK].

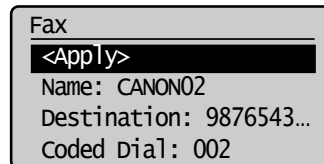

● **Deleting a coded dial code**

- (1) Press [◀].

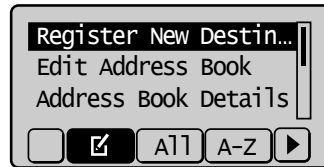

- (2) Press [▲] or [▼] to select <Delete From Address Book>, and then press [OK].

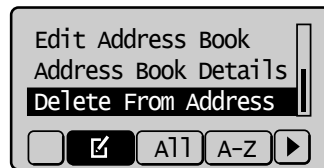

When the address book PIN is specified

Use the numeric keys to enter the PIN, and then press [OK].

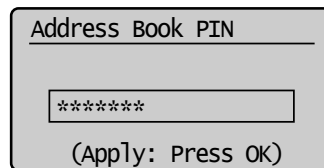

- (3) Press [▲] or [▼] to select a destination that you want to delete, and then press [OK].

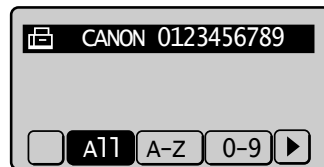

- (4) Press [◀] to select <Yes>, and then press [OK].

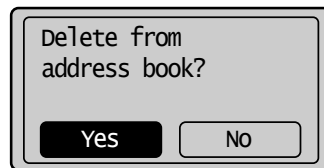

- 3** Press [○] (Back) to close the menu screen.

Registering and Editing a coded Dial Code via the Remote UI

- 1 Start the web browser.
- 2 Enter "http://<the IP address of the machine>/" in the address field, and then press the [ENTER] key on your keyboard.

Input Example: "http://192.168.0.215/"

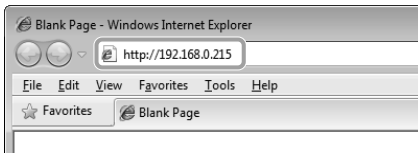

- 3 Log on to the Remote UI.

- (1) Select [System Manager Mode].
- (2) Enter [System Manager PIN].
- (3) Click [OK].

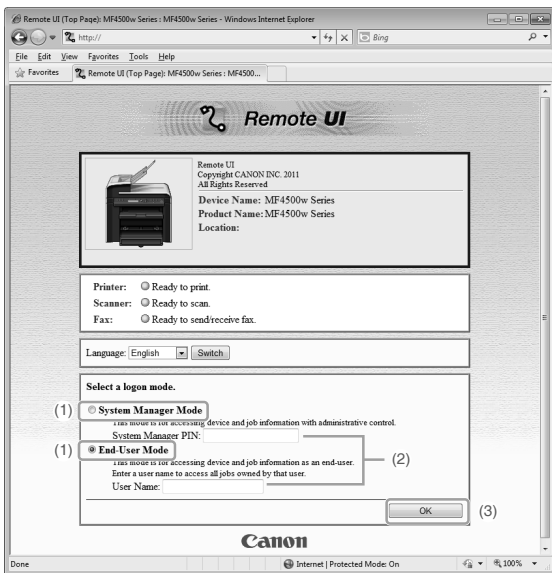

- 4 Click [Address] → [Coded Dial].

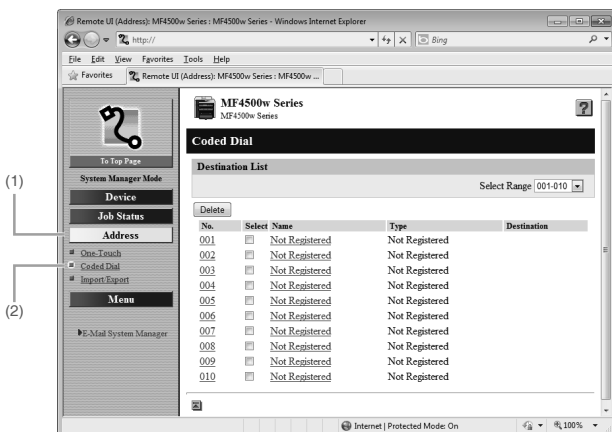

- Storing a coded dial code newly
Proceed to Step 5.

- Editing a coded dial code
 - (1) Click the number or name.
 - (2) Click [Edit].
 - (3) Specify the required settings in the edit screen for destinations, and then click [OK].

- Deleting a coded dial code
 - (1) Select the check box for which you want to delete the number, and then click [Delete].

- 5 Click [Not Registered] or the number which is not registered.

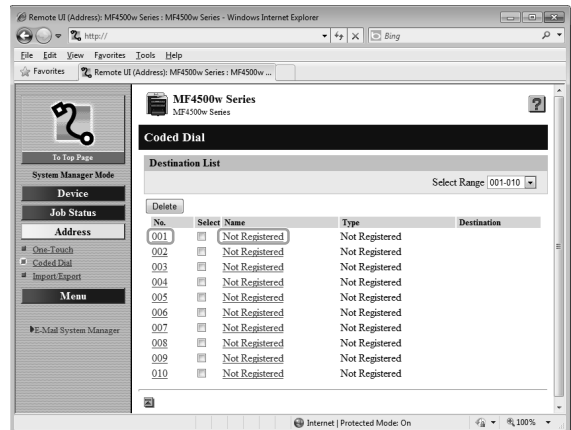

- 6 Select [Fax] from the drop-down list.

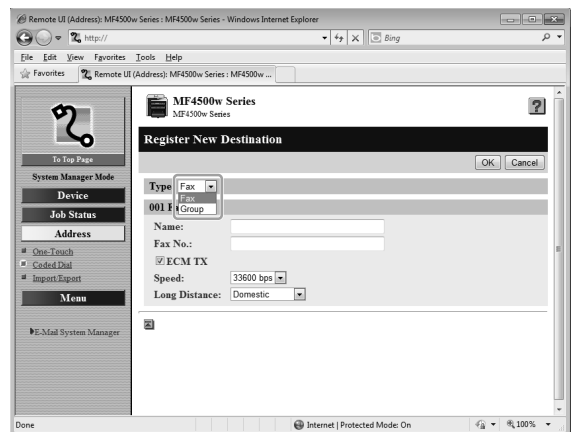

- 7 Specify the required settings, and then click [OK].

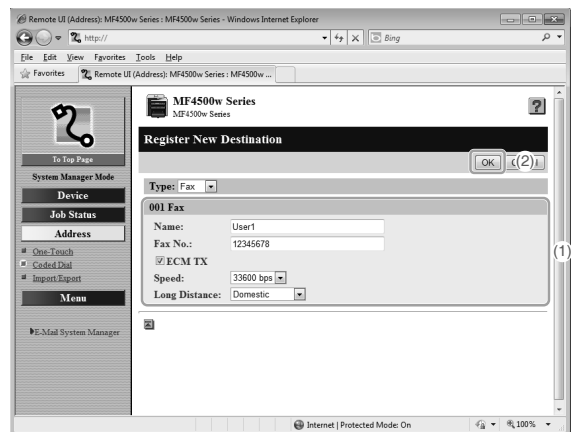

Registering and Editing Recipients for Group Dialing

You can perform the following procedures.

- Registering group addresses
- Adding a recipient to group addresses
- Deleting a recipient from group addresses
- Changing a group name
- Deleting group addresses



IMPORTANT

Before registering group addresses

- Register group addresses for an unused one-touch key or coded dial codes. Keep a one-touch key or coded dial available for group dialing.
- Recipients must be registered to one-touch keys or coded dial codes before they can be added to a group.

Registering and Editing a Destination Group via the Operation Panel

Keys to be used for this operation

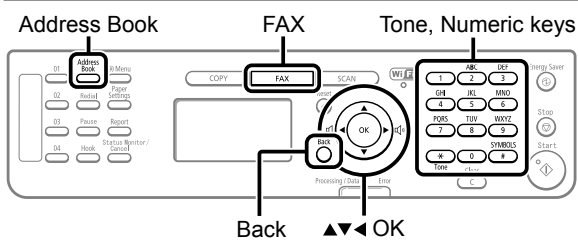

1 Press [**FAX**].

2 Press [**Address Book**] (Address Book).

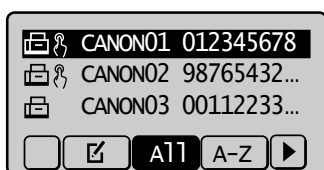

Registering group addresses newly

- (1) Press [**Left Arrow**].
- (2) Press [**Up Arrow**] or [**Down Arrow**] to select <Register New Destination to Address Book>, and then press [OK].

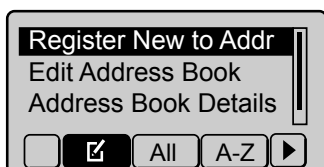

When the address book PIN is specified

Use the numeric keys to enter the PIN, and then press [OK].

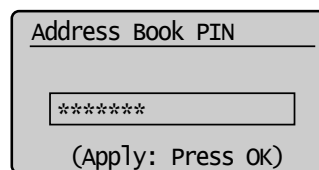

- (3) Press [**Up Arrow**] or [**Down Arrow**] to select <One-Touch> or <Coded Dial>, and then press [OK].

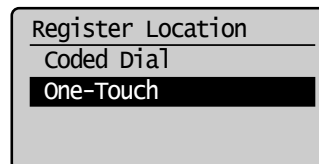

- (4) Press [**Up Arrow**] or [**Down Arrow**] to select <Group>, and then press [OK].

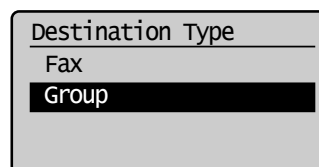

- (5) If you selected <One-Touch> in Step (3), press [**Up Arrow**] or [**Down Arrow**] to select the number to be registered, and then press [OK].

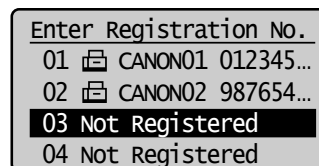

- (6) Press [**Up Arrow**] or [**Down Arrow**] to select <Name>, and then press [OK].

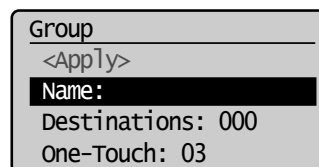

- (7) Use the numeric keys to specify <Name>.
 - ▶ "Text Input Method" (→P.1-9)

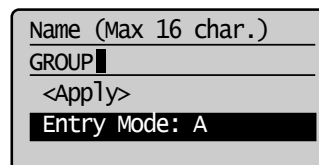

- (8) Press [**Up Arrow**] or [**Down Arrow**] to select <Apply>, and then press [OK].

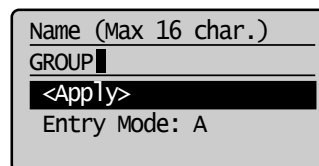

- (9) Press [▲] or [▼] to select <Destinations>, and then press [OK].

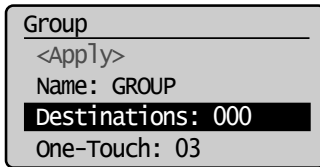

- (10) Press [▲] or [▼] to select <Add>, and then press [OK].

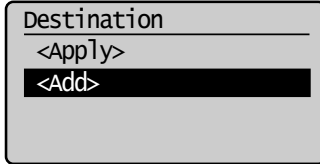

- (11) Press [▲] or [▼] to select a destination that you want to add, and then press [OK].

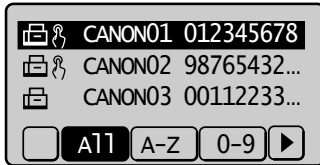

- (12) Repeat Step (10) and (11) to select the destinations to be added.
 (13) Press [▲] or [▼] to select <Apply>, and then press [OK].

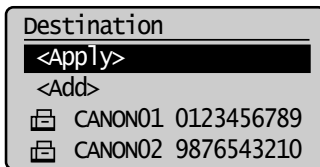

- (14) Press [▲] or [▼] to select <Apply>, and then press [OK].

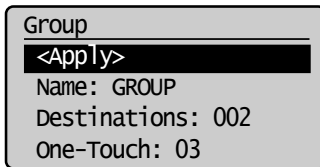

● **Adding destinations to a group**

- (1) Press [◀].
 (2) Press [▲] or [▼] to select <Edit Address Book>, and then press [OK].

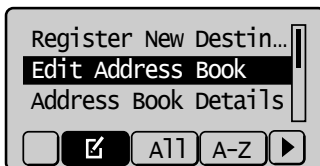

When the address book PIN is specified

Use the numeric keys to enter the PIN, and then press [OK].

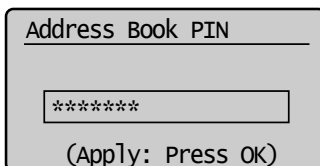

- (3) Press [▲] or [▼] to select a group to which destinations are added, and then press [OK].

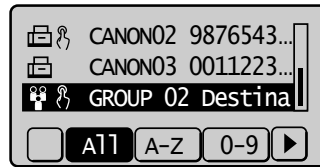

- (4) Press [▲] or [▼] to select <Destinations>, and then press [OK].

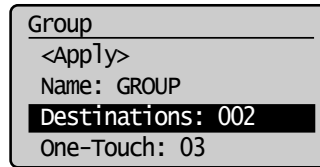

- (5) Press [▲] or [▼] to select <Add>, and then press [OK].

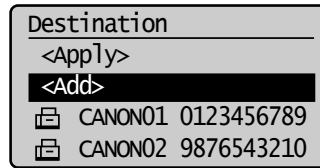

- (6) Press [▲] or [▼] to select a destination to be added, and then press [OK].



- (7) Press [▲] or [▼] to select <Apply>, and then press [OK].

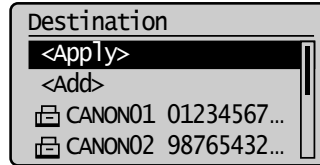

- (8) Press [▲] or [▼] to select <Apply>, and then press [OK].

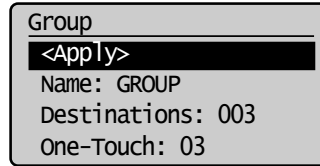

● Deleting destinations from a group

- (1) Press [◀].
- (2) Press [▲] or [▼] to select <Edit Address Book>, and then press [OK].

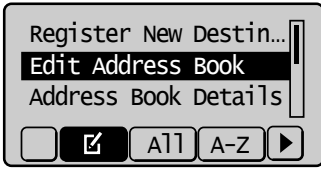

When the address book PIN is specified

Use the numeric keys to enter the PIN, and then press [OK].

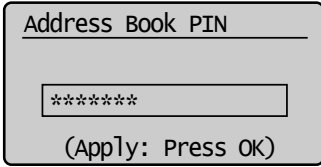

- (3) Press [▲] or [▼] to select a group in which destinations are deleted, and then press [OK].



- (4) Press [▲] or [▼] to select <Destinations>, and then press [OK].

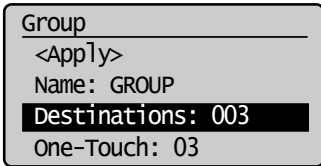

- (5) Press [▲] or [▼] to select a destination to be deleted, and then press [OK].

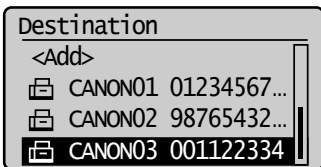

- (6) Press [▲] or [▼] to select <Delete From Group>, and then press [OK].

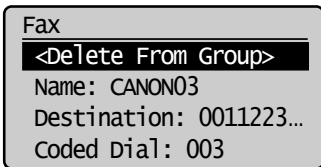

- (7) Press [◀] to select <Yes>, and then press [OK].

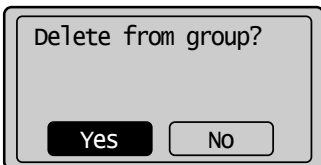

- (8) Press [▲] or [▼] to select <Apply>, and then press [OK].

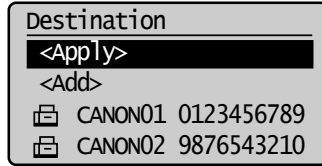

- (9) Press [▲] or [▼] to select <Apply>, and then press [OK].

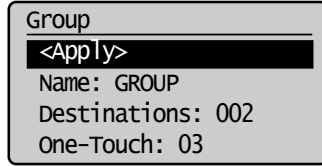

● Changing the name of a group

- (1) Press [◀].
- (2) Press [▲] or [▼] to select <Edit Address Book>, and then press [OK].

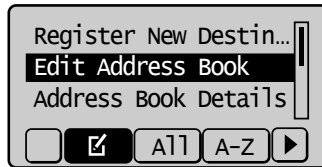

When the address book PIN is specified

Use the numeric keys to enter the PIN, and then press [OK].

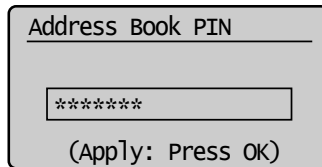

- (3) Press [▲] or [▼] to select a group for which the group name is changed, and then press [OK].



- (4) Press [▲] or [▼] to select <Name>, and then press [OK].

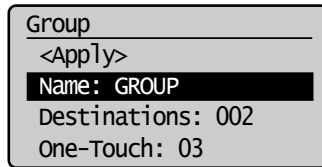

- (5) Change <Name>.
 ▶ "Text Input Method" (→P.1-9)

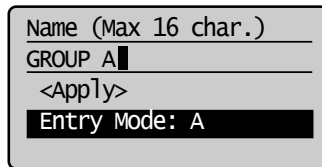

- (6) Press [▲] or [▼] to select <Apply>, and then press [OK].

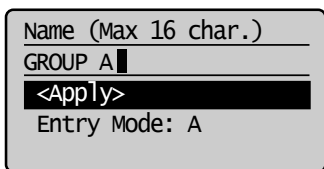

- (7) Press [▲] or [▼] to select <Apply>, and then press [OK].

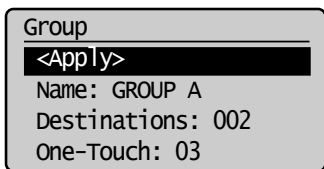

● Deleting a group

- (1) Press [◀].
- (2) Press [▲] or [▼] to select <Delete From Address Book>, and then press [OK].

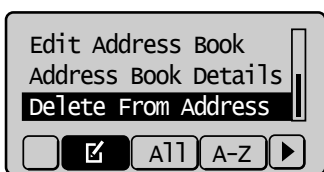

When the address book PIN is specified

Use the numeric keys to enter the PIN, and then press [OK].

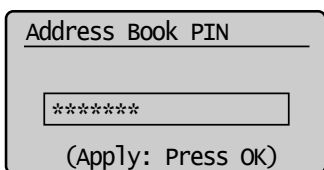

- (3) Press [▲] or [▼] to select a group that you want to delete, and then press [OK].



- (4) Press [◀] to select <Yes>, and then press [OK].

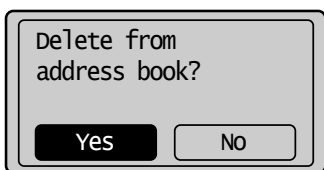

- 3** Press [○] (Back) to close the menu screen.

Registering and Editing a Destination Group via the Remote UI

- 1** Start the web browser.
- 2** Enter "http://<the IP address of the machine>/" in the address field, and then press the [ENTER] key on your keyboard.

Input Example: "http://192.168.0.215/"

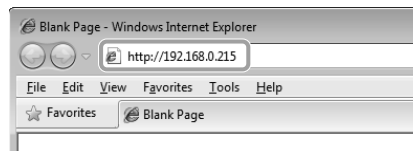

- 3** Log on to the Remote UI.

- (1) Select [System Manager Mode].
- (2) Enter [System Manager PIN].
- (3) Click [OK].

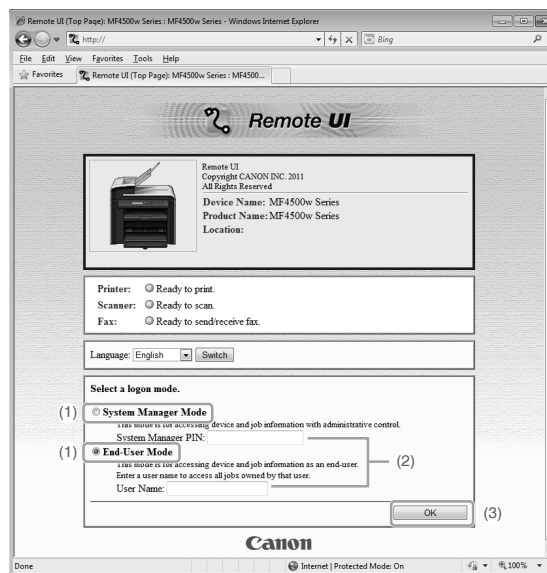

- 4** Click [Address] → [One-Touch] or [Coded Dial].

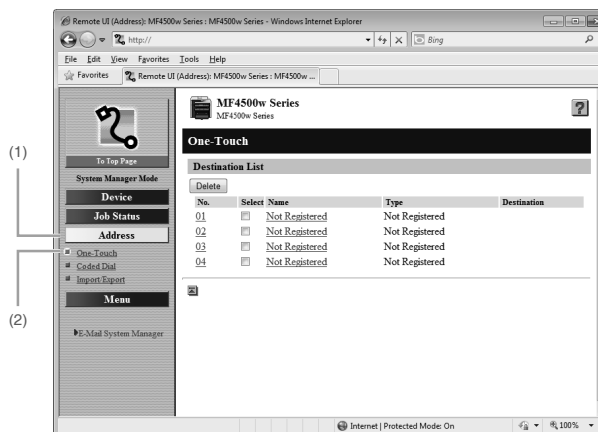

- Registering group addresses newly**
Proceed to Step 5.

● **Adding destinations to a group**

- (1) Click the number or name.
- (2) Click [Edit].
- (3) Click [Address Book].
- (4) Click [One-Touch] or [Coded Dial] from the drop-down list, select the check box for the number to be added in a group, and then click [OK].

● **Deleting a destination from a group**

- (1) Click the number or name.
- (2) Click [Edit].
- (3) Select the destination from [Members List] to be deleted, and then click [Delete].
- (4) Click [OK].

● **Changing the name of a group**

- (1) Click the number or name.
- (2) Click [Edit].
- (3) Change a name of [Group Name], and then click [OK].

● **Deleting a destination from a group**

- (1) Select the check box for which you want to delete the number, and then click [Delete].

5 Click [Not Registered] or the number which is not registered.

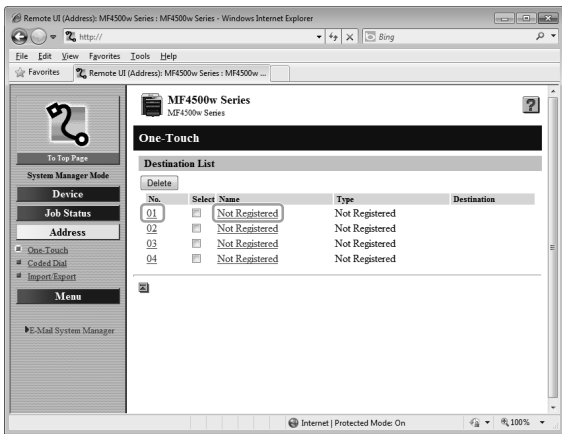

6 Select [Group] from the drop-down list.



7 Enter a name in [Group Name], and then click [Address Book].



8 Click [One-Touch] or [Coded Dial] from the drop-down list, select the check box for the number to be registered in a group, and then click [OK].

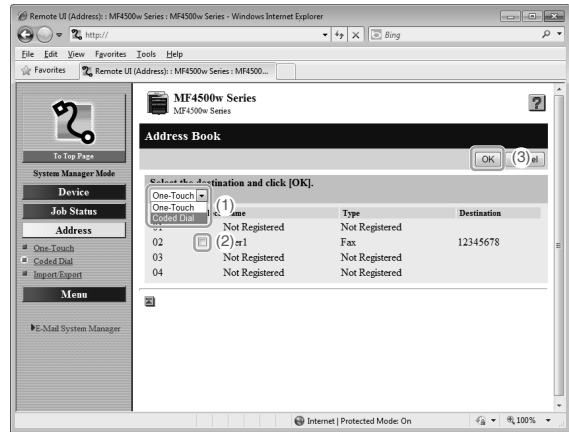

9 Check if the registered destinations are displayed in [Members List], and then click [OK].

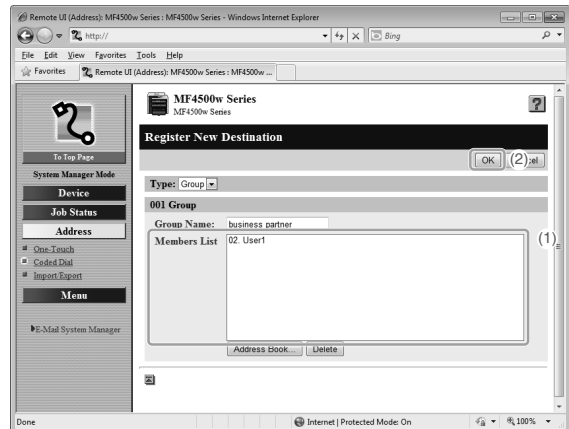

Using the Fax Functions

This section describes the procedure for using the fax functions.

Basic Method for Sending Faxes	6-2	Changing the Fax Settings (Items Specified Using the [Menu] Button)	6-19
Fax Settings	6-3	Setting Procedure for Sending Faxes	6-19
Image Quality Settings	6-3	Setting Items	6-19
Density Settings	6-3	Register Unit Name	6-20
Sharpness Settings	6-3	Register Unit Telephone Number	6-20
Specifying Destinations	6-4	Select Line Type	6-20
Specifying Destinations by Entering a Fax Number	6-4	Public Line Connection	6-20
Specifying Destinations with the One-Touch Keys	6-4	Off-Hook Alarm	6-20
Specifying Destinations Using Coded Dialing	6-4	Sender ID	6-20
Specifying Destinations Using Group Dialing	6-5	Change Defaults	6-20
Specifying Destinations Using the Address Book	6-5	ECM TX	6-20
Redialing (Manual Redialing)	6-6	Pause Time	6-21
Useful Fax Sending Methods	6-7	Auto Redial	6-21
Sending a Fax after Making a Phone Call (Manual Sending)	6-7	Check Dial Tone Before Sending	6-21
Push-button Telephone Service Using a Dial-line	6-7	Setting Procedure for Receiving Faxes	6-21
Sending a Fax Abroad (Adding Pauses)	6-8	Setting Items for the Receive Settings	6-22
Sending to Multiple Destinations at a Time (Sequential Broadcast)	6-9	2-Sided Printing	6-22
Receiving Faxes	6-10	Reduce RX Size	6-22
Receive Mode	6-10	RX Page Footer	6-22
Changing the Receive Mode	6-12	Continue Print When Toner Is Nearly Out	6-22
Detailed Settings for the Fax/Tel Auto Switch Mode	6-13	ECM RX	6-22
Forwarding Received Fax Documents in Memory to Other Destinations (Manual Forwarding)	6-14	Incoming Ring	6-23
Checking and Managing Fax Documents in Memory	6-15	Remote RX	6-23
Checking and Canceling Fax Jobs	6-15	Auto RX Switch	6-23
Printing Received Fax Documents	6-15	System Settings Procedure	6-23
Checking and Deleting Received Fax Documents	6-16	Setting Items	6-24
Checking the History of Received/Sent Fax Documents	6-17	TX Start Speed	6-24
Changing the Default Values for Fax	6-18	RX Start Speed	6-24
		Memory Lock Settings	6-24
		Select Country/Region	6-24
		Address Book PIN	6-25
		Restrict New Destinations	6-25
		Allow Driver Faxing	6-25
		Restrict Sending From History	6-25
		Fax No. Confirmation Re-Entry	6-25
		Restrict Sequential Broadcast	6-25
		Canceling Fax Jobs	6-26

Basic Method for Sending Faxes

This section describes the basic procedure for sending faxes.

1 Place documents.

- ▶ "Placing Documents" (→P.2-4)
- ▶ "Document Requirements" (→P.2-2)

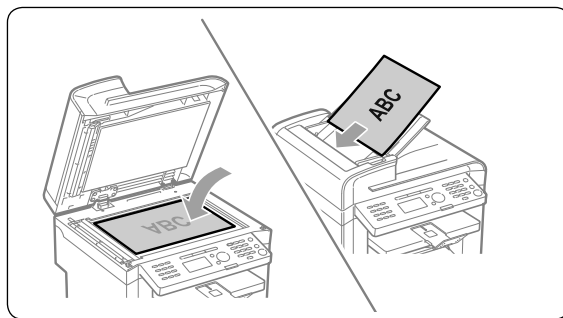

2 Press [FAX] .

4 Specify the destination.

These are the following methods to specify a destination.
(For details, see P.6-4 to 6-5.)

- 1 Entering the fax number
- 2 One-touch keys
- 3 Coded dialing
- 4 Group dialing
- 5 Address book - Sequential broadcast (→P.6-9)

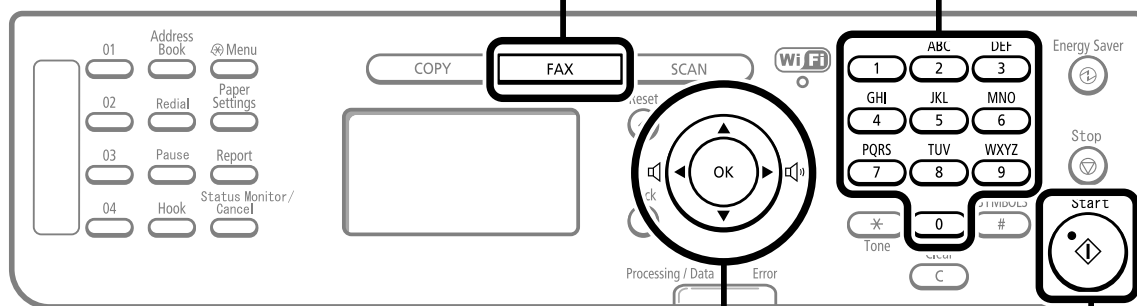

3 Set scanning settings for documents as needed.

There are the three items you can specify.
(For details, see P.6-3.)

- 1 Image Quality Settings
- 2 Density Settings
- 3 Sharpness Settings

The settings specified here are effective only for the current sending operation. To make the settings effective for all the fax operations, see "Changing the Default Values for Fax" (→P.6-18).

5 Press [Start] (Start).

When placing documents in the feeder

Document scanning is started. The fax is sent when the scanning is finished.

When placing documents on the platen glass

Perform the following procedure.

- (1) Press [▲] or [▼] to select the size of the original document, and then press [OK].
- (2) Press [Start] (Start) for each document.
- (3) When all documents are scanned completely, select <Start Sending>, and then press [OK].

Fax Settings

1 Image Quality Settings

Fax mode screen

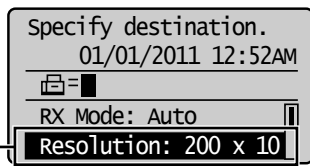

Press [▲] or [▼] to select <Resolution>.

Setting screen

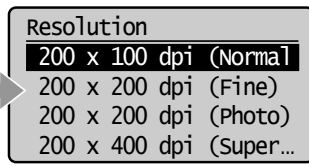

Specify the scanning resolution. Higher resolutions will result in better image quality, but also longer transmission times.

<200 dpi x 100 dpi (Normal)>	For text documents
<200 dpi x 200 dpi (Fine)>	For fine text documents
<200 dpi x 400 dpi (Superfine)>	Achieves an even finer resolution than (Fine)
<200 dpi x 200 dpi (Photo)>	For documents that contain photographs

2 Density Settings

Fax mode screen

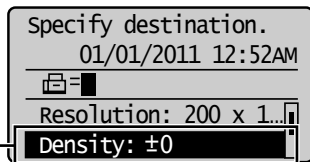

Press [▲] or [▼] to select <Density>.

Setting screen

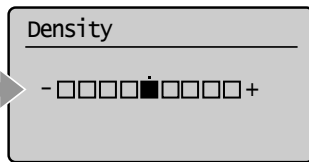

Specify the scanning density.

[◀]	Makes the scanning density lighter.
[▶]	Makes the scanning density darker.

3 Sharpness Settings

Fax mode screen

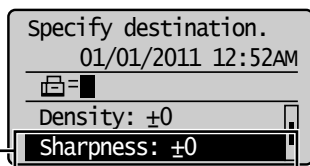

Press [▲] or [▼] to select <Sharpness>.

Setting screen

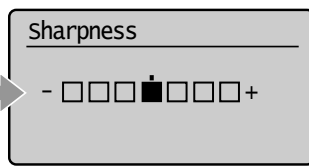

You can emphasize the outline of the image in the document or decrease the contrast.

[◀]	If you want to clearly scan halftone images adjust the sharpness to <->. This can reduce the moire effect (patchy patterns called "moire").
[▶]	If you want to clearly scan text or lines, adjust the sharpness to <+>. This is appropriate for scanning documents with fine markings, such as blueprint or thinly penciled documents.

Specifying Destinations

Specifying Destinations

1 Specifying Destinations by Entering a Fax Number

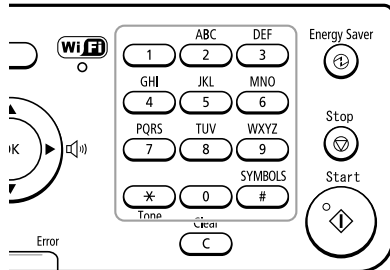

Specify the fax number with the numeric keys, [*] (Tone), and [#] (SYMBOLS).

Correcting destinations

- To cancel a destination
Press and hold [C] (Clear).
- To delete the last character of a destination
Press [C] (Clear).

2 Specifying Destinations with the One-Touch Keys

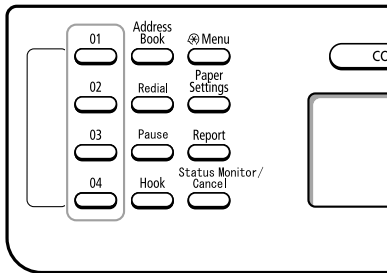

Press the one-touch key (01 to 04) of the destination.

To use this feature, you need to pre-register destinations in one-touch keys.
▶ "Registering and Editing One-Touch Keys" (→P.5-3)

If you press an incorrect key

- (1) Press [C] (Clear).
 - (2) Press [◀] to select <Yes>, and then press [OK].
- * If you want to repeat the procedure from specifying the settings for the document scanning, press [⌂] (Reset).

3 Specifying Destinations Using Coded Dialing

Fax mode screen

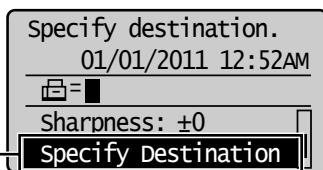

Press [▲] or [▼] to select <Specify Destination>.



Setting screen

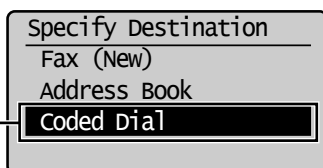

Press [▲] or [▼] to select <Coded Dial>.

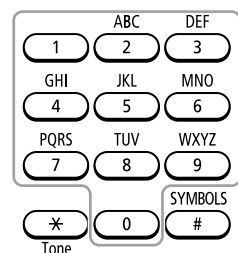
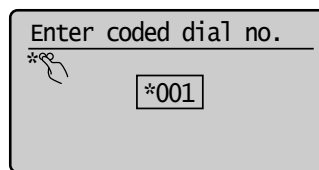

Enter the three-digit registration number (001 to 100) with the numeric keys.

To use this feature, you need to pre-register destinations in coded dials.
▶ "Registering and Editing One-Touch Keys" (→P. 5-3)

If you press an incorrect key

- (1) Press [C] (Clear).
 - (2) Press [◀] to select <Yes>, and then press [OK].
- * If you want to repeat the procedure from specifying the settings for the document scanning, press [⌂] (Reset).

Specifying Destinations

4 Specifying Destinations Using Group Dialing

● **When the numbers are registered in a one-touch key**
Press the one-touch key (01 to 04) assigned to the group.

● **When the numbers are registered in a coded dial code**

Fax mode screen

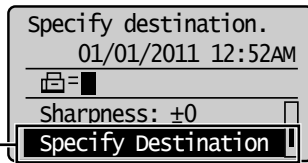

Press [▲] or [▼] to select <Specify Destination>.



Setting screen

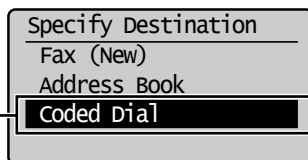

Press [▲] or [▼] to select <Coded Dial>.

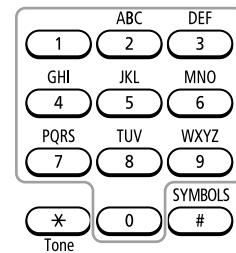
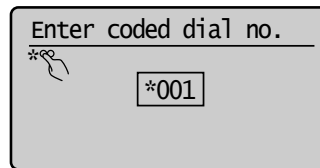
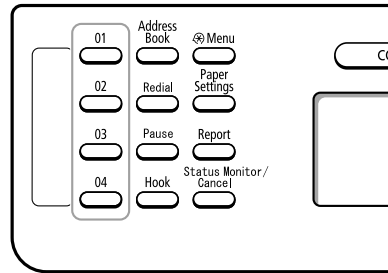

Enter the three-digit registration number (001 to 100) with the numeric keys.

To use this feature, you need to pre-register destinations in coded dials.

"Registering and Editing Recipients for Group Dialing" (→P.5-9)

If you press an incorrect key

- (1) Press [C] (Clear).
 - (2) Press [◀] to select <Yes>, and then press [OK].
- * If you want to repeat the procedure from specifying the settings for the document scanning, press [⌂] (Reset).

5 Specifying Destinations Using the Address Book

After entering the characters from the operation panel and searching the abbreviation of destinations from the registered address book (one-touch keys, coded dial, or group dialing), the destinations to be specified appear on the display. You can specify the displayed address as a destination.

To use this feature, you need to pre-register destinations in the address book.

"Registering Destinations in the Address Book" (→P.5-1)

1 Press [] (Address Book).

2 Press [◀] or [▶] to select search for the recipient.

- Select <All> to displays all the recipients.
- Select at the bottom left of the screen to add or edit recipients.

"Registering Destinations in the Address Book" (→P.5-1)

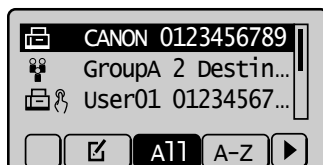

3 Press [▲] or [▼] to select a recipient, and then press [OK].

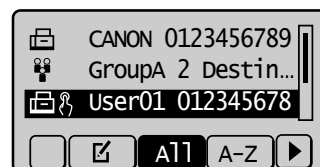

Redialing (Manual Redialing)

To redial a number, follow the procedures below.

Keys to be used for this operation

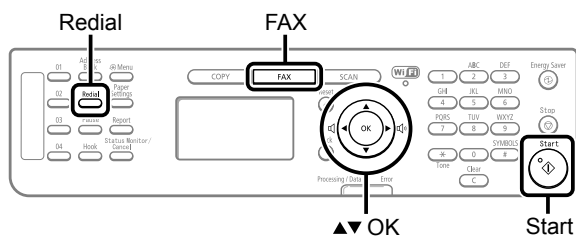

1 Place documents.

- ▶ "Placing Documents" (→P.2-4)
- ▶ "Document Requirements" (→P.2-2)

2 Press [**FAX**].

3 Press [] (Redial).

4 Press [] or [] to select a recipient, and then press [**OK**].

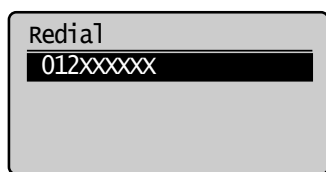

5 Press [] (Start).



NOTE

Destinations that can be redialed

- A destination entered with the numeric keys
(You may not redial multiple destinations when entering destinations with the numeric keys.)
- Up to the last three destinations
(Only the last destination when using [] (Hook))

when sending from history is restricted

Redialing is not available.

- ▶ "Restrict Sending From History" (→P.6-25)

When turning this machine OFF

Recently dialed numbers are cleared.

When sending by automatic redialing

- ▶ "Auto Redial" (→P.6-21)

Useful Fax Sending Methods

Sending a Fax after Making a Phone Call (Manual Sending)

Send a fax manually in the following cases.

- If you want to make a phone call before sending fax documents
- If the recipient's fax machine cannot automatically receive faxes

Keys to be used for this operation

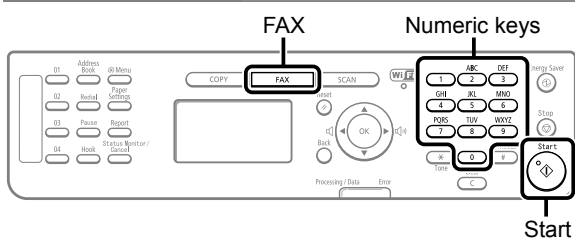

1 Connect an external telephone to this machine.

For details on connecting, see the following.

- ☞ e-Manual → Setting Up the Machine → Specifying Initial Fax Settings and Connecting a Telephone Cable → Connecting a Telephone Line

2 Place documents in the feeder.

- ☞ "Placing Documents" (→P.2-4)
- ☞ "Document Requirements" (→P.2-2)

3 Press [**FAX**].

4 Set scanning settings for documents as needed.

- ☞ "Fax Settings" (→P.6-3)

5 Check the dial tone via the handset of the external telephone.

The dial tone sounds.

6 Dial the recipient's fax number.

7 Talk through the handset to the recipient.

When you hear a beep, proceed to Step 9.

8 Ask the recipient to set their fax machine to receive faxes.

9 When you hear a beep, press [**Start**], and hang up the handset.

After completing the scanning, you can send the fax documents.



NOTE

Restrictions for manual sending

- Scanning from the platen glass is not available.
- The group dialing function is not available.
- Scanning 2-sided documents is not available. (Only one side of the documents will be scanned.)

Check the dial tone before entering a fax number.

If you enter the number before checking the dial tone, the call may not be connected or the wrong number may be dialed.

Push-button Telephone Service Using a Dial-line

Some types of push-button telephone services require the availability of a push-button line (e.g., banks, airline reservations, and hotel reservations). If this machine is connected using a dial-line, you can send the tone signal temporarily using the following procedures.

Keys to be used for this operation

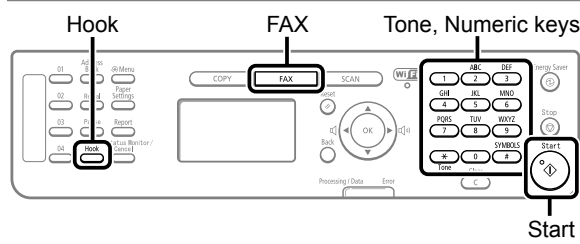

1 Press [**FAX**].

2 Press [**Hook**], and check the dial tone.

The dial tone sounds.

3 Use the numeric keys to dial the desired information service.

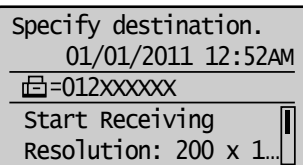

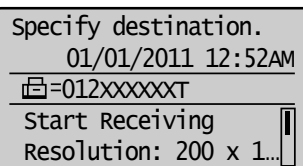

4 After responding to the recorded message of the information service, press [*** (Tone)**].

You can switch to the tone signal.

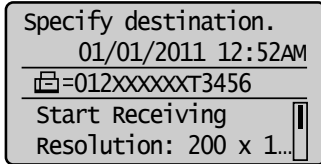

- 5** Use the numeric keys to enter the required numbers for the information service.



- 6** If you want to receive faxes, press [] (Start).



NOTE

Telephone call

The external telephone must be connected to this machine.

Check the dial tone before entering a fax number.

If you enter the number before checking the dial tone, the call may not be connected or the wrong number may be dialed.

Sending a Fax Abroad (Adding Pauses)

When sending a fax abroad, you may need to insert a pause within the number.

When communicating abroad, the signal distance is extreme and the signal route complicated. Because of this, you may not be able to connect to a recipient by dialing an international telephone identification number, country code, and the recipient's fax number at the same time. In this case, add a pause after the international telephone identification number. Because adding a pause provides a point where wait time can be added when dialing, it is easier to connect to the recipient.

Keys to be used for this operation

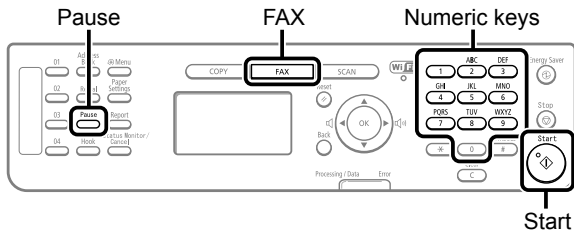



- 1** Place documents.
 - ▶ "Placing Documents" (→P.2-4)
 - ▶ "Document Requirements" (→P.2-2)
- 2** Press [].
- 3** Set scanning settings for documents as needed.
 - ▶ "Fax Settings" (→P.6-3)

- 4** Use the numeric keys to enter the international access code.

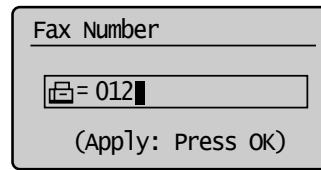
For details on international access codes, contact your telephone company.



- 5** Press [] (Pause) to enter a pause as needed.

- The letter <p> indicating a pause is displayed.
- The default pause is two seconds*. To change the pause time, see "Pause Time" (→P.6-21).
- When you are adding pauses consecutively, press [] (Pause) again.

* The default value varies depending on the country where you are using the machine.

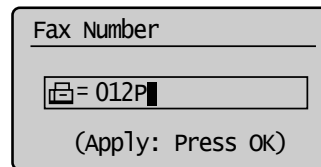

- 6** Enter the country code, the area code, and the fax/telephone number using the numeric keys.

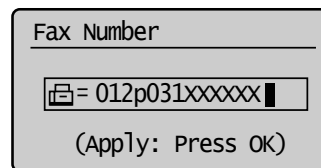

- 7** Press [] (Pause) to add a pause at the end of the fax/telephone number as needed.

- The letter <P> is displayed at the end of the fax number.
- The pause added to the end of the number is fixed at 10 seconds.

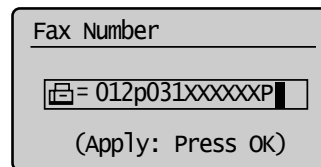

- 8** Press [] (Start).

Sending to Multiple Destinations at a Time (Sequential Broadcast)

You can send the same document to multiple destinations.

Keys to be used for this operation

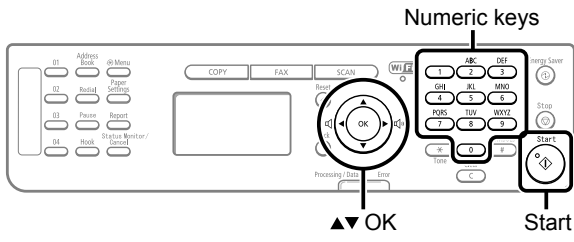

1 Place documents.

- ☞ "Placing Documents" (→P.2-4)
- ☞ "Document Requirements" (→P.2-2)

2 Press [▲] or [▼] to select <Specify Destination>, and then press [OK].

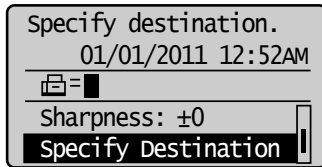

3 Press [▲] or [▼] to select a method for specifying destinations, and then press [OK].

- Fax (New)
- Address Book
- Coded Dial
- ☞ "Specifying Destinations" (→P.6-4)

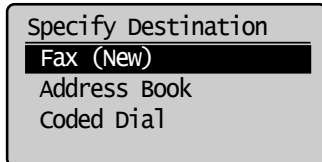

4 Repeat Step 2 and 3 to enter all the destinations.

5 Press [Start] (Start).



NOTE

The number of destinations capable of sequential broadcast

You can select destinations in the following combinations.

- Specifying destinations using numeric keys: Up to 10 destinations
- One-touch keys: Up to 4 destinations
- Coded dial codes: Up to 100 destinations

When specifying destinations using the numeric keys

Enter the numbers, and then press [OK].

When checking the specified destinations

Press [▲] or [▼] to select <Confirm/Edit Destination>, and then press [OK].

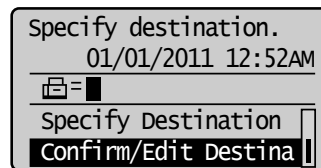

Receiving Faxes

This section describes the procedure for receiving faxes.

Receive Mode

Your machine provides multiple methods for automatically or manually receiving faxes. To select the receive mode that best suits your needs, refer to the flowcharts that follow. The default receive setting is <Auto> mode.

Auto mode

Receives faxes automatically.
The receiving method depends on whether an external telephone is connected.

Operation for when an incoming call is received

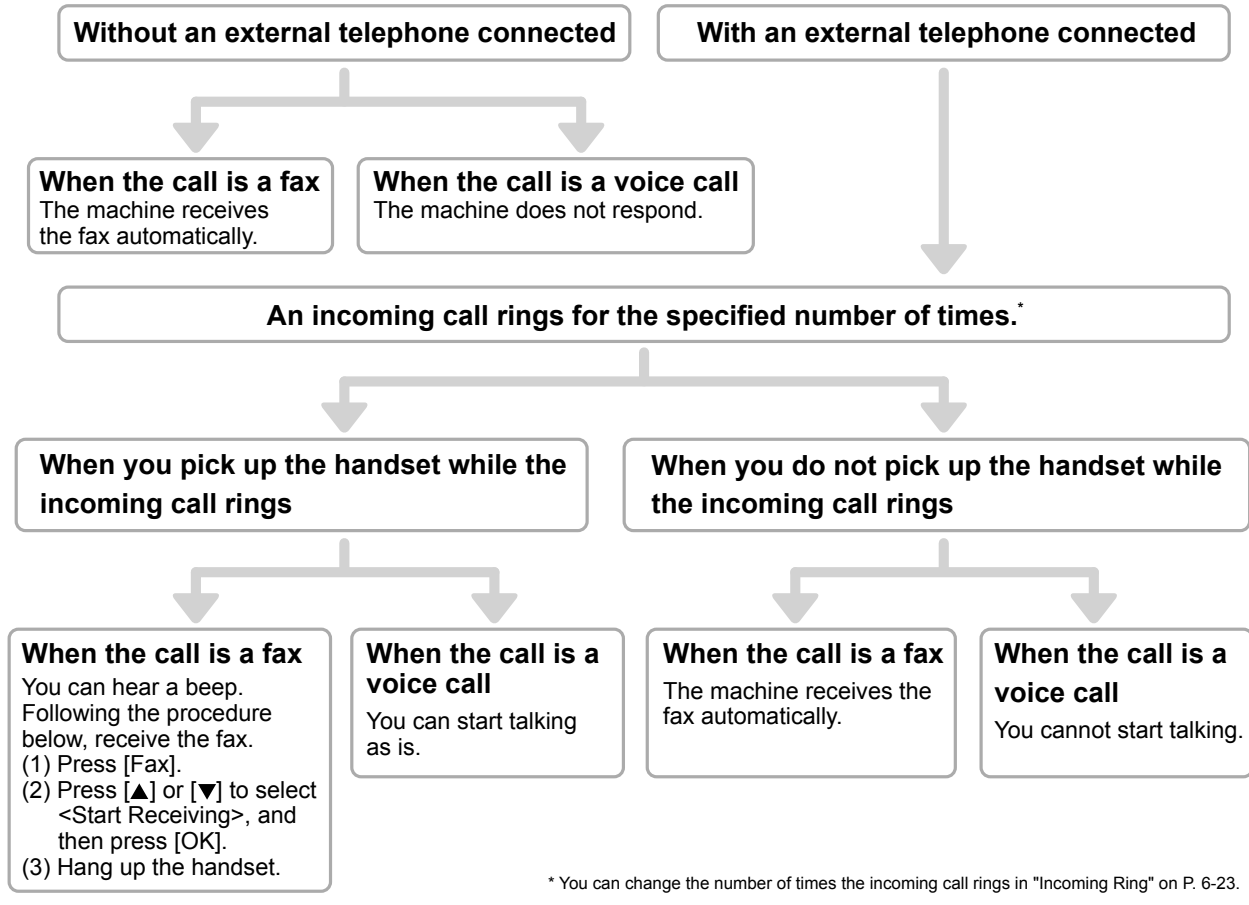

Fax/Tel Auto Switch mode

Receives faxes automatically. (When a call comes in, the telephone will ring. To disable the incoming ring, see "Incoming Ring" (→P.6-23))
Respond to a telephone call by picking up the handset.

Operation for when an incoming call is received

An incoming call rings for the specified number of times.^{*1}

When you do not pick up the handset within the specified number of times

When you pick up the handset within the specified number of times

The machine judges whether the incoming call is a fax or voice call.^{*2}

When the call is a fax

You can hear a beep. Following the procedure below, receive the fax.
(1) Press [Fax].
(2) Press [▲] or [▼] to select <Start Receiving>, and then press [OK].
(3) Hang up the handset.

When the call is a voice call

You can start talking as is.

When the call is a fax

The machine receives the fax automatically.

When the call is a voice call

The telephone rings.^{*3}

When you pick up the handset during ringing

You can start talking as is.

When you do not pick up the handset during ringing

The machine hangs up the telephone or switches to the fax receive mode.^{*4}

^{*1} You can change the number of times the incoming ringing in "Incoming Ring" on P. 6-23.

^{*2} To adjust the delay before the telephone rings during an incoming call, set the <Ring Start Time>.

^{*3} To adjust the length of the incoming ring, set the <Incoming Ring Time>.

^{*4} To specify how the machine behaves when you do not answer an incoming call, set the <Action After Ring> option.

For details about the ring start time, incoming ring time, and after ring option, see "Detailed Settings for the Fax/Tel Mode" on P. 6-13.

Answer mode

Receives faxes automatically.
The built-in answering machine will record messages for unanswered incoming calls.

Operation for when an incoming call is received

The telephone rings the number of times specified for the built-in answering machine.^{*1}

When you pick up the handset during ringing

When the built-in answering machine starts up

When the call is a fax

You can hear a beep. Following the procedure below, receive the fax.
(1) Press [Fax].
(2) Press [▲] or [▼] to select <Start Receiving>, and then press [OK].
(3) Hang up the handset.

When the call is a voice call

You can start talking as is.

When the call is a fax

The machine receives the fax automatically.

When the call is a voice call

The built-in answering machine records the message.^{*2}

^{*1} Set your answering machine to answer after a few rings.

^{*2} Record a message on your answering machine. (It is recommended that you insert about 4 seconds of silence at the beginning of the message or limit the message within 20 seconds.)

Manual mode

In manual mode, you must pick up the handset to answer calls or receive faxes.

Use this mode if you expect to receive more incoming telephone calls than faxes or expect to seldom receive faxes.

Operation for when an incoming call is received**The external phone rings.**

When you pick up the handset while the telephone rings

When you do not pick up the handset while the telephone rings

The machine cannot receive a call or fax.¹

When the call is a fax

You can hear a beep. Following the procedure below, receive the fax.²

- (1) Press [Fax].
- (2) Press [▲] or [▼] to select <Start Receiving>, and then press [OK].
- (3) Hang up the handset.

When the call is a voice call

You can start talking as is.

¹ If "Auto RX Switch" (P. 6-23) is set to <On>, the machine switches to the fax receive operation automatically when the machine rings for a certain time.

² When "Remote RX" (P. 6-23) is set, you can also receive fax documents by dialing from your telephone.

DRPD (Distinctive Ring Pattern Detection) mode

The DRPD service allows you to assign distinctive ring patterns for two phone numbers on a single telephone line.

Your machine will automatically monitor incoming calls and, based on the ring pattern, will let you know if the incoming call is a fax or voice call. Set the fax ring pattern that matches the pattern assigned by your telephone company. Contact your telephone company for availability.

Changing the Receive Mode

Select the fax receive mode that best suits your needs.

Keys to be used for this operation

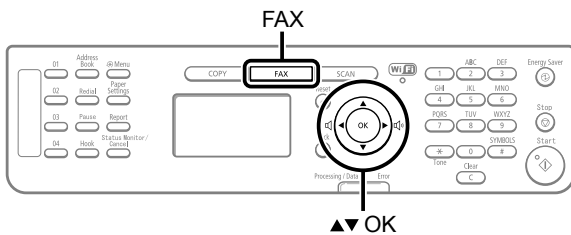

- 1** Press [**FAX**].
- 2** Press [▲] or [▼] to select <RX Mode>, and then press [OK].

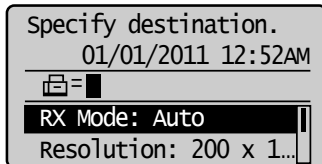

- 3** Press [▲] or [▼] to select a receive mode, and then press [OK].

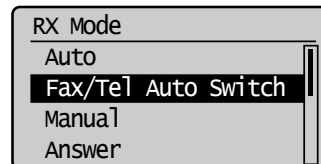
**If you select <Fax/Tel Auto Switch>**

You need to specify the detailed settings. See "Detailed Settings for the Fax/Tel Auto Switch Mode" (→P.6-13) and specify the settings.

If you select <DRPD: Select Fax>

Press [▲] or [▼] to select a ring pattern, and then press [OK].

**NOTE**

Depending on the connected telephone

Sending or receiving may not work properly.

Detailed Settings for the Fax/Tel Auto Switch Mode

Set the ringing time or the operations for the Fax/Tel Auto Switch mode.

Keys to be used for this operation

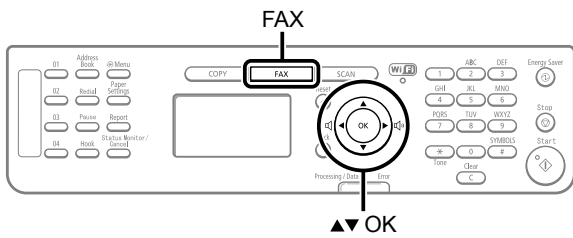

- 1 Press [**FAX**].
- 2 Press [▲] or [▼] to select <RX Mode>, and then press [OK].

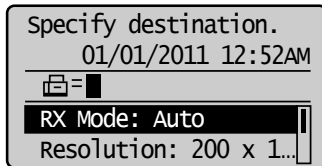

- 3 Press [▲] or [▼] to select <Fax/Tel Auto Switch>, and then press [OK].

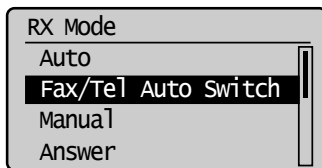

- 4 Press [▲] or [▼] to select an item to be specified, and then press [OK].

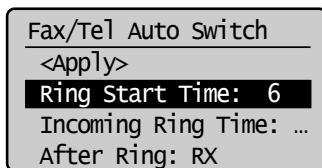

- 5 Press [▲] or [▼] to select <Apply>, and then press [OK].

The receive mode is changed.

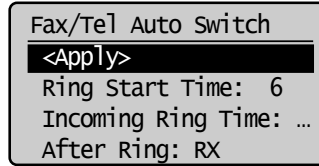



<Ring Start Time>	Specify how long the machine will attempt to detect a fax tone before the handset starts ringing. Specify a duration between 4 seconds and 30 seconds, and then press [OK].
<Incoming Ring Time>	Set how long the handset will ring during an incoming call. Specify a duration between 15 seconds and 300 seconds, and then press [OK].
<After Ring>	Specify how the machine should behave when an incoming call is not answered. Select <End> or <RX>, and then press [OK]. <ul style="list-style-type: none"> - <End>: Disconnects the call. - <RX>: Receives a fax.

Forwarding Received Fax Documents in Memory to Other Destinations (Manual Forwarding)

When a fax is stored in memory, you can manually forward it to a specified destination.

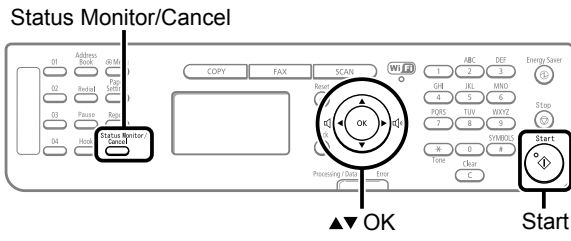
Keys to be used for this operation



- 1 Press [] (Status Monitor/Cancel).
- 2 Press [▲] or [▼] to select <Fax Job Status/History>, and then press [OK].

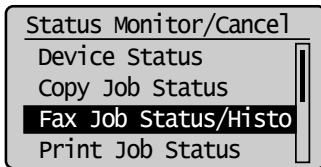

- 3 Press [▲] or [▼] to select <RX Job Status>, and then press [OK].

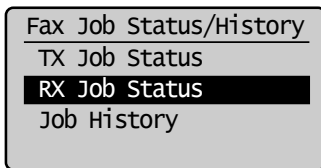

- 4 Press [▲] or [▼] to select a job that you want to forward, and then press [OK].

You cannot forward received faxes during

- a receiving operation
- a normal printing operation after completion of receiving

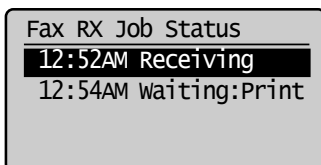

- 5 Press [▲] or [▼] to select <Forward>, and then press [OK].

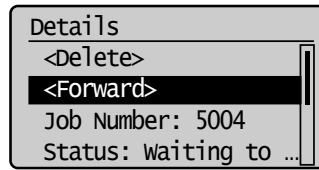

- 6 Specify the forwarding destination.

You can specify the destination via one of the following methods.

- ☑ "Specifying Destinations with the One-Touch Keys" (→P.6-4)
- ☑ "Specifying Destinations Using Coded Dialing" (→P.6-4)
- ☑ "Specifying Destinations Using the Address Book" (→P.6-5)



- 7 Press [OK].

Checking and Managing Fax Documents in Memory

You can check the status of or manage fax documents that are in the machine's memory.

Checking and Canceling Fax Jobs

You can check detailed information about fax jobs currently being sent or received, or waiting to be sent or received. Also, you can also cancel unnecessary jobs (documents).

Keys to be used for this operation

Status Monitor/Cancel

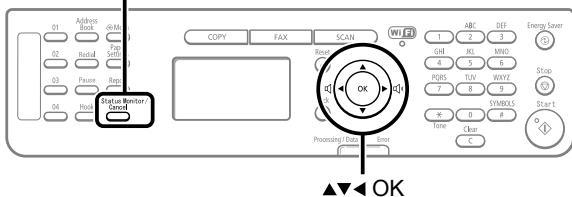

1 Press [] (Status Monitor/Cancel).

2 Press [▲] or [▼] to select <Fax Job Status/History>, and then press [OK].

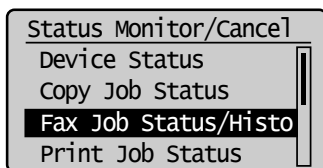

3 Press [▲] or [▼] to select <TX Job Status> or <RX Job Status>, and then press [OK].

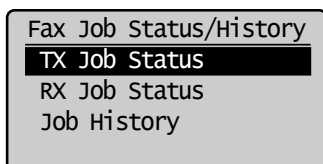

4 Press [▲] or [▼] to select a job to be checked or canceled, and then press [OK].

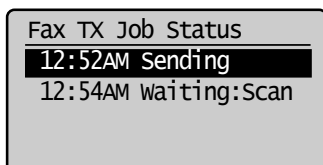

The detailed information is displayed.

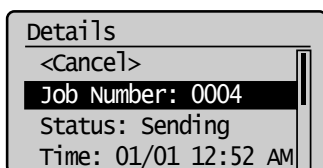

For canceling

(1) Press [▲] or [▼] to select <Cancel>, and then press [OK].

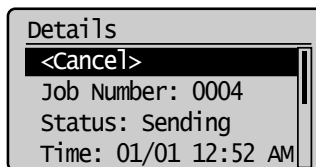

(2) Press [◀] to select <Yes>, and then press [OK].

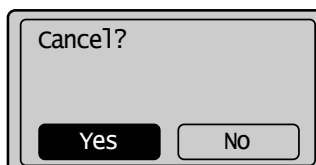



The sending or receiving job is canceled. Fax transmission to all the destinations will be canceled for sequential broadcast.

(3) Press [] (Status Monitor/Cancel) to close the screen.

NOTE

Pressing [] (Stop) can also cancel the fax jobs <h6>

You can cancel the fax job also by pressing [] (Stop).

* If only one job is processing or waiting to be sent or received, you can stop the job by pressing [] (Stop) twice.

For checking only

Press [] (Status Monitor/Cancel) to close the screen.

Printing Received Fax Documents

You can print fax documents saved in the memory.

NOTE

When printing received documents

- You cannot specify a particular document to print. All received faxes that are stored in memory will be printed.
- No preview function is available for stored faxes.

If time is specified in <Memory Lock Time>

Fax documents are printed automatically at <Memory Lock End Time>.

Keys to be used for this operation

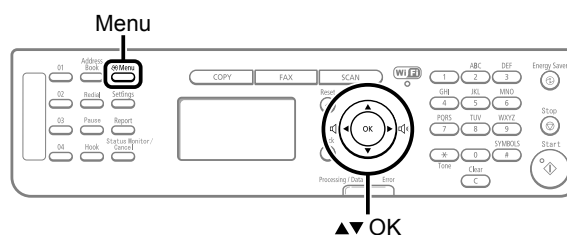

- 1 Press [] (Menu).
- 2 Press [▲] or [▼] to select <System Management Settings>, and then press [OK].

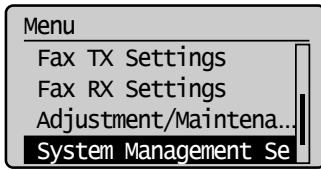

When the system manager PIN is specified

Enter the system manager PIN.

 "Text Input Method" (→P.1-9)

When you finished entering, press [▲] or [▼] to select <Apply>, and then press [OK].

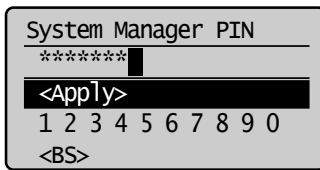

- 3 Press [▲] or [▼] to select <Communication Management Settings>, and then press [OK].

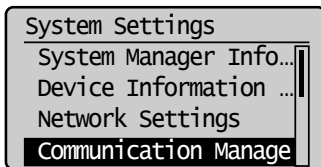

- 4 Press [▲] or [▼] to select <Memory Lock Settings>, and then press [OK].

If <Memory Lock PIN> is specified, use the numeric keys to enter it, and then press [OK].

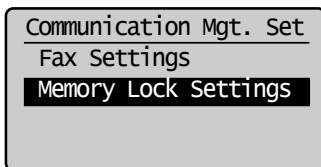

- 5 Press [▲] or [▼] to select <Off>, and then press [OK].

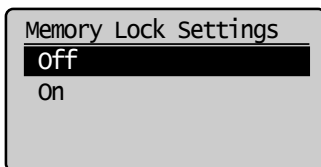

Fax documents saved in the memory are printed.

- 6 Press [] (Menu) to close the menu screen.

Checking and Deleting Received Fax Documents

You can check detailed information about fax documents saved in memory. Also, you can delete unnecessary documents.



Stored documents in memory

You can specify the destination to forward the documents.

 "Forwarding Received Fax Documents in Memory to Other Destinations (Manual Forwarding)" (→P.6-14)

You can print stored documents.

 "Printing Received Fax Documents" (→P.6-15)

Keys to be used for this operation

Status Monitor/Cancel

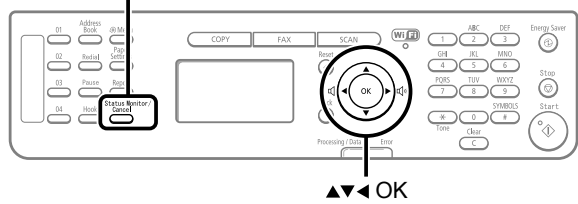

- 1 Press [] (Status Monitor/Cancel).

- 2 Press [▲] or [▼] to select <Fax Job Status/History>, and then press [OK].

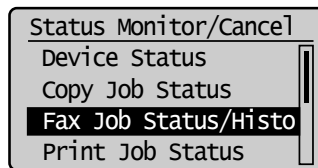

- 3 Press [▲] or [▼] to select <RX Job Status>, and then press [OK].

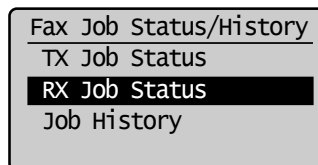

- 4 Press [▲] or [▼] to select a job to be checked or deleted, and then press [OK].

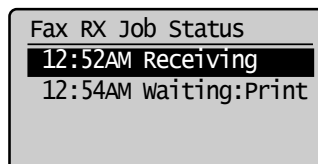

The detailed information is displayed.

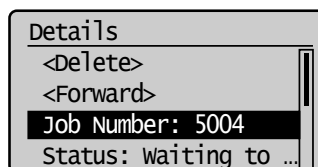

For canceling

(1) Press [▲] or [▼] to select <Delete>, and then press [OK].

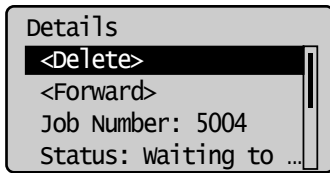

(2) Press [◀] to select <Yes>, and then press [OK].

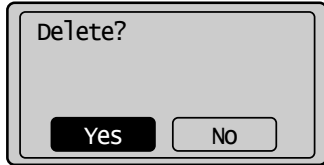

The received job is deleted.

(3) Press [] (Status Monitor/Cancel) to close the screen.

For checking only

Press [] (Status Monitor/Cancel) to close the screen.

Checking the History of Received/Sent Fax Documents

You can check the history of received or sent faxes

Keys to be used for this operation

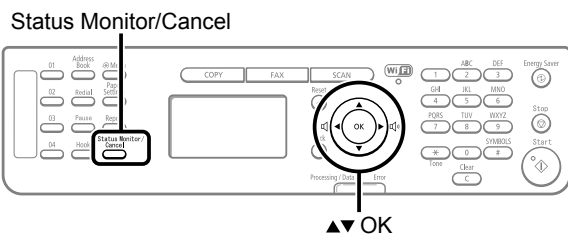

1 Press [] (Status Monitor/Cancel).

2 Press [▲] or [▼] to select <Fax Job Status/History>, and then press [OK].

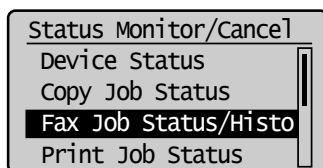

3 Press [▲] or [▼] to select <Job History>, and then press [OK].

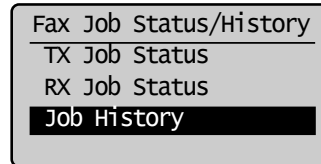

4 Press [▲] or [▼] to select a job to be checked, and then press [OK].

The detailed information is displayed.

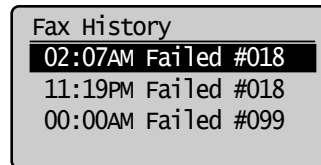

5 Press [▲] or [▼] to select an item to be checked, and then press [OK].

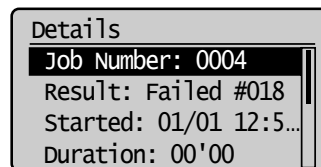

6 Press [] (Status Monitor/Cancel) to close the screen.

Changing the Default Values for Fax

The default values for fax are those functions which are applied automatically when [⊗] (Reset) is pressed or the power is turned ON. You can change the default values to suit your needs.

You can register the following types of settings as the default values.

- Resolution
- Density
- Sharpness

Keys to be used for this operation

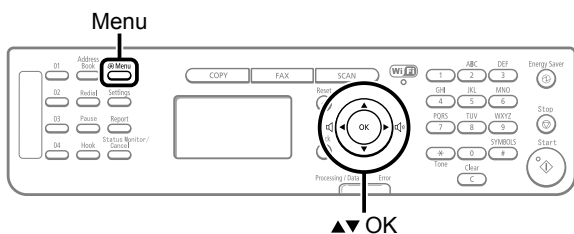

1 Press [Menu].

2 Press [▲] or [▼] to select <Fax TX Settings>, and then press [OK].

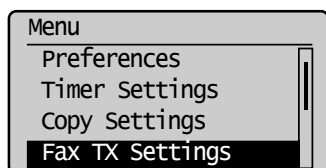

3 Press [▲] or [▼] to select <TX Function Settings>, and then press [OK].

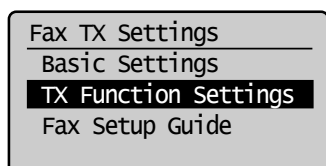

4 Press [▲] or [▼] to select <Change Defaults>, and then press [OK].

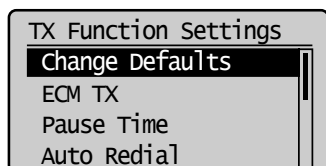

5 Press [▲] or [▼] to select a setting item, and then press [OK].

- **Resolution/Density/Sharpness**

For details on settings, see "Fax Settings" (→P.6-3).

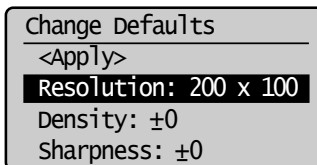

6 After specifying the setting, press [▲] or [▼] to select <Apply>, and then press [OK].

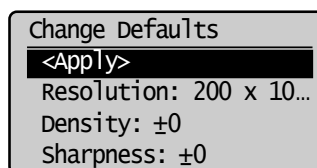

7 Press [Menu] to close the menu screen.

Changing the Fax Settings (Items Specified Using the [Menu] Button)

Change the settings for sending and receiving faxes. For details on the procedure for setting specifications or the setting items, see the next items.

- ▶ "Setting Procedure for Sending Faxes" (→P.6-19)
- ▶ "Setting Items" (→P.6-19)
- ▶ "Setting Procedure for Receiving Faxes" (→P.6-21)
- ▶ "Setting Items for the Receive Settings" (→P.6-22)
- ▶ "System Settings Procedure" (→P.6-23)
- ▶ "Setting Items" (→P.6-24)

Setting Procedure for Sending Faxes

Specify the settings for sending faxes using the following procedure.

This section describes the procedure for changing the setting for "ECM TX" as an example.

Keys to be used for this operation

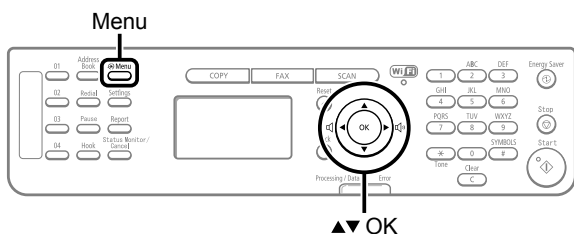

- 1 Press [] (Menu).
- 2 Press [▲] or [▼] to select <Fax TX Settings>, and then press [OK].

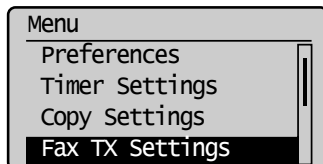

- 3 Press [▲] or [▼] to select <TX Function Settings>, and then press [OK].

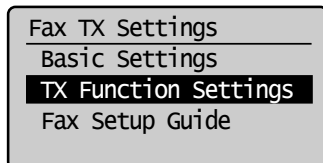

- 4 Press [▲] or [▼] to select <ECM TX>, and then press [OK].

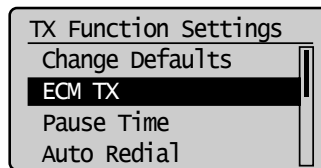

- 5 Press [▲] or [▼] to select <Off> or <On>, and then press [OK].

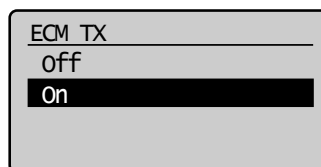

* When <Apply> appears in the screen, you must select <Apply> and press [OK] after specifying the setting.

- 6 Press [] (Menu) to close the menu screen.

The setting is complete.

Setting Items

The following settings are available for sending faxes.

Send/Receive Settings	
Basic Settings	▶ "Register Unit Name" (→P.6-20)
	▶ "Register Unit Telephone Number" (→P.6-20)
	▶ "Select Line Type" (→P.6-20)
	▶ "Public Line Connection" (→P.6-20)
	▶ "Off-Hook Alarm" (→P.6-20)
TX Function Settings	▶ "Sender ID" (→P.6-20)
	▶ "Change Defaults" (→P.6-20)
	▶ "ECM TX" (→P.6-20)
	▶ "Pause Time" (→P.6-21)
	▶ "Auto Redial" (→P.6-21)
	▶ "Check Dial Tone Before Sending" (→P.6-21)

Register Unit Name

Your name or company's name must be registered as the machine's name.

When you send a document, the name that you registered will appear at the top of the recipient's paper.

How to display the settings

[] (Menu) → <Fax TX Settings> → <Basic Settings> → <Register Unit Name>

Settings

You can enter characters (up to 24 characters).

"Text Input Method" (→P.1-9)



NOTE

How to use a username

When you send a document, the sender information that you registered is printed on the recipient's paper.

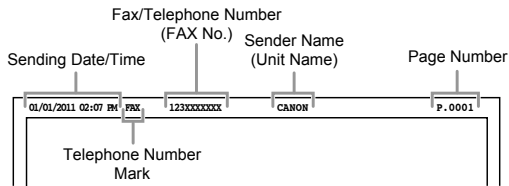

Register Unit Telephone Number

Register your machine's fax number.

How to display the settings

[] (Menu) → <Fax TX Settings> → <Basic Settings> → <Register Unit Telephone Number>

Settings

You can enter numbers with the numeric keys (up to 20 characters).

You can also enter the [+].

Select Line Type

If you cannot send a fax, change this setting.
If you are not sure about your telephone line type, contact your local telephone company.

How to display the settings

[] (Menu) → <Fax TX Settings> → <Basic Settings> → <Select Line Type>

Settings

(Bold: Default settings)

Dial 10 PPS	Specify when you are using a dial-line.
Tone	Specify when you are using a tone-line.

Public Line Connection

The following problems may occur when fax receive mode is selected to <Fax/Tel Auto Switch>.

- The external telephone does not ring.
 - Cannot make a call using the external telephone.
- You can solve these problems by changing this setting.

How to display the settings

[] (Menu) → <Fax TX Settings> → <Basic Settings> → <Public Line Connection>

Settings

(Bold: Default settings)

Direct	Use this setting under normal conditions
Adapter 1	Select this option if a problem occurs when <Direct> is selected.
Adapter 2	Select this option if the problem continues when <Adapter 1> is selected.

Off-Hook Alarm

Specify whether or not to sound an alarm when the telephone handset is off the hook.

You can also set the volume of the alarm sound.

How to display the settings

[] (Menu) → <Fax TX Settings> → <Basic Settings> → <Off-Hook Alarm>

Settings

(Bold: Default settings)

Off	No alarm will sound.	
On	Off-Hook Alarm Volume: 1 to 5	An alarm will sound at the specified volume.

Sender ID

You can specify whether the sender ID is added to a document to be sent.

The sender ID is printed on the top of the sent document. Information such as your fax number and name is printed, enabling the recipient to know who sent the document.

How to display the settings

[] (Menu) → <Fax TX Settings> → <Basic Settings> → <Sender ID>

Settings

(Bold: Default settings)

Off	No sender ID is added.	
On	Print Location: On Image, Above Image	Select the location where the sender ID is printed.
	Mark No. as TEL/FAX: FAX, TEL	Select a character to be added in front of a telephone number.

Change Defaults

You can change the settings for when turning the power ON or pressing [] (Reset).

How to display the settings

[] (Menu) → <Fax TX Settings> → <TX Function Settings> → <Change Defaults>

Settings

For details on the settings, see the following item.

"Changing the Default Values for Fax" (→P.6-18)

ECM TX

The ECM (Error Correction Mode) is a function for detecting and correcting errors during fax communication. Using the ECM function can diminish send errors even over poor connections



NOTE

Check the settings for the recipient's machine also.

The ECM function is available only when the setting for the machine and recipient's machine are enabled.

Even if the ECM function is enabled

An error may occur due to the telephone line.

When the ECM function is enabled

It may take additional time to send documents if a problem occurs with the telephone line.

How to display the settings

[Menu] (Menu) → <Fax TX Settings> → <TX Function Settings> → <ECM TX>

Settings

(Bold: Default settings)

Off	Does not use the ECM function.
On	Uses the ECM function.

Pause Time

Specify the length of a pause when [Pause] (Pause) is pressed.

For details on adding pauses, see “Sending a Fax Abroad (Adding Pauses)” (→P.6-8)

How to display the settings

[Menu] (Menu) → <Fax TX Settings> → <TX Function Settings> → <Pause Time>

Settings

(Bold: Default settings)

1 to 2 to 15 (seconds)

Auto Redial

Set auto redialing to automatically reattempt to connect to a destination if the line is busy or a send error occurs. You can also specify the how many time to redial a number and an interval between attempts.

How to display the settings

[Menu] (Menu) → <Fax TX Settings> → <TX Function Settings> → <Auto Redial>

Settings

(Bold: Default settings)

Off	Does not redial automatically. When redialing manually, see “Redialing (Manual Redialing)” (→P.6-6).	
On	Redial Times: 1 to 2 to 10 (times)	Set the number of redial attempts.
	Redial Interval: 2 to 99 (minutes)	Set an interval (in minutes) between redial attempts.
	Redial When Err Occurs: Off, On	Specifies whether or not to redial when a send error occurs.

Check Dial Tone Before Sending

When sending a fax, you can specify whether or not to verify the dial tone before dialing.

How to display the settings

[Menu] (Menu) → <Fax TX Settings> → <TX Function Settings> → <Check Dial Tone Before Sending>

Settings

(Bold: Default settings)

Off	Does not check the dial tone.
On	Checks the dial tone before dialing.

Setting Procedure for Receiving Faxes

Specify the settings for receiving faxes using the following procedure.

This section describes the procedure for changing the setting for “ECM RX” as an example.

Keys to be used for this operation

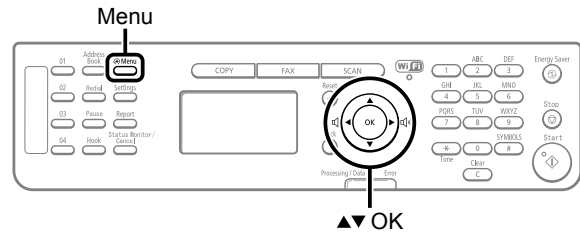

- 1 Press [Menu].
- 2 Press [▲] or [▼] to select <Fax RX Settings>, and then press [OK].

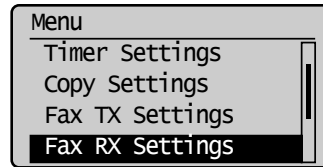

- 3 Press [▲] or [▼] to select <Fax Settings>, and then press [OK].

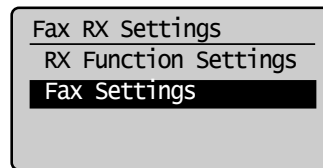

- 4 Press [▲] or [▼] to select <ECM RX>, and then press [OK].

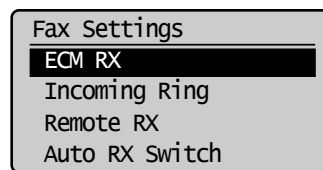

- 5 Press [▲] or [▼] to select <Off> or <On>, and then press [OK].

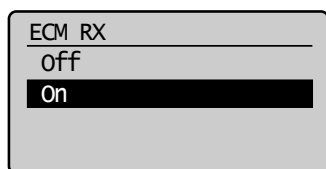

* When <Apply> appears in the screen, you must select <Apply> and press [OK] to apply the setting.

- 6 Press [] (Menu) to close the menu screen.

The setting is complete.

Setting Items for the Receive Settings

The receive settings include the following items.

Fax RX Settings	
RX Function Settings	<ul style="list-style-type: none"> ▶ "2-Sided Printing" (→P.6-22) ▶ "Reduce RX Size" (→P.6-22) ▶ "RX Page Footer" (→P.6-22) ▶ "Continue Print. When Toner Is Nearly Out" (→P.6-22)
Fax Settings	<ul style="list-style-type: none"> ▶ "ECM RX" (→P.6-22) ▶ "Incoming Ring" (→P.6-23) ▶ "Remote RX" (→P.6-23) ▶ "Auto RX Switch" (→P.6-23)

2-Sided Printing

Use this option to save paper by printing on both sides of each sheet.

How to display the settings

[] (Menu) → <Fax RX Settings> → <RX Function Settings> → <2-Sided Printing>

Settings

(Bold: Default settings)

Off	Prints on only one side of each sheet.
On	Prints on both sides of each sheet.

Reduce RX Size

Use this option to scale images so they fit the selected paper size or at a specified ratio, when receiving faxes.

How to display the settings

[] (Menu) → <Fax RX Settings> → <RX Function Settings> → <Reduce RX Size>

Settings

(Bold: Default settings)

Off	No image reduction.
On	Ratio: Auto , 97%, 95%, 90%, 75% <Auto>: Reduces the image size by automatically adjusting the reduction ratio. <97%>, <95%>, <90%>, <75%>: Reduces the image according to the specified ratio.
	Reduction Direction: Vertical/Horizontal, Vertical Only <Vertical/Horizontal>: Reduces the image size both vertically and horizontally. <Vertical Only>: Reduces the image vertically only.

RX Page Footer

Specify whether or not to print a received date, day of the week, time, number, and page number at the bottom of documents when printing received documents.

How to display the settings

[] (Menu) → <Fax RX Settings> → <RX Function Settings> → <RX Page Footer>

Settings

(Bold: Default settings)

Off	Does not include the page footer.
On	Includes the page footer.

Continue Print. When Toner Is Nearly Out

Specify whether or not to continue printing received documents when the toner is nearly out.



IMPORTANT

When using this option, some documents may be light or blurry, due to low toner. Beware that data is erased when a received fax is printed, so you will not be able to reprint a received fax that is too light or blurred to read.

How to display the settings

[] (Menu) → <Fax RX Settings> → <RX Function Settings> → <Continue Print. When Toner Is Nearly Out>

Settings

(Bold: Default settings)

Off	Printing does not continue when the toner is low.
On	Printing continues when the toner is low.

ECM RX

The ECM (Error Correction Mode) is a function for detecting and correcting errors during fax communication. Using the ECM function can diminish receive errors even over poor connections.



NOTE

Check the settings for the recipient's machine also

The ECM function is available only when the setting for both the sender's and recipient's machines are enabled.

Even if the ECM function is enabled

An error may occur due to a poor connection.

When the ECM function is enabled

It may take time to receive documents if a problem occurs with the telephone line.

How to display the settings

[] (Menu) → <Fax RX Settings> → <Fax Settings> → <ECM RX>

Settings

(Bold: Default settings)

Off	Does not use the ECM function.
On	Uses the ECM function.

Incoming Ring

Specify whether or not the external telephone will ring during an incoming call if <RX Mode> is set to <Auto> or <Fax/Tel Auto Switch>.

You can also specify the number of ringing times.

After the external telephone rings for specified times, the machine automatically starts receiving when receiving a fax. When receiving a call, only when <RX Mode> is set to <Fax/Tel Auto Switch>, the machine's speaker rings.

How to display the settings

[Menu] (Menu) → <Fax RX Settings> → <Fax Settings> → <Incoming Ring>

Settings

(Boldface: Default settings)

Off		The telephone does not ring during an incoming call.
On	Ring Times: 1 to 2 to 99 (times)	The telephone rings during an incoming call. You can specify the number of ringing times in <Ring Times>.

Remote RX

If an external telephone is connected, you can switch to the fax receiving mode immediately by dialing the ID number for fax receiving using the dial buttons of the telephone during a phone call.

How to display the settings

[Menu] (Menu) → <Fax RX Settings> → <Fax Settings> → <Remote RX>

Settings

(Boldface: Default settings)

Off		Remote receiving is disabled.
On	Remote RX ID: 00 to 25 to 99	Remote receiving is enabled. You can specify an ID number for fax receiving in <Remote Receive ID>.

Auto RX Switch

Specify how long an incoming call should ring before the machine automatically switches to fax mode. This option is available when the <RX Mode> is set to <Manual>.

How to display the settings

[Menu] (Menu) → <Fax RX Settings> → <Fax Settings> → <Auto RX Switch>

Settings

(Bold: Default settings)

Off		The machine will not automatically switch to fax mode.
On	Incoming Ring Time: 1 to 15 to 99 (seconds)	The machine will automatically switch to fax mode after the specified period.

System Settings Procedure

Specify the system settings using the following procedure. This section describes the procedure for changing the setting for "TX Start Speed" as an example.

Keys to be used for this operation

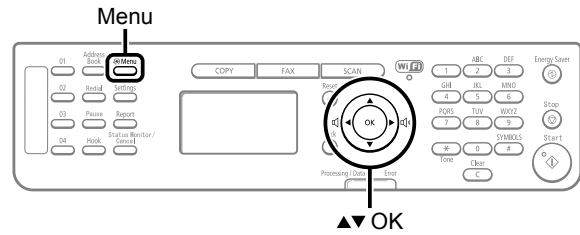

- 1 Press [Menu].
- 2 Press [▲] or [▼] to select <System Management Settings>, and then press [OK].

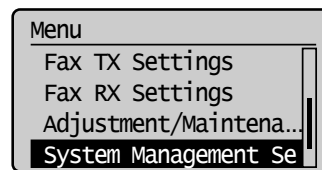

When the system manager PIN is specified

Enter the system manager PIN.

[Text Input Method] (→P.1-9)

When you are finished entering, press [▲] or [▼] to select <Apply>, and then press [OK].

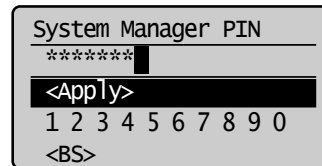

- 3 Press [▲] or [▼] to select <Communication Management Settings>, and then press [OK].

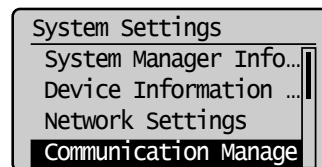

- 4 Press [▲] or [▼] to select <Fax Settings>, and then press [OK].

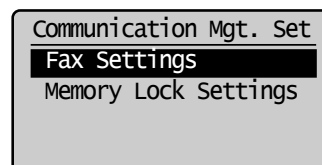

- 5 Press [▲] or [▼] to select <TX Start Speed>, and then press [OK].

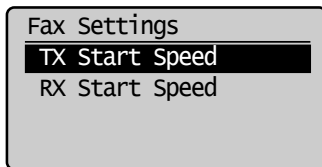

- 6 Press [▲] or [▼] to select the send start speed, and then press [OK].

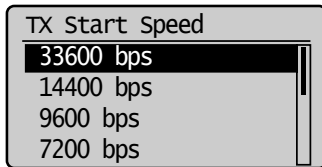

* When <Apply> appears in the screen, you must select <Apply> and press [OK] after specifying the setting.

- 7 Press [()] (Menu) to close the menu screen.

The setting is complete.

Setting Items

The following system management settings are available.

System Settings	
Communications Settings	Fax Settings <ul style="list-style-type: none"> ▶ "TX Start Speed" (→P.6-24) ▶ "RX Start Speed" (→P.6-24)
	▶ "Memory Lock Settings" (→P. 6-24)
▶ "Select Country/Region" (→P.6-24)	
Restrict TX Function	▶ "Address Book PIN" (→P.6-25)
	▶ "Restrict New Destinations" (→P.6-25)
	▶ "Allow Driver Faxing" (→P.6-25)
	▶ "Restrict Sending From History" (→P.6-25)
	▶ "Fax No. Confirmation Re-Entry" (→P.6-25)
▶ "Restrict Sequential Broadcast" (→P.6-25)	

TX Start Speed

Change the transmission start speed if you have difficulty starting a fax transmission.

How to display the settings

[()] (Menu) → <System Management Settings> → <Communication Management Settings> → <Fax Settings> → <TX Start Speed>

Settings

(Bold: Default settings)

33600 bps, 14400 bps, 9600 bps, 7200 bps, 4800 bps, 2400 bps

RX Start Speed

Specify the receive start speed if you have difficulty receiving faxes.

How to display the settings

[()] (Menu) → <System Management Settings> → <Communication Management Settings> → <Fax Settings> → <RX Start Speed>

Settings

(Bold: Default settings)

33600 bps, 14400 bps, 9600 bps, 7200 bps, 4800 bps, 2400 bps

Memory Lock Settings

Normally, received documents are immediately printed. However, you can specify whether or not to store received faxes in memory before printing. You can then print the stored faxes at any time or delete them without printing to save paper.

How to display the settings

[()] (Menu) → <System Management Settings> → <Communication Management Settings> → <Memory Lock Settings>

Settings

(Bold: Default settings)

Off	Does not use the Memory Lock mode.	
On	Memory Lock PIN: Seven-digit number	If you set a PIN, it will be necessary to enter the PIN whenever you want to change the Memory Lock mode settings, or cancel the Memory Lock mode.
	Print Report: Off, On	You can specify whether or not to print the receive results when receiving a fax. To use this feature, you must also activate the "Receive Results" feature.
	Memory Lock Time: Off, On	If you specify <On>, documents are received in the memory only within a specified time. Enter <Memory Lock Start Time> and <Memory Lock End Time> respectively.



NOTE

Memory Lock PIN

- If you do not want to set the PIN, press [OK] without entering any numbers.
- You cannot register consecutive digits that consist of only "0" as a PIN, such as <0000000>.
- If you register a number that starts from <0>, the PIN changes as follows.
Example: When you enter <02> or <002>, the PIN is specified as <0000002>.

Select Country/Region

Specify the country or region where the machine is to be used.



IMPORTANT

After configuration

Restart the machine to activate the settings.

How to display the settings

[()] (Menu) → <System Management Settings> → <Select Country/Region>

Settings

(Bold: Default settings)

UnitedStates (US), Canada (CA),
Brazil (BR), Mexico (MX), Other

Address Book PIN

Specify a PIN to protect the address book. The PIN will be required to register, edit, or delete destinations.

How to display the settings

 [] (Menu) → <System Management Settings> → <Restrict TX Function> → <Address Book PIN>

Settings

Enter a 7-digit number.

To cancel the PIN option, clear any numbers entered and press [OK].

Restrict New Destinations

Restrict the destinations that can be specified to pre-registered one-touch keys or coded dial codes.

Restricting destinations will prevent the following operations.

- Specifying a destination with the numeric keys
- Registering new destinations to the address book, one-touch keys, coded dial codes
- Changing destinations that are registered to the address book, one-touch keys, coded dial codes

How to display the settings

 [] (Menu) → <System Management Settings> → <Restrict TX Function> → <Restrict New Destinations>

Settings

(Bold: Default settings)

Off	No restriction.
On	Performs restriction. Specifies destinations registered under the one-touch keys and coded dial codes.

Allow Driver Faxing

Specify whether or not to allow faxes to be sent via a computer's fax driver.

How to display the settings

 [] (Menu) → <System Management Settings> → <Restrict TX Function> → <Allow Driver Faxing>

Settings

(Bold: Default settings)

Off	Faxes cannot be sent by a computer's fax driver.
On	Faxes can be sent from a computer's fax driver.

Restrict Sending From History

Specify whether or not to restrict sending faxes from history.

How to display the settings

 [] (Menu) → <System Management Settings> → <Restrict TX Function> → <Restrict Sending From History>

Settings

(Bold: Default settings)

Off	Sending from a history is permitted.
On	Sending from a history is not permitted.

Fax No. Confirmation Re-Entry

Specify whether or not to require a confirmation before sending a fax. If you activate this feature, you must re-enter the fax number before the fax will be sent.

How to display the settings

 [] (Menu) → <System Management Settings> → <Restrict TX Function> → <Fax No. Confirmation Re-Entry>

Settings

(Bold: Default settings)

Off	Does not require confirmation.
On	Requires you to re-enter the fax number for confirmation.

Restrict Sequential Broadcast

Specify whether or not to restrict faxes to multiple recipients.

How to display the settings

 [] (Menu) → <System Management Settings> → <Restrict TX Function> → <Restrict Sequential Broadcast>

Settings

(Bold: Default settings)

Off	Allows you to send a fax to multiple recipients.
Confirm Sequential Broadcast	Displays a confirmation screen when you send a fax to multiple recipients.
Reject Sequential Broadcast	Does not allow you to send a fax to multiple recipients.



● Canceling Fax Jobs

You can cancel fax jobs that are sending or receiving, or waiting to be sent or received.

1 Press [].

2 Press [] (Stop).

* If only one job is processing or waiting to be sent or received, you can stop the job by pressing [] (Stop) twice.

3 When <Cancel?> appears, Press [] or [] to select <Yes>, and then press [OK].

* You can also press [] (Stop) to cancel the job. Transmission or reception is canceled.

Using the Scan Functions

The documents scanned by the machine can be stored in a computer.

* If you are a Macintosh user, see the Mac Scanner Driver Guide.

To view how to display the Mac Scanner Driver Guide, see "For Macintosh Users" (→P.11-4).

Basic Operation Methods for Scanning

You can scan a document using the keys on the operation panel.



NOTE

To scan documents by operating a computer

See "Scan" in the e-Manual.

Keys to be used for this operation

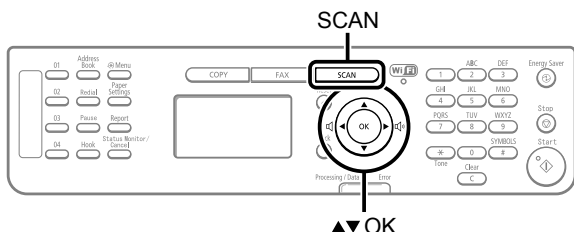

1 Place documents.

- ▶ "Placing Documents" (→P.2-4)
- ▶ "Document Requirements" (→P.2-2)



NOTE

When scanning using the operation panel

You cannot scan multiple documents from the platen glass.

2 Press [SCAN].

3 Press [▲] or [▼] to select <Computer>, and then press [OK].

Select the scan type.

Computer
Remote Scanner

4 Press [▲] or [▼] to specify a destination, and then press [OK].

- When multiple computers are connected
The computer connected by a USB cable is listed on the top.
- When a computer is connected by a USB cable
This screen is not displayed.
- If eleven or more computers are connected via a network
The eleventh and subsequent computers are not displayed (you cannot scan). Reduce the number of computers connected to this machine via a network.
- ▶ e-Manual → Scan → Registering the Scanner in MF Network Scan Utility
- * You can change the names for the displayed computers.
▶ e-Manual → Scan → Using the MF Toolbox

Specify destination.

EXAMPLE1
EXAMPLE2

5 Press [▲] or [▼] to specify the scanner settings and then press [OK].

The scanner settings are specified by default as follows.

	Scan Mode	Resolution	File Type	PDF Settings
Color Scan	Color	300 dpi	PDF	Searchable/High
B&W Scan	Black and White	300 dpi	TIFF	-
Custom 1	Color	300 dpi	JPEG/Exif	-
Custom 2	Color	300 dpi	PDF	Searchable/Standard

Select Scan Type

Scan: Press OK

Color Scan
B&W Scan
Custom 1

Scanning operation starts, and the scan mode screen reappears after saving the data.



If you cannot scan

You cannot scan when the setting screen of the MF Toolbox is displayed.
Click to close the setting screen before scanning.

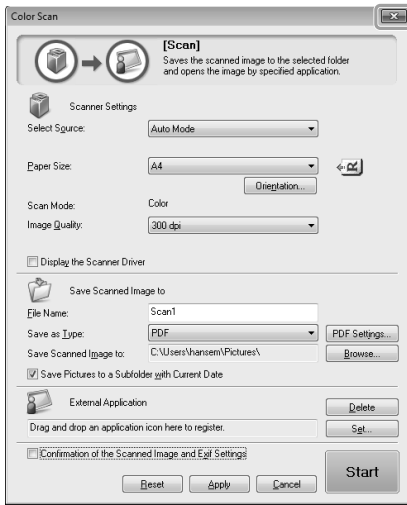

The location to save the scanned images

The folder where the images are saved opens automatically after scanning.

By default, the folder for the date when you scanned the data is created in the [Pictures] folder. (For Windows 2000/XP, the folder is created in the [My Pictures] folder in [My Documents].)



Note

To change the scanner settings

You can change the settings for the location to save, the file format, or the resolution from a computer.

e-Manual → Scan → Using the MF Toolbox

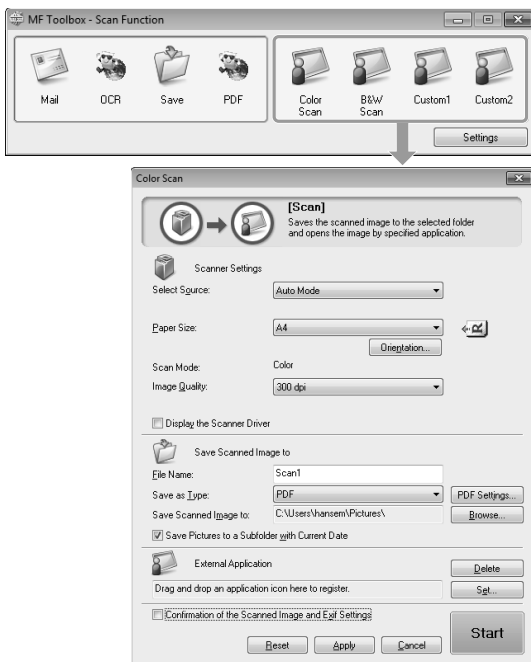

Maintenance

This section describes the maintenance of this machine, replacement of the toner cartridges, and so on.

Cleaning the Machine **8-2**

Cleaning the Exterior	8-2
Cleaning the Interior	8-2
Cleaning the Fixing Unit	8-3
Cleaning the Platen Glass	8-4
Cleaning the Feeder	8-4
Precautions When Cleaning the Machine	8-4

Replacing Toner Cartridges **8-6**

When a Message Appears	8-6
When White Streaks Appear On the Printouts or Some Parts Are Faded	8-6
About the Supplied Toner Cartridge	8-7
About Replacement Toner Cartridge	8-7
Handling Toner Cartridge	8-7
Checking the Toner Level	8-8
Using the Toner Saver Mode	8-8
Before Replacing the Toner Cartridge	8-9
Replacing the Toner Cartridge	8-10
Precautions when Replacing Toner Cartridge	8-11
Purchase Consumables	8-12

Recycling Used Cartridges **8-13**

The Clean Earth Campaign	8-13
U.S.A. PROGRAM	8-13
Packaging	8-13
Shipping	8-14
CANADA PROGRAM-CANADA PROGRAMME	8-15

Transporting the Machine **8-16**

Precautions when Transporting the Machine	8-17
---	------

Cleaning the Machine

Cleaning the Exterior

Clean the exterior of the machine and ventilation slots.

- 1 Turn OFF the power switch and disconnect the power cord.
- 2 Clean the exterior of the machine with a soft, well wrung out cloth dampened with water or mild detergent diluted with water.

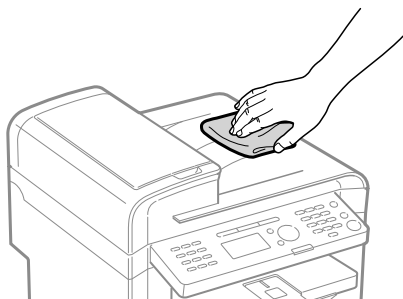

- 3 Wait for the printer to dry completely before reconnecting the power cord, and then turn ON the power.

Cleaning the Interior

Clean the machine's print area periodically to prevent toner powder and paper dust from accumulating inside.

- 1 Turn OFF the power switch and disconnect the power cord.
- 2 Hold the operation panel.

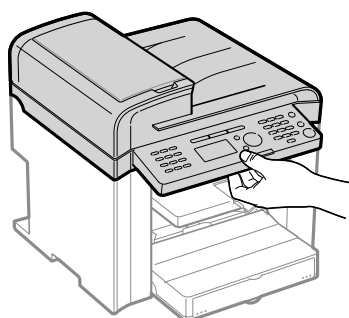

- 3 Lift the scanning platform.

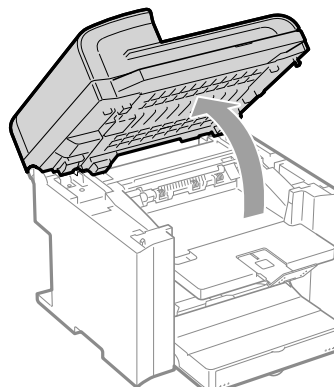

If you cannot lift the scanning platform

Ensure that the feeder is completely closed.

Do not try to forcefully lift the scanning platform, as this may damage the machine.

* If you set thick documents such as a book, the feeder may not be completely closed. Remove the documents.

- 4 Hold the grip on the left front side of the toner cover.

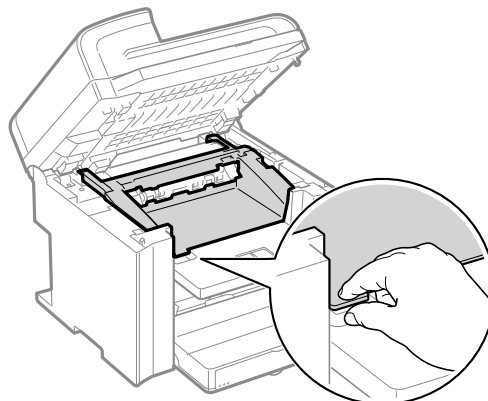

- 5 Open the toner cover.

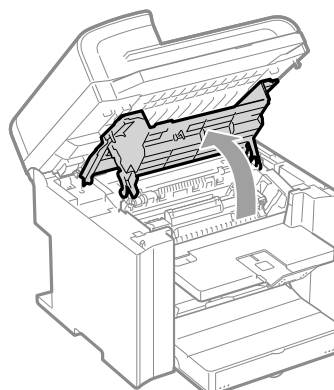

6 Remove the toner cartridge.

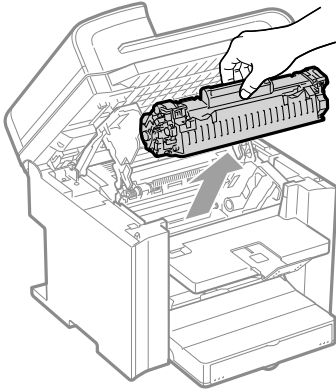

7 Remove any toner or paper debris from interior of the machine, with a clean, soft, dry, and lint-free cloth.

8 Insert the toner cartridge.

Fit the protrusions (A) on each side of the toner cartridge into the guides located on each side of the machine, and then slide the toner cartridge into the machine until the toner cartridge meets the back of the machine.

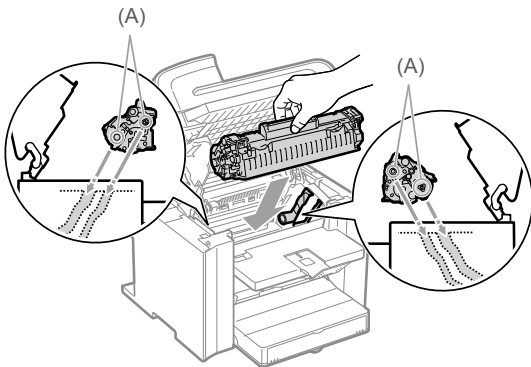

9 Close the toner cover.



If you cannot close the toner cover

Ensure that the toner cartridge is properly set in the machine.
Do not try to forcefully close the toner cover, as this may damage the machine.

10 Lower the scanning platform.

11 Connect the power cord and turn ON the power switch.

Cleaning the Fixing Unit

In the following cases, the fixing unit may be dirty. Clean the fixing unit.

- When black streaks appear on the printed paper
- When a toner cartridge is replaced

Keys to be used for this operation

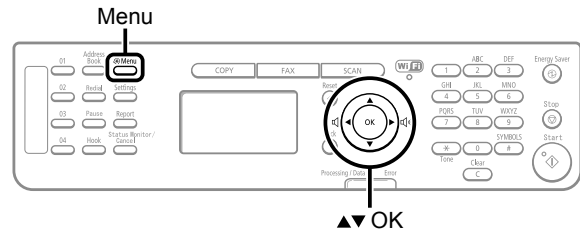

- 1 Press [] (Menu).
- 2 Press [▲] or [▼] to select <Adjustment/Maintenance>, and then press [OK].

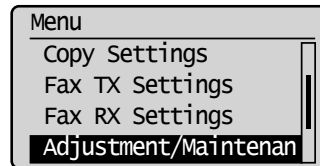

- 3 Press [▲] or [▼] to select <Clean Fixing Unit>, and then press [OK].

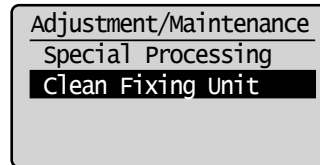

- 4 Load Letter size plain paper in the multi-purpose tray, and then press [OK].

The cleaning process will start. Cleaning takes approximately 90 seconds.

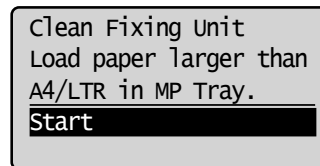

* It is recommended that you use plain paper to clean the fixing unit.



If cleaning does not begin

When there are jobs stored in memory, this function is not available.

- 5 Press [] (Menu) to close the menu screen.

Cleaning the Platen Glass

Follow this procedure to clean the platen glass and under surface of the feeder.

- 1 Turn OFF the power switch and disconnect the power cord.
- 2 Open the feeder.

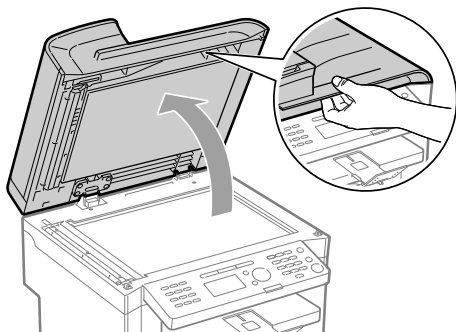

- 3 Clean the platen glass and the under surface of the feeder.

- (1) Clean the areas with a cloth dampened with water.
- (2) Wipe the areas with a soft, dry cloth.

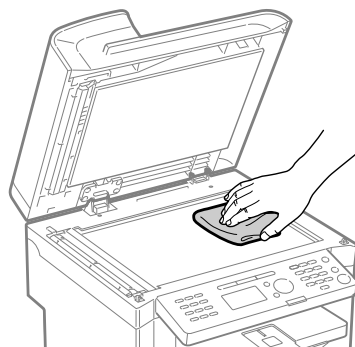

IMPORTANT

Precautions when cleaning the platen glass

Be careful not to fold the transparent sheet (A) at the left side of the platen glass.

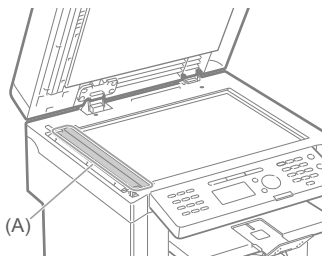

- 4 Close the feeder.
- 5 Connect the power cord and turn ON the power switch.

Cleaning the Feeder

If your documents have black streaks or appear dirty after scanning using the feeder, the roller inside the feeder may be dirty. Clean the feeder scanning area and roller.

- 1 Turn OFF the power switch and disconnect the power cord.
- 2 Open the feeder cover.



- 3 Clean the rollers (A) inside the feeder with a well wrung out cloth dampened with water, and then wipe the area with a soft, dry cloth.

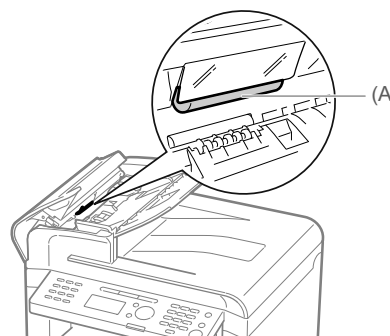

- 4 Close the feeder cover.
- 5 Connect the power cord and turn ON the power switch.

Precautions When Cleaning the Machine

Before cleaning the machine, check the following.

- Ensure no jobs are stored in memory, then turn OFF the power switch and disconnect the power cord.
- Use a soft cloth to avoid scratching the components.
- Do not use tissue paper, paper towels, or similar materials for cleaning. They can stick to the components or generate static charges.

CAUTION

Precautions when closing the feeder

Be careful not to get your fingers caught.

Do not touch the fixing unit (A).

Touching the fixing unit (A) may cause burns as it becomes very hot during use.

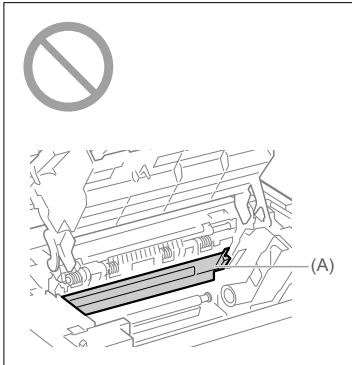

Precautions if you get toner on your hands or clothing

If toner gets on your hands or clothing, wash them immediately with cold water.

Washing with warm water sets the toner, making it impossible to remove the toner stains.

IMPORTANT

Precautions when cleaning the feeder

Do not dampen the cloth too much, as this may tear the document or damage the machine.

Do not touch the transfer roller (A).

Touching the transfer roller (A) may damage the machine.

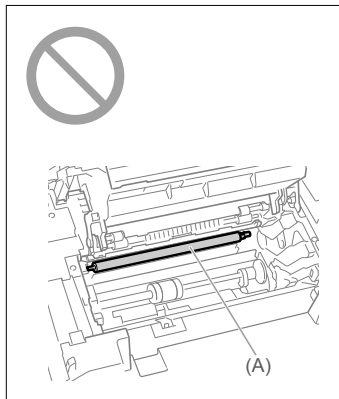

NOTE

Sending or receiving faxes

When the power plug is unplugged, the machine cannot send or receive faxes.

If there is data waiting to be printed

The data is deleted when you turn OFF the power switch.

Data received in memory, reserved sending data, etc.

They can be kept for approximately 5 minutes after the power plug is unplugged. To view jobs stored in memory, see the following.

- ▶ "Checking and Managing Fax Documents in Memory" (→P6-15)

Replacing Toner Cartridges

Toner cartridges are consumable products. When the toner has almost or completely run out in the middle of operating this machine, a message appears in the display, or the symptoms described below appears. Follow a proper resolution depending on the message or symptom.

● A message appears in the display

- ▶ "When a Message Appears" (→P.8-6)

● White streaks appear on the printouts or some parts are faded

- ▶ "When White Streaks Appear On the Printouts or Some Parts Are Faded" (→P.8-6)



IMPORTANT

About toner cartridges

For details on the toner cartridge yields and the procedures for handling toner cartridges and checking the toner level, see the following.

- ▶ About the Supplied Toner Cartridge (→P.8-7)
- ▶ About Replacement Toner Cartridge (→P.8-7)
- ▶ Handling Toner Cartridge (→P.8-7)
- ▶ Checking the Toner Level (→P.8-8)
- ▶ Using the Toner Saver Mode (→P.8-8)
- ▶ Purchase Consumables (→P.8-12)

* The yields of the toner cartridges included in this machine differ from those of replacement toner cartridges.

When a Message Appears

When the toner becomes nearly out in the middle of operating this machine, a message appears in the display.

Message	When It Is Displayed	Description and Solutions
<Prepare toner cartridge.>	When a toner cartridge soon needs to be replaced.	Redistribute the toner. ▶ "Before Replacing the Toner Cartridge" (→P.8-9) It is recommended that you replace the toner cartridge before printing a large amount of data. ▶ "Replacing the Toner Cartridge" (→P.8-10)
<Toner is nearly out.>	When a toner cartridge has reached the end of its life.	Redistribute the toner. ▶ "Before Replacing the Toner Cartridge" (→P.8-9) If this message does not disappear, replace the toner cartridge. ▶ "Replacing the Toner Cartridge" (→P.8-10) If this message is displayed, the incoming fax will be stored in the memory without being printed. Also, reports may not be printed, even if they are set to be printed automatically. If <Continue Printing When Toner Is Low> in <RX Function Settings> is set to <On>, however, printing will be continued, but white streaks or smudges may appear on printouts. ⓘ e-Manual → Basic Operation → Setting the Report to Print Automatically ▶ "Continue Print. When Toner Is Nearly Out" (→P.6-22)



IMPORTANT

White streaks appear or some parts are faded

If white streaks appear on the printouts or some parts are faded, the toner cartridge has almost reached the end of its life, even if no messages appear on the screen. If print quality declines, refer to the following to resolve the problem.

- ▶ "When White Streaks Appear On the Printouts or Some Parts Are Faded" (→P.8-6)

When White Streaks Appear On the Printouts or Some Parts Are Faded

If the toner almost runs out, white streaks appear on the printouts or some parts are faded.



* No message appears on the display even if the toner almost runs out. Replace the toner cartridge when white streaks appear on the printouts or some parts of the printout are faded.

If the above symptoms appear



Follow the procedure in the section below before replacing the toner cartridge. You may print for some time, until the toner completely runs out.

- ▶ "Before Replacing the Toner Cartridge" (→P.8-9)

If print result is not improved



If white streaks or faded parts continue to appear after following the procedure in the section above, replace the toner cartridge.

- ▶ "Replacing the Toner Cartridge" (→P.8-10)

About the Supplied Toner Cartridge

The average yield of the included toner cartridge is as follows.

Canon Cartridge 128 Starter	Average yield ¹ : 1,000 sheets
------------------------------------	---

¹ The average yield is on the basis of "ISO/IEC 19752"² when printing A4 size paper with the default print density setting.

² "ISO/IEC 19752" is the global standard related to "Method for the determination of toner cartridge yield for monochromatic electrophotographic printers and multi-function devices that contain printer components" issued by ISO (International Organization for Standardization).

The average yield of the replacement toner cartridge is different from which of the supplied toner cartridge.

About Replacement Toner Cartridge

Purchase the toner cartridge at your local authorized Canon dealer.

Replace the toner cartridge according to the description in the following charts. However, you may need to replace the toner cartridge earlier than the described life time depending on installation environment of the machine, the printing paper size, or the document type.

Toner cartridge	Target for replacing toner cartridge
Canon Cartridge 128	Average yield ¹ : 2,100 sheets

¹ The average yield is on the basis of "ISO/IEC 19752"² when printing A4 size paper with the default print density setting.

² "ISO/IEC 19752" is the global standard related to "Method for the determination of toner cartridge yield for monochromatic electrophotographic printers and multi-function devices that contain printer components" issued by ISO (International Organization for Standardization).



IMPORTANT

About Replacement Toner Cartridge

For optimum print quality, replacing the toner cartridge with Canon genuine ones is recommended.

Model name	Supported Canon genuine toner cartridge
MF4570dw	Canon Cartridge 128

Handling Toner Cartridge

Note the following when handling the toner cartridge.



CAUTION

Do not place the toner cartridge in fire.

This may cause toner remaining inside the cartridge to ignite and result in burns.

If toner leaks from the toner cartridge

Be careful not to inhale the toner or allow it to come into direct contact with your skin. If the toner comes into contact with your skin, wash with soap. If the skin becomes irritated or you inhale the toner, consult a physician immediately.

When removing a toner cartridge

Ensure to remove it carefully. If not removed with care, the toner powder may scatter and come in contact with your eyes and mouth. If toner gets into your eyes or mouth, wash them immediately with cold water and consult a physician.

Keep the toner cartridge away from small children.

If the toner or other parts are ingested, consult a physician immediately.

Do not disassemble the toner cartridge.

The toner may scatter and get into your eyes or mouth. If toner gets into your eyes or mouth, wash them immediately with cold water and consult a physician.



IMPORTANT

Handling toner cartridge

- Keep the toner cartridge away from computer screens, disk drives, and floppy disks. They may be damaged by magnet which is in inside of the toner cartridge.
- Avoid locations subject to high temperature, high humidity, or rapid changes in temperature.
- Do not expose the toner cartridge to direct sunlight or bright light for more than five minutes.
- Store the toner cartridge in its protective bag. Do not open the bag until you are ready to install the toner cartridge in the machine.
- Keep the protective bag for the toner cartridge. They are required when transporting the machine such as during relocation.
- Do not store the toner cartridge in a salty atmosphere or where there are corrosive gases such as from aerosol sprays.
- Do not remove the toner cartridge from the machine unnecessarily.
- Print quality may deteriorate if the drum surface is exposed to light or is damaged.
- Always hold the toner cartridge by its handle to avoid touching the drum.
- Do not place the toner cartridge in an upright or an upside down position. If the toner is kept upright or upside down, the toner will solidify and may not return to its original condition even if it is shaken.
- When disposing of a used toner cartridge, place the toner container into its protective bag to prevent the toner from scattering, and then dispose of the toner cartridge according to local regulations.

Be careful of counterfeit toner cartridges.

Please be aware that there are counterfeit Canon toner cartridges in the marketplace.

Use of counterfeit toner cartridges may result in poor print quality or machine performance.

Canon is not responsible for any malfunction, accident or damage caused by the use of counterfeit toner cartridge.

For more information, see <http://www.canon.com/counterfeit>.

Checking the Toner Level

Keys to be used for this operation

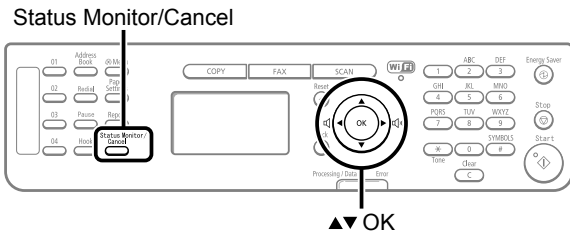

- 1 Press [] (Status Monitor/Cancel).
- 2 Press [▲] or [▼] to select <Device Status>, and then press [OK].

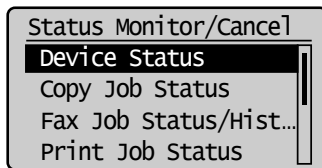

- 3 Press [▲] or [▼] to select <Toner Gauge>, and then press [OK].

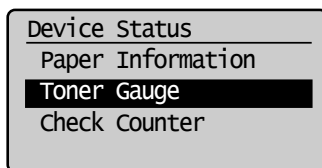

The toner level is displayed.

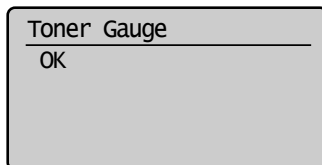

NOTE

Displaying the toner level

The toner level is displayed in three stages.

- <OK>
The message <Prepare toner cartridge.> appears in the display.
- <Low>
The message <Prepare toner cartridge.> appears in the display.
- <Nearly Out>
The message <Toner is nearly out.> appears in the display.
For details on solution, see the following.
 e-Manual → Troubleshooting → Display Messages

- 4 Press [] (Status Monitor/Cancel) to close <Toner Gauge> screen.

Using the Toner Saver Mode

Set whether or not to conserve toner when copying or faxing.



NOTE

If you want to conserve toner when printing

Set to use [Toner Save] on the [Quality] tab of the printer driver.

 e-Manual → Print → Printing Functions → [Quality] Sheet

Keys to be used for this operation

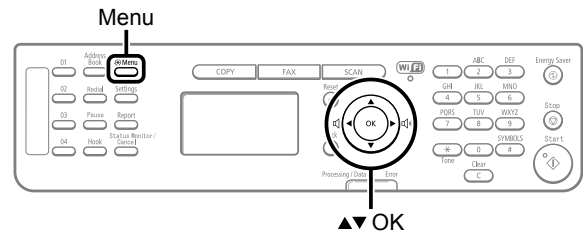

- 1 Press [] (Menu).
- 2 Press [▲] or [▼] to select <Preferences>, and then press [OK].

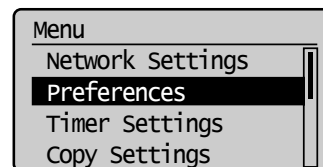

- 3 Press [▲] or [▼] to select <Toner Saver Mode>, and then press [OK].

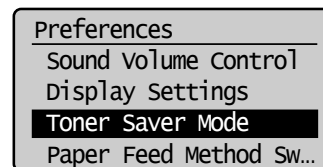

- 4 Press [▲] or [▼] to apply the toner saver mode to an operation, and then press [OK].

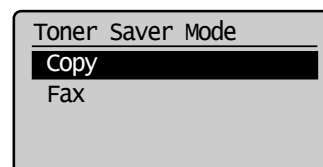

- 5 Press [▲] or [▼] to select <Off> or <On>, and then press [OK].

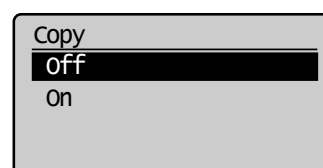

<Off>	Do not use the toner saver mode.
<On>	Use the toner saver mode.

NOTE

When the <Toner Saver Mode> is set to <On>

You may conserve toner, however, the output may be less clear and thin lines or light colors may be printed unclearly.

6 Press [] (Menu) to return to standby mode.

Before Replacing the Toner Cartridge

Before replacing the toner cartridge, see "Replacing the Toner Cartridge" (→P.8-10)

If the toner almost runs out, follow the procedure below before replacing the toner cartridge. You may print for some time, until the toner is completely run out.

1 Hold the operation panel.

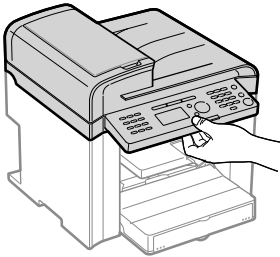

2 Lift the scanning platform.

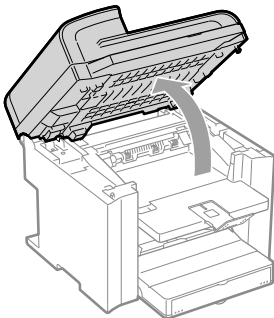

? If you cannot lift the scanning platform

Ensure that the feeder is completely closed.
Do not try to forcefully lift the scanning platform, as this may damage the machine.

* If you set thick documents such as a book, the feeder may not be completely closed. Remove the documents.

3 Hold the grip on the left front side of the toner cover.

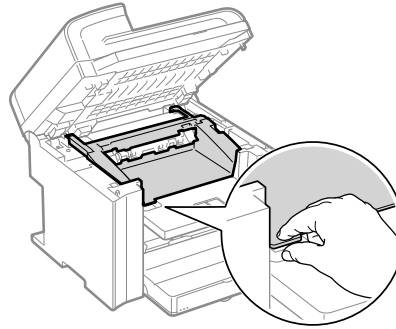

4 Open the toner cover.

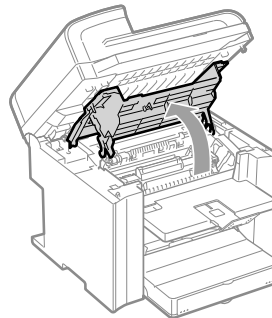

5 Remove the toner cartridge.

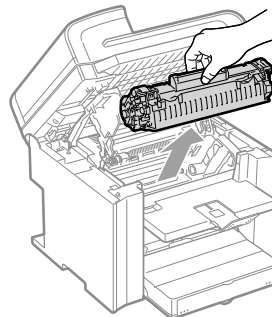

6 Gently shake the toner cartridge five or six times to evenly distribute the toner.

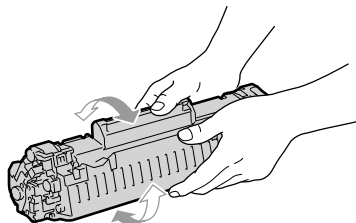

7 Insert the toner cartridge.

Fit the protrusions (A) on each side of the toner cartridge into the guides located on each side of the machine, and then slide the toner cartridge into the machine until the toner cartridge meets the back of the machine.

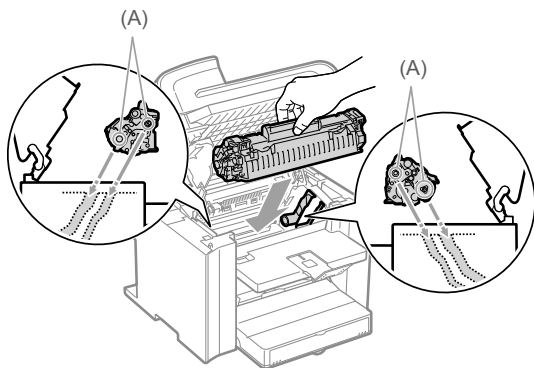

8 Close the toner cover.



If you cannot close the toner cover

Ensure that the toner cartridge is properly set in the machine.
Do not try to forcefully close the toner cover, as this may damage the machine.

9 Lower the scanning platform.

Replacing the Toner Cartridge

Before replacing toner cartridges, see "Precautions when Replacing Toner Cartridge" (→P.8-11)



NOTE

Checking the toner cartridge status

You can check the level of remain toner on the operation panel.

▶ "Checking the Toner Level" (→P.8-8)

1 Hold the operation panel.

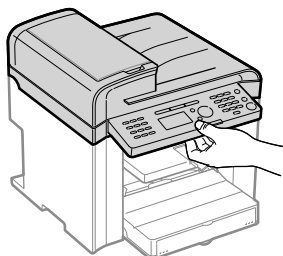

2 Lift the scanning platform.

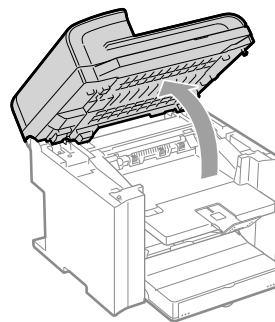

If you cannot lift the scanning platform

Ensure that the feeder is completely closed.

Do not try to forcefully lift the scanning platform, as this may damage the machine.

* If you set thick documents such as a book, the feeder may not be completely closed. Remove the documents.

3 Hold the grip on the left front side of the toner cover.

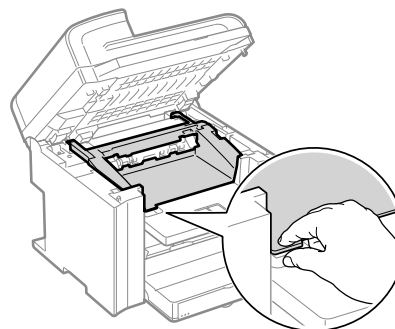

4 Open the toner cover.

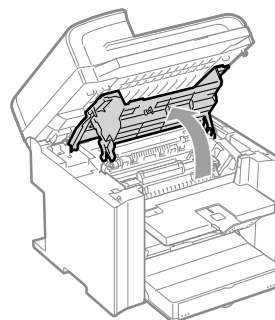

5 Remove the toner cartridge.

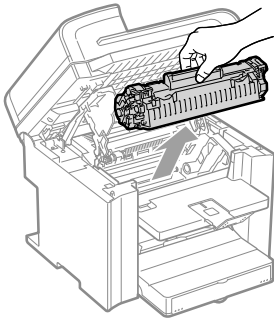

6 Take out the new toner cartridge from the protective bag.

You can open the protective bag with your hands from the notch.

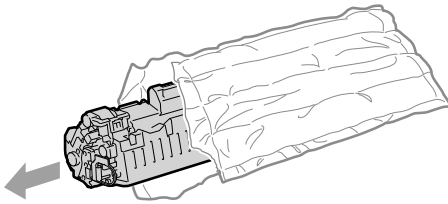

7 Gently shake the toner cartridge five or six times to evenly distribute the toner.

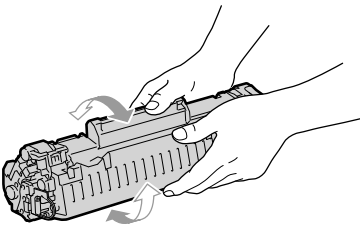

8 Place the toner cartridge on a flat surface, remove the tab, and gently pull the sealing tape completely out.

The full length of the sealing tape is approximately 20" (50 cm).

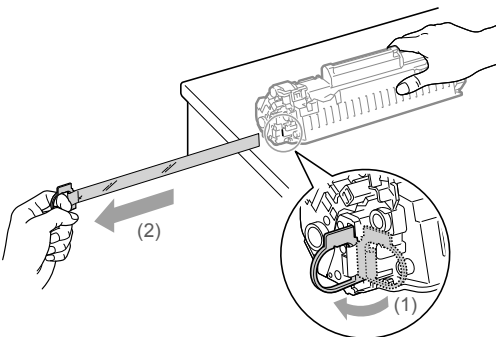

9 Insert the toner cartridge.

Fit the protrusions (A) on each side of the toner cartridge into the guides located on each side of the machine, and then slide the toner cartridge into the machine until the toner cartridge meets the back of the machine.

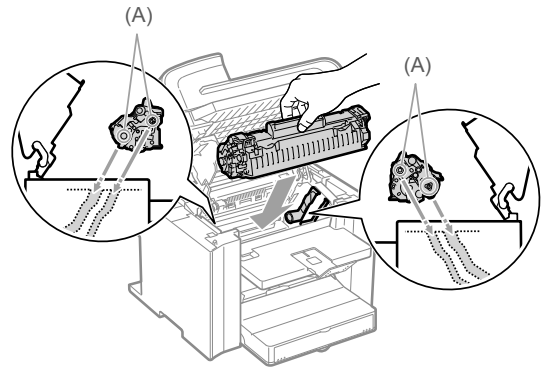

10 Close the toner cover.



If you cannot close the toner cover

Ensure that the toner cartridge is properly set in the machine.
Do not try to forcefully close the toner cover, as this may damage the machine.

11 Lower the scanning platform.

Precautions when Replacing Toner Cartridge

See "Maintenance and Inspections" (→P.xv) in "Important Safety Instructions" as well.

! WARNING

Do not dispose of a used toner cartridge in open flames

This may cause the toner remaining inside the cartridges to ignite, resulting in burns or fire.

! CAUTION

Precautions if you get toner on your hands or clothing

If toner gets on your hands or clothing, wash them immediately with cold water.
Washing with warm water sets the toner, making it impossible to remove the toner stains.

Be careful not to allow the toner to scatter

Do not pull out the sealing tape forcefully or stop at midpoint, as this may cause toner to spill out.
If toner gets into your eyes or mouth, wash them immediately with cold water and consult a physician.

Precautions when lowering the scanning platform

Be careful not to catch your fingers.



IMPORTANT

About replacement toner cartridge

For optimum print quality, replacement is recommended using genuine Canon toner cartridge.

Model name	Supported Canon genuine toner cartridge
MF4570dw	Canon Cartridge 128

Shake the toner cartridge before setting

If toner is not distributed evenly, this may result in a deterioration in print quality.

Hold the toner cartridge properly

When handling the toner cartridge, hold them properly as shown in the figure. Do not place them vertically or upside-down.

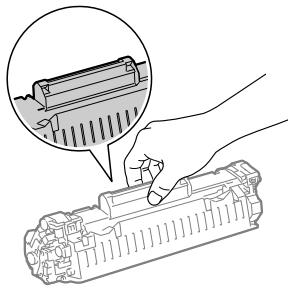

Do not touch the toner cartridge memory (A) or the electrical contacts (B)

This may result in damage to the cartridge.

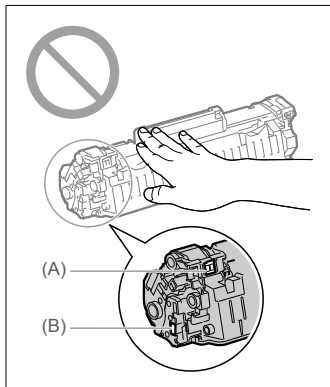

Do not open the drum protective shutter (A).

Print quality may deteriorate if you touch or damage the drum inside of the drum protective shutter (A). Do not touch or open the drum protective shutter (A).

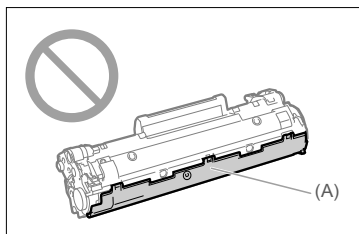

When pulling out the sealing tape

- Do not pull the sealing tape diagonally or sideways. If the tape breaks, this may become difficult to pull out completely.

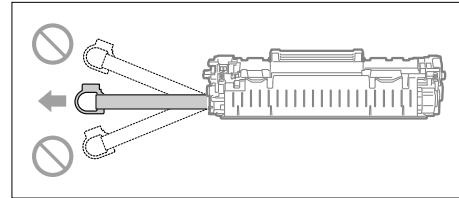

- Even if the sealing tape stops at midpoint, pull it out of the toner cartridge completely.
- If any tape remains in the toner cartridge, this may result in poor print quality.
- If you are using the Fax, please note that you can only print the received data once, because the received data is deleted once it is printed.

Disposing of the removed sealing tape

Dispose of the sealing tape according to local regulations.

Keep the protective bag

Keep the protective bag for the toner cartridge. You will need them when you remove the toner cartridge for machine maintenance or other purposes.

Do not touch the high-voltage contacts (A)

This may result in damage to the machine.

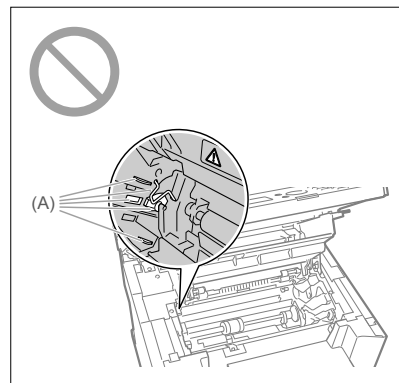

Do not leave the toner cover open for a long time with the toner cartridge installed.

This may result in a deterioration in print quality.



NOTE

About the packing materials

The packing materials may be changed in form or placement, or may be added or removed without notice.

When the message <Toner is nearly out.> appears when receiving a fax

Printing of the fax is interrupted and the received data will be stored in the memory.

If <Continue Print. When Toner Is Nearly Out> is set to <On>

You can keep printing fax documents or reports without replacing a toner cartridge. However, the printed documents may be light or blurred because of lack of toner. The data is erased when the documents are printed out, so you cannot print the same documents again.

- ☑ "Continue Print. When Toner Is Nearly Out" (→P6-22)

Collecting used toner cartridges

- ☑ "Recycling Used Cartridges" (→P8-13)

Purchase Consumables

Purchase at your local authorized Canon dealer. If you are not sure, contact the Canon help line.

Recycling Used Cartridges

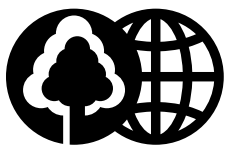

Canon has instituted a worldwide recycling program for cartridges called "The Clean Earth Campaign". This program preserves precious natural resources by utilizing a variety of materials found in the used cartridges that are of no further use, to remanufacture new cartridges which, at the same time, keeps the environment cleaner by reducing landfill waste. Complete details concerning this program are enclosed in each Cartridge box.

The Clean Earth Campaign

THE Canon CARTRIDGE RECYCLING PROGRAM

The Canon Cartridge Recycling Program fulfills the first initiative of Canon's Clean Earth Campaign, which supports four critical environmental areas:

- Recycling in the Workplace
- Conserving Environmental Resources
- Scientific Research and Education
- Encouraging Outdoors Appreciation

The remaining "Clean Earth" initiatives are supported in the U.S. through sponsorships of the National Park Foundation, the National Wildlife Federation, and The Nature Conservancy and in Canada through donations to the World Wildlife Fund Canada and The Nature Conservancy of Canada.

Since its inception, The Canon Cartridge Recycling Program has collected huge amount of cartridges that otherwise would have been discarded into landfills or similar facilities. Instead, this rapidly growing program returns used cartridges to the manufacturing process, thus conserving an array of resources. Becoming a part of this worthwhile program is easy. When your cartridge is of no further use, simply follow the instructions detailed for U.S. or Canadian residents.

We appreciate your support of The Canon Cartridge Recycling Program.

Working together we can make a significant contribution to a cleaner planet.

- Cartridges collected through this program are not refilled.
- You are not entitled to a tax deduction or rebate for the return of empty cartridges.
- This program may be modified or discontinued without notice.

The Clean Earth Campaign

Supporting Environmental Initiatives With

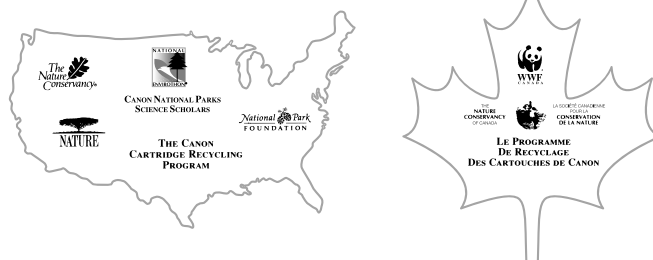

U.S.A. PROGRAM

Packaging

Option A-1: Single Box Return

- Repackage the empty cartridge utilizing the wrapper and pulp mould end-blocks from the new cartridge's box.
- Place the empty cartridge in the box of your new cartridge. Seal the box.

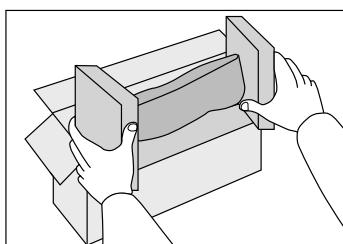

● Option B: Volume Box Return

We encourage you to use this option as a more efficient way to ship cartridges.

- Place as many cartridges as possible into one box.
Carefully seal the box with tape;
or
- Call **1-800-OK-Canon** to receive your free eight cartridge collection box.

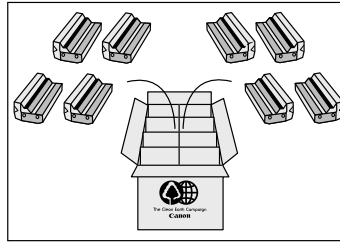

● Option A-2: Multiple Box Return

We encourage you to use this option as a more efficient way to ship cartridges.

- Complete Option A-1.
- Bundle multiple cartridge boxes together securely with tape.

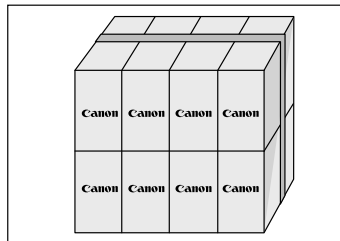

Please be sure that the shipment does not exceed UPS specifications.

Maximum weight = 70 lb. (31.8 kg)

Maximum length = 108" (2,743 mm)

Maximum girth (length + 2 x width + 2 x height) = 130" (3,302 mm)

If your shipment exceeds the above limits, please call 1-800-OK-Canon for special shipping information.

Please Note:

Do not send defective cartridges for replacement.

Defective cartridges under warranty should be exchanged by an authorized dealer or service facility as provided in the warranty.

Shipping

Apply the UPS authorized returning label provided in this guide.

Residents of Alaska and Hawaii: Do not use the UPS authorized returning label. For Alaska and Hawaii Canon set up alternative mail service with the U.S. Postal Service.

Please call 1-800-OK-Canon to receive U.S. Postal Service merchandise returning label.

- Give the shipment to your UPS driver when you receive your next regular delivery; (UPS may charge a fee for customers who call UPS to pick up a cartridge shipment if they do not already have a delivery scheduled.)
or
- Take the shipment to your local UPS receiving point.



● Option A: Single Box Return

- Repackage the empty cartridge utilizing the wrapper and pulp mould end-blocks from the new cartridge's box.
- Place the empty cartridge in the box of your new cartridge. Seal the box.
- Apply the Canon Canada Inc./Canada Post label provided in this brochure. Canon's labels are specially marked so that Canon pays the postage.
- Deposit your empty cartridge in any full size street mailbox or take it to your local Canada Post outlet or franchise.

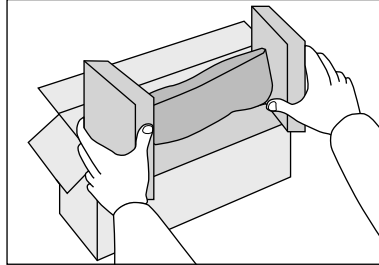

● Option B: Volume Box Return (eight or more cartridges)

We encourage you to use this option as a more efficient way to ship cartridges.

- Call **1-800-667-2666** to receive your free Canon collection box kit.
- The collection box can accommodate eight individual cartridge boxes.
- Place your eight individually packaged boxes of empty cartridges into the Canon collection box. Seal the box.
- Apply the Canon Canada Inc./Canada Post label provided in this brochure.
- Canon's labels are specially marked so that Canon pays the postage.
- Deliver to any local Canada Post outlet or franchise. Customers who hold a Commercial pick-up agreement with Canada Post may have their collection box picked up.

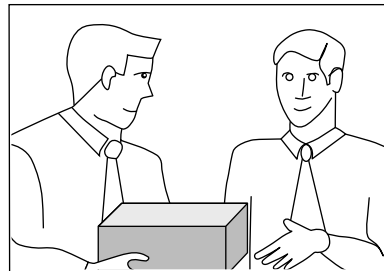
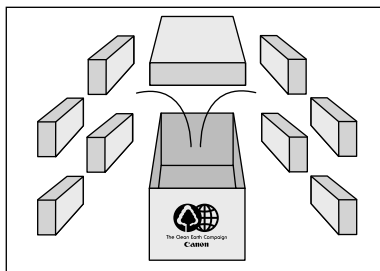

Working to preserve endangered species is a long-standing Canon interest.

To this end, for every cartridge collected, Canon Canada donates \$1, shared equally between World Wildlife Fund Canada and the Nature Conservancy of Canada. This donation is utilized in Canada.

- For further information about The Clean Earth Campaign in Canada, please call or write to Canon.

1-800-667-2666

Canon Canada Inc.
Corporate Customer Relations
6390 Dixie Road
Mississauga, ON L5T 1P7

Transporting the Machine

Before transporting the machine, see "Precautions when Transporting the Machine" (→P8-17)

When changing the location of the machine or moving the machine for maintenance, be sure to perform the following procedure.

- 1 Turn OFF the machine and any connected computer.

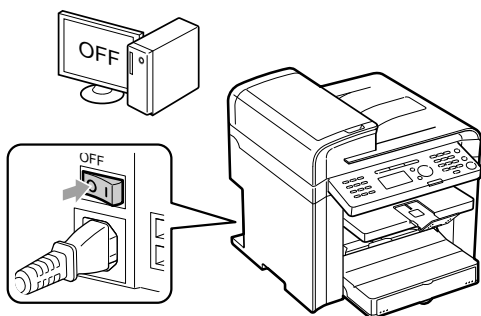

- 2 Disconnect all cables and the power cord from the machine.

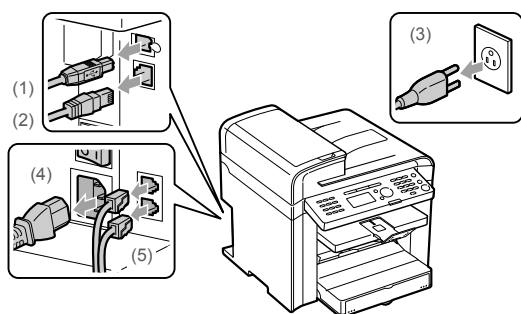

How to remove the cables and cord

USB cable*	(1) Remove it from the machine.
LAN cable*	(2) Remove it from the machine.
Power cord	(3) Unplug the power plug from the AC power outlet. (4) Remove it from the machine.
Telephone cables*	(5) Remove it from the machine.

* Whether the cable is connected or not varies depending on your environment.

- 3 Close the document feeder tray.

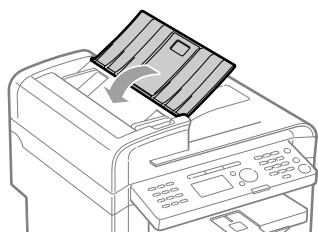

If documents are set in the document feeder tray

Remove all documents from the document feeder tray.

- 4 Fold the paper stopper, and then push the output tray extension into the machine.

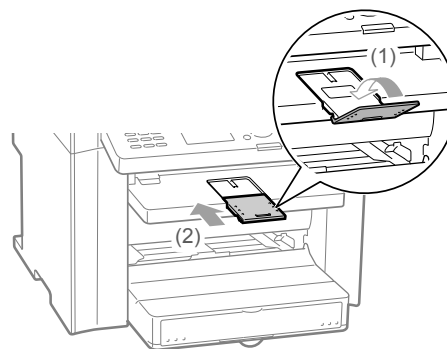

If paper is in the output tray

Remove the paper from the output tray.

- 5 Lift the dust cover.

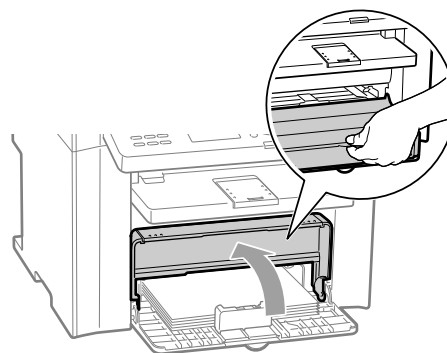

If paper is set in the multi-purpose tray

Remove the paper from the multi-purpose tray.

6 Remove any paper from the paper cassette.

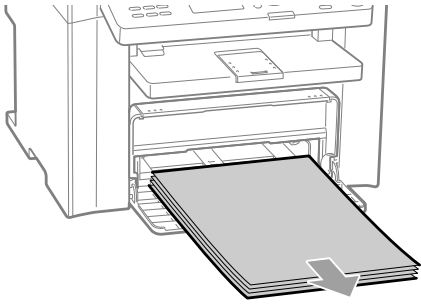

NOTE

If the paper guide at the front projects from the paper cassette

Push the paper guide into the paper cassette.

7 Lower the dust cover.

8 Close the paper cassette.

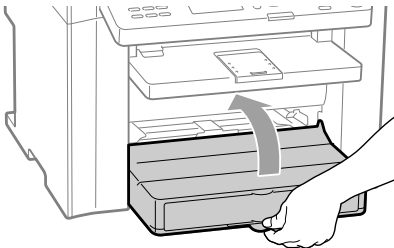

9 Move the machine.

Ensure that all covers and trays are closed, and hold the lift handles with the front side of the machine facing you.

Check the weight of the machine to carry it safely.

▶ "Main Specifications" (→P.11-2)

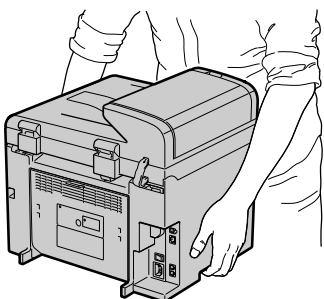
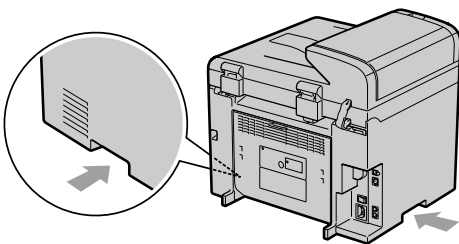

10 Carefully set the machine down on the new installation site.

NOTE

When reinstalling the machine

Refer to the supplied Starter Guide.

When transporting the machine long distance

To prevent damage to the machine during transportation, refer to the following.

- Remove the toner cartridge.
- Securely pack the printer in its original box with the original packing materials.
- * If the original box and packing materials are not available, find an appropriate box along with packing materials and pack the machine and the parts appropriately.

Precautions when Transporting the Machine

WARNING

When transporting the machine

Be sure to turn off the power switches of the machine and your computer, and then unplug the power plug and interface cables.

Failure to do so can damage the cables or cords, resulting in a fire or electrical shock.

CAUTION

Set the machine down slowly and carefully.

Be careful not to hurt your hands or fingers.

IMPORTANT

Do not carry the machine with covers or trays open.

Make sure that the scanning platform and paper cassette are closed before carrying the machine.

Troubleshooting

This section describes solutions for cases such as paper jam and when problems are not solved.

Clearing Jams	9-2	Print Result Is Not Good	9-13
Document Jams in the Feeder	9-3	Paper Curls	9-13
Paper Jams Inside the Machine	9-3	Paper Creases	9-14
Display Message	9-6	Printing Is Uneven	9-14
Error Codes	9-6	White Specks Appear	9-15
If <Incorrect Size/Setting> Appears	9-8	The Toner Does Not Fix onto the Paper Well	9-16
Troubleshooting	9-9	The Printed Paper Has Vertical Streaks	9-16
Check the Following First	9-9	Smudge Marks of Spattering Toner Appear around the Text or Patterns	9-17
Is the power switched ON?	9-9	The Overall Print Result Is Dark	9-17
Has the power switch been just turned ON?	9-9	Copied Lines and Text Appear Faded	9-18
Is the machine in Sleep mode?	9-9	Printed Bar Codes Cannot Be Scanned	9-18
Are the settings proper?	9-9	Paper Jams Occur Frequently When Performing 2-Sided Printing	9-18
Is the Error indicator on or blinking?	9-9		
Does a message appear on the display?	9-10		
Is the telephone line connected or configured properly?	9-10		
If You Cannot Solve a Problem	9-10		
If a Power Failure Occurs	9-11		
If You Cannot Solve a Problem	9-12		
Customer Support (U.S.A.)	9-12		
Customer Support (Canada)	9-12		

Clearing Jams

Keys to be used for this operation

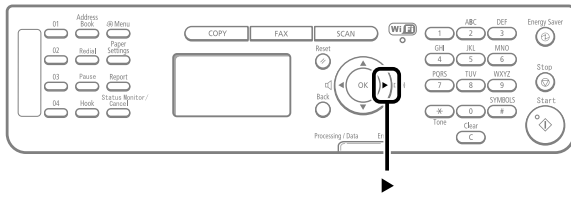

When <Paper jam.> appears on the display, a paper jam has occurred in the feeder or inside the machine. To remove the jammed document or paper, follow the instructions on the display. Press [▶] to view the next step.

⌘ Paper jam.
Press [▶] to display steps. ▶

- ▶ "Document Jams in the Feeder" (→P.9-3)
- ▶ "Paper Jams Inside the Machine" (→P.9-3)

! WARNING

When removing the jammed document or paper

Use caution to avoid cutting your hands.

When removing jammed paper or when inspecting the inside of the machine

Do not allow necklaces, bracelets, or other metal objects to touch the inside of the machine, as this may result in burns or electrical shock.

! CAUTION

If loose toner comes into contact with your skin or clothing

Wash with cold water. Avoid warm water, as this will set the toner and cause it to stain your skin or clothing.

When removing the jammed document or paper

If paper is jammed, remove the jammed paper so that any pieces of paper do not remain inside the machine according to the displayed message. Also, do not put your hand in an area other than indicated areas, as this may result in personal injuries or burns.

Do not touch the fixing unit (A).

Touching the fixing unit (A) may cause burns as it becomes very hot during use.

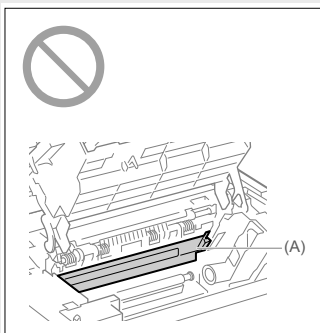

! IMPORTANT

If the jammed paper is torn

Remove all torn pieces to avoid further jams.

If repeated paper jams occur

Check the following.

- Ensure that the following packing material is completely removed.

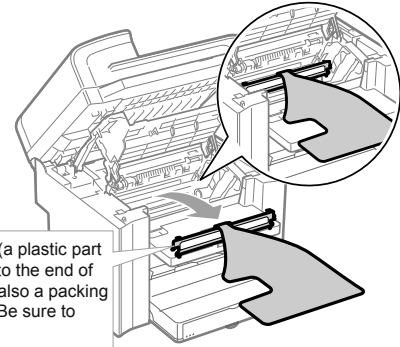

This part (a plastic part attached to the end of paper) is also a packing material. Be sure to remove it.

- Fan the paper stack and tap the edge on a flat surface to align the paper before loading it into the machine.
- Ensure that the paper you are using meets the requirements for use.
 - ▶ "Paper Requirements" (→P.2-6)
- Ensure that you have removed all scraps of paper from the inside of the machine.

Do not touch the transfer roller (A).

Touching the transfer roller (A) may damage the machine.

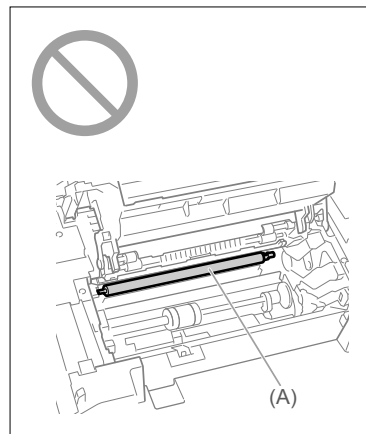

! NOTE

Do not force the jammed document or paper out of the machine

Contact your local authorized Canon dealer or the Canon help line for assistance, if needed.

Document Jams in the Feeder

Referring to the procedure on the display, follow the steps below to remove jammed documents.

- 1 Remove any document loaded in the feeder.
- 2 Open the feeder cover.

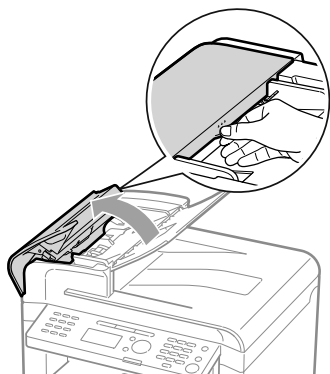

- 3 Remove any jammed document by pulling it gently.

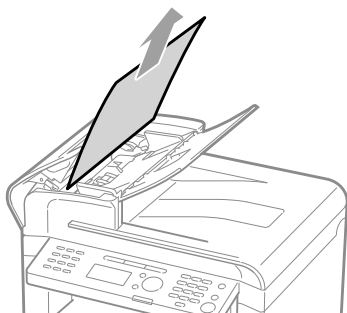

- 4 Close the feeder cover.

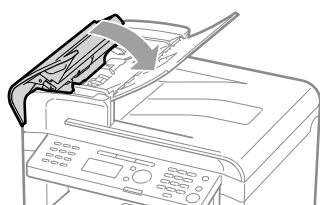

- 5 Place documents in the feeder.

Paper Jams Inside the Machine

Referring to the procedure on the display, follow the steps below to remove jammed paper.

- 1 Hold the operation panel.

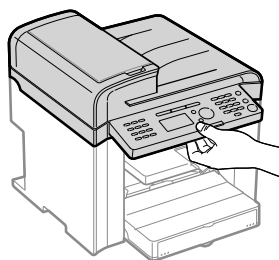

- 2 Lift the scanning platform.

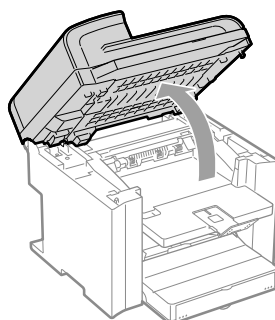

If you cannot lift the scanning platform

Ensure that the feeder is completely closed.

Do not try to forcefully lift the scanning platform, as this may damage the machine.

* If you set thick documents such as a book, the feeder may not be completely closed. Remove the documents.

- 3 Hold the grip on the left front side of the toner cover.

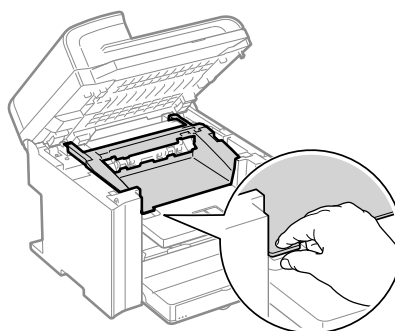

4 Open the toner cover.

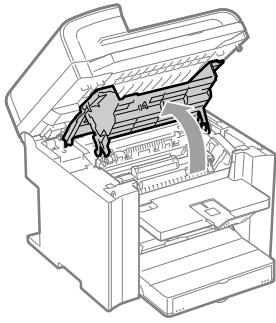

5 Remove the toner cartridge.

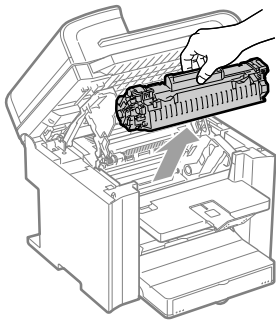

6 Remove any jammed paper by pulling it gently.

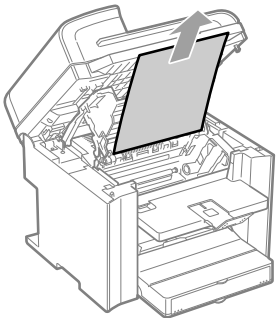

If you do not see the leading edge of the jammed paper
Do not force to pull the paper, and proceed to step 7.

7 Push up the green colored part (A), and then pull the paper exit guide to open.

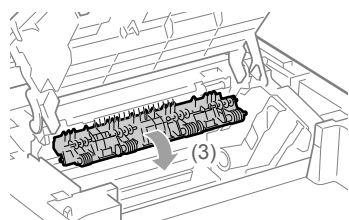
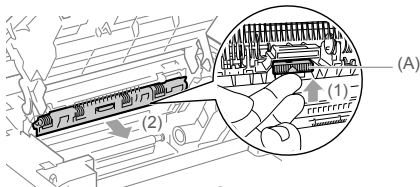

8 Remove any jammed paper by pulling it gently.

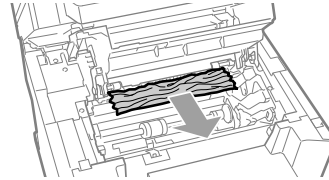

If you do not see the leading edge of the jammed paper
Do not force to pull the paper, and proceed to step 9.

9 Lift the paper exit guide, and then firmly close it.

Ensure that each end of the paper exit guide is closed.

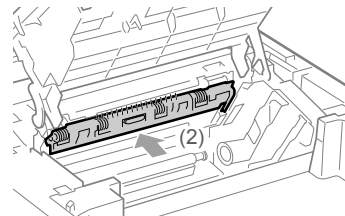
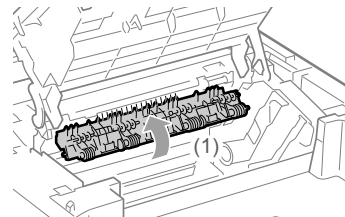

10 Remove any jammed paper by pulling it gently.

(1) Gently pull any jammed paper downward from between the fixing unit (A) and transfer roller (B) until the leading edge emerges from the machine.

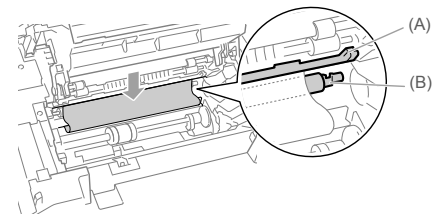

(2) When the leading edge emerges, hold both sides of the jammed paper and carefully pull it out.

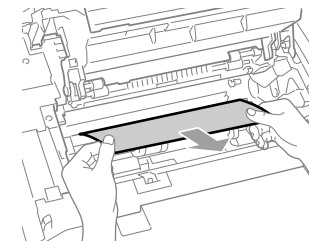

11 Remove any jammed paper by pulling it gently.

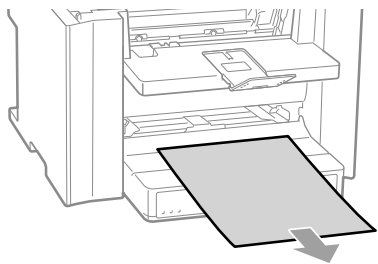

12 Lift the dust cover.

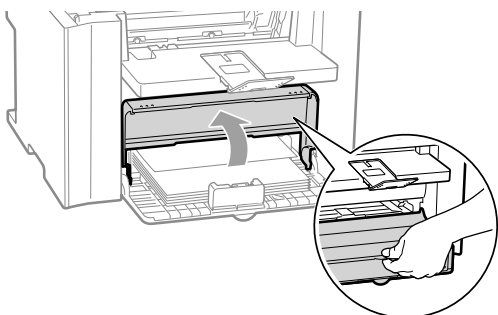

13 Remove any paper loaded in the paper cassette.

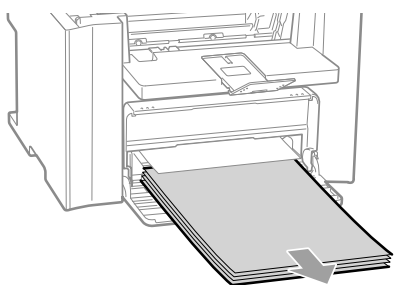

14 Remove any jammed paper by pulling it gently.

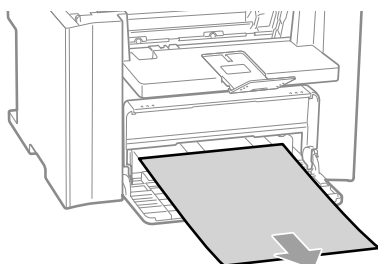

15 Reload paper into the paper cassette and lower the dust cover.

▶ Next, continue to clear jams in the rear cover.

16 Open the rear cover.

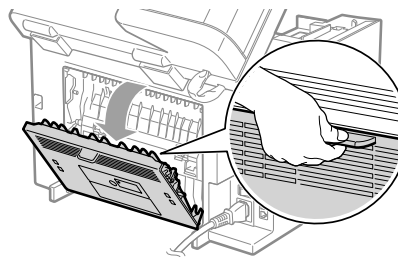

17 Remove any jammed paper by pulling it gently.

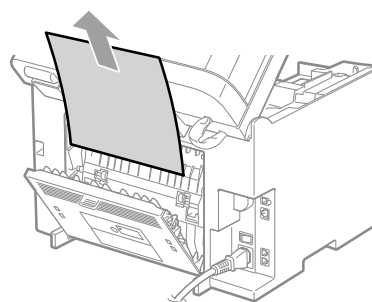

18 Close the rear cover.

19 Insert the toner cartridge.

Fit the protrusions (A) on each side of the toner cartridge into the guides located on each side of the machine, and then slide the toner cartridge into the machine until the toner cartridge meets the back of the machine.

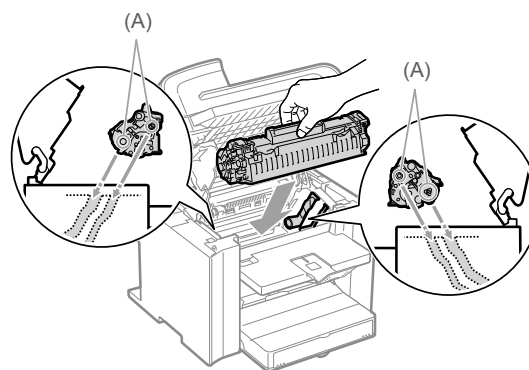

20 Close the toner cover.



If you cannot close the toner cover

Ensure that the toner cartridge is properly set in the machine. Do not try to forcefully close the toner cover, as this may damage the machine.

21 Lower the scanning platform.

The machine is ready to print.

● Display Message

If messages appear, see the following and solve the problem.
 📖 e-Manual → Troubleshooting → Display Messages

● Error Codes

An error code is a 3-digit code recorded as an error log when an error occurs. You can view the code in the following locations.

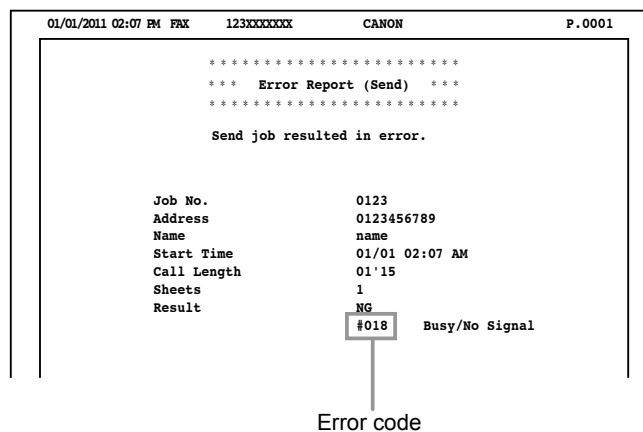

Error codes for fax jobs	<ul style="list-style-type: none"> • Error send report • Error receive report • Job history in the system status screen
---------------------------------	--



For details on the reports, refer to the following.
 📖 e-Manual → Basic Operation → Setting the Report to Print Automatically

For details on the error code, see the following.

#001	Cause	A document may be jammed.
	Action	Remove the jammed document.
#003	Cause	A high volume of data is causing the transmission to take a very long time.
	Action 1	Reduce the scanning resolution, and then try to send the document again.
	Action 2	Reduce the scanning resolution or ask the sender to divide the document before sending it again.
#005	Cause 1	A fax recipient did not respond within 35 seconds.
	Action	Repeat the procedure from the first step. Additionally, ask the recipient to check the fax machine. If you are making an overseas call, add a pause to the fax number.
	Cause 2	The recipient may not be using a G3 fax machine.
	Action	Ask the recipient what type of fax machine is being used, and then send the document to the recipient's G3 fax machine. If the recipient does not have a G3 fax machine, send the document again using a communication mode compatible with the recipient's fax machine.
#012	Cause	The recipient's machine has run out of paper.
	Action	Ask the recipient to ensure that paper is loaded in their machine.
#018	Cause 1	Redialing was not able to obtain any response. The line may be in use or disconnected.
	Action	Wait a moment, and then try again. If you are still unable to send the document, ask the recipient to verify that the fax machine is turned ON. If the line is busy, wait a few moments, and try to send the document again.
	Cause 2	You were not able to send the document because the line is busy or disconnected.
	Action	Verify that the recipient can communicate with you, and then try again.
	Cause 3	The settings on the recipient's machine are incompatible with yours.
	Action	Verify that the recipient can communicate with you, and then try again.
	Cause 4	No pause was added to the fax number when attempting an international fax transmission.
Action	Add a pause after the country code or the recipient's fax number, and then redial the number. If you want to send the document to a recipient that is registered under a one-touch key, change the settings for international sending in the detailed setting screen.	

#022	Cause	Sending faxes from a computer is restricted.
	Action	The restriction needs to be canceled. Contact your administrator for more details.  e-Manual → Security → Restricting Destination Operations/Sending Functions → Restricting Fax Sending from a Computer
#037	Cause 1	The machine's memory is full.
	Action 1	Print, send, or delete any documents stored in the memory.
	Action 2	For a copy job, divide the document into two or set <Original Type> to <Text/Photo (High Speed)> before copying.  e-Manual → Copy → Selecting Image Quality (Copy)
	Cause 2	The data size exceeds the machine's available memory.
	Action	Reduce the data resolution or change the file format to reduce the data volume.
#054	Cause 1	A user abbreviation or a user fax number is not registered when sending a fax from a computer.
	Action	Register the user abbreviation and the user fax number.
	Cause 2	The recipient's fax number exceeds 40 digits when sending a fax from a computer or importing a destination from the address book.
	Action	Reduce the recipient's fax number under 40 digits.
#099	Cause	You unintentionally canceled a job.
	Action	Try to resend the job.
#995	Cause	The job waiting to be sent or received has canceled by a user.
	Action	Retry to send or receive the job as needed.



If <Incorrect Size/Setting> Appears

The message appears when the paper size specified in <Drawer 1>, or <MP Tray> in the <Paper Settings> menu is different from the size of the paper loaded in the paper cassette or multi-purpose tray. If the message appears, perform the following operations.



NOTE

When printing using the printer driver

To ignore the message and proceed to print on paper that is currently set, press [▲] or [▼] to select <Resume>, and then press [OK]. However, images may be printed improperly, for example, part of images may not be printed.

Change the <Paper Settings> menu according to the size of the loaded paper.

Cancel the job, see “Setting a Paper Size and Type” (→P.2-14), and then change <Paper Settings>.



IMPORTANT

When printing using the printer driver

Check that the paper size setting on the computer is also correct.

Loading paper of the size specified in the <Paper Settings> menu

- (1) See “Loading Paper” (→P.2-9) and reload the paper specified in the <Paper Settings> menu.
- (2) Press [▲] or [▼] to select <Resume>, and then press [OK].

● Troubleshooting

If one of the following problems occurs during use, try the actions suggested here before contacting technical support.

Check the Following First

Is the power switched ON?

Ensure that the power cord is securely plugged into the machine and into the wall outlet.

Ensure that electricity is supplied from the power cord. Use another power cord or verify that cord is broken using a voltmeter.

Turn ON the power switch.

If there is no problem



Has the power switch been just turned ON?

Wait a moment for the machine starts and warm up.

If there is no problem



Is the machine in Sleep mode?

Press [] (Energy Saver) on the operation panel to exit the Sleep mode.

If there is no problem



Are the settings proper?

If the machine emits the entry error tone and does not start operating when you press [] (Start), your combination of settings may be invalid. Recheck the settings.

If there is no problem



Is the Error indicator on or blinking?

Ensure that paper is loaded properly in the paper cassette or multi-purpose tray.

▶ "Loading Paper" (→P.2-9)

Check if paper is jammed.

▶ "Clearing Jams" (→P.9-2)

Turn OFF the power switch of the machine, wait for more than 10 seconds, and then turn it ON. If the problem is solved, the Error indicator will turn off and the display will return to standby mode. If the Error indicator keeps blinking, unplug the power cord and contact your local authorized Canon dealer or the Canon help line.

If there is no problem



Does a message appear on the display?

If an error message appears on the display, refer to the following section to locate the appropriate corrective action.

▶ "Display Message" (→P.9-6)

Print the transmission management report to see if any errors are listed.

📖 e-Manual → Basic Operation → Printing a List → Printing a Communication Management Report

If there is no problem



Is the telephone line connected or configured properly?

Ensure that the telephone cable is properly connected. Check if the cables for the telephone line port and external device port on the back of the machine are connected inversely.

📖 "Configuring and Connecting the Fax" (→ Starter Guide)

Ensure that the line type setting (dial or push) corresponds to the type of telephone line that is connected to the machine.

▶ "Select Line Type" (→P.6-20)

Ensure that the telephone line is not receiving interference from nearby devices such as a microwave oven. This may affect status of the telephone line.

If there is no problem



If You Cannot Solve a Problem

See "Troubleshooting" in the e-Manual, then solve the problem.

● If a Power Failure Occurs

The machine cannot be used while power supply is cut off.

The fax function during a power failure

- Documents cannot be sent or received.
- You may not be able to make a call using the external telephone depending on your telephone.
- You may be able to get a call using the external telephone depending on your telephone.



IMPORTANT

Data storage for when power supply is cut off

Even if power is lost due to a power failure or accidental unplugging, any sent or received documents stored in the memory are backed up for approximately 5 minutes.



NOTE

Charging the built-in battery

It takes approximately 24 hours to fully charge the built-in battery after the machine is turned ON.

If the built-in battery has not been charged fully charged, documents stored in the memory may not be properly backed up.

If You Cannot Solve a Problem

Customer Support (U.S.A.)

If you cannot solve the problem after having referred to the information in this chapter, contact Canon Customer Care Center at 1-800-OK-CANON Monday through Friday between the hours of 8:00 A.M. to 8:00 P.M. EST. On-line support is also available 24 hours a day at the website <http://www.canontechsupport.com>.

Please have the following information ready when you contact Canon:

- Product name (imageCLASS MF4570dw)
- Serial number (a character string which consists of three alphabets and a 5-digit number and is indicated on the rating label located on the rear side of the machine)

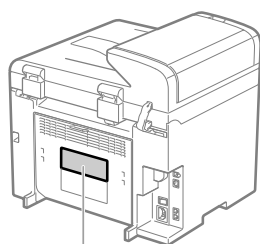

Rating label

- Place of purchase
- Nature of problem
- Steps you have taken to solve the problem and the results

IMPORTANT

WARNING

If the machine makes strange noises or emits smoke or odd odor

Turn OFF the power switch immediately, disconnect the power cord, and contact Canon Customer Care Center. Do not attempt to disassemble or repair the machine yourself.

If you attempt to repair the machine by yourself

It may void the limited warranty.

Customer Support (Canada)

Canon Canada Inc., offers a full range of customer technical support options*:

- * Support program specifics are subject to change without notice.
- For step-by-step troubleshooting, e-mail technical support, the latest driver or document downloads, and answers to frequently asked questions, visit <http://www.canon.ca/>
- Free live technical support 9 A.M. to 8 P.M. EST Monday through Friday (excluding holidays) for products still under warranty 1-800-OK-CANON
- For the location of the authorized service facility nearest you, visit <http://www.canon.ca/> or 1-800-OK-CANON
- If the problem cannot be corrected by using one of the above technical support options, repair options are available at the time of your call to the live technical support number above or via the website at <http://www.canon.ca/>
- * Support program specifics are subject to change without notice.

Please have the following information ready when you contact Canon:

- Product name (imageCLASS MF4570dw)
- Serial number (a character string which consists of three alphabets and a 5-digit number and is indicated on the rating label located on the rear side of the machine)

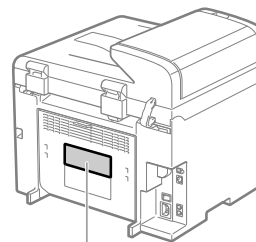

Rating label

- Place of purchase
- Nature of problem
- Steps you have taken to solve the problem and the results

IMPORTANT

WARNING

If the machine makes strange noises or emits smoke or odd odor

Turn OFF the power switch immediately, disconnect the power cord, and contact Canon Customer Care Center. Do not attempt to disassemble or repair the machine yourself.

If you attempt to repair the machine by yourself

It may void the limited warranty.

Paper Creases

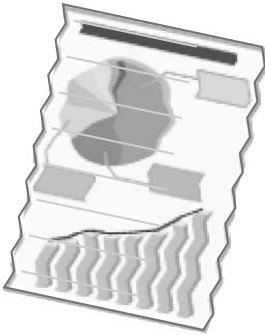

Perform one of the following solutions according to the cause.

<Cause 1> The paper is not loaded properly.

Solution	Load the paper properly. ☑ "Loading Paper" (→P.2-9)
-----------------	--

<Cause 2> Damp paper is used.

Solution	Replace the paper with new paper in an unopened package. ☑ "Paper Requirements" (→P.2-6)
-----------------	---

<Cause 3> Appropriate paper is not being used.

Solution	Replace the paper with which can be used with this printer. ☑ "Paper Requirements" (→P.2-6)
-----------------	--

<Cause 4> There is a foreign object inside the printer.

Solution	Remove the foreign object inside the printer.
-----------------	---

<Cause 5> Depending on the paper type or the operating environment, the paper may be creased.

Solution	<p>Change the <Special Mode V> settings from the operation panel. e-Manual → Maintenance → Special Mode The level of improvement according to the setting option is as following.</p> <table border="1" style="margin-left: 20px;"> <tr> <td style="text-align: center;"><Off></td> <td style="text-align: center;">→</td> <td style="text-align: center;"><Mode 1></td> <td style="text-align: center;">→</td> <td style="text-align: center;"><Mode 2></td> <td style="text-align: center;">→</td> <td style="text-align: center;"><Mode 3></td> </tr> <tr> <td style="text-align: center;">(low)</td> <td></td> <td></td> <td></td> <td></td> <td></td> <td style="text-align: center;">(high)</td> </tr> </table> <ul style="list-style-type: none"> * Change of paper type or environment may reduce the curl or wrinkle problem, even without changing the setting. * This setting is available when <ul style="list-style-type: none"> • the <Paper Size> is set to <B5>, <A5>, <STMT>, or <EXEC> • the <Paper Type> is set to <Plain (16 lb Bond-24 lb Bond)>, <Plain L (16 lb Bond-24 lb Bond)>, <Recycled>, <Color>, <Rough 1 (16 lb Bond-24 lb Bond)>, or <Envelope> * As you select an option that has higher effect, printing speed becomes slower. 	<Off>	→	<Mode 1>	→	<Mode 2>	→	<Mode 3>	(low)						(high)
<Off>	→	<Mode 1>	→	<Mode 2>	→	<Mode 3>									
(low)						(high)									

Printing Is Uneven

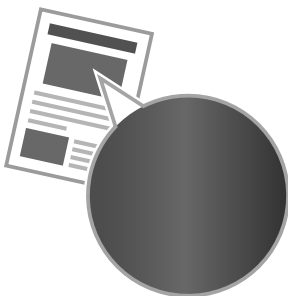

Perform one of the following solutions according to the cause.

<Cause 1> Paper is too moist or Too dry.

Solution	Replace the paper with new paper in an unopened package. ☑ "Paper Requirements" (→P.2-6)
-----------------	---

<Cause 2> Toner is nearly out.

Solution	To view the solution, refer to the following. ☑ "Replacing the Toner Cartridge" (→P.8-10)
-----------------	--

<Cause 3> The drum in the toner cartridge is deteriorated.

Solution	Replace the toner cartridge with a new one. ☑ "Replacing the Toner Cartridge" (→P.8-10)
-----------------	--

<Cause 4> Unevenness may appear when thin lines are printed.

Solution	Change the <Special Mode J> setting to <On> from the operation panel. 📖 e-Manual → Maintenance → Special Mode * If you use this mode, the following problems may occur. <ul style="list-style-type: none">• The output is less fine.• Toner smears even on unnecessary parts.• Toner consumption increases.
-----------------	---

White Specks Appear

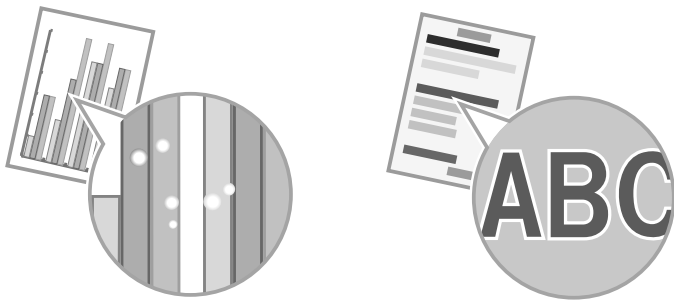

Perform one of the following solutions according to the cause.

<Cause 1> Appropriate paper is not being used.

Solution	Replace the paper with which can be used with this printer. ☑ "Paper Requirements" (→P.2-6)
-----------------	--

<Cause 2> Damp paper is used.

Solution	Replace the paper with new paper in an unopened package. ☑ "Paper Requirements" (→P.2-6)
-----------------	---

<Cause 3> The drum in the toner cartridge is deteriorated.

Solution	Replace the toner cartridge with a new one. ☑ "Replacing the Toner Cartridge" (→P.8-10)
-----------------	--

<Cause 4> When you print a document of highly contrasting density, white specks may appear on the outlines of the text or images.

Solution	Change the [Special Print Mode] setting to [Special Settings 2] from the printer driver. 📖 e-Manual → Maintenance → Special Mode * When [Special Settings 2] is selected, printing density is lower than when [Off] or [Special Settings 1] is selected. Also, text or lines may be less clear.
-----------------	--

The Toner Does Not Fix onto the Paper Well

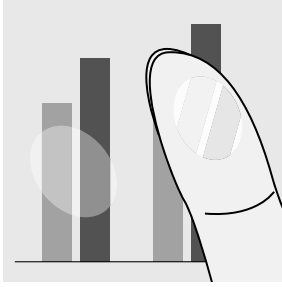

Perform one of the following solutions according to the cause.

<Cause 1> Paper type setting is not specified properly.

Solution	<p>Properly specify the paper type setting.</p> <ul style="list-style-type: none"> * If you are using coarse paper, select one of the followings. <ul style="list-style-type: none"> • <Rough 1 (16 lb Bond-24 lb Bond)> • <Rough 2 (24 lb Bond-32 lb Bond)> • <Rough 3 (45 lb Cover-60 lb Cover)> <p><input checked="" type="checkbox"/> "Setting a Paper Size and Type" (→P.2-14)</p>
-----------------	--

<Cause 2> Appropriate paper is not being used.

Solution	<p>Replace the paper with which can be used with this printer.</p> <p><input checked="" type="checkbox"/> "Paper Requirements" (→P.2-6)</p>
-----------------	---

<Cause 3> Depending on the environment (in low temperature environments), toner may not be fixed sufficiently, and output may be less clear.

Solution	<p>Change the <Special Mode K> setting to <On> from the operation panel.</p> <p> e-Manual → Maintenance → Special Mode</p> <ul style="list-style-type: none"> * Change of environment may improve the toner fixation, even without changing the setting. * If you use this mode, printing speed becomes slow.
-----------------	---

The Printed Paper Has Vertical Streaks



Perform one of the following solutions according to the cause.

<Cause 1> Depending on the paper type or the operating environment, vertical streaks may appear on the printed paper.

Solution 1	<p>Replace the paper with new paper in an unopened package.</p> <p><input checked="" type="checkbox"/> "Paper Requirements" (→P.2-6)</p>										
Solution 2	<p>When copying or printing received faxes Change the <Special Mode Z> setting from the operation panel.</p> <p>When printing from a computer Change the [Special Print Adjustment] setting from the print driver.</p> <p> e-Manual → Maintenance → Special Mode</p> <p>The level of improvement according to the setting option is as following.</p> <table border="1" style="width: 100%; text-align: center;"> <tr> <td><Off></td> <td>→ <Mode 1></td> <td>→ <Mode 2></td> <td>→ <Mode 3></td> <td>→ <Mode 4></td> </tr> <tr> <td>(low)</td> <td></td> <td></td> <td></td> <td>(high)</td> </tr> </table> <ul style="list-style-type: none"> * Change of paper type or environment may reduce the streaks, even without changing the setting. * As you select an option that has higher effect, printing density becomes lower. Outlines of printed text or images may be less clear, or images may be slightly jagged. 	<Off>	→ <Mode 1>	→ <Mode 2>	→ <Mode 3>	→ <Mode 4>	(low)				(high)
<Off>	→ <Mode 1>	→ <Mode 2>	→ <Mode 3>	→ <Mode 4>							
(low)				(high)							

Solution 3	<p>When printing received faxes Change the <Special Mode C> setting to <On> from the operation panel.</p> <p>When printing from a computer Change the <Special Mode D> setting to <On> from the print driver.</p> <p>☰ e-Manual → Maintenance → Special Mode</p> <ul style="list-style-type: none"> * Change of paper type or environment may reduce the streaks, even without changing the setting. * This mode is more effective than <Special Mode Z>, however, printing speed becomes slow. * This mode has higher priority than <Special Mode Z>.
-------------------	---

<Cause 2> The toner cartridge was replaced, or the printer was not printed for a long period of time.

Solution	<p>Change the <Special Mode B> setting from the operation panel.</p> <p>☰ e-Manual → Maintenance → Special Mode</p> <p>The level of improvement according to the setting option is as following.</p> <table border="1" style="margin-left: 20px;"> <tr> <td style="text-align: center;"><Off> → <Mode 1> → <Mode 2> → <Mode 3></td> </tr> <tr> <td style="text-align: center;">(low) (high)</td> </tr> </table> <ul style="list-style-type: none"> * Change of paper type or environment may reduce the streaks, even without changing the setting. * As you select an option that has higher effect, printing speed becomes slower. 	<Off> → <Mode 1> → <Mode 2> → <Mode 3>	(low) (high)
<Off> → <Mode 1> → <Mode 2> → <Mode 3>			
(low) (high)			

Smudge Marks of Spattering Toner Appear around the Text or Patterns

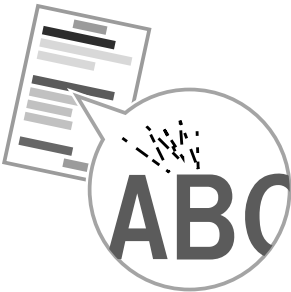

Perform one of the following solutions according to the cause.

<Cause 1> Appropriate paper is not being used.

Solution	<p>Replace the paper with which can be used with this printer.</p> <p>☑ "Paper Requirements" (→P.2-6)</p>
-----------------	---

<Cause 2> Depending on the paper type (especially for heavy paper) or the operating environment (especially in dry environments), smudge marks of spattering toner may appear.

Solution	<p>Change the <Special Mode U> settings to <On> from the operation panel.</p> <p>☰ e-Manual → Maintenance → Special Mode</p> <ul style="list-style-type: none"> * Maintain this setting <Off> in normal conditions. Change the setting only when the problems mentioned above occur. * If you use this mode, printing quality may become lower depending on the paper type (especially for thin paper) or environment (especially in wet environments)
-----------------	--

The Overall Print Result Is Dark

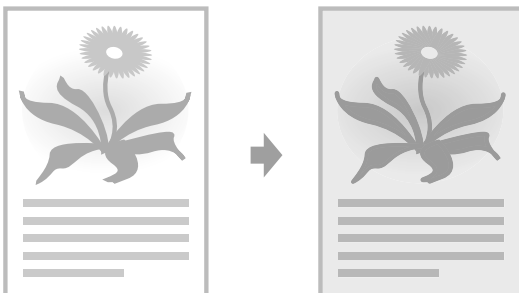

Perform one of the following solutions according to the cause.

<Cause 1> The copy density is not properly set.

Solution	Adjust the <Density> or <Correct Density> lower from the operation panel. ☑ "Adjusting the Density" (→P.3-4) 📖 e-Manual → Copy → Adjusting the Density → Finely Adjusting the Density
-----------------	---

<Cause 2> The machine is exposed to direct sunlight or strong light.

Solution	Move the machine. 📖 e-Manual → Maintenance → Transporting the Machine
-----------------	--

Copied Lines and Text Appear Faded

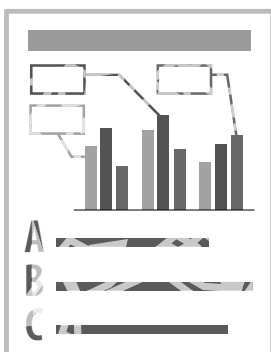

Perform the following procedure.

<Cause> <Original Type> is set to <Text/Photo (High Speed)> (default).

Solution	Set <Original Type> to <Text>, and then try to copy again. ☑ "Selecting Image Quality (Copy)" (→P.3-4)
-----------------	---

Printed Bar Codes Cannot Be Scanned

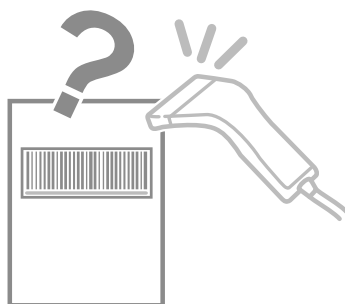

Perform the following procedure.

<Cause> When printing a bar code with the default printing preferences, the bar code may not be able to be scanned.

Solution	Change the [Special Print Mode] setting to [Special Settings 1] from the print driver. 📖 e-Manual → Maintenance → Special Mode * When [Special Settings 1] is selected, printing density is lower than when [Off] is selected. Also, text or lines may be less clear.
-----------------	---

Paper Jams Occur Frequently When Performing 2-Sided Printing

Perform the following procedure.

<Cause> Depending on the paper type (especially for thin paper or curled paper), paper jams occur frequently when performing 2-sided printing.

Solution	Change the <Special Mode I> settings from the operation panel. 📖 e-Manual → Maintenance → Special Mode * Maintain this setting <Off> in normal conditions. Change the setting only when the problems mentioned above occur. * If you use this mode when you are not using thin paper, images may become white.
-----------------	---

Registering/Setting the Various Functions

You can set or change machine functions from the setting menu according to your purpose.

Setting Menu List	10-2
--------------------------	-------------

Printing a User Data List.....	10-2
Contents of the Setting Menu.....	10-2

Setting Menu List

Printing a User Data List

To see the contents of current settings, print out user's data list.

Keys to be used for this operation

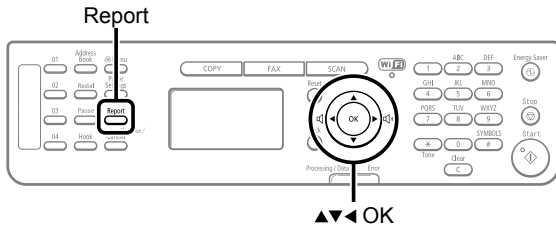

- 1 Press [] (Report).
- 2 Press [▲] or [▼] to select <Print Report Lists>, and then press [OK].

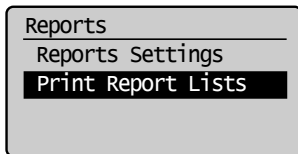

- 3 Press [▲] or [▼] to select <User Data List>, and then press [OK].

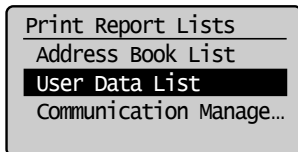

- 4 Ensure that the paper is loaded, and then press [OK].

Load the paper indicated in the display.

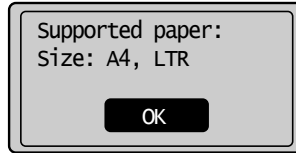

- 5 Press [◀] to select <Yes>, and then press [OK].

Printing starts.

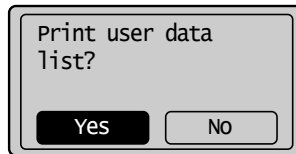

- 6 Press [] (Report) to close <Print Report Lists> screen.

Contents of the Setting Menu

[Address Book] key

Register the following types of destination.

- One-touch keys
- Coded dialing
- Group dialing

[Paper Settings] key

Register the size and type of the paper to be used. You can also register a custom paper size.

[Menu] key

Configure the machine settings. You can perform adjustment and cleaning.





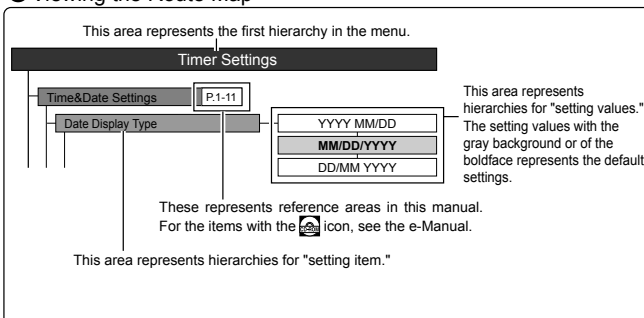

[Report] key

You can specify the settings for various report output conditions and output a report.

● Viewing the Route Map



● Menu Operations

	Returns to the previous hierarchy.
	Proceeds to the next hierarchy.
	Selects an upper item/setting value.
	Selects a lower item/setting value.
	Proceeds to the next hierarchy. Also, a setting value is determined, and an operation is performed. * When <Apply> appears in the screen, you need to select <Apply> and press [OK] after specifying the setting.
	Returns to the previous hierarchy.
	Cancels the setting and returns to the initial screen.

Address Book

<How to display>
 1 Press [FAX].
 2 Press [Address Book].
 3 The address book is displayed.
 4 Press [Left Arrow] to select [OK], and then press [OK].

Keys to be used for this operation

Coded Dial P.5-6

Fax

Name	Max 16 characters
Destination	Max 40
Settings	
ECM TX	Off
	On
Speed	33600 bps
	14400 bps
	9600 bps
	7200 bps
	4800 bps
	2400 bps
Long Distance	Domestic
	International (1)
	International (2)
	International (3)
Coded Dial:Registration No.	

Group

Name	Max 16 characters
Destination	Select Coded Dial/One-Touch Dial
Coded Dial:Registration No.	

One-Touch P.5-3

Fax

Enter Registration No.	
Name	Max 16 characters
Destination	Max 40
Settings	
ECM TX	Off
	On
Speed	33600 bps
	14400 bps
	9600 bps
	7200 bps
	4800 bps
	2400 bps
Long Distance	Domestic
	International (1)
	International (2)
	International (3)
One-Touch:Registration No.	

Group

Enter Registration No.	
Name	Max 16 characters
Destination	Select Coded Dial/One-Touch Dial
One-Touch:Registration No.	

Paper Settings

<How to display>
 Press [Paper Settings].

Keys to be used for this operation

▶ "Setting a Paper Size and Type" (P. 2-14)

Menu

<How to display>
 1 Press [Menu].
 2 The setting menu is displayed.

Keys to be used for this operation

Network Settings

Select Wired/Wireless LAN

Wired LAN
Wireless LAN

Wireless LAN Settings

WPS Push Button Mode

WPS PIN Code Mode

SSID Settings

Select Access Point

Manual Settings

Wireless LAN Information

Mac Address

Wireless LAN Status

Latest Error Information

Channel

SSID Settings

Security Settings

TCP/IP Settings

IPv4 Settings

IP Address Settings

Auto Obtain

Select Protocol	Off
	DHCP
	BOOTP
	RARP

Auto IP

	Off
	On

Manual Obtain

IP Address	0.0.0.0
Subnet Mask	0.0.0.0
Gateway Address	0.0.0.0

View Settings

Auto Obtain	
IP Address	
Subnet Mask	
Gateway Address	

PING Command

	0.0.0.0
--	---------

DNS Settings

DNS Server Settings

Primary DNS Server	0.0.0.0
Secondary DNS Server	0.0.0.0

DNS Host Name/Domain Name Settings

Host Name

Domain Name

DNS Dynamic Update Settings

	Off
	On

mDNS Settings

	Off
	On
mDNS Name	

IPv6 Settings

Use IPv6

	Off
	On
View Settings	

Stateless Address Settings

	Off
	On
View Settings	

Continues to the next page

Use DHCPv6	Off
	On
	View Settings
DNS Settings	
DNS Host Name/Domain Name Settings	
Use IPv4 Host/Domain	Off
	- Host Name
	- Domain Name
	On
DNS Dynamic Update Settings	
	Off
	On
	- Register Manual Add.: Off, On
	- Register Stateful Add.: Off, On
	- Register Stateless Add.: Off, On
mDNS Settings	
	Off
	On
Use IPv4 Name for mDNS	Off (mDNS Name)
	On
LPD Settings	
	Off
	On
RAW Settings	
	Off
	On
WSD Print Settings	
Use WSD Print	Off
	On
Use WSD Browsing	Off
	On
Use Multicast Discovery	Off
	On
Use HTTP	Off
	On
Port Number Settings	
LPD: 0 to 515 to 65535	
RAW: 0 to 9100 to 65535	
HTTP: 0 to 80 to 65535	
SNMP: 0 to 161 to 65535	
IP Address Range Settings	
IPv4 Address Range Settings	
	Off
	Only Allowed Addresses On
	Only Denied Addresses On
	Allowed/Denied Addresses On
IPv6 Address Range Settings	
	Off
	Only Allowed Addresses On
	Only Denied Addresses On
	Allowed/Denied Addresses On
Allowed RX MAC Address Settings	Off
	On
SNMP Settings	
	Off
	On
Community Name 1	Public
Community Name 2	
Writable SNMP 1	Off
	On
Writable SNMP 2	Off
	On
Dedicated Community Settings	Off
	Read-Write
	Read-Only
Printer Management Information From Host	Off
	On
Dedicated Port Settings	
	Off
	On
Startup Settings	0 to 300 (seconds)
Ethernet Driver Settings	
Auto Detect	Off
	- Communication Mode : Half Duplex, Full Duplex
	- Ethernet Type: 10 Base-T, 100 Base-TX
MAC Address	On
Initialize Network Settings	

Preferences	
Sound Volume Control	
Fax Tone	Off
	On
	- Fax Volume: 1 to 5
Ring Tone	Off
	On
	- Ring Tone Volume: 1 to 5
TX Done Tone	Off
	On
	- TX Done Volume: 1 to 5
	Sound Only When Error Occurs
	- TX Done Volume: 1 to 5
RX Done Tone	Off
	On
	- RX Done Volume: 1 to 5
	Sound Only When Error Occurs
	- RX Done Volume: 1 to 5
Scanning Done Tone	Off
	On
	- Scanning Done Volume: 1 to 5
	Sound Only When Error Occurs
	- Scanning Done Volume: 1 to 5
Entry Tone	Off
	On
	- Entry Tone Volume: 1 to 5
Entry Error Tone	Off
	On
	- Entry Err. Tone Volume: 1 to 5
Warning Tone	Off
	On
	- Warning Tone Volume: 1 to 5
Job Done Tone	Off
	On
	- Job Done Tone Volume: 1 to 5
Display Settings	
Select Default Screen	Copy
	Fax
	Scan
	Status Monitor/Cancel
Status Monitor/Cancel Device Priority	Off
	On
Language	English
	French
	Portuguese
	Spanish
Remote UI Language *	English
	French
	Portuguese
	Spanish
Contrast	-2 to 0 to +2
Invert Screen Colors	Off
	On
mm/Inch Entry Switch	mm
	Inch
Gram/Pound Switch	Gram
	Pound
Message Display Time	1 to 2 to 5 (seconds)
Scrolling Speed	Slow
	Normal
	Fast
Cursor Movement	Auto
	Manual
Toner Saver Mode <small>P.8-8</small>	
Copy	Off
	On
Fax	Off
	On

Paper Feed Method Switch

Multi-Purpose Tray **Print Speed Priority**
 Print Side Priority

Drawer 1 **Print Speed Priority**
 Print Side Priority

Timer Settings

Time & Date Settings P.1-12

Date Display Type YYYY MM/DD
 MM/DD/YYYY
 DD/MM YYYY

12/24 Hour Clock **12 Hour (AM/PM)**
 24 Hour

Current Time Settings

Daylight Savings **Off**
 On
 - Start (M/D)
 - End (M/D)

Sleep Timer P.1-11 **10 to 240 (minutes)**

Auto Reset Timer 0=Off
 1 to 2 to 9 (minutes)

Screen After Auto Reset **Default Screen**
 Selected Screen

Auto Offline Time 0=Off
 1 to 5 to 60 (minutes)

Copy Settings

Change Defaults P.3-9

Correct Density -4 to 0 to +4

Fax TX Settings

Basic Settings

Register Unit Name P.6-20

Register Unit Telephone Number P.6-20

Select Line Type P.6-20 Dial 10 PPS
 Tone

Public Line Connection P.6-20 **Direct**
 Adapter 1
 Adapter 2

Off-Hook Alarm P.6-20 **Off**
 On
 - Off-Hook Alarm Volume: 1 to 5

Sender ID P.6-20 Off
 On

Print Location On Image
 Above Image

Mark Number. as **FAX**
 TEL

TX Function Settings

Change Defaults P.6-18

ECM TX P.6-20 Off
 On

Pause Time P.6-21 1 to 2 to 15 (seconds)

Auto Redial P.6-21 Off
 On

Redial Times 1 to 2 to 10 (times)

Redial Interval 2 to 99 (minutes)

Redial When Error Occurs Off
 On

Check Dial Tone Before Sending P.6-21 **Off**
 On

Fax Setup Guide

Fax RX Settings

RX Function Settings

2-Sided Printing P.6-22 **Off**
 On

Reduce RX Size P.6-22 Off
 On
 - Ratio: Auto, 97, 95, 90, 75(%)
 - Direction: Vertical/Horizontal,
Vertical Only

RX Page Footer P.6-22 **Off**
 On

Continue Print, When Toner Is Nearly Out P.6-22 **Off**
 On

Fax Settings

ECM RX P.6-22 Off
 On

Incoming Ring P.6-23 Off
 On
 - Ring Times: 1 to 2 to 99 (times)

Remote RX P.6-23 Off
 On
 - Remote RX ID: 00 to 25 to 99

Auto RX Switch P.6-23 **Off**
 On
 - Incoming Ring Time: 1 to 15 to 99 (seconds)

Adjustment/Maintenance

Special Processing

Special Mode U **Off**
 On

Special Mode V **Off**
 Mode 1
 Mode 2
 Mode 3

Special Mode Z

Copy Off
 Mode 1
 Mode 2
 Mode 3
 Mode 4

Fax Off
 Mode 1
 Mode 2
 Mode 3
 Mode 4

Special Mode B **Off**
 Mode 1
 Mode 2
 Mode 3

Special Mode C **Off**
 On

Special Mode D

Copy **Off**
 On

Print **Off**
 On

Special Mode I **Off**
 On

Special Mode J **Off**
 On

Special Mode K **Off**
 On

Clean Fixing Unit P.8-3

System Management Settings

- Network Settings P.10-3
- System Manager Information Settings
 - System Manager PIN: Up to seven digits
 - System Manager Name: Up to 32 characters
- Device Information Settings
 - Device Name: Up to 32 characters
 - Location: Up to 32 characters
- Communication Management Settings
 - Fax Settings
 - TX Start Speed P.6-24
 - 33600 bps
 - 14400 bps
 - 9600 bps
 - 7200 bps
 - 4800 bps
 - 2400 bps
 - RX Start Speed P.6-24
 - Memory Lock Settings P.6-24
 - Off
 - On
 - Memory Lock PIN
 - Report Print
 - Off
 - On
 - Memory Lock Time
 - Off
 - On
 - Memory Lock Start Time
 - Memory Lock End Time
- Select Country/Region P.6-24
 - United States (US)
 - Canada (CA)
 - Brazil (BR)
 - Mexico (MX)
 - Other
- Remote UI On/Off
 - Off
 - On
- Restrict TX Function
 - Address Book PIN P.6-25
 - Restrict New Destinations P.6-25
 - Off
 - On
 - Allow Driver Faxing P.6-25
 - Off
 - On
 - Restrict Sending From History P.6-25
 - Off
 - On
 - Fax No. Confirmation Re-Entry P.6-25
 - Off
 - On
 - Restrict Sequential Broadcast P.6-25
 - Off
 - Confirm Sequential Broadcast
 - Reject Sequential Broadcast
- Display Job History
 - Off
 - On
- USB Device On/Off
 - Off
 - On
- Update Firmware
- Initialize Address Book
- Initialize System Settings
 - System Manager Information Settings
 - Device Information Settings
 - Network Settings
 - Communication Management Settings
 - Remote UI On/Off
 - Restrict TX Function
 - Display Job History
 - USB Device On/Off
 - Initialize All

Initialize Menu

- Preferences
- Timer Settings
- Copy Settings
- Fax TX Settings
- Fax RX Settings
- Special Processing
- Initialize All

Reports

<How to display>

- 1 Press [Report].
- 2 The report output menu is displayed.

Keys to be used for this operation

Reports Settings

- TX Result Report
 - Off
 - On
 - Only When Error Occurs
- Report With TX Image
 - Off
 - On
- Communication Management Report
 - Auto Print After 40 Transmissions
 - Off
 - On
 - Separate TX/RX
 - Off
 - On
- RX Result Report
 - Off
 - On
 - Only When Error Occurs
- Print Report Lists
 - Address Book List
 - Coded Dial
 - One-Touch
 - Group
 - User Data List
 - Communication Management Report

Appendix

This section describes the specifications of the machine and information for Macintosh users.

Main Specifications	11-2
Machine Specifications	11-2
Wireless LAN Specification	11-2
Copy Specifications	11-2
Printer Specification	11-3
Scanner Specifications	11-3
Fax Specifications	11-3
Telephone Specifications	11-3
For Macintosh Users	11-4
Displaying Driver Guides (HTML Files)	11-4
Displaying a Driver's Help System	11-4
Content of the e-Manual about Features that Are Unavailable on the Macintosh	11-4
Index	11-5

Main Specifications

Machine Specifications

Machine Specifications	
Type	Personal Desktop
Power Supply	120 to 127 V, 60 Hz (Power requirements differ depending on the country in which you purchased the product.)
Power Consumption	<ul style="list-style-type: none"> Maximum: 1,130 W or less Average consumption during standby mode: Approx. 10 W Average consumption during sleep mode: Approx. 2.7 W
Warm-up Time	<ul style="list-style-type: none"> 13.5 seconds or less* (Temperature: 68 °F (20 °C), humidity: 65% RH ; from when the machine is turned on with the power switch to when the standby display appears) * Warm-up time may vary depending on the condition and environment around the machine.
Weight	Main unit (including toner cartridge): Approx. 27.3 lb (12.4 kg)
Dimensions (W x L x H)	15 3/8" x 16 5/8" x 14 1/2" (390 mm x 421 mm x 370 mm)
Installation Space (W x L x H)	24 1/4" x 31 5/8" x 29" (617 mm x 804 mm x 735 mm)
Environmental Conditions	Temperature: 50 to 86°F (10 to 30°C) Humidity: 20% to 80% RH (no condensation)
Acceptable Documents	"Document Requirements" (→P.2-2)
Acceptable Paper Stock	"Paper Requirements" (→P.2-6)
Printable Range	"Printable Range" (→P.2-8)
Scanning Range	"Scanning Range" (→P.2-2)

Wireless LAN Specification

Wireless LAN Specification	
Standard	IEEE802.11g/IEEE802.11b/IEEE 802.11n*
Transmission Scheme	DS-SS System/OFDM System
Frequency Range	2412 to 2472 MHz
Data Transmission Rate	<ul style="list-style-type: none"> IEEE802.11g 6/9/12/18/24/36/48/54 Mbps IEEE802.11b 1/2/5.5/11 Mbps IEEE 802.11n <ul style="list-style-type: none"> - SGI Invalidated 20 MHz : 6.5/13/19.5/26/39/52/58.5/65 Mbps - SGI Validated 20 MHz : 7.2/14.4/21.7/28.9/43.3/57.8/72.2 Mbps - SGI Invalidated 40 MHz : 13.5/27/40.5/81/108/121.5/135 Mbps - SGI Validated 40 MHz : 15/30/45/60/90/120/150 Mbps
Communication Mode	Infrastructure Mode
Security	WEP, WPA-PSK (TKIP/AES-CCMP), WPA2-PSK (TKIP/AES-CCMP)

* WPS (Wi-Fi Protected Setup), Connection can be established by manually setting values.

Copy Specifications

Copy Specifications	
Scanning Resolution	<ul style="list-style-type: none"> Text/Photo (High Speed): 300 dpi x 300 dpi Text/Photo, Photo, Text: 600 dpi x 600 dpi
Output Resolution	600 dpi x 600 dpi
Copy Ratio	<ul style="list-style-type: none"> Direct 1:1 ± 1.0 % Enlargement 1:4.00, 1:2.00, 1:1.29 Reduction 1:0.78, 1:0.64, 1:0.50, 1:0.25 Zoom 0.25 to 4.00, 1% increments
Copy Speed (Letter Plain Direct)*	26 cpm
Successive Copying Capacity	Maximum 99 copies
First Copy Time (Letter)	<ul style="list-style-type: none"> Platen glass 8.7 seconds or less Feeder 12 seconds or less

* Speed when using Letter size Plain paper and copying the same data continuously. Depending on the type, size, or feeding direction of the paper, such as when using small size paper, copy speed may become slower. Also, operation may pause or become slow to readjust the temperature or print quality of the machine, when copying continuously.

Printer Specification

Printer Specification	
Printing Method	Indirect electrostatic system (On-demand fixing)
Paper Capacity	Multi-purpose tray: 1 sheet Paper cassette: Approx. 250 sheets (16 to 21 lb Bond (60 to 80 g/m ²))
Output Tray Capacity (Letter size paper which has been just opened)	Approx. 100 sheets (16 to 21 lb Bond (60 to 80 g/m ²))* ¹
Print Speed (Letter Plain Direct)** ²	26 ppm
Output Resolution	600 dpi x 600 dpi
Gradation	256 gradations
Toner Cartridge	"Replacing Toner Cartridges" (→P8-6)

*¹ Actual paper capacity varies depending on the installation environment and paper type to be used.

*² Speed when using Letter size Plain paper and printing the same data continuously. Depending on the type, size, or feeding direction of the paper, such as when using small size paper, print speed may become slower. Also, operation may pause or become slow to readjust the temperature or print quality of the machine, when printing continuously.

Scanner Specifications

Scanner Specifications	
Type	Color scanner
Maximum Scanning Size	<ul style="list-style-type: none"> Platen glass: 8 1/2" x 11 5/8" (215.9 mm x 297 mm) Feeder: 8 1/2" x 14" (215.9 mm x 355.6 mm)
Scanning Resolution	<ul style="list-style-type: none"> Optical resolution Platen glass: 600 x 600 dpi Feeder: 300 x 300 dpi Software interpolation resolution 9600 dpi x 9600 dpi
Scanning Speed (Letter, 300 x 300 dpi)*	<ul style="list-style-type: none"> Platen glass Grayscale: 3 seconds/sheet Color: 15 seconds/sheet Feeder Grayscale: 3 seconds/sheet Color: 15 seconds/sheet
Host Interface	<ul style="list-style-type: none"> 100 Base-TX 10 Base-T Hi-Speed USB USB
Operating System	<ul style="list-style-type: none"> Windows 2000/XP/Vista/7 Mac OS 10.4.9 or later (excluding Classic environment)
Driver	<ul style="list-style-type: none"> TWAIN WIA 1.0 (Windows XP/Vista/7) WIA 2.0 (Windows Vista/7) ICA (Mac OS X 10.6.x)

* The communication time is not included.

Fax Specifications

Fax Specifications	
Applicable Line	Public Switched Telephone Network (PSTN) ^{*1}
Communication Mode	G3, Super G3
Data Compression Type	MH, MR, MMR
Modem Speed	33.6 Kbps Automatic Fallback
Transmission Speed	Approx. 3 seconds per page ^{*2} (ECM-MMR, transmitting from the memory at 33.6 Kbps)
Sending/Receiving Memory	Maximum approx. 256 pages ^{*2} (Total pages of transmission/reception)
Fax Resolution	<ul style="list-style-type: none"> (Normal): 200 dpi x 100 dpi (Fine): 200 dpi x 200 dpi (Photo): 200 dpi x 200 dpi (Superfine): 200 dpi x 400 dpi
Dialing System	<ul style="list-style-type: none"> One-touch keys (4 destinations) Coded dialing (100 destinations) Group dialing (50 destinations) Address book dialing Regular dialing (with numeric keys) Automatic redialing Manual redialing Sequential broadcast (114 destinations)
Receiving System	<ul style="list-style-type: none"> Automatic reception Remote reception by telephone (Default ID: 25)
Report Output	<ul style="list-style-type: none"> Send Results Transmission management report (Auto output every 40 destinations) Receive Results

*¹ The Public Switched Telephone Network (PSTN) currently supports 28.8 Kbps modem speed or lower. However, this depends on the telephone line condition.

*² Based on ITU-T Standard Chart No. 1, MMR standard mode.

Telephone Specifications

Telephone Specifications	
Available Telephone	External telephone/External telephone with built-in answering machine/Data modem

For Macintosh Users

In this manual, methods to operate in the Windows environment are explained as examples. To view how to use printer drivers or utilities for Macintosh, see the following driver guides (HTML files) or driver help systems.

Function	Object	Reference
Print function	Installing the Printer Driver	<ul style="list-style-type: none"> • Starter Guide • Mac UFR II Printer Driver Installation Guide
	Printing	<ul style="list-style-type: none"> • Mac UFR II Printer Driver Installation Guide
	Using each feature	<ul style="list-style-type: none"> • Printer Driver's Help
Fax function	Installing the Fax Driver	<ul style="list-style-type: none"> • Starter Guide • Mac Fax Driver Installation Guide
	Sending a fax	<ul style="list-style-type: none"> • Mac Fax Driver Installation Guide
	Using each feature	<ul style="list-style-type: none"> • Fax Driver's Help
Scan function	Installing the Scanner Driver	<ul style="list-style-type: none"> • Starter Guide • Mac Scanner Driver Guide
	Scanning (Setting the MF Toolbox or ScanGear MF)	<ul style="list-style-type: none"> • Mac Scanner Driver Guide

Displaying Driver Guides (HTML Files)

Double-click the following HTML files from the [Manuals] folder on the provided CD-ROM.

- **Mac UFR II Printer Driver Installation Guide**

→ [GUIDE-UFR II-US.pdf]

- **Mac Fax Driver Installation Guide**

→ [GUIDE-FAX-US.pdf]

- **Mac Scanner Driver Guide**

→ [GUIDE-SCAN-US.pdf]

Displaying a Driver's Help System

You can use drivers' help systems after you install each driver.

- **Printer Driver's Help**

From the below panels in the [Print] dialog, click [?].

- [Basic] panel
- [Advanced] panel

- **Fax Driver's Help**

From the below panels in the [Print] dialog, click [?].

- [General Settings] panel
- [Special Features] panel
- [Cover Sheet] panel

Content of the e-Manual about Features that Are Unavailable on the Macintosh

Among the features explained in the e-Manual, the followings are unavailable on the Macintosh.

- **Installing or uninstalling the e-Manual**

Reference in the e- Manual	"Installing the e-Manual" "Uninstalling the e-Manual"
----------------------------	--

- **Accessory software**

- Presto! PageManager

Reference in the e- Manual	"User Software CD-ROM"
----------------------------	------------------------

- **Using WSD network**

Reference in the e- Manual	"Installing the MF Drivers Via the WSD Network"
----------------------------	---

- **Some print features**

<Examples>

- Operating in the print server environment
- Watermark printing
- PageComposer (Combining and printing multiple files)
- Changing the halftone
- Adjusting the gamma value

For information on the features that are available on the Macintosh, see the Printer Driver's help system.

Reference in the e- Manual	"Print"
----------------------------	---------

- **Some scan features**

<Examples>

- Creating a "Searchable PDF"

For information on the features that are available on the Macintosh, see the Mac Scanner Driver Guide.

Reference in the e- Manual	"Scan"
----------------------------	--------

Index

C

Canceling

Fax Jobs..... 6-26

Changing the Default Values

Copy..... 3-9

Fax..... 6-18

Cleaning the Machine..... 8-2

Exterior..... 8-2

Fixing Unit..... 8-3

Platen Glass..... 8-4

Coded Dial Codes

Editing..... 5-6

Storing..... 5-6

Coded Dialing..... 5-2

Contents of the Setting Menu..... 10-2

Copying..... 3-1

2-Sided Copying..... 3-5

Collating Copies..... 3-7

Enlarging/Reducing Copies..... 3-6

ID Card..... 3-8

N on 1..... 3-6

Copy Mode..... 1-6

Copyright..... xix

D

Date Settings..... 1-12

Density

Copy..... 3-4

Fax..... 6-3

Disclaimers..... xx

Display..... 1-6

Display Messages..... 9-6

LCD (Standby Mode)..... 1-6

Document feeder tray..... 1-2

Document guides..... 1-2

Documents

Clearing Jams..... 9-2

Placing..... 2-4

Receiving Faxes..... 6-10

Requirements..... 2-2

Scanning Range..... 2-2

Sending Faxes..... 6-2

Documents Requirements..... 2-2

E

Error Code..... 9-6

F

Fax Documents in the Memory

Forwarding..... 6-14

History..... 6-17

Received Fax Documents..... 6-16

Transmission Documents..... 6-15

Fax mode..... 1-6

Fax Settings..... 6-19

Feeder..... 1-2

G

Group Dialing..... 5-2

Editing..... 5-9

Storing..... 5-9

H

Handling..... xiv

I

If a Power Failure Occurs.....	9-11
If <Incorrect size/setting> Appears.....	9-8
If You Cannot Solve a Problem.....	9-12
Image Quality	
Copy.....	3-4
Fax.....	6-3
Installation	xiii
Requirements.....	xvii
Space.....	xvii

L

LAN port.....	1-3
---------------	-----

M

Main Specifications	11-2
Copy specifications.....	11-2
Fax Specifications.....	11-3
Machine Specifications.....	11-2
Printer Specification.....	11-3
Scanner Specifications.....	11-3
Telephone Specifications.....	11-3
Maintenance and Inspections	xv, xviii
Manual Sending	6-7
Multi-purpose Tray	
Paper guide.....	1-4

O

One-Touch Keys	5-2
Editing.....	5-3
Storing.....	5-3
Operation Panel	1-2, 1-5
Output tray	1-2

P

Paper	
Clearing Jams.....	9-2
Loading.....	2-9
Paper Size and Type.....	2-14
Printable Range.....	2-8
Requirements.....	2-6
Paper Cassette	1-2, 1-4
Paper Requirements	2-6
Platen glass	1-2
Power Supply	xiii
Requirements.....	xvii
Printable Range	2-8
Printing a User Data List	10-2
Printing from a Computer	4-1

R

Rear cover	1-3
Receive Mode	6-10
Answer mode.....	6-11
Auto mode.....	6-10
Changing.....	6-12
Fax/Tel Auto Switch mode.....	6-11
Manual mode.....	6-12
Registering/Setting the Various Functions	10-1

S

Scan Functions	7-1
Scan Mode	1-6
Scanning area	1-2
Scanning Range	2-2
Selecting Print Side	2-16
Sequential Broadcast	6-9

Sharpness	
Copy.....	3-7
Fax.....	6-3
Sleep Timer.....	1-11
Specifying Destinations.....	6-4

T

Telephone Equipment.....	xvi
Telephone line jack.....	1-3
Text Input Method.....	1-9
Time Settings.....	1-12
Toner Cartridge.....	8-6
Checking the Toner Level.....	8-8
Handling.....	8-7
Replacing Toner Cartridge.....	8-10
Trademarks.....	xix
Transporting the Machine.....	8-16
Tray extension.....	1-2
Troubleshooting.....	9-1
Clearing Jams.....	9-2
Error Code.....	9-6
If a Power Failure Occurs.....	9-11
If <Incorrect Size/Setting> Appears.....	9-8
If You Cannot Solve a Problem.....	9-12

U

USB port.....	1-3
----------------------	------------

Canon

CANON INC.

30-2, Shimomaruko 3-chome, Ohta-ku, Tokyo 146-8501, Japan

CANON MARKETING JAPAN INC.

16-6, Konan 2-chome, Minato-ku, Tokyo 108-8011, Japan

CANON U.S.A., INC.

One Canon Plaza, Lake Success, NY 11042, U.S.A.

CANON EUROPA N.V.

Bovenkerkerweg, 59-61, 1185 XB Amstelveen, The Netherlands

CANON CHINA CO. LTD.

15F Jinbao Building No.89, Jinbao Street, Dongcheng District, Beijing 100005, PRC

CANON SINGAPORE PTE LTD

1 HarbourFront Avenue, #04-01 Keppel Bay Tower, Singapore 098632

CANON AUSTRALIA PTY LTD

1 Thomas Holt Drive, North Ryde, Sydney NSW 2113, Australia

CANON GLOBAL WORLDWIDE SITES

<http://www.canon.com/>

Serial No.	
Date of Purchase	

