



Canon

PowerShot SX500 IS

Camera User Guide

- Make sure you read this guide, including the “Safety Precautions” section, before using the camera.
- Reading this guide will help you learn to use the camera properly.
- Store this guide safely so that you can use it in the future.

ENGLISH

Package Contents

Before use, make sure the following items are included in the package. If anything is missing, contact your camera dealer.

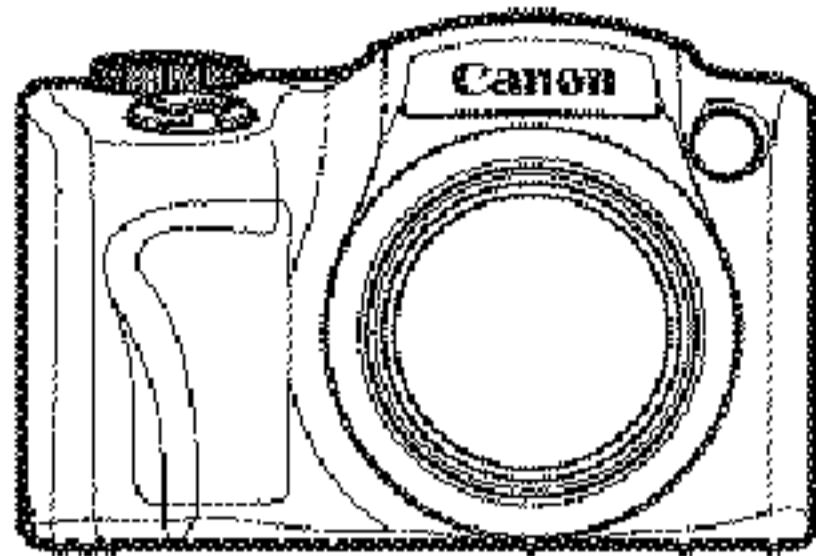

Camera

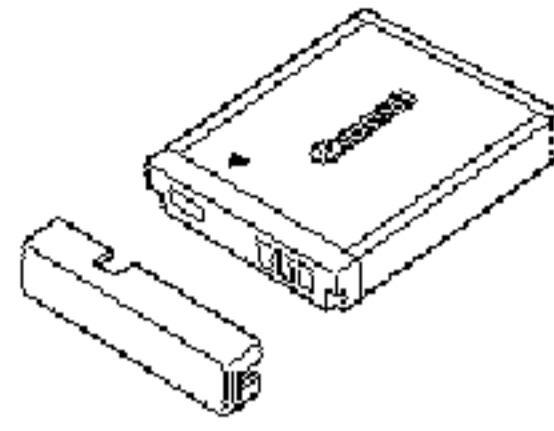

Battery Pack NB-6L
(with terminal cover)

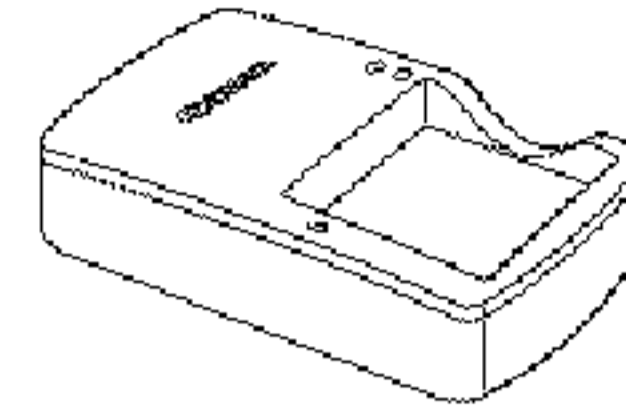

Battery Charger
CB-2LY/CB-2LYE

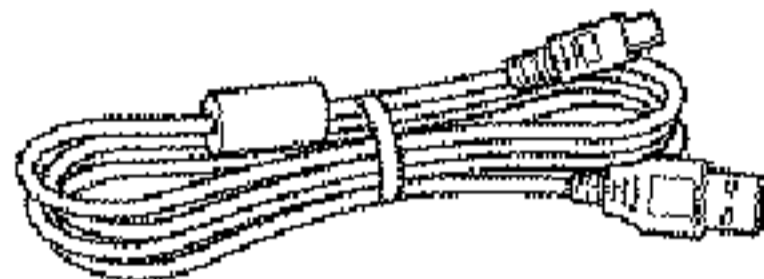

Interface Cable
IFC-400PCU

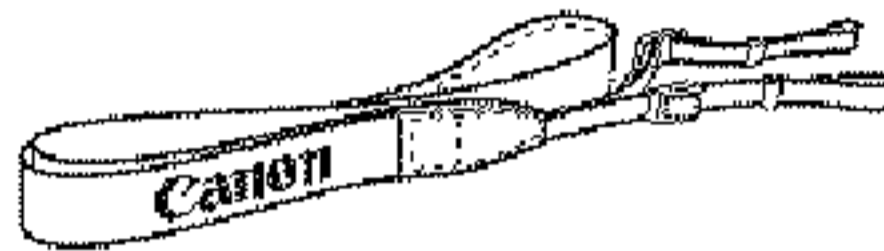

Neck Strap
NS-DC11

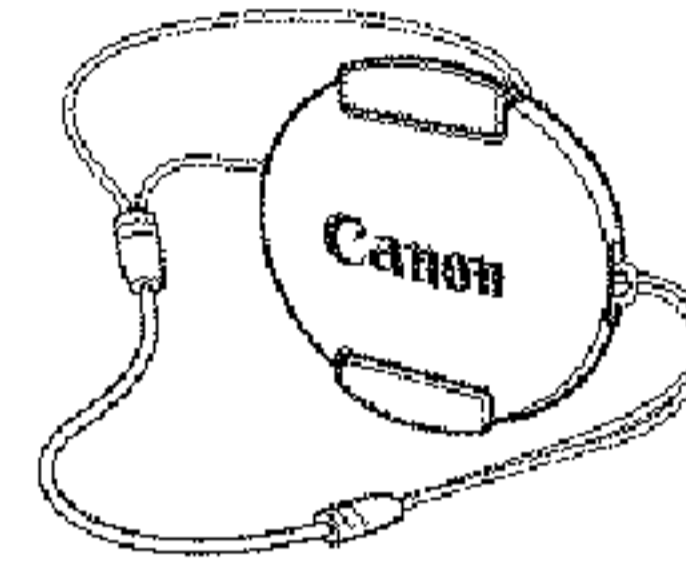

Lens Cap
(with cord)



DIGITAL CAMERA
Solution Disk*
(CD-ROM)

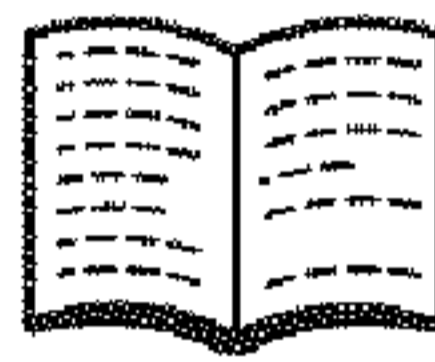

Getting Started

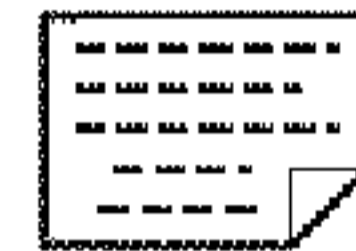

Warranty Card

* Contains software and PDF manuals (📖31).

* A memory card is not included.



* Any supplements or revisions to the *Camera User Guide* are included at the end of this guide.

Compatible Memory Cards

The following memory cards (sold separately) can be used, regardless of capacity.

- * SD memory cards*
- * SDHC memory cards*
- * SDXC memory cards* 
- * Eye-Fi cards

* Conforms to SD specifications. However, not all memory cards have been verified to work with the camera.

About Eye-Fi Cards

This product is not guaranteed to support Eye-Fi card functions (including wireless transfer). In case of an issue with an Eye-Fi card, please check with the card manufacturer.

Also note that an approval is required to use Eye-Fi cards in many countries or regions. Without approval, use of the card is not permitted. If it is unclear whether the card has been approved for use in the area, please check with the card manufacturer.

Preliminary Notes and Legal Information

- * Take and review some test shots initially to make sure the images were recorded correctly. Please note that Canon Inc., its subsidiaries and affiliates, and its distributors are not liable for any consequential damages arising from any malfunction of a camera or accessory, including memory cards, that results in the failure of an image to be recorded or to be recorded in a way that is machine readable.
- * Images recorded by the camera are intended for personal use. Refrain from unauthorized recording that infringes on copyright law, and note that even for personal use, photography may contravene copyright or other legal rights at some performances or exhibitions, or in some commercial settings.
- * The camera warranty is valid only in the area of purchase. In case of camera problems while abroad, return to the area of purchase before contacting a Canon Customer Support Help Desk.
- * Although the LCD monitor is produced under extremely high-precision manufacturing conditions and more than 99.99% of the pixels meet design specifications, in rare cases some pixels may be defective or may appear as red or black dots. This does not indicate camera damage or affect recorded images.
- * The LCD monitor may be covered with a thin plastic film for protection against scratches during shipment. If covered, remove the film before using the camera.
- * When the camera is used over an extended period, it may become warm. This does not indicate damage.

Organization of Camera User Guide

The following guides are included, each used for different purposes.

Basic Guide (📖 17)

- * Gives basic instructions, from initial preparations to shooting, playback, and saving on a computer

Advanced Guide (📖 41)

- * Practical guide that introduces other camera basics and describes shooting and playback options

Part Names and Conventions in This Guide

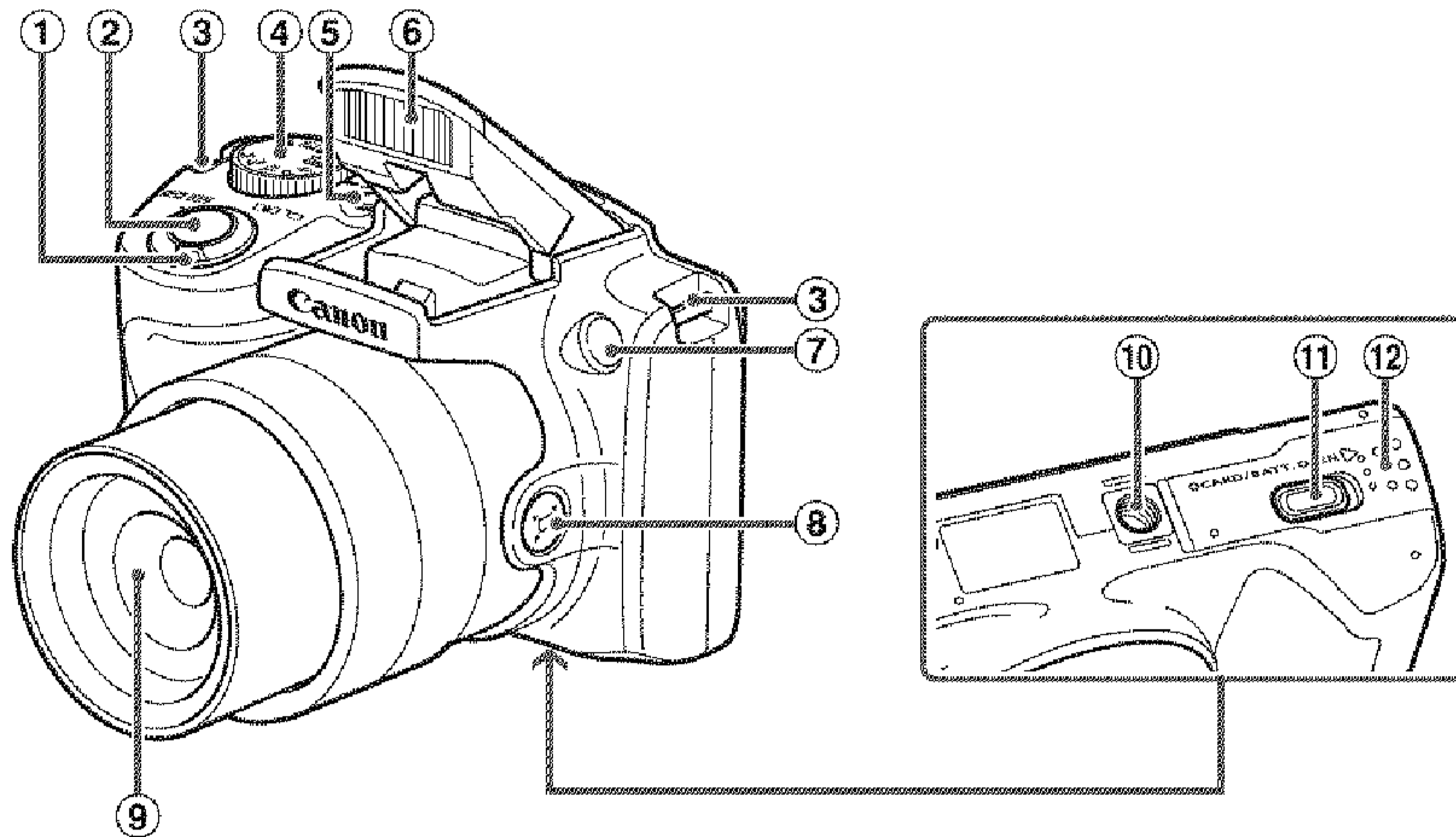

- | | |
|-------------------------------|---------------------------------|
| ① Zoom lever | ⑥ Flash |
| Shooting: <[🌲] (telephoto)> / | ⑦ Lamp |
| <[🌲] (wide angle)> | ⑧ <[🔍] (Framing Assist – Seek)> |
| Playback: <[Q] (magnify)> / | button |
| <[🏠] (index)> | ⑨ Lens |
| ② Shutter button | ⑩ Tripod socket |
| ③ Strap mount | ⑪ DC coupler terminal cover |
| ④ Mode dial | ⑫ Memory card/battery cover |
| ⑤ Power button | |

- * Shooting modes and on-screen icons and text are indicated in brackets.
- * ⓘ: Important information you should know
- * 🖋️: Notes and tips for expert camera use
- * 📖xx: Pages with related information (in this example, “xx” represents a page number)
- * Instructions in this guide apply to the camera under default settings.
- * For convenience, all supported memory cards are simply referred to as “the memory card”.
- * The tabs shown above titles indicate whether the function is used for still images, movies, or both.

Still Images: Indicates that the function is used when shooting or viewing still images.

Movies: Indicates that the function is used when shooting or viewing movies.

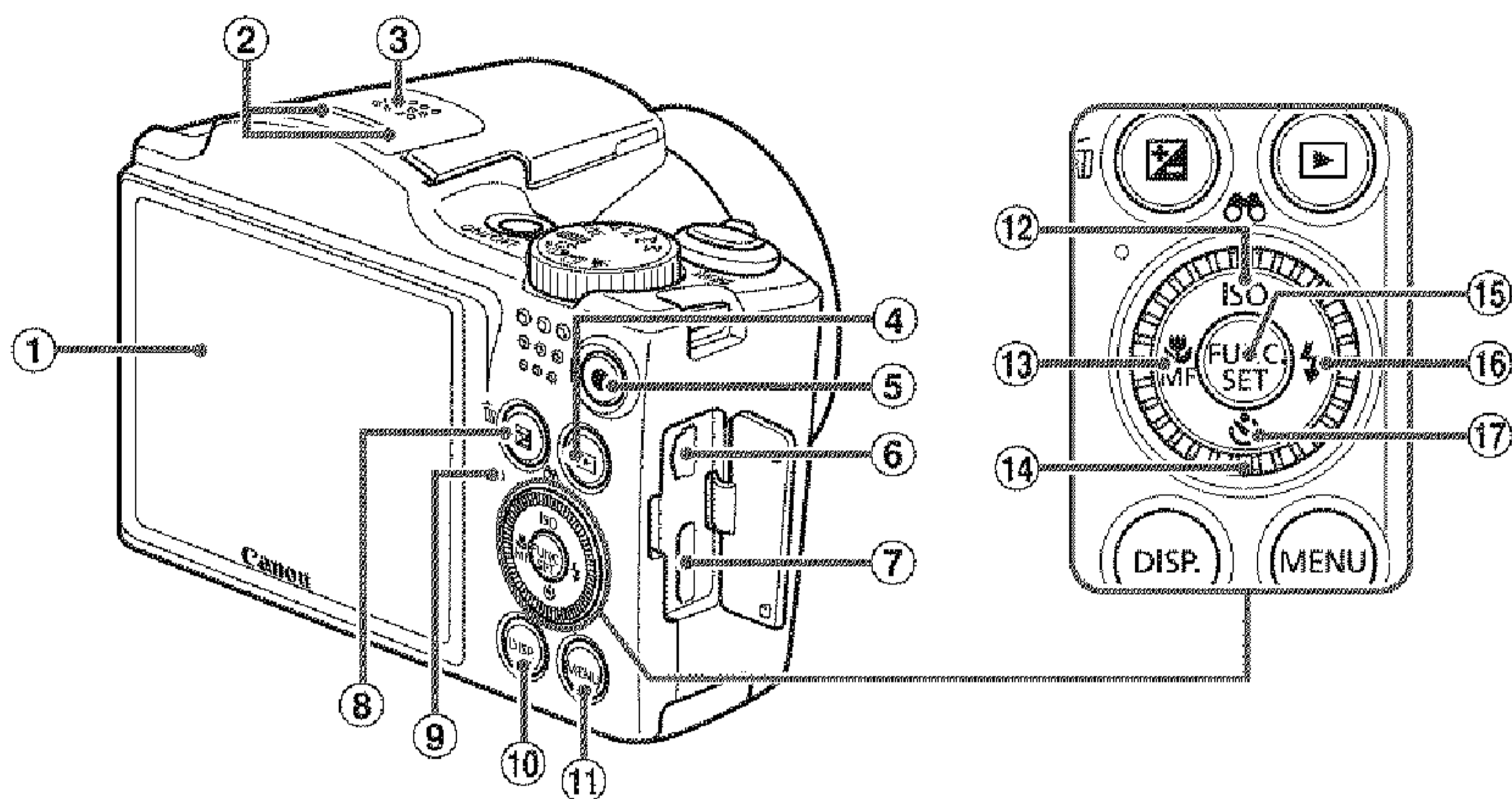

- ① Screen (LCD monitor)
- ② Microphone
- ③ Speaker
- ④ <▶ (Playback)> button
- ⑤ Movie button
- ⑥ AV OUT (Audio/video output) / DIGITAL terminal
- ⑦ HDMI™ terminal
- ⑧ <+/- (Exposure compensation)> / <🗑 (Single image erase)> button
- ⑨ Indicator
- ⑩ <DISP. (Display)> button
- ⑪ <MENU> button
- ⑫ <ISO (ISO speed)> / <👁 (Filter image display)> / Up button
- ⑬ <🌸 (Macro)> / <MF (Manual focus)> / Left button
- ⑭ Control dial
- ⑮ FUNC./SET button
- ⑯ <⚡ (Flash)> / Right button
- ⑰ <🕒 (Self-timer)> / Down button

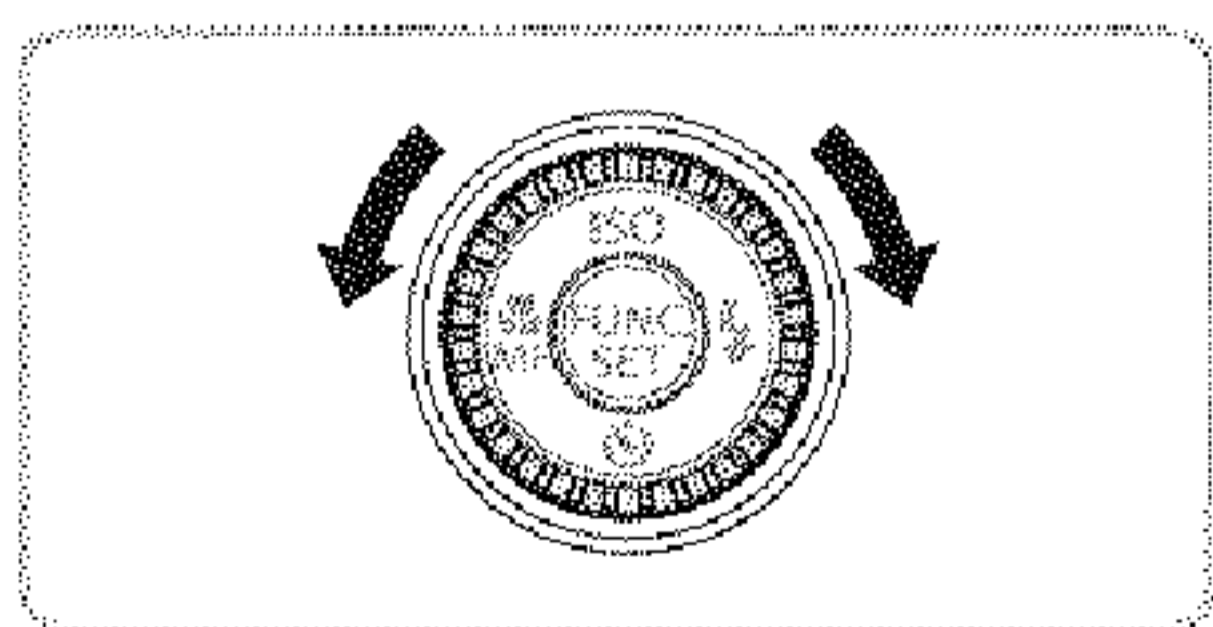

● Turning the control dial is one way to choose setting items, switch images, and perform other operations. Most of these operations are also possible with the <▲><▼><◀><▶> buttons.

- * In this guide, icons are used to represent the corresponding camera buttons and dials on which they appear or which they resemble.
- * The following camera buttons and controls are represented by icons.

- <▲> Up button ⑫ on back
- <▼> Down button ⑰ on back
- <◀> Left button ⑬ on back
- <🌀> Control dial ⑭ on back
- <▶> Right button ⑯ on back

Table of Contents

Package Contents	2	Helpful Shooting Features	72
Compatible Memory Cards	3	Customizing Camera Operation	75
Preliminary Notes and Legal Information	4	3 Other Shooting Modes	77
Organization of Camera User Guide	5	Discreet Mode	78
Part Names and Conventions in This Guide	6	Brightness/Color Customization (Live View Control)	79
Table of Contents	8	Specific Scenes	80
Contents: Basic Operations	10	Image Effects (Creative Filters) ...	82
Safety Precautions	12	Special Modes for Other Purposes	87
<hr/>		Shooting Various Movies	88
Basic Guide	17	4 P mode	91
Initial Preparations	18	Shooting in Program AE Mode (<P> Mode)	92
Trying the Camera Out	26	Image Brightness (Exposure Compensation)	93
Included Software, PDF Manuals	31	Color and Continuous Shooting ...	98
Accessories	39	Shooting Range and Focusing	103
<hr/>		Flash	111
Advanced Guide	41	Other Settings	114
1 Camera Basics	41	5 Tv, Av, and M Mode	115
On/Off	42	Specific Shutter Speeds (<Tv> Mode)	116
Shutter Button	43	Specific Aperture Values (<Av> Mode)	117
Shooting Modes	44	Specific Shutter Speeds and Aperture Values (<M> Mode)	118
Shooting Display Options	45	6 Playback Mode	121
FUNC. Menu	46	Viewing	122
MENU Menu	47	Browsing and Filtering Images	126
Indicator Display	49		
Clock	49		
2 Smart Auto Mode	51		
Shooting (Smart Auto)	52		
Common, Convenient Features ...	60		
Image Customization Features ...	67		

Image Viewing Options.....	129	9 Appendix.....	195
Protecting Images.....	132	Troubleshooting.....	196
Erasing Images.....	136	On-Screen Messages.....	200
Rotating Images.....	140	On-Screen Information.....	202
Image Categories.....	142	Functions and Menu Tables.....	206
Editing Still Images.....	146	Handling Precautions.....	216
Editing Movies.....	153	Specifications.....	217
7 Setting Menu.....	155	Index.....	221
Adjusting Basic Camera Functions.....	156		
8 Accessories.....	169		
Tips on Using Included Accessories.....	170		
Optional Accessories.....	171		
Using Optional Accessories.....	173		
Printing Images.....	179		
Using an Eye-Fi Card.....	193		

Contents: Basic Operations

Shoot

- Use camera-determined settings (Auto Mode) 52

Shooting people well



Portraits

(80)



Against Snow

(81)

Matching specific scenes



Low Light

(80)

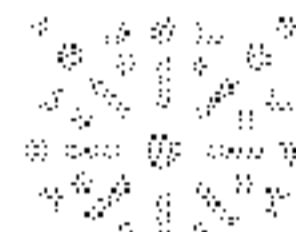

Fireworks

(81)

Applying special effects



Vivid Colors

(82)



Poster Effect

(82)



Fish-Eye Effect

(83)



Miniature Effect

(83)

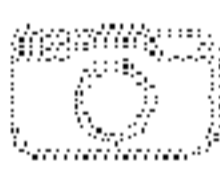

Toy Camera Effect

(85)



Monochrome

(86)

- Where sound and flash are not allowed (Discreet Mode) 78
- While adjusting image settings (Live View Control) 79
- Focus on faces 52, 80, 106
- With myself in the shot (Self-Timer) 62, 87
- Add a date stamp 65

 **View**

- View images (Playback Mode)..... 122
- Automatic playback (Slideshow)..... 130
- On a TV..... 173
- On a computer 32
- Browse through images quickly 126
- Erase images 136

 **Shoot/View Movies**

- Shoot movies 52, 88
- View movies (Playback Mode)..... 122

 **Print**

- Print pictures 179

 **Save**

- Save images to a computer 32

Safety Precautions

- * Before using the product, please ensure that you read the safety precautions described below. Always ensure that the product is used correctly.
- * The safety precautions noted on the following pages are intended to prevent injuries to yourself and other persons, or damage to the equipment.
- * Be sure to also check the guides included with any separately sold accessories you use.



Denotes the possibility of serious injury or death.

- * **Do not trigger the flash in close proximity to people's eyes.**
Exposure to the intense light produced by the flash could damage eyesight. In particular, remain at least 1 meter (39 inches) away from infants when using the flash.
- * **Store this equipment out of the reach of children and infants.**
Strap: Putting the strap around a child's neck could result in asphyxiation.
- * **Use only recommended power sources.**
- * **Do not attempt to disassemble, alter or apply heat to the product.**
- * **Avoid dropping or subjecting the product to severe impacts.**
- * **To avoid the risk of injury, do not touch the interior of the product if it has been dropped or otherwise damaged.**
- * **Stop using the product immediately if it emits smoke, a strange smell, or otherwise behaves abnormally.**
- * **Do not use organic solvents such as alcohol, benzine, or thinner to clean the product.**
- * **Do not let the product come into contact with water (e.g. sea water) or other liquids.**
- * **Do not allow liquids or foreign objects to enter the camera.**
This could result in electrical shock or fire.
If liquids or foreign objects come into contact with the camera interior, immediately turn the camera off and remove the battery.
If the battery charger becomes wet, unplug it from the outlet and consult your camera distributor or a Canon Customer Support Help Desk.

- * **Use only the recommended battery.**
- * **Do not place the battery near or in direct flame.**
- * **Unplug the power cord periodically, and using a dry cloth, wipe away any dust and dirt that has collected on the plug, the exterior of the power outlet, and the surrounding area.**
- * **Do not handle the power cord with wet hands.**
- * **Do not use the equipment in a manner that exceeds the rated capacity of the electrical outlet or wiring accessories. Do not use if the power cord or plug are damaged, or not fully plugged into the outlet.**
- * **Do not allow dirt or metal objects (such as pins or keys) to contact the terminals or plug.**

The battery may explode or leak, resulting in electrical shock or fire. This could cause injury and damage the surroundings. In the event that a battery leaks and the battery electrolyte contacts eyes, mouth, skin or clothing, immediately flush with water.

- * **Turn the camera off in places where camera use is prohibited.**

The electromagnetic waves emitted by the camera may interfere with the operation of electronic instruments and other devices. Exercise adequate caution when using the camera in places where use of electronic devices is restricted, such as inside airplanes and medical facilities.

- * **Do not play the supplied CD-ROM(s) in any CD player that does not support data CD-ROMs.**

It is possible to suffer hearing loss from listening with headphones to the loud sounds of a CD-ROM played on an audio CD player (music player). Additionally, this could damage the speakers.

 Caution	Denotes the possibility of injury.
--	------------------------------------

- * **When holding the camera by the strap, be careful not to bang it, subject it to strong impacts or shocks, or let it get caught on other objects.**

- * **Be careful not to bump or push strongly on the lens.**

This could lead to injury or damage the camera.

- * **Be careful not to subject the screen to strong impacts.**

If the screen cracks, injury may result from the broken fragments.

Safety Precautions

- **When using the flash, be careful not to cover it with your fingers or clothing.**

This could result in burns or damage to the flash.

- **Avoid using, placing or storing the product in the following places:**
 - **Places subject to strong sunlight**
 - **Places subject to temperatures above 40 °C (104 °F)**
 - **Humid or dusty areas**

These could cause leakage, overheating or an explosion of the battery, resulting in electrical shock, fire, burns or other injuries.

High temperatures may cause deformation of the camera or battery charger casing.

- **The slideshow transition effects may cause discomfort when viewed for prolonged periods.**

Caution

Denotes the possibility of damage to the equipment.

- **Do not aim the camera at bright light sources (such as the sun on a clear day).**

Doing so may damage the image sensor.

- **When using the camera on a beach or at a windy location, be careful not to allow dust or sand to enter the camera.**

This may cause the product to malfunction.

- **In regular use, small amounts of smoke may be emitted from the flash.**

This is due to the high intensity of the flash burning dust and foreign materials stuck to the front of the unit. Please use a cotton swab to remove dirt, dust or other foreign matter from the flash to prevent heat build-up and damage to the unit.

- **Remove and store the battery when you are not using the camera.**

If the battery is left inside the camera, damage caused by leakage may occur.

- **Before you discard the battery, cover the terminals with tape or other insulators.**

Contacting other metal materials may lead to fire or explosions.

- * **Unplug the battery charger from the power outlet after charging is complete, or when you are not using it.**
- * **Do not place anything, such as cloth, on top of the battery charger while it is charging.**

Leaving the unit plugged in for a long period of time may cause it to overheat and distort, resulting in fire.

- * **Do not place the battery near pets.**

Pets biting the battery could cause leakage, overheating or explosion, resulting in fire or damage.

- * **When putting the camera in your bag, ensure that hard objects do not come into contact with the screen.**

- * **Do not attach any hard objects to the camera.**

Doing so may cause malfunctions or damage the screen.

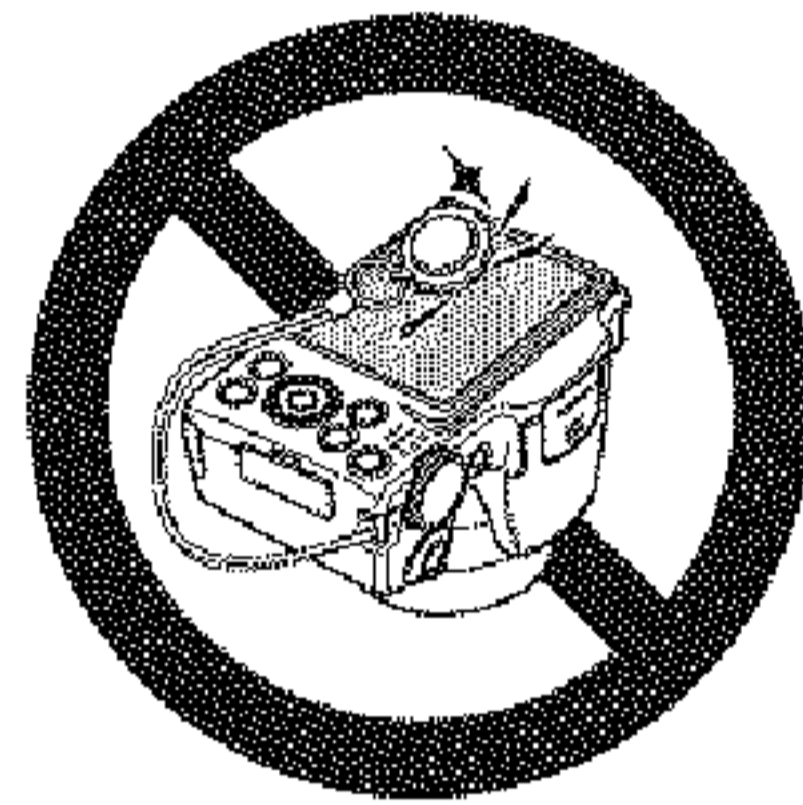

Basic Guide

Gives basic instructions, from initial preparations to shooting, playback, and saving on a computer

Initial Preparations

Prepare for shooting as follows.

Attaching the Strap

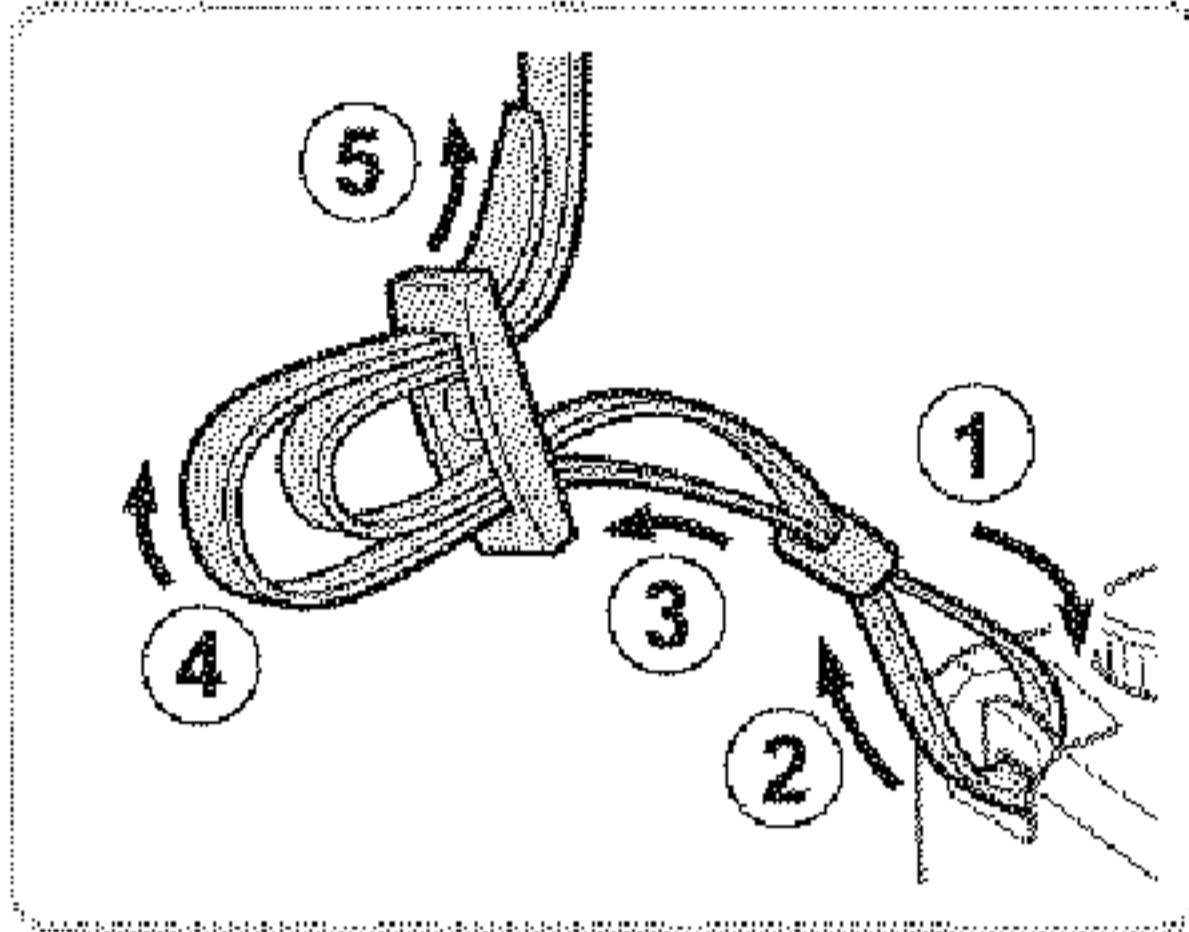

1 Attach the strap.

- Attach the included strap to the camera as shown.
- On the other side of the camera, attach the strap the same way.

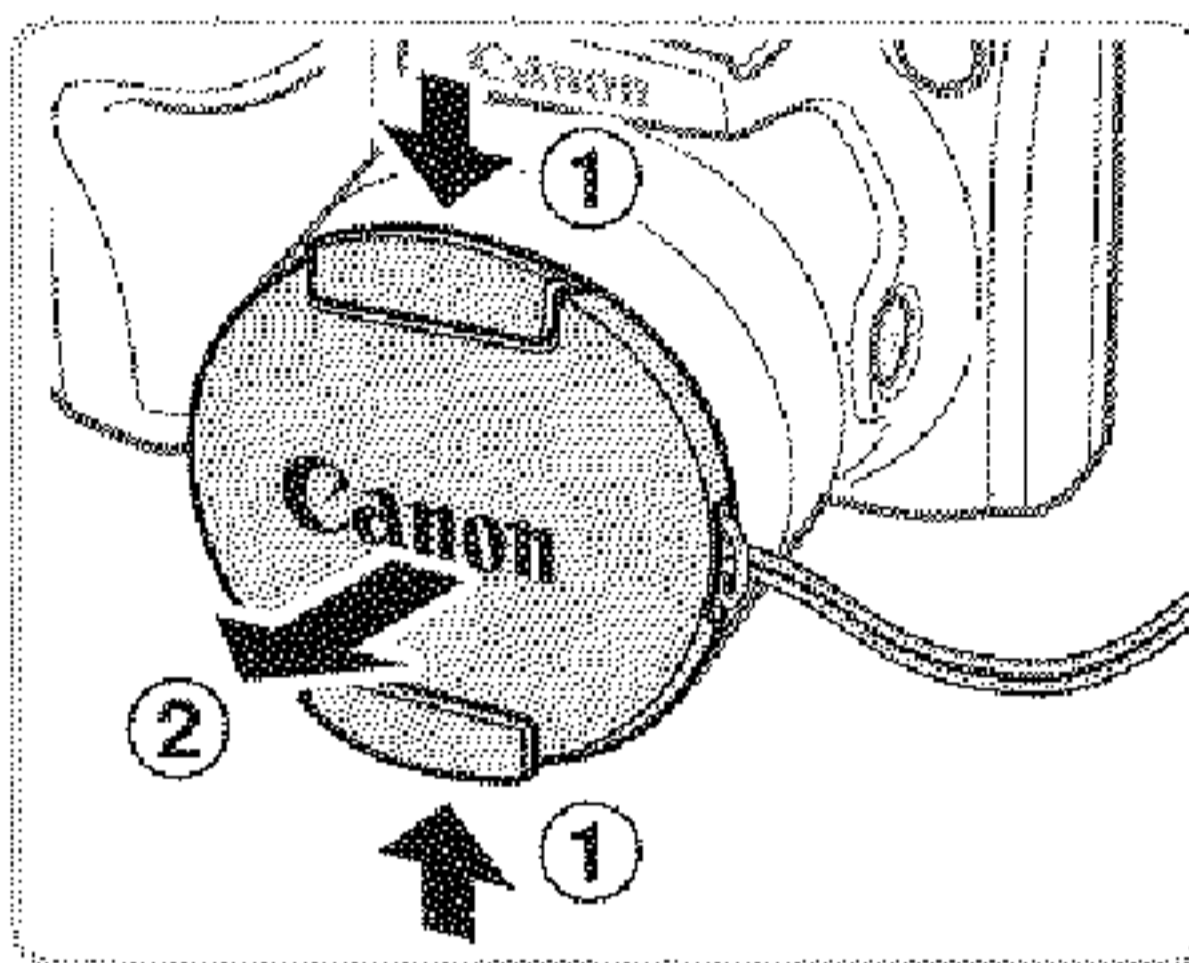

2 Attach the lens cap to the strap.

- Remove the lens cap from the camera and attach the lens cap cord to the strap.
- Always remove the lens cap before turning the camera on.
- Keep the lens cap on the lens when the camera is not in use.

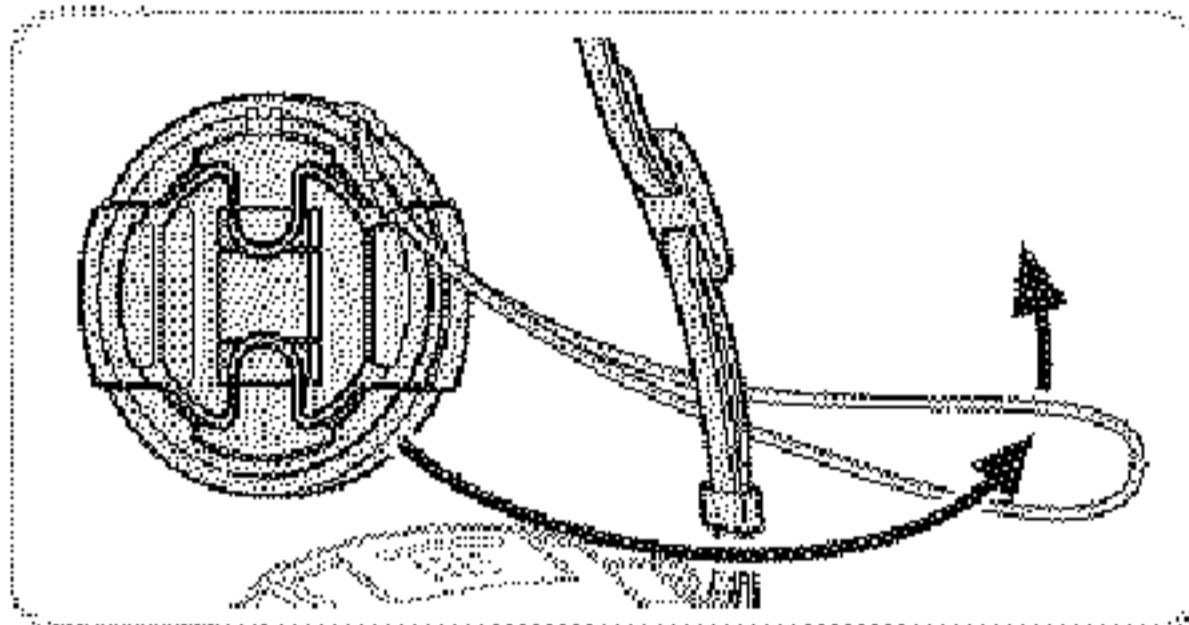

Holding the Camera

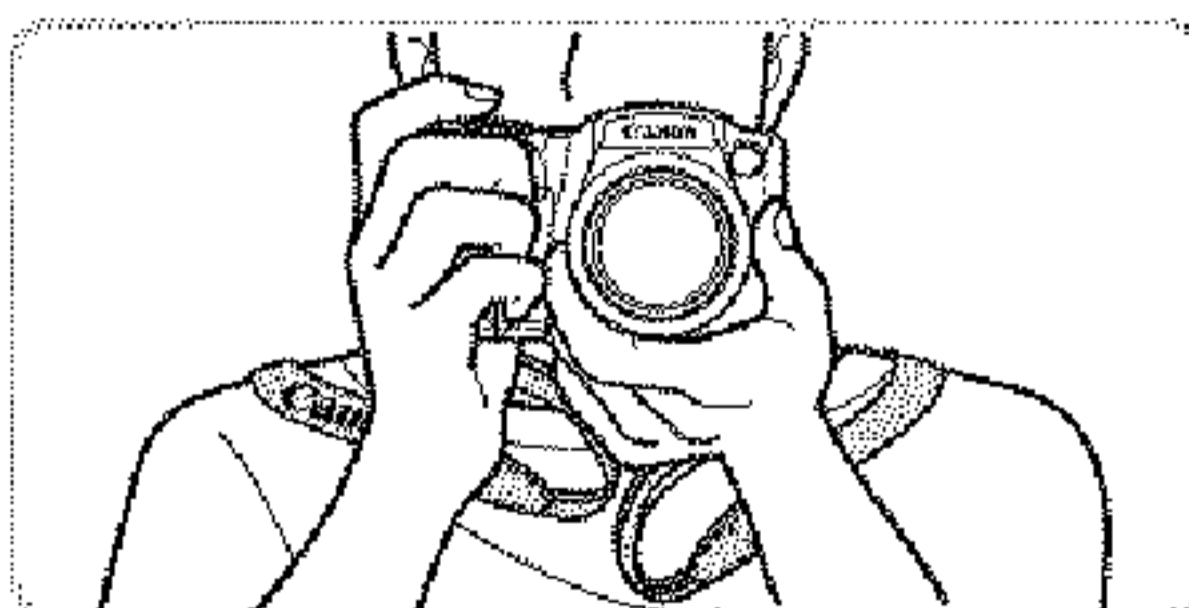

- Place the strap around your neck.
- When shooting, keep your arms close to your body and hold the camera securely to prevent it from moving. If you have raised the flash, do not rest your fingers on it.

Charging the Battery

Before use, charge the battery with the included charger. Be sure to charge the battery initially, because the camera is not sold with the battery charged.

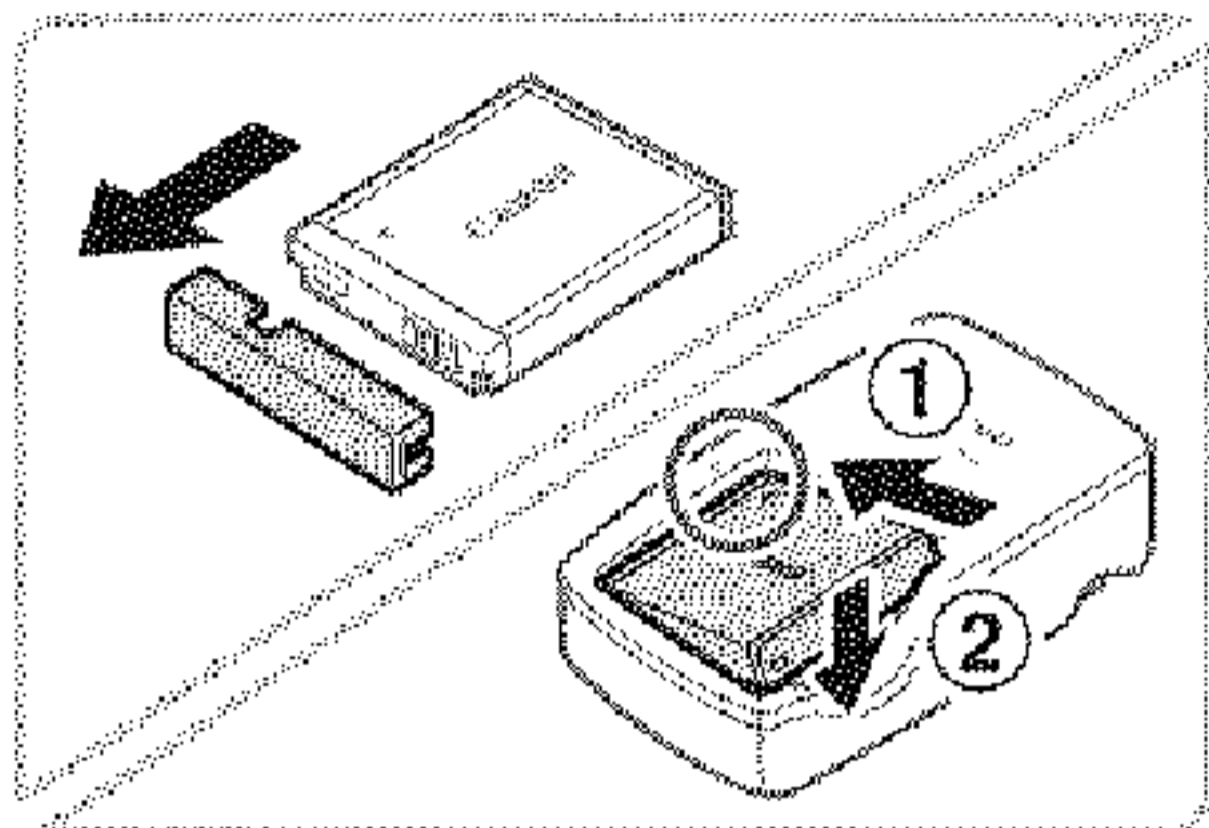

1 Remove the battery cover and insert the battery in the charger.

- Remove the cover from the battery, align the ▲ marks on the battery and charger, and insert the battery by pushing it in (①) and down (②).

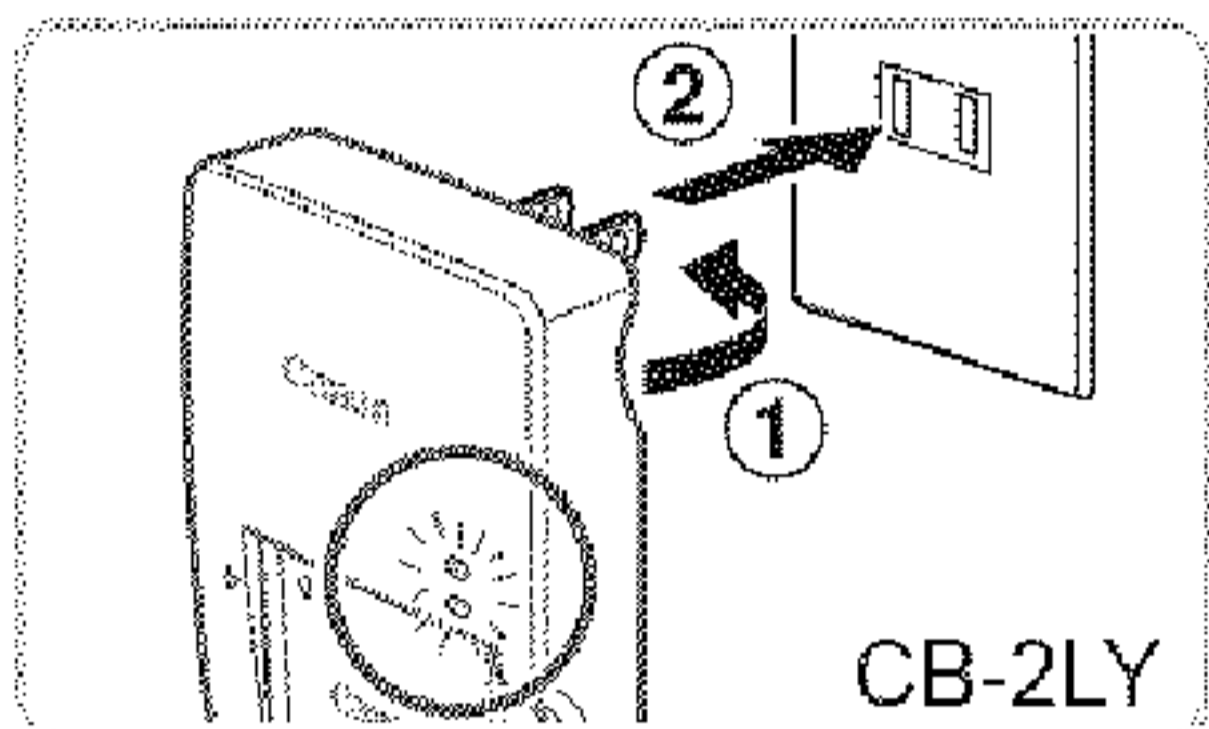

2 Charge the battery.

- CB-2LY:** Flip out the plug (①) and plug the charger into a power outlet (②).
- CB-2LYE:** Plug the power cord into the charger, then plug the other end into a power outlet.

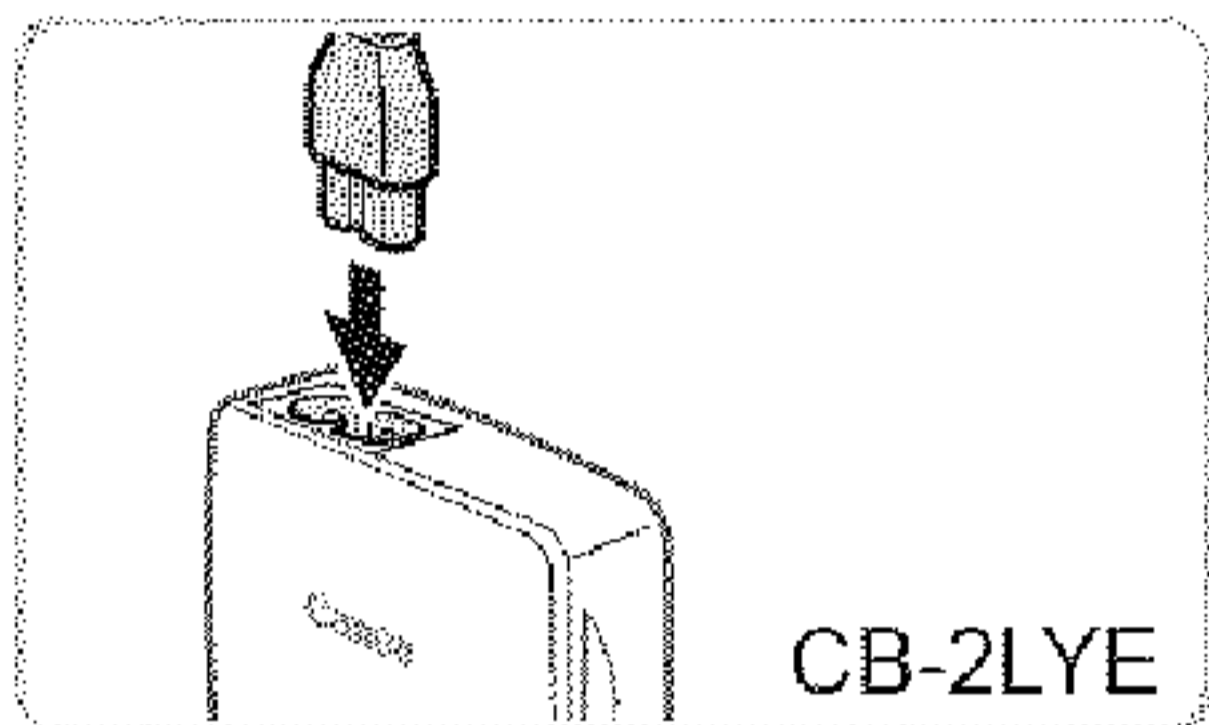

- ▶ The charging lamp turns orange and charging begins.
- ▶ When the charging is finished, the lamp turns green.

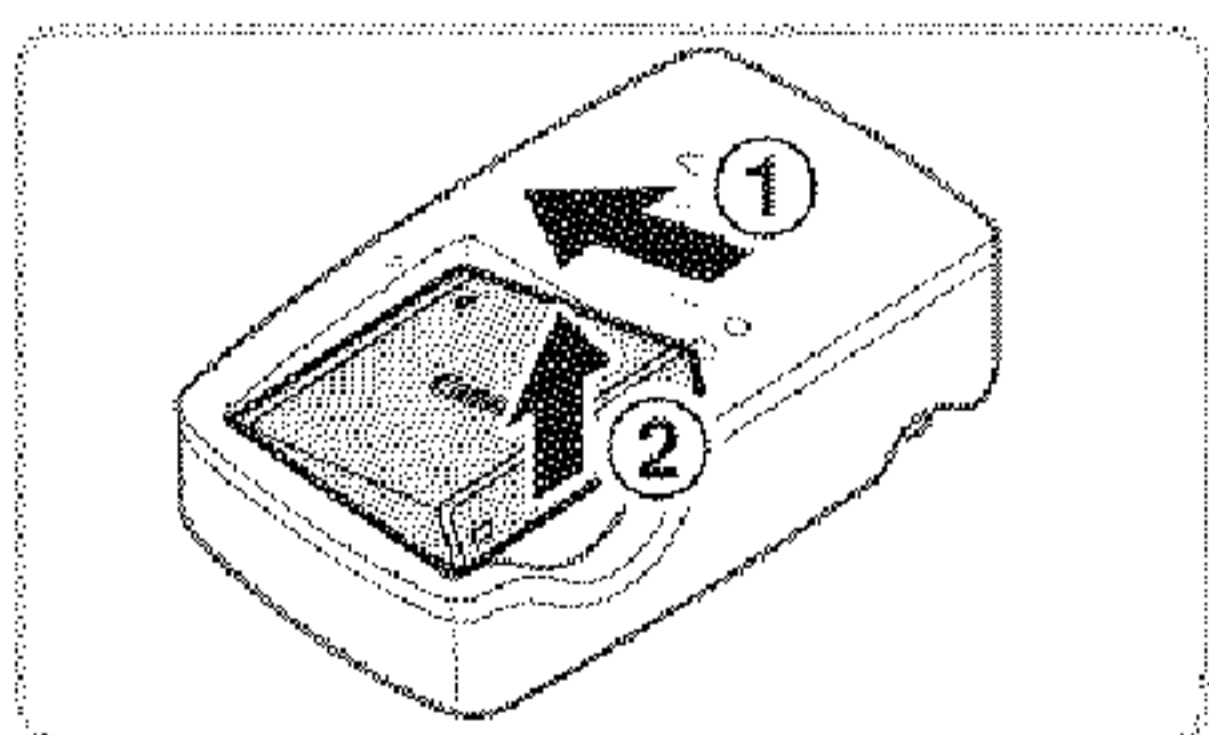

3 Remove the battery.

- After unplugging the battery charger, remove the battery by pushing it in (①) and up (②).



- To protect the battery and keep it in optimal condition, do not charge it continuously for more than 24 hours.
- For battery chargers that use a power cord, do not attach the charger or cord to other objects. Doing so could result in malfunction or damage to the product.



For details on charging time and the number of shots and recording time possible with a fully charged battery, see “Specifications” (1217).

Inserting the Battery and Memory Card

Insert the included battery and a memory card (sold separately). Note that before using a new memory card (or a memory card formatted in another device), you should format the memory card with this camera (160).

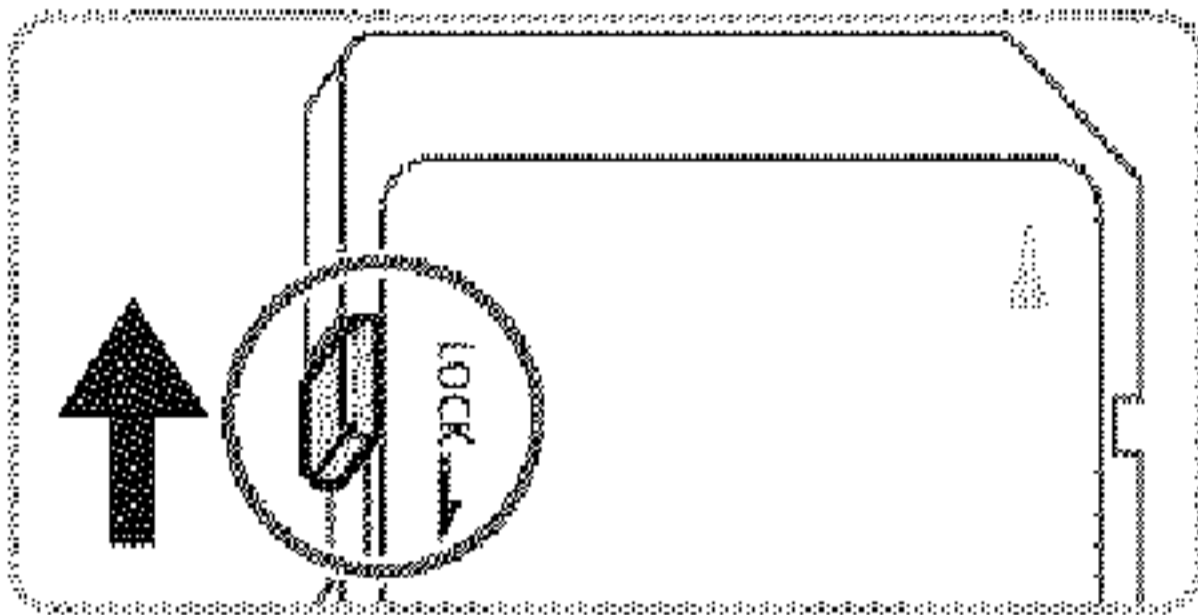

1 Check the card's write-protect tab.

- Recording is not possible on memory cards with a write-protect tab when the tab is in the locked (downward) position. Slide the tab up until it clicks into the unlocked position.

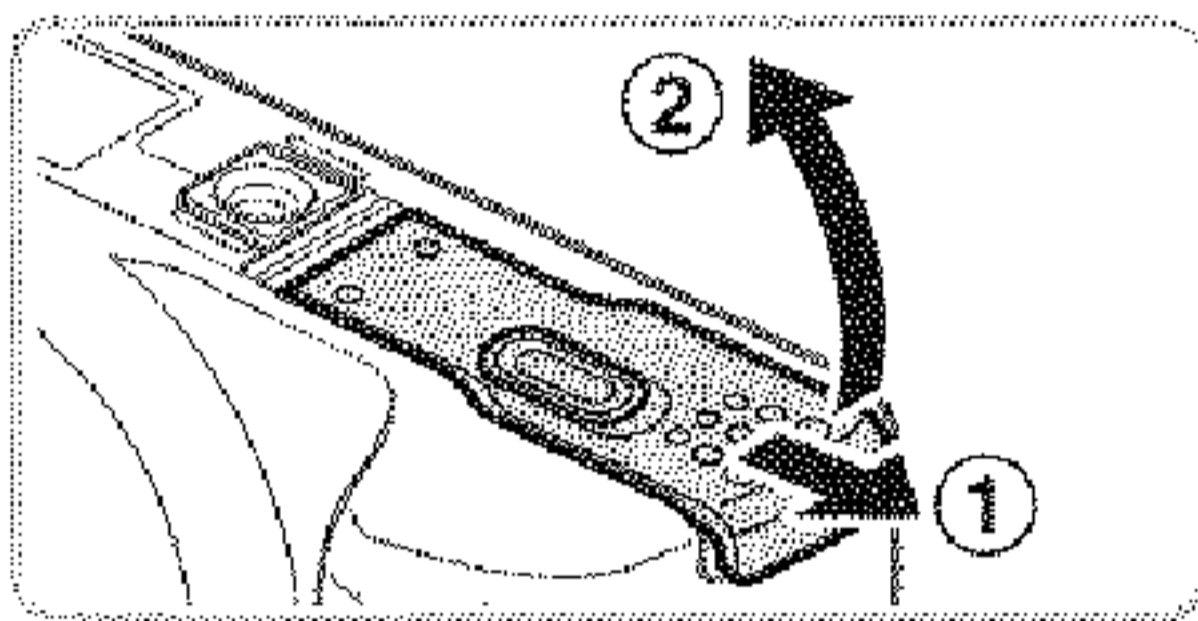

2 Open the cover.

- Slide the cover (1) and open it (2).

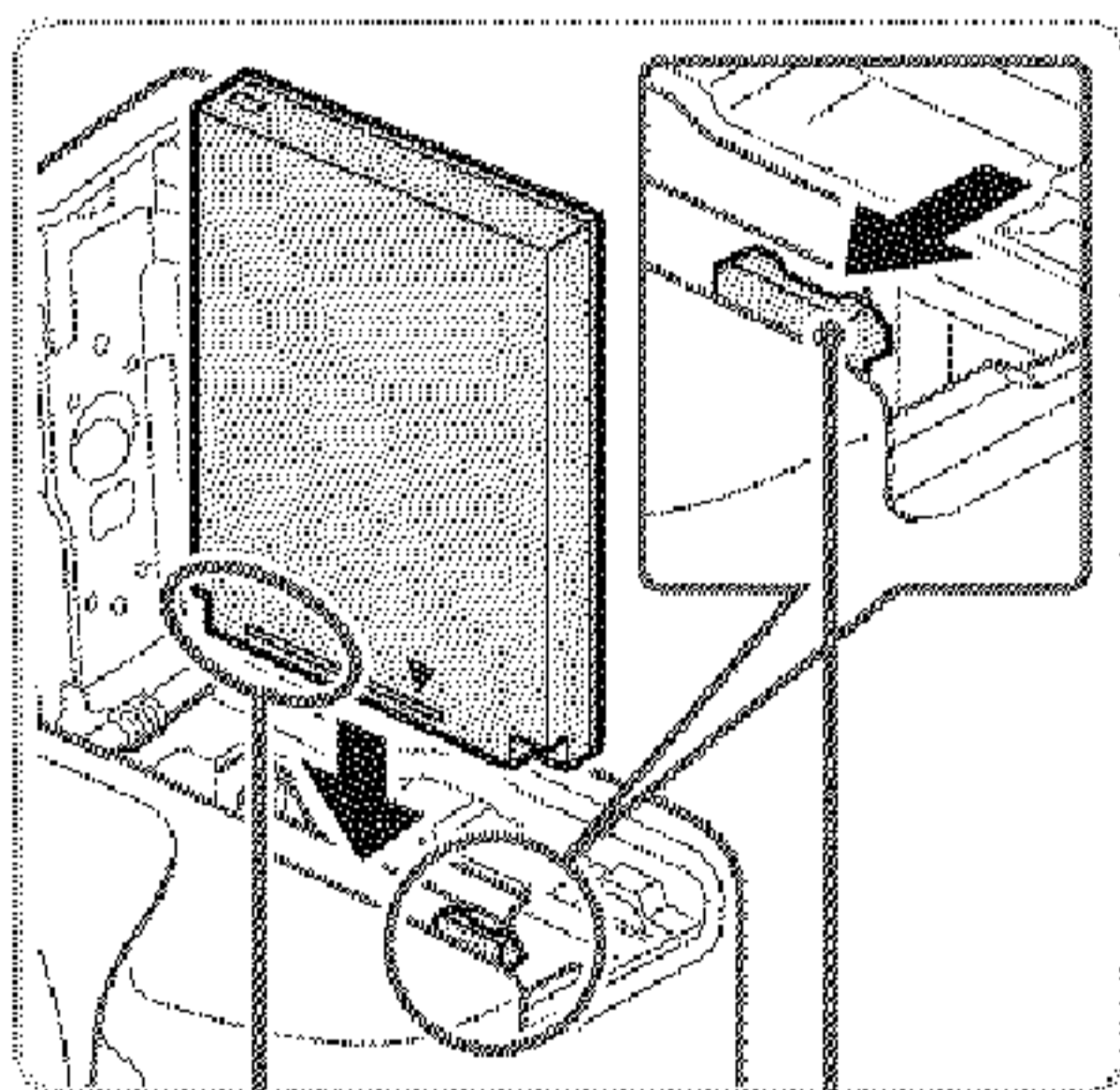

3 Insert the battery.

- While pressing the battery lock in the direction of the arrow, insert the battery as shown and push it in until it clicks into the locked position.
- If you insert the battery facing the wrong way, it cannot be locked into the correct position. Always confirm that the battery is facing the right way and locks when inserted.

Terminals

Battery
Lock

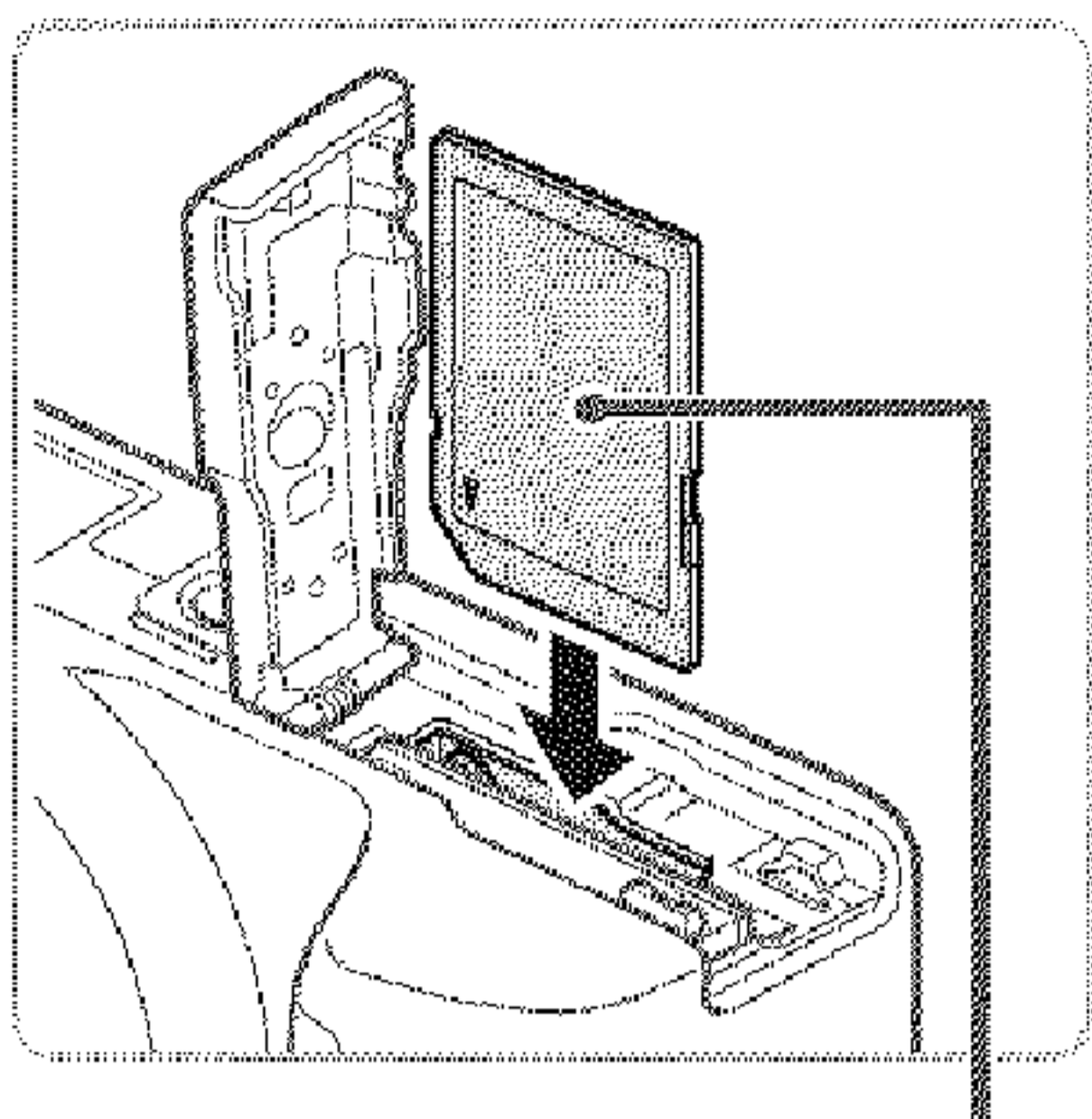

Label

4 Insert the memory card.

- Insert the memory card facing as shown until it clicks into the locked position.
- Make sure the memory card is facing the right way when you insert it. Inserting memory cards facing the wrong way may damage the camera.

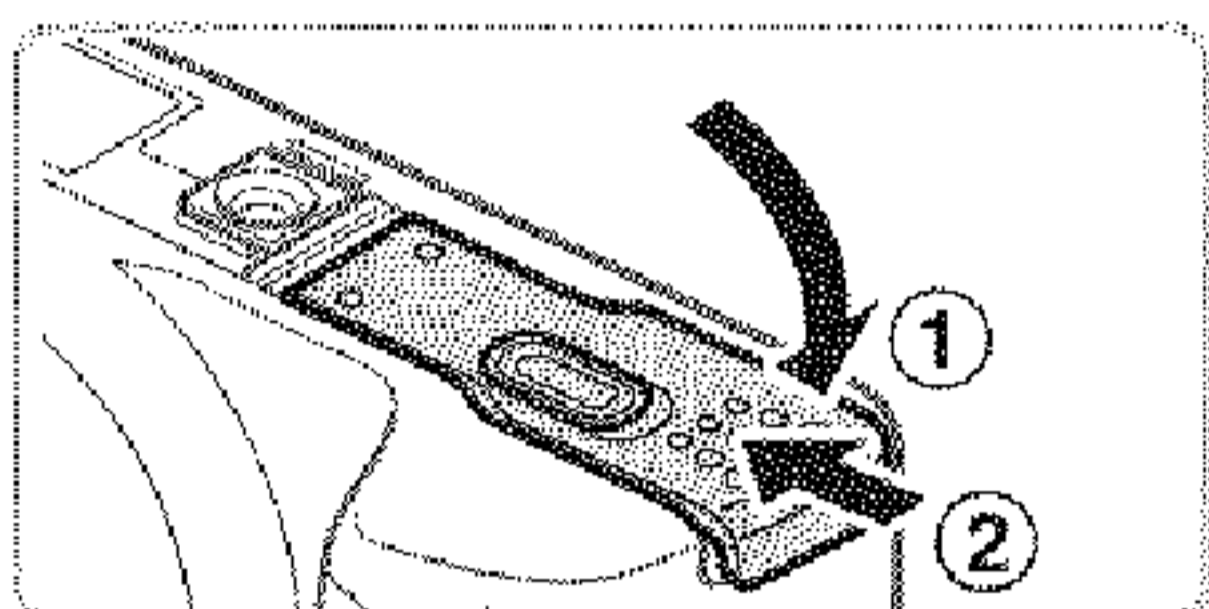

5 Close the cover.

- Lower the cover (①) and hold it down as you slide it, until it clicks into the closed position (②).



* For guidelines on how many shots or hours of recording can be saved on one memory card, see “Specifications” (217).

■ Removing the Battery and Memory Card

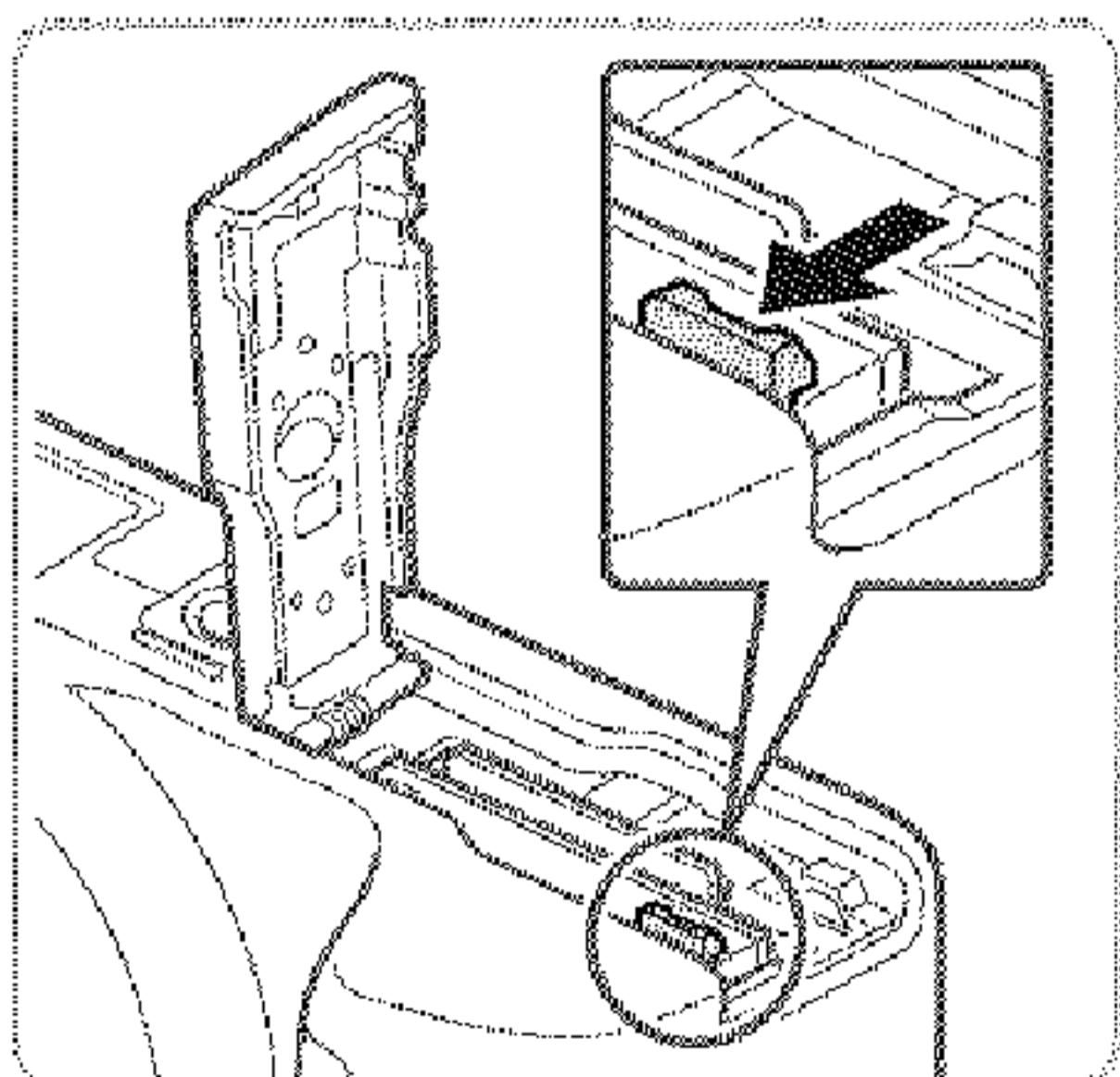

Remove the battery.

- Open the cover and press the battery lock in the direction of the arrow.
- ▶ The battery will pop up.

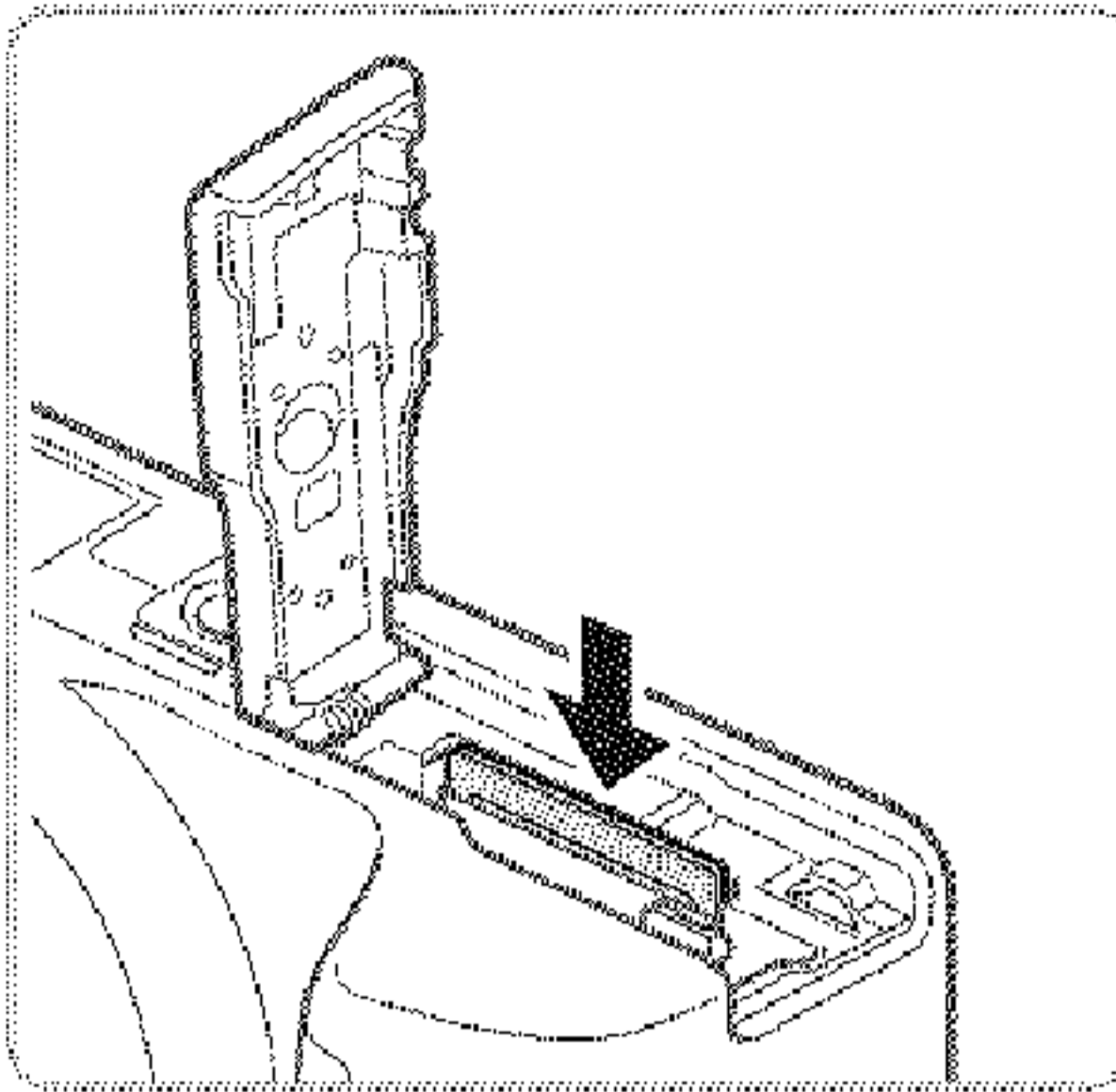

Remove the memory card.

- Push the memory card in until it clicks, and then slowly release it.
- ▶ The memory card will pop up.

Setting the Date and Time

Set the current date and time correctly as follows if the [Date/Time] screen is displayed when you turn the camera on. Information you specify this way is recorded in image properties when you shoot, and it is used when you manage images by shooting date or print images showing the date. You can also add a date stamp to shots, if you wish (65).

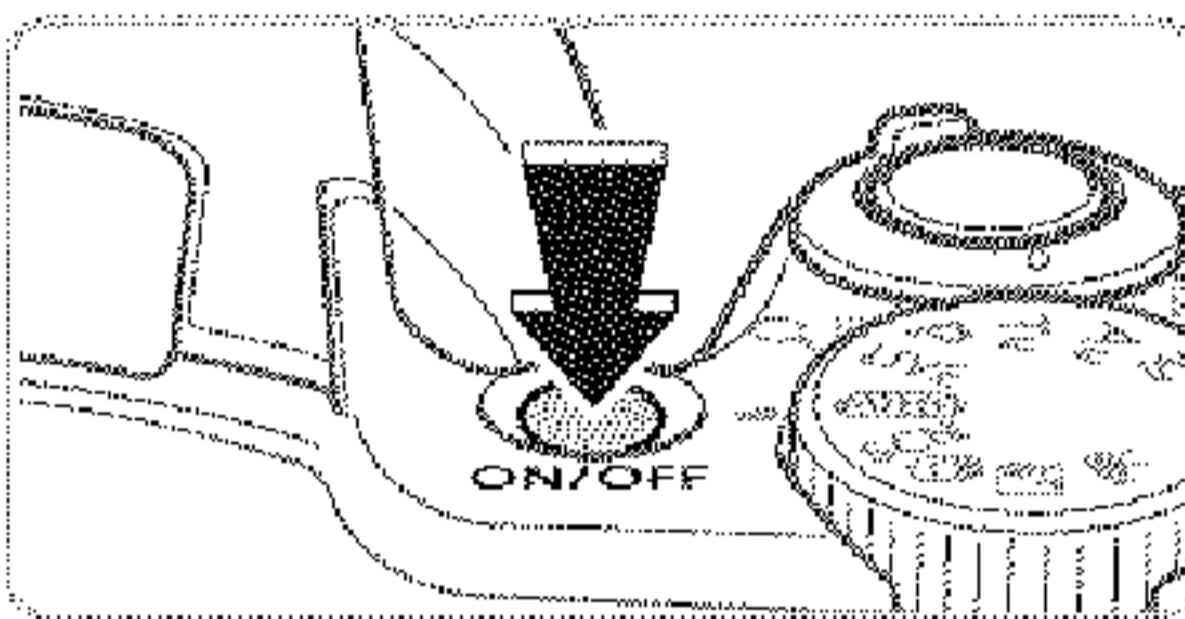

1 Turn the camera on.

- Press the power button.
- ▶ The [Date/Time] screen is displayed.



2 Set the date and time.

- Press the <◀><▶> buttons to choose an option.
- Press the <▲><▼> buttons or turn the <⦿> dial to specify the date and time.
- When finished, press the <FUNC SET> button.





3 Set the home time zone.

- Press the <◀><▶> buttons or turn the <⦿> dial to choose your home time zone.

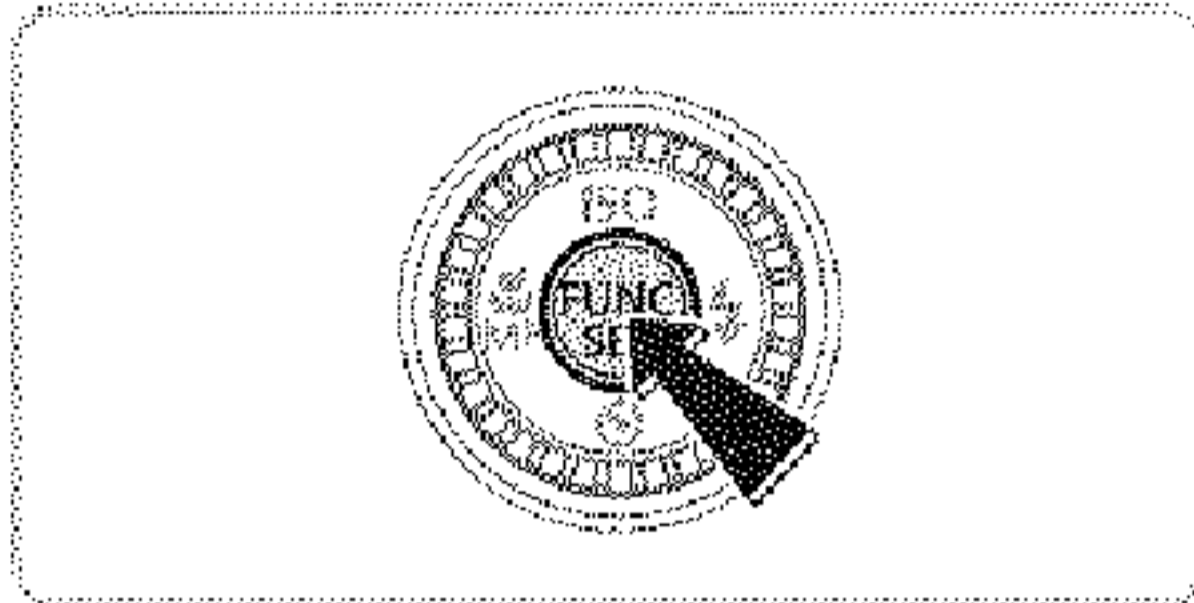

4 Finish the setup process.

- Press the <FUNC SET> button to complete the setting. The setting screen is no longer displayed.
- To turn off the camera, press the power button.



- * Unless you set the date, time, and home time zone, the [Date/Time] screen will be displayed each time you turn the camera on. Specify the correct information.



- * To set daylight saving time (1 hour ahead), choose [☀️ Off] in step 2 and then choose [☀️] by pressing the <▲><▼> buttons or turning the <⦿> dial.

■ Changing the Date and Time

Adjust the date and time as follows.

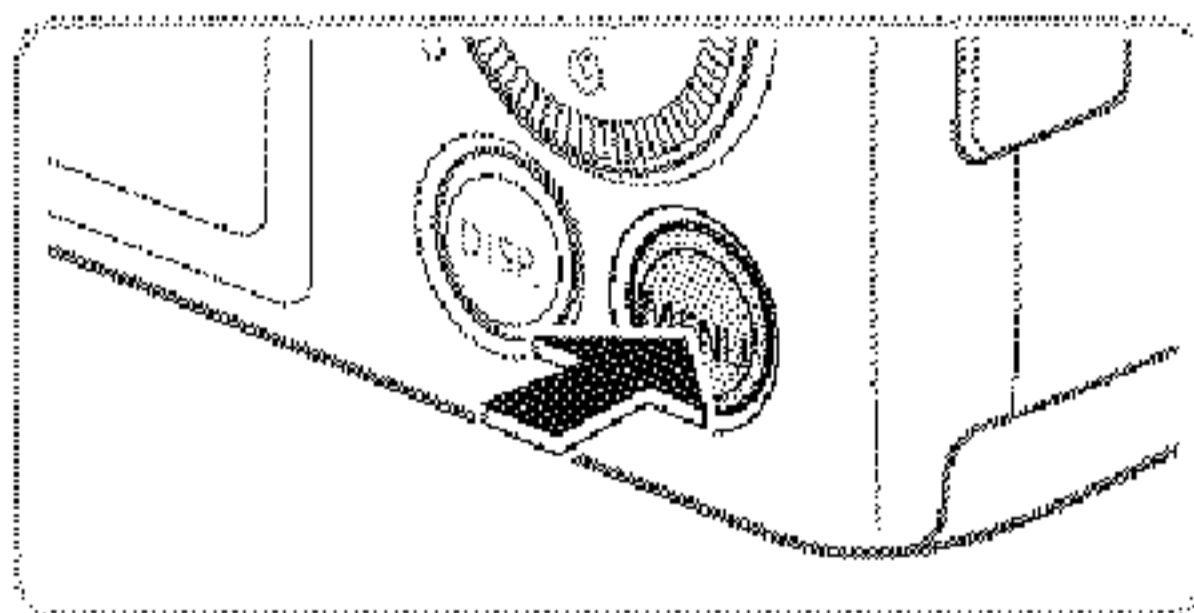

1 Access the camera menu.

- Press the <MENU> button.

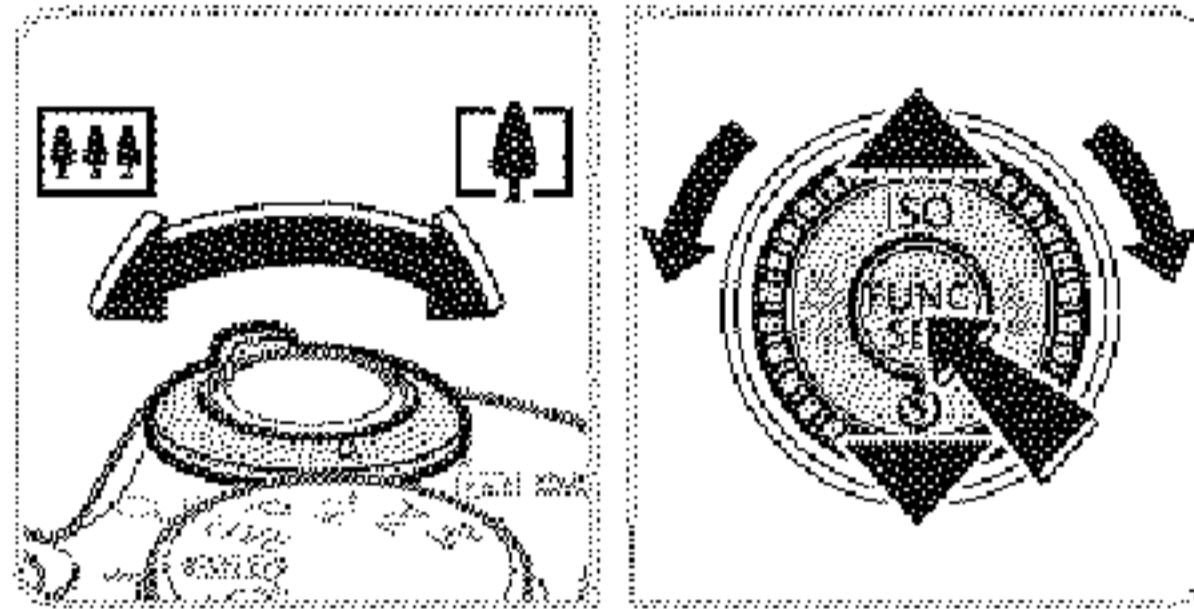
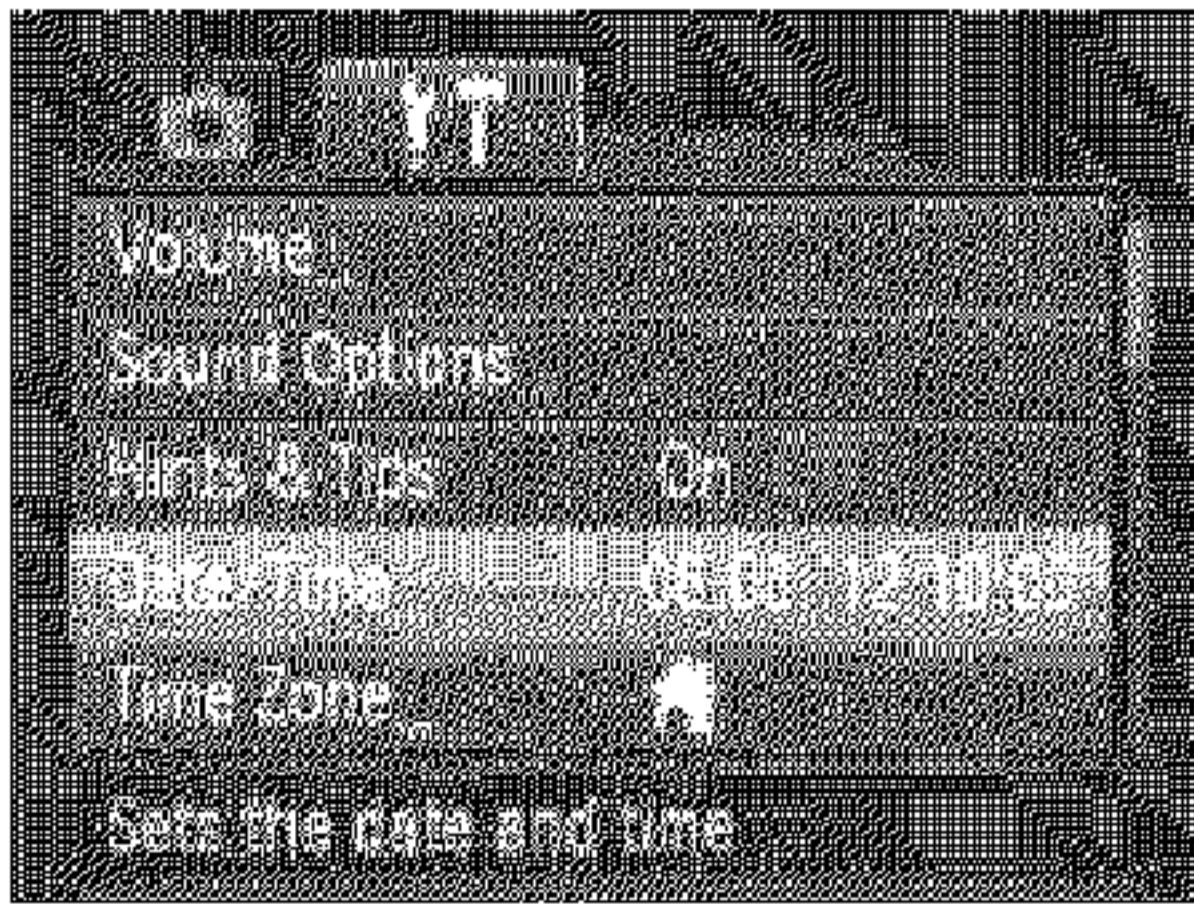

2 Choose [Date/Time].

- Move the zoom lever to choose the [YT] tab.
- Press the <▲><▼> buttons or turn the <◂> dial to choose [Date/Time], and then press the <FUNC SET> button.

3 Change the date and time.

- Follow step 2 on 22 to adjust the settings.
- Press the <MENU> button to close the menu.



- Date/time settings can be retained for about 3 weeks by the camera's built-in date/time battery (backup battery) after the battery pack is removed.
- The date/time battery will be charged in about 4 hours once you insert a charged battery or connect the camera to an AC adapter kit (sold separately, 171), even if the camera is left off.
- Once the date/time battery is depleted, the [Date/Time] screen will be displayed when you turn the camera on. Follow the steps on 22 to set the date and time.

Display Language

The display language can be changed as needed.

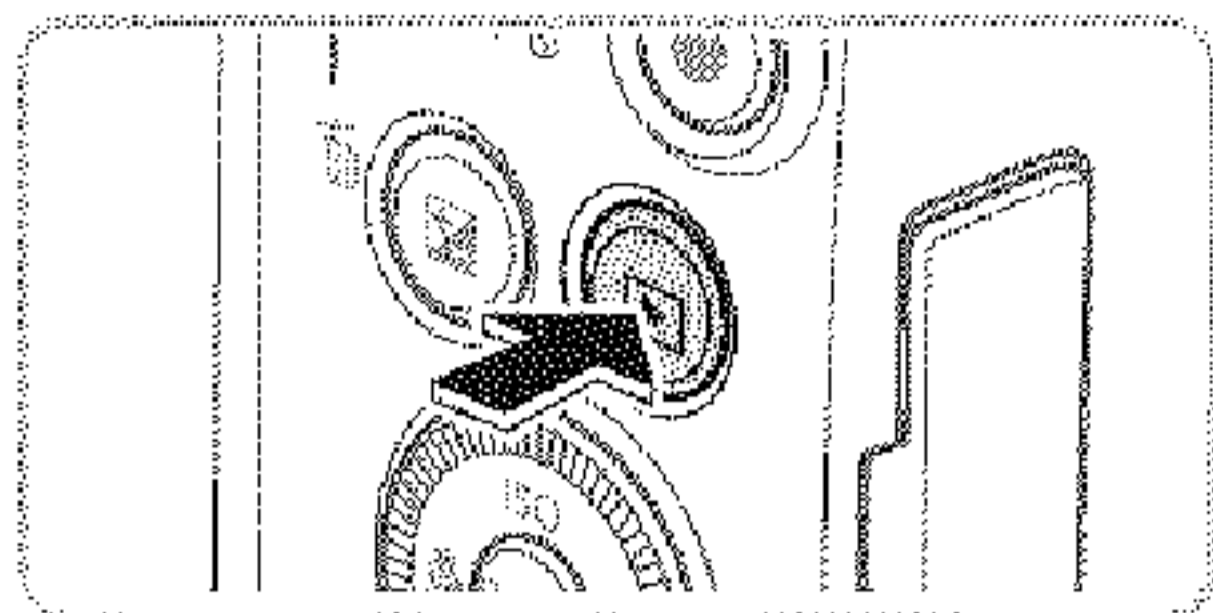

1 Enter Playback mode.

- Press the <▶> button.

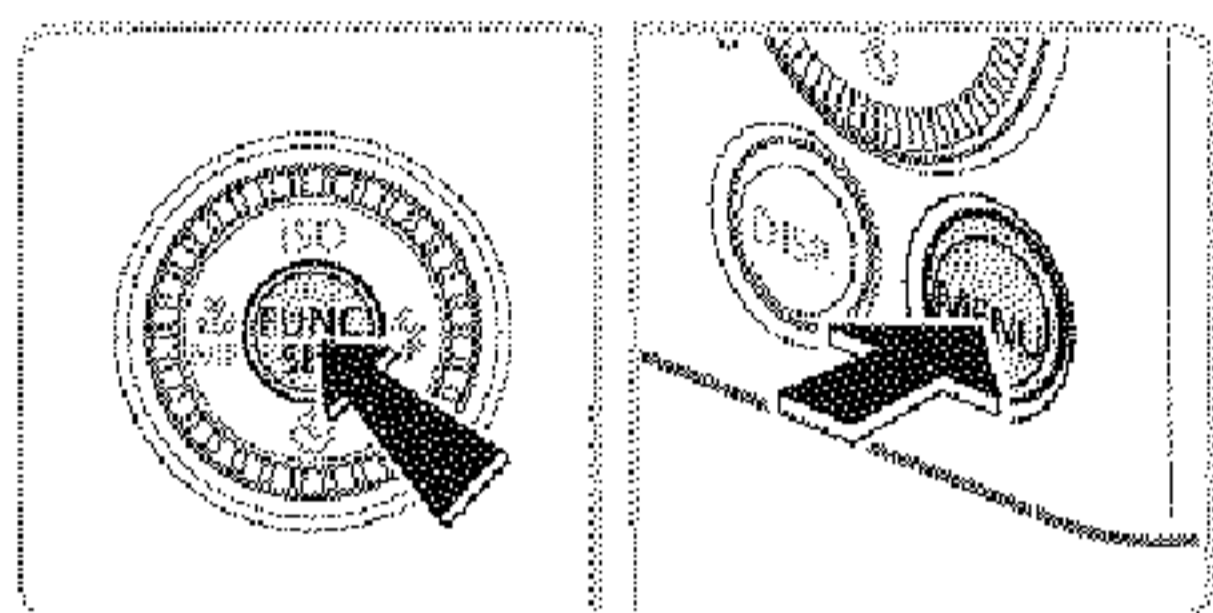

2 Access the setting screen.

- Press and hold the <FUNC SET> button, and then immediately press the <MENU> button.



3 Set the display language.

- Press the <▲><▼><◀><▶> buttons or turn the <◉> dial to choose a language, and then press the <FUNC SET> button.
- ▶ Once the display language has been set, the setting screen is no longer displayed.



- * The current time is displayed if you wait too long in step 2 after pressing the <FUNC SET> button before you press the <MENU> button. In this case, press the <FUNC SET> button to dismiss the time display and repeat step 2.
- * You can also change the display language by pressing the <MENU> button and choosing [Language] on the [F1] tab.

Trying the Camera Out

Follow these instructions to turn the camera on, shoot still images or movies, and then view them.

Shooting (Smart Auto)

For fully automatic selection of the optimal settings for specific scenes, simply let the camera determine the subject and shooting conditions.

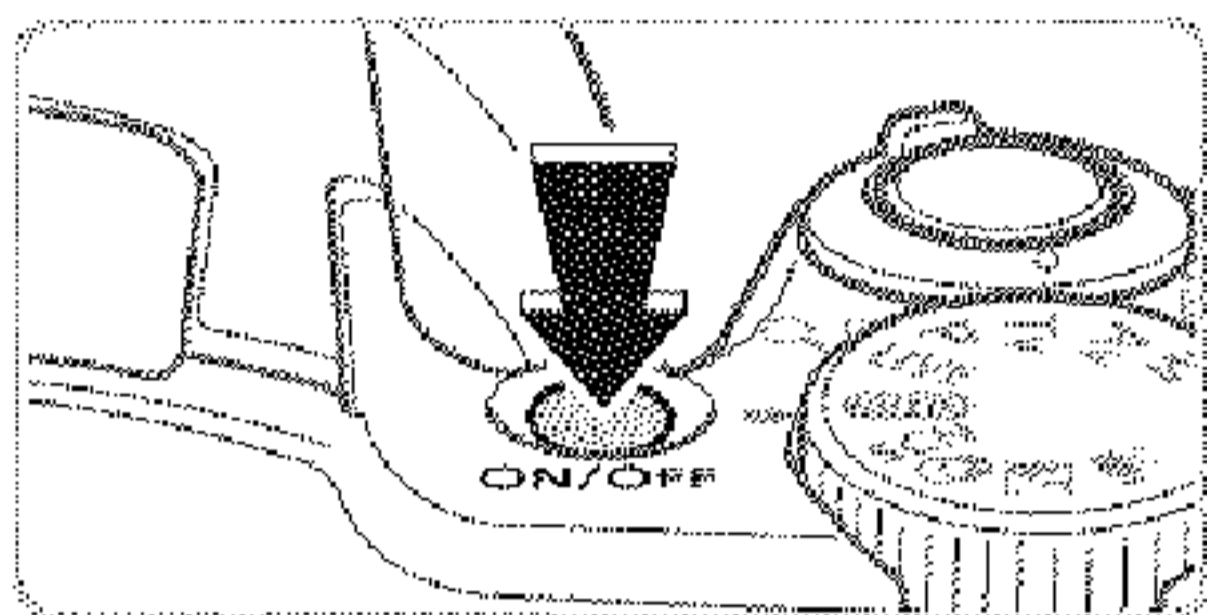

1 Turn the camera on.

- Press the power button.
- ▶ The startup screen is displayed.

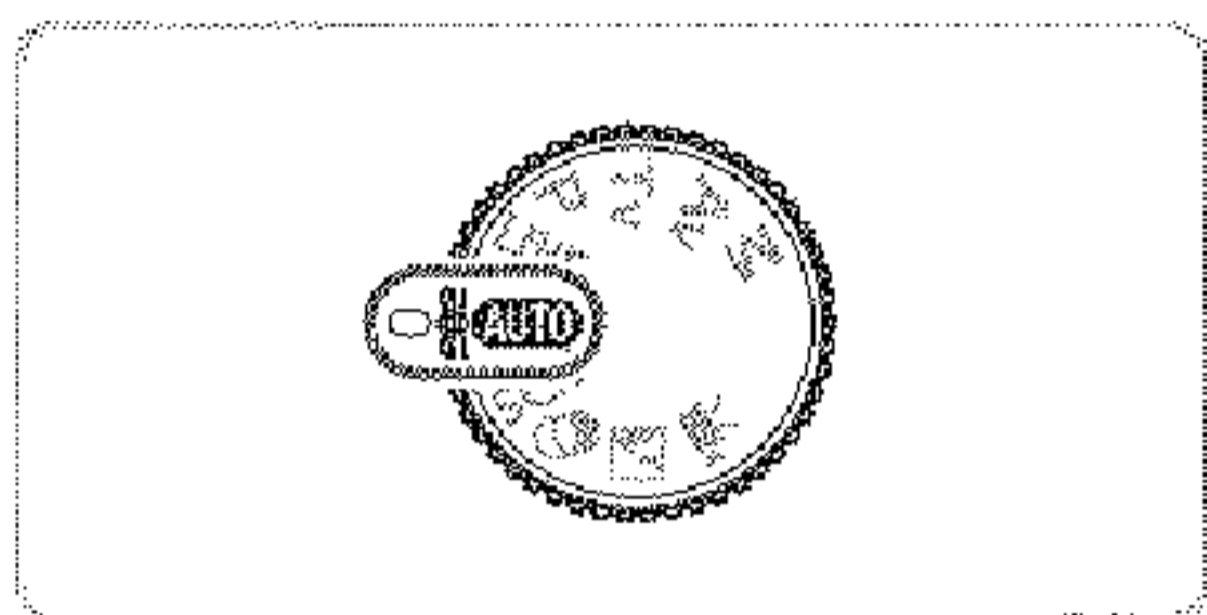

2 Enter <AUTO> mode.

- Set the mode dial to <AUTO>.
- Aim the camera at the subject. The camera will make a slight clicking noise as it determines the scene.
- ▶ Icons representing the scene and image stabilization mode are displayed in the upper right of the screen.
- ▶ Frames displayed around any detected subjects indicate that they are in focus.

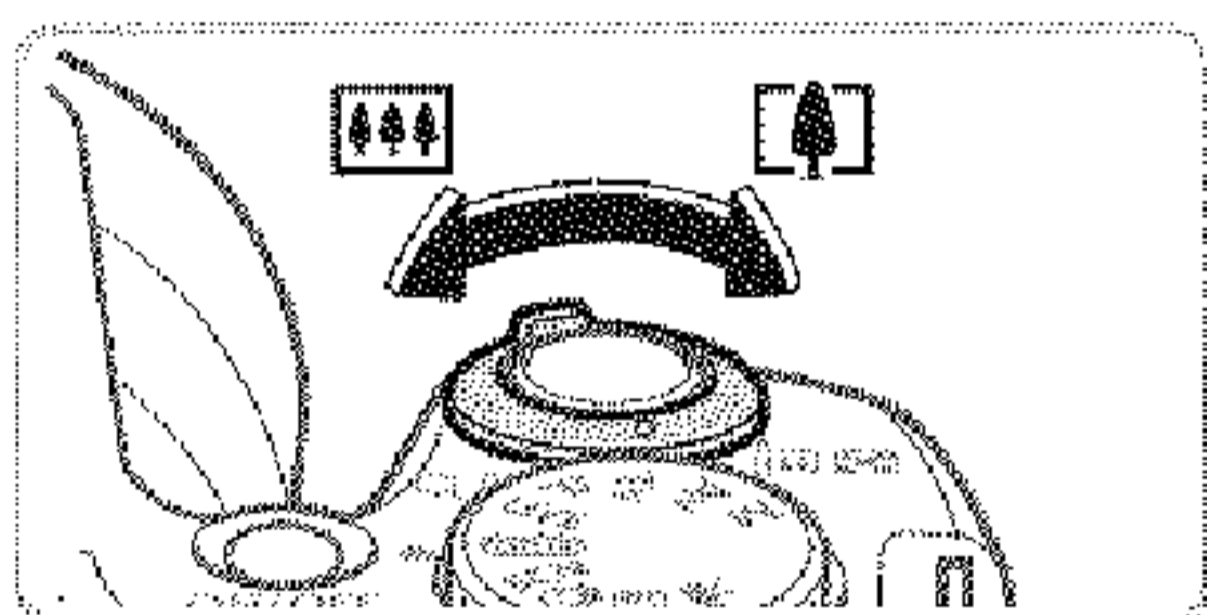

3 Compose the shot.

- To zoom in and enlarge the subject, move the zoom lever toward <[🌲]> (telephoto), and to zoom away from the subject, move it toward <[🌳]> (wide angle).

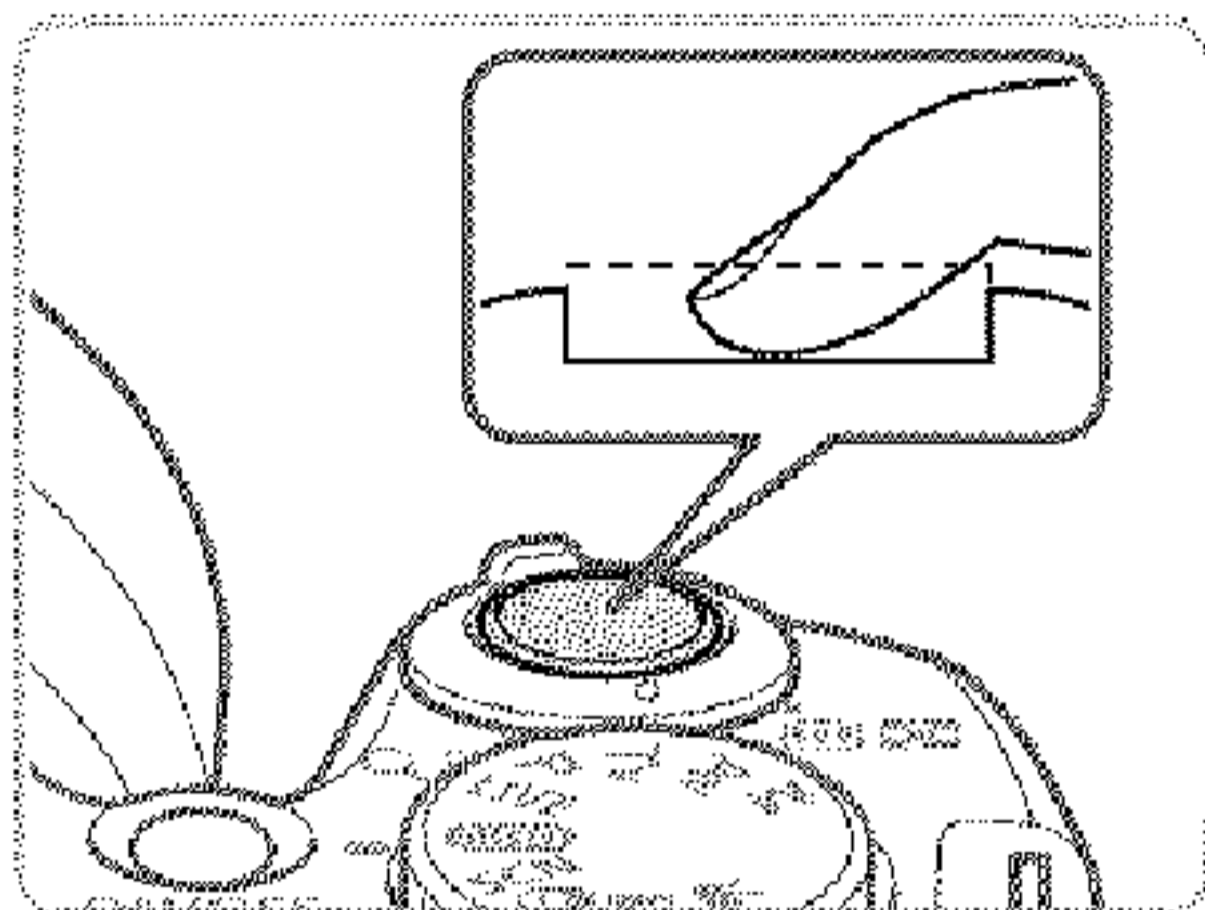
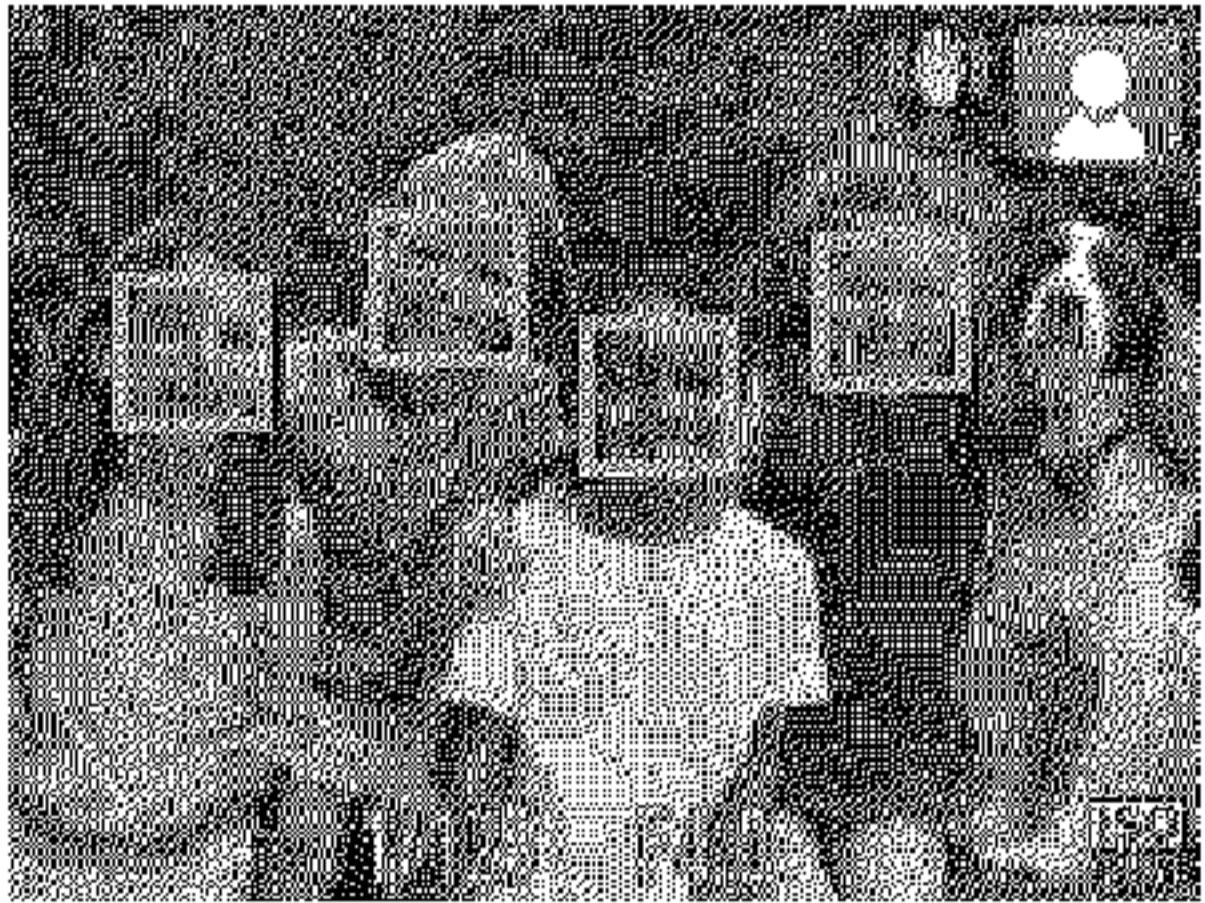
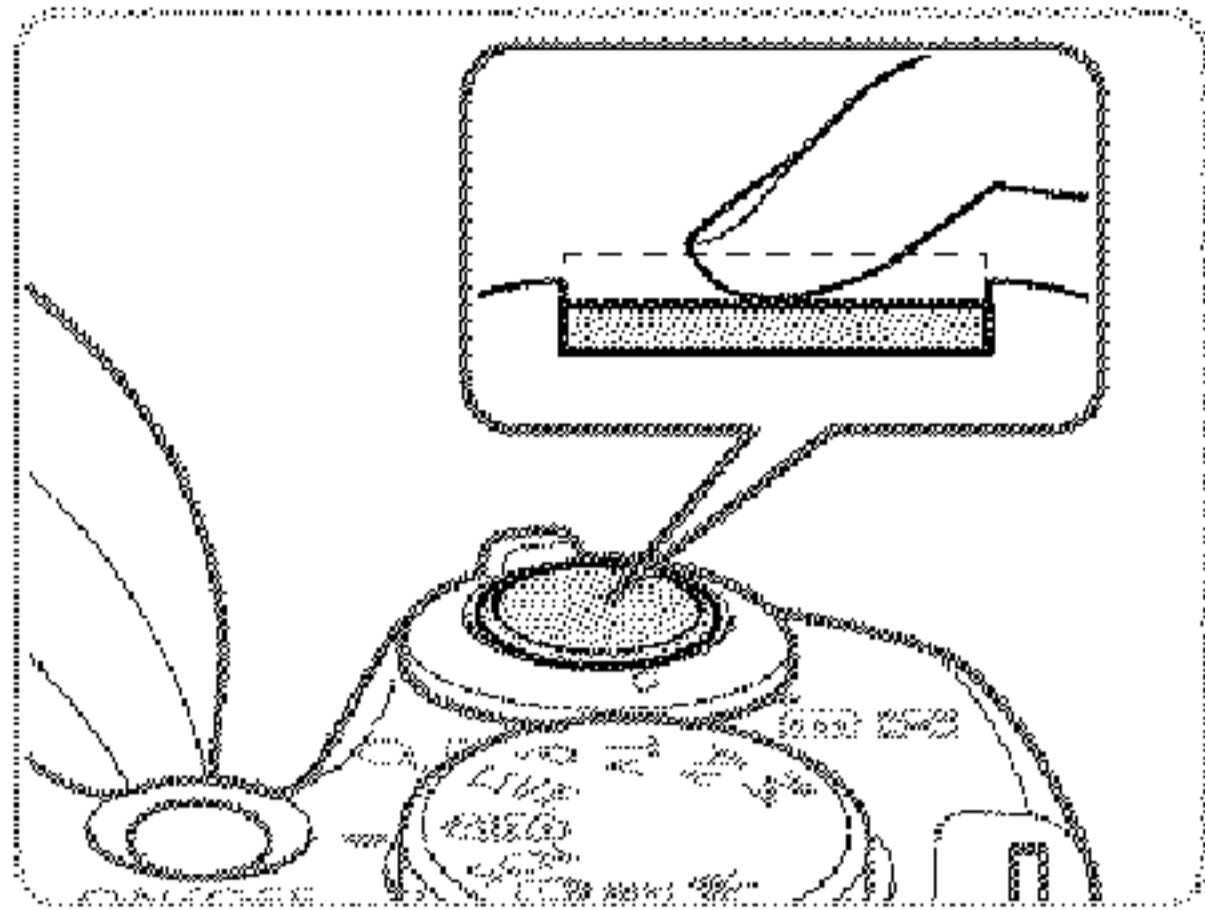

4 Shoot.

Shooting Still Images

① Focus.

- Press the shutter button lightly, halfway down. The camera beeps twice after focusing, and green frames are displayed to indicate image areas in focus.
- If [Raise the flash] is displayed, lift the flash with your finger to prepare it for use. If you prefer not to use the flash, push it down with your finger, into the camera.

② Shoot.

- Press the shutter button all the way down.
- ▶ As the camera shoots, a shutter sound is played, and in low-light conditions when you have raised the flash, it fires automatically.
- Keep the camera still until the shutter sound ends.
- ▶ Your shot remains displayed on the screen for about two seconds.
- Even while the shot is displayed, you can take another shot by pressing the shutter button again.

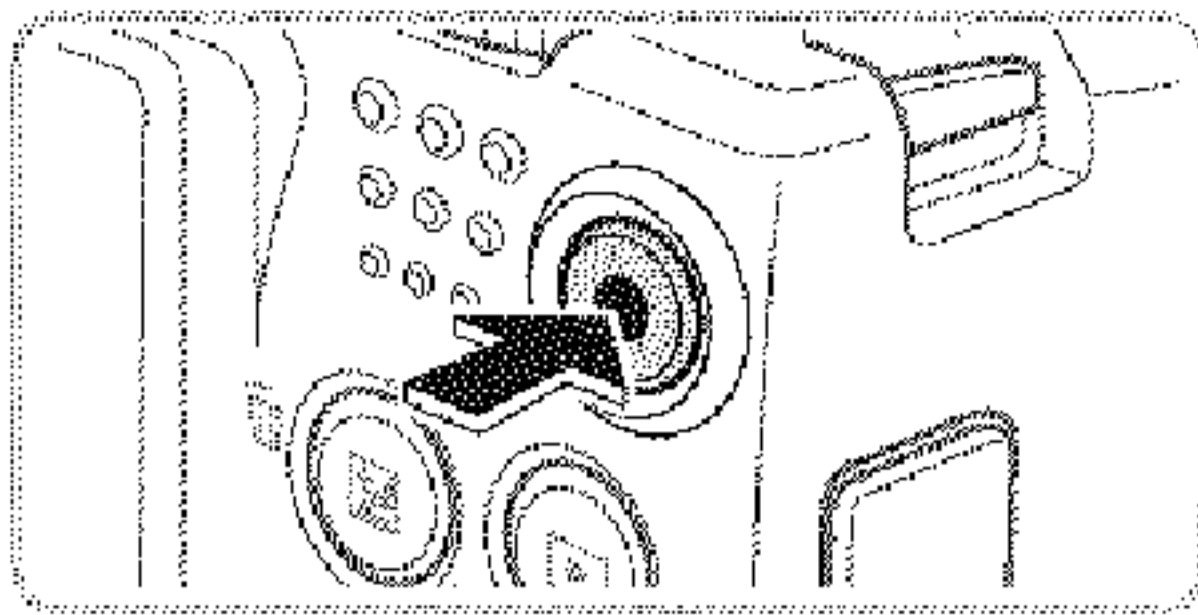

Elapsed Time

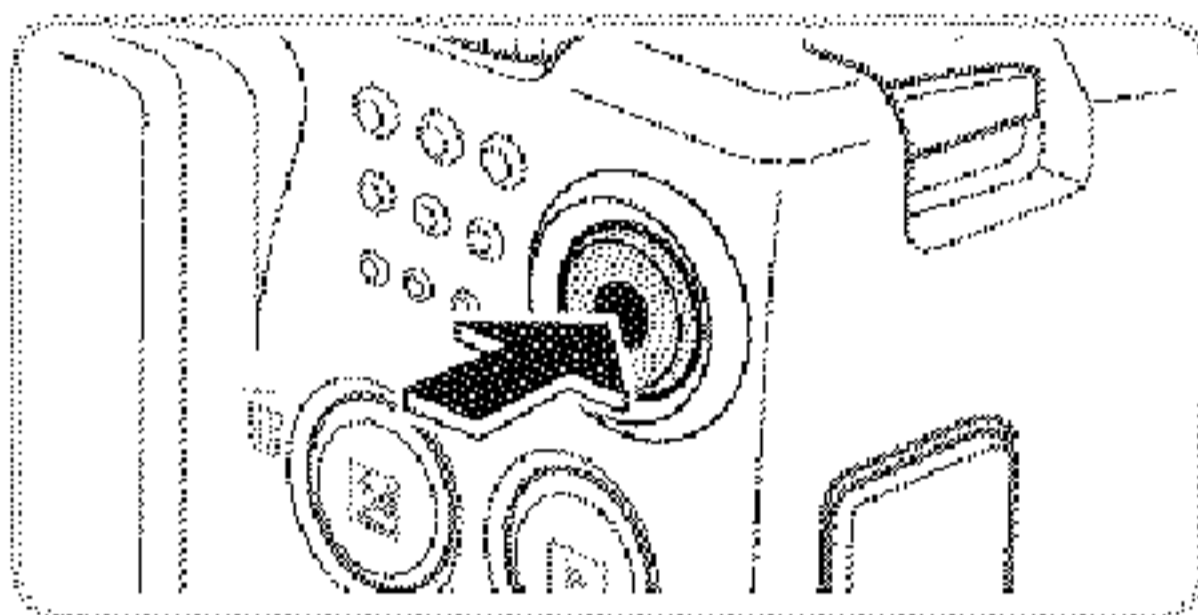
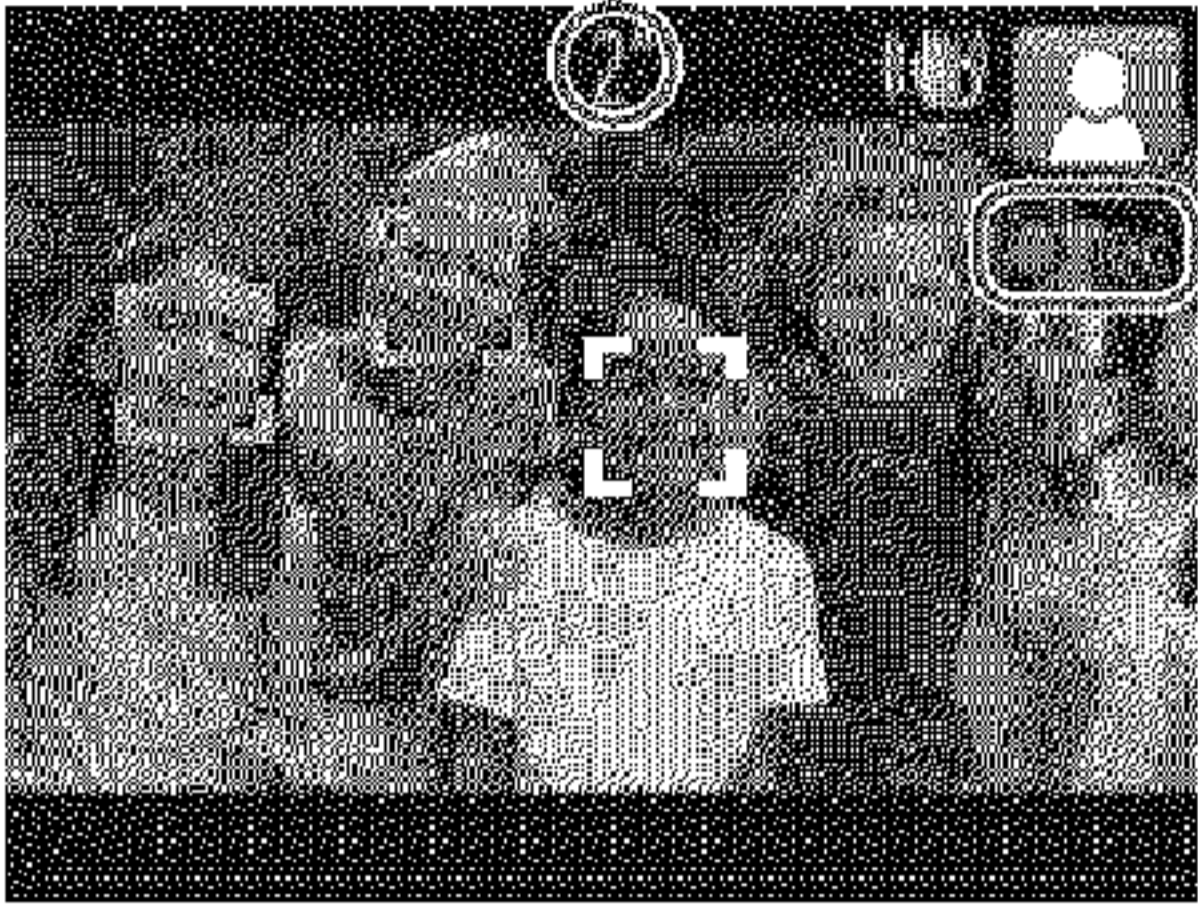

Shooting Movies

① Start shooting.

- Press the movie button. The camera beeps once as recording begins, and [●Rec] is displayed with the elapsed time.
- ▶ Black bars displayed on the top and bottom edges of the screen indicate image areas not recorded.
- ▶ Frames displayed around any detected faces indicate that they are in focus.
- Once recording begins, you can take your finger off the movie button.

② Finish shooting.

- Press the movie button again to stop shooting. The camera beeps twice as recording stops.

Viewing

After shooting images or movies, you can view them on the screen as follows.

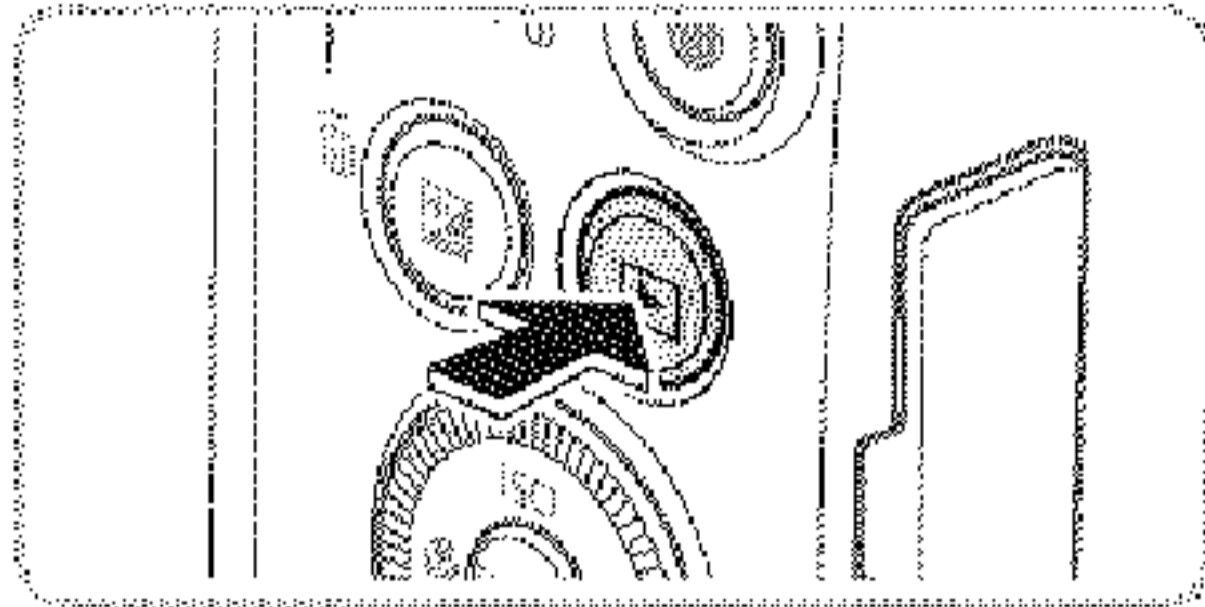

1 Enter Playback mode.

- Press the <▶> button.
- ▶ Your last shot is displayed.

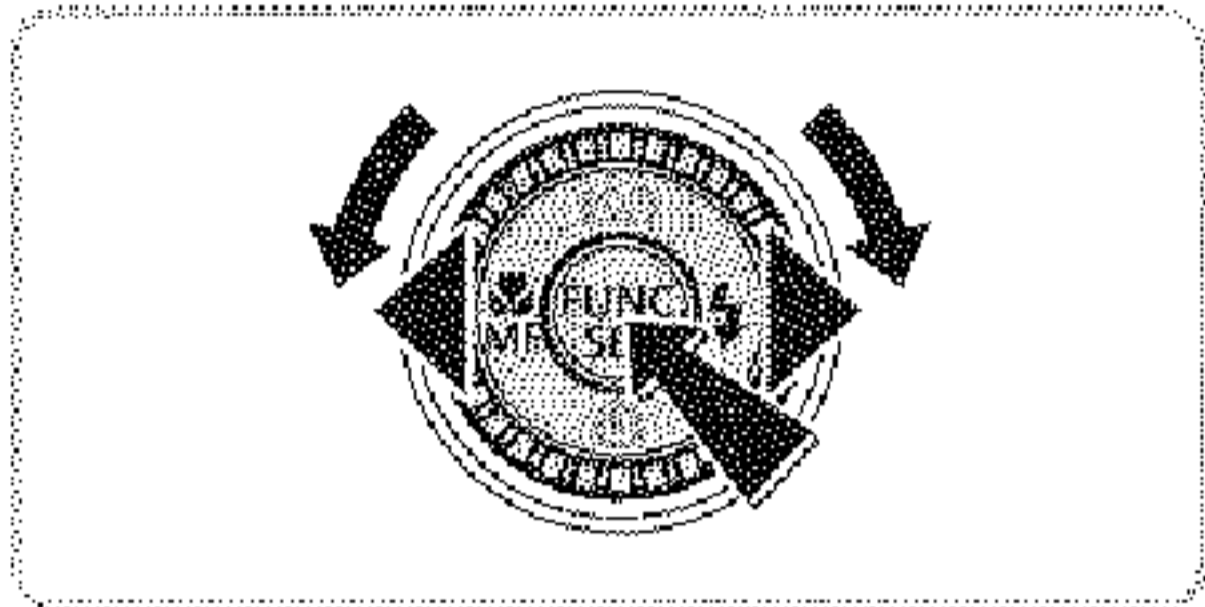

2 Browse through your images.



- To view the previous image, press the <◀> button or turn the <⊙> dial counterclockwise. To view the next image, press the <▶> button or turn the <⊙> dial clockwise.
- Press and hold the <◀><▶> buttons to browse through images quickly. Images appear grainy at this time.



- To access Scroll Display mode, turn the <⊙> dial rapidly. In this mode, turn the <⊙> dial to browse through images.
- To return to single-image display, press the <FUNC SET> button.



- Movies are identified by a [SET] [MOVIE] icon. To play movies, go to step 3.



Volume

3 Play movies.

- Press the <FUNC. SET> button to access the movie control panel, choose [▶] (either press the <◀><▶> buttons or turn the <◉> dial), and then press the <FUNC. SET> button again.
- ▶ Playback now begins, and after the movie is finished, [SET] is displayed.
- To adjust the volume, press the <▲><▼> buttons.



• To switch to Shooting mode from Playback mode, press the shutter button halfway.

Erasing the Images

You can choose and erase unneeded images one by one. Be careful when erasing images, because they cannot be recovered.



1 Choose an image to erase.

- Press the <◀><▶> buttons or turn the <◉> dial to choose an image.

2 Erase the image.

- Press the <🗑️> button.
- After [Erase?] is displayed, press the <◀><▶> buttons or turn the <◉> dial to choose [Erase], and then press the <FUNC. SET> button.
- ▶ The current image is now erased.
- To cancel erasure, press the <◀><▶> buttons or turn the <◉> dial to choose [Cancel], and then press the <FUNC. SET> button.



• You can also erase all images at once (137).

Included Software, PDF Manuals

The software and PDF manuals on the included DIGITAL CAMERA Solution Disk (CD-ROM) (📖2) are introduced below, with instructions for installation, and saving images to a computer.

Software

After installing the software on the CD-ROM, you can do the following things on your computer.

CameraWindow

- Import images and change camera settings

ImageBrowser EX

- Manage images: view, search, and organize
- Print and edit images

Auto Update Function

Using the included software, you can update to the latest version, and download new functions via the Internet (some software excluded). Be sure to install the software on a computer with an Internet connection so you can use this function.



- * Internet access is required to use this function, and any ISP account charges and access fees must be paid separately.

PDF Manuals

Camera User Guide

- Refer to this guide for a more in-depth understanding of camera operation.

Software Guide

- Refer to this guide when using the included software. The guide can be accessed from the help system of included software (some software excluded).

System Requirements

The included software can be used on the following computers. Adobe Reader is required to view the PDF manuals.

	Windows	Macintosh
Operating System	Windows 7 SP1 Windows Vista SP2 Windows XP SP3	Mac OS X 10.6 – 10.7
Computer	Computers running one of the above operating systems (preinstalled), with an included USB port and Internet connection*	
Processor	Still images 1.6 GHz or higher Movies Core 2 Duo 1.66 GHz or higher	Mac OS X 10.7: Core 2 Duo or higher Mac OS X 10.6: Core Duo 1.83 GHz or higher
RAM	Still images Windows 7 (64 bit): 2 GB or more Windows 7 (32 bit), Vista: 1 GB or more Windows XP: 512 MB or more Movies 1 GB or more	Mac OS X 10.7: 2 GB or more Mac OS X 10.6: 1 GB or more
Interfaces	USB	
Free Hard Disk Space	440 MB or more*	550 MB or more
Display	1024 x 768 resolution or higher	

* Silverlight 4 or later (max. 100 MB) must be installed, and in Windows XP, Microsoft .NET Framework 3.0 or later (max. 500 MB) must be installed. Installation may take some time, depending on computer performance.



* Check the Canon website for the latest system requirements, including supported OS versions.

Installing the Software

Windows 7 and Mac OS X 10.6 are used here for the sake of illustration. Using the software auto update function, you can update to the latest version and download new functions via the Internet (some software excluded), so be sure to install the software on a computer with an Internet connection.

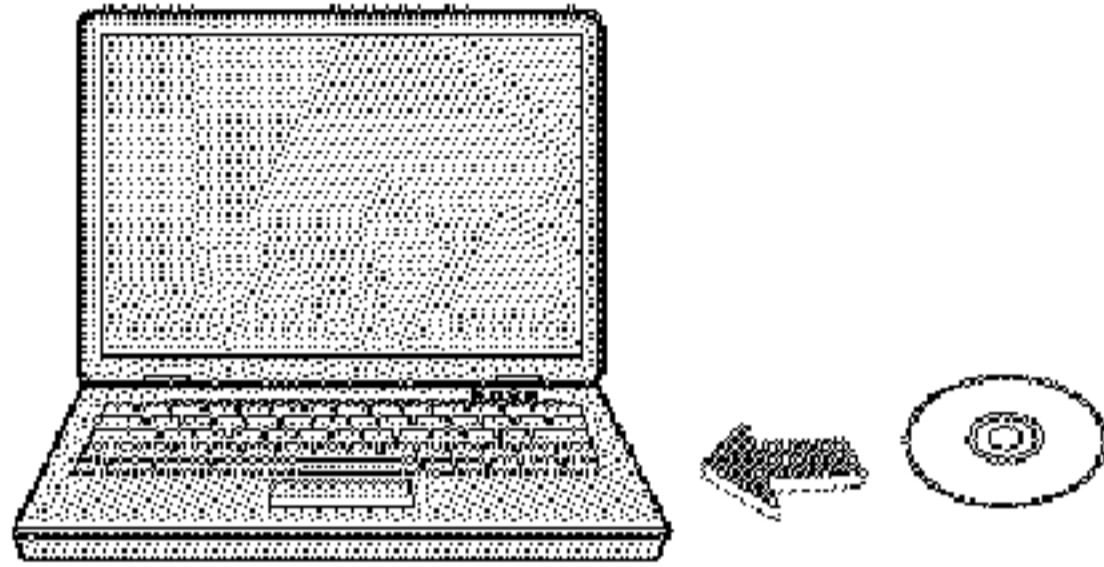

1 Insert the CD-ROM in the computer's CD-ROM drive.

- Insert the included CD-ROM (DIGITAL CAMERA Solution Disk) (2) in the computer's CD-ROM drive.
- On a Macintosh computer, after inserting the disc, double-click the desktop disc icon to open it, and then double-click the [] icon displayed.

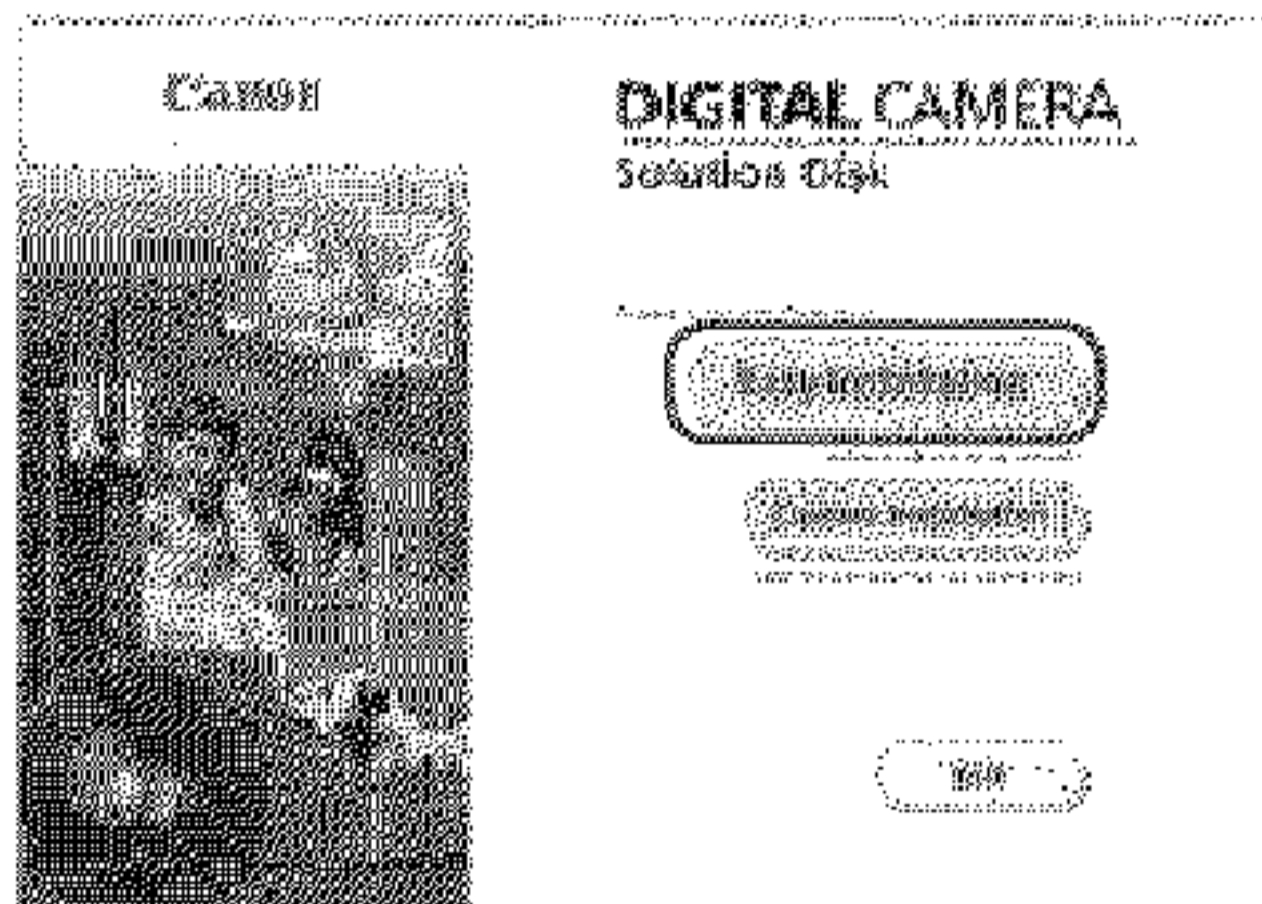

2 Begin the installation.

- Click [Easy Installation] and follow the on-screen instructions to complete the installation process.

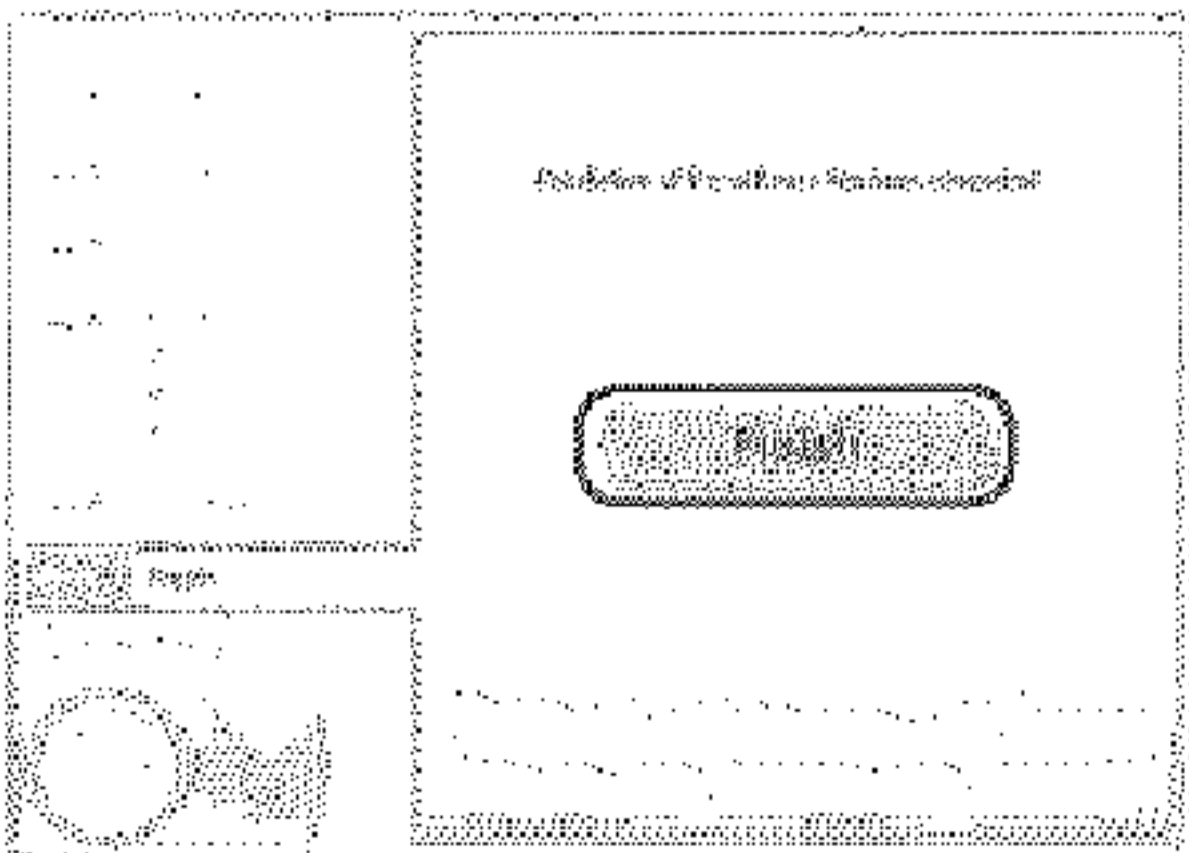
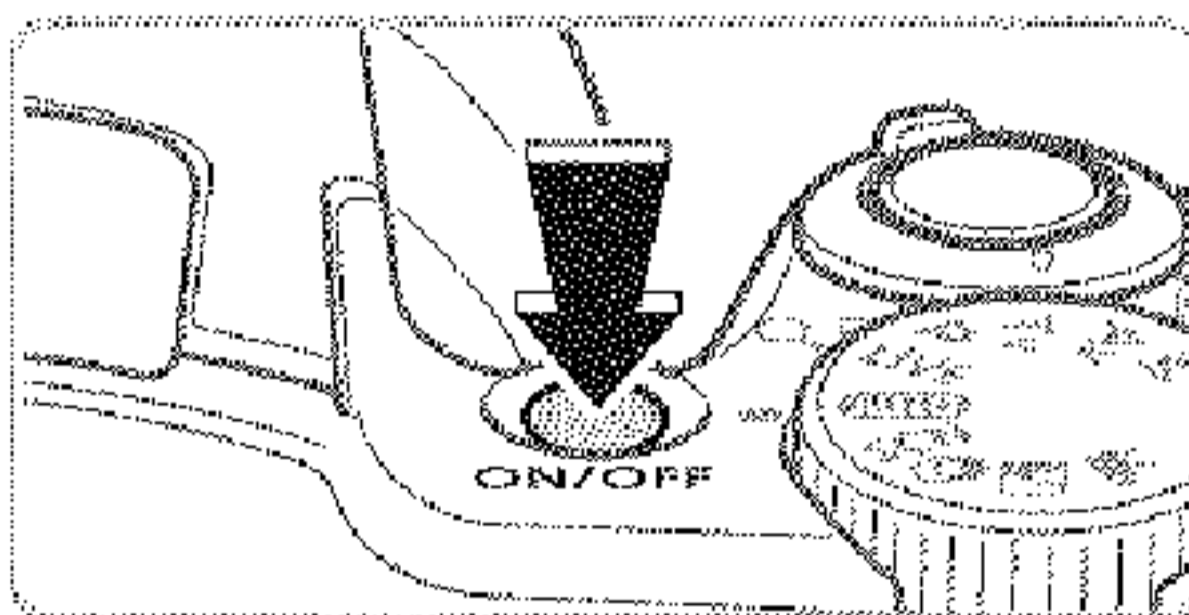
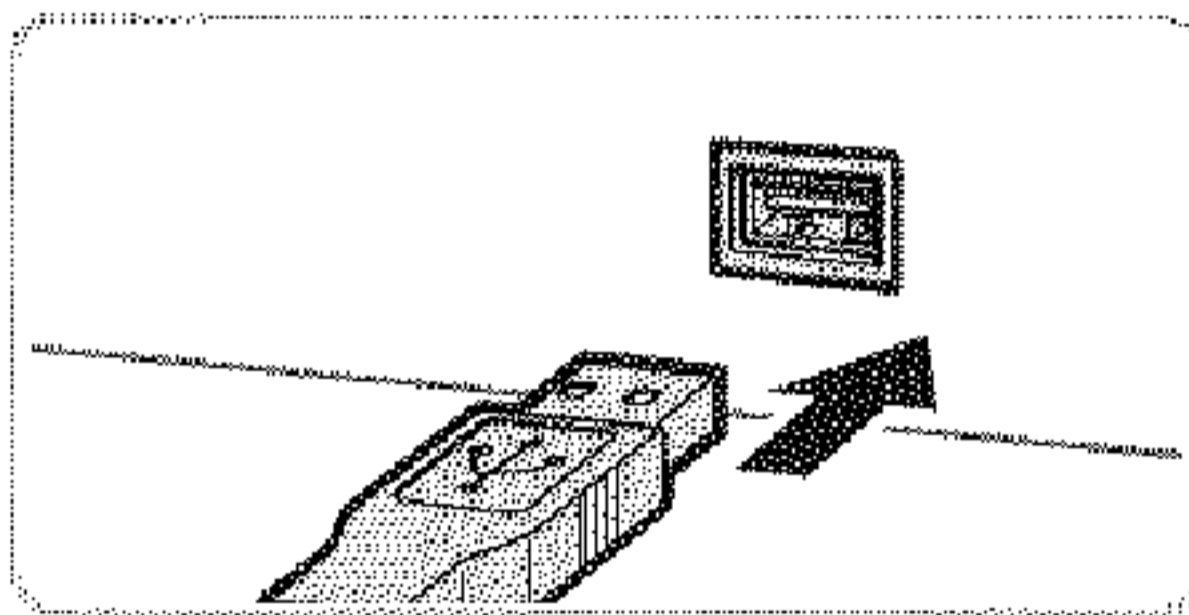
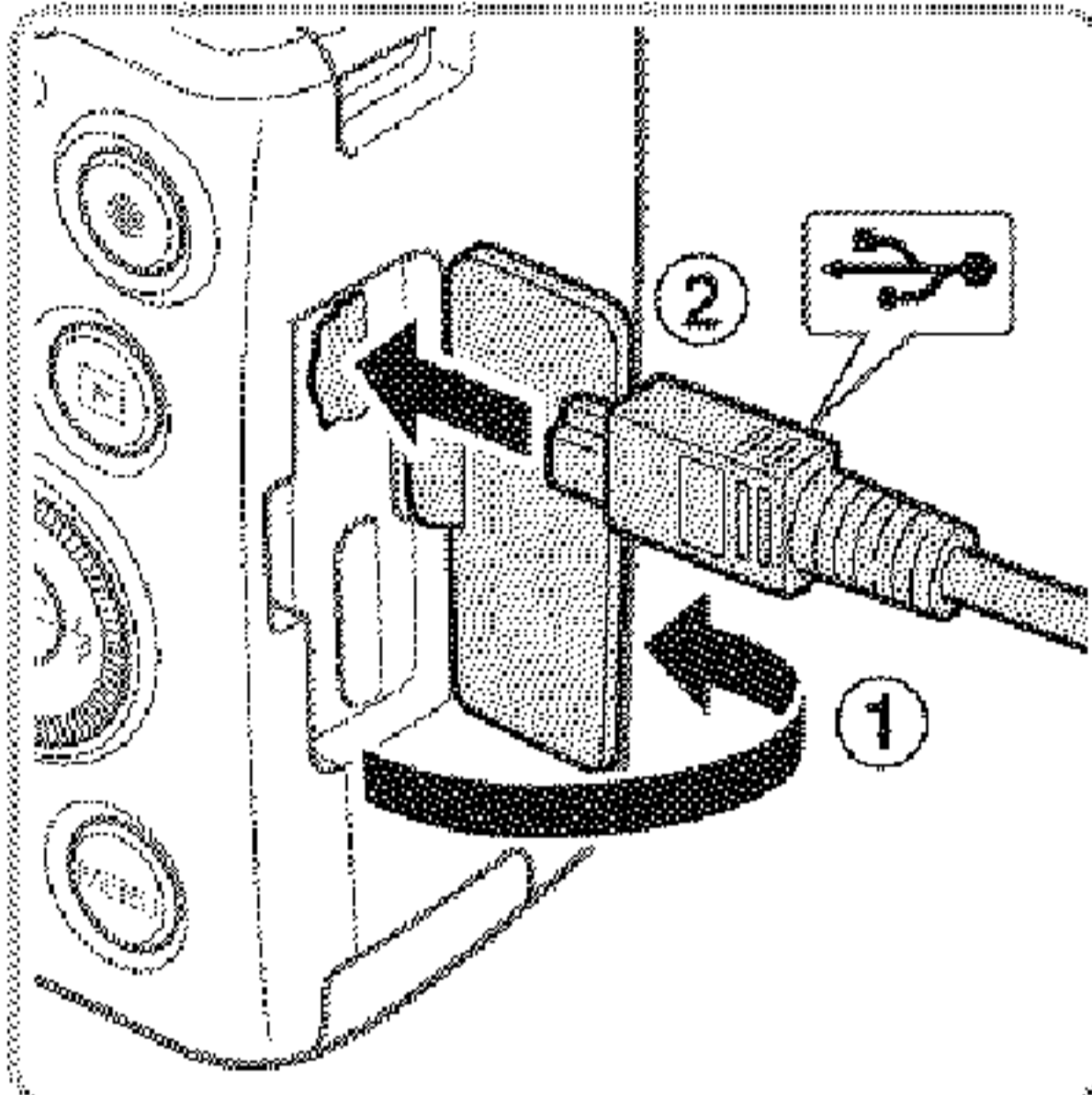
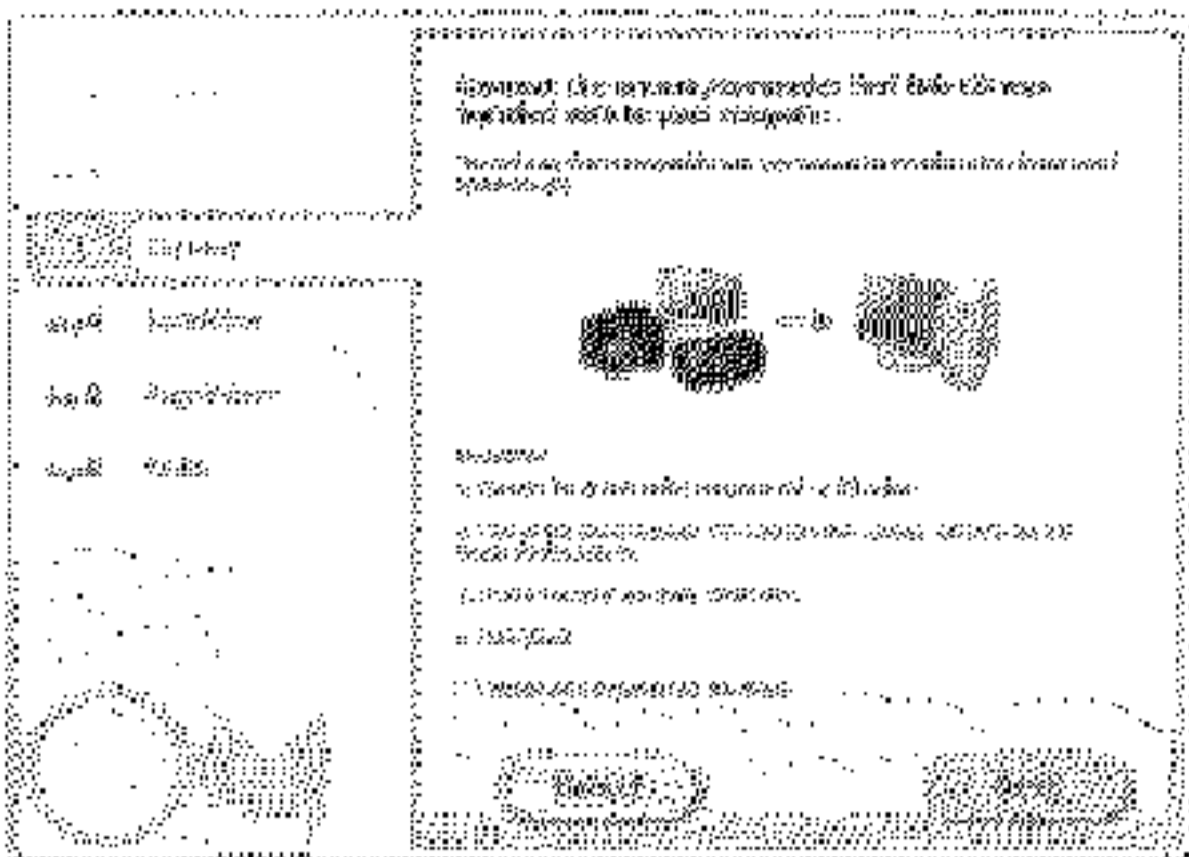

3 When a message is displayed prompting you to connect the camera, connect it to a computer.

- With the camera turned off, open the cover (1). With the smaller plug of the included interface cable (2) in the orientation shown, insert the plug fully into the camera terminal (2).

- Insert the larger plug of the interface cable in the computer's USB port. For details about USB connections on the computer, refer to the computer user manual.

4 Install the files.

- Turn the camera on, and follow the on-screen instructions to complete the installation process.
- ▶ The software will connect to the Internet to update to the latest version and download new functions. Installation may take some time, depending on computer performance and the Internet connection.
- Click [Finish] or [Restart] on the screen after installation and remove the CD-ROM when the desktop is displayed.
- Turn the camera off and disconnect the cable.



- * When not connected to the Internet, there are the following limitations.
 - The screen in step 3 will not be displayed.
 - Some functions may not be installed.
- * The first time you connect the camera to the computer, drivers will be installed, so it may take a few minutes until camera images are accessible.
- * If you have several cameras that were bundled with ImageBrowser EX on the included CD-ROMs, be sure to use each camera with their included CD-ROM and follow the on-screen installation instructions for each. Doing so will ensure that each camera will receive the correct updates and new functions via the auto update function.

Saving Images to a Computer

Windows 7 and Mac OS X 10.6 are used here for the sake of illustration.

1 Connect the camera to the computer.

- Follow step 3 on  34 to connect the camera to a computer.

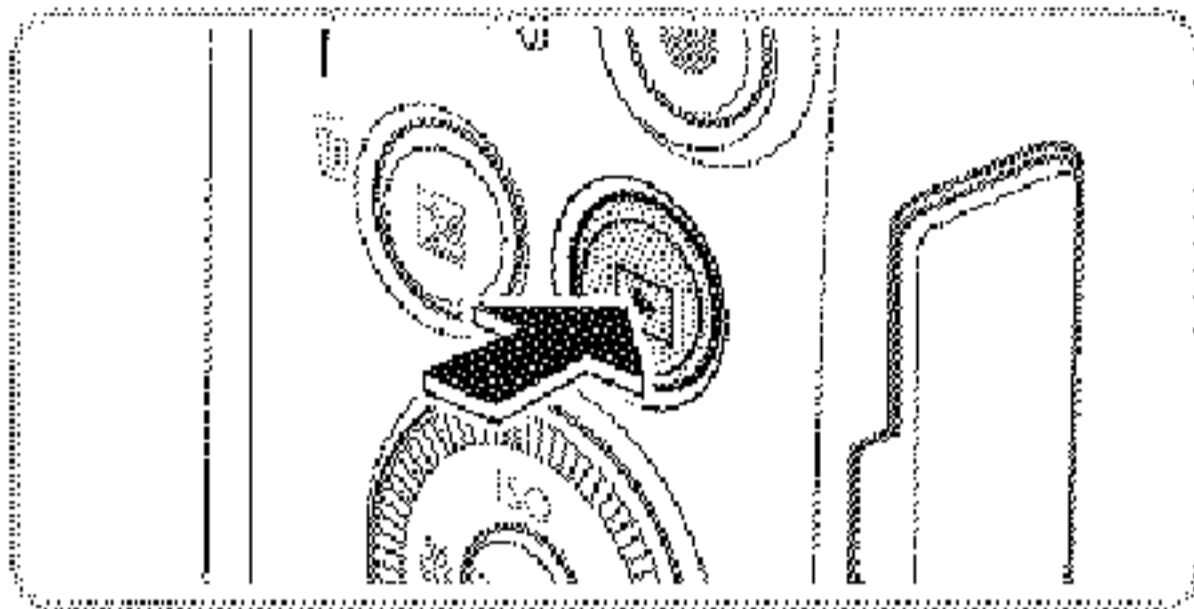

2 Turn the camera on to access CameraWindow.

- Press the  button to turn the camera on.
- On a Macintosh computer, CameraWindow is displayed when a connection is established between the camera and computer.

- For Windows, follow the steps introduced below.

- In the screen that displays, click the  link to modify the program.

- Choose [Downloads Images From Canon Camera using Canon CameraWindow] and then click [OK].

- Double click .

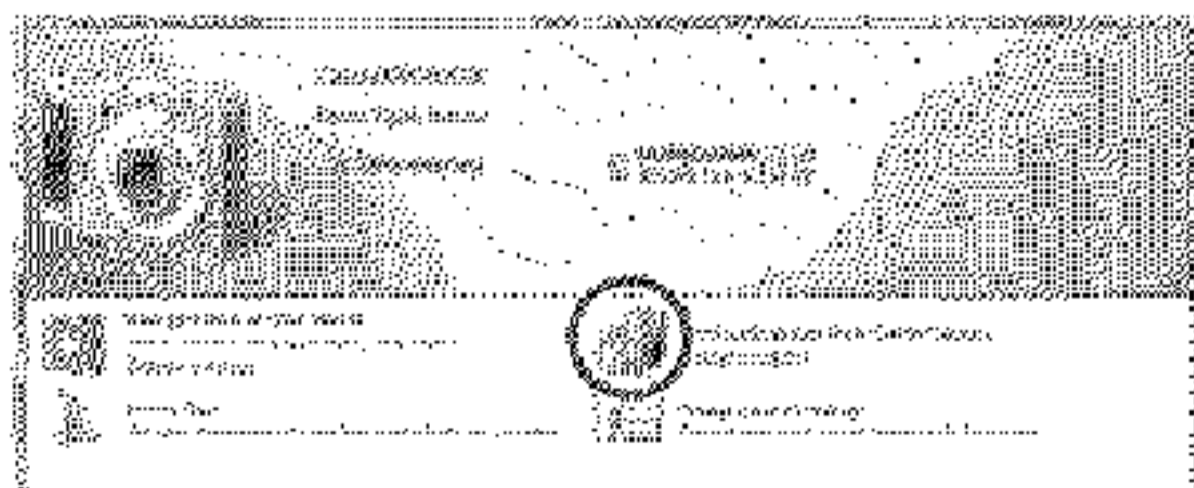
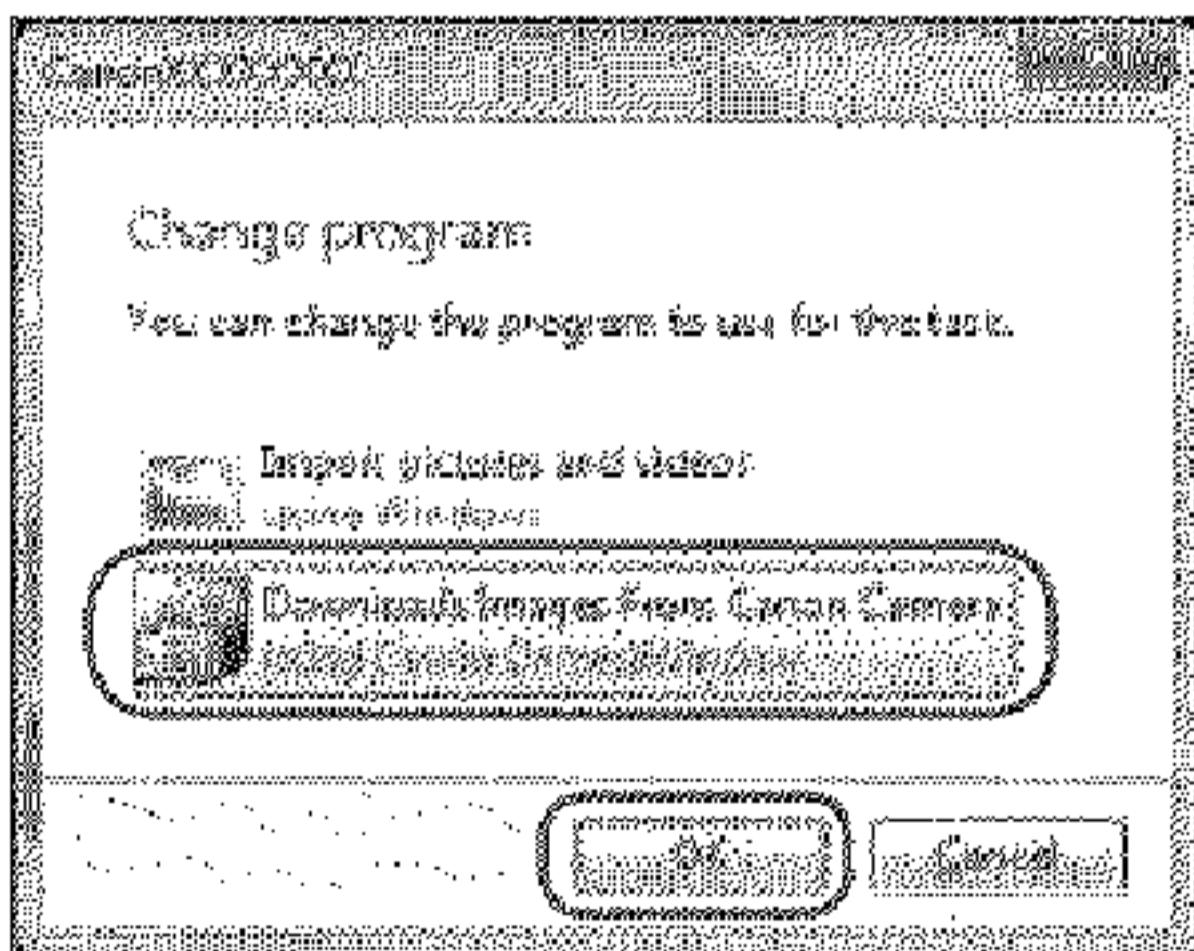
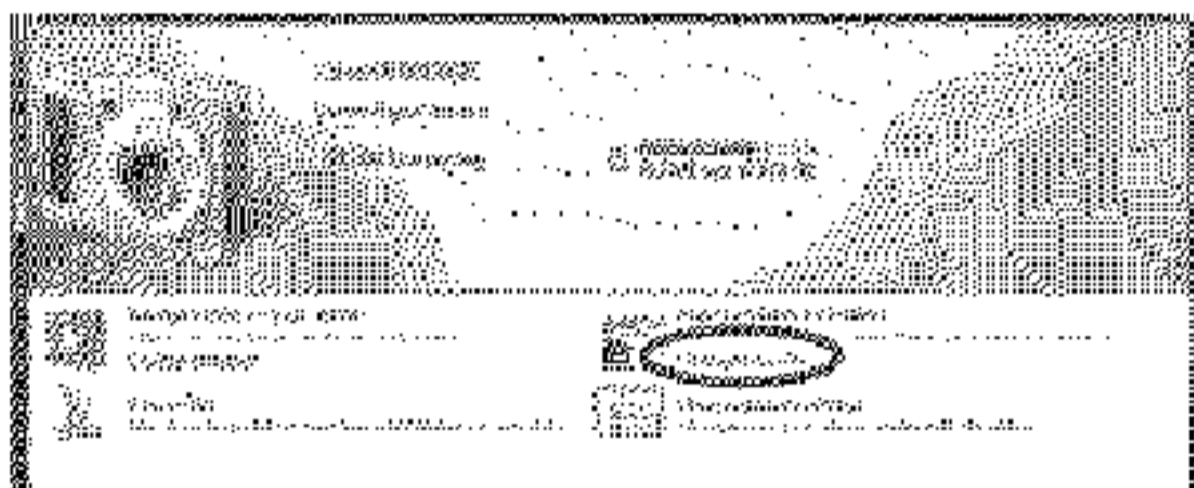

CameraWindow

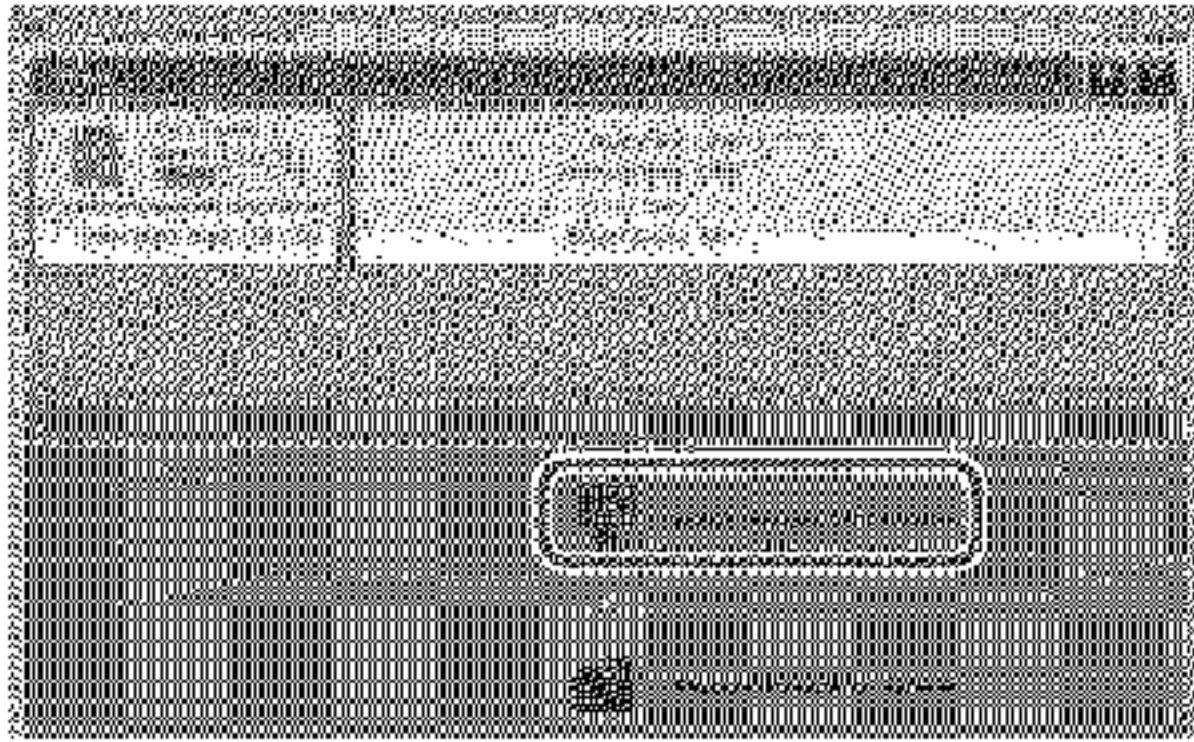

3 Save the images to the computer.

- Click [Import Images from Camera], and then click [Import Untransferred Images].
- ▶ Images are now saved to the Pictures folder on the computer, in separate folders named by date.
- After images are saved, close CameraWindow, press the <▶> button to turn the camera off, and unplug the cable.
- For instructions on viewing images on a computer, refer to the *Software Guide* (📖31).



- * In Windows 7, if the screen in step 2 is not displayed, click the [] icon in the taskbar.
- * To start CameraWindow in Windows Vista or XP, click [Downloads Images From Canon Camera using Canon CameraWindow] on the screen displayed when you turn the camera on in step 2. If CameraWindow is not displayed, click the [Start] menu and choose [All Programs] ► [Canon Utilities] ► [CameraWindow] ► [CameraWindow].
- * On a Macintosh computer, if CameraWindow is not displayed after step 2, click the [CameraWindow] icon in the Dock (the bar at the bottom of the desktop).
- * Although you can save images to a computer simply by connecting your camera to the computer without using the included software, the following limitations apply.
 - It may take a few minutes after you connect the camera to the computer until camera images are accessible.
 - Images shot in vertical orientation may be saved in horizontal orientation.
 - Image protection settings may be cleared from images saved to a computer.
 - Some problems may occur when saving images or image information, depending on the operating system version, the software in use, or image file sizes.
 - Some functions provided by the included software may not be available, such as editing movies or returning images to the camera.

Using the PDF Manuals

Camera User Guide

- Access this guide by double-clicking the desktop shortcut icon.

Software Guide

- The guide can be accessed from the help system of included software (some software excluded).



- * It may not be possible to install the PDF manuals on computers that do not meet the system requirements (32). However, you can view the manuals on a computer that supports Adobe Reader by copying the PDF files in the Readme folder on the CD-ROM directly to a convenient location on the computer.

Accessories

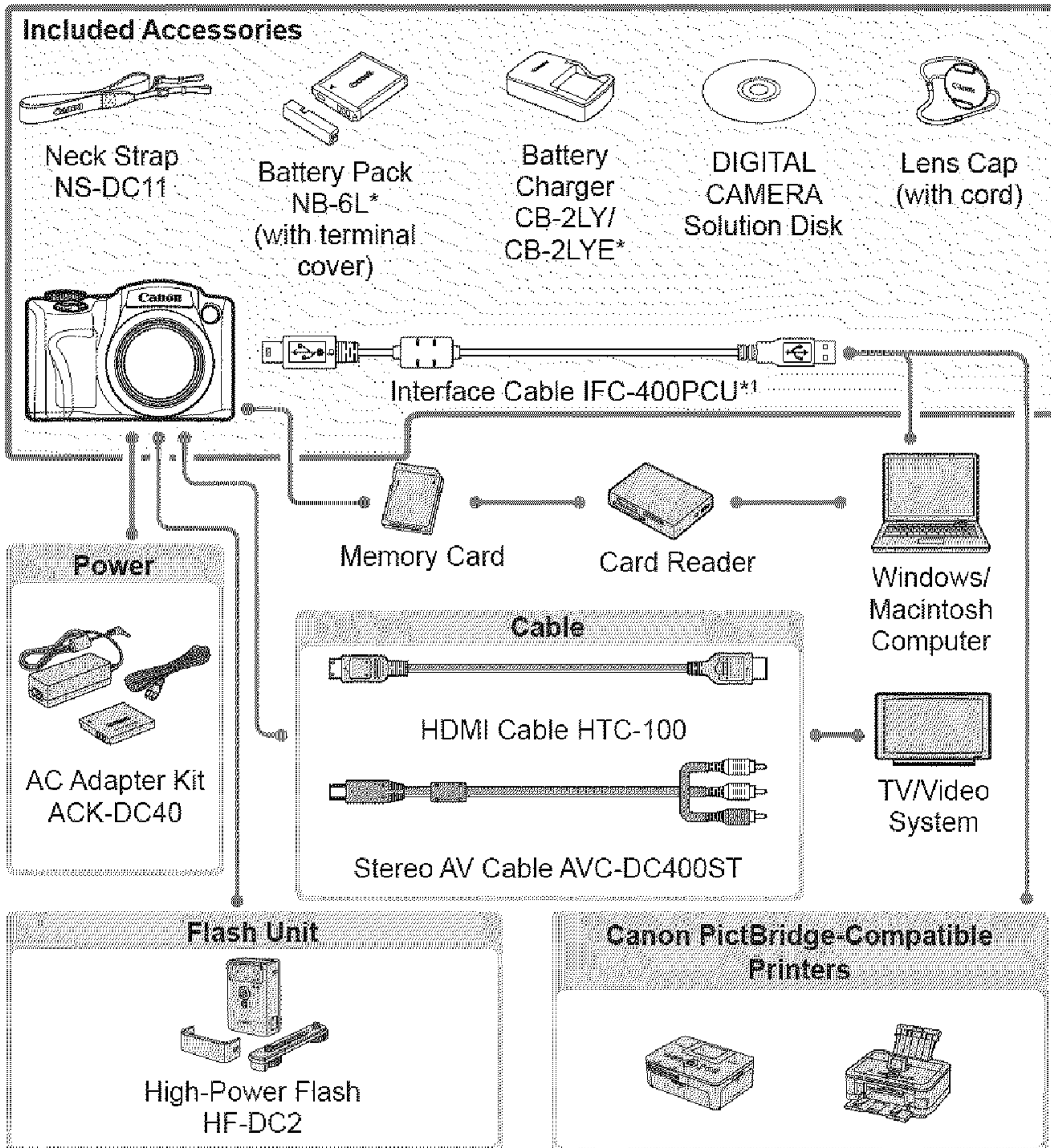

* Also available for purchase separately.

Use of genuine Canon accessories is recommended.

This product is designed to achieve excellent performance when used with genuine Canon accessories.

Canon shall not be liable for any damage to this product and/or accidents such as fire, etc., caused by the malfunction of non-genuine Canon accessories (e.g., a leakage and/or explosion of a battery pack). Please note that this warranty does not apply to repairs arising out of the malfunction of non-genuine Canon accessories, although you may request such repairs on a chargeable basis.

Advanced Guide

1

Camera Basics

Practical guide that introduces other camera basics and describes shooting and playback options

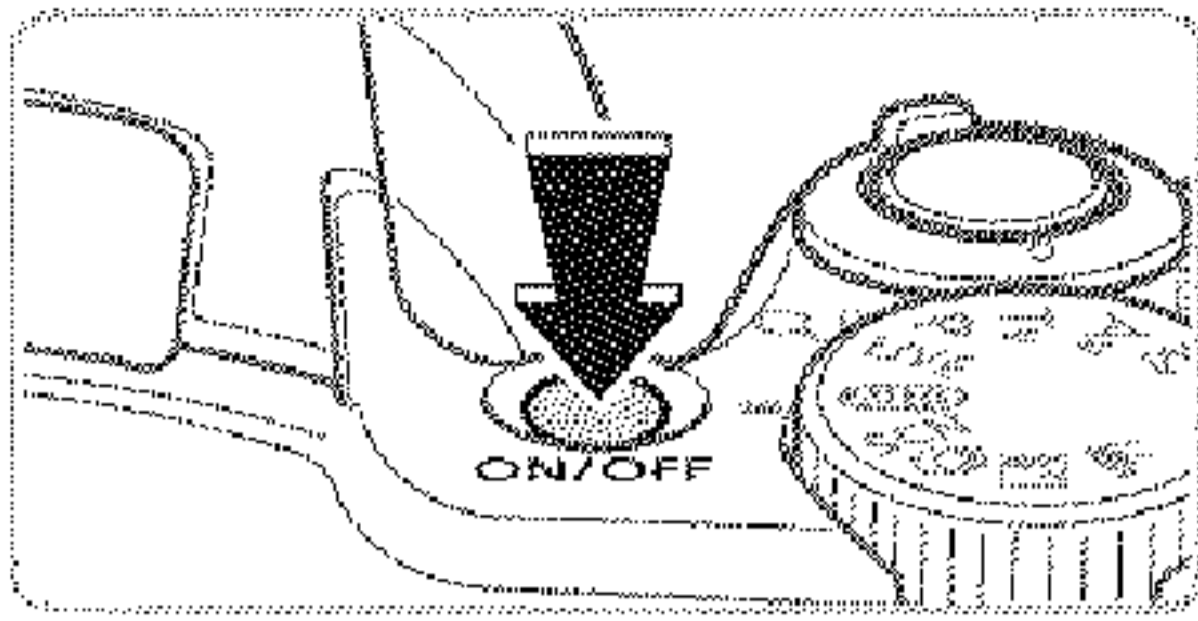

Shooting Mode

- Press the power button to turn the camera on and prepare for shooting.
- To turn the camera off, press the power button again.

Playback Mode

- Press the <▶> button to turn the camera on and view your shots.
- To turn the camera off, press the <▶> button again.

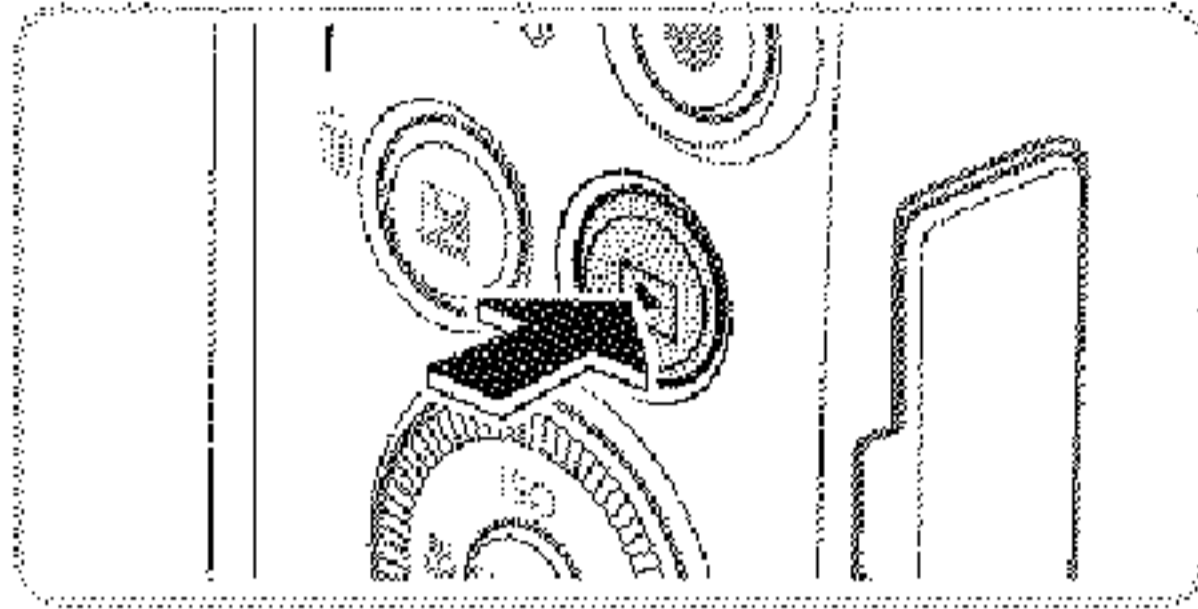

- * To switch to Playback mode from Shooting mode, press the <▶> button.
- * To switch to Shooting mode from Playback mode, press the shutter button halfway (📖43).
- * The lens will be retracted after about one minute once the camera is in Playback mode. You can turn the camera off when the lens is retracted by pressing the <▶> button.

Power-Saving Features (Auto Power Down)

As a way to conserve battery power, the camera automatically deactivates the screen (Display Off) and then turns itself off after a specific period of inactivity.

■ Power Saving in Shooting Mode

The screen is automatically deactivated after about one minute of inactivity. In about two more minutes, the lens is retracted and the camera turns itself off. To activate the screen and prepare for shooting when the screen is off but the lens is still out, press the shutter button halfway (📖43).

■ Power Saving in Playback Mode

The camera turns itself off automatically after about five minutes of inactivity.



- * Adjust the timing of automatic camera and screen deactivation as needed (📖163).
- * Power saving is not active while the camera is connected to a computer (📖36).

Shutter Button

To ensure your shots are in focus, always press the shutter button lightly (halfway) initially. Once the subject is in focus, press the button all the way down to shoot.

In this manual, shutter button operations are described as pressing the button *halfway* or *all the way down*.

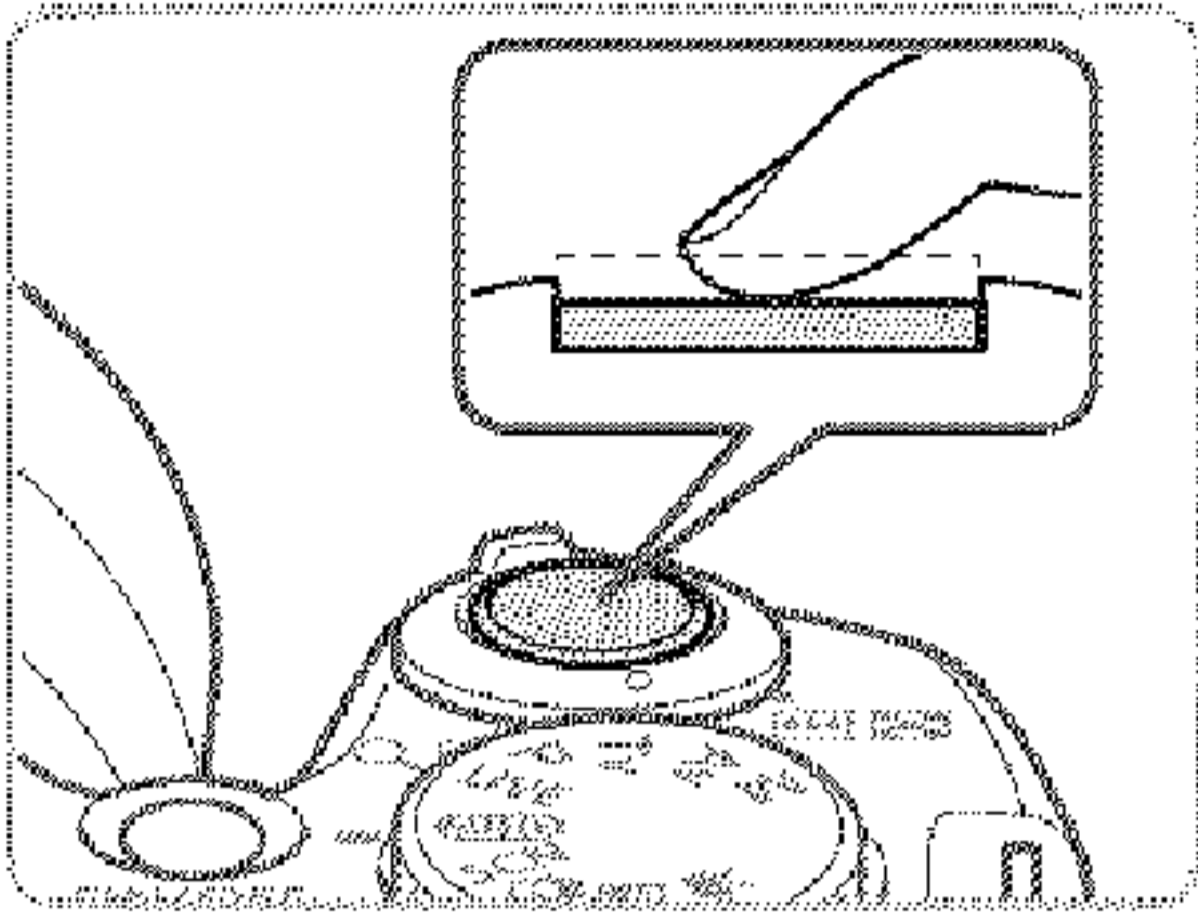

1 Press halfway. (Press lightly to focus.)

- Press the shutter button halfway. The camera beeps twice, and AF frames are displayed around image areas in focus.

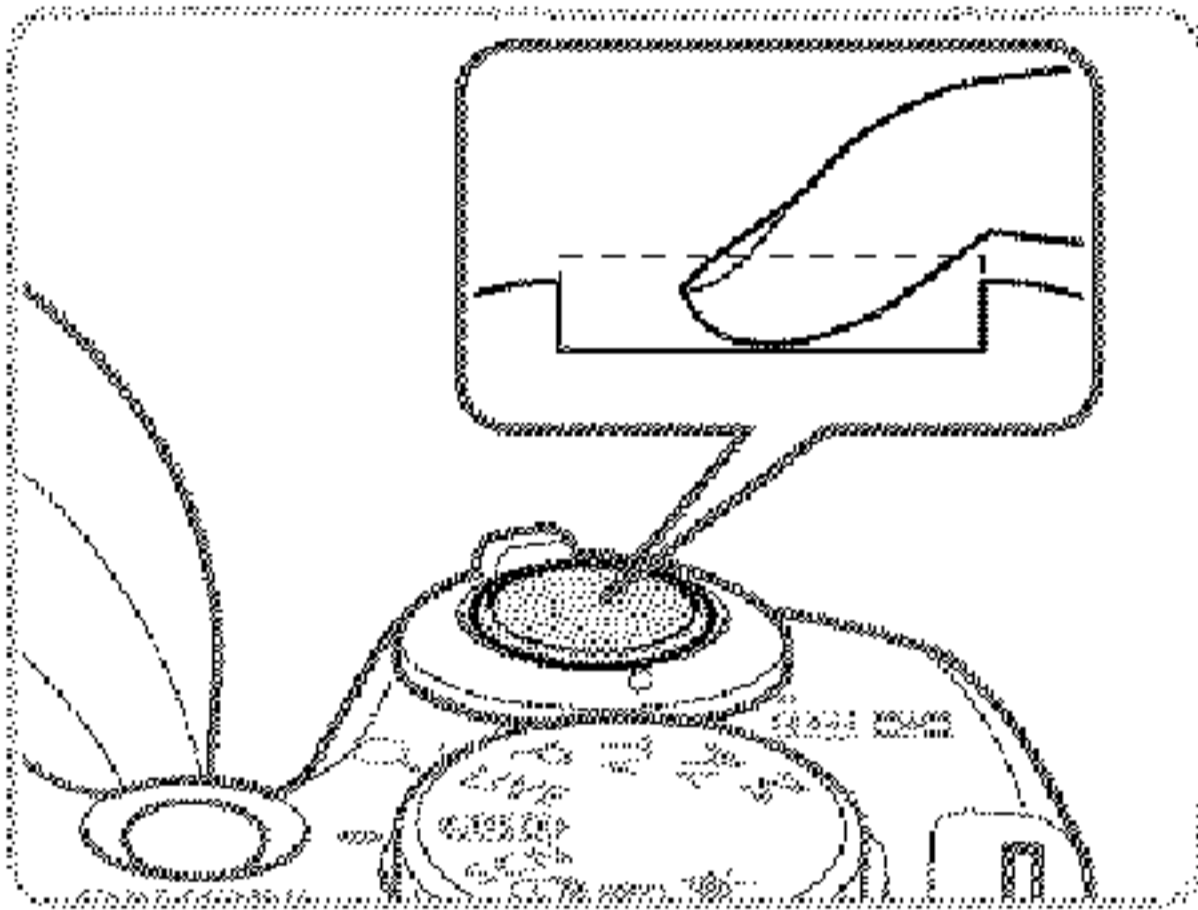

2 Press all the way down. (From the halfway position, press fully to shoot.)

- ▶ The camera shoots, as a shutter sound is played.
- Keep the camera still until the shutter sound ends.



- * Images may be out of focus if you shoot without initially pressing the shutter button halfway.
- * Length of shutter sound playback varies depending on the time required for the shot. It may take longer in some shooting scenes, and images will be blurry if you move the camera (or the subject moves) before the shutter sound ends.

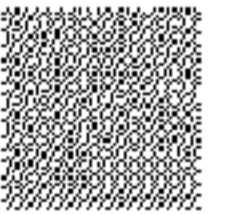

Shooting Modes

Use the mode dial to access each shooting mode.

P, Tv, Av, and M Modes

Take a variety of shots using your preferred settings (📖91, 115).

Live View Control Mode

Customize image brightness or colors when shooting (📖79).

Auto Mode

Fully automatic shooting, with camera-determined settings (📖26, 52).

Scene Mode

Shoot with optimal settings for specific scenes (📖80).

Movie Mode

For shooting movies (📖88).

You can also shoot movies when the mode dial is not set to Movie mode, simply by pressing the movie button.

Discreet Mode

Shoot without the flash or camera sounds (📖78).

Creative Filters Mode

Add a variety of effects to images when shooting (📖82).

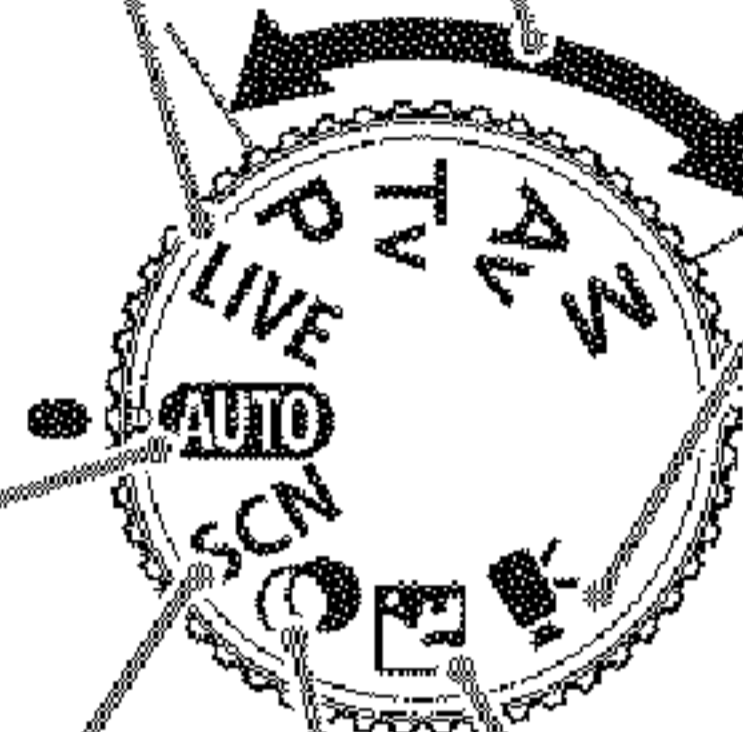

* You can turn the mode dial to switch to Shooting mode from Playback mode.

Shooting Display Options

Press the <DISP.> button to view other information on the screen, or to hide the information. For details on the information displayed, see  202.



Information is displayed

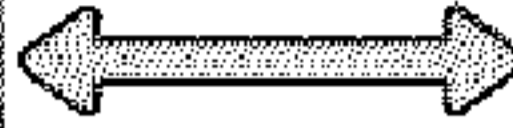

No information is displayed



- * Screen brightness is automatically increased by the night display function when you are shooting under low light, making it easier to check how shots are composed. However, on-screen image brightness may not match the brightness of your shots. Note that any on-screen image distortion or jerky subject motion will not affect recorded images.
- * For playback display options, see  124.

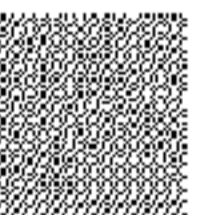

FUNC. Menu

Configure commonly used shooting functions through the FUNC. menu as follows.

Note that menu items and options vary depending on the shooting mode (208 – 209).

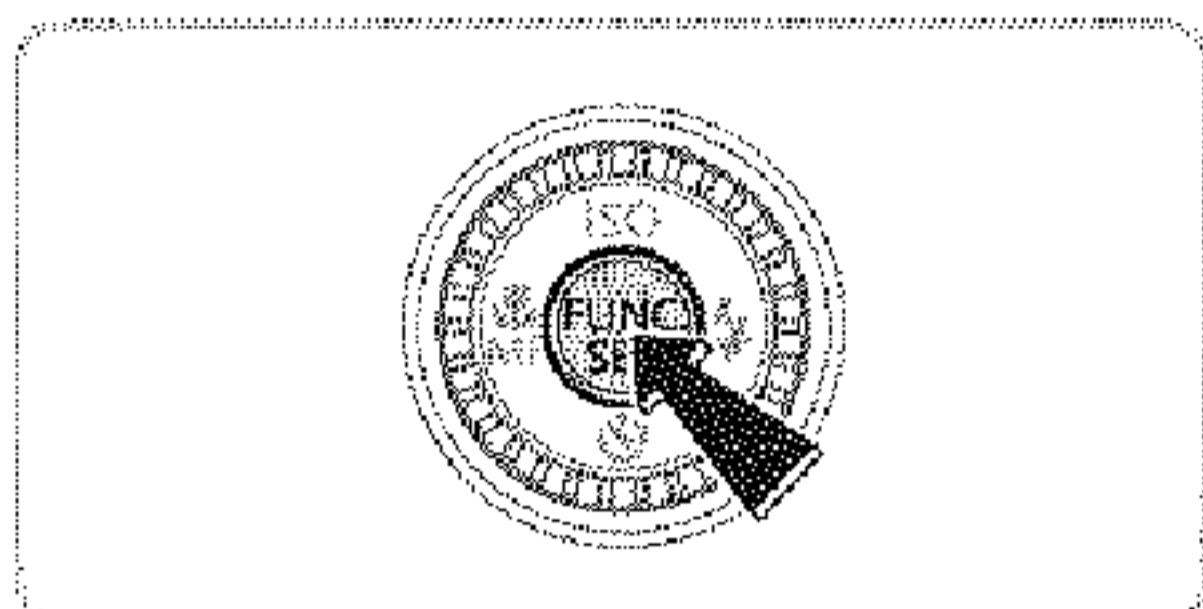

1 Access the FUNC. menu.

- Press the <FUNC. SET> button.

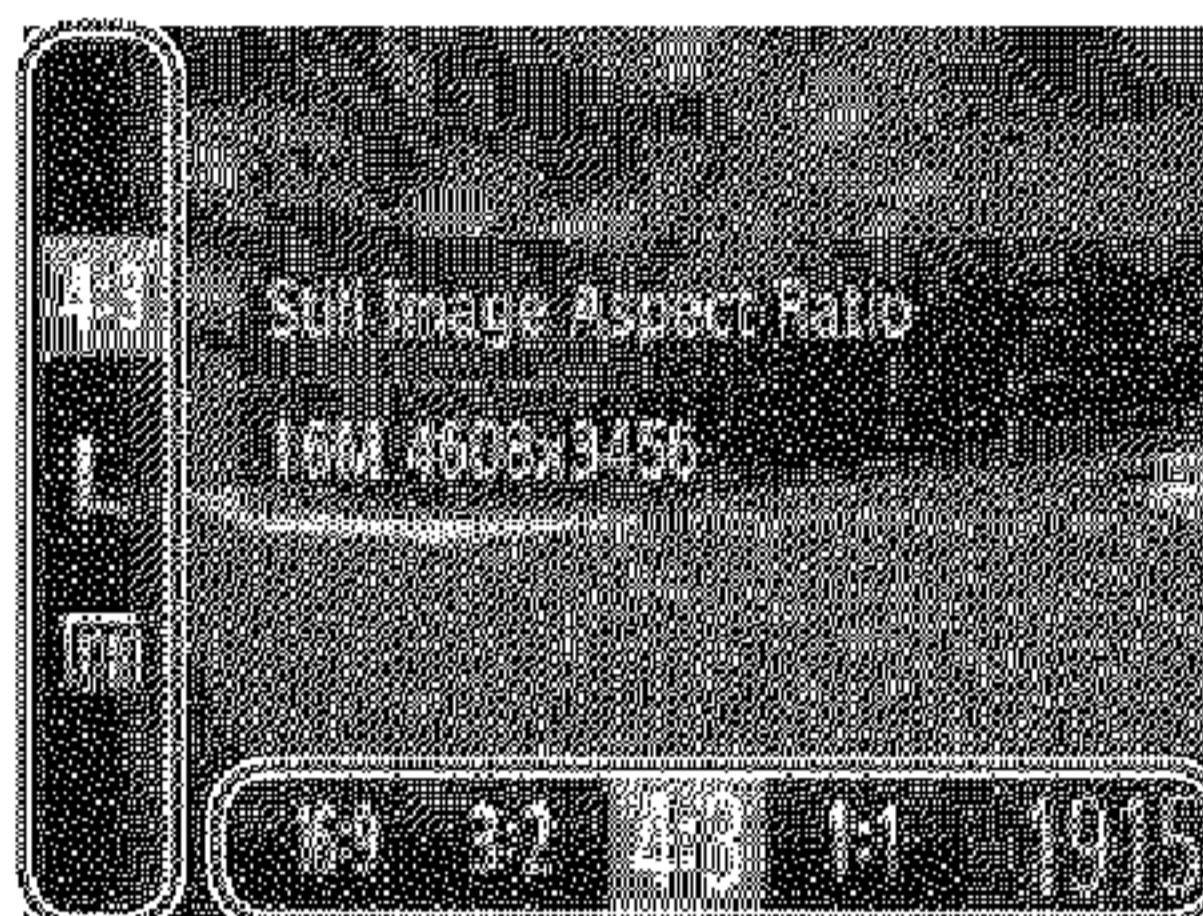

2 Choose a menu item.

- Press the <▲><▼> buttons to choose a menu item.
- ▶ Available options are shown at the bottom of the screen.

Menu Items

Options

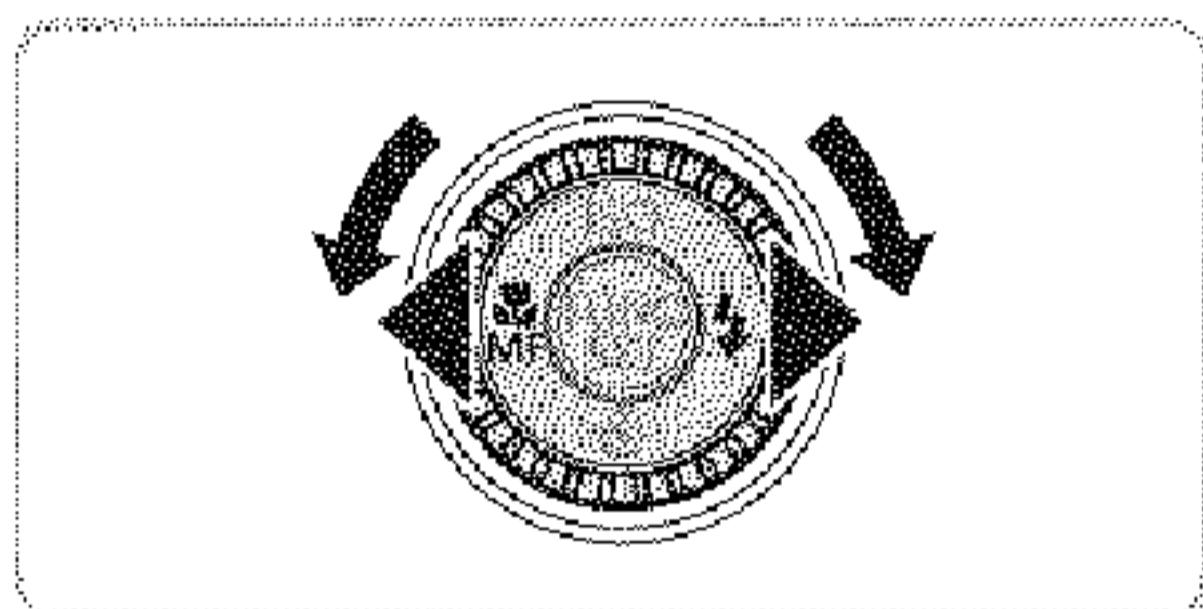

3 Choose an option.

- Press the <◀><▶> buttons or turn the <◉> dial to choose an option.
- Options labeled with a [DISP.] icon can be configured by pressing the <DISP.> button.
- To return to the menu items, press the <DISP.> button.

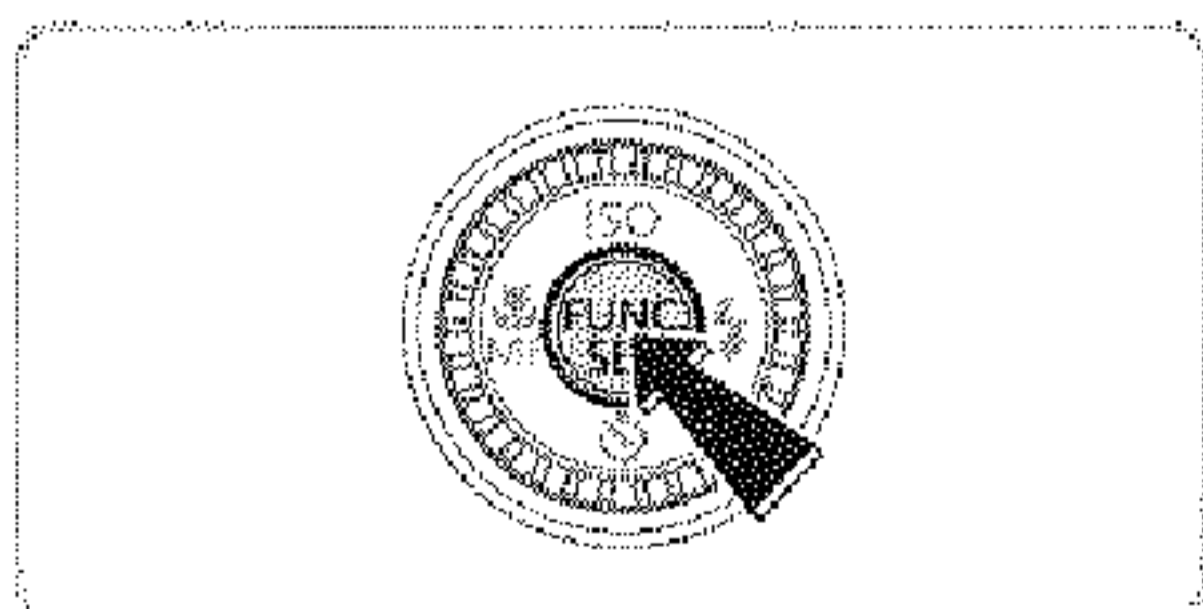

4 Finish the setup process.

- Press the <FUNC. SET> button.
- ▶ The screen before you pressed the <FUNC. SET> button in step 1 is displayed again, showing the option you configured.



* To undo any accidental setting changes, you can restore the camera's default settings (167).

MENU Menu

Configure a variety of camera functions through other menus as follows. Menu items are grouped by purpose on tabs, such as shooting [📷], playback [▶], and so on. Note that available settings vary depending on the selected shooting or playback mode (📖 210 – 215).

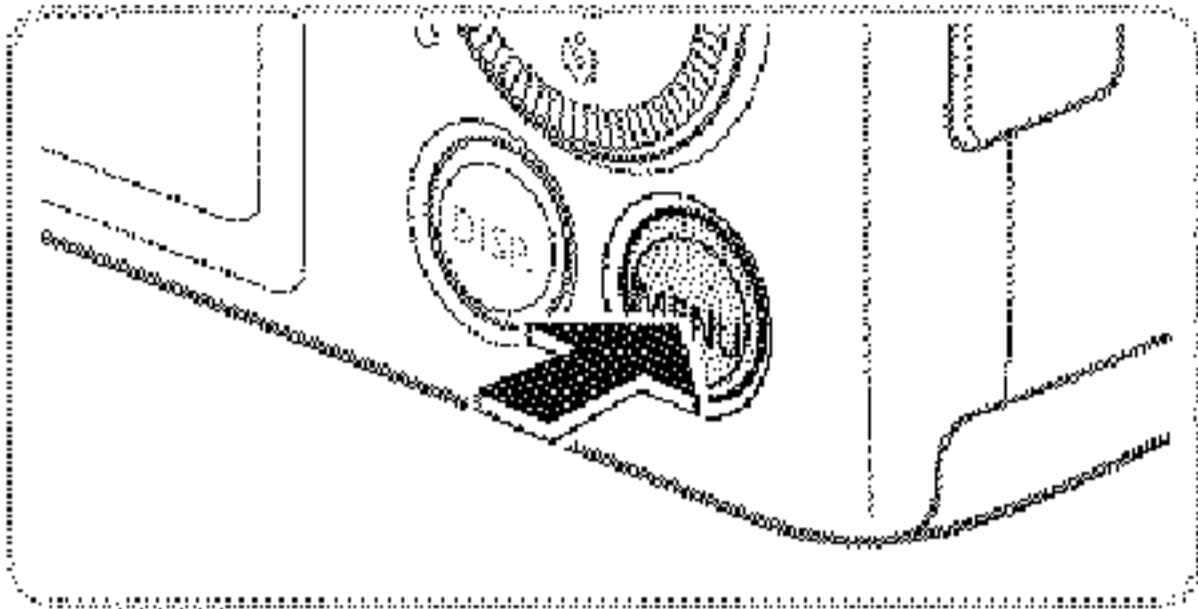

1 Access the menu.

- Press the <MENU> button.

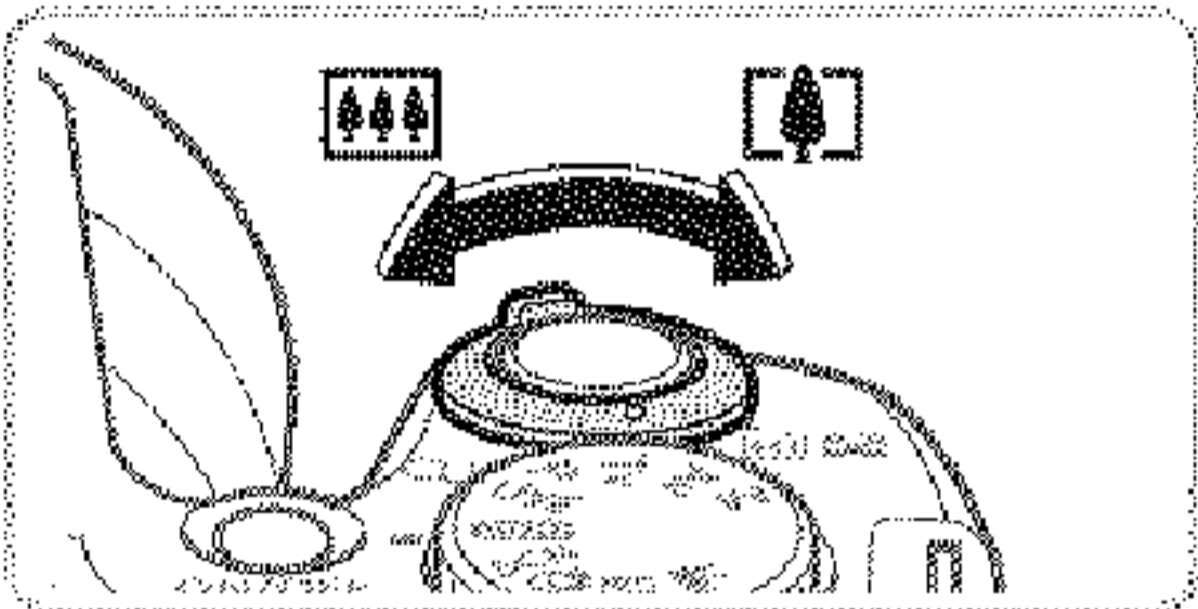

2 Choose a tab.

- Move the zoom lever to choose a tab.
- After you have pressed the <▲><▼> buttons to choose a tab initially, you can switch between tabs by pressing the <◀><▶> buttons.



3 Choose a setting.

- Press the <▲><▼> buttons or turn the <⦿> dial to choose a setting.
- To choose settings with options not shown, first press the <FUNC. SET> or <▶> button to switch screens, and then either press the <▲><▼> buttons or turn the <⦿> dial to select the setting.
- To return to the previous screen, press the <MENU> button.

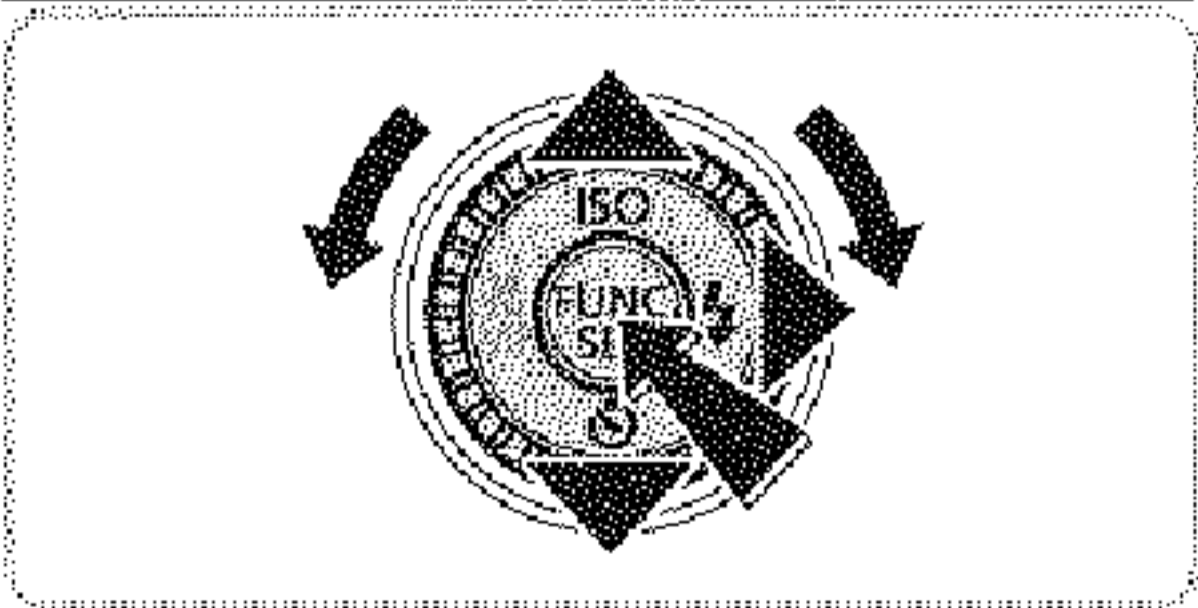
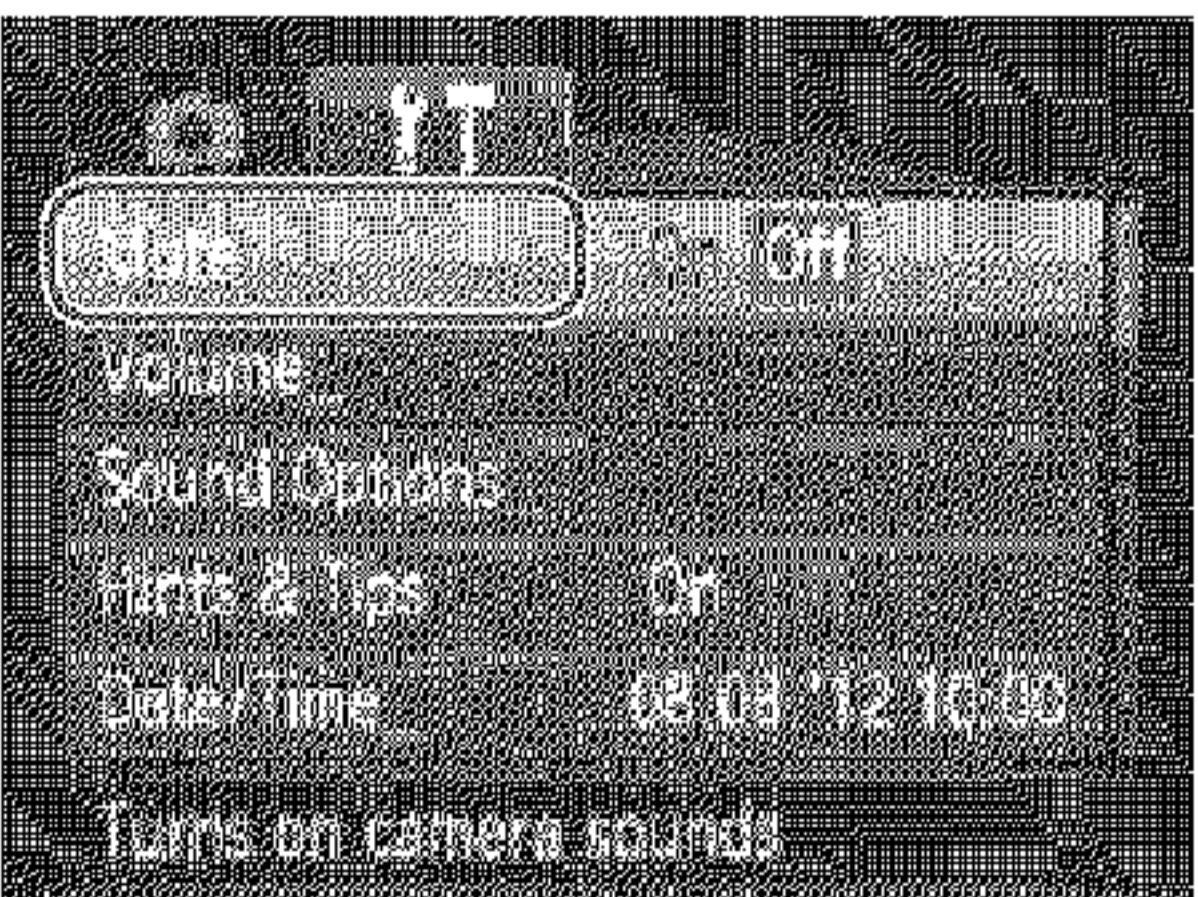

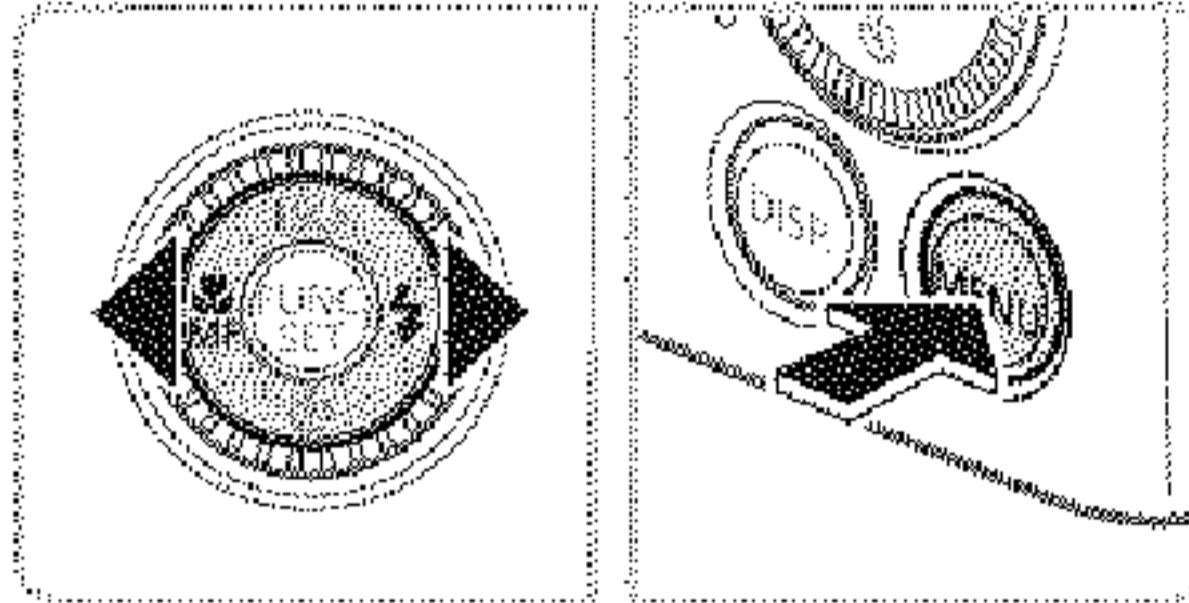

4 Choose an option.

- Press the <◀><▶> buttons to choose an option.

5 Finish the setup process.

- Press the <MENU> button to return to the screen displayed before you pressed the <MENU> button in step 1.



* To undo any accidental setting changes, you can restore the camera's default settings (167).

Indicator Display

The indicator on the back of the camera (📖7) lights up or blinks depending on the camera status.

Color	Indicator Status	Camera Status
Green	On	Connected to a computer (📖36), or display off (📖42, 163)
	Blinking	Starting up, recording/reading/transmitting images



- When the indicator blinks green, never turn the camera off, open the memory card/battery cover, or shake or jolt the camera, which may corrupt images or damage the camera or memory card.

Clock

You can check the current time.

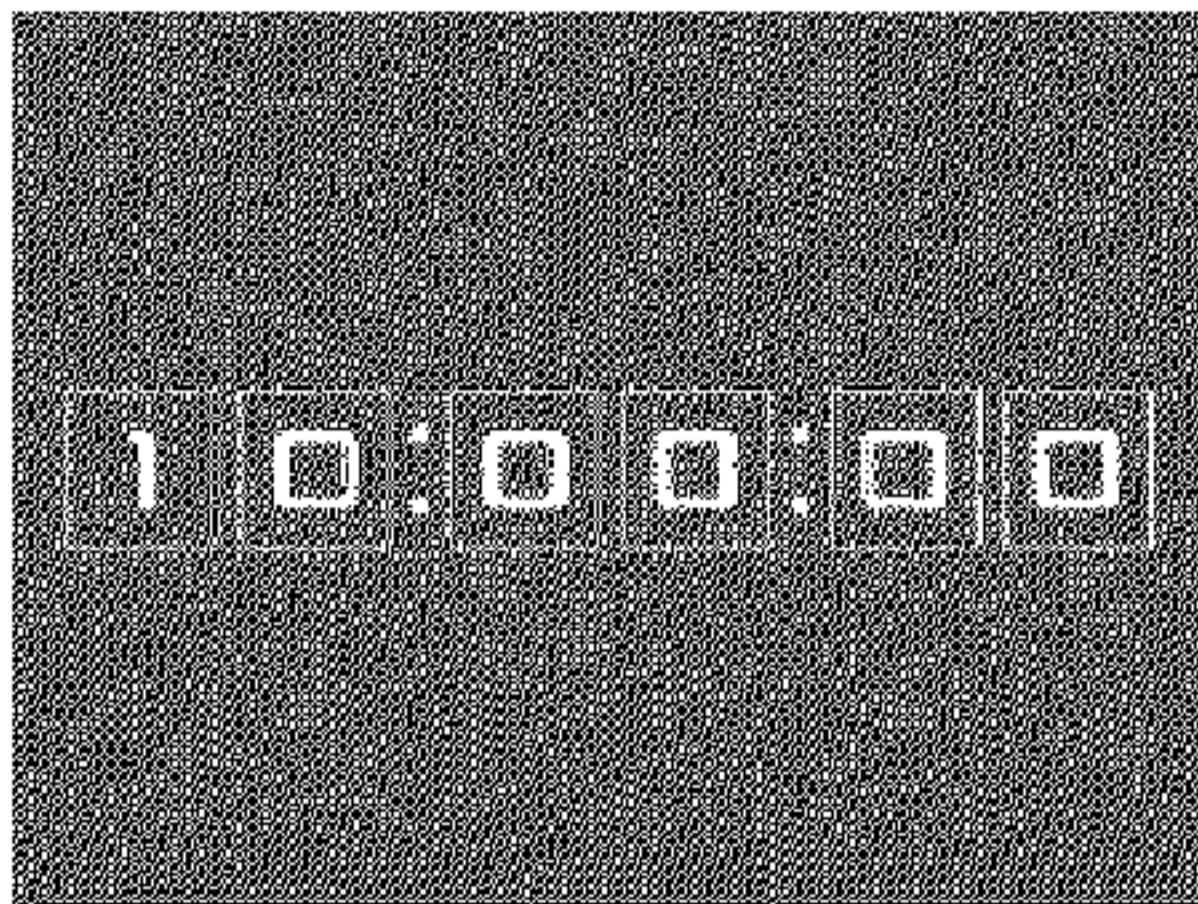

- Press and hold the <FUNC SET> button.
- The current time appears.
- If you hold the camera vertically while using the clock function, it will switch to vertical display. Press the <◀><▶> buttons or turn the <🌀> dial to change the display color.
- Press the <FUNC SET> button again to cancel the clock display.



- When the camera is off, press and hold the <FUNC SET> button, then press the power button to display the clock.

2

Smart Auto Mode

Convenient mode for easy shots with greater control over shooting

Shooting (Smart Auto)

For fully automatic selection at optimal settings for specific scenes, simply let the camera determine the subject and shooting conditions.

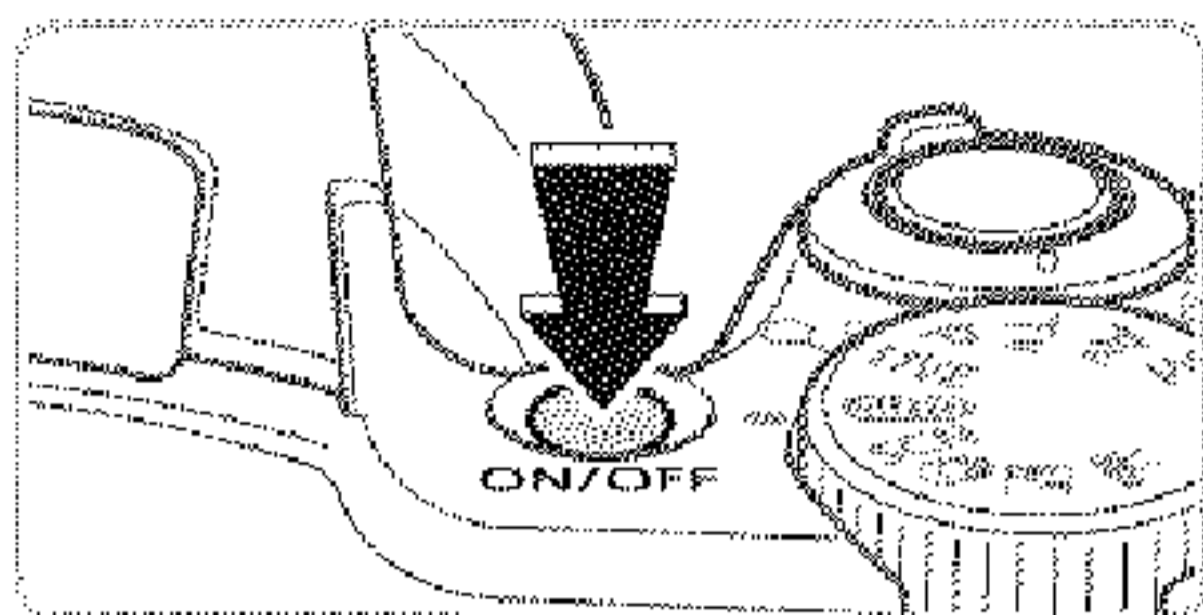

1 Turn the camera on.

- Press the power button.
- ▶ The startup screen is displayed.

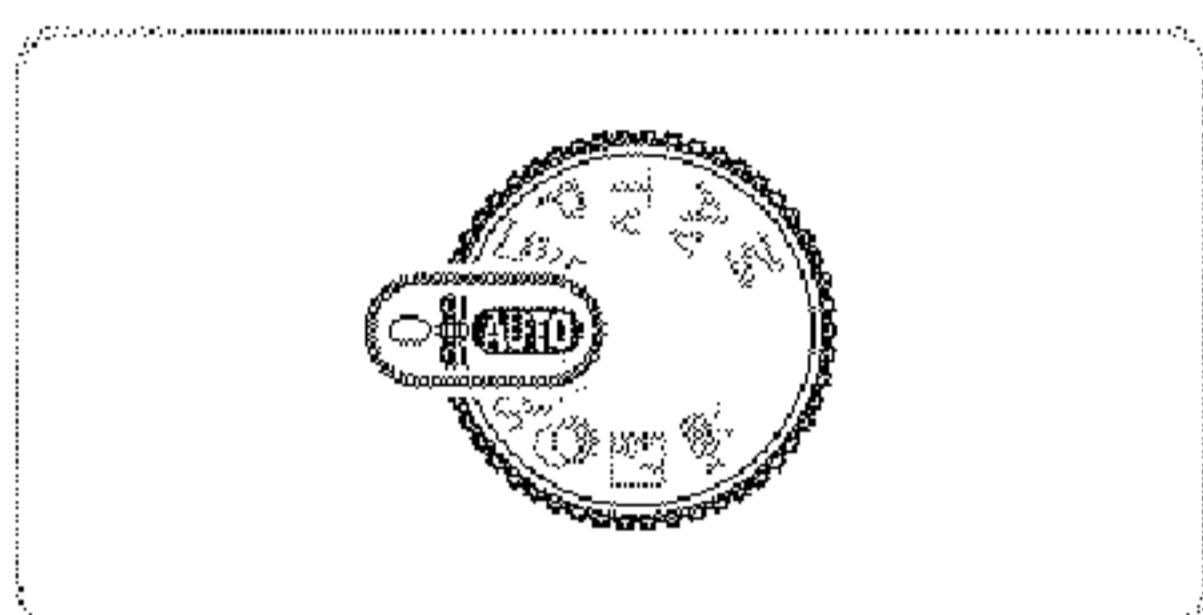

2 Enter <AUTO> mode.

- Set the mode dial to <AUTO>.
- Aim the camera at the subject. The camera will make a slight clicking noise as it determines the scene.
- ▶ Icons representing the scene and image stabilization mode are displayed in the upper right of the screen (57, 58).
- ▶ Frames displayed around any detected subjects indicate that they are in focus.

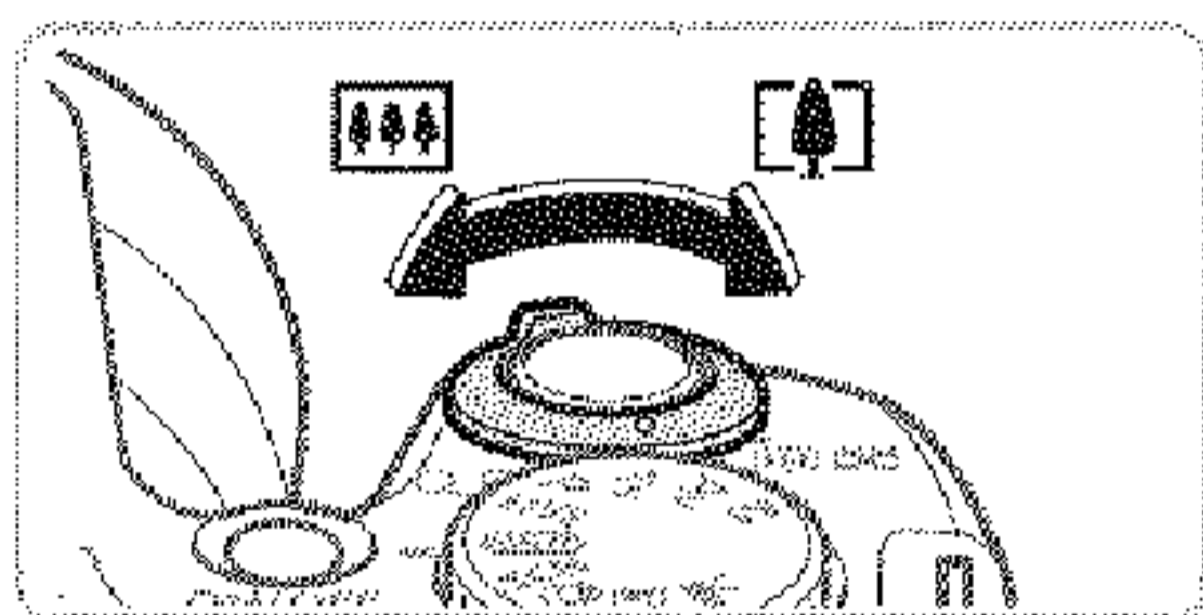

Zoom Bar

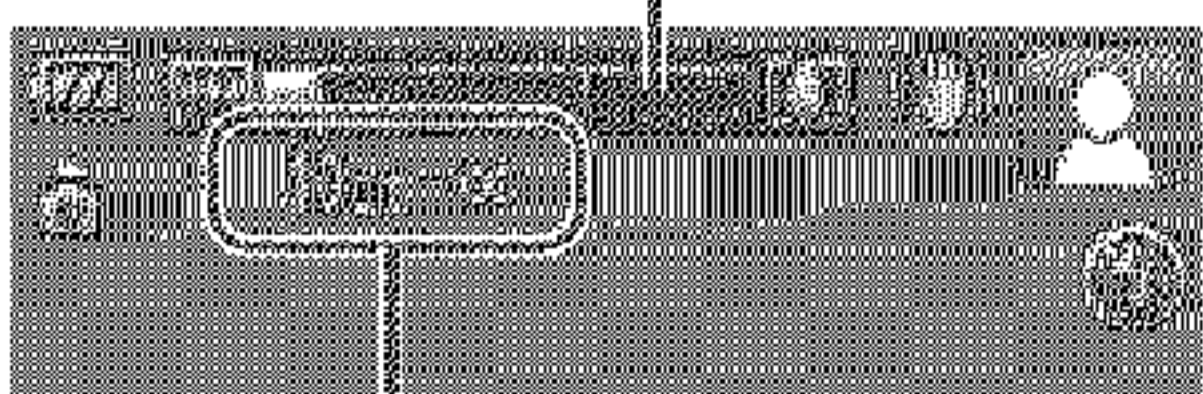

Focus Range (approx.)

3 Compose the shot.

- To zoom in and enlarge the subject, move the zoom lever toward <[🌲]> (telephoto), and to zoom away from the subject, move it toward <[🌳]> (wide angle). (A zoom bar showing the zoom position is displayed.)
- To zoom in or out quickly, move the zoom lever all the way toward <[🌲]> (telephoto) or <[🌳]> (wide angle), and to zoom in or out slowly, move it just a little in the desired direction.

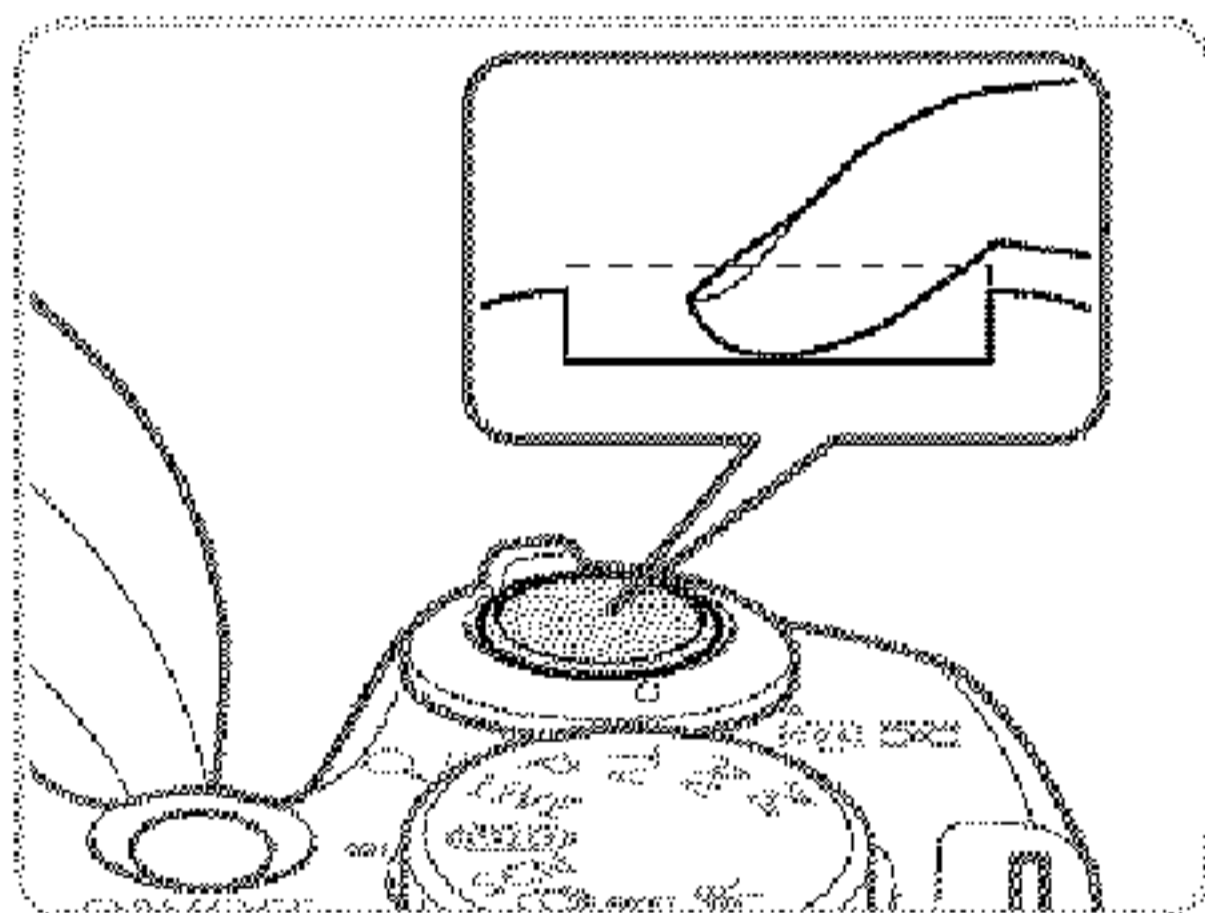
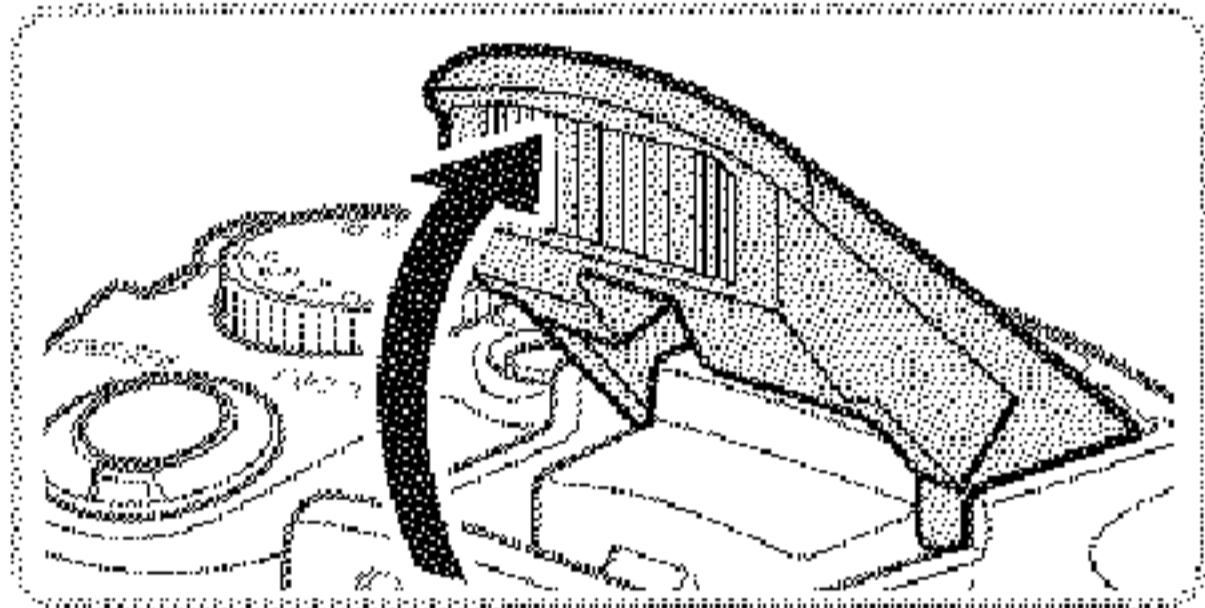
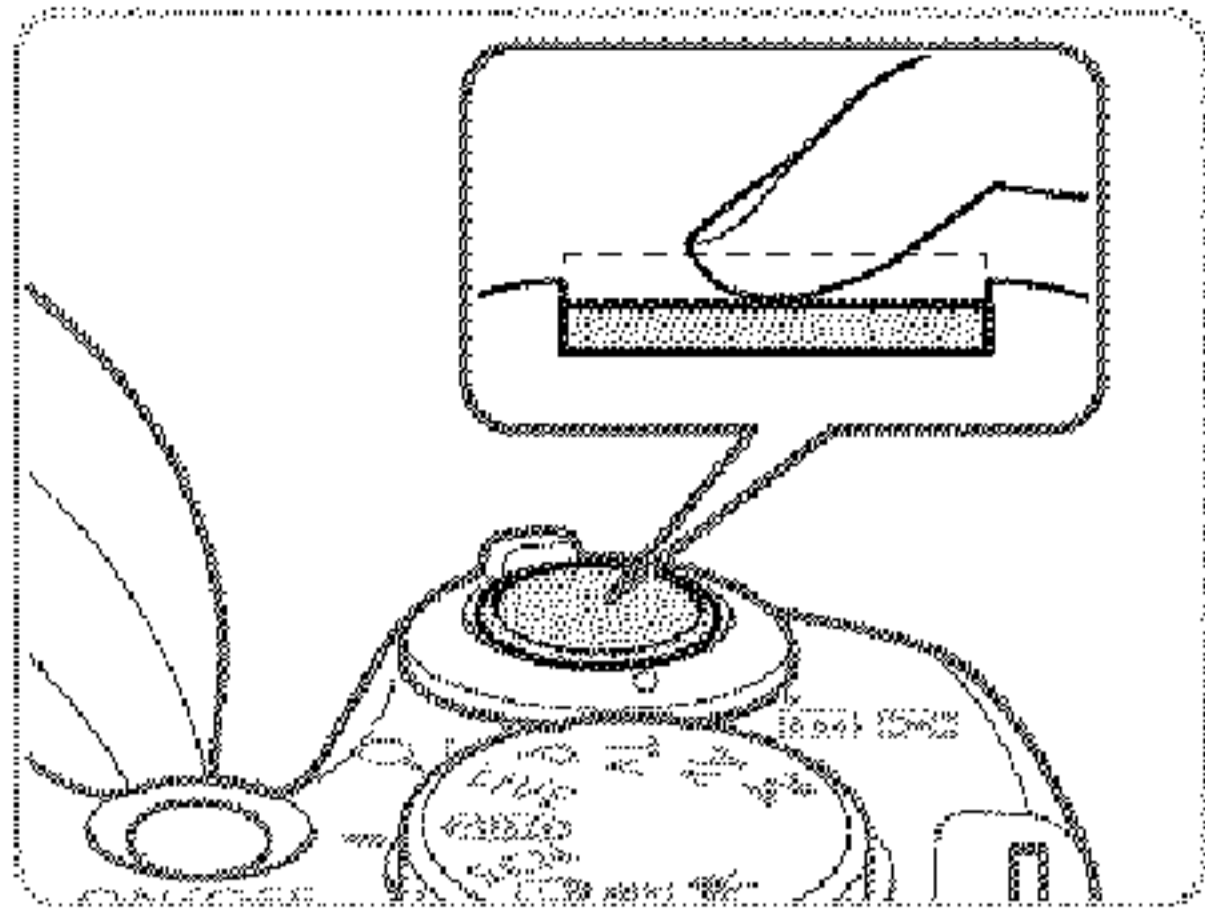

4 Shoot.

Shooting Still Images

① Focus.

- Press the shutter button halfway. The camera beeps twice after focusing, and green frames are displayed to indicate image areas in focus.
- ▶ Several green frames are displayed when multiple areas are in focus.
- If [Raise the flash] is displayed, lift the flash with your finger to prepare it for use. If you prefer not to use the flash, push it down with your finger, into the camera.

② Shoot.

- Press the shutter button all the way down.
- ▶ As the camera shoots, a shutter sound is played, and in low-light conditions when you have raised the flash, it fires automatically.
- Keep the camera still until the shutter sound ends.
- ▶ Your shot remains displayed on the screen for about two seconds.
- Even while the shot is displayed, you can take another shot by pressing the shutter button again.

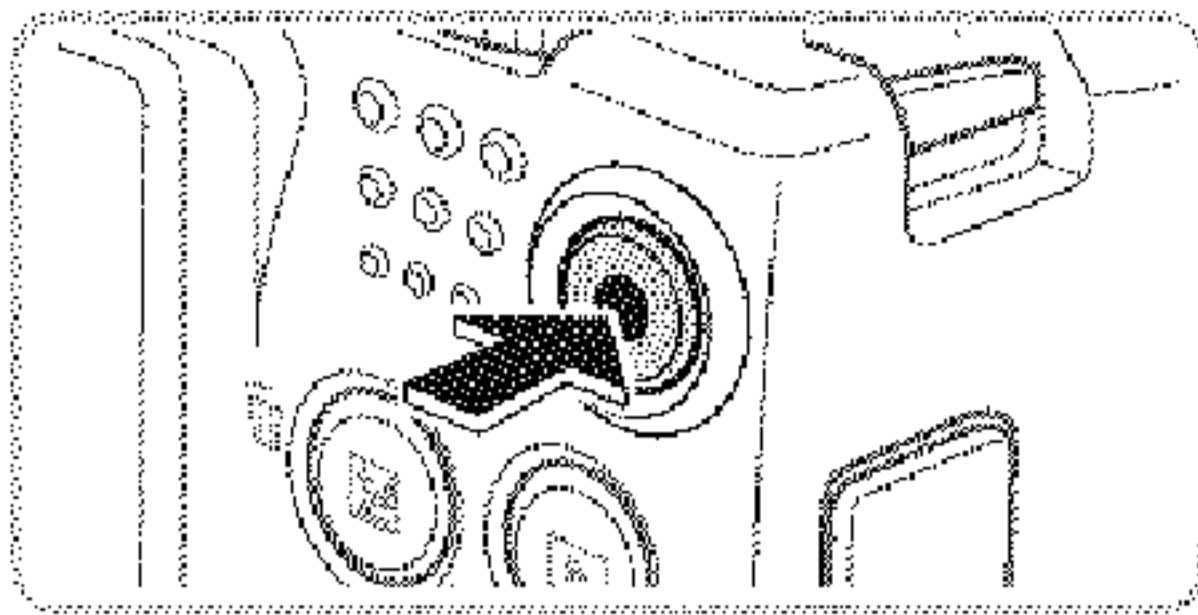

Elapsed Time

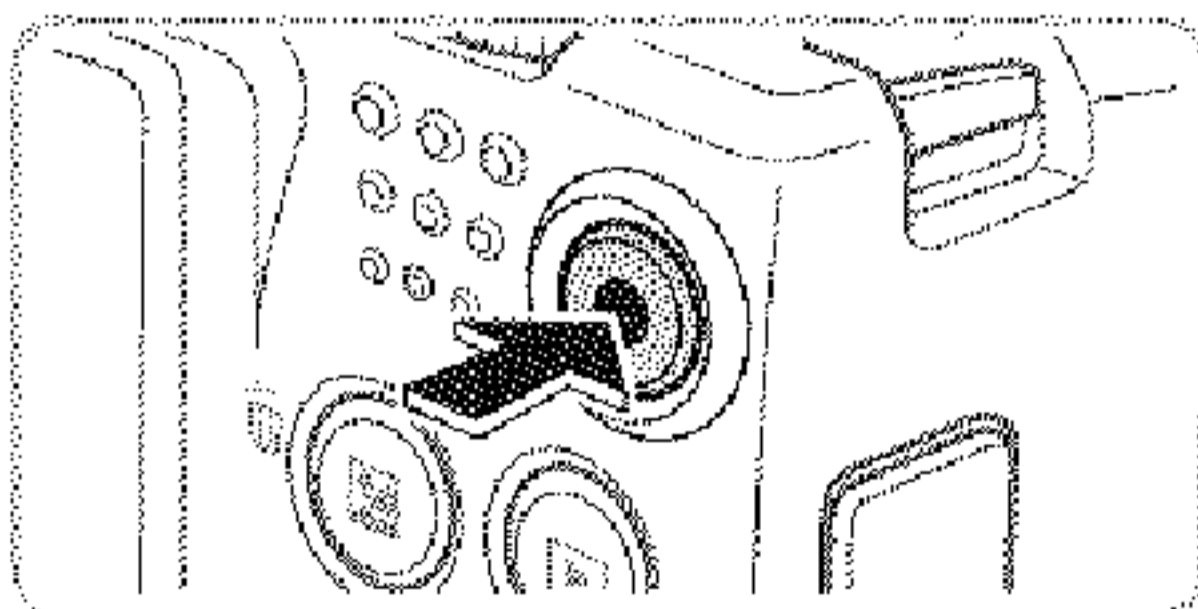
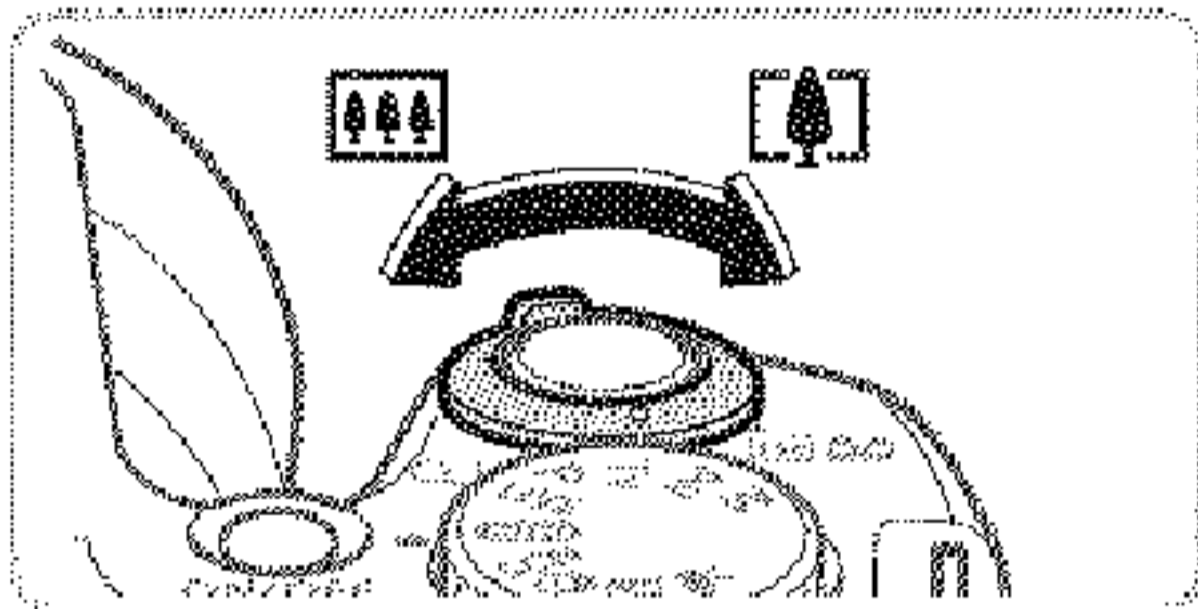
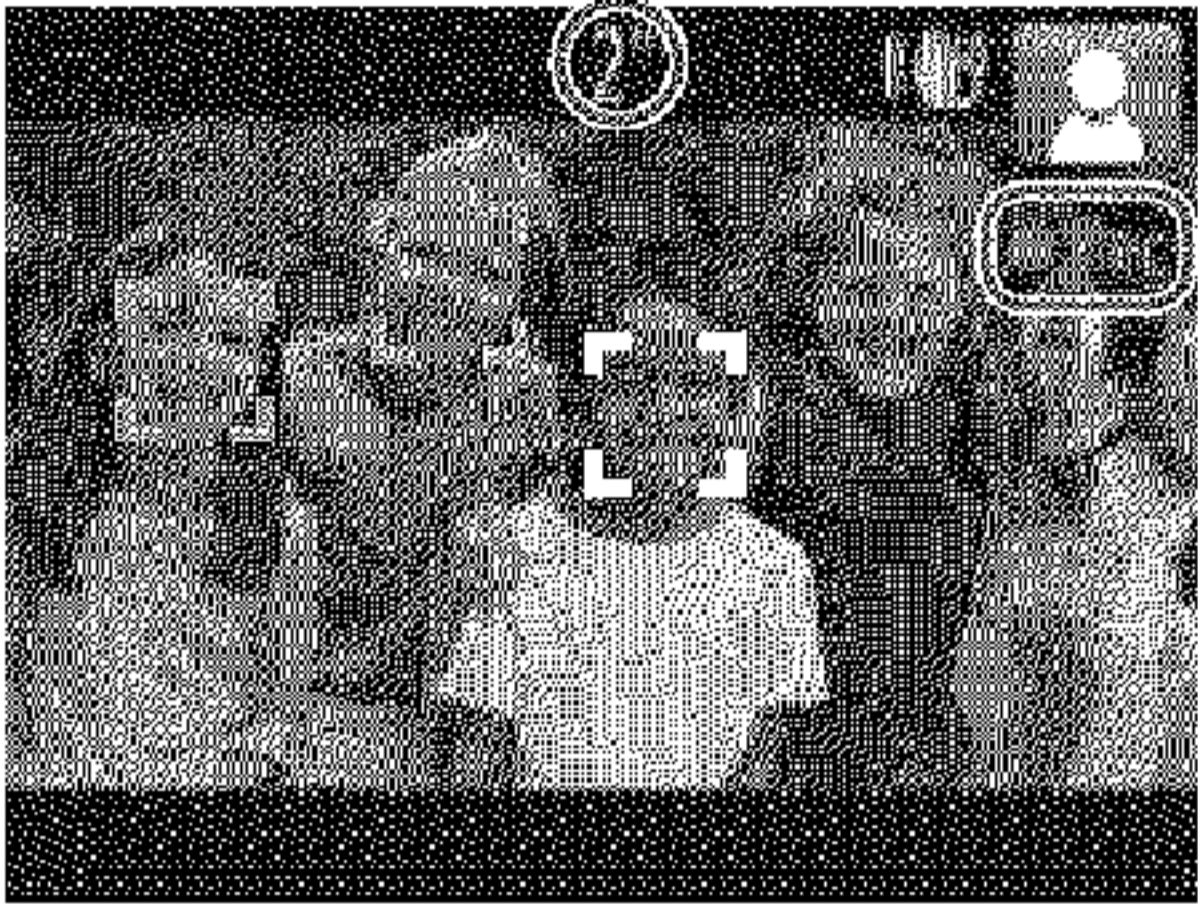

Shooting Movies

① Start shooting.

- Press the movie button. The camera beeps once as recording begins, and [●Rec] is displayed with the elapsed time.
- ▶ Black bars displayed on the top and bottom edges of the screen indicate image areas not recorded.
- ▶ Frames displayed around any detected faces indicate that they are in focus.
- Once recording begins, you can take your finger off the movie button.

② Resize the subject and recompose the shot as needed.

- To resize the subject, do the same thing as in step 3 on [52](#). However, note that the sound of camera operations will be recorded, and movies shot at zoom factors shown in blue will look grainy.
- When you recompose shots, the focus, brightness, and colors will be automatically adjusted.





③ Finish shooting.

- Press the movie button again to stop shooting. The camera beeps twice as recording stops.
- Recording will stop automatically when the memory card becomes full.

■ Still Images/Movies

- ❗ * To restore camera sound if you have accidentally deactivated it (by holding the <DISP.> button down while turning the camera on), press the <MENU> button and choose [Mute] on the [Y/T] tab, and then press the <◀><▶> buttons to choose [Off].

■ Still Images

- ❗ * A flashing [] icon warns that images are more likely to be blurred by camera shake. In this case, mount the camera on a tripod or take other measures to keep it still.
- * If your shots are dark despite the flash firing, move closer to the subject. For details on the flash range, see “Specifications” ( 217).
- * The subject may be too close if the camera only beeps once when you press the shutter button halfway. For details on the focusing range (shooting range), see “Specifications” ( 217).
- * To reduce red-eye and to assist in focusing, the lamp may be activated when shooting in low-light conditions.
- * A blinking [] icon displayed when you attempt to shoot indicates that shooting is not possible until the flash has finished recharging. Shooting can resume as soon as the flash is ready, so either press the shutter button all the way down and wait, or release it and press it again.

■ Movies

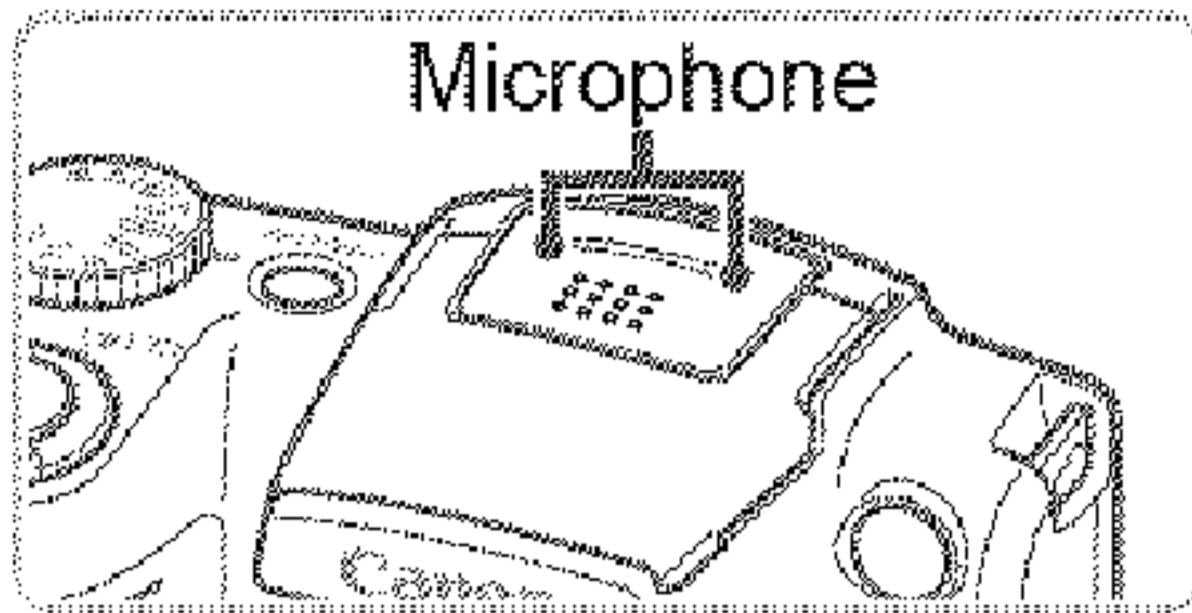

- Before shooting a movie, lower the flash with your finger. Be careful not to touch the microphone when shooting a movie. Leaving the flash raised, or blocking the microphone may prevent audio from being recorded or may cause the recording to sound muffled.
 - Avoid touching camera controls other than the movie button when shooting movies, because sounds made by the camera will be recorded.
-



- Audio is recorded in stereo.

Still Images

Movies

Scene Icons

In <AUTO> mode, shooting scenes determined by the camera are indicated by the icon displayed, and corresponding settings are automatically selected for optimal focusing, subject brightness, and color.

Subject	People			Other Subjects			Icon Background Color
		In Motion ^{*1}	Shadows on Face ^{*1}		In Motion ^{*1}	At Close Range	
Background							Gray
Bright							
Backlit			—				Light Blue
With Blue Sky							
Backlit			—				Orange
Sunsets	—	—	—		—	—	
Spotlights	—		—				Dark Blue
Dark	—						
Tripod Used	*2	—	—	*2	—	—	

*1 Not displayed for movies.







*2 Displayed in dark scenes when the camera is held still, as when mounted on a tripod.



Try shooting in <P> mode (91) if the scene icon does not match actual shooting conditions, or if it is not possible to shoot with your expected effect, color, or brightness.

Image Stabilization Icons

Optimal image stabilization for the shooting conditions is automatically applied (Intelligent IS). Additionally, the following icons are displayed in **<AUTO>** mode.

	Image stabilization for still images		Image stabilization for movies, reducing strong camera shake, as when shooting while walking (Dynamic IS)
	Image stabilization for still images, when panning*		Image stabilization for slow camera shake, such as when shooting movies at telephoto (Powered IS)
	Image stabilization for macro shots (Hybrid IS)		No image stabilization, because the camera is mounted on a tripod or held still by other means

* Displayed when you pan, following moving subjects with the camera. When you follow subjects moving horizontally, image stabilization only counteracts vertical camera shake, and horizontal stabilization stops. Similarly, when you follow subjects moving vertically, image stabilization only counteracts horizontal camera shake.



* To cancel image stabilization, set [IS Mode] to [Off] (114). In this case, an IS icon is not displayed.

On-Screen Frames

A variety of frames are displayed once the camera detects subjects you are aiming the camera at.

- * A white frame is displayed around the subject (or person's face) determined by the camera to be the main subject, and gray frames are displayed around other detected faces. Frames follow moving subjects within a certain range to keep them in focus. However, if the camera detects subject movement, only the white frame will remain on the screen.
- * When you are pressing the shutter button halfway and the camera detects subject movement, a blue frame is displayed, and the focus and image brightness are constantly adjusted (Servo AF).



- * Try shooting in <P> mode (📖91) if no frames are displayed, if frames are not displayed around desired subjects, or if frames are displayed on the background or similar areas.

Zooming In Closer on Subjects (Digital Zoom)

When distant subjects are too far away to enlarge using the optical zoom, use digital zoom for up to about 120x enlargement.

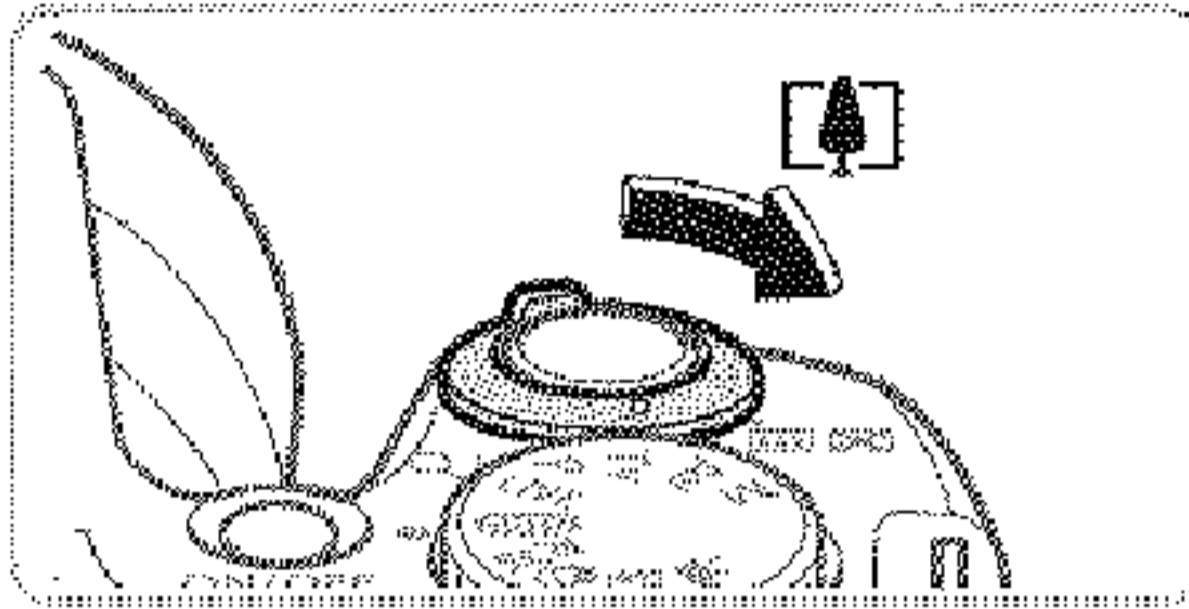

1 Move the zoom lever toward .

- Hold the lever until zooming stops.
- ▶ Zooming stops at the largest possible zoom factor (before the image becomes noticeably grainy), which is then indicated on the screen.

2 Move the zoom lever toward  **again.**

- ▶ The camera zooms in even closer on the subject, using digital zoom.

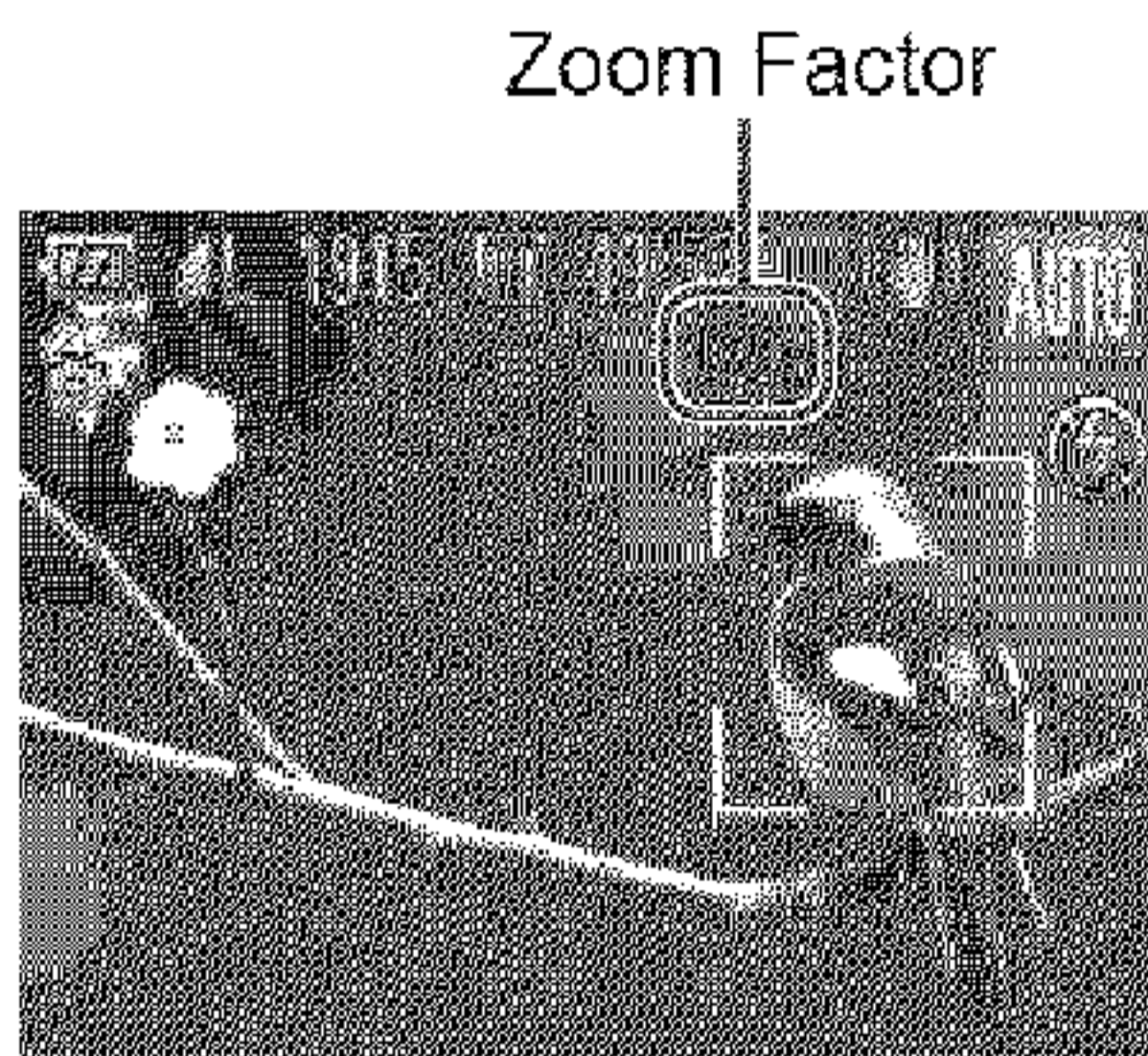

- Moving the zoom lever will display the zoom bar (which indicates the zoom position). The color of the zoom bar will change depending on the zoom range.
 - White range: optical zoom range where the image will not appear grainy.
 - Yellow range: digital zoom range where the image is not noticeably grainy (ZoomPlus).
 - Blue range: digital zoom range where the image will appear grainy.

Because the blue range will not be available at some resolution settings (📖68) the maximum zoom factor can be achieved by following step 1.

- Zoomed images may look grainy, under some resolution settings (📖68) and zoom factors. In this case, the zoom factor is shown in blue.



- * Focal length when optical and digital zoom are combined is as follows (35mm film equivalent).
24 – 2880 mm (24 – 720 mm with optical zoom alone)
- * To deactivate digital zoom, press the <MENU> button, choose [Digital Zoom] on the [CAMERA] tab, and then choose [Off].

Still Images

Movies

Reacquiring Subjects Lost After Zooming (Framing Assist – Seek)

If you lose track of a subject while zooming in, you can find it more easily by temporarily zooming out.

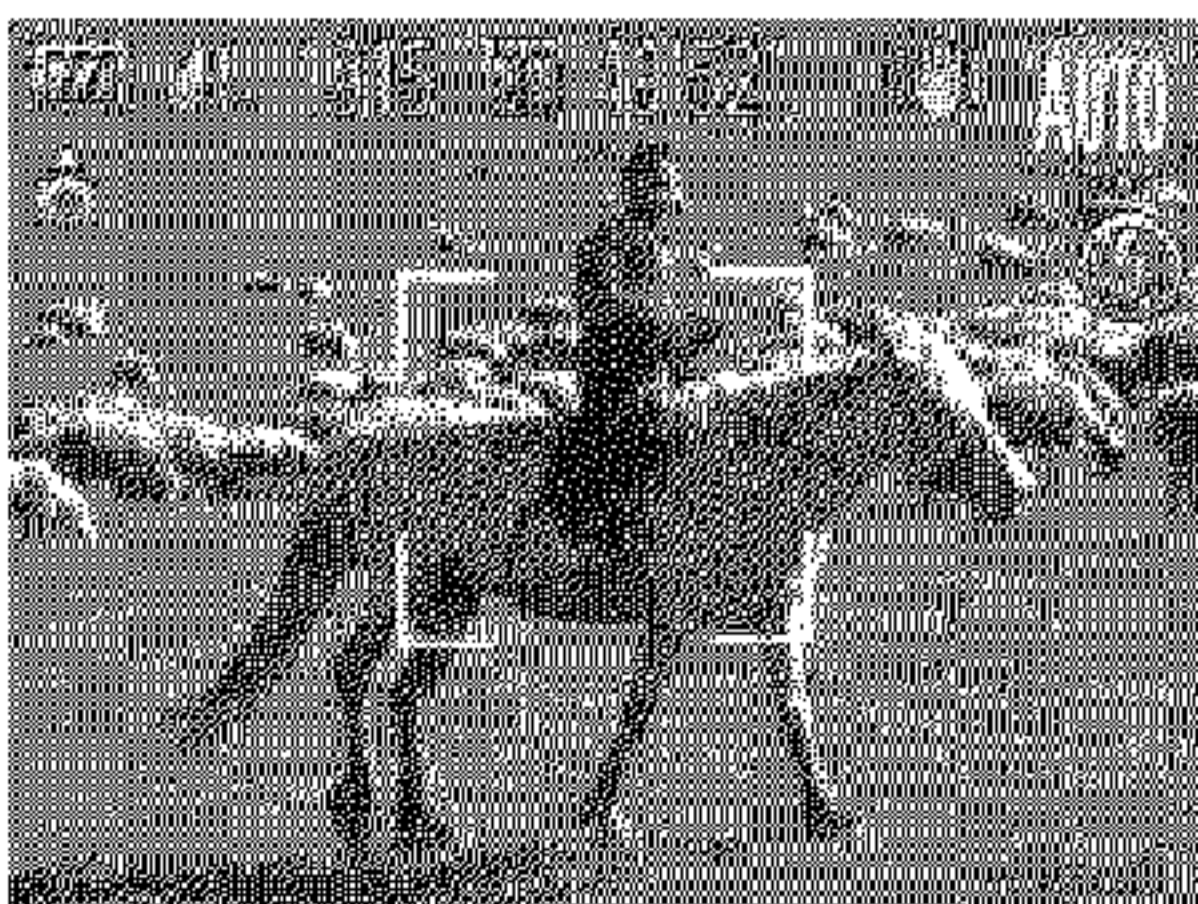
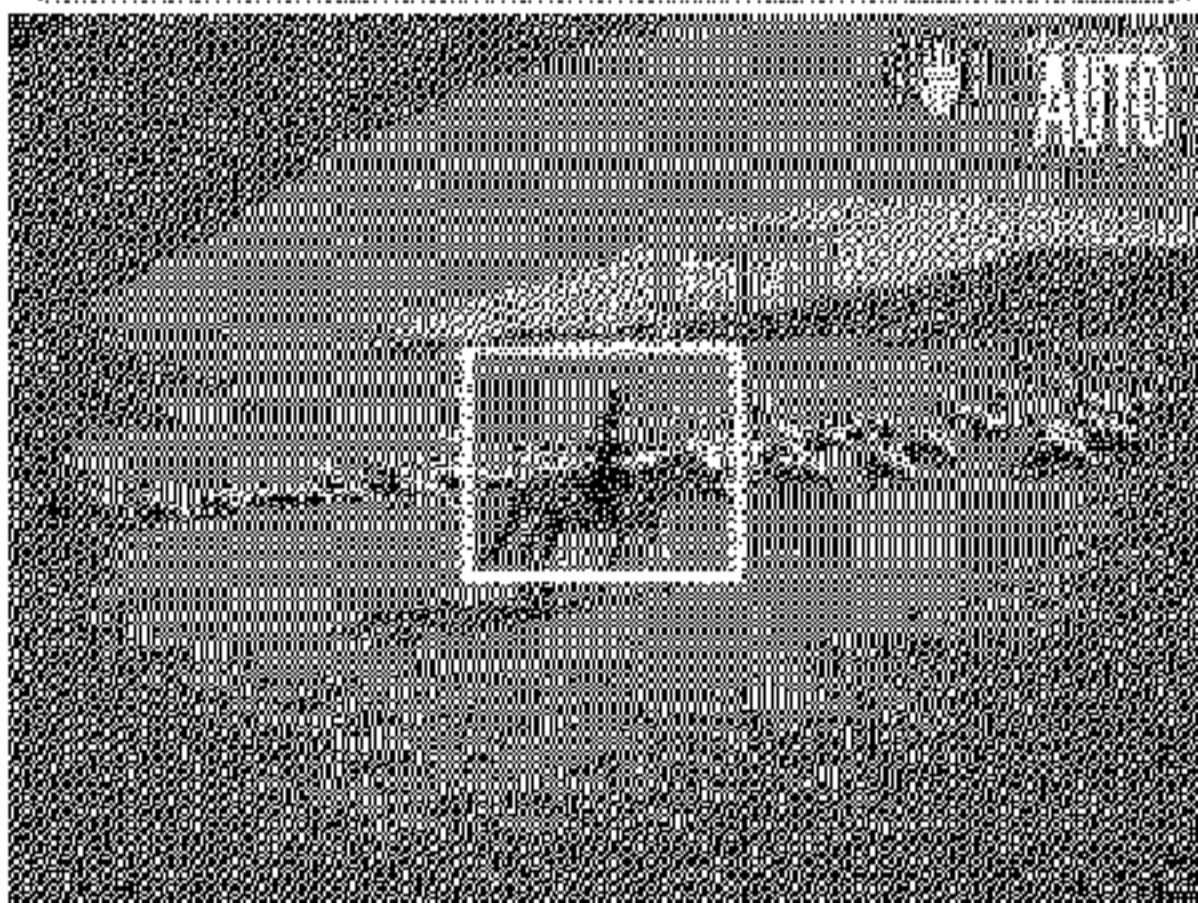
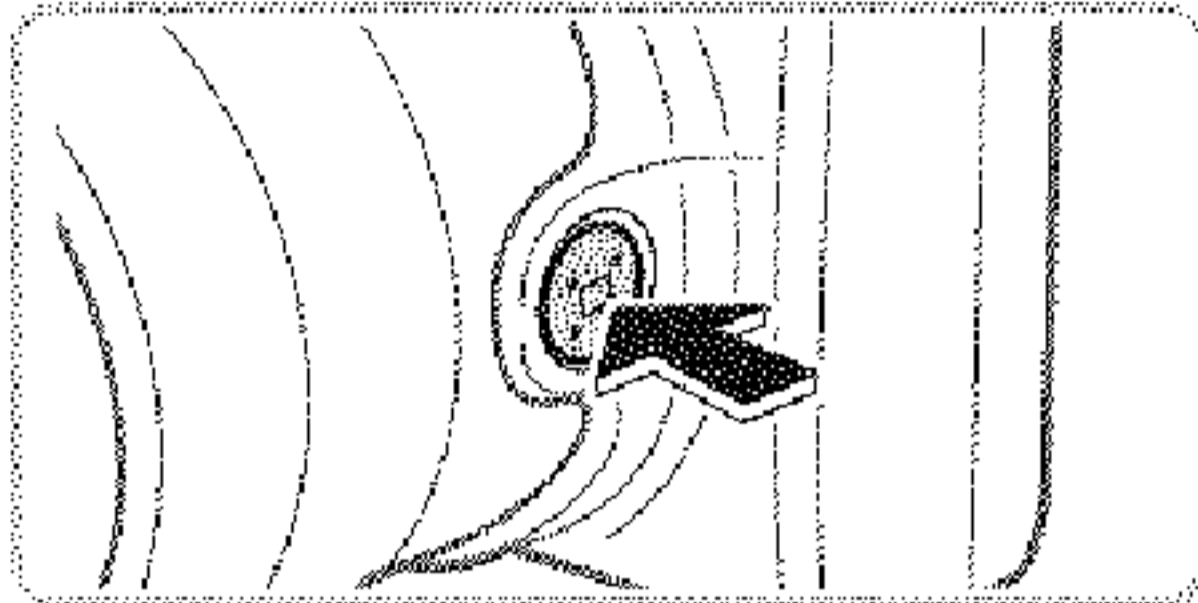

1 Look for the lost subject.

- Press and hold the <ZOOM OUT> button.





- ▶ The camera zooms out and displays a white frame around the area previously shown (before you pressed the <ZOOM OUT> button).

2 Reacquire the subject.

- Aim the camera so that the subject in the white frame, and then release the <ZOOM OUT> button.
- ▶ The previous magnification is now restored, so that the area outlined in white fills the screen again.

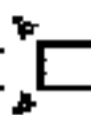
- ❗ Some shooting information is not displayed while the camera is zoomed out.
- During movie shooting, the white frame is not displayed if you press the  button. Also note that camera operating sounds such as zooming will be recorded.

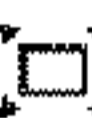
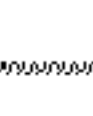

- If you prefer to shoot at the zoom factor of the screen in step 1, press the shutter button all the way down.
- You can adjust the zoom factor that the camera will revert to after Zoom Framing Assist (when you release the  button) by moving the zoom lever as you hold the  button to resize the white frame.
- To adjust how much the camera zooms out when the  button is pressed, press the <MENU> button and choose one of the three levels in [ Display Area] on the [] tab.
- The zoom factor cannot be changed with the  button after you press the shutter button all the way down in self-timer mode (see below).

Still Images





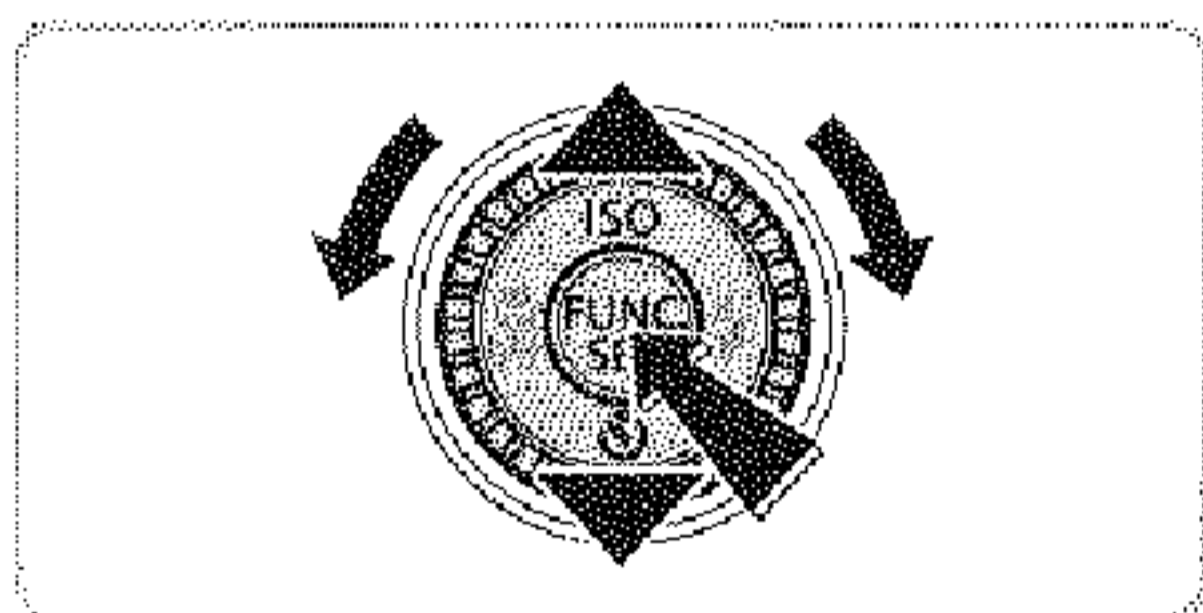

Movies

Using the Self-Timer

With the self-timer, you can include yourself in group photos or other timed shots. The camera will shoot about 10 seconds after you press the shutter button.



1 Configure the setting.

- Press the  button, choose [] (either press the  <  buttons or turn the  dial), and then press the  button.
- ▶ Once the setting is complete, [] is displayed.

2 Shoot.

- For Still Images: Press the shutter button halfway to focus on the subject, and then press it all the way down.
- For Movies: Press the movie button.
- ▶ Once you start the self-timer, the lamp will blink and the camera will play a self-timer sound.
- ▶ Two seconds before the shot, the blinking and sound will speed up. (The lamp will remain lit in case the flash fires.)
- To cancel shooting after you have triggered the self-timer, press the <MENU> button.
- To restore the original setting, choose [OFF] in step 1.

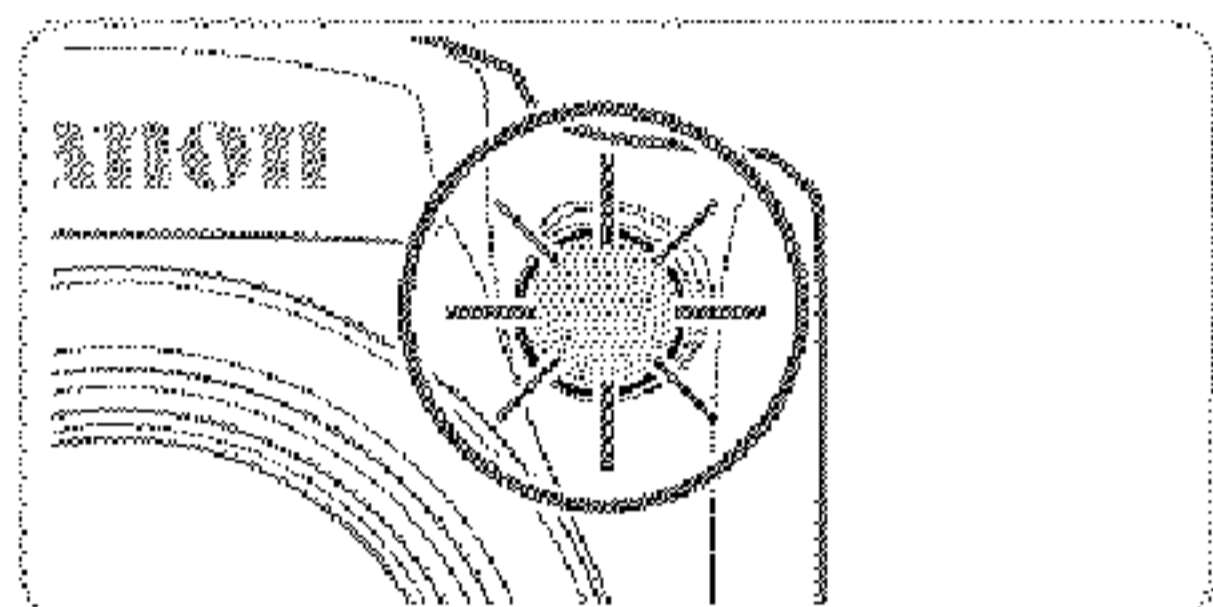

Still Images

Movies

■ Using the Self-Timer to Avoid Camera Shake

This option delays shutter release until about two seconds after you have pressed the shutter button. If the camera is unsteady while you are pressing the shutter button, it will not affect your shot.



Configure the setting.

- Follow step 1 on [62](#) and choose [ON].
- ▶ Once the setting is complete, [ON] is displayed.
- Follow step 2 on [63](#) to shoot.

■ Customizing the Self-Timer

You can specify the delay (0 – 30 seconds) and number of shots (1 – 10).

1 Choose [Ⓢ].

- Following step 1 on  62, choose [Ⓢ] and press the <MENU> button immediately.



2 Configure the setting.

- Press the <▲><▼> buttons to choose [Delay] or [Shots].
- Press the <◀><▶> buttons or turn the <⦿> dial to choose a value, and then press the <FUNC. SET> button.
- ▶ Once the setting is complete, [Ⓢ] is displayed.
- Follow step 2 on  63 to shoot.



- * For movies shot using the self-timer, [Delay] represents the delay before recording begins, but the [Shots] setting has no effect.



- * When you specify multiple shots, image brightness and white balance are determined by the first shot. More time is required between shots when the flash fires or when you have specified to take many shots. Shooting will stop automatically when the memory card becomes full.
- * When a delay longer than two seconds is specified, two seconds before the shot, the lamp blinking and self-timer sound will speed up. (The lamp will remain lit in case the flash fires.)

Adding a Date Stamp

The camera can add the shooting date to images, in the lower-right corner. However, note that date stamps cannot be edited or removed, so confirm beforehand that the date and time are correct (📖22).

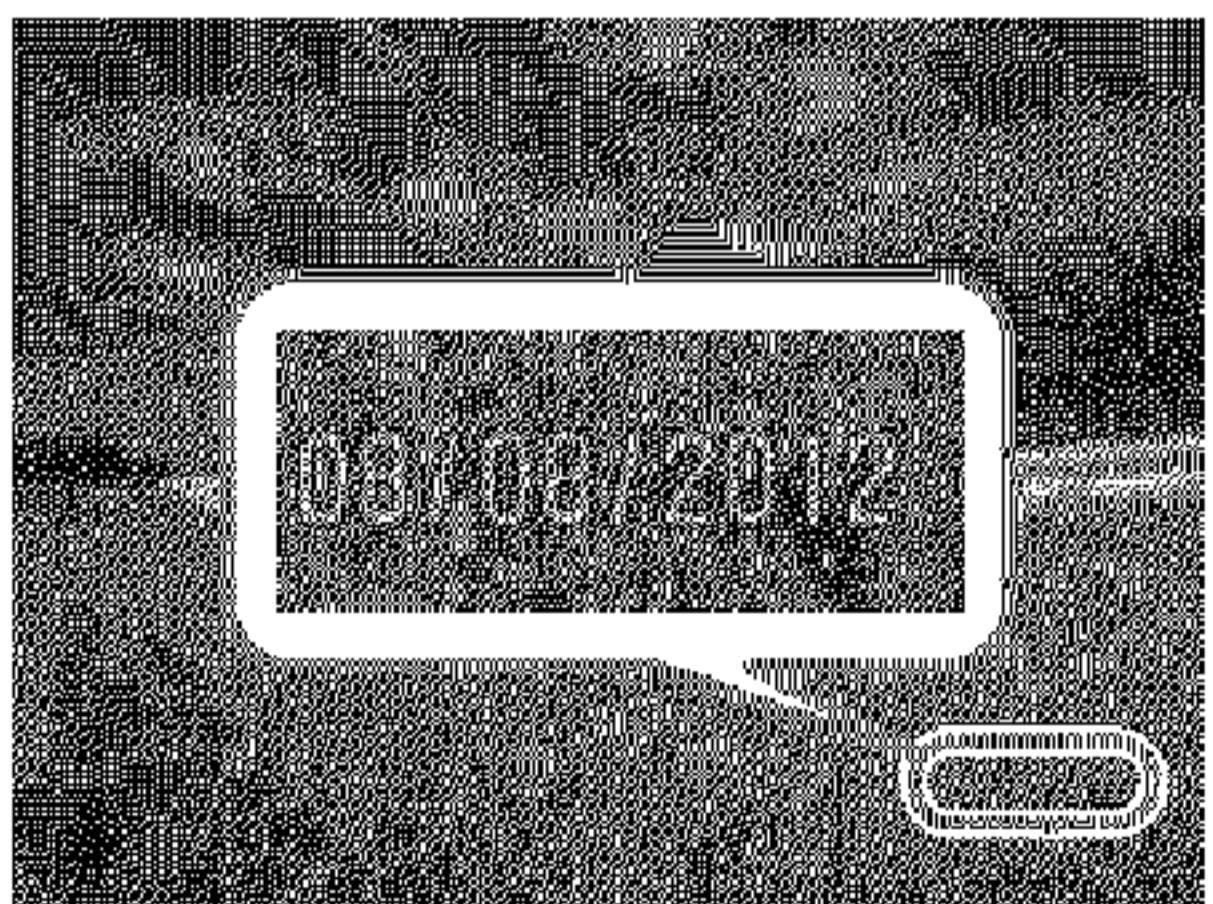
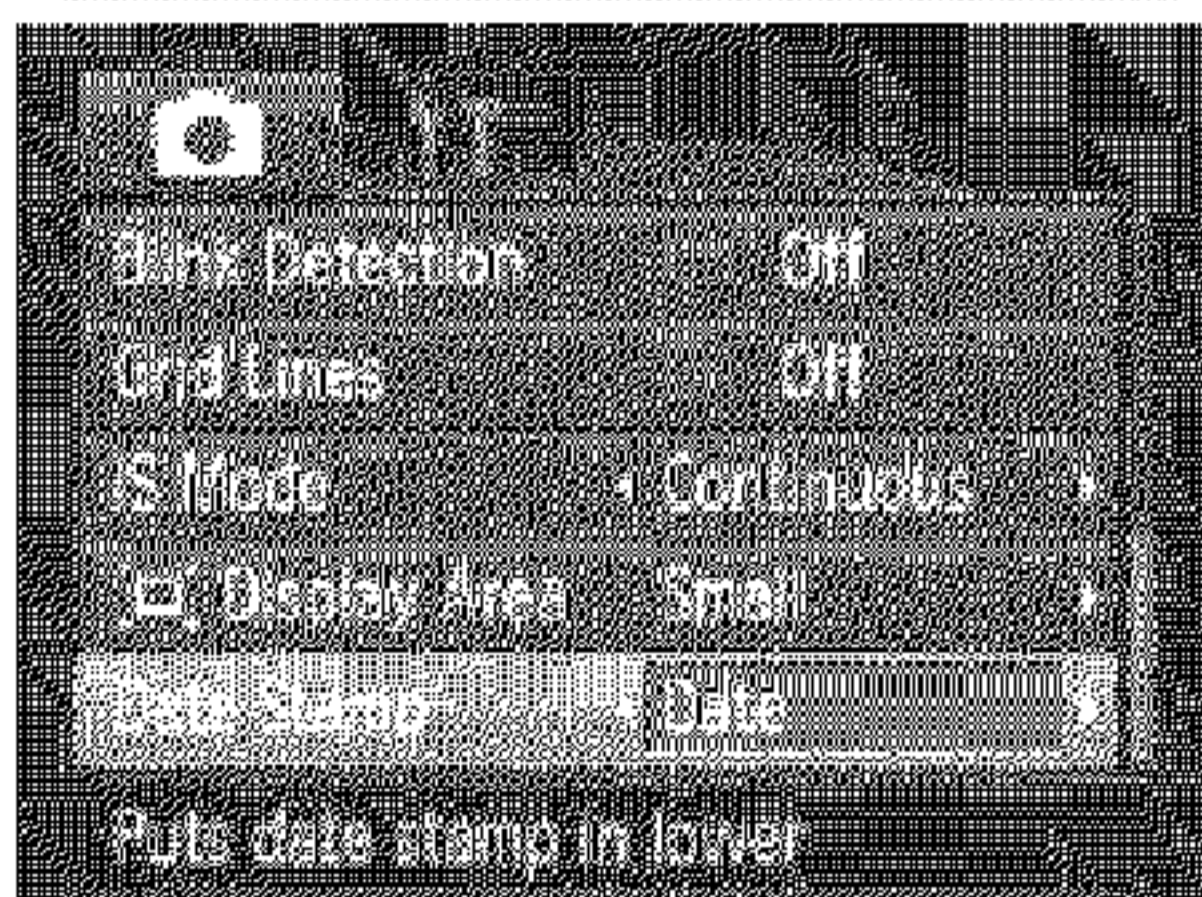
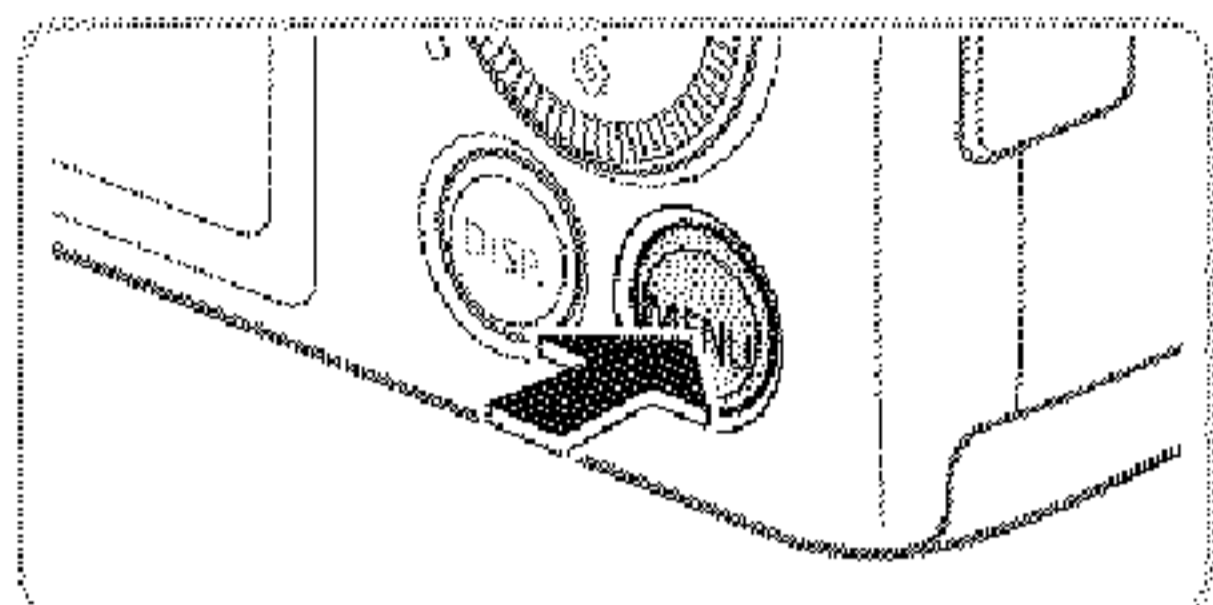

1 Configure the setting.

- Press the <MENU> button, choose [Date Stamp] on the [📷] tab, and then choose the desired option (📖47).
- ▶ Once the setting is complete, [DATE] is displayed.

2 Shoot.

- ▶ As you take shots, the camera adds the shooting date or time to the lower-right corner of images.
- To restore the original setting, choose [Off] in step 1.



* Date stamps cannot be edited or removed.



* Shots taken without adding a date stamp can be printed with one as follows. However, adding a date stamp this way to images that already have one may cause it to be printed twice.

- Use the included software to print
For details, refer to the *Software Guide* (📖31).
- Print using printer functions (📖179)
- Use camera DPOF print settings (📖186) to print

Choosing Subjects to Focus On (Tracking AF)

Shoot after choosing a subject to focus on as follows.

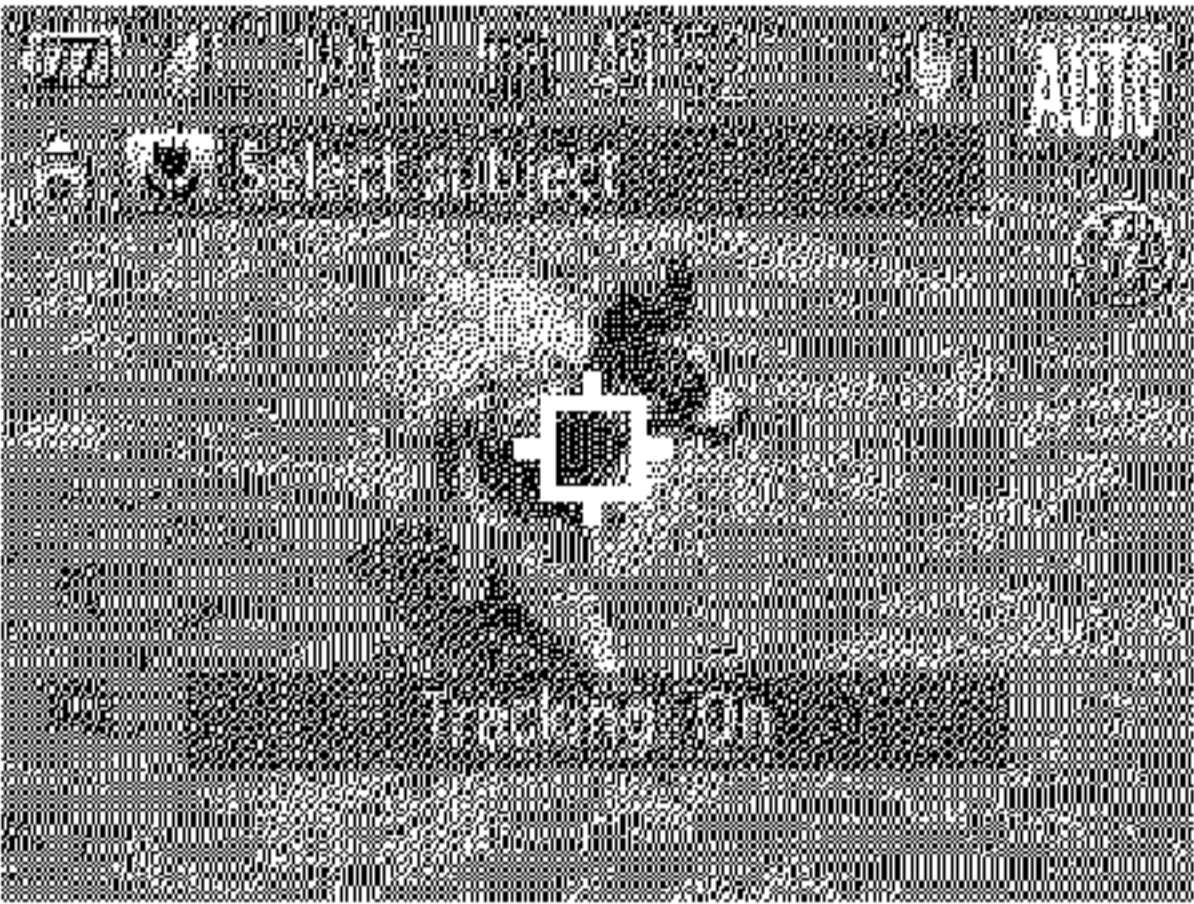
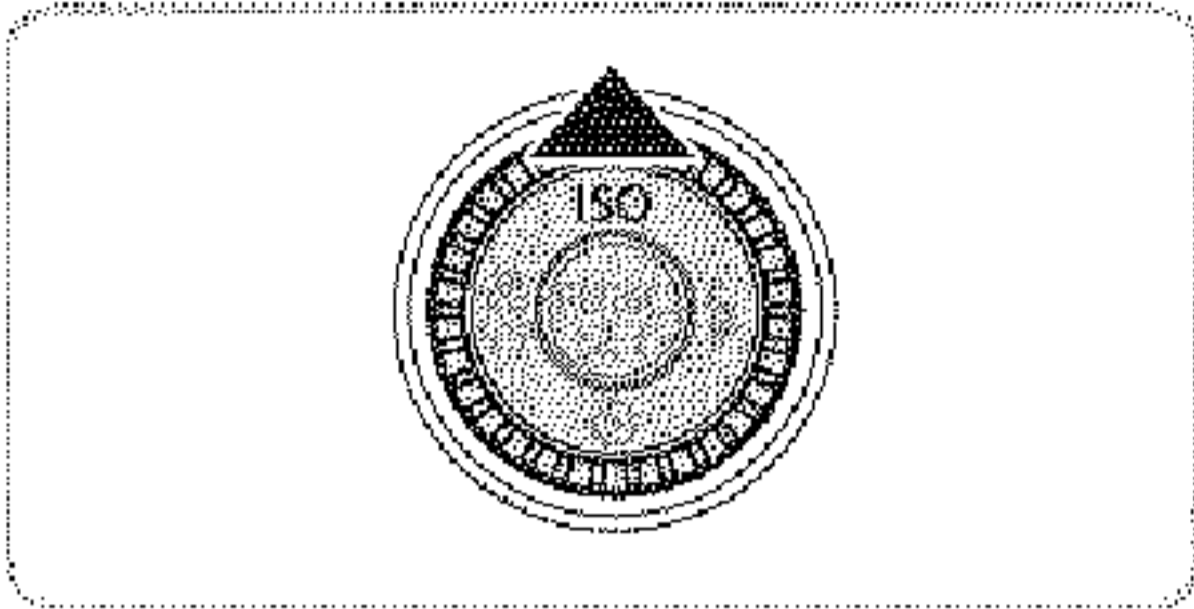

1 Specify Tracking AF.

- Press the <▲> button.
- ▶ [□] is displayed in the center of the screen.

2 Choose a subject to focus on.

- Aim the camera so that [□] is on the desired subject, and then press the shutter button halfway.
- ▶ A blue frame is displayed, and the camera will keep the subject in focus and image brightness adjusted (Servo AF).

3 Shoot.

- Press the shutter button all the way down to shoot.
- Press the <▲> button to cancel Tracking AF.



- * Tracking may not be possible when subjects are too small or move too rapidly, or when subject color or brightness matches that of the background too closely.

Changing the Aspect Ratio

Change the image aspect ratio (ratio of width to height) as follows.

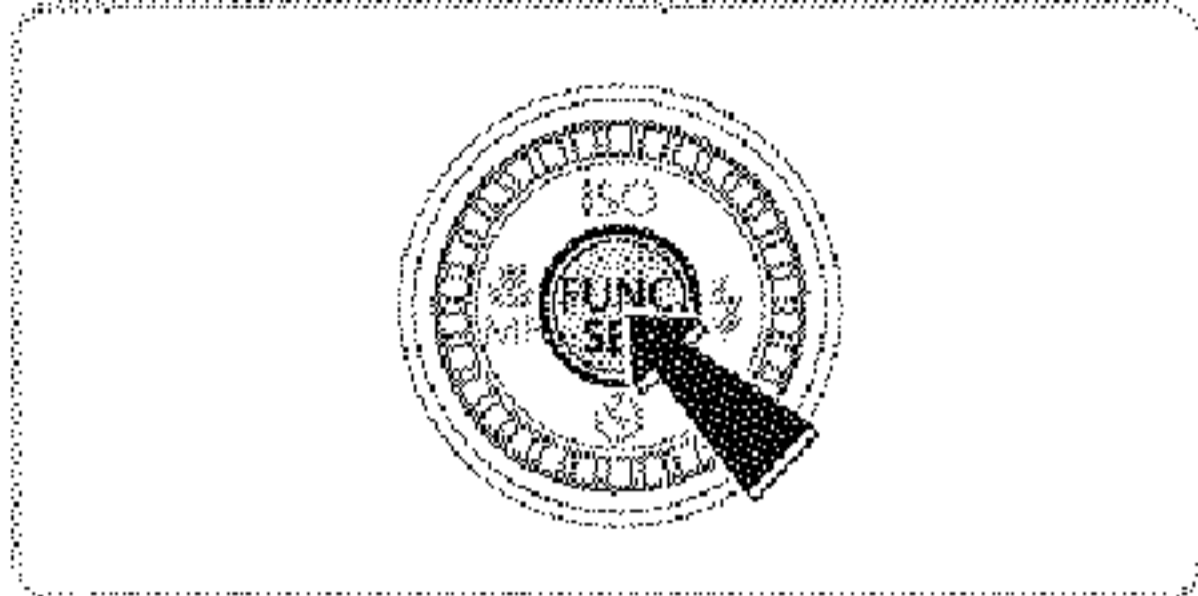

Configure the setting.

- Press the <FUNC SET> button, choose [4:3] in the menu, and choose the desired option (see 46).
- ▶ Once the setting is complete, the screen aspect ratio will be updated.
- To restore the original setting, repeat this process but choose [4:3].

16:9	Used for display on widescreen HDTVs or similar display devices.
3:2	Same aspect ratio as 35mm film, used for printing images at 5 x 7-inch or postcard sizes.
4:3	Native aspect ratio of the camera screen, also used for display on standard-definition televisions or similar display devices, or for printing images at 3.5 x 5-inch or A-series sizes.
1:1	Square aspect ratio.

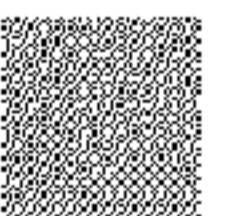

Changing Image Resolution (Size)

Choose from 4 levels of image resolution, as follows. For guidelines on how many shots at each resolution setting can fit on a memory card, see “Specifications” (217).

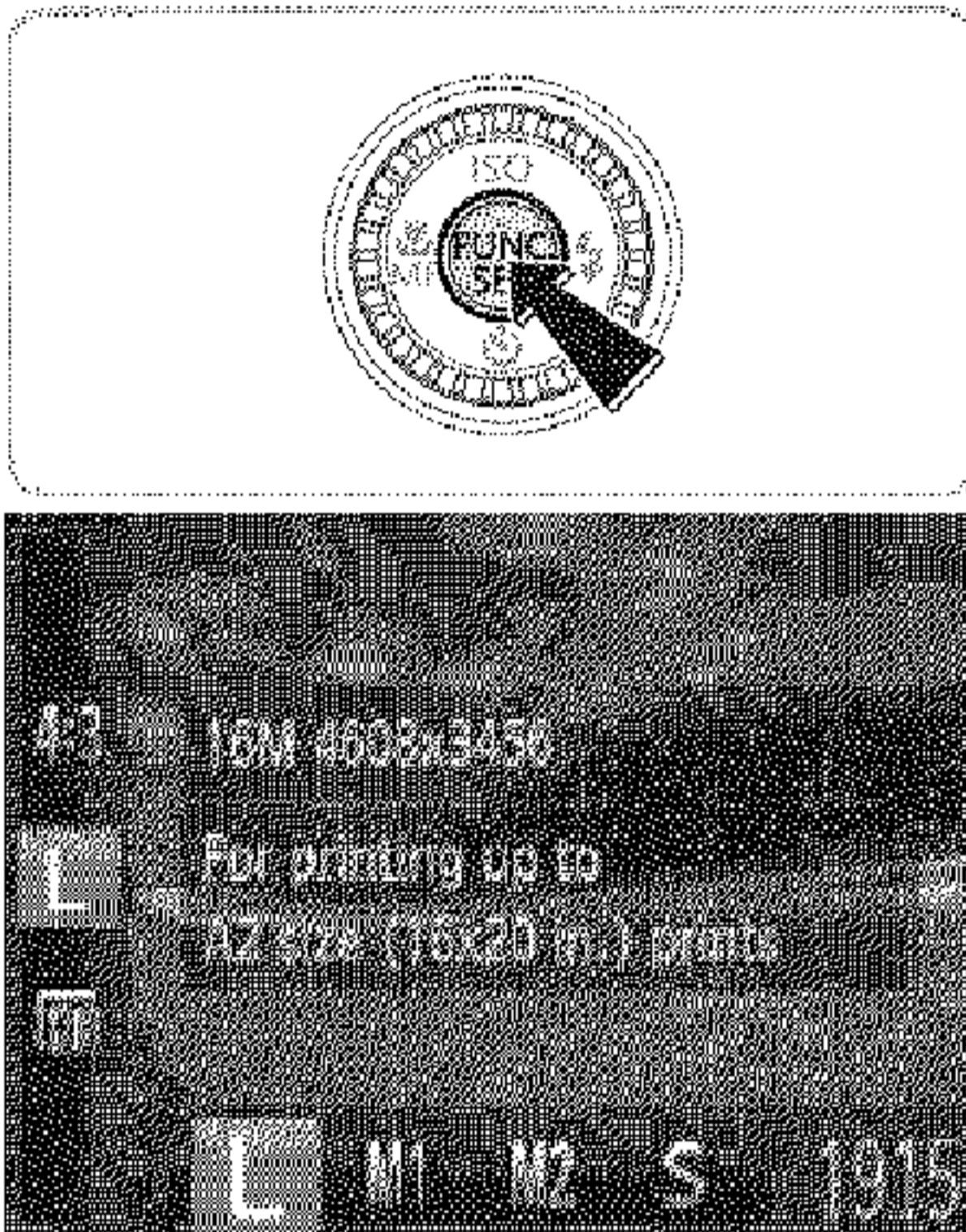

Configure the setting.

- Press the <FUNC. SET> button, choose [L] in the menu, and choose the desired option (46).
- ▶ The option you configured is now displayed.
- To restore the original setting, repeat this process but choose [L].

Guidelines for Choosing Resolution Based on Paper Size (for 4:3 Images)

A2 (16.5 x 23.4 in.)	L
A3 – A5 (11.7 x 16.5 – 5.8 x 8.3 in.)	M1
5 x 7 in. Postcard 3.5 x 5 in.	M2

- [S]: For e-mailing images.

Red-Eye Correction

Red-eye that occurs in the flash photography can be automatically corrected as follows.

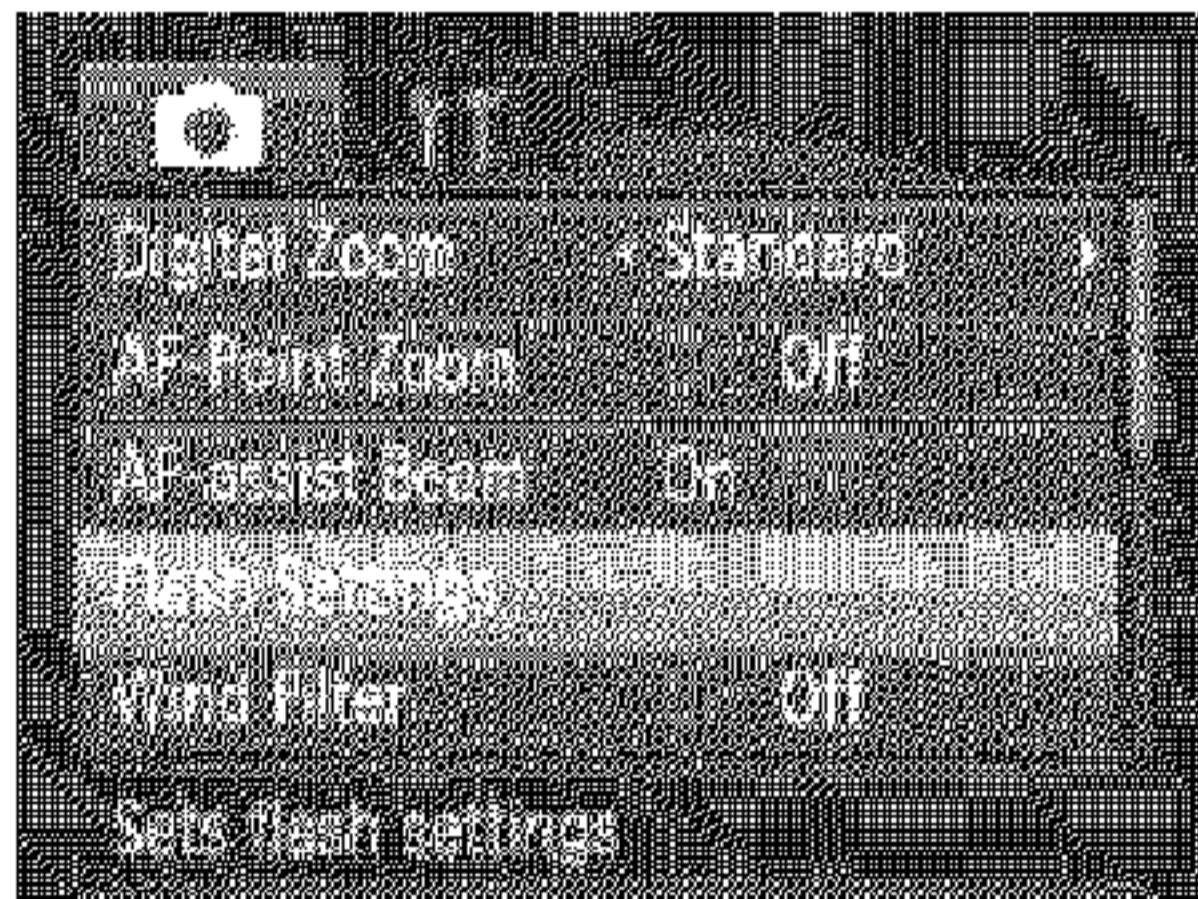
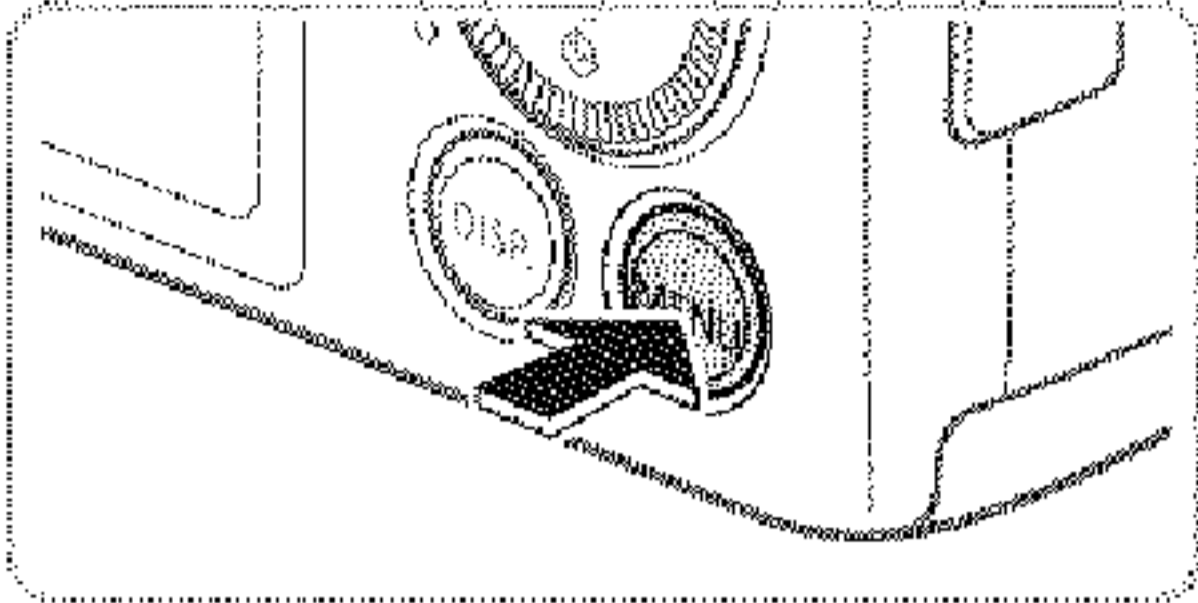

1 Access the [Flash Settings] screen.

- Press the <MENU> button, choose [Flash Settings] on the [📷] tab, and then press the <FUNC. SET> button (📖47).

2 Configure the setting.

- Choose [Red-Eye Corr.], and then choose [On] (📖47).
- ▶ Once the setting is complete, [📷] is displayed.
- To restore the original setting, repeat this process but choose [Off].



- * Red-eye correction may be applied to image areas other than eyes (if the camera misinterprets red eye makeup as red pupils, for example).



- * You can also correct existing images (📖151).
- * You can also access the screen in step 2 when the flash is up by pressing the <▶> button and immediately pressing the <MENU> button.

Changing Movie Image Quality

2 image quality settings are available. For guidelines on the maximum movie length at each level of image quality that will fit on a memory card, see “Specifications” (217).

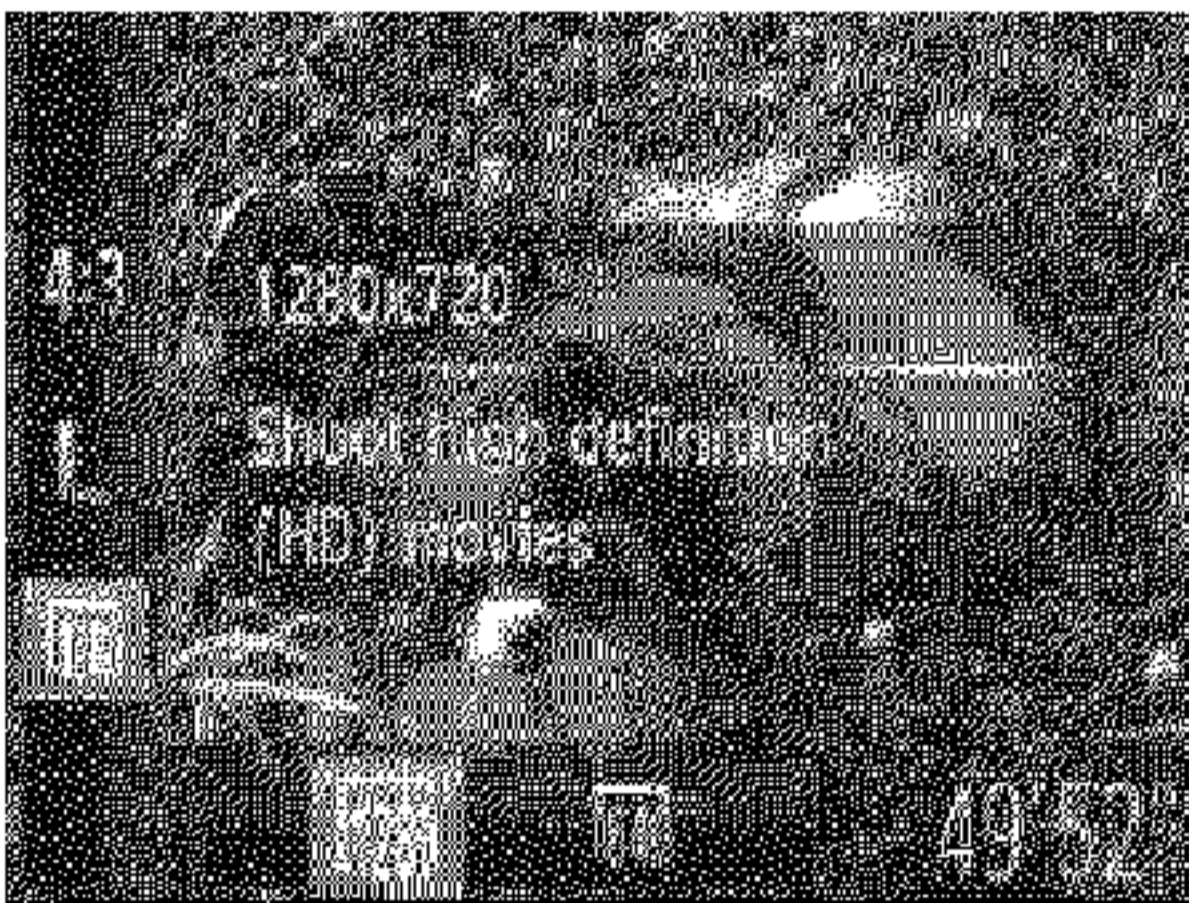
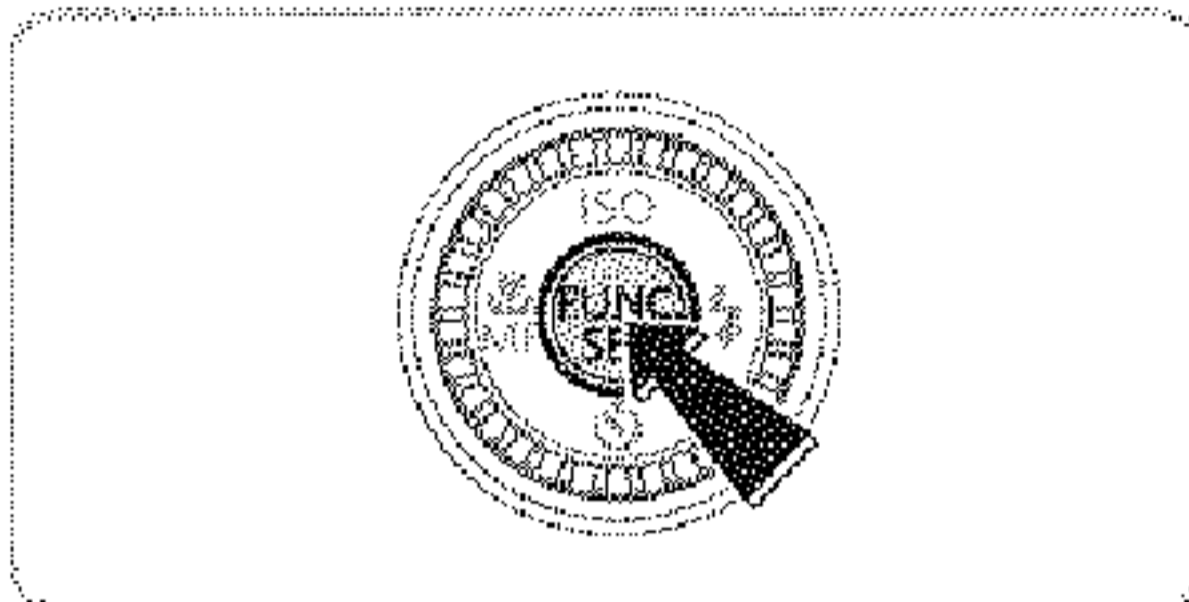

Configure the setting.

- Press the <FUNC SET> button, choose [1280] in the menu, and choose the desired option (46).
- ▶ The option you configured is now displayed.
- To restore the original setting, repeat this process but choose [1280].

Image Quality	Resolution	Frame Rate	Details
[1280]	1280 x 720	25 fps*	For shooting in HD
[640]	640 x 480	30 fps	For shooting in standard definition

* [1280] movies are played back at 30 fps.



- * In [1280] mode, black bars displayed on the top and bottom edges of the screen indicate image areas not recorded.

Using the Wind Filter

Distorted audio caused by recording when the wind is strong can be reduced. However, the recording may sound unnatural when this option is used when there is no wind.

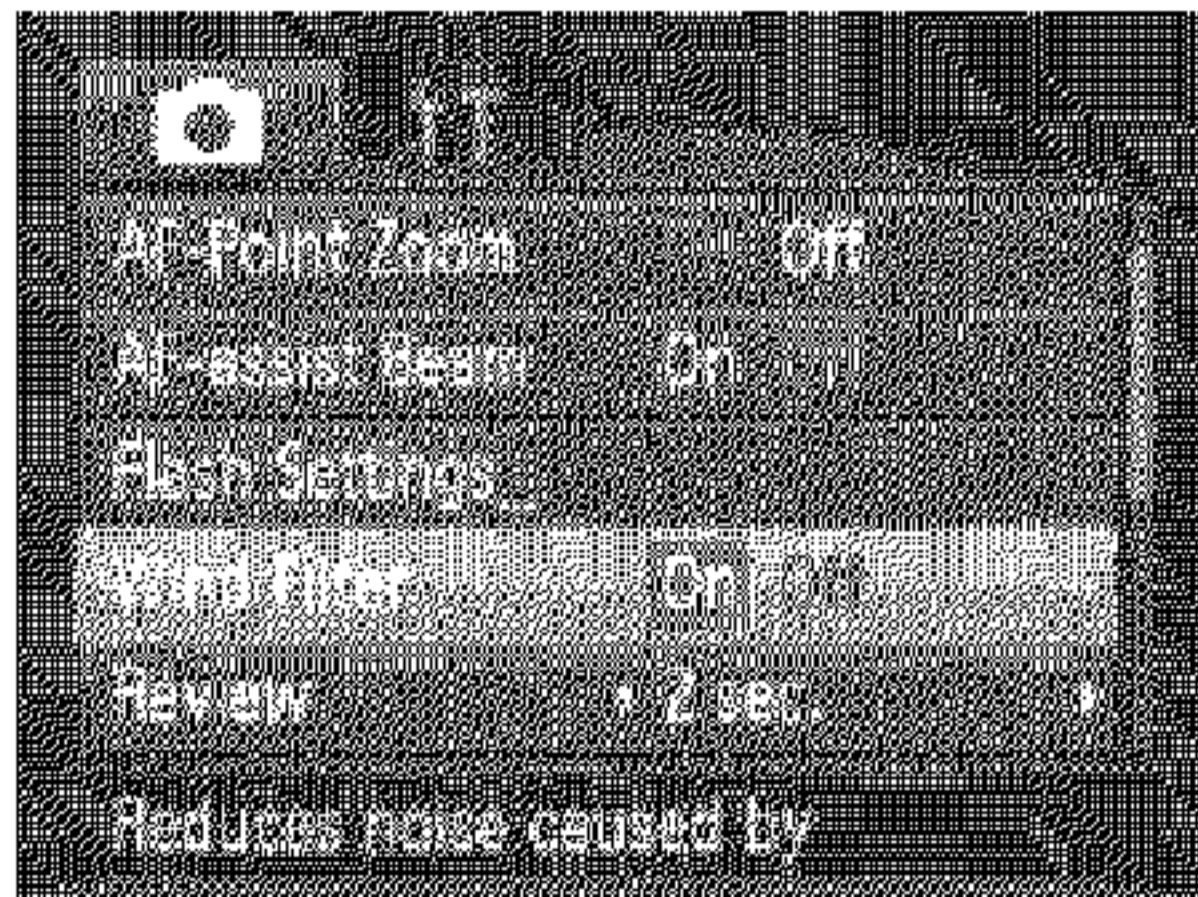
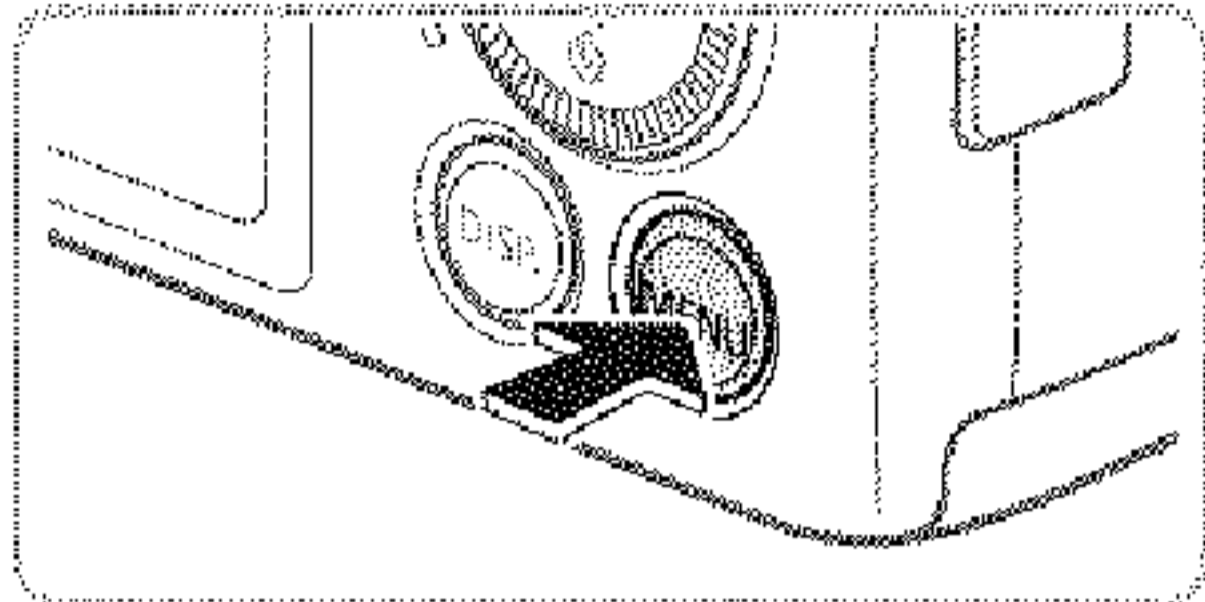

Configure the setting.

- Press the <MENU> button, choose [Wind Filter] on the [📷] tab, and then choose [On] (📖47).
- To restore the original setting, repeat this process but choose [Off].

Helpful Shooting Features

Still Images

Movies

Displaying Grid Lines

Grid lines can be displayed on the screen for vertical and horizontal reference while shooting.

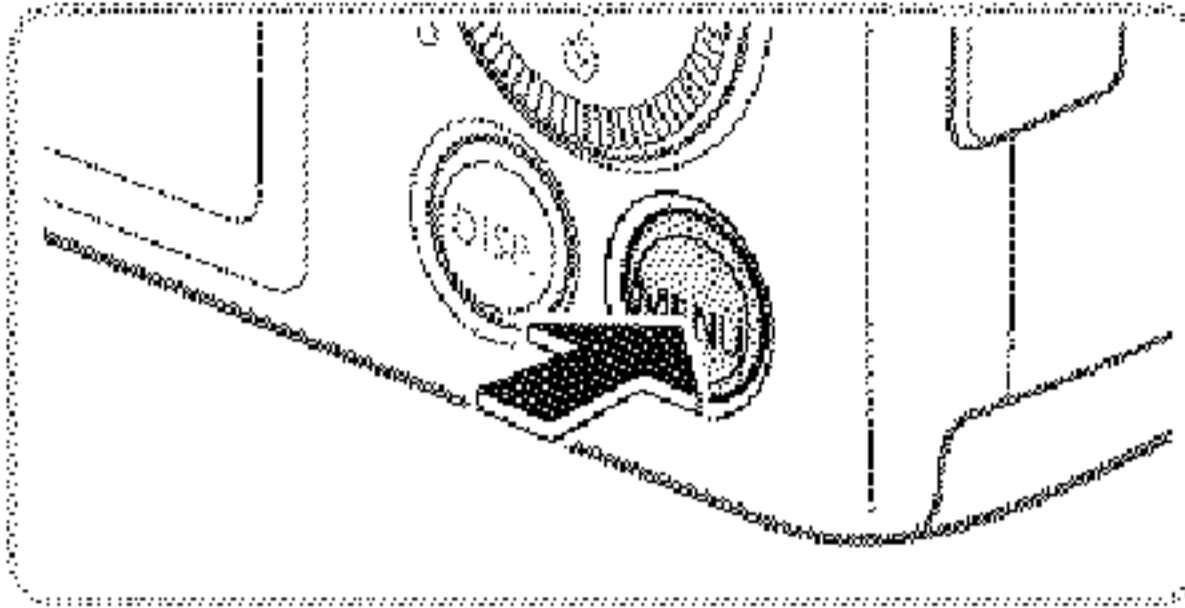

Configure the setting.

- Press the <MENU> button, choose [Grid Lines] on the [📷] tab, and then choose [On] (📖47).
- ▶ Once the setting is complete, grid lines are displayed on the screen.
- To restore the original setting, repeat this process but choose [Off].



* Grid lines are not recorded in your shots.

Still Images

Magnifying the Area in Focus

You can check the focus by pressing the shutter button halfway, which will enlarge the portion of the image in focus in the AF frame.

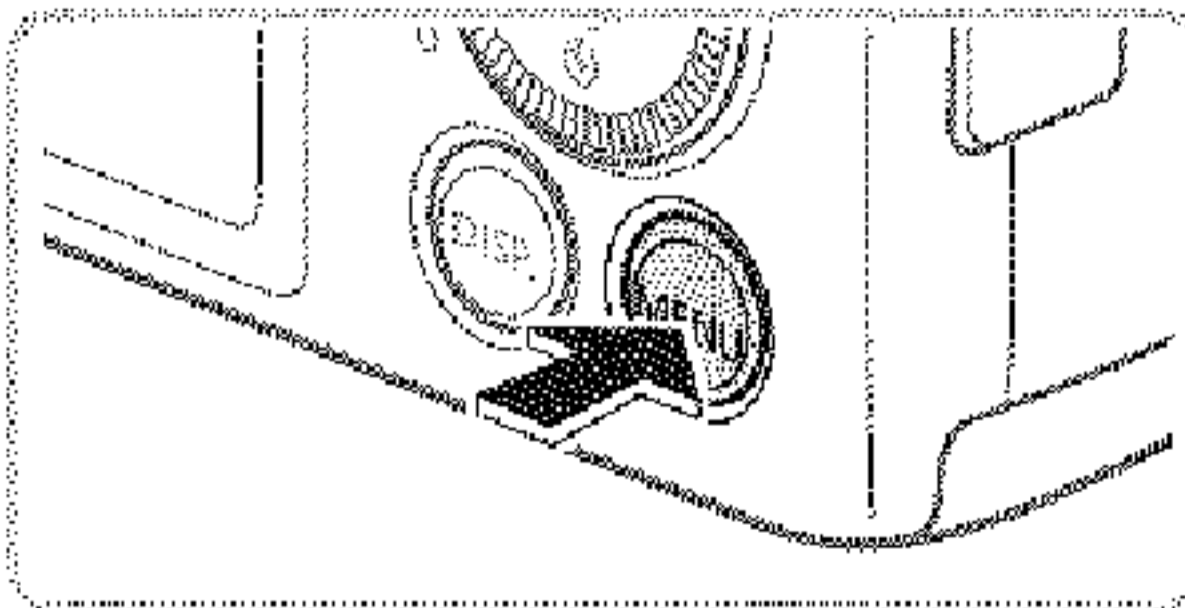

Configure the setting.

- Press the <MENU> button, choose [AF-Point Zoom] on the [📷] tab, and then choose [On] (📖47).

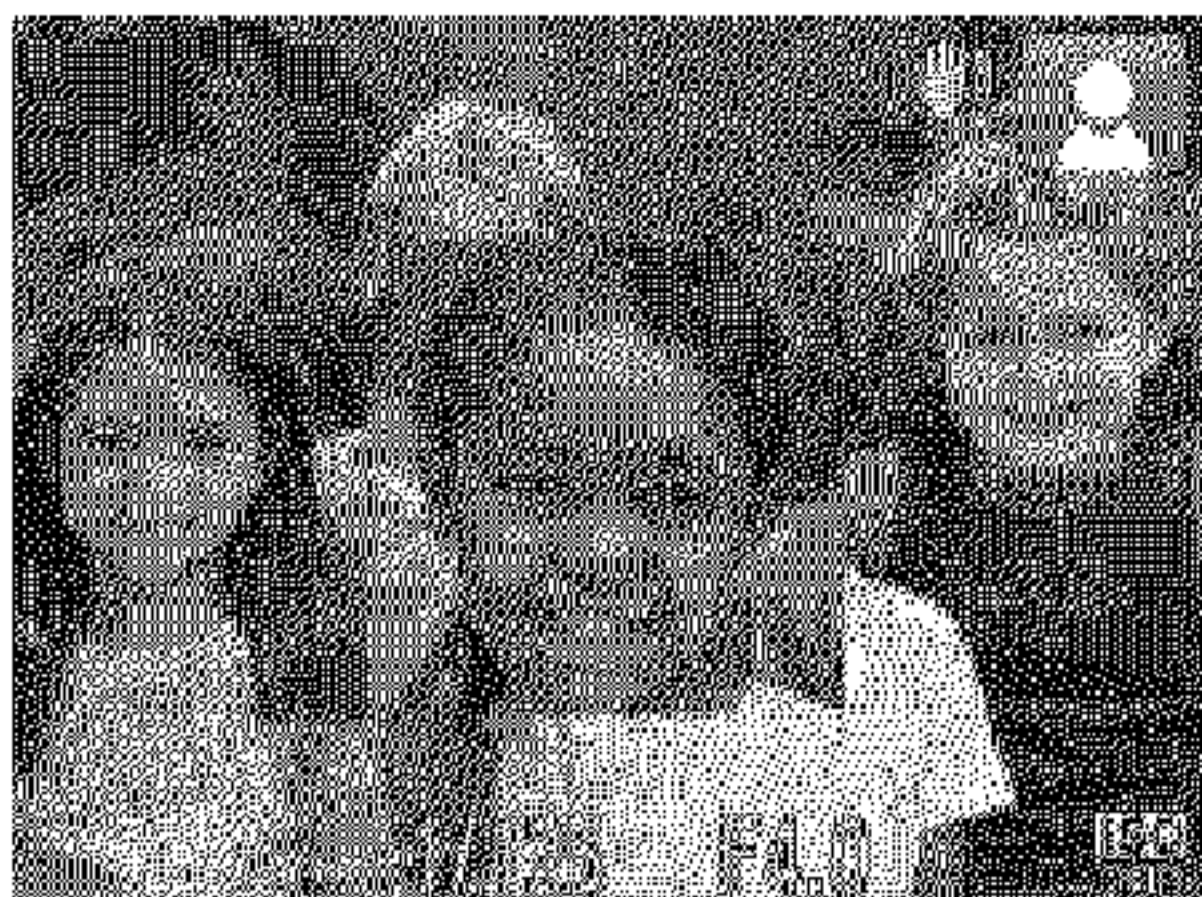

2 Check the focus.

- Press the shutter button halfway. The face detected as the main subject is now magnified.
- To restore the original setting, choose [Off] in step 1.



* The area in focus will not be magnified when you press the shutter button halfway if a face was not detected, if the person is too close to the camera and their face is too large for the screen, or if the camera detects subject movement.





* The display will not magnify when using the digital zoom (📖60) or Tracking AF (📖107).

Checking for Closed Eyes

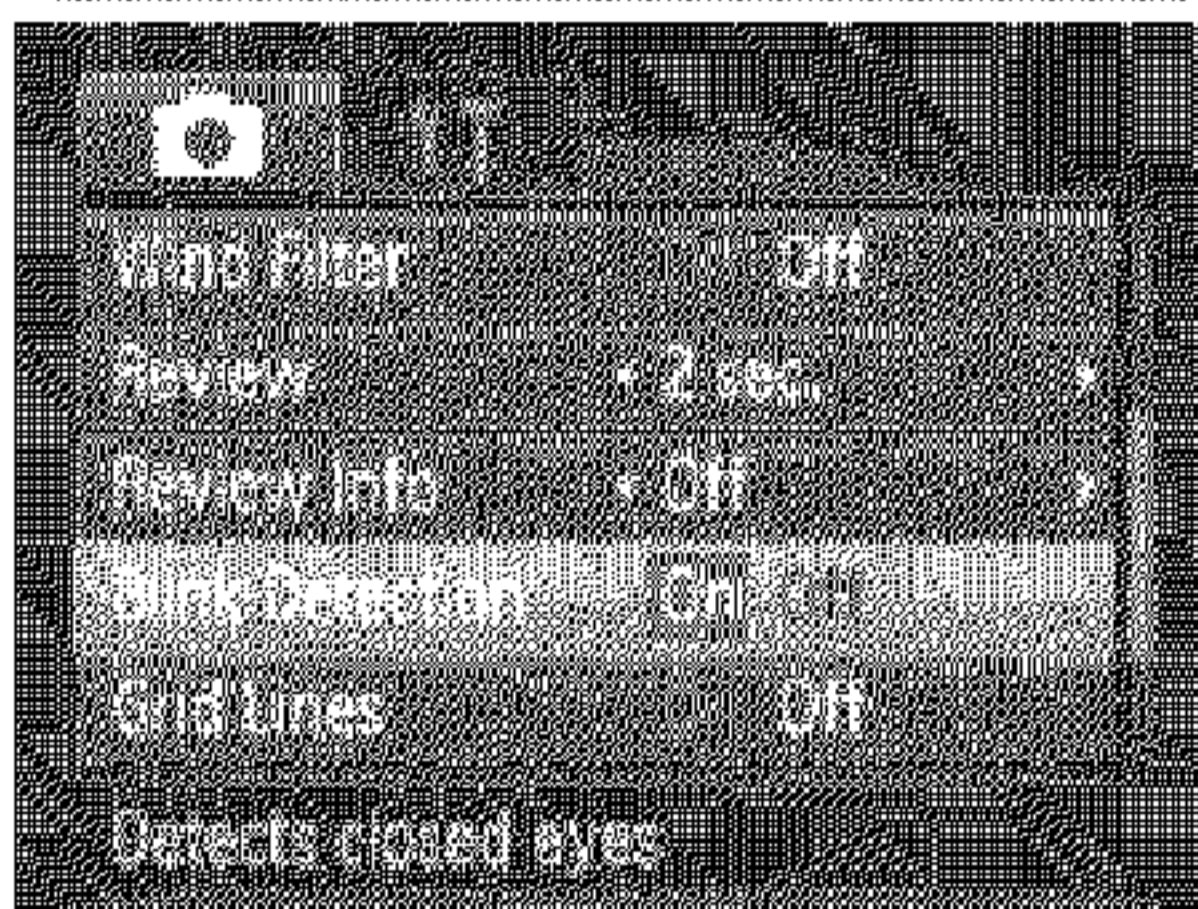
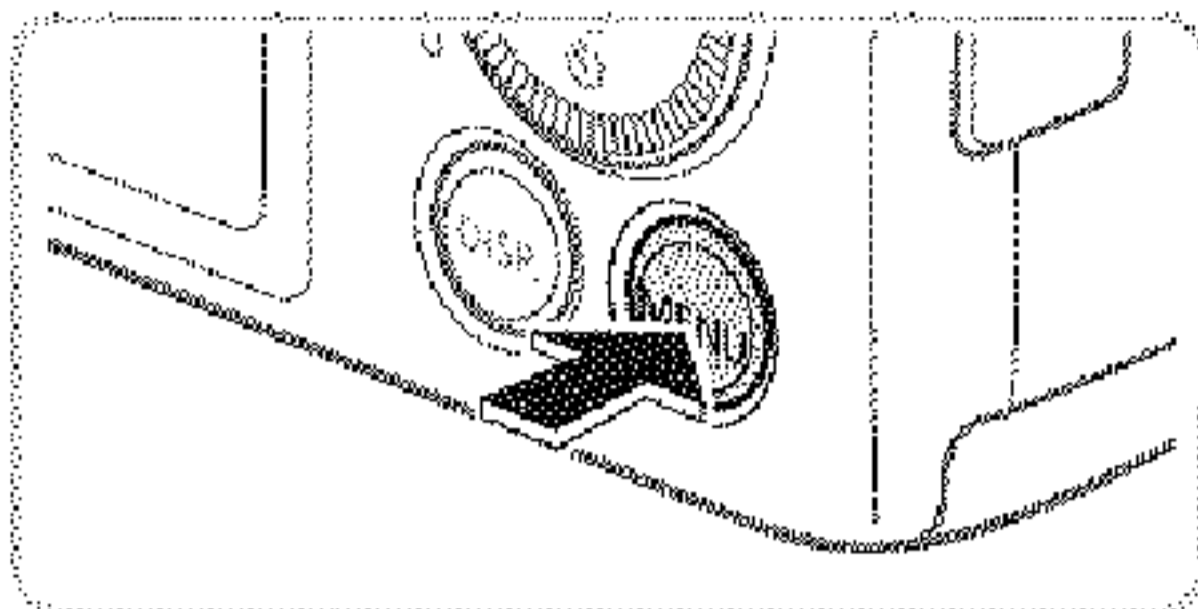
[,] is displayed when the camera detects that people may have closed their eyes.





1 Configure the setting.

- Press the <MENU> button, choose [Blink Detection] on the [,] tab, and then choose [On] (47).

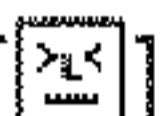
2 Shoot.

- ▶ A frame, accompanied by [,], is displayed when the camera detects a person whose eyes are closed.
- To restore the original setting, choose [Off] in step 1.



- When you have specified multiple shots in [,] mode, this function is only available for the final shot.
- The frame is not displayed when [Review] is set to [Quick] (76).

Customizing Camera Operation

Customize shooting functions on the [📷] tab of the menu as follows. For instructions on menu functions, see “MENU Menu” (📖47).

Still Images

Deactivating the AF Assist Beam

You can deactivate the lamp that normally lights up to help you focus when you press the shutter button halfway in low-light conditions.



Configure the setting.

- Press the <MENU> button, choose [AF-assist Beam] on the [📷] tab, and then choose [Off] (📖47).
- To restore the original setting, repeat this process but choose [On].

Still Images

Deactivating the Red-Eye Reduction Lamp

You can deactivate the red-eye reduction lamp that lights up to reduce red-eye when the flash is used in low-light shots.

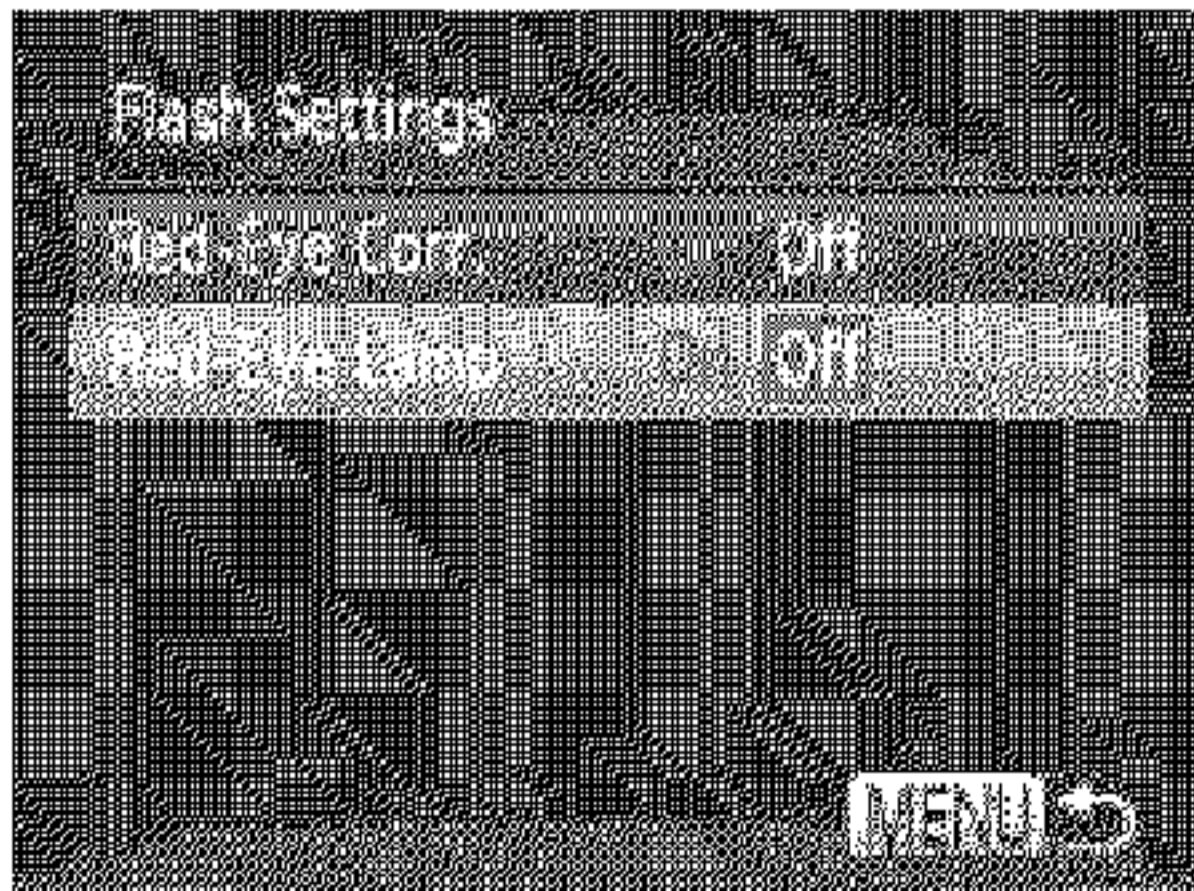

1 Access the [Flash Settings] screen.

- Press the <MENU> button, choose [Flash Settings] on the [📷] tab, and then press the <FUNC. SET> button (📖47).

2 Configure the setting.

- Choose [Red-Eye Lamp], and then choose [Off] (📖47).
- To restore the original setting, repeat this process but choose [On].

Changing the Image Display Period After Shots

Change how long images are displayed after shots as follows.



Configure the setting.

- Press the <MENU> button, choose [Review] on the [CAMERA] tab, and then choose the desired option (47).
- To restore the original setting, repeat this process but choose [2 sec.].

Quick	Displays images only until you can shoot again.
2 – 10 sec.	Displays images for the specified time.
Hold	Displays images until you press the shutter button halfway.
Off	No image display after shots.

Changing the Image Display Style After Shots

Change the way images are displayed after shots as follows.

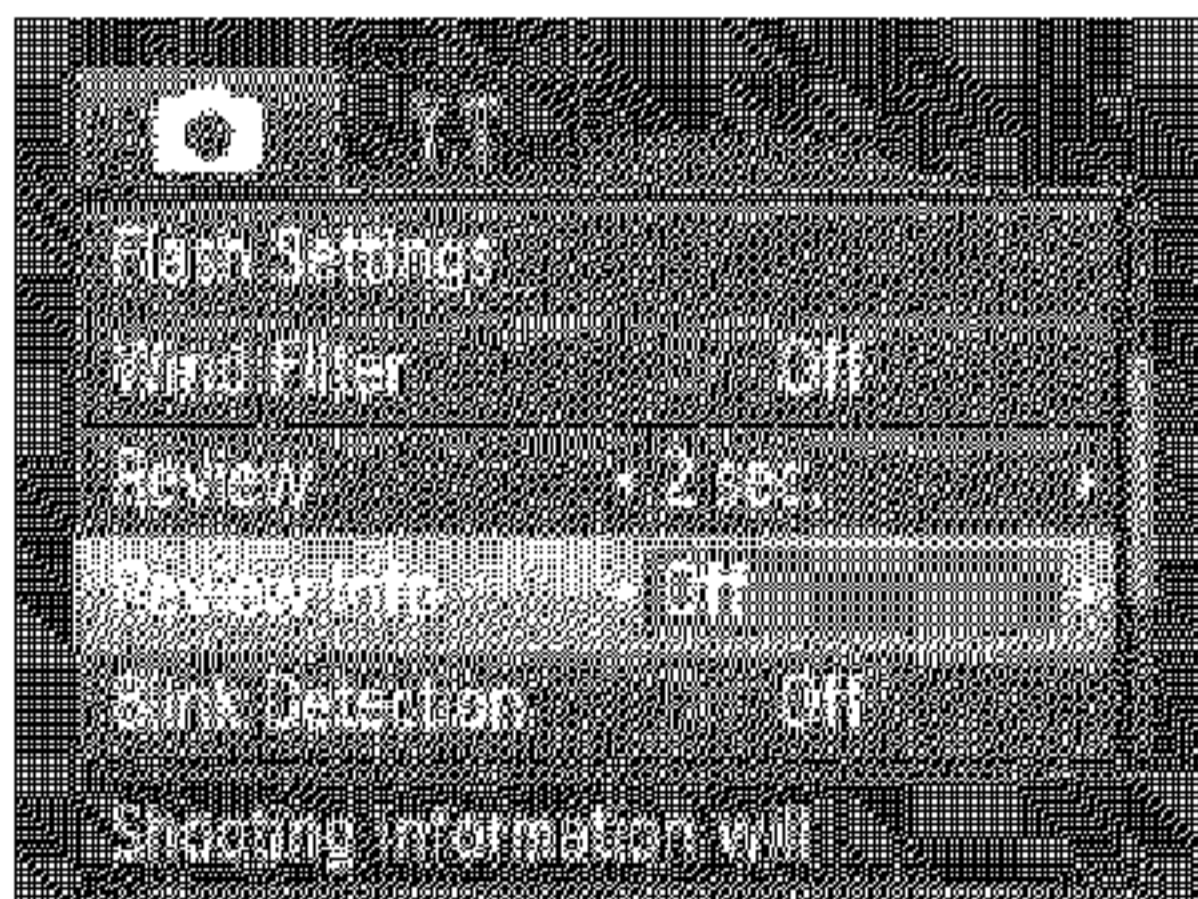

Configure the setting.

- Press the <MENU> button, choose [Review Info] on the [CAMERA] tab, and then choose the desired option (47).
- To restore the original setting, repeat this process but choose [Off].

Off	Displays only the image.
Detailed	Displays shooting details (204).
Focus Check	Shows the area in the AF frame magnified, enabling you to check the focus. Follow the steps in “Checking the Focus” (125).



* This setting is set to [Off] and cannot be changed when [Review] (see above) is set to [Quick] or [Off].

3

Other Shooting Modes

Shoot more effectively in various scenes, and take shots enhanced with unique image effects or captured using special functions

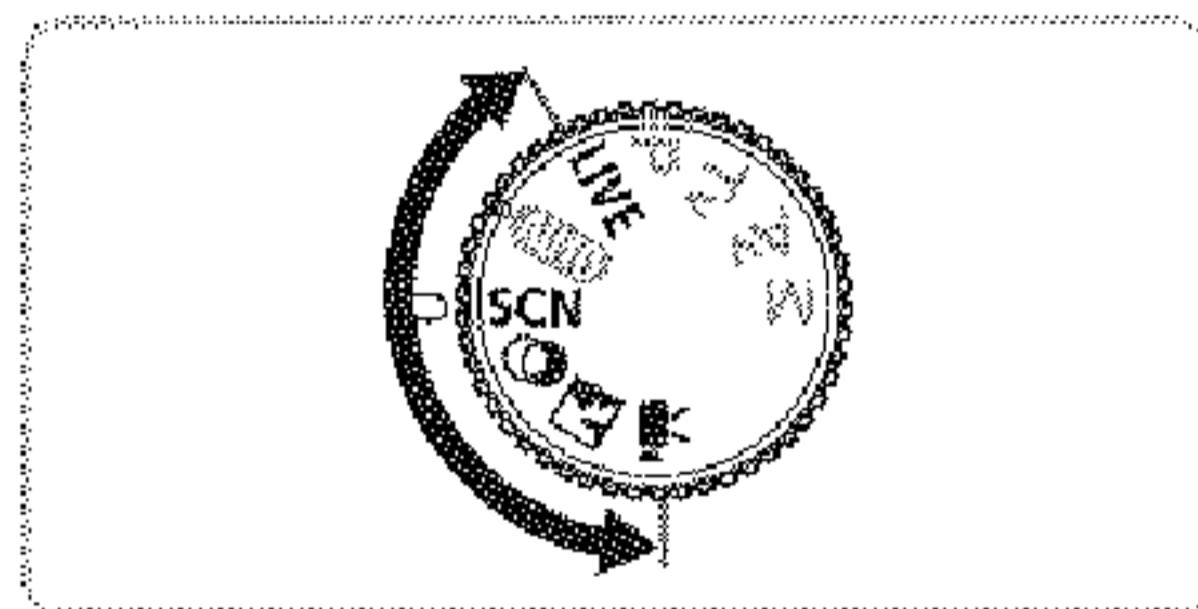

Discreet Mode

Shoot without activating camera sounds, the flash, or lamp as follows. Use this mode where camera sounds, the flash, and lights are prohibited.

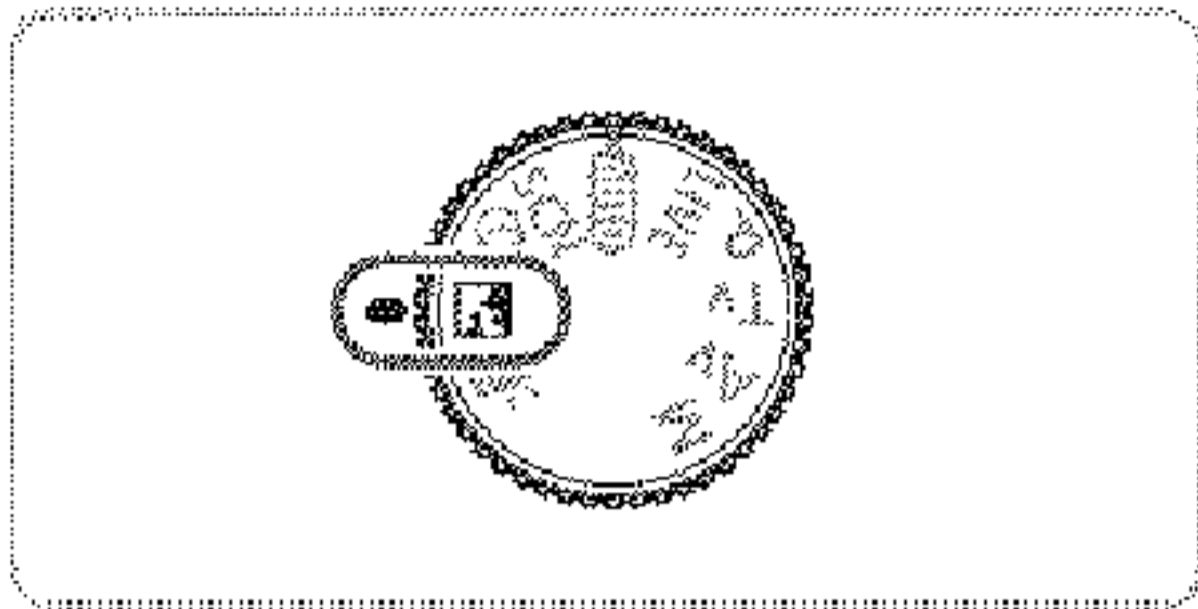

- 1 **Enter  mode.**
 - Set the mode dial to .

- 2 **Shoot.**



- * In  mode, even playback sounds are muted. Sounds of camera operations are muted, and movie audio is also muted.

Brightness/Color Customization (Live View Control)

Image brightness or colors when shooting can be easily customized as follows.



1 Enter <LIVE> mode.

- Set the mode dial to <LIVE>.

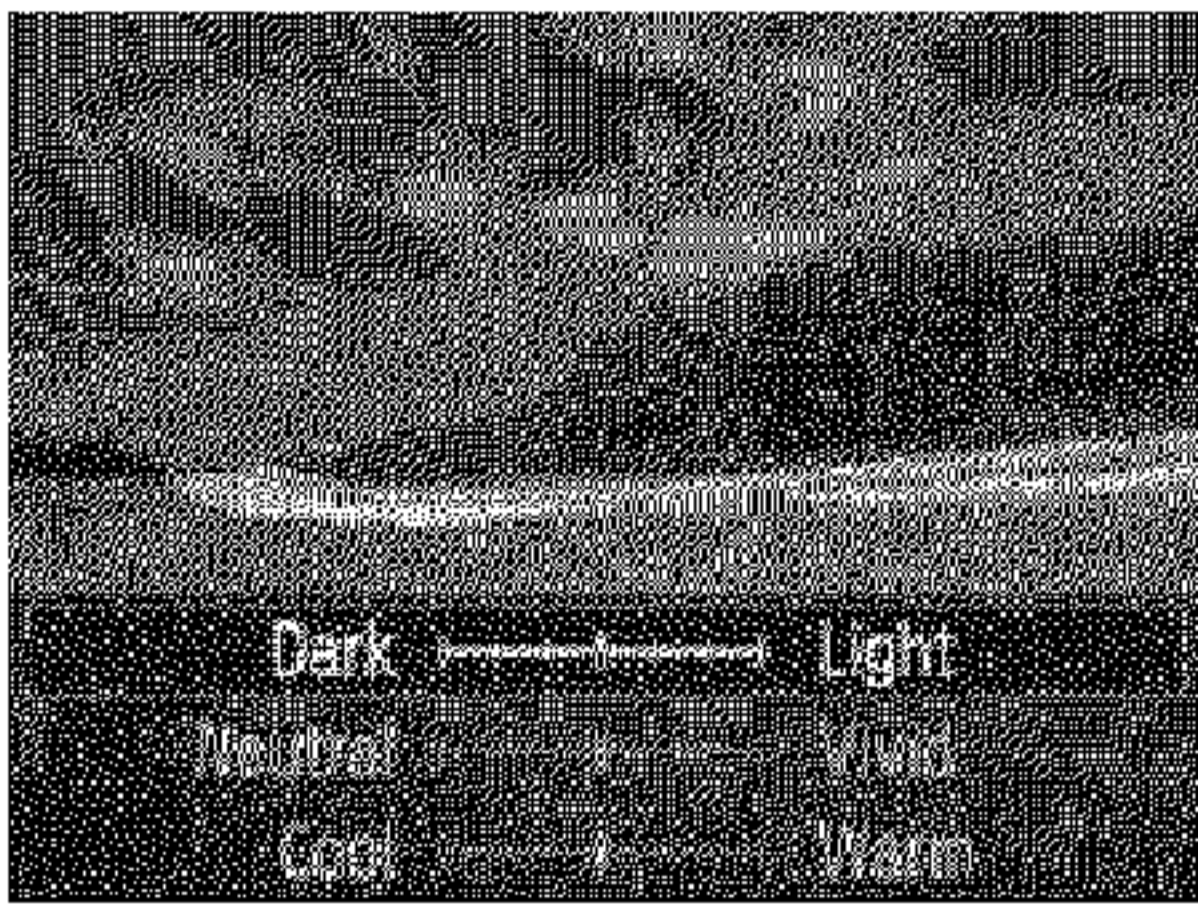

2 Configure the setting.

- Press the <FUNC/SET> button to access the setting screen. Press the <▲><▼> buttons to choose a setting item, and then press the <◀><▶> buttons or turn the <◉> dial to adjust the value as you watch the screen.
- Press the <FUNC/SET> button.

3 Shoot.

Brightness	For brighter images, adjust the level to the right, and for darker images, adjust it to the left.
Color	For more vivid images, adjust the level to the right, and for more subdued images, adjust it to the left.
Tone	For a warm, reddish tone, adjust the level to the right, and for a cool, bluish tone, adjust it to the left.

Specific Scenes

Choose a mode matching the shooting scene, and the camera will automatically configure the settings for optimal shots.

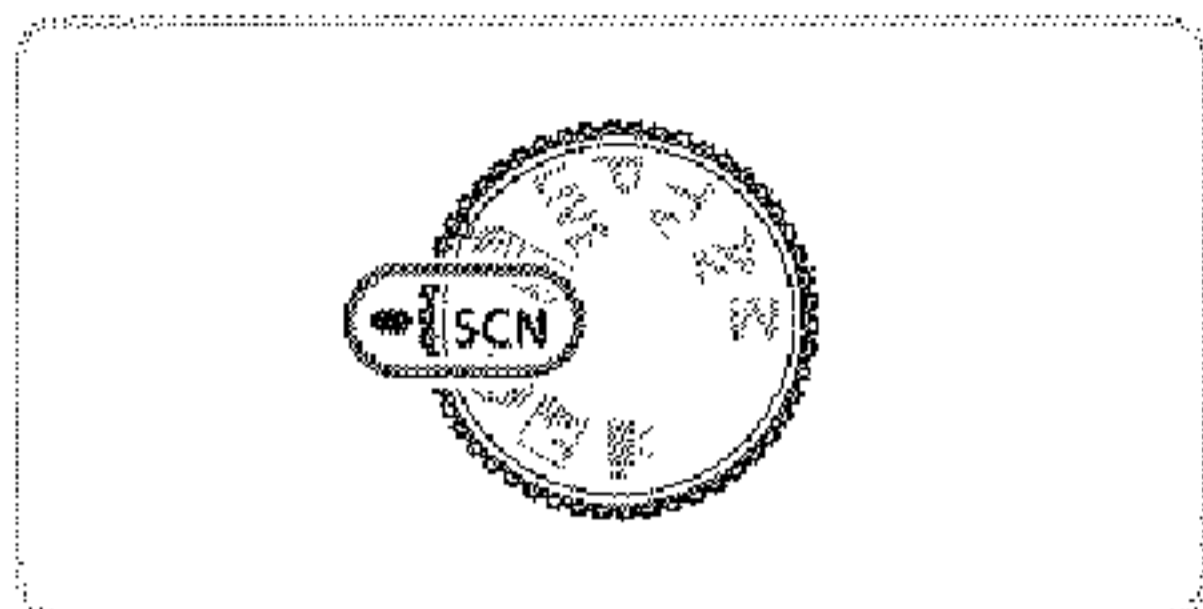

- 1 **Enter <SCN> mode.**
 - Set the mode dial to <SCN>.



- 2 **Choose a shooting mode.**
 - Press the <FUNC/SET> button, choose [P] in the menu, and then choose a shooting mode (46).

- 3 **Shoot.**



Still Images

Movies

- **Shoot portraits (Portrait)**
 - Take shots of people with a softening effect.

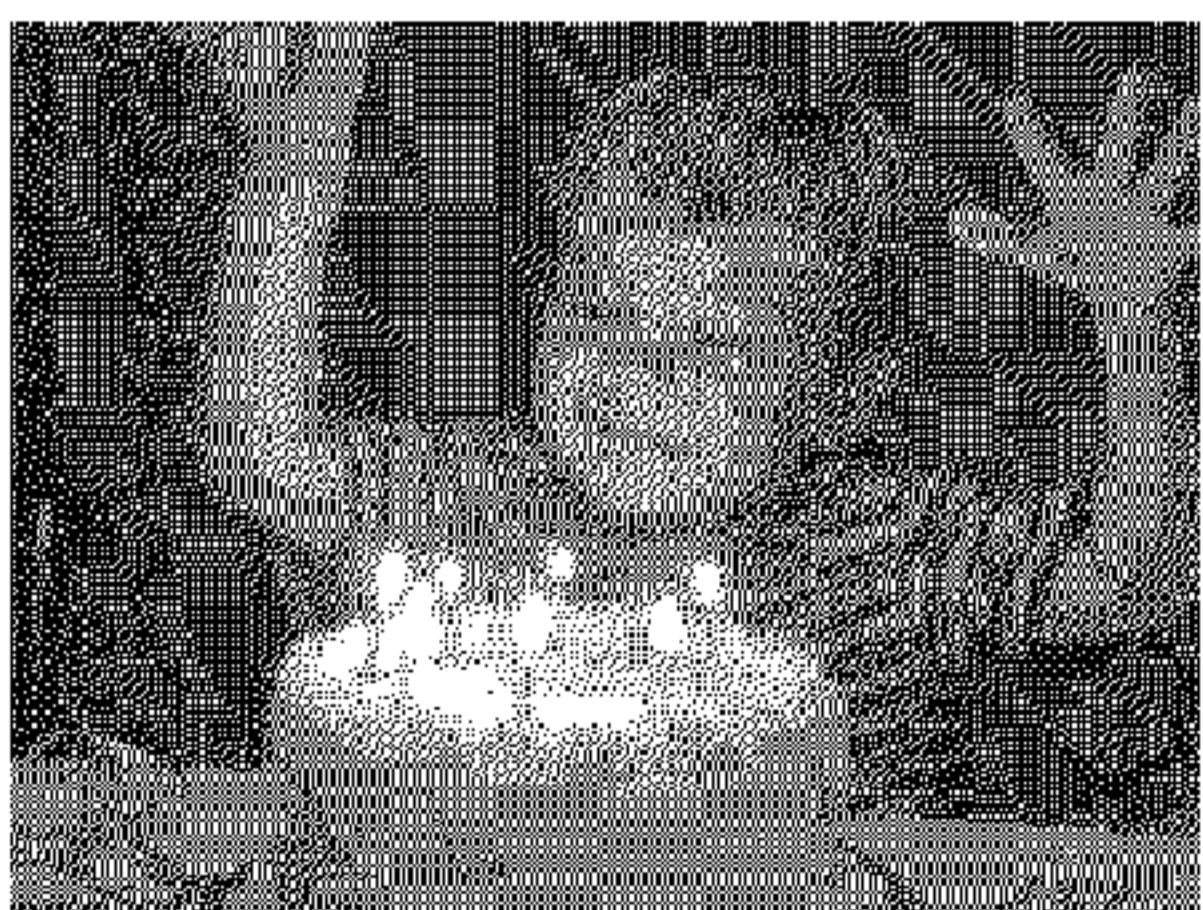

Still Images

- **Shoot under low light (Low Light)**
 - Shoot with minimal camera shake and subject blur even in low-light conditions.

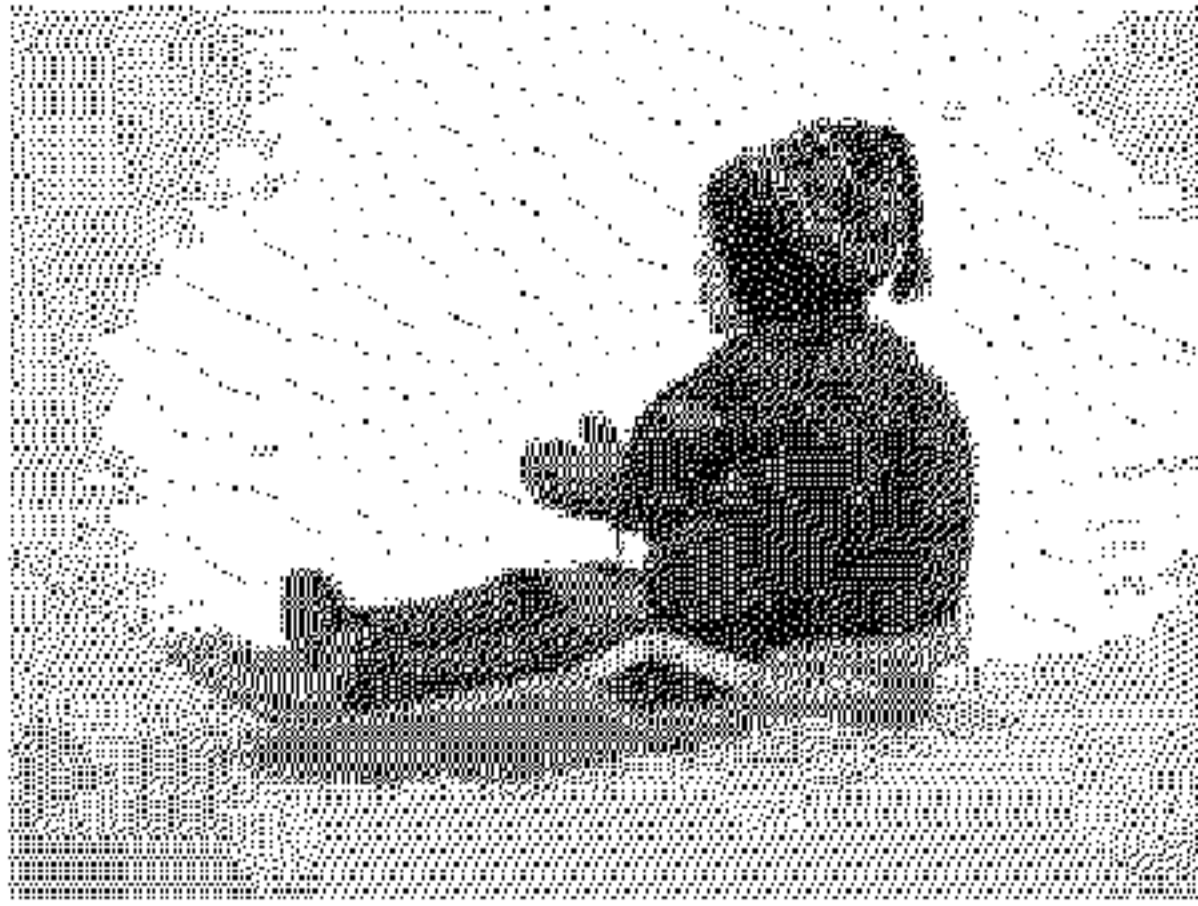

Still Images

Movies

Shoot with snowy backgrounds (Snow)

- Bright, natural-colored shots of people against snowy backgrounds.

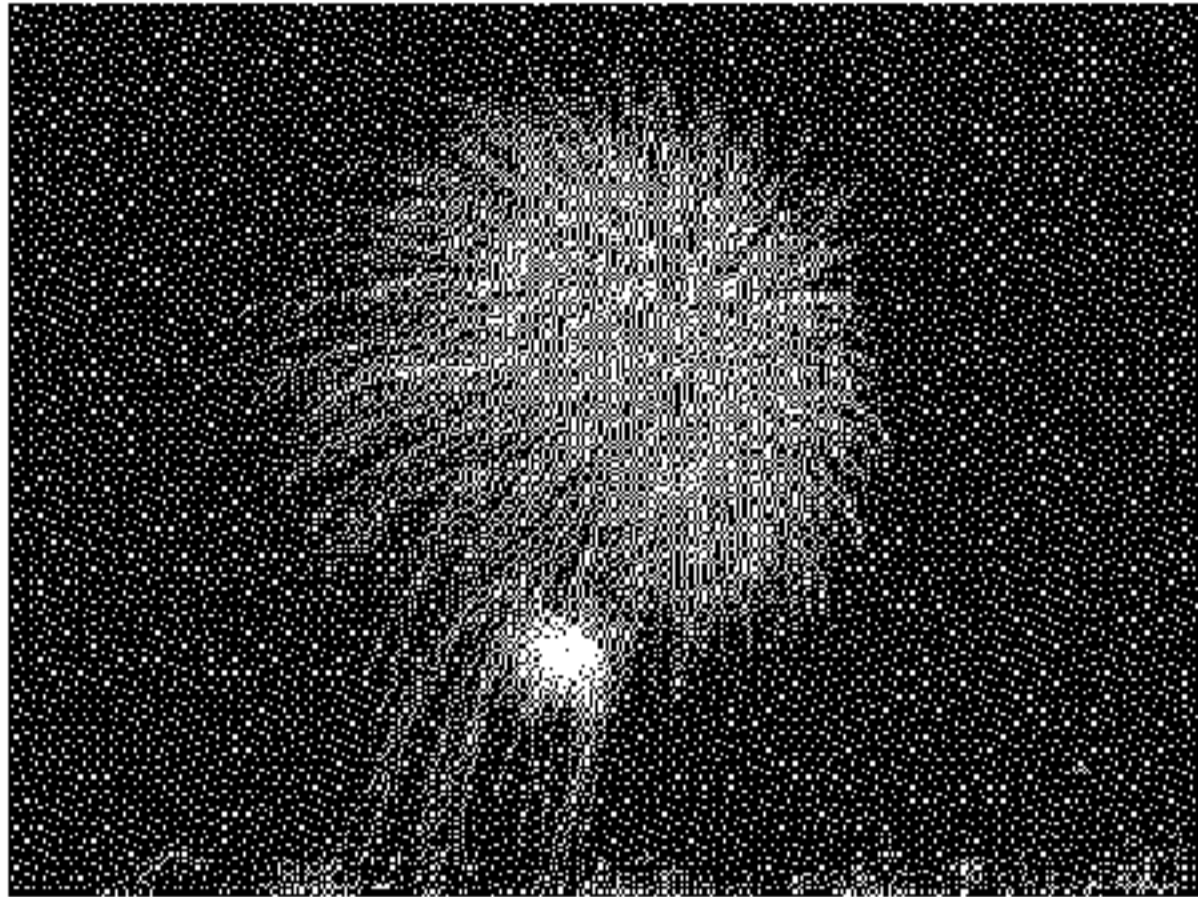



Still Images

Movies

Shoot fireworks (Fireworks)

- Vivid shots of fireworks.



- * In  mode, mount the camera on a tripod or take other measures to keep it still and prevent camera shake. Additionally, you should set [IS Mode] to [Off] when using a tripod or other means to hold the camera still ( 114).



- *  mode resolution is [**M**] (2304 x 1728) and cannot be changed.

Image Effects (Creative Filters)

Add a variety of effects to images when shooting.

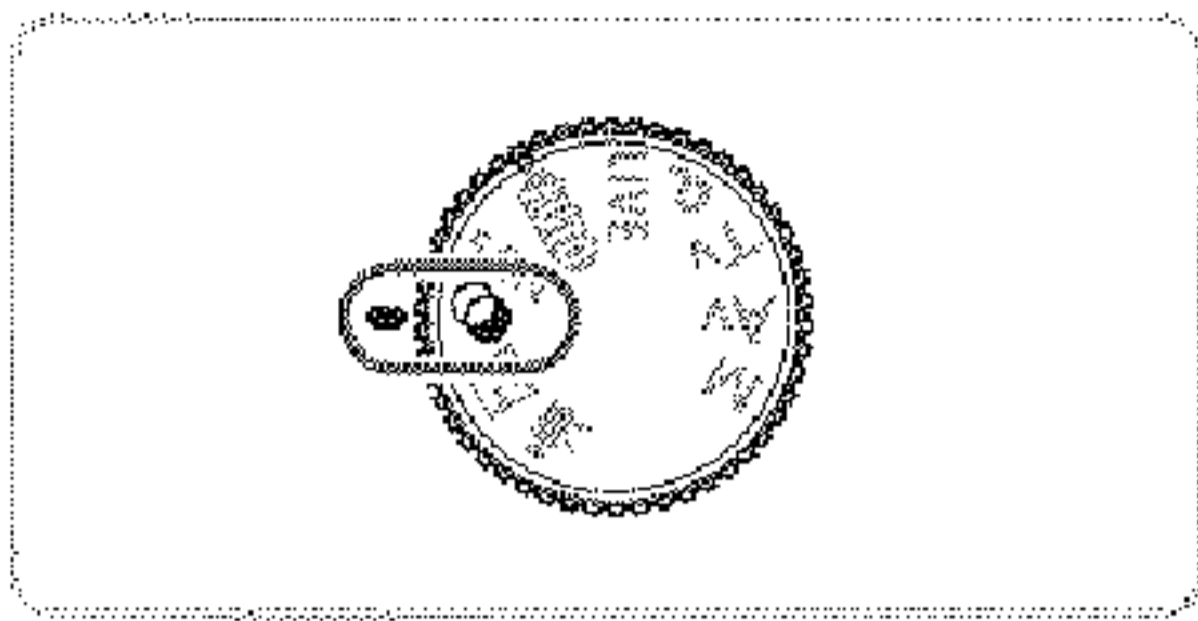

1 Enter mode.

- Set the mode dial to .

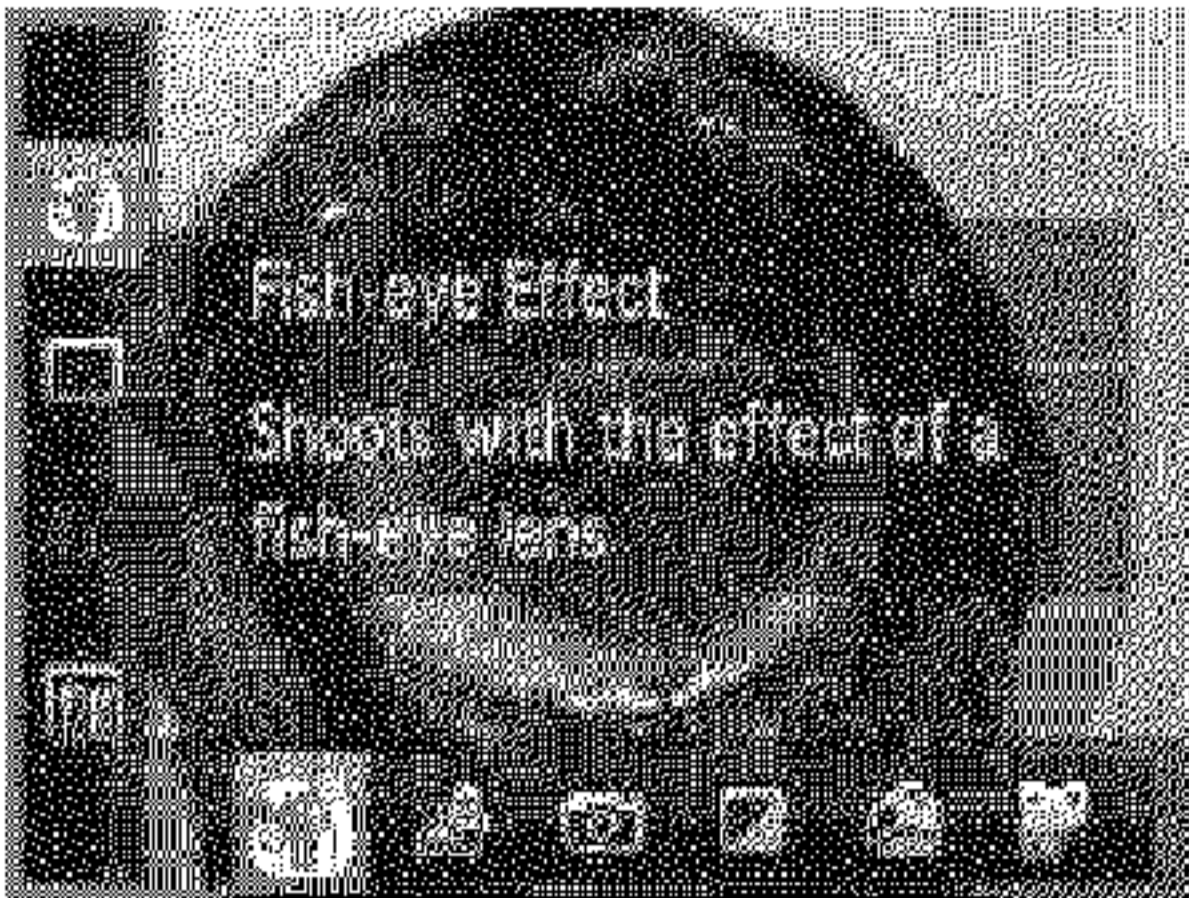

2 Choose a shooting mode.

- Press the button, choose [] in the menu, and then choose a shooting mode (book 46).

3 Shoot.

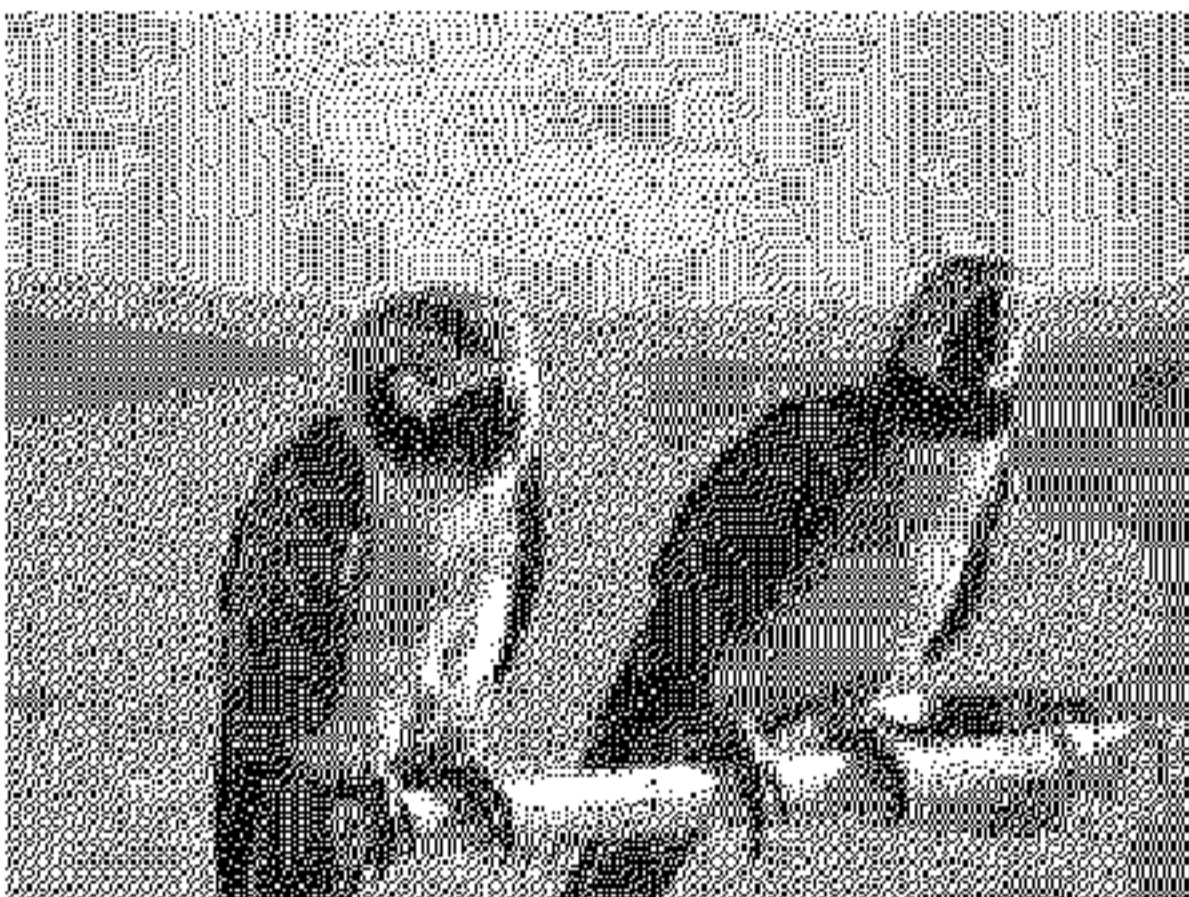

Still Images

Movies

Shoot in vivid colors (Super Vivid)

- Shots in rich, vivid colors.



Still Images

Movies

Posterized shots (Poster Effect)

- Shots that resemble an old poster or illustration.



- In [] and [] modes, try taking some test shots first, to make sure you obtain the desired results.

Shooting with a Fish-Eye Lens Effect (Fish-eye Effect)

Shoot with the distorting effect of a fish-eye lens.

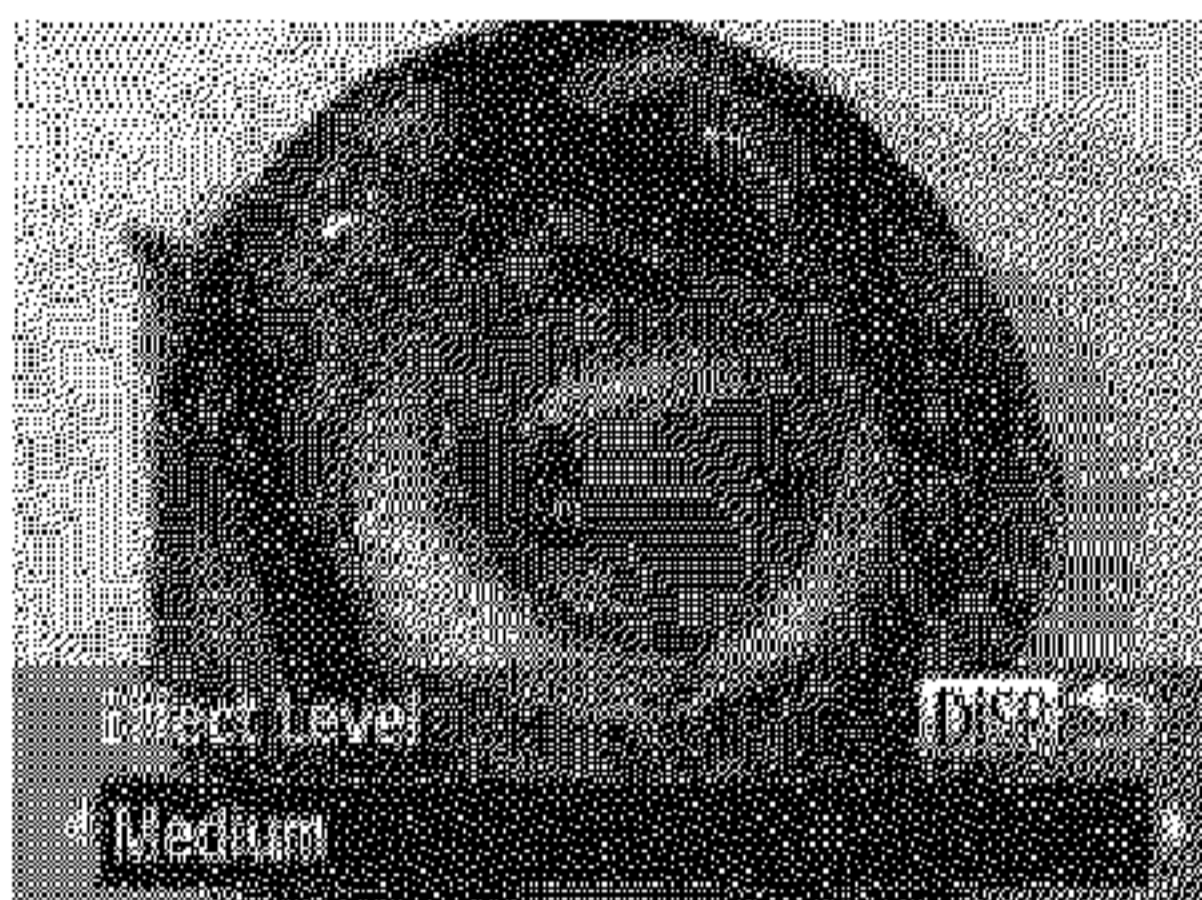

1 Choose [📷].

- Follow steps 1 – 2 on 82 and choose [📷].

2 Choose an effect level.

- Press the <DISP.> button, choose an effect level (either press the <◀><▶> buttons or turn the <⚙️> dial), and then press the <DISP.> button again.
- ▶ A preview is shown of how your shot will look with the effect applied.

3 Shoot.



- Try taking some test shots first, to make sure you obtain the desired results.

Shots Resembling Miniature Models (Miniature Effect)

Creates the effect of a miniature model, by blurring image areas above and below your selected area.

You can also make movies that look like scenes in miniature models by choosing the playback speed before the movie is recorded. People and objects in the scene will move quickly during playback. Note that sound is not recorded.

1 Choose [📷].

- Follow steps 1 – 2 on 82 and choose [📷].
- ▶ A white frame is displayed, indicating the image area that will not be blurred.



2 Choose the area to keep in focus.

- Press the <DISP.> button.
- Move the zoom lever to resize the frame, and press the <▲><▼> buttons to move it.



3 For movies, choose the movie playback speed.

- Press the <MENU> button, and then choose the speed by pressing the <◀><▶> buttons or turning the <⚙> dial.

4 Return to the shooting screen and shoot.

- Press the <MENU> button to return to the shooting screen, and then shoot.

■ Playback Speed and Estimated Playback Time (for One-Minute Clips)

Speed	Playback Time
5x	Approx. 12 sec.
10x	Approx. 6 sec.
20x	Approx. 3 sec.



- The zoom is not available when shooting movies. Be sure to set the zoom before shooting.
- Try taking some test shots first, to make sure you obtain the desired results.



- * To switch the orientation of the frame (from horizontal to vertical or vice-versa), press the **<FUNC SET>** button in step 2. You can move the frame in vertical orientation by pressing the **<◀><▶>** buttons.
- * Holding the camera vertically will change the orientation of the frame.
- * Movie image quality is **[640]** at an aspect ratio of **[4:3]** and **[1280]** at an aspect ratio of **[16:9]** (📖67). These quality settings cannot be changed.
- * The zoom factor cannot be changed with the **<◻>** button on the screens in steps 2 and 3, or while shooting movies.

Still Images

Shooting with a Toy Camera Effect (Toy Camera Effect)

This effect makes images resemble shots from a toy camera by vignetting (darker, blurred image corners) and changing the overall color.

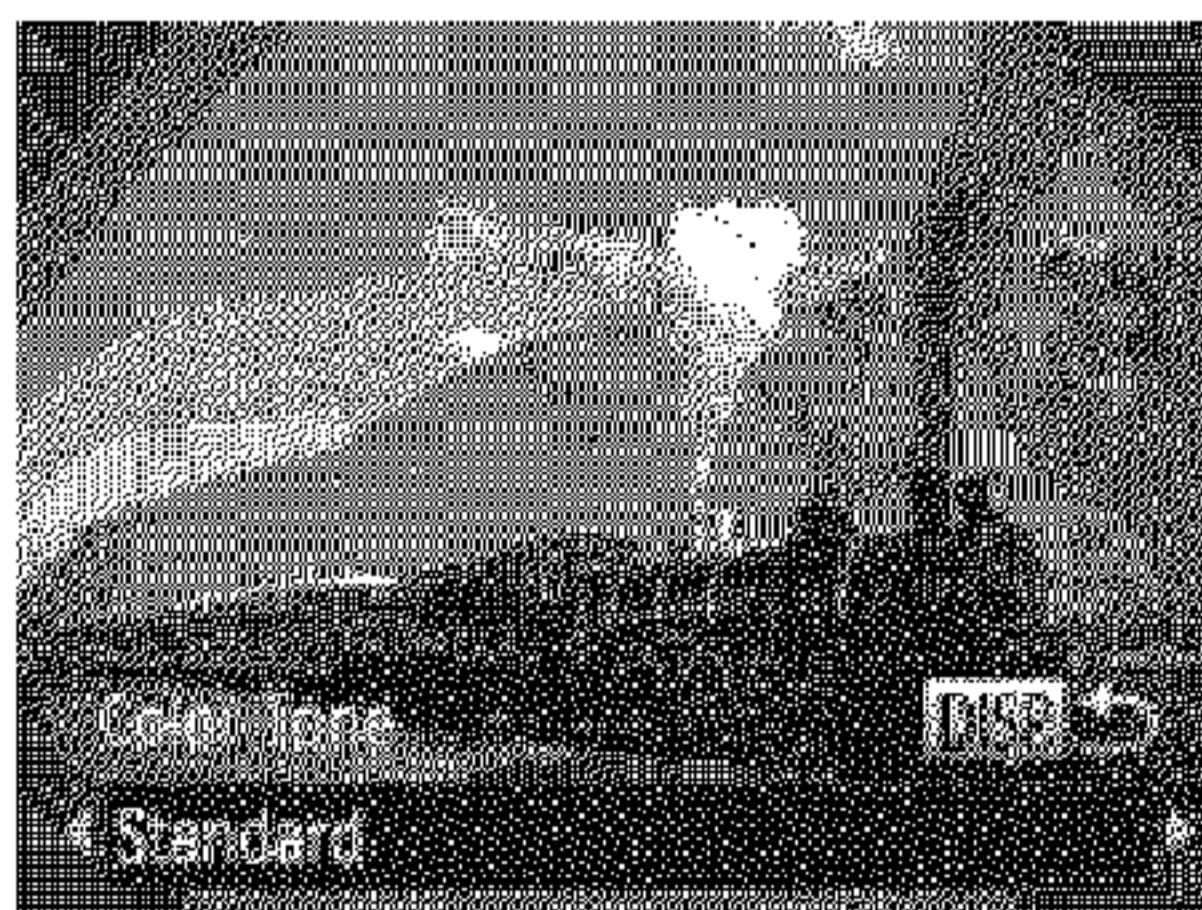

1 Choose [📷].

- Follow steps 1 – 2 on 📖82 and choose [📷].

2 Choose a color tone.

- Press the **<DISP.>** button, choose a color tone (either press the **<◀><▶>** buttons or turn the **<🕒>** dial), and then press the **<DISP.>** button again.
- ▶ A preview is shown of how your shot will look with the effect applied.

3 Shoot.

Standard	Shots resemble toy camera images.
Warm	Images have a warmer tone than with [Standard].
Cool	Images have a cooler tone than with [Standard].





- * Try taking some test shots first, to make sure you obtain the desired results.

Shooting in Monochrome

Shoot images in black and white, sepia, or blue and white.



1 Choose [].

- Follow steps 1 – 2 on  82 and choose [].

2 Choose a color tone.

- Press the <DISP.> button, choose a color tone (either press the <◀><▶> buttons or turn the < > dial), and then press the <DISP.> button again.
- ▶ A preview is shown of how your shot will look with the effect applied.

3 Shoot.

B/W	Black and white shots.
Sepia	Sepia tone shots.
Blue	Blue and white shots.

Using the Face Self-Timer

The camera will shoot about two seconds after detecting that the face of another person (such as the photographer) has entered the shooting area (📖 106). This is useful when including yourself in group photos or similar shots.



1 Choose [👤].

- Follow steps 1 – 2 on 📖 80 and choose [👤].

2 Compose the shot and press the shutter button halfway.

- Make sure a green frame is displayed around the face you focus on and white frames around other faces.

3 Press the shutter button all the way down.

- ▶ The camera now enters shooting standby mode, and [Look straight at camera to start count down] is displayed.
- ▶ The lamp blinks and the self-timer sound is played.

4 Join the subjects in the shooting area and look at the camera.

- ▶ After the camera detects a new face, the lamp blinking and self-timer sound will speed up. (When the flash fires, the lamp will remain lit.) About two seconds later, the camera will shoot.
- To cancel shooting after you have triggered the self-timer, press the <MENU> button.

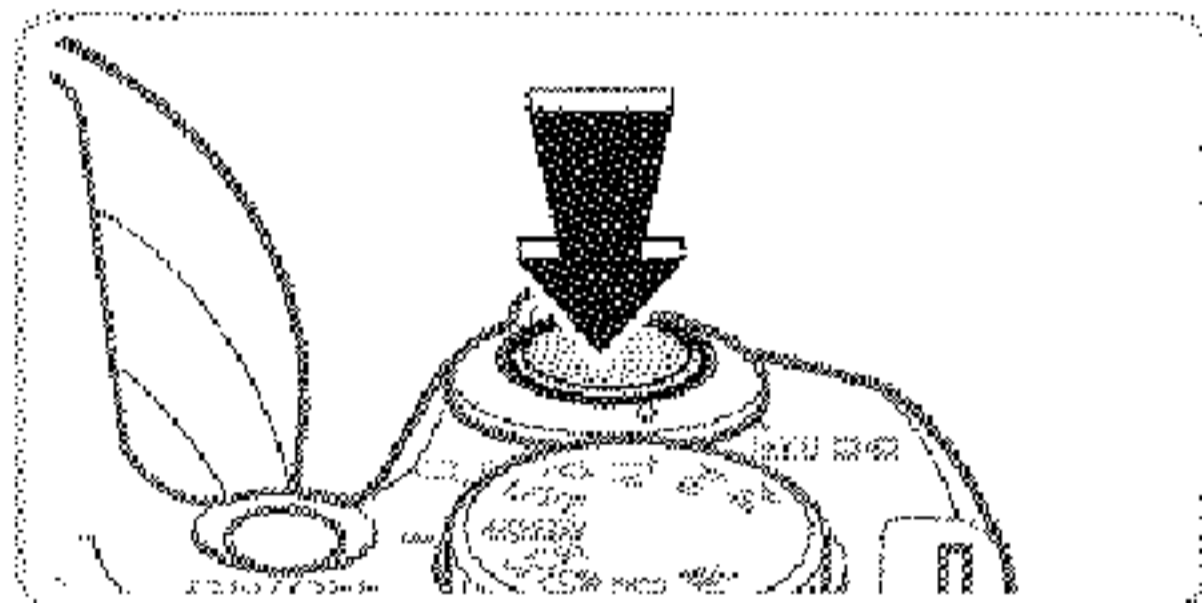



- Even if your face is not detected after you join the others in the shooting area, the camera will shoot about 15 seconds later.
- To change the number of shots, after choosing [] in steps 1 – 2 on 80, press the <DISP.> button, and then either press the <◀><▶> buttons or turn the <◉> dial to choose a value, and then press the <DISP.> button again.
- The zoom factor cannot be changed with the <◻> button after you press the shutter button all the way down.

Movies

Shooting Various Movies

Movies

Shooting Movies in <▶◻> Mode

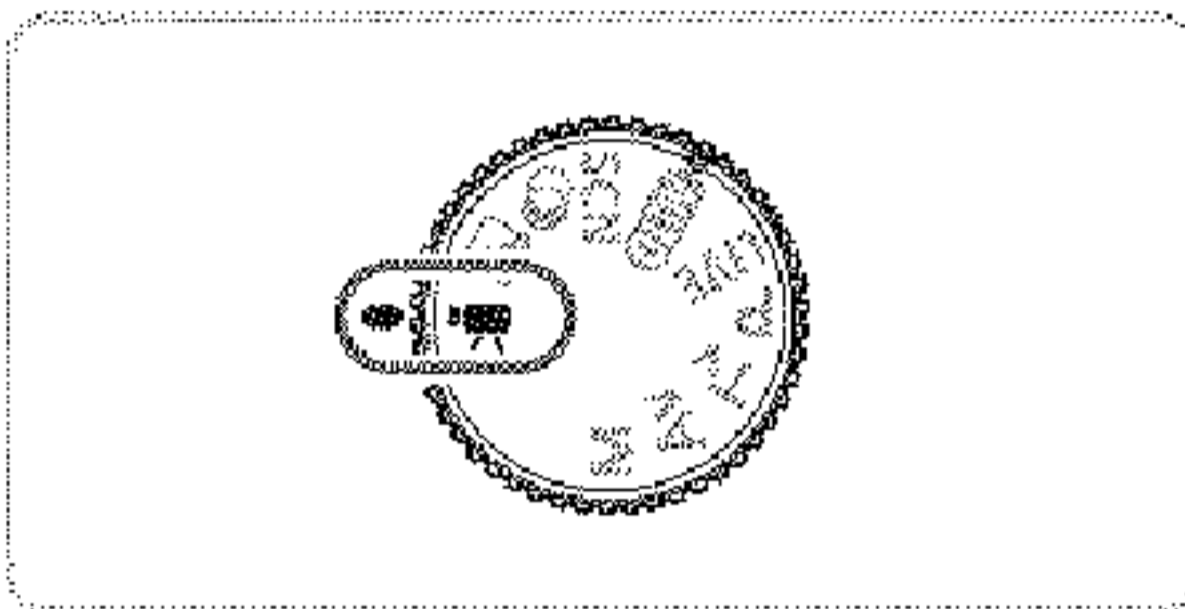

- 1 **Enter <▶◻> mode.**
 - Set the mode dial to <▶◻>.
 - ▶ Black bars displayed on the top and bottom edges of the screen indicate image areas not recorded.
- 2 **Configure the settings to suit the movie (206 – 213).**
- 3 **Shoot.**
 - Press the movie button.
 - To stop movie recording, press the movie button again.

Locking or Changing Image Brightness Before Shooting

Before shooting, you can lock the exposure or change it in 1/3-stop increments within a range of -2 to +2.



1 Lock the exposure.

- Press the <▲> button to lock the exposure. The exposure shift bar is displayed.
- To unlock the exposure, press the <▲> button again.

2 Adjust the exposure.

- Turn the <⊙> dial to adjust the exposure, as you watch the screen.

3 Shoot (📖 88).

Shooting iFrame Movies

Shoot movies that can be edited with iFrame-compatible software or devices. You can quickly edit, save, and manage iFrame movies using the included software (📖 31).

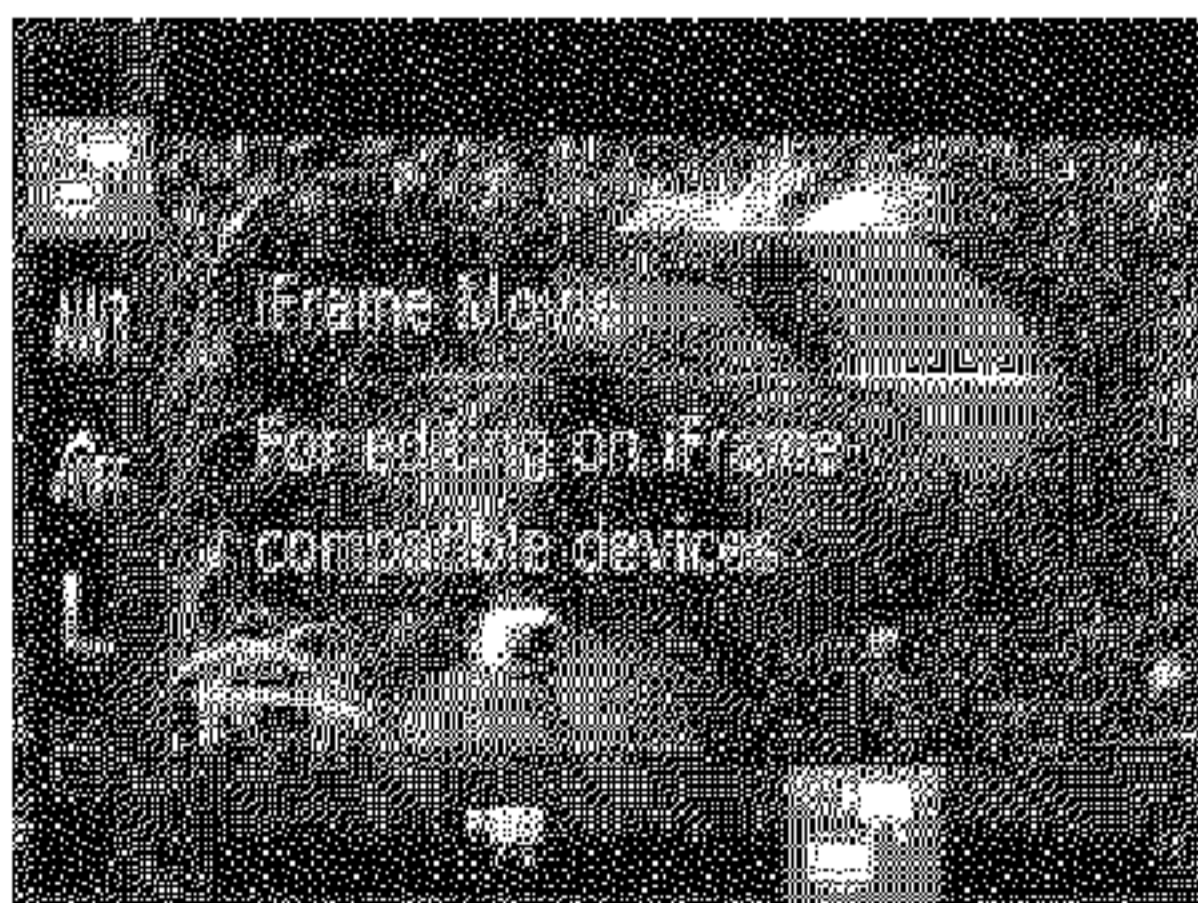

1 Choose [📺].

- Set the mode dial to <📺>.
- Press the <FUNC SET> button, choose [📺] in the menu, and then choose [📺] (📖 46).
- ▶ Black bars displayed on the top and bottom edges of the screen indicate image areas not recorded.

2 Shoot (📖 88).



- * The resolution is [1280] (📖 70) and cannot be changed.
- * iFrame is a video format developed by Apple.

4

P mode

More discerning shots, in your preferred shooting style

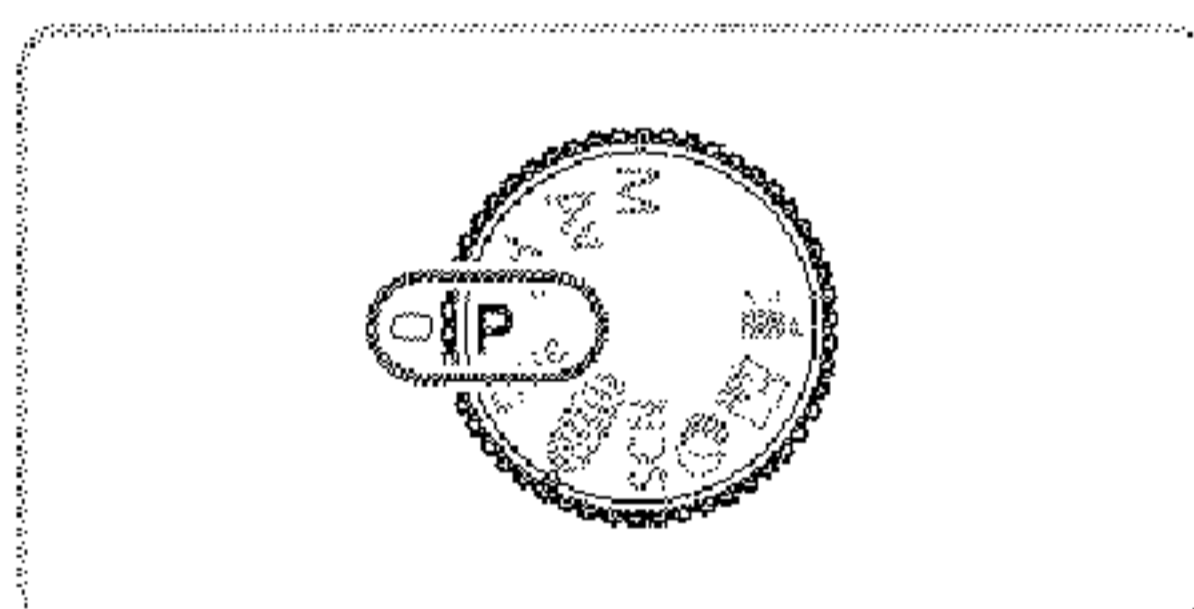

- Instructions in this chapter apply to the camera with the mode dial set to **<P>** mode.
- **<P>**: Program AE; AE: Auto Exposure
- Before using a function introduced in this chapter in modes other than **<P>**, make sure the function is available in that mode (📖 206 – 213).

Shooting in Program AE Mode (<P> Mode)

You can customize many function settings to suit your preferred shooting style.

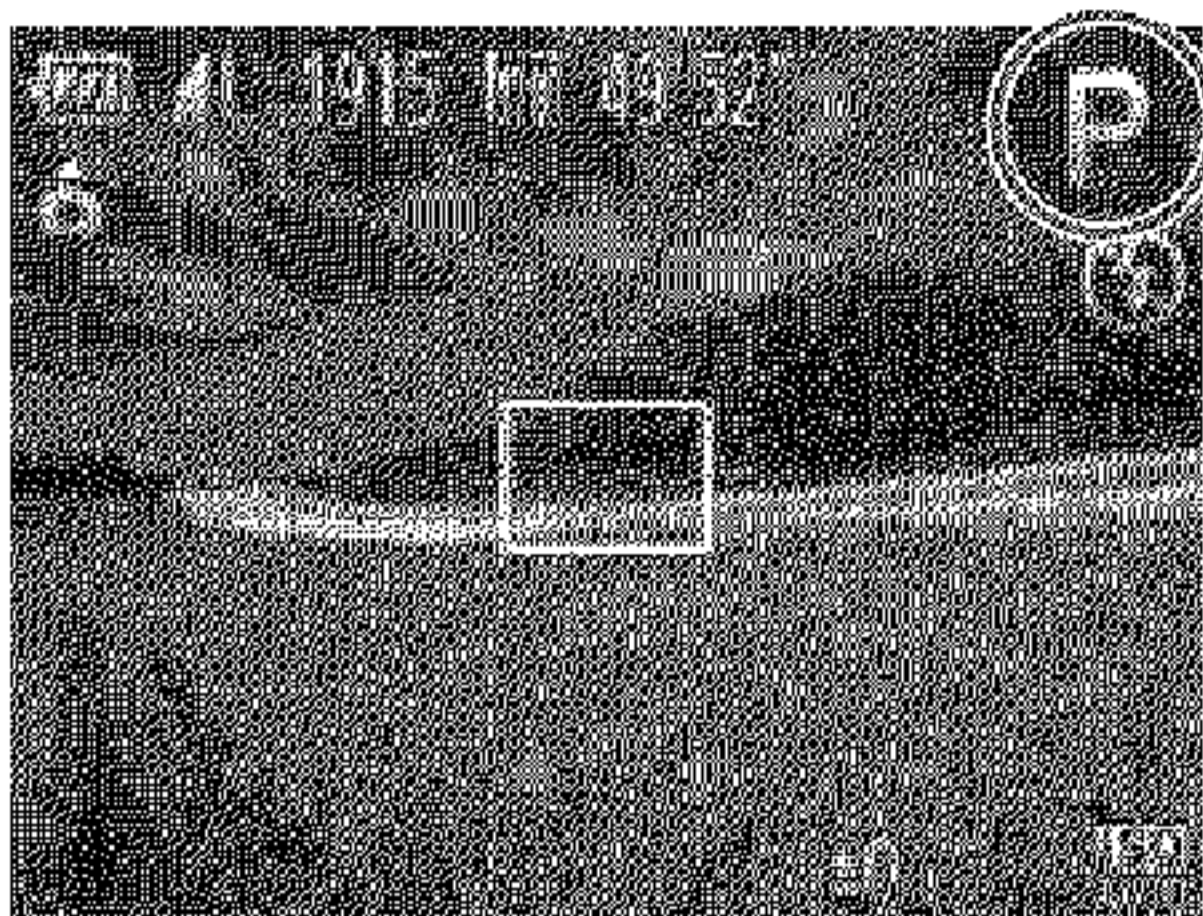

- 1 Enter <P> mode.
 - Set the mode dial to <P>.

- 2 Customize the settings as desired (📖 93 – 114), and then shoot.



- If adequate exposure cannot be obtained when you press the shutter button halfway, shutter speeds and aperture values are displayed in orange. To obtain adequate exposure, try adjusting the following settings.
 - Activate the flash (📖 111)
 - Change the ISO speed (📖 96)
- Movies can be recorded in <P> mode as well, by pressing the movie button. However, some FUNC. (📖 46) and Menu (📖 47) settings may be automatically adjusted for movie recording.
- For details on the shooting range in <P> mode, see “Specifications” (📖 217).



Image Brightness (Exposure Compensation)

Still Images

Adjusting Image Brightness (Exposure Compensation)

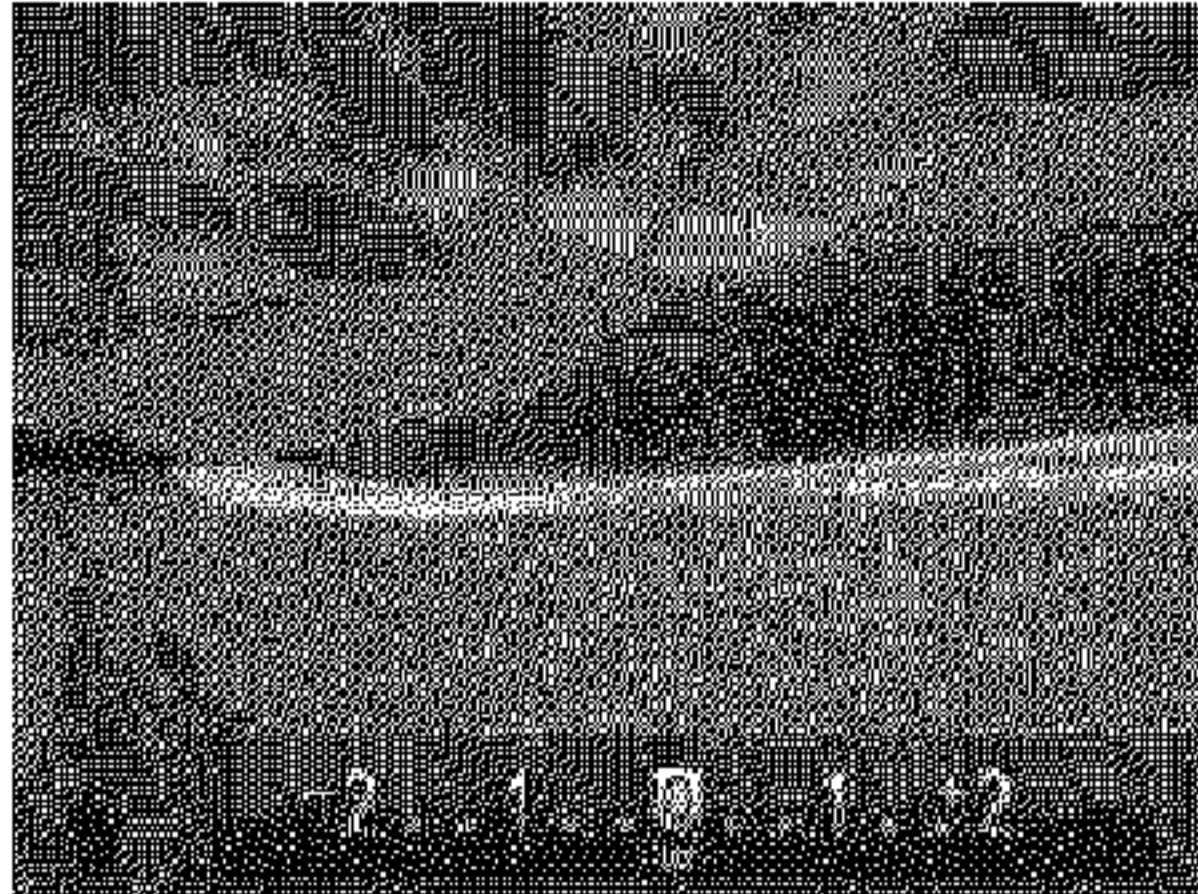
The standard exposure set by the camera can be adjusted in 1/3-stop increments, in a range of -2 to +2.





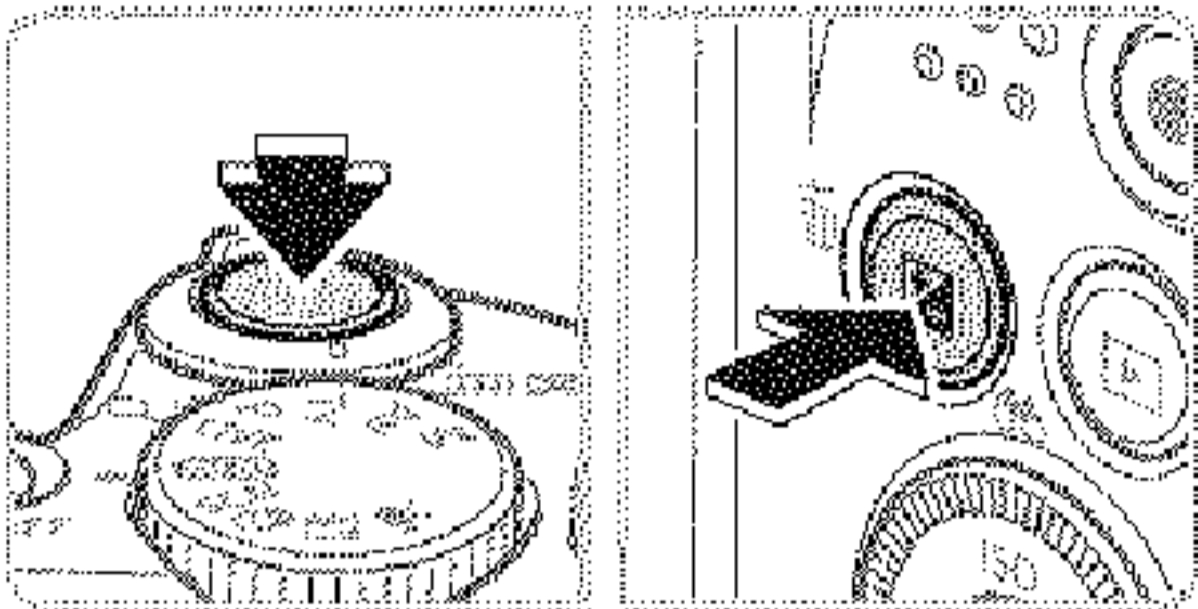

- Press the  button. As you watch the screen, turn the  dial to adjust brightness, and then press the  button again when finished.
- ▶ The correction level you specified is now displayed.

Locking Image Brightness/Exposure (AE Lock)

Before shooting, you can lock the exposure, or you can specify focus and exposure separately.



1 Lock the exposure.

- Aim the camera at the subject to shoot with the exposure locked. With the shutter button pressed halfway, press the  button.
- ▶ [] is displayed, and the exposure is locked.
- To unlock AE, release the shutter button and press the  button again. In this case, [] is no longer displayed.

2 Compose the shot and shoot.

- After one shot, AE is unlocked and [] is no longer displayed.



- * AE: Auto Exposure
- * After the exposure is locked, you can adjust the combination of shutter speed and aperture value by turning the  dial (Program Shift).

Changing the Metering Method

Adjust the metering method (how brightness is measured) to suit shooting conditions as follows.



- Press the <FUNC/SET> button, choose [] in the menu, and choose the desired option (46).
- ▶ The option you configured is now displayed.

<input checked="" type="checkbox"/> Evaluative	For typical shooting conditions, including backlit shots. Automatically adjusts exposure to match the shooting conditions.
<input type="checkbox"/> Center Weighted Avg.	Determines the average brightness of light across the entire image area, calculated by treating brightness in the central area as more important.
<input type="checkbox"/> Spot	Metering restricted to within the [] (Spot AE Point frame), displayed in the center of the screen.

Changing the ISO Speed

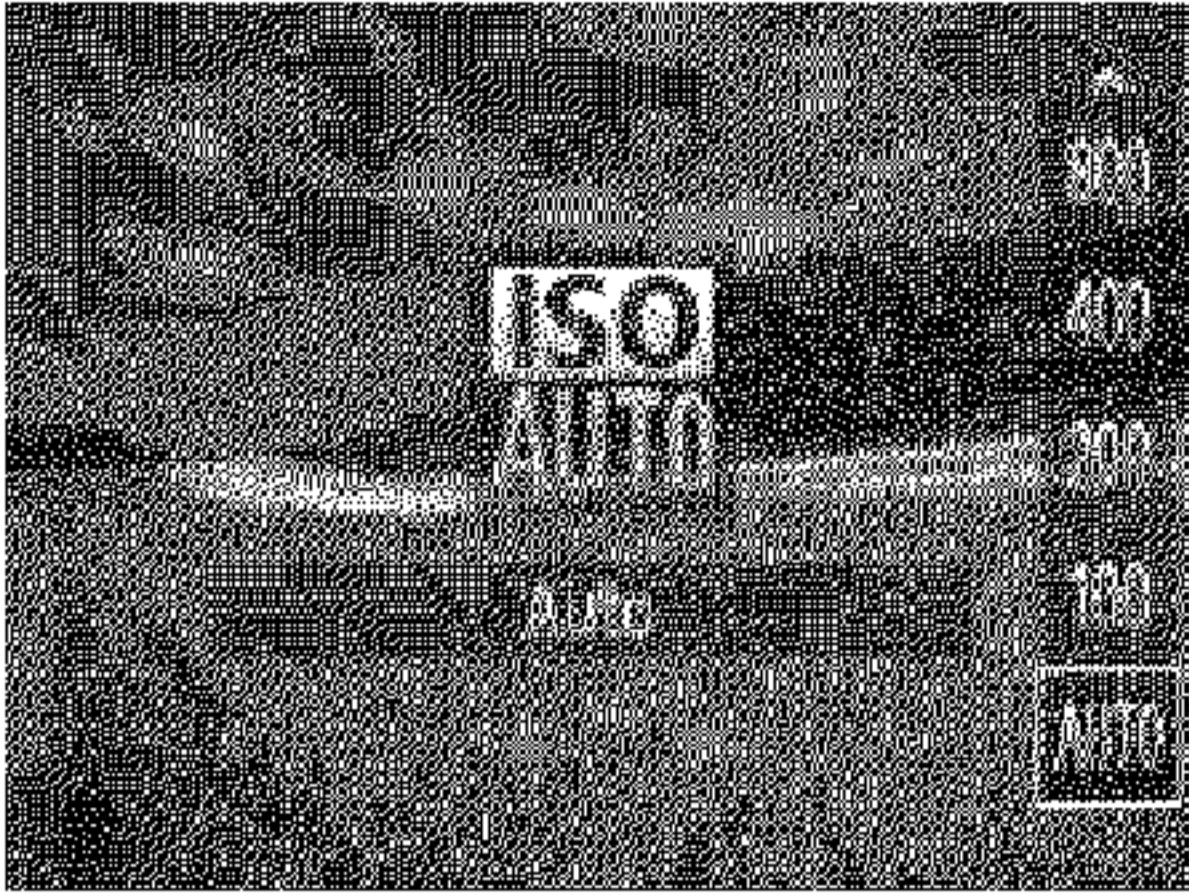

- Press the <▲> button, choose an option (either press the <▲><▼> buttons or turn the <⊙> dial), and then press the <FUNC. SET> button.
- ▶ The option you configured is now displayed.

	Automatically adjusts the ISO speed to suit the shooting mode and conditions.	
	Low	For shooting outdoors in fair weather.
	↑ ↓	For shooting in cloudy conditions, or at twilight.
	High	For shooting night scenes, or in dark rooms.



- To view the automatically set ISO speed when the camera is set to , press the shutter button halfway.
- Although choosing a lower ISO speed may reduce image graininess, there may be a greater risk of subject blurriness in some shooting conditions.
- Choosing a higher ISO speed will increase shutter speed, which may reduce subject blurriness and increase the flash range. However, shots may look grainy.

Correcting Image Brightness (i-Contrast)

Before shooting, excessively bright or dark image areas (such as faces or backgrounds) can be detected and automatically adjusted to the optimal brightness. Insufficient overall image contrast can also be automatically corrected before shooting to make subjects stand out better.

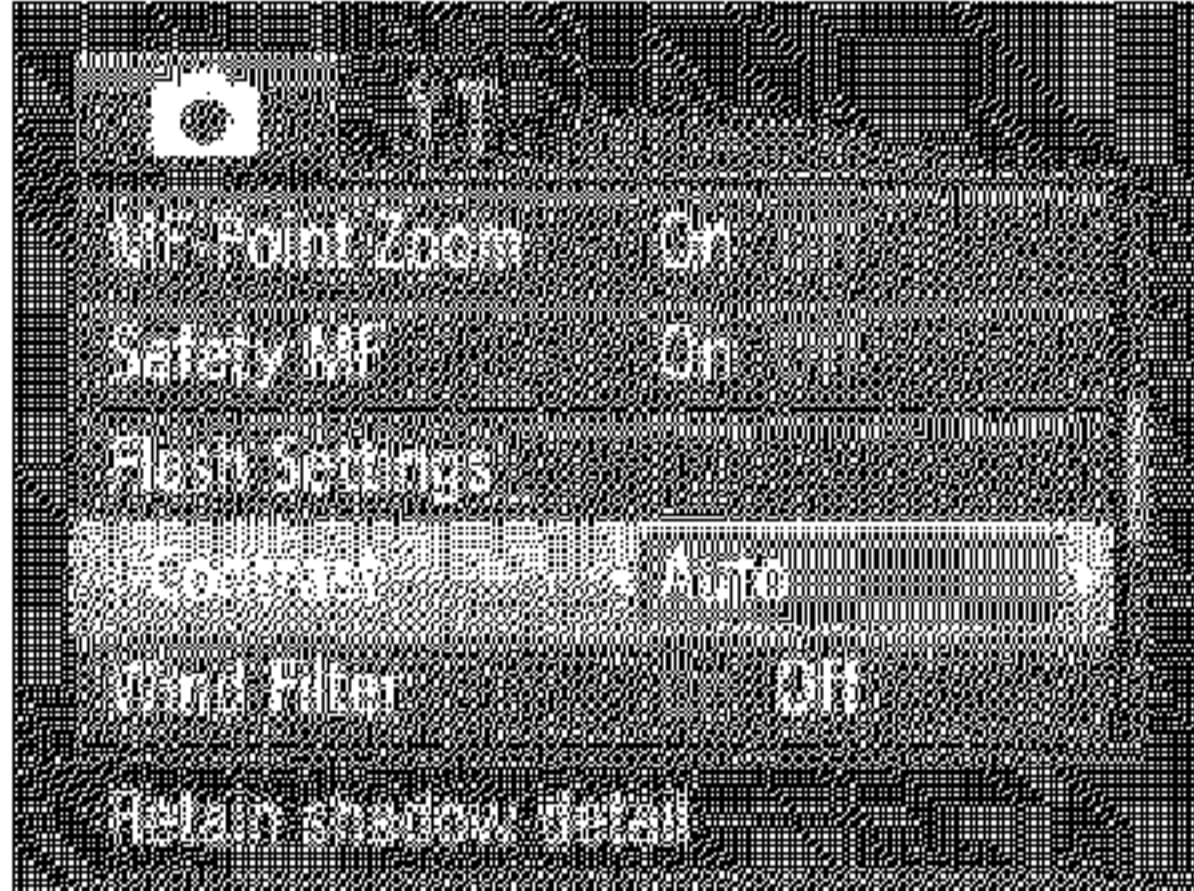

- Press the <MENU> button, choose [i-Contrast] on the [CAMERA] tab, and then choose [Auto] (📖47).
- ▶ Once the setting is complete, [C_i] is displayed.



- * Under some shooting conditions, correction may be inaccurate or may cause images to appear grainy.













- * You can also correct existing images (📖150).

Adjusting White Balance

By adjusting white balance (WB), you can make image colors look more natural for the scene you are shooting.



- Press the  button, choose [AWB] in the menu, and choose the desired option ( 46).
- ▶ The option you configured is now displayed.

 Auto	Automatically sets the optimal white balance for the shooting conditions.
 Day Light	For shooting outdoors in fair weather.
 Cloudy	For shooting in cloudy conditions, in the shade, or at twilight.
 Tungsten	For shooting under ordinary incandescent (tungsten) lighting and similarly colored fluorescent lighting.
 Fluorescent	For shooting under warm-white (or similarly colored) or cool-white fluorescent lighting.
 Fluorescent H	For shooting under daylight fluorescent and similarly colored fluorescent lighting.
 Custom	For manually setting a custom white balance ( 99).

■ Custom White Balance

For image colors that look natural under the light in your shot, adjust white balance to suit the light source where you are shooting. Set the white balance under the same light source that will illuminate your shot.

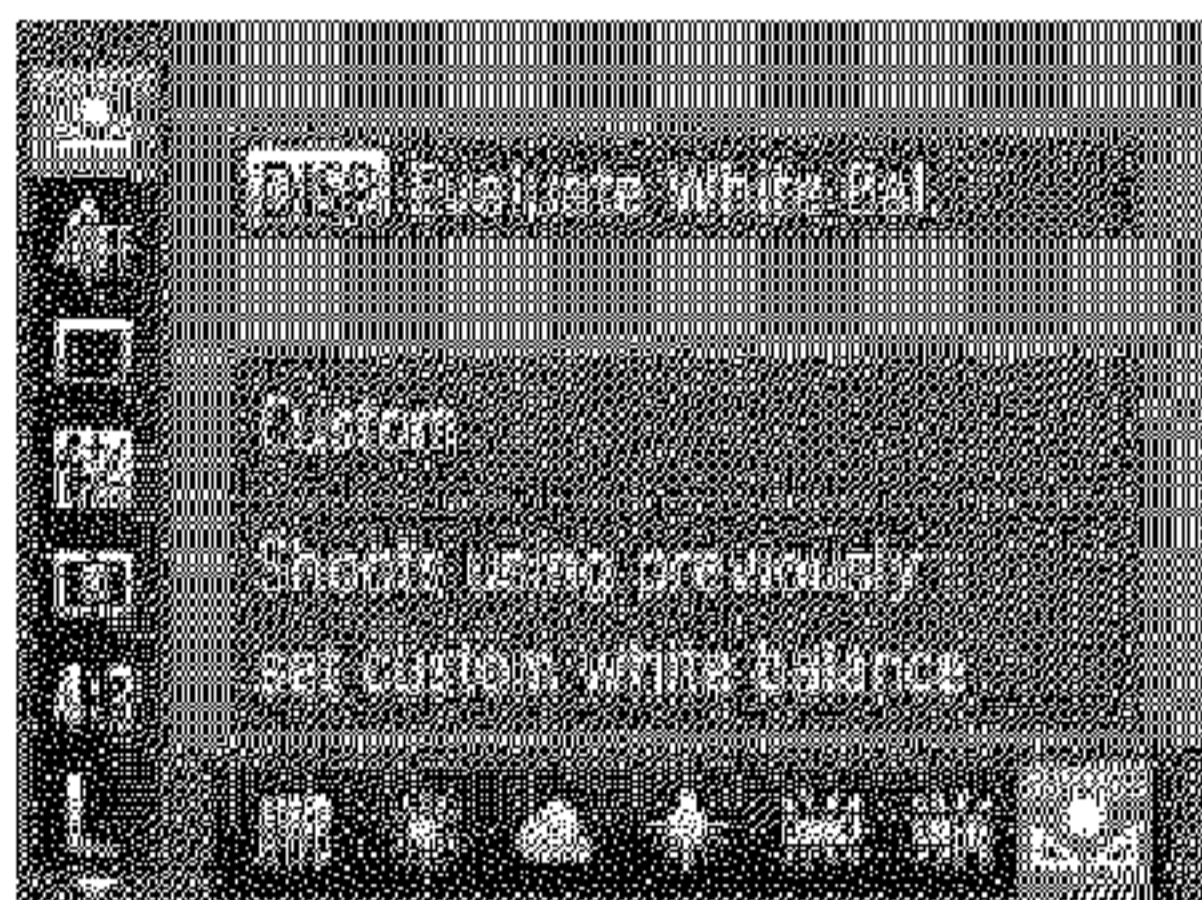

- Follow the steps on 98 to choose .
- Aim the camera at a plain white subject, so that the entire screen is white. Press the <DISP.> button.
- ▶ The tint of the screen changes once the white balance data has been recorded.









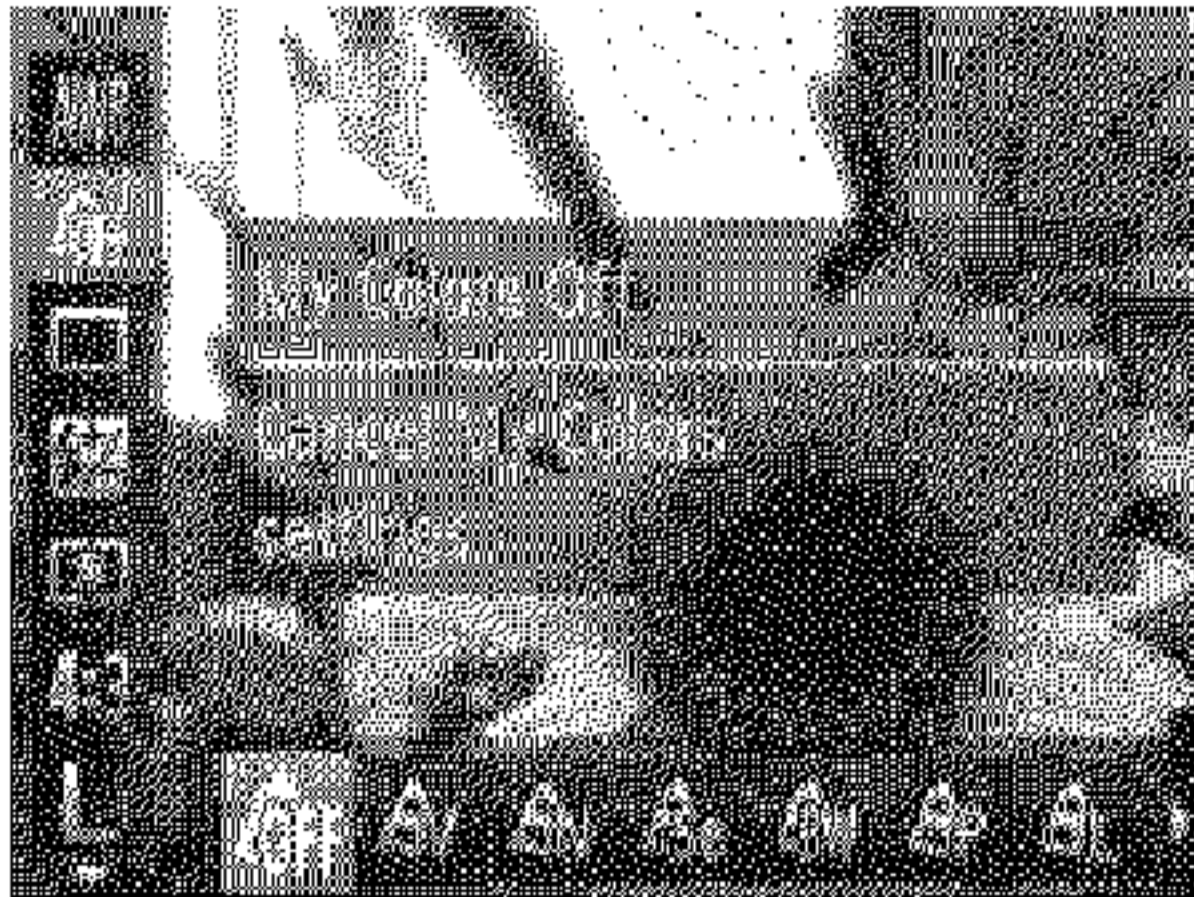







- * Colors may look unnatural if you change camera settings after recording white balance data.

Changing Image Color Tones (My Colors)

Change image color tones as desired, such as converting images to sepia or black and white.



- Press the  button, choose [OFF] in the menu, and choose the desired option ( 46).
- ▶ The option you configured is now displayed.

 My Colors Off	—
 Vivid	Emphasizes contrast and color saturation, making images sharper.
 Neutral	Tones down contrast and color saturation for subdued images.
 Sepia	Creates sepia tone images.
 B/W	Creates black and white images.
 Positive Film	Combines the effects of Vivid Blue, Vivid Green, and Vivid Red to produce intense yet natural-looking colors resembling images on positive film.
 Lighter Skin Tone	Lightens skin tones.
 Darker Skin Tone	Darkens skin tones.
 Vivid Blue	Emphasizes blues in images. Makes the sky, ocean, and other blue subjects more vivid.
 Vivid Green	Emphasizes greens in images. Makes mountains, foliage, and other green subjects more vivid.
 Vivid Red	Emphasizes reds in images. Makes red subjects more vivid.
 Custom Color	Adjust contrast, sharpness, color saturation, and other qualities as desired ( 101).

- ❗ * White balance (📖98) cannot be set in [A_{Se}] or [A_{BW}] modes.
- * With [A_L] and [A_D] modes, colors other than people's skin tone may be modified. These settings may not produce the expected results with some skin tones.

Still Images

Movies

■ Custom Color

Choose the desired level of image contrast, sharpness, color saturation, red, green, blue, and skin tones in a range of 1 – 5.

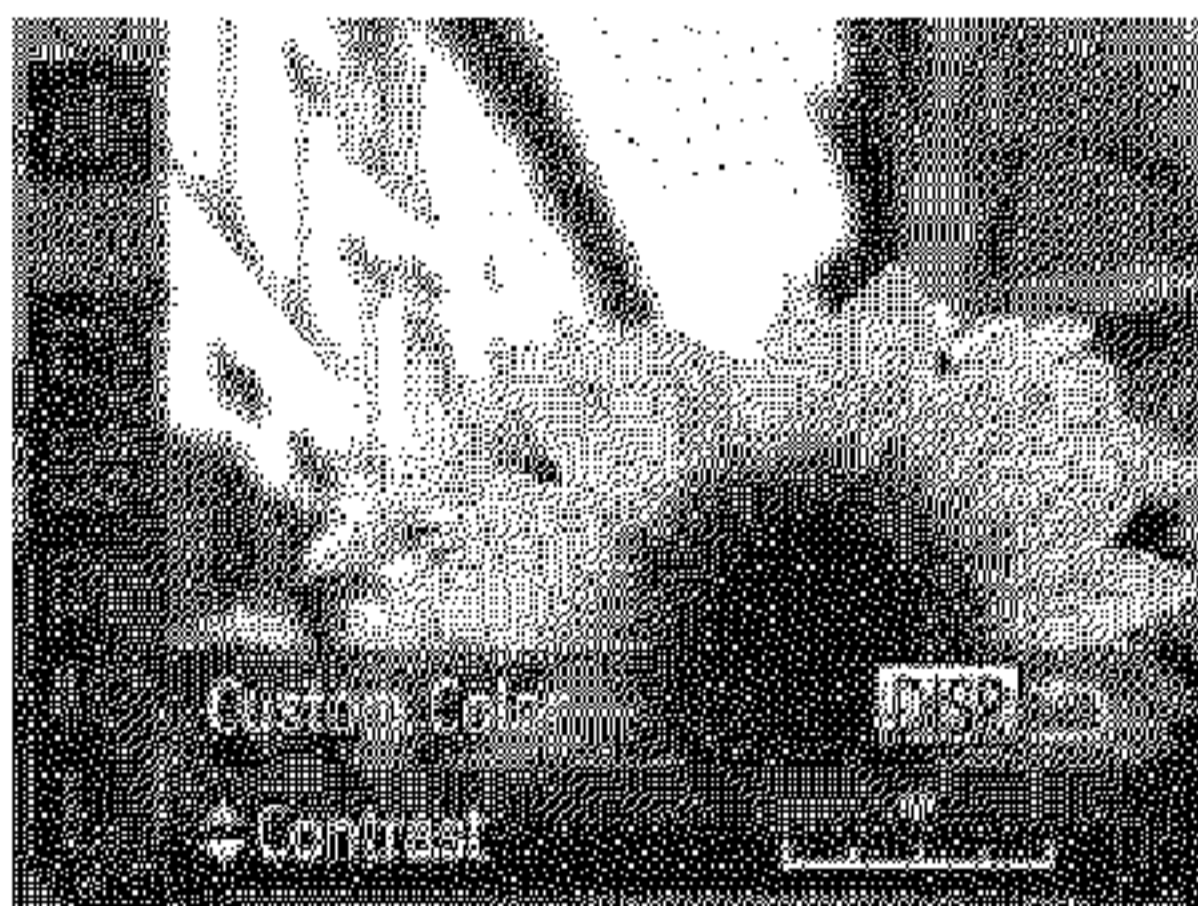

1 Access the setting screen.

- Follow the steps on 📖 100 to choose [A_C], and then press the <DISP.> button.

2 Configure the setting.

- Press the <▲><▼> buttons to choose an option, and then specify the value by pressing the <◀><▶> buttons or turning the <⊙> dial.
- For stronger/more intense effects (or darker skin tones), adjust the value to the right, and for weaker/lighter effects (or lighter skin tones), adjust the value to the left.
- Press the <DISP.> button to complete the setting.

Continuous Shooting

Hold the shutter button all the way down to shoot continuously.

For details on the continuous shooting speed, see “Specifications” (217).

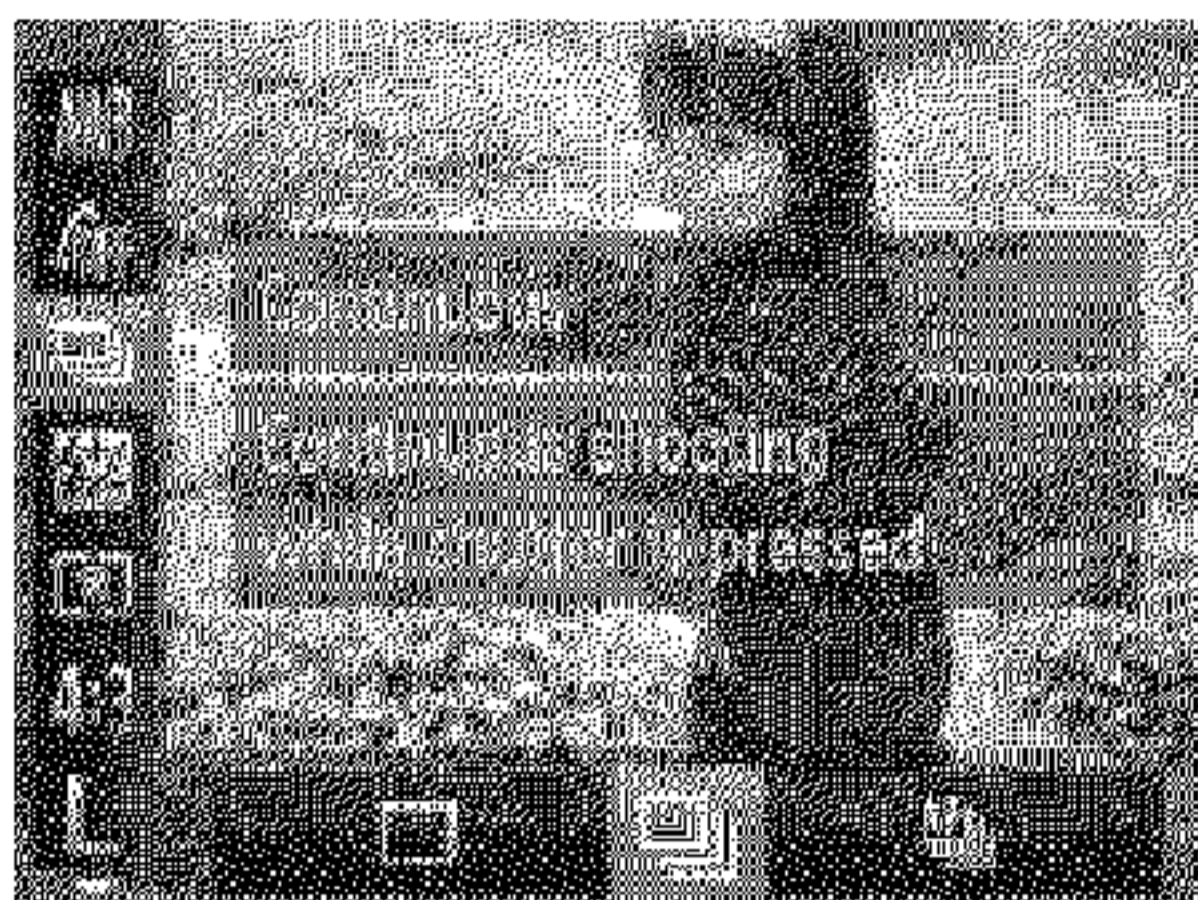



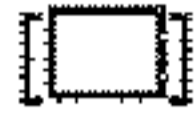



1 Configure the setting.

- Press the <FUNC/SET> button, choose  in the menu, and choose the desired option (46).
- ▶ The option you configured is now displayed.

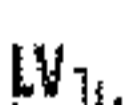
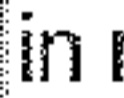
2 Shoot.

- ▶ Hold the shutter button all the way down to shoot continuously.

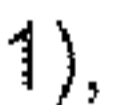
Mode	Description
 Continuous	Continuous shooting, with the focus and exposure determined when you press the shutter button halfway.
 Continuous Shooting AF	Continuous shooting and focusing. [AF Frame] is set to [Center] and cannot be changed.
 Continuous Shooting LV*	Continuous shooting, with the focus fixed at the position determined in manual focusing. In  mode, focus is determined by the first shot.

* In  mode (81), AF lock (110), or manual focus mode (103),  is changed to .

* For details on the continuous shooting speed in each mode, see, “Specifications” (217).



- Cannot be used with the self-timer (62) or [Blink Detection] (74).
- Shooting may stop momentarily or continuous shooting may slow down depending on shooting conditions, camera settings, and the zoom position.
- As more shots are taken, shooting may slow down.
- Shooting may slow down if the flash fires.



- Continuous shooting is faster in  mode (80).

Shooting Close-ups (Macro)

To restrict the focus to subjects at close range, set the camera to [🌸]. For details on the focusing range, see “Specifications” (📖217).



- Press the <◀> button, choose [🌸] (either press the <◀><▶> buttons or turn the <⚙️> dial), and then press the <FUNC SET> button.
- ▶ Once the setting is complete, [🌸] is displayed.



• In the yellow bar display area below the zoom bar, [🌸] will turn gray and the camera will not focus.



• To prevent camera shake, try mounting the camera on a tripod and shooting with the camera set to [🌸] (📖63).

Shooting in Manual Focus Mode

When focusing is not possible in AF mode, use manual focus. You can specify the general focal position and then press the shutter button halfway to have the camera determine the optimal focal position near the position you specified. For details on the focusing range, see “Specifications” (📖217).



Choose [MF].

- Press the <◀> button, choose [MF] (either press the <◀><▶> buttons or turn the <⚙️> dial), and then press the <FUNC SET> button.
- ▶ [MF] and the MF indicator are displayed.



MF Indicator

2 Specify the general focal position.

- Referring to the on-screen MF indicator bar (which shows the distance and focal position) and the magnified display area, press the <▲><▼> buttons or turn the <⚙> dial to specify the general focal position.

3 Fine-tune the focus.

- Press the shutter button halfway to have the camera fine-tune the focal position (Safety MF).



- AF frame mode or size cannot be changed while focusing manually (📖105). If you want to change the AF frame mode or size, cancel manual focus mode first.
- Focusing is possible when using the digital zoom (📖60) or digital tele-converter (📖105), but the magnified display will not appear.



- To focus more accurately, try attaching the camera to a tripod to stabilize it.
- To hide the magnified display area, press the <MENU> button and set [MF-Point Zoom] on the [📷] tab to [Off] (📖47).
- To deactivate automatic focus fine-tuning when the shutter button is pressed halfway, press the <MENU> button and set [Safety MF] on the [📷] tab to [Off] (📖47).

Digital Tele-Converter

The focal length of the lens can be increased by approximately 1.6x or 2.0x. This can reduce camera shake because the shutter speed is faster than it would be if you zoomed (including using digital zoom) in to the same zoom factor.



- Press the <MENU> button, choose [Digital Zoom] on the [CAMERA] tab, and then choose the desired option (📖47).
- ▶ The view is enlarged and the zoom factor is displayed on the screen.



- * The digital tele-converter cannot be used with digital zoom (📖60) and AF-point zoom (📖72).



- * The respective focal lengths when using [1.6x] and [2.0x] are 38.4 – 1152 mm and 48 – 1440 mm (35mm film equivalent).
- * The shutter speed may be equivalent when you move the zoom lever all the way toward <[TELEPHOTO]> for maximum telephoto, and when you zoom in to enlarge the subject to the same size following step 2 on 📖60.

Changing the AF Frame Mode

Change the AF (auto focus) frame mode to suit the shooting conditions as follows.

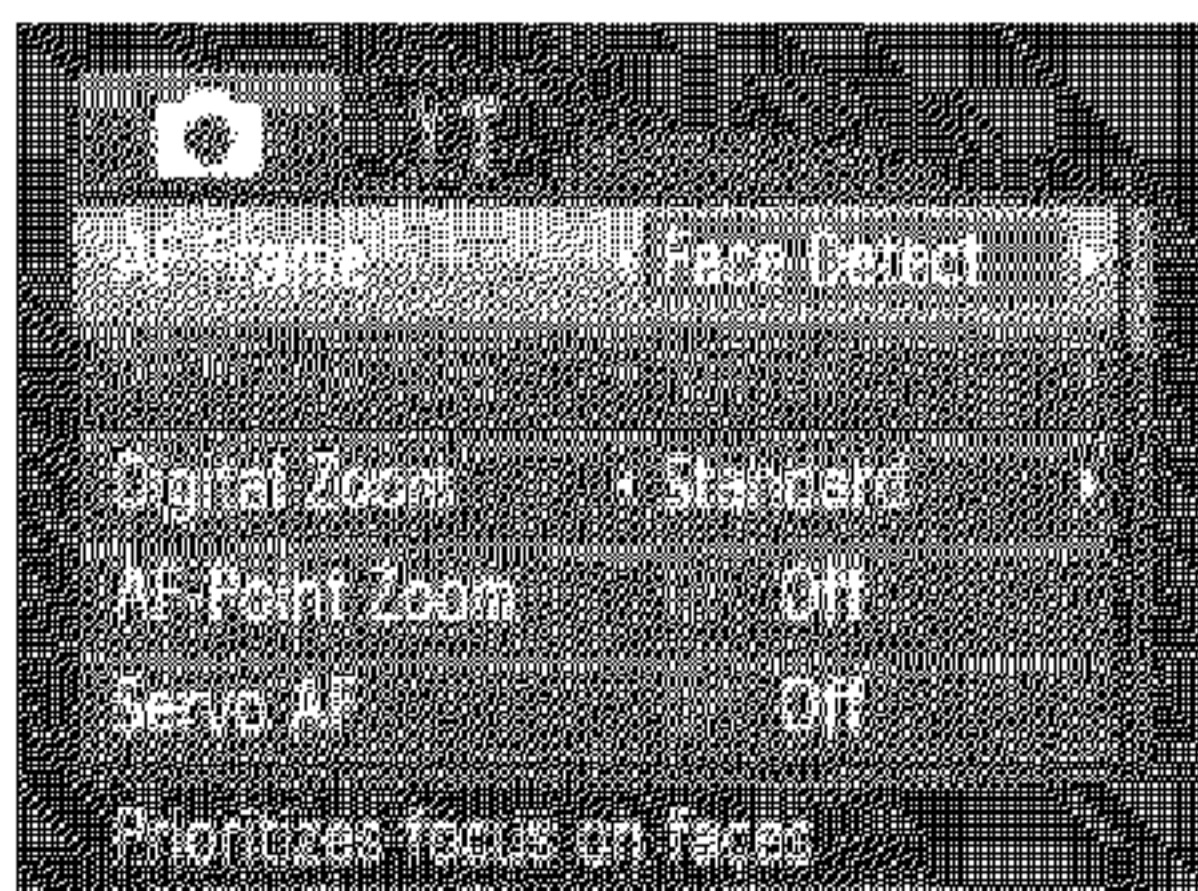

- Press the <MENU> button, choose [AF Frame] on the [CAMERA] tab, and then choose the desired option (📖47).

■ Center

One AF frame is displayed in the center. Effective for reliable focusing.



- A yellow AF frame is displayed with [!] if the camera cannot focus when you press the shutter button halfway. Note that AF-point zooming (72) is not possible.



- To reduce the AF frame size, press the <MENU> button and set [AF Frame Size] on the [📷] tab to [Small] (47).
- The AF frame size is set to [Normal] when you use the digital zoom (60) or digital tele-converter (105), and in manual focus mode (103).
- To compose shots so that subjects are positioned at the edge or in a corner, first aim the camera to capture the subject in an AF frame, and then hold the shutter button halfway down. As you continue to hold the shutter button halfway, recompose the shot as desired, and then press the shutter button all the way down (Focus Lock).

■ Face Detect

- Detects people's faces, and then sets the focus, exposure (evaluative metering only), and white balance ([AWB] only).
- After you aim the camera at the subject, a white frame is displayed around the person's face determined by the camera to be the main subject, and up to two gray frames are displayed around other detected faces.
- When the camera detects movement, frames will follow moving subjects, within a certain range.
- After you press the shutter button halfway, up to nine green frames are displayed around faces in focus.



- * If faces are not detected, or when only gray frames are displayed (without a white frame), an AF frame is displayed in the center of the screen when you press the shutter button halfway.
- * If faces are not detected when Servo AF (📖 109) is set to [On], the AF frame is displayed in the center of the screen when you press the shutter button halfway.
- * Examples of faces that cannot be detected:
 - Subjects that are distant or extremely close
 - Subjects that are dark or light
 - Faces in profile, at an angle, or partly hidden
- * The camera may misinterpret non-human subjects as faces.
- * No AF frames are displayed if the camera cannot focus when you press the shutter button halfway.

Still Images

■ Choosing Subjects to Focus On (Tracking AF)

Shoot after choosing a subject to focus on as follows.

1 Choose [Tracking AF].

- Follow the steps on 📖 105 to choose [Tracking AF].
- ▶ [□] is displayed in the center of the screen.

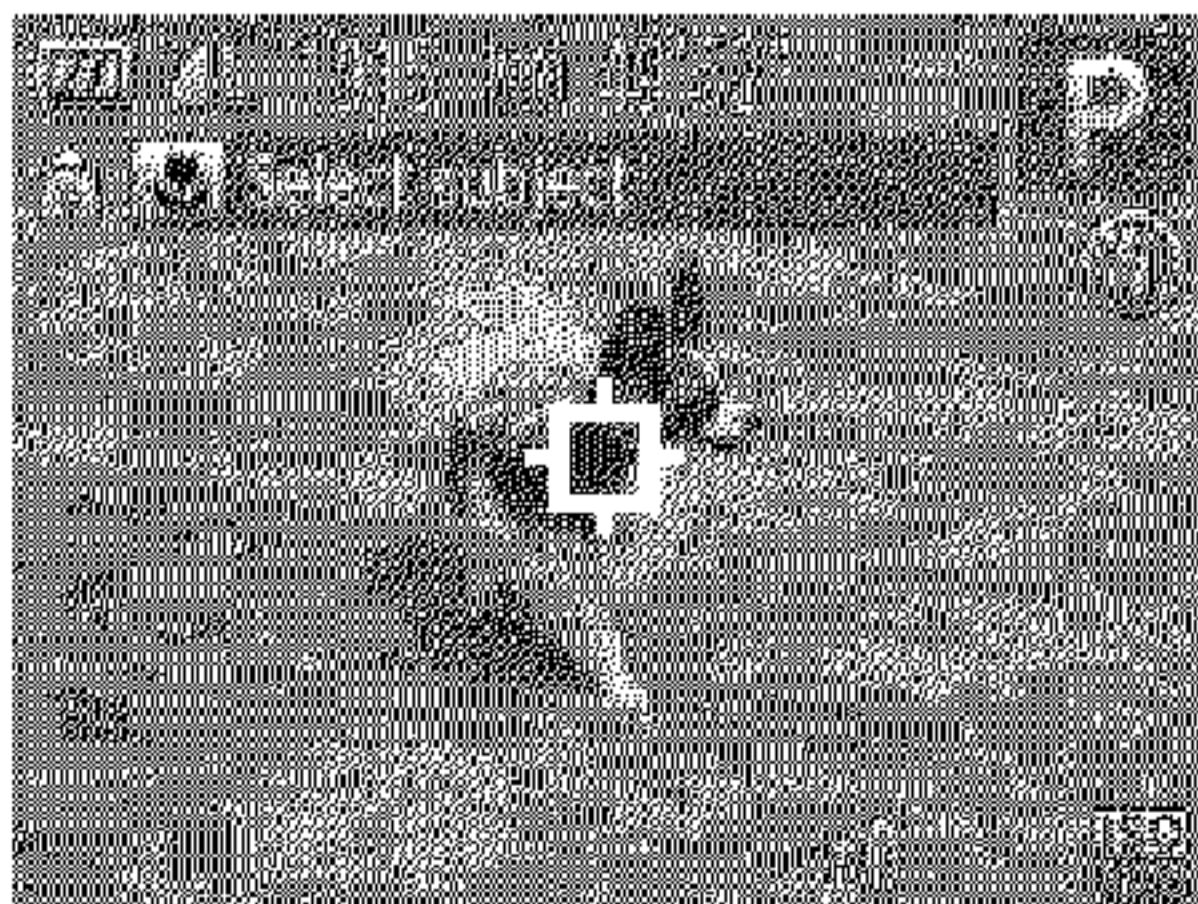

2 Choose a subject to focus on.

- Aim the camera so that [□] is on the desired subject, and then press the <◀▶> button.

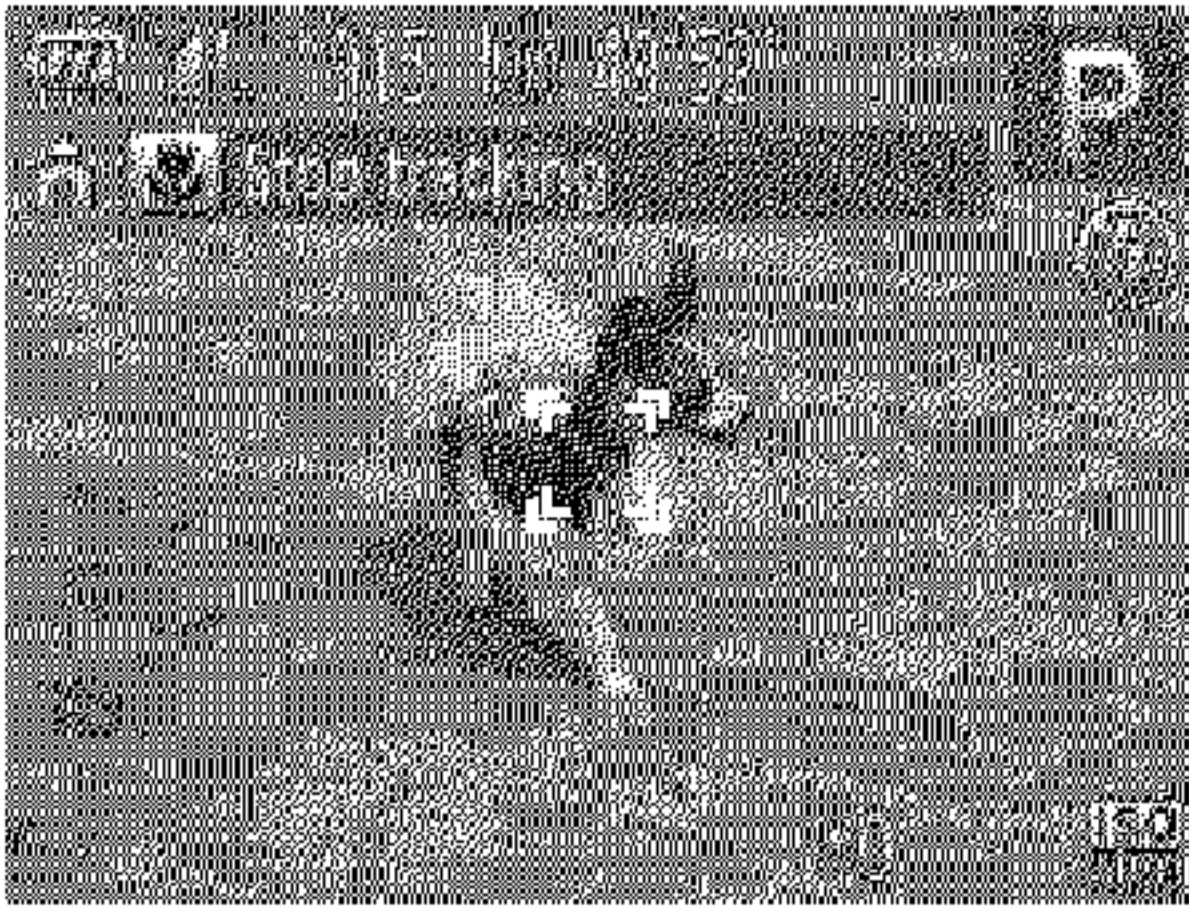

- ▶ When the subject is detected, the camera beeps and [] is displayed. Even if the subject moves, the camera will continue to track the subject within a certain range.
- ▶ If no subject is detected, [] is displayed.
- To cancel tracking, press the <◀> button again.

3 Shoot.

- Press the shutter button halfway. [] changes to a blue [], which follows the subject as the camera continues to adjust the focus and exposure (Servo AF) (📖 109).
- Press the shutter button all the way down to shoot.
- ▶ Even after your shot, [] is still displayed and the camera continues to track the subject.



- [Servo AF] (📖 109) is set to [On] and cannot be changed.
- Tracking may not be possible when subjects are too small or move too rapidly, or when subject color or brightness matches that of the background too closely.
- [AF-Point Zoom] on the [📷] tab is not available.
- [🌸] is not available.



- The camera can detect subjects even if you press the shutter button halfway without pressing the <◀> button. After your shot, [] is displayed in the center of the screen.
- When shooting in [MF] mode (📖 103), press and hold the <◀> button for at least one second.

■ Shooting with Servo AF

This mode helps avoid missing shots of subjects in motion, because the camera continues to focus on the subject and adjust the exposure as long as you press the shutter button halfway.



1 Configure the setting.

- Press the <MENU> button, choose [Servo AF] on the [📷] tab, and then choose [On] (📖47).

2 Focus.

- The focus and exposure are maintained where the blue AF frame is displayed while you are pressing the shutter button halfway.



- * Focusing may not be possible in some shooting conditions.
- * In low-light conditions, Servo AF may not be activated (AF frames may not turn blue) when you press the shutter button halfway. In this case, the focus and exposure are set according to the specified AF frame mode.
- * If adequate exposure cannot be obtained, shutter speeds and aperture values are displayed in orange. Release the shutter button, and then press it halfway again.
- * AF lock shooting is not available.
- * [AF-Point Zoom] on the [📷] tab is not available.
- * Not available when using the self-timer (📖62).

Changing the Focus Setting

You can change default camera operation of constantly focusing on subjects it is aimed at, even when the shutter button is not pressed. Instead, you can limit camera focusing to the moment you press the shutter button halfway.



- Press the <MENU> button, choose [Continuous AF] on the [CAMERA] tab, and then choose [Off] (47).

On	Helps avoid missing sudden photo opportunities, because the camera constantly focuses on subjects until you press the shutter button halfway.
Off	Conserves battery power, because the camera does not focus constantly.

Shooting with the AF Lock

The focus can be locked. After you lock the focus, the focal position will not change even when you release your finger from the shutter button.

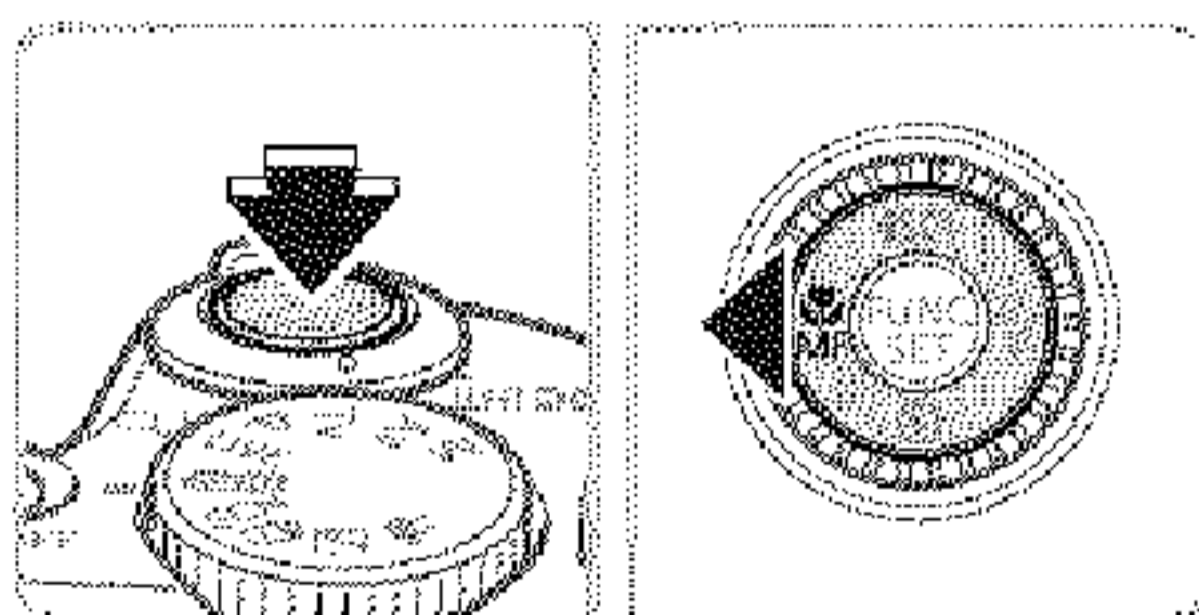

- 1 Lock the focus.**
 - With the shutter button pressed halfway, press the <◀> button.
 - ▶ The focus is now locked, and [MF] and the MF indicator are displayed.
 - To cancel AF lock, release the shutter button, hold the shutter button halfway down again, and press the <◀> button.
- 2 Compose the shot and shoot.**

Activating Flash

You can have the flash fire for each shot. For details on the flash range, see “Specifications” (217).

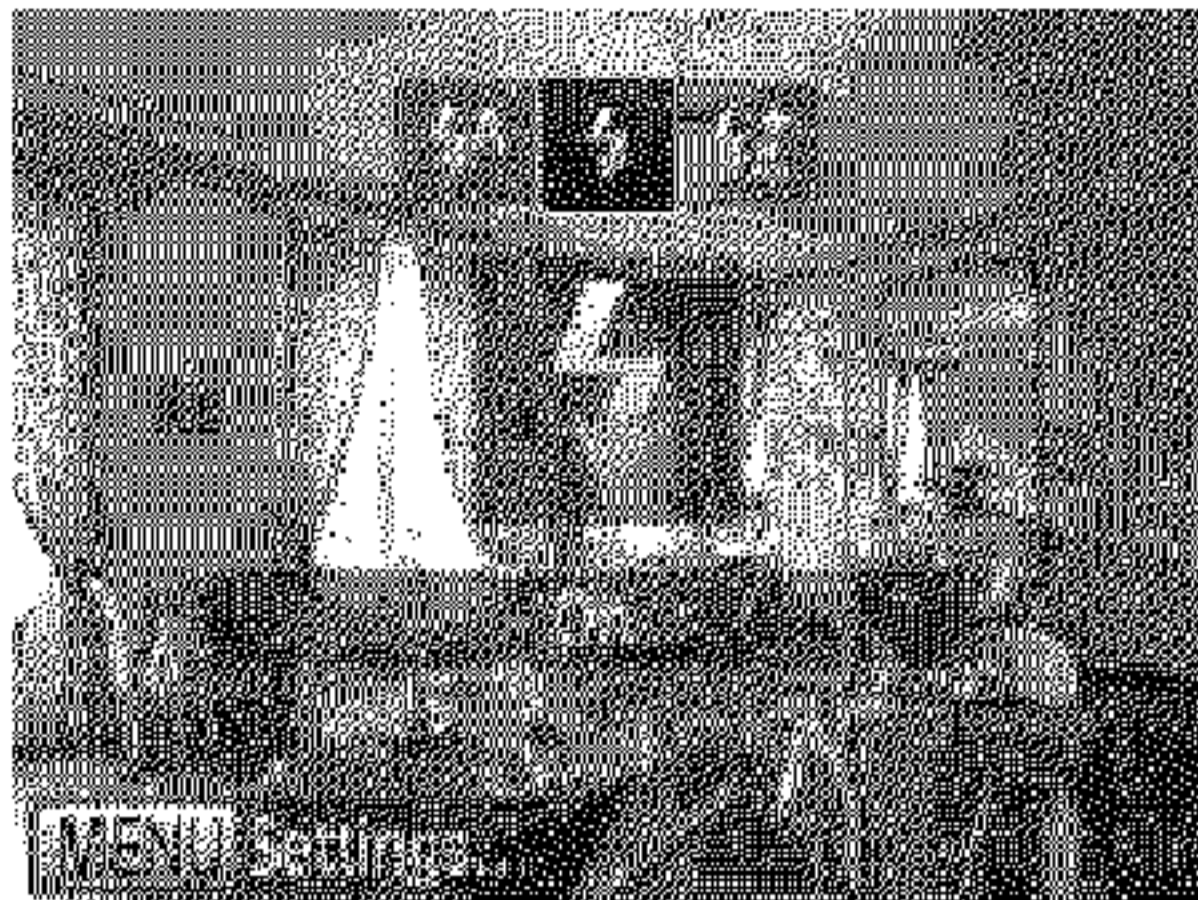

- 1 **Lift the flash.**
- 2 **Configure the setting.**
 - Press the <▶> button, choose [] (either press the <◀><▶> buttons or turn the <◉> dial), and then press the <FUNC SET> button.
 - ▶ Once the setting is complete, [] is displayed.



- The setting screen cannot be accessed by pressing the <▶> button when the flash is lowered. Lift the flash with your finger in advance.

Shooting with Slow Synchro

With this option, the flash fires to increase the brightness of the main subject (such as people) while the camera shoots at a slow shutter speed to increase the brightness of the background that is out of the flash range. For details on the flash range, see “Specifications” (217).



- 1 **Lift the flash.**
- 2 **Configure the setting.**
 - Press the <▶> button, choose [] (either press the <◀><▶> buttons or turn the <◉> dial), and then press the <FUNC SET> button.
 - ▶ Once the setting is complete, [] is displayed.

3 Shoot.

- Even after the flash fires, ensure that the main subject does not move until the shutter sound is finished playing.



- Mount the camera on a tripod or take other measures to keep it still and prevent camera shake. Additionally, you should set [IS Mode] to [Off] when using a tripod or other means to hold the camera still (📖 114).
- The setting screen cannot be accessed by pressing the <▶> button when the flash is lowered. Lift the flash with your finger in advance.

Still Images

Adjusting the Flash Exposure Compensation

Just as with regular exposure compensation (📖 93), you can adjust the flash exposure from -2 to +2 stops, in 1/3-stop increments.

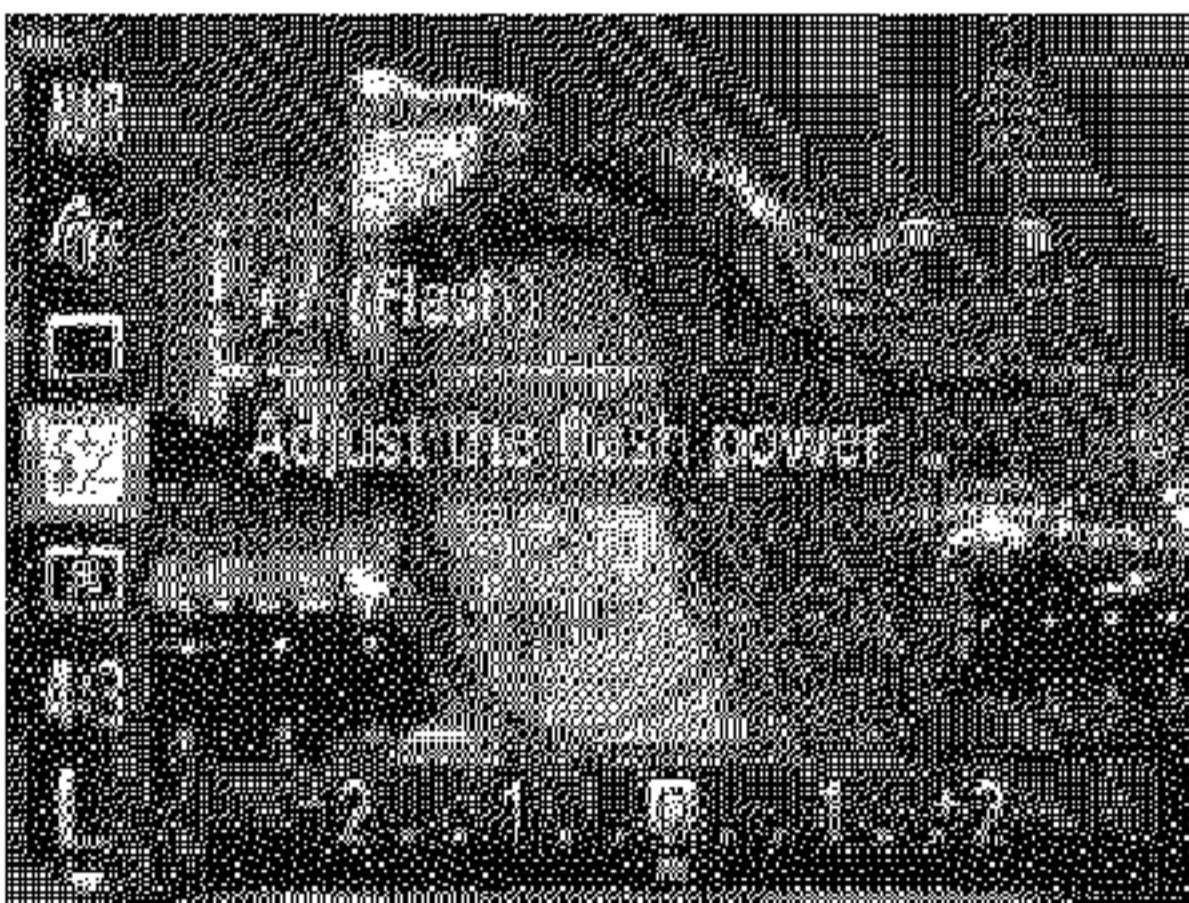

- Press the <FUNC SET> button, choose [⚡] in the menu, and adjust the setting by either pressing the <◀><▶> buttons or turning the <⚙> dial (📖 46).
- ▶ Once the setting is complete, [⚡] is displayed.



- When there is a risk of overexposure, the camera automatically adjusts the shutter speed or aperture value during the flash shots to reduce washed-out highlights and shoot at optimal exposure. However, you can deactivate automatic adjustment of the shutter speed and aperture value by accessing <MENU> (📖 47) and setting [Safety FE] in [Flash Settings] on the [📷] tab to [Off].
- You can also configure the flash exposure compensation by accessing <MENU> (📖 47) and choosing [Flash Exp. Comp] in [Flash Settings] on the [📷] tab.
- You can also access the [Flash Settings] <MENU> screen when the flash is up by pressing the <▶> button and immediately pressing the <MENU> button.

Shooting with the FE Lock

Just as with the AE lock (📖 94), you can lock the exposure for the flash shots.

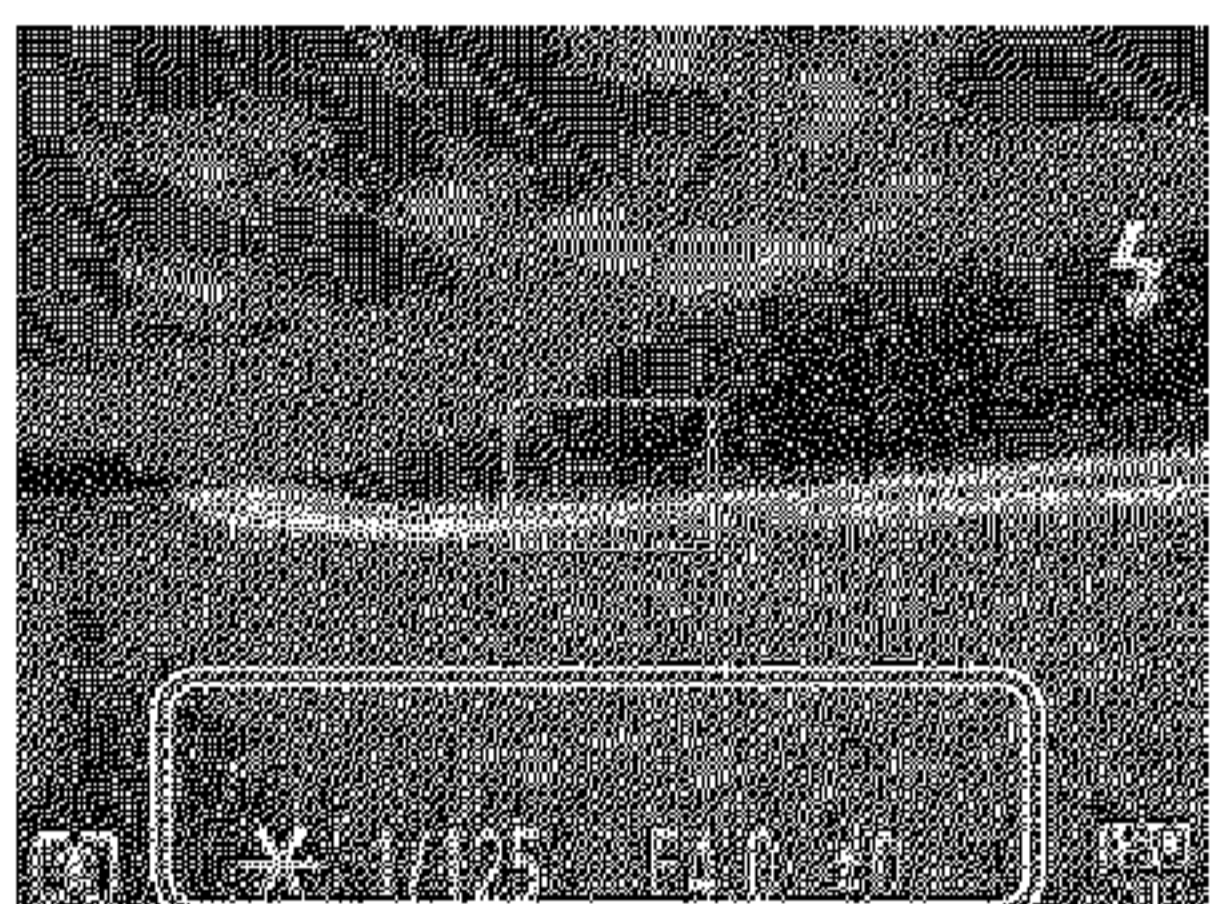
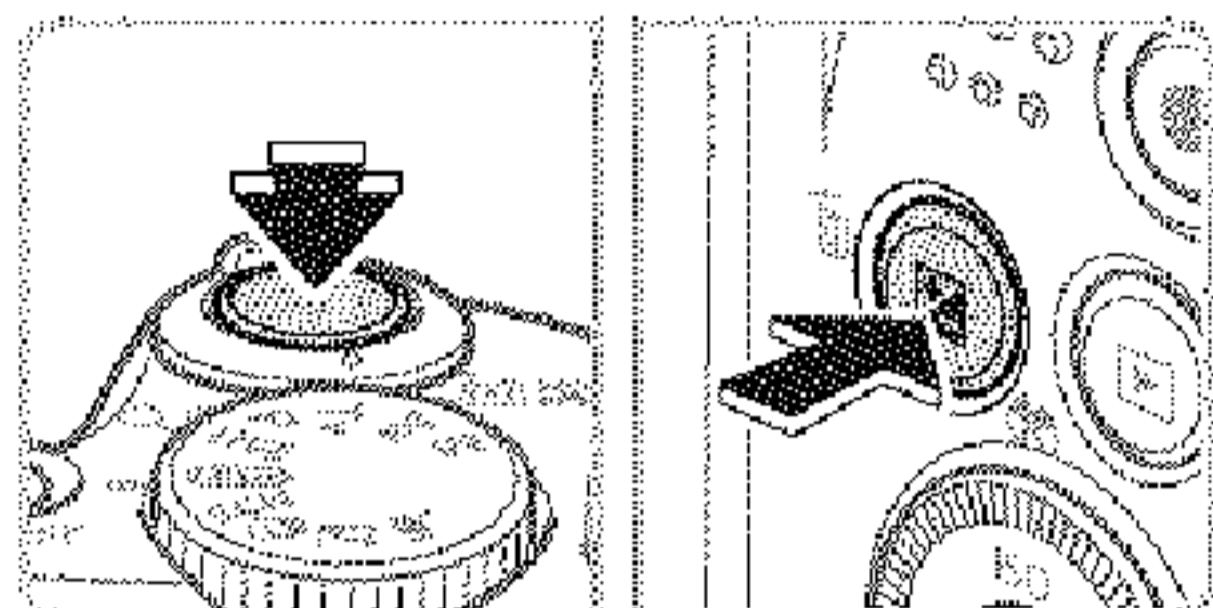

- 1 **Lift the flash and set the flash to [⚡] (📖 111).**
- 2 **Lock the flash exposure.**
 - Aim the camera at the subject to shoot with the exposure locked. With the shutter button pressed halfway, press the <⚡> button.
 - ▶ The flash fires, and when [⚡*] is displayed, the flash output level is retained.
 - To unlock FE, release the shutter button and press the <⚡> button again. In this case, [⚡*] is no longer displayed.
- 3 **Compose the shot and shoot.**
 - After one shot, FE is unlocked and [⚡*] is no longer displayed.



* FE: Flash Exposure

Changing the Compression Ratio (Image Quality)

Choose from two compression ratios, as follows: [S] (Super Fine), [F] (Fine). For guidelines on how many shots at each compression ratio can fit on a memory card, see “Specifications” (217).

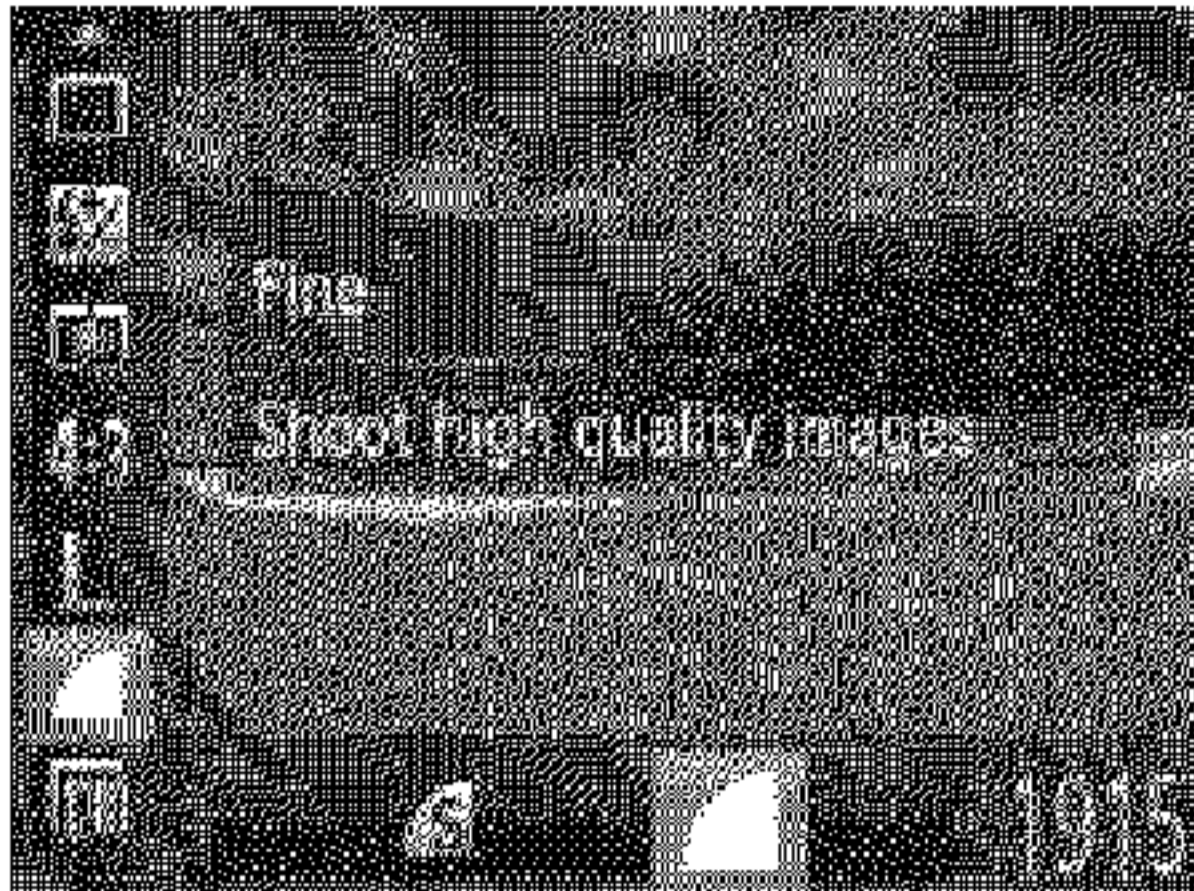

Configure the setting.

- Press the <FUNC/SET> button, choose [F] in the menu, and choose the desired option (46).

Changing the IS Mode Settings

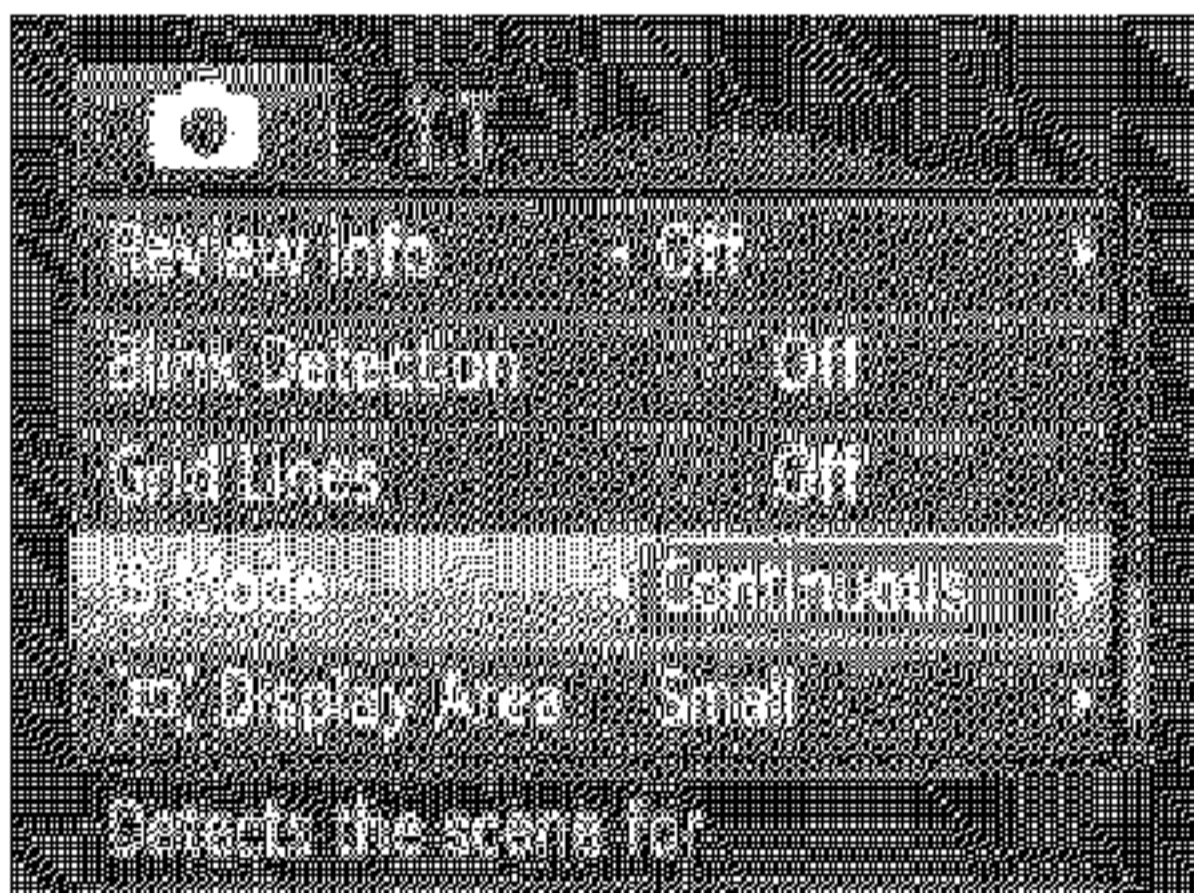

- Press the <MENU> button, choose [IS Mode] on the [CAMERA] tab, and then press the <<>> buttons to choose the desired option (47).

Continuous	Optimal image stabilization for the shooting conditions is automatically applied (Intelligent IS) (58).
Shoot Only*	Image stabilization is active only at the moment of shooting.
Off	Deactivates image stabilization.

* The setting is changed to [Continuous] for movie recording.



- If image stabilization cannot prevent camera shake, mount the camera on a tripod or take other measures to hold it still. In this case, set [IS Mode] to [Off].