

## *PowerShot SX530 HS* Camera User Guide

ENGLISH

- Make sure you read this guide, including the “Safety Precautions” (📖 14) section, before using the camera.
- Reading this guide will help you learn to use the camera properly.
- Store this guide safely so that you can use it in the future.

- Click the buttons in the lower right to access other pages.
  - ▶: Next page
  - ◀: Previous page
  - 🔗: Page before you clicked a link
- To jump to the beginning of a chapter, click the chapter title at right.

Before Use

Basic Guide

Advanced Guide

**1** Camera Basics

**2** Auto Mode /  
Hybrid Auto Mode

**3** Other Shooting Modes

**4** P Mode

**5** Tv, Av, and M Mode

**6** Playback Mode

**7** Wi-Fi Functions

**8** Setting Menu

**9** Accessories

**10** Appendix

Index

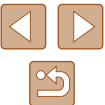

# Before Use

## Initial Information

### Package Contents

Before use, make sure the following items are included in the package. If anything is missing, contact your camera retailer.



Camera



Battery Pack  
NB-6LH\*



Battery Charger  
CB-2LY/CB-2LYE



Neck Strap



Lens Cap  
(with cord)

\* Do not peel off the battery pack label.

- Printed matter is also included.
- A memory card is not included (📖2).

## Compatible Memory Cards

The following memory cards (sold separately) can be used, regardless of capacity.

- SD memory cards\*
- SDHC memory cards\*
- SDXC memory cards\*



\* Cards conforming to SD standards. However, not all memory cards have been verified to work with the camera.

Before Use

Basic Guide

Advanced Guide

**1** Camera Basics

**2** Auto Mode /  
Hybrid Auto Mode

**3** Other Shooting Modes

**4** P Mode

**5** Tv, Av, and M Mode

**6** Playback Mode

**7** Wi-Fi Functions

**8** Setting Menu

**9** Accessories

**10** Appendix

Index

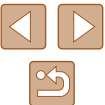

## Preliminary Notes and Legal Information

- Take and review some test shots initially to make sure the images were recorded correctly. Please note that Canon Inc., its subsidiaries and affiliates, and its distributors are not liable for any consequential damages arising from any malfunction of a camera or accessory, including memory cards, that result in the failure of an image to be recorded or to be recorded in a way that is machine readable.
- Images recorded by the camera shall be for personal use. Refrain from unauthorized recording that infringes on copyright law, and note that even for personal use, photography may contravene copyright or other legal rights at some performances or exhibitions, or in some commercial settings.
- The camera warranty is valid only in the area of purchase. In case of camera problems while abroad, return to the area of purchase before contacting a Canon Customer Support Help Desk.
- Although the LCD monitor is produced under extremely high-precision manufacturing conditions and more than 99.99% of the pixels meet design specifications, in rare cases some pixels may be defective or may appear as red or black dots. This does not indicate camera damage or affect recorded images.
- The LCD monitor may be covered with a thin plastic film for protection against scratches during shipment. If covered, remove the film before using the camera.
- When the camera is used over an extended period, it may become warm. This does not indicate damage.

Before Use

Basic Guide

Advanced Guide

**1** Camera Basics

**2** Auto Mode / Hybrid Auto Mode

**3** Other Shooting Modes

**4** P Mode

**5** Tv, Av, and M Mode

**6** Playback Mode

**7** Wi-Fi Functions

**8** Setting Menu

**9** Accessories

**10** Appendix

Index



# Part Names and Conventions in This Guide

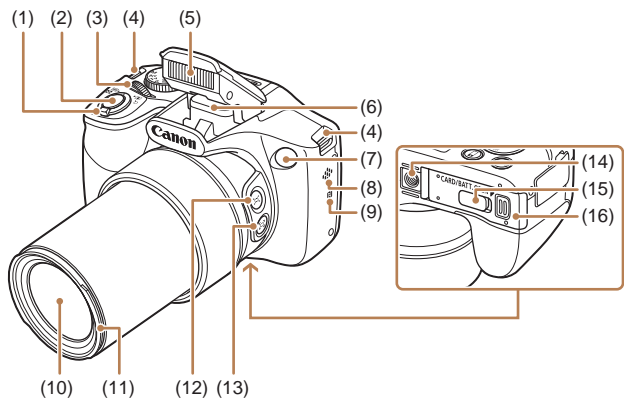

- |   |  |
|---|--|
| (1) Zoom lever<br>Shooting: [T] (telephoto) /<br>[W] (wide angle)<br>Playback: [Q] (magnify) /<br>[i] (index) | (8) Speaker                                |
| (2) Shutter button  | (9) [N] (N-Mark)*                          |
| (3) Front dial  | (10) Lens                                  |
| (4) Strap mount   | (11) Lens hood/filter adapter mount        |
| (5) Flash   | (12) [F] (Framing Assist – Seek)<br>button |
| (6) Wi-Fi antenna area  | (13) [L] (Framing Assist – Lock)<br>button |
| (7) Lamp  | (14) Tripod socket                         |
|   | (15) DC coupler terminal cover             |
|   | (16) Memory card/battery cover             |

\* Used with NFC features (98).

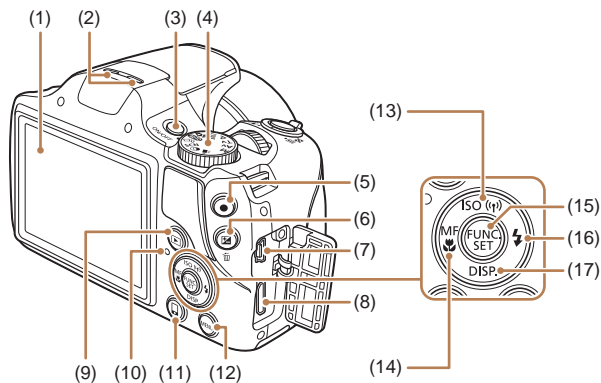

- |  |   |
|--|---|
| (1) Screen (LCD monitor)   | (10) Indicator                                      |
| (2) Microphone   | (11) [M] (Mobile Device Connection)<br>button       |
| (3) Power button   | (12) [MENU] button                                  |
| (4) Mode dial  | (13) [ISO] (ISO speed) / [Wi-Fi] /<br>Up button     |
| (5) Movie button   | (14) [MF] (Manual focus) / [Macro]<br>/ Left button |
| (6) [C] (Exposure compensation) /<br>[E] (Single-image erase) button | (15) FUNC./SET button                               |
| (7) AV OUT (Audio/video output) /<br>DIGITAL terminal                | (16) [Flash] / Right button                         |
| (8) HDMI™ terminal   | (17) [DISP.] (Display) / Down button                |
| (9) [P] (Playback) button  |   |

Before Use

Basic Guide

Advanced Guide

**1** Camera Basics

**2** Auto Mode /  
Hybrid Auto Mode

**3** Other Shooting Modes

**4** P Mode

**5** Tv, Av, and M Mode

**6** Playback Mode

**7** Wi-Fi Functions











**8** Setting Menu

**9** Accessories

**10** Appendix

Index



- In this guide, icons are used to represent the corresponding camera buttons and dials on which they appear or which they resemble.
- The following camera buttons and controls are represented by icons.
  -  Front dial (3) on front
  -  Up button (13) on back
  -  Left button (14) on back
  -  Right button (16) on back
  -  Down button (17) on back
- Shooting modes and on-screen icons and text are indicated in brackets.
- : Important information you should know
- : Notes and tips for expert camera use
- xx: Pages with related information (in this example, “xx” represents a page number)
- Instructions in this guide apply to the camera under default settings.
- For convenience, all supported memory cards are simply referred to as the “memory card”.
- The symbols  “Still Images” and  “Movies” below titles indicate how the function is used—whether for still images or movies.

Before Use
Basic Guide
Advanced Guide
<b>1</b> Camera Basics
<b>2</b> Auto Mode / Hybrid Auto Mode
<b>3</b> Other Shooting Modes
<b>4</b> P Mode
<b>5</b> Tv, Av, and M Mode
<b>6</b> Playback Mode
<b>7</b> Wi-Fi Functions
<b>8</b> Setting Menu
<b>9</b> Accessories
<b>10</b> Appendix
Index



# Table of Contents

## Before Use

<b>Initial Information</b> .....	<b>2</b>
Package Contents .....	2
Compatible Memory Cards.....	2
Preliminary Notes and Legal Information .....	3
Part Names and Conventions in This Guide .....	4
Common Camera Operations .....	12
Safety Precautions .....	14

## Basic Guide

<b>Basic Operations</b> .....	<b>17</b>
Initial Preparations.....	17
Attaching Accessories .....	17
Holding the Camera.....	18
Charging the Battery Pack.....	18
Inserting the Battery Pack and Memory Card.....	19
Removing the Battery Pack and Memory Card .....	19
Setting the Date and Time .....	20
Changing the Date and Time.....	20
Display Language.....	21
Trying the Camera Out.....	22
Shooting (Smart Auto) .....	22
Viewing.....	23
Erasing Images .....	24

## Advanced Guide

<b>1 Camera Basics</b> .....	<b>25</b>
On/Off.....	25
Power-Saving Features (Auto Power Down).....	26
Power Saving in Shooting Mode .....	26
Power Saving in Playback Mode.....	26
Shutter Button .....	26
Shooting Modes .....	27
Shooting Display Options .....	27
Using the FUNC. Menu .....	28
Using the Menu Screen.....	29
On-Screen Keyboard.....	30
Indicator Display.....	30
Clock .....	31
<b>2 Auto Mode / Hybrid Auto Mode</b> .....	<b>32</b>
Shooting with Camera-Determined Settings .....	32
Shooting (Smart Auto) .....	32
Shooting in Hybrid Auto Mode .....	34
Digest Movie Playback .....	34
Still Images/Movies .....	35
Still Images .....	35
Movies .....	35
Scene Icons.....	36
Image Stabilization Icons.....	37
On-Screen Frames .....	37
Common, Convenient Features .....	38
Zooming In Closer on Subjects (Digital Zoom).....	38
Easily Reacquiring Subjects after Manual Zooming (Framing Assist – Seek) .....	39

Before Use
Basic Guide
Advanced Guide
<b>1</b> Camera Basics
<b>2</b> Auto Mode / Hybrid Auto Mode
<b>3</b> Other Shooting Modes
<b>4</b> P Mode
<b>5</b> Tv, Av, and M Mode
<b>6</b> Playback Mode
<b>7</b> Wi-Fi Functions
<b>8</b> Setting Menu
<b>9</b> Accessories
<b>10</b> Appendix
Index

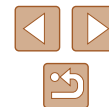

Easily Composing Shots after Manual Zooming (Framing Assist – Lock) .....	39
Auto Zooming to Keep Faces at a Constant Size .....	40
Adjusting the Constant Face Display Size .....	40
Easily Reacquiring Subjects with Auto Zooming (Seek Assist) .	41
Using the Self-Timer .....	42
Using the Self-Timer to Avoid Camera Shake .....	42
Customizing the Self-Timer .....	43
Adding a Date Stamp .....	43
Continuous Shooting .....	44
Image Customization Features .....	45
Changing the Aspect Ratio .....	45
Changing Image Resolution (Size).....	45
Guidelines for Choosing Resolution Based on Paper Size (for 4:3 Images) .....	45
Red-Eye Correction .....	46
Changing Movie Image Quality .....	46
Helpful Shooting Features.....	47
Displaying Grid Lines.....	47
Magnifying the Area in Focus .....	47
Checking for Closed Eyes .....	48
Customizing Camera Operation.....	48
Deactivating the AF-Assist Beam .....	48
Deactivating the Red-Eye Reduction Lamp.....	49
Changing the Image Display Style after Shots .....	49
Changing the Image Display Period after Shots .....	49
Changing the Screen Displayed after Shots .....	50

<b>3 Other Shooting Modes.....</b>	<b>51</b>
Brightness / Color Customization (Live View Control).....	51
Enjoying a Variety of Images from Each Shot (Creative Shot) .....	52
Image Display during Playback .....	52
Choosing Effects .....	53
Specific Scenes.....	53
Image Effects (Creative Filters).....	54
Shooting with a Fish-Eye Lens Effect (Fish-Eye Effect) .....	55
Shots Resembling Miniature Models (Miniature Effect).....	55
Playback Speed and Estimated Playback Time (for One-Minute Clips) .....	56
Shooting with a Toy Camera Effect (Toy Camera Effect).....	56
Shooting in Monochrome.....	57
Special Modes for Other Purposes .....	57
Auto Shooting after Face Detection (Smart Shutter).....	57
Auto Shooting after Smile Detection .....	57
Using the Wink Self-Timer .....	58
Using the Face Self-Timer.....	58
High-Speed Continuous Shooting (High-Speed Burst) .....	59
Shooting Various Movies.....	60
Shooting Movies in Movie Mode.....	60
Locking or Changing Image Brightness before Shooting .....	60
<b>4 P Mode.....</b>	<b>61</b>
Shooting in Program AE ([P] Mode) .....	61
Image Brightness (Exposure).....	62
Adjusting Image Brightness (Exposure Compensation) .....	62
Locking Image Brightness / Exposure (AE Lock) .....	62
Changing the Metering Method .....	62
Changing the ISO Speed.....	63
Correcting Image Brightness (i-Contrast) .....	63

Before Use
Basic Guide
Advanced Guide
<b>1</b> Camera Basics
<b>2</b> Auto Mode / Hybrid Auto Mode
<b>3</b> Other Shooting Modes
<b>4</b> P Mode
<b>5</b> Tv, Av, and M Mode
<b>6</b> Playback Mode
<b>7</b> Wi-Fi Functions
<b>8</b> Setting Menu
<b>9</b> Accessories
<b>10</b> Appendix
Index



Image Colors .....	64
Adjusting White Balance .....	64
Custom White Balance .....	64
Changing Image Color Tones (My Colors) .....	64
Custom Color .....	65
Shooting Range and Focusing .....	66
Shooting Close-Ups (Macro) .....	66
Shooting in Manual Focus Mode .....	66
Digital Tele-Converter .....	67
Changing the AF Frame Mode .....	68
Center .....	68
Face AiAF .....	68
Choosing Subjects to Focus On (Tracking AF) .....	69
Shooting with Servo AF .....	69
Changing the Focus Setting .....	70
Shooting with the AF Lock .....	70
Flash .....	71
Changing the Flash Mode .....	71
Auto .....	71
On .....	71
Slow Synchro .....	71
Off .....	71
Adjusting the Flash Exposure Compensation .....	72
Shooting with the FE Lock .....	72
Other Settings .....	73
Changing the Compression Ratio (Image Quality) .....	73
Changing the IS Mode Settings .....	73
Shooting Movies with Subjects at the Same Size Shown before Shooting .....	73

<b>5 Tv, Av, and M Mode .....</b>	<b>74</b>
Specific Shutter Speeds ([Tv] Mode) .....	74
Specific Aperture Values ([Av] Mode) .....	75
Specific Shutter Speeds and Aperture Values ([M] Mode) .....	75
Adjusting the Flash Output .....	76
<b>6 Playback Mode .....</b>	<b>77</b>
Viewing .....	77
Switching Display Modes .....	78
Overexposure Warning (for Image Highlights) .....	79
Histogram .....	79
GPS Information Display .....	79
Viewing Short Movies Created When Shooting Still Images (Digest Movies) .....	79
Viewing by Date .....	80
Browsing and Filtering Images .....	80
Navigating through Images in an Index .....	80
Finding Images Matching Specified Conditions .....	81
Using the Front Dial to Jump between Images .....	81
Viewing Individual Images in a Group .....	82
Image Viewing Options .....	83
Magnifying Images .....	83
Viewing Slideshows .....	84
Changing Slideshow Settings .....	84
Auto Playback of Related Images (Smart Shuffle) .....	85
Protecting Images .....	85
Using the Menu .....	86
Choosing Images Individually .....	86
Selecting a Range .....	87
Protecting All Images at Once .....	87
Clearing All Protection at Once .....	87

Before Use
Basic Guide
Advanced Guide
<b>1</b> Camera Basics
<b>2</b> Auto Mode / Hybrid Auto Mode
<b>3</b> Other Shooting Modes
<b>4</b> P Mode
<b>5</b> Tv, Av, and M Mode
<b>6</b> Playback Mode
<b>7</b> Wi-Fi Functions
<b>8</b> Setting Menu
<b>9</b> Accessories
<b>10</b> Appendix
Index





Erasing Images .....	88	Checking Your Computer Environment .....	105
Erasing Multiple Images at Once.....	88	Installing the Software .....	105
Choosing a Selection Method .....	88	Configuring the Computer for a Wi-Fi Connection (Windows Only) .....	106
Choosing Images Individually.....	89	Saving Images to a Connected Computer.....	107
Selecting a Range .....	89	Confirming Access Point Compatibility .....	107
Specifying All Images at Once.....	89	Using WPS-Compatible Access Points .....	107
Rotating Images .....	90	Connecting to Listed Access Points .....	109
Using the Menu .....	90	Previous Access Points .....	110
Deactivating Auto Rotation .....	90	Sending Images to a Registered Web Service.....	111
Tagging Images as Favorites .....	91	Registering Web Services .....	111
Using the Menu .....	91	Registering CANON iIMAGE GATEWAY.....	111
Editing Still Images.....	92	Registering Other Web Services .....	113
Resizing Images .....	92	Uploading Images to Web Services .....	113
Cropping.....	92	Printing Images Wirelessly from a Connected Printer.....	114
Changing Image Color Tones (My Colors) .....	93	Sending Images to Another Camera .....	116
Correcting Image Brightness (i-Contrast) .....	94	Image Sending Options.....	117
Correcting Red-Eye.....	94	Notes on Sending Images .....	117
Editing Movies .....	95	Choosing the Image Resolution (Size).....	117
Editing Digest Movies.....	96	Adding Comments .....	118
<b>7 Wi-Fi Functions.....</b>	<b>97</b>	Sending Images Automatically (Image Sync).....	118
Available Wi-Fi Features .....	97	Initial Preparations.....	118
Sending Images to a Smartphone.....	98	Preparing the Camera .....	118
Sending Images to an NFC-Compatible Smartphone.....	98	Preparing the Computer .....	119
Connecting via NFC When Off or in Shooting Mode.....	98	Sending Images.....	119
Connecting via NFC in Playback Mode.....	100	Using a Smartphone to View Camera Images and Control the Camera.....	120
Sending to a Smartphone Assigned to the Button.....	101	Geotagging Images on the Camera .....	120
Adding a Smartphone Using the Wi-Fi Menu .....	102	Shooting Remotely .....	121
Using Another Access Point .....	104	Editing or Erasing Wi-Fi Settings.....	122
Previous Access Points .....	105	Editing Connection Information .....	122
Saving Images to a Computer.....	105	Changing a Device Nickname .....	122
Preparing to Register a Computer.....	105		

<b>Before Use</b>
<b>Basic Guide</b>
<b>Advanced Guide</b>
<b>1 Camera Basics</b>
<b>2 Auto Mode / Hybrid Auto Mode</b>
<b>3 Other Shooting Modes</b>
<b>4 P Mode</b>
<b>5 Tv, Av, and M Mode</b>
<b>6 Playback Mode</b>
<b>7 Wi-Fi Functions</b>
<b>8 Setting Menu</b>
<b>9 Accessories</b>
<b>10 Appendix</b>
<b>Index</b>

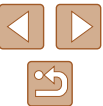

Erasing Connection Information .....	123
Returning the Wi-Fi Settings to Default .....	123
<b>8 Setting Menu .....</b>	<b>124</b>
Adjusting Basic Camera Functions .....	124
Silencing Camera Operations .....	124
Adjusting the Volume .....	124
Hiding Hints and Tips .....	125
Date and Time .....	125
World Clock .....	125
Lens Retraction Timing .....	126
Using Eco Mode .....	126
Power-Saving Adjustment .....	126
Screen Brightness .....	127
Hiding the Start-Up Screen .....	127
Formatting Memory Cards .....	127
Low-Level Formatting .....	128
File Numbering .....	128
Date-Based Image Storage .....	129
Metric / Non-Metric Display .....	129
Checking Certification Logos .....	129
Display Language .....	129
Adjusting Other Settings .....	130
Restoring Defaults .....	130
<b>9 Accessories .....</b>	<b>131</b>
System Map .....	131
Optional Accessories .....	132
Power Supplies .....	132
Flash Unit .....	133
Other Accessories .....	133
Printer .....	133

Using Optional Accessories .....	134
Playback on a TV .....	134
Playback on a High-Definition TV .....	134
Playback on a Standard-Definition TV .....	134
Powering the Camera with Household Power .....	135
Using a Lens Hood (Sold Separately) .....	136
Using Lens Filters (Sold Separately) .....	136
Using the Software .....	137
Software .....	137
Computer Connections via a Cable .....	138
Checking Your Computer Environment .....	138
Installing the Software .....	138
Saving Images to a Computer .....	138
Printing Images .....	140
Easy Print .....	140
Configuring Print Settings .....	141
Cropping Images before Printing .....	141
Choosing Paper Size and Layout before Printing .....	142
Available Layout Options .....	142
Printing ID Photos .....	142
Printing Movie Scenes .....	143
Movie Printing Options .....	143
Adding Images to the Print List (DPOF) .....	143
Configuring Print Settings .....	143
Setting Up Printing for Individual Images .....	144
Setting Up Printing for a Range of Images .....	144
Setting Up Printing for All Images .....	144
Clearing All Images from the Print List .....	145
Printing Images Added to the Print List (DPOF) .....	145

<b>Before Use</b>
<b>Basic Guide</b>
<b>Advanced Guide</b>
<b>1 Camera Basics</b>
<b>2 Auto Mode / Hybrid Auto Mode</b>
<b>3 Other Shooting Modes</b>
<b>4 P Mode</b>
<b>5 Tv, Av, and M Mode</b>
<b>6 Playback Mode</b>
<b>7 Wi-Fi Functions</b>
<b>8 Setting Menu</b>
<b>9 Accessories</b>
<b>10 Appendix</b>
<b>Index</b>

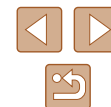

Adding Images to a Photobook .....	145
Choosing a Selection Method .....	145
Adding Images Individually .....	146
Adding All Images to a Photobook .....	146
Removing All Images from a Photobook .....	146
<b>10 Appendix .....</b>	<b>147</b>
Troubleshooting .....	147
On-Screen Messages .....	150
On-Screen Information .....	152
Shooting (Information Display) .....	152
Battery Level .....	153
Playback (Detailed Information Display) .....	153
Summary of Movie Control Panel .....	154
Functions and Menu Tables .....	154
Functions Available in Each Shooting Mode .....	154
FUNC. Menu .....	156
Shooting Tab .....	157
Set Up Tab .....	161
Playback Tab .....	161
Print Tab .....	162
Playback Mode FUNC. Menu .....	162
Handling Precautions .....	162
Specifications .....	163
Camera Specifications .....	163
Wi-Fi .....	163
Digital Zoom Focal Length (35mm film equivalent) .....	163
Number of Shots/Recording Time, Playback Time .....	163
Number of Shots per Memory Card .....	164
Recording Time per Memory Card .....	164
Flash Range .....	164
Shooting Range .....	165

Continuous Shooting Speed .....	165
Shutter Speed .....	165
Aperture .....	165
Battery Pack NB-6LH .....	165
Battery Charger CB-2LY/CB-2LYE .....	165
Lens Hood LH-DC60 (Sold Separately) .....	165
Index .....	166
Wi-Fi (Wireless LAN) Precautions .....	168
Radio Wave Interference Precautions .....	168
Security Precautions .....	168
Trademarks and Licensing .....	169
Disclaimer .....	169

<b>Before Use</b>
<b>Basic Guide</b>
<b>Advanced Guide</b>
<b>1 Camera Basics</b>
<b>2 Auto Mode / Hybrid Auto Mode</b>
<b>3 Other Shooting Modes</b>
<b>4 P Mode</b>
<b>5 Tv, Av, and M Mode</b>
<b>6 Playback Mode</b>
<b>7 Wi-Fi Functions</b>
<b>8 Setting Menu</b>
<b>9 Accessories</b>
<b>10 Appendix</b>
<b>Index</b>

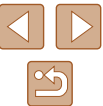

# Common Camera Operations

## Shoot

- Use camera-determined settings (Auto Mode, Hybrid Auto Mode)
  - 32, 34
- See several effects applied to each shot, using camera-determined settings (Creative Shot Mode)
  - 52

Shooting people well



Portraits  
(53)



Against Snow  
(53)

Matching specific scenes



Low Light  
(53)



Fireworks  
(53)

Applying special effects



Vivid Colors  
(54)



Poster Effect  
(54)



Fish-Eye Effect  
(55)



Miniature Effect  
(55)



Toy Camera Effect  
(56)



Monochrome  
(57)

- While adjusting image settings (Live View Control)
  - 51
- Focus on faces
  - 32, 53, 68
- Without using the flash (Flash Off)
  - 32, 71
- Include yourself in the shot (Self-Timer)
  - 42, 58
- Add a date stamp
  - 43
- Movie clips and photos together (Movie Digest)
  - 34

Before Use

Basic Guide

Advanced Guide

**1** Camera Basics

**2** Auto Mode / Hybrid Auto Mode

**3** Other Shooting Modes

**4** P Mode

**5** Tv, Av, and M Mode

**6** Playback Mode

**7** Wi-Fi Functions

**8** Setting Menu







**9** Accessories

**10** Appendix



Index



## View

- View images (Playback Mode)
  -  77
- Automatic playback (Slideshow)
  -  84
- On a TV
  -  134
- On a computer
  -  138
- Browse through images quickly
  -  80
- Erase images
  -  88

## Shoot/View Movies

- Shoot movies
  -  32,  60
- View movies (Playback Mode)
  -  77



## Print

- Print pictures
  -  140

## Save

- Save images to a computer via a cable
  -  138

## Use Wi-Fi Functions

- Send images to a smartphone
  -  98
- Share images online
  -  111
- Send images to a computer
  -  105

## Before Use

### Basic Guide

### Advanced Guide

#### **1** Camera Basics

#### **2** Auto Mode / Hybrid Auto Mode

#### **3** Other Shooting Modes

#### **4** P Mode

#### **5** Tv, Av, and M Mode

#### **6** Playback Mode

#### **7** Wi-Fi Functions

#### **8** Setting Menu

#### **9** Accessories

#### **10** Appendix

## Index

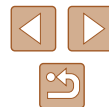

## Safety Precautions

- Before using the product, ensure that you read the safety precautions described below. Always ensure that the product is used correctly.
- The safety precautions noted here are intended to prevent you and other persons from being injured or incurring property damage.
- Be sure to also check the guides included with any separately sold accessories you use.



### Warning

Denotes the possibility of serious injury or death.

- Do not trigger the flash in close proximity to people's eyes. Exposure to the intense light produced by the flash could damage eyesight. In particular, remain at least 1 meter (3.3 feet) away from infants when using the flash.

- Store this equipment out of the reach of children and infants. A strap wound around a child's neck may result in asphyxiation. If your product uses a power cord, mistakenly winding the cord around a child's neck may result in asphyxiation.

- Use only recommended power sources.
- Do not disassemble, alter, or apply heat to the product.
- Do not peel off the label, if the battery pack has one.
- Avoid dropping or subjecting the product to severe impacts.
- Do not touch the interior of the product if it is broken, such as when dropped.
- Stop using the product immediately if it emits smoke or a strange smell, or otherwise behaves abnormally.
- Do not use organic solvents such as alcohol, benzene, or thinner to clean the product.
- Avoid contact with liquid, and do not allow liquid or foreign objects inside.

This could result in electrical shock or fire.

If the product gets wet, or if liquid or foreign objects get inside, remove the battery pack/batteries or unplug immediately.

- Do not look through the viewfinder (if your model has one) at intense light sources, such as the sun on a clear day or an intense artificial light source.

This could damage your eyesight.

- Do not touch the product during thunderstorms if it is plugged in. This could result in electrical shock or fire. Immediately stop using the product and distance yourself from it.

- Use only the recommended battery pack/batteries.

- Do not place the battery pack/batteries near or in direct flame. This may cause the battery pack/batteries to explode or leak, resulting in electrical shock, fire, or injuries. If leaking battery electrolyte comes into contact with eyes, mouth, skin, or clothing, immediately flush with water.

- If the product uses a battery charger, note the following precautions.
  - Remove the plug periodically and, using a dry cloth, wipe away any dust and dirt that has collected on the plug, the exterior of the power outlet, and the surrounding area.
  - Do not insert or remove the plug with wet hands.
  - Do not use the equipment in a manner that exceeds the rated capacity of the electrical outlet or wiring accessories. Do not use if the plug is damaged or not fully inserted in the outlet.
  - Do not allow dust or metal objects (such as pins or keys) to contact the terminals or plug.
  - Do not cut, damage, alter, or place heavy items on the power cord, if your product uses one.

This could result in electrical shock or fire.

- Turn the camera off in places where camera use is prohibited. The electromagnetic waves emitted by the camera may interfere with the operation of electronic instruments and other devices. Exercise adequate caution when using the product in places where use of electronic devices is restricted, such as inside airplanes and medical facilities.

Before Use

Basic Guide

Advanced Guide

**1** Camera Basics

**2** Auto Mode / Hybrid Auto Mode

**3** Other Shooting Modes

**4** P Mode

**5** Tv, Av, and M Mode

**6** Playback Mode

**7** Wi-Fi Functions

**8** Setting Menu

**9** Accessories

**10** Appendix

Index



- Do not allow the camera to maintain contact with skin for extended periods.

Even if the camera does not feel hot, this may cause low-temperature burns, manifested in redness of the skin or blistering. Use a tripod in hot places, or if you have poor circulation or insensitive skin.

 <b>Caution</b>	Denotes the possibility of injury.
--	------------------------------------

- When carrying the product by the strap, be careful not to bang it, subject it to strong impacts or shocks, or let it get caught on other objects.
- Be careful not to bump or push strongly on the lens. This could lead to injury or damage the camera.
- Be careful not to subject the screen to strong impacts. If the screen cracks, injury may result from the broken fragments.
- When using the flash, be careful not to cover it with your fingers or clothing. This could result in burns or damage to the flash.
- Avoid using, placing, or storing the product in the following places:
  - Places subject to direct sunlight
  - Places subject to temperatures above 40 °C (104 °F)
  - Humid or dusty places
 These could cause leakage, overheating, or an explosion of the battery pack/batteries, resulting in electrical shock, fire, burns, or other injuries. Overheating and damage may result in electrical shock, fire, burns, or other injuries.
- The slideshow transition effects may cause discomfort when viewed for prolonged periods.
- When using optional lenses, lens filters, or filter adapters (if applicable), be sure to attach these accessories firmly. If the lens accessory becomes loose and falls off, it may crack, and the shards of glass may lead to cuts.

- On products that raise and lower the flash automatically, make sure to avoid pinching your fingers with the lowering flash. This could result in injury.

<b>Caution</b>	Denotes the possibility of property damage.
----------------	---

- Do not aim the camera at intense light sources, such as the sun on a clear day or an intense artificial light source. Doing so may damage the image sensor or other internal components.
- When using the camera on a sandy beach or at a windy location, be careful not to allow dust or sand to enter the camera.
- On products that raise and lower the flash automatically, do not push the flash down or pry it open. This may cause the product to malfunction.
- Wipe off any dust, grime, or other foreign matter on the flash with a cotton swab or cloth. The heat emitted from the flash may cause foreign matter to smoke or the product to malfunction.
- Remove and store the battery pack/batteries when you are not using the product. Any battery leakage that occurs may cause product damage.
- Before you discard the battery pack/batteries, cover the terminals with tape or other insulators. Contacting other metal materials may lead to fire or explosions.
- Unplug any battery charger used with the product when not in use. Do not cover with a cloth or other objects when in use. Leaving the unit plugged in for a long period of time may cause it to overheat and distort, resulting in fire.
- Do not leave any dedicated battery packs near pets. Pets biting the battery pack could cause leakage, overheating, or explosion, resulting in product damage or fire.

<b>Before Use</b>
<b>Basic Guide</b>
<b>Advanced Guide</b>
<b>1 Camera Basics</b>
<b>2 Auto Mode / Hybrid Auto Mode</b>
<b>3 Other Shooting Modes</b>
<b>4 P Mode</b>
<b>5 Tv, Av, and M Mode</b>
<b>6 Playback Mode</b>
<b>7 Wi-Fi Functions</b>
<b>8 Setting Menu</b>
<b>9 Accessories</b>
<b>10 Appendix</b>
<b>Index</b>



- If your product uses multiple batteries, do not use batteries that have different levels of charge together, and do not use old and new batteries together. Do not insert the batteries with the + and – terminals reversed.

This may cause the product to malfunction.

- Do not sit down with the camera in your pant pocket. Doing so may cause malfunctions or damage the screen.
- When putting the camera in your bag, ensure that hard objects do not come into contact with the screen. Also close the screen (so that it faces the body), if your product's screen closes.
- Do not attach any hard objects to the product. Doing so may cause malfunctions or damage the screen.



## Before Use

## Basic Guide

## Advanced Guide

### 1 Camera Basics

### 2 Auto Mode / Hybrid Auto Mode

### 3 Other Shooting Modes

### 4 P Mode

### 5 Tv, Av, and M Mode

### 6 Playback Mode

### 7 Wi-Fi Functions

### 8 Setting Menu

### 9 Accessories

### 10 Appendix

## Index

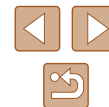



## Basic Operations

Basic information and instructions, from initial preparations to shooting and playback

### Initial Preparations

Prepare for shooting as follows.

#### Attaching Accessories

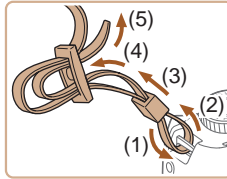

##### 1 Attach the strap.

- Attach the included strap to the camera as shown.
- On the other side of the camera, attach the strap the same way.

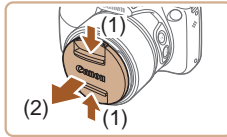

##### 2 Attach the lens cap.

- Remove the lens cap from the lens and attach the lens cap cord to the strap.

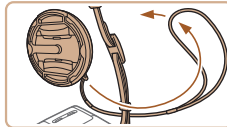

- Always remove the lens cap before turning the camera on. Try clipping the lens cap to the neck strap when the cap is not in use.
- Keep the lens cap on the lens when the camera is not in use.



Before Use

Basic Guide

Advanced Guide

1 Camera Basics

2 Auto Mode / Hybrid Auto Mode

3 Other Shooting Modes

4 P Mode

5 Tv, Av, and M Mode

6 Playback Mode

7 Wi-Fi Functions

8 Setting Menu

9 Accessories

10 Appendix

Index

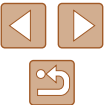

## Holding the Camera



- Place the strap around your neck.
- When shooting, keep your arms close to your body and hold the camera securely to prevent it from moving. If you have raised the flash, do not rest your fingers on it.

## Charging the Battery Pack

Before use, charge the battery pack with the included charger. Be sure to charge the battery pack initially, because the camera is not sold with the battery pack charged.

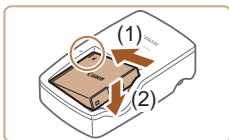

### 1 Insert the battery pack.

- After aligning the ▲ marks on the battery pack and charger, insert the battery pack by pushing it in (1) and down (2).

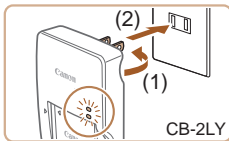

### 2 Charge the battery pack.

- CB-2LY: Flip out the plug (1) and plug the charger into a power outlet (2).
- CB-2LYE: Plug the power cord into the charger, then plug the other end into a power outlet.
- The charging lamp turns orange, and charging begins.
- When charging is finished, the lamp turns green.

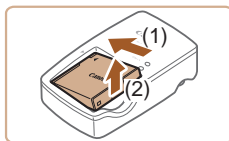
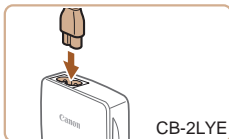

### 3 Remove the battery pack.

- After unplugging the battery charger, remove the battery pack by pushing it in (1) and up (2).



- To protect the battery pack and keep it in optimal condition, do not charge it continuously for more than 24 hours.
- For battery chargers that use a power cord, do not attach the charger or cord to other objects. Doing so could result in malfunction or damage to the product.



- For details on charging time and the number of shots and recording time possible with a fully charged battery pack, see “Number of Shots/Recording Time, Playback Time” (163).
- Charged battery packs gradually lose their charge, even when they are not used. Charge the battery pack on (or immediately before) the day of use.
- The charger can be used in areas with 100 – 240 V AC power (50/60 Hz). For power outlets in a different format, use a commercially available adapter for the plug. Never use an electrical transformer designed for traveling, which may damage the battery pack.

Before Use

Basic Guide

Advanced Guide

1 Camera Basics

2 Auto Mode / Hybrid Auto Mode

3 Other Shooting Modes

4 P Mode

5 Tv, Av, and M Mode

6 Playback Mode

7 Wi-Fi Functions

8 Setting Menu

9 Accessories

10 Appendix

Index



## Inserting the Battery Pack and Memory Card

Insert the included battery pack and a memory card (sold separately). Note that before using a new memory card (or a memory card formatted in another device), you should format the memory card with this camera (127).

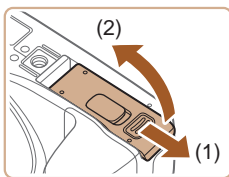

### 1 Open the cover.

- Slide the cover (1) and open it (2).

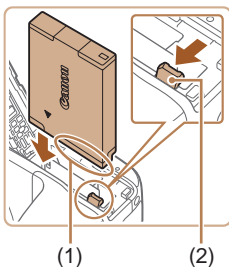

### 2 Insert the battery pack.

- Holding the battery pack with the terminals (1) facing as shown, press the battery lock (2) in the direction of the arrow and insert the battery pack until the lock clicks shut.
- If you insert the battery pack facing the wrong way, it cannot be locked into the correct position. Always confirm that the battery pack is facing the right way and locks when inserted.

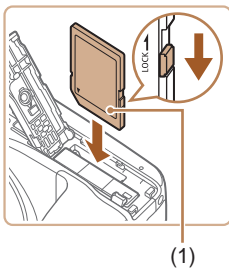

### 3 Check the card's write-protect tab and insert the memory card.

- Recording is not possible on memory cards with a write-protect tab when the tab is in the locked position. Slide the tab to the unlocked position.
- Insert the memory card with the label (1) facing as shown until it clicks into place.

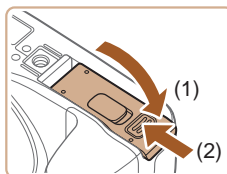

### 4 Close the cover.

- Lower the cover (1) and hold it down as you slide it, until it clicks into the closed position (2).



- For guidelines on how many shots or hours of recording can be saved on one memory card, see “Number of Shots per Memory Card” (164).

## Removing the Battery Pack and Memory Card

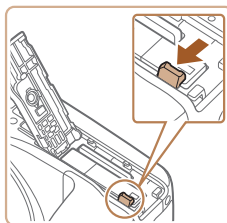

### Remove the battery pack.

- Open the cover and press the battery lock in the direction of the arrow.
- The battery pack will pop up.

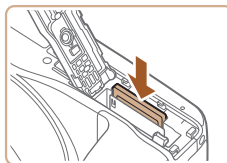

### Remove the memory card.

- Push the memory card in until it clicks, and then slowly release it.
- The memory card will pop up.

Before Use

Basic Guide

Advanced Guide

1 Camera Basics

2 Auto Mode / Hybrid Auto Mode

3 Other Shooting Modes

4 P Mode

5 Tv, Av, and M Mode

6 Playback Mode

7 Wi-Fi Functions

8 Setting Menu

9 Accessories

10 Appendix

Index

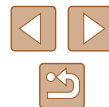

## Setting the Date and Time

Set the current date and time correctly as follows if the [Date/Time] screen is displayed when you turn the camera on. Information you specify this way is recorded in image properties when you shoot, and it is used when you manage images by shooting date or print images showing the date. You can also add a date stamp to shots, if you wish (43).



### 1 Turn the camera on.

- Press the power button.
- The [Date/Time] screen is displayed.

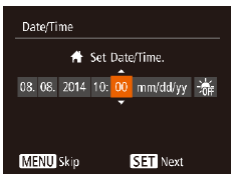

### 2 Set the date and time.

- Press the [◀][▶] buttons to choose an option.
- Press the [▲][▼] buttons to specify the date and time.
- When finished, press the [OK] button.

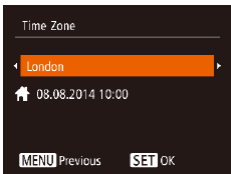

### 3 Specify your home time zone.

- Press the [◀][▶] buttons to choose your home time zone.



### 4 Finish the setup process.

- Press the [OK] button when finished. After a confirmation message, the setting screen is no longer displayed.
- To turn off the camera, press the power button.



- Unless you set the date, time, and home time zone, the [Date/Time] screen will be displayed each time you turn the camera on. Specify the correct information.



- To set daylight saving time (1 hour ahead), choose [DST] in step 2 and then choose [On] by pressing the [▲][▼] buttons.

## Changing the Date and Time

Adjust the date and time as follows.



### 1 Access the menu screen.

- Press the [MENU] button.

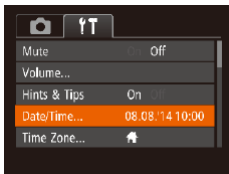

### 2 Choose [Date/Time].

- Move the zoom lever to choose the [↑] tab.
- Press the [▲][▼] buttons to choose [Date/Time], and then press the [OK] button.



Before Use
Basic Guide
Advanced Guide
<b>1</b> Camera Basics
<b>2</b> Auto Mode / Hybrid Auto Mode
<b>3</b> Other Shooting Modes
<b>4</b> P Mode
<b>5</b> Tv, Av, and M Mode
<b>6</b> Playback Mode
<b>7</b> Wi-Fi Functions
<b>8</b> Setting Menu
<b>9</b> Accessories
<b>10</b> Appendix

Index

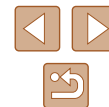

### 3 Change the date and time.

- Follow step 2 in “Setting the Date and Time” (📖20) to adjust the settings.
- Press the [MENU] button to close the menu screen.



- Date/time settings can be retained for about 3 weeks by the camera's built-in date/time battery (backup battery) after the battery pack is removed.
- The date/time battery will be charged in about 4 hours once you insert a charged battery pack or connect the camera to an AC adapter kit (sold separately, 📖132), even if the camera is left off.
- Once the date/time battery is depleted, the [Date/Time] screen will be displayed when you turn the camera on. Set the correct date and time as described in “Setting the Date and Time” (📖20).

## Display Language

Change the display language as needed.

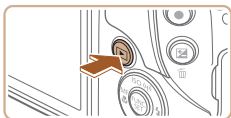

### 1 Enter Playback mode.

- Press the [▶] button.

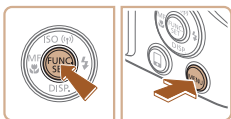

### 2 Access the setting screen.

- Press and hold the [ⓘ] button, and then immediately press the [MENU] button.

English	ノルスク	Română
Deutsch	Svenska	Türkçe
Français	Español	العربية
Nederlands	Ελληνικά	മലയാളം
Dansk	Русский	简体中文
Português	Polski	繁體中文
Suomi	Čeština	한국어



- The current time is displayed if you wait too long in step 2 after pressing the [ⓘ] button before you press the [MENU] button. In this case, press the [ⓘ] button to dismiss the time display and repeat step 2.
- You can also change the display language by pressing the [MENU] button and choosing [Language] (🗣️) on the [🔧] tab.

### 3 Set the display language.

- Press the [▲][▼][◀][▶] buttons to choose a language, and then press the [ⓘ] button.
- Once the display language has been set, the setting screen is no longer displayed.

Before Use

Basic Guide

Advanced Guide

1 Camera Basics

2 Auto Mode / Hybrid Auto Mode

3 Other Shooting Modes

4 P Mode

5 Tv, Av, and M Mode

6 Playback Mode

7 Wi-Fi Functions

8 Setting Menu

9 Accessories

10 Appendix

Index



# Trying the Camera Out

► Still Images ► Movies

Follow these instructions to turn the camera on, shoot still images or movies, and then view them.

## Shooting (Smart Auto)

For fully automatic selection of the optimal settings for specific scenes, simply let the camera determine the subject and shooting conditions.



### 1 Turn the camera on.

- Press the power button.
- The startup screen is displayed.



### 2 Enter [AUTO] mode.

- Set the mode dial to [AUTO].
- Aim the camera at the subject. The camera will make a slight clicking noise as it determines the scene.



- Icons representing the scene and image stabilization mode are displayed in the upper right of the screen.
- Frames displayed around any detected subjects indicate that they are in focus.

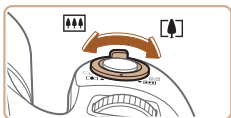

### 3 Compose the shot.

- To zoom in and enlarge the subject, move the zoom lever toward [▲] (telephoto), and to zoom away from the subject, move it toward [▼] (wide angle).

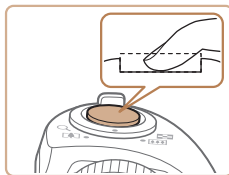
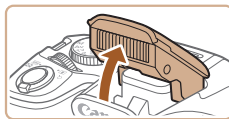
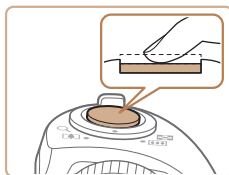

## 4 Shoot. Shooting Still Images

### 1) Focus.

- Press the shutter button lightly, halfway down. The camera beeps twice after focusing, and AF frames are displayed to indicate image areas in focus.
- If [Raise the flash] is displayed, lift the flash with your finger to prepare it for use. If you prefer not to use the flash, push it down with your finger, into the camera.

### 2) Shoot.

- Press the shutter button all the way down.
- As the camera shoots, a shutter sound is played, and in low-light conditions when you have raised the flash, it fires automatically.
- Keep the camera still until the shutter sound ends.
- After displaying your shot, the camera will revert to the shooting screen.

Before Use

Basic Guide

Advanced Guide

1 Camera Basics

2 Auto Mode / Hybrid Auto Mode

3 Other Shooting Modes

4 P Mode

5 Tv, Av, and M Mode

6 Playback Mode

7 Wi-Fi Functions

8 Setting Menu

9 Accessories

10 Appendix

Index

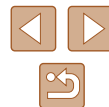



## Shooting Movies

### 1) Start shooting.

- Press the movie button. The camera beeps once as recording begins, and [●Rec] is displayed with the elapsed time (1).

(1)

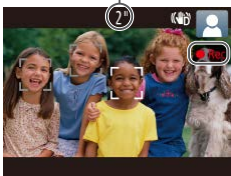

- Black bars are displayed on the top and bottom edges of the screen, and the subject is slightly enlarged. The black bars indicate image areas not recorded.
- Frames displayed around any detected faces indicate that they are in focus.
- Once recording begins, take your finger off the movie button.



### 2) Finish shooting.

- Press the movie button again to stop shooting. The camera beeps twice as recording stops.

## Viewing

After shooting images or movies, you can view them on the screen as follows.

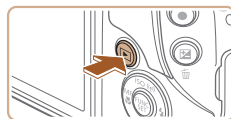

### 1 Enter Playback mode.

- Press the [▶] button.
- Your last shot is displayed.



### 2 Browse through your images.

- To view the previous image, press the [◀] button. To view the next image, press the [▶] button.



- To access this screen (Scroll Display mode), press and hold the [◀][▶] buttons for at least one second. In this mode, press the [◀][▶] buttons to browse through images.
- To return to single-image display, press the [⊙] button.
- Movies are identified by a [SET ▶] icon. To play movies, go to step 3.



Before Use

Basic Guide

Advanced Guide

1 Camera Basics

2 Auto Mode / Hybrid Auto Mode

3 Other Shooting Modes

4 P Mode

5 Tv, Av, and M Mode

6 Playback Mode

7 Wi-Fi Functions

8 Setting Menu

9 Accessories

10 Appendix

Index



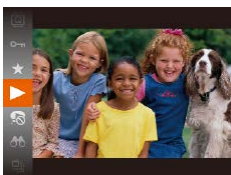

### 3 Play movies.

- Press the button, press the [][] buttons to choose [], and then press the button again.
- Playback now begins, and after the movie is finished, [SET ] is displayed.
- To adjust the volume, press the [][] buttons.



- To switch to Shooting mode from Playback mode, press the shutter button halfway.

## Erasing Images

You can choose and erase unneeded images one by one. Be careful when erasing images, because they cannot be recovered.

### 1 Choose an image to erase.

- Press the [][] buttons to choose an image.



### 2 Erase the image.

- Press the [] button.
- After [Erase?] is displayed, press the [][] buttons to choose [Erase], and then press the button.
- The current image is now erased.
- To cancel erasure, press the [][] buttons to choose [Cancel], and then press the button.



- You can choose multiple images to erase at once (88).

Before Use

Basic Guide

Advanced Guide

1 Camera Basics

2 Auto Mode / Hybrid Auto Mode

3 Other Shooting Modes

4 P Mode

5 Tv, Av, and M Mode

6 Playback Mode

7 Wi-Fi Functions

8 Setting Menu

9 Accessories

10 Appendix

Index





## Camera Basics

Other basic operations and more ways to enjoy your camera, including shooting and playback options

### On/Off



#### Shooting Mode

- Press the power button to turn the camera on and prepare for shooting.
- To turn the camera off, press the power button again.

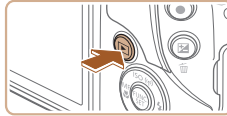

#### Playback Mode

- Press the [▶] button to turn the camera on and view your shots.
- To turn the camera off, press the [▶] button again.



- To switch to Playback mode from Shooting mode, press the [▶] button.
- To switch to Shooting mode from Playback mode, press the shutter button halfway (p. 26).
- The lens will be retracted after about one minute once the camera is in Playback mode. You can turn the camera off when the lens is retracted by pressing the [▶] button.

Before Use

Basic Guide

Advanced Guide

**1** Camera Basics

**2** Auto Mode / Hybrid Auto Mode

**3** Other Shooting Modes

**4** P Mode

**5** Tv, Av, and M Mode

**6** Playback Mode

**7** Wi-Fi Functions

**8** Setting Menu

**9** Accessories

**10** Appendix

Index

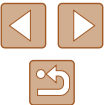

## Power-Saving Features (Auto Power Down)

As a way to conserve battery power, the camera automatically deactivates the screen (Display Off) and then turns itself off after a specific period of inactivity.

### Power Saving in Shooting Mode

The screen is automatically deactivated after about one minute of inactivity. In about two more minutes, the lens is retracted and the camera turns itself off. To activate the screen and prepare for shooting when the screen is off but the lens is still out, press the shutter button halfway (📖26).

### Power Saving in Playback Mode

The camera turns itself off automatically after about five minutes of inactivity.



- You can deactivate Auto Power Down and adjust the timing of Display Off, if you prefer (📖126).
- Power saving is not active while the camera is connected to other devices via Wi-Fi (📖97), or when connected to a computer (📖138).

## Shutter Button

To ensure your shots are in focus, always begin by holding the shutter button halfway down, and once the subject is in focus, press the button all the way down to shoot.

In this manual, shutter button operations are described as pressing the button *halfway* or *all the way down*.

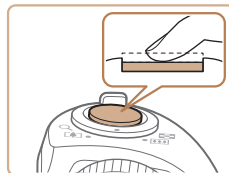

### 1 Press halfway. (Press lightly to focus.)

- Press the shutter button halfway. The camera beeps twice, and AF frames are displayed around image areas in focus.

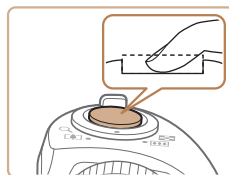

### 2 Press all the way down. (From the halfway position, press fully to shoot.)

- The camera shoots, as a shutter sound is played.
- Keep the camera still until the shutter sound ends.



- Images may be out of focus if you shoot without initially pressing the shutter button halfway.
- Length of shutter sound playback varies depending on the time required for the shot. It may take longer in some shooting scenes, and images will be blurry if you move the camera (or the subject moves) before the shutter sound ends.

Before Use

Basic Guide

Advanced Guide

1 Camera Basics

2 Auto Mode / Hybrid Auto Mode

3 Other Shooting Modes

4 P Mode

5 Tv, Av, and M Mode

6 Playback Mode

7 Wi-Fi Functions

8 Setting Menu

9 Accessories

10 Appendix

Index



## Shooting Modes

Use the mode dial to access each shooting mode.

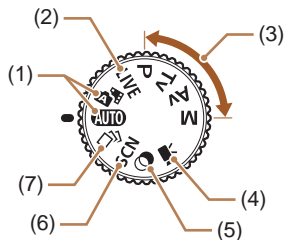

- |  |   |
|--|---|
| <p>(1) Auto Mode / Hybrid Auto Mode<br/>Fully automatic shooting, with camera-determined settings (📖22, 📖32, 📖34).</p> <p>(2) Live View Control Mode<br/>Customize image brightness or colors when shooting (📖51).</p> <p>(3) P, Tv, Av, and M Modes<br/>Take a variety of shots using your preferred settings (📖61, 📖74).</p> | <p>(4) Movie Mode<br/>For shooting movies (📖60). You can also shoot movies when the mode dial is not set to Movie mode, simply by pressing the movie button.</p> <p>(5) Creative Filters Mode<br/>Add a variety of effects to images when shooting (📖54).</p> <p>(6) Special Scene Mode<br/>Shoot with optimal settings for specific scenes (📖53).</p> <p>(7) Creative Shot Mode<br/>You can capture multiple still images with effects using camera-determined settings (📖52).</p> |
|--|---|

## Shooting Display Options

Press the [▼] button to view other information on the screen, or to hide the information. For details on the information displayed, see “On-Screen Information” (📖152).

	<p>Information is displayed</p>
	<p>No information is displayed</p>



- Screen brightness is automatically increased by the night view function when you are shooting under low light, making it easier to check how shots are composed. However, on-screen image brightness may not match the brightness of your shots. Note that any on-screen image distortion or jerky subject motion will not affect recorded images.
- For playback display options, see “Switching Display Modes” (📖78).

Before Use

Basic Guide

Advanced Guide

**1** Camera Basics

**2** Auto Mode / Hybrid Auto Mode

**3** Other Shooting Modes

**4** P Mode

**5** Tv, Av, and M Mode

**6** Playback Mode

**7** Wi-Fi Functions

**8** Setting Menu

**9** Accessories

**10** Appendix

Index



## Using the FUNC. Menu

Configure commonly used functions through the FUNC. menu as follows. Note that menu items and options vary depending on the shooting mode (📖 156) or playback mode (📖 162).

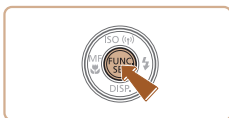

### 1 Access the FUNC. menu.

- Press the [FUNC.] button.

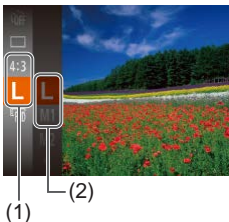

### 2 Choose a menu item.

- Press the [▲][▼] buttons to choose a menu item (1), and then press the [FUNC.] or [▶] button.
- Available options (2) are listed next to menu items, on the right.
- Depending on the menu item, functions can be specified simply by pressing the [FUNC.] or [▶] button, or another screen is displayed for configuring the function.



### 3 Choose an option.

- Press the [▲][▼] buttons to choose an option.
- Options labeled with a [MENU] icon can be configured by pressing the [MENU] button.
- To return to the menu items, press the [◀] button.



### 4 Finish the setup process.

- Press the [FUNC.] button.
- The screen before you pressed the [FUNC.] button in step 1 is displayed again, showing the option you configured.



- To undo any accidental setting changes, you can restore the camera's default settings (📖 130).

Before Use

Basic Guide

Advanced Guide

1 Camera Basics

2 Auto Mode / Hybrid Auto Mode

3 Other Shooting Modes

4 P Mode

5 Tv, Av, and M Mode

6 Playback Mode

7 Wi-Fi Functions

8 Setting Menu

9 Accessories

10 Appendix

Index

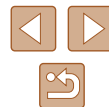

## Using the Menu Screen

Configure a variety of camera functions through the menu screen as follows. Menu items are grouped by purpose on tabs, such as shooting [📷], playback [▶], and so on. Note that available menu items vary depending on the selected shooting or playback mode (📖 157 – 📖 162).



### 1 Access the menu screen.

- Press the [MENU] button.

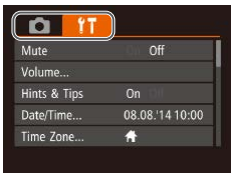

### 2 Choose a tab.

- Move the zoom lever to choose a tab.
- After you have turned the [🔍] dial or pressed the [▲][▼] buttons to choose a tab initially, you can switch between tabs by pressing the [◀][▶] buttons.

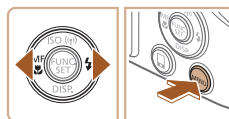
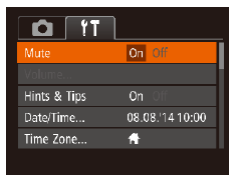
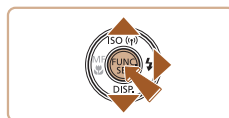
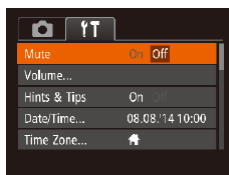

### 3 Choose a menu item.

- Press the [▲][▼] buttons to choose a menu item.
- For menu items with options not shown, first press the [⊕] or [▶] button to switch screens, and then press the [▲][▼] buttons to select the menu item.
- To return to the previous screen, press the [MENU] button.

### 4 Choose an option.

- Press the [◀][▶] buttons to choose an option.

### 5 Finish the setup process.

- Press the [MENU] button to return to the screen displayed before you pressed the [MENU] button in step 1.



- To undo any accidental setting changes, you can restore the camera's default settings (📖 130).

Before Use

Basic Guide

Advanced Guide

1 Camera Basics

2 Auto Mode / Hybrid Auto Mode

3 Other Shooting Modes

4 P Mode

5 Tv, Av, and M Mode

6 Playback Mode

7 Wi-Fi Functions

8 Setting Menu

9 Accessories

10 Appendix

Index

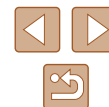

## On-Screen Keyboard

Use the on-screen keyboard to enter information for Wi-Fi connections (📖98). Note that the length and type of information you can enter varies depending on the function you are using.

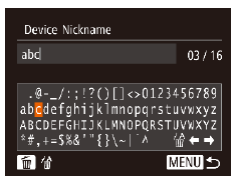

### Entering Characters

- Press the [▲][▼][◀][▶] buttons to choose a character, and then press the [⊞] button to enter it.

### Moving the Cursor

- Choose [◀] or [▶] and press the [⊞] button.

### Deleting Characters

- To delete the previous character, either press the [⏪] button or choose [⏪] and press the [⊞] button.

### Confirming Input and Returning to the Previous Screen

- Press the [MENU] button.



## Indicator Display

The indicator on the back of the camera (📖4) lights up or blinks depending on the camera status.

Color	Indicator Status	Camera Status
Green	On	Connected to a computer (📖138), or display off (📖26, 📖126, 📖126)
	Blinking	Starting up, recording/reading/transmitting images, shooting long exposures (📖74, 📖75), or connecting/transmitting via Wi-Fi



- When the indicator blinks green, never turn the camera off, open the memory card/battery cover, or shake or jolt the camera, which may corrupt images or damage the camera or memory card.

Before Use

Basic Guide

Advanced Guide

**1** Camera Basics

**2** Auto Mode / Hybrid Auto Mode

**3** Other Shooting Modes

**4** P Mode

**5** Tv, Av, and M Mode

**6** Playback Mode

**7** Wi-Fi Functions

**8** Setting Menu

**9** Accessories

**10** Appendix



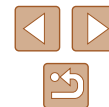

Index

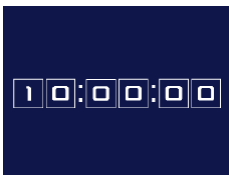

# Clock

You can check the current time.



- Press and hold the  button.
- The current time appears.
- If you hold the camera vertically while using the clock function, it will switch to vertical display. Press the   buttons to change the display color.
- Press the  button again to cancel the clock display.



- When the camera is off, press and hold the  button, then press the power button to display the clock.

Before Use

Basic Guide

Advanced Guide

**1** Camera Basics

**2** Auto Mode / Hybrid Auto Mode

**3** Other Shooting Modes

**4** P Mode

**5** Tv, Av, and M Mode

**6** Playback Mode

**7** Wi-Fi Functions

**8** Setting Menu

**9** Accessories

**10** Appendix

Index

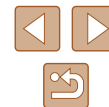

# 2

## Auto Mode / Hybrid Auto Mode

Convenient mode for easy shots with greater control over shooting

### Shooting with Camera-Determined Settings

For fully automatic selection of the optimal settings for specific scenes, simply let the camera determine the subject and shooting conditions.

#### Shooting (Smart Auto)

► Still Images ► Movies

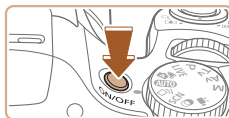

#### 1 Turn the camera on.

- Press the power button.
- The startup screen is displayed.



#### 2 Enter [AUTO] mode.

- Set the mode dial to [AUTO].
- Aim the camera at the subject. The camera will make a slight clicking noise as it determines the scene.
- Icons representing the scene and image stabilization mode are displayed in the upper right of the screen (📖36, 📖37).
- Frames displayed around any detected subjects indicate that they are in focus.



Before Use

Basic Guide

Advanced Guide

1 Camera Basics

2 Auto Mode / Hybrid Auto Mode

3 Other Shooting Modes

4 P Mode

5 Tv, Av, and M Mode

6 Playback Mode

7 Wi-Fi Functions

8 Setting Menu

9 Accessories

10 Appendix

Index

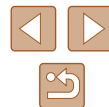



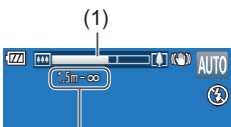
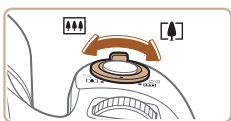

(2)

### 3 Compose the shot.

- To zoom in and enlarge the subject, move the zoom lever toward [👤] (telephoto), and to zoom away from the subject, move it toward [🌄] (wide angle). (A zoom bar (1) showing the zoom position is displayed, along with the area in focus (2).)
- To zoom in or out quickly, move the zoom lever all the way toward [👤] (telephoto) or [🌄] (wide angle), and to zoom in or out slowly, move it just a little in the desired direction.

### 4 Shoot.

#### Shooting Still Images

##### 1) Focus.

- Press the shutter button halfway. The camera beeps twice after focusing, and AF frames are displayed to indicate image areas in focus.
- Several AF frames are displayed when multiple areas are in focus.

- If [Raise the flash] is displayed, lift the flash with your finger to prepare it for use. If you prefer not to use the flash, push it down with your finger, into the camera.

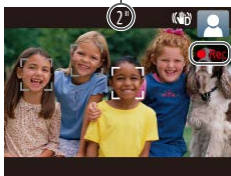
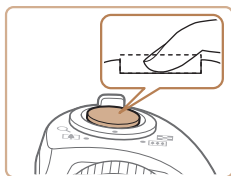
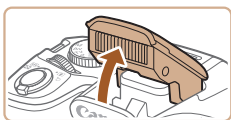
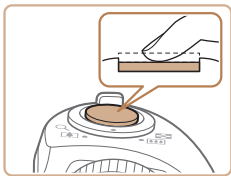

### 2) Shoot.

- Press the shutter button all the way down.
- As the camera shoots, a shutter sound is played, and in low-light conditions when you have raised the flash, it fires automatically.
- Keep the camera still until the shutter sound ends.
- After displaying your shot, the camera will revert to the shooting screen.

#### Shooting Movies

##### 1) Start shooting.

- Press the movie button. The camera beeps once as recording begins, and [●Rec] is displayed with the elapsed time (1).
- Black bars are displayed on the top and bottom edges of the screen, and the subject is slightly enlarged. The black bars indicate image areas not recorded.
- Frames displayed around any detected faces indicate that they are in focus.
- Once recording begins, take your finger off the movie button.

##### 2) Resize the subject and recompose the shot as needed.

- To resize the subject, repeat the operations in step 3. However, note that the sound of camera operations will be recorded. Note that movies shot at zoom factors shown in blue will look grainy.
- When you recompose shots, the focus, brightness, and colors will be automatically adjusted.

Before Use

Basic Guide

Advanced Guide

1 Camera Basics

2 Auto Mode / Hybrid Auto Mode

3 Other Shooting Modes

4 P Mode

5 Tv, Av, and M Mode

6 Playback Mode

7 Wi-Fi Functions

8 Setting Menu

9 Accessories

10 Appendix

Index





### 3) Finish shooting.

- Press the movie button again to stop shooting. The camera beeps twice as recording stops.
- Recording will stop automatically when the memory card becomes full.

## Shooting in Hybrid Auto Mode

► Still Images ► Movies

You can make a short movie of the day just by shooting still images. The camera records 2 – 4-second clips of scenes before each shot, which are later combined in a digest movie.



### 1 Enter [Smart Auto] mode.

- Follow step 2 in “Shooting (Smart Auto)” (📖32) and choose [Smart Auto].



### 2 Compose the shot.

- Follow steps 3 – 4 in “Shooting (Smart Auto)” (📖32) to compose the shot and focus.
- For more impressive digest movies, aim the camera at subjects about four seconds before shooting still images.

### 3 Shoot.

- Follow step 4 in “Shooting (Smart Auto)” (📖32) to shoot a still image.
- The camera records both a still image and movie clip. The clip, which ends with the still image and a shutter sound, forms a single chapter in the digest movie.



- Battery life is shorter in this mode than in [AUTO] mode, because digest movies are recorded for each shot.
- A digest movie may not be recorded if you shoot a still image immediately after turning the camera on, choosing [Smart Auto] mode, or operating the camera in other ways.
- Camera operating sounds will be recorded in digest movies.



- Digest movie quality is [FHD] and cannot be changed.
- Sounds are not played when you press the shutter button halfway or trigger the self-timer.
- Digest movies are saved as separate movie files in the following cases even if they were recorded on the same day in [Smart Auto] mode.
  - The digest movie file size reaches approximately 4 GB, or the total recording time reaches approximately 29 minutes and 59 seconds.
  - The digest movie is protected (📖85).
  - Daylight saving time (📖20) or time zone (📖125) settings are changed.
  - A new folder is created (📖129).
- Recorded shutter sounds cannot be modified or erased.
- If you prefer to record digest movies without still images, adjust the setting in advance. Choose MENU (📖29) > [Camera] tab > [Digest Type] > [No Stills] (📖29).
- Individual chapters can be edited (📖96).

## ■ Digest Movie Playback

Display a still image shot in [Smart Auto] mode to play a digest movie, or specify the date of the digest movie to play (📖79).

Before Use
Basic Guide
Advanced Guide
<b>1</b> Camera Basics
<b>2</b> Auto Mode / Hybrid Auto Mode
<b>3</b> Other Shooting Modes
<b>4</b> P Mode
<b>5</b> Tv, Av, and M Mode
<b>6</b> Playback Mode
<b>7</b> Wi-Fi Functions
<b>8</b> Setting Menu
<b>9</b> Accessories
<b>10</b> Appendix
Index

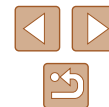

## Still Images/Movies



- If the camera is turned on while the [▼] button is held down, the camera will no longer sound. To activate sounds again, press the [MENU] button and choose [Mute] on the [F/T] tab, and then press the [◀] [▶] buttons to choose [Off].

## Still Images



- A blinking [📷] icon warns that images are more likely to be blurred by camera shake. In this case, mount the camera on a tripod or take other measures to keep it still.
- If your shots are dark despite the flash firing, move closer to the subject. For details on the flash range, see “Flash Range” (📖164).
- The subject may be too close if the camera only beeps once when you press the shutter button halfway. For details on the focusing range (shooting range), see “Shooting Range” (📖165).
- To reduce red-eye and to assist in focusing, the lamp may be activated when shooting in low-light conditions.
- A blinking [🔋] icon displayed when you attempt to shoot indicates that shooting is not possible until the flash has finished recharging. Shooting can resume as soon as the flash is ready, so either press the shutter button all the way down and wait, or release it and press it again.
- Although you can shoot again before the shooting screen is displayed, your previous shot may determine the focus, brightness, and colors used.



- You can change how long images are displayed after shots (📖49).

## Movies



- Before shooting a movie, lower the flash with your finger. Be careful not to touch the microphone (1) when shooting a movie. Leaving the flash raised, or blocking the microphone may prevent audio from being recorded or may cause the recording to sound muffled.



- Avoid touching camera controls other than the movie button when shooting movies, because sounds made by the camera will be recorded.
- Once movie recording begins, the image display area changes and subjects are enlarged to allow for correction of significant camera shake. To shoot subjects at the same size shown before shooting, adjust the image stabilization setting (📖73).



- Audio is recorded in stereo.

### Before Use

### Basic Guide

### Advanced Guide

#### 1 Camera Basics

#### 2 Auto Mode / Hybrid Auto Mode

#### 3 Other Shooting Modes

#### 4 P Mode

#### 5 Tv, Av, and M Mode

#### 6 Playback Mode

#### 7 Wi-Fi Functions

#### 8 Setting Menu

#### 9 Accessories

#### 10 Appendix

### Index

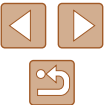

## Scene Icons

► Still Images ► Movies

In [AUTO] mode, shooting scenes determined by the camera are indicated by the icon displayed, and corresponding settings are automatically selected for optimal focusing, subject brightness, and color.

Background	When Shooting People			Icon Background Color																																							
	People	In Motion* <sup>1</sup>	Shadows on Face* <sup>1</sup>																																								
Bright				Gray																																							
Bright and Backlit			—																																								
With Blue Sky				Light Blue																																							
Blue Sky and Backlit			—																																								
Spotlights				Dark Blue																																							
Dark																																											
Dark, Using Tripod	<table border="1"> <thead> <tr> <th rowspan="2">Background</th> <th colspan="3">When Shooting Other Subjects</th> <th rowspan="2">Icon Background Color</th> </tr> <tr> <th>Other Subjects</th> <th>In Motion*<sup>1</sup></th> <th>At Close Range</th> </tr> </thead> <tbody> <tr> <td>Bright</td> <td></td> <td></td> <td></td> <td rowspan="2">Gray</td> </tr> <tr> <td>Bright and Backlit</td> <td></td> <td></td> <td></td> </tr> <tr> <td>With Blue Sky</td> <td></td> <td></td> <td></td> <td rowspan="2">Light Blue</td> </tr> <tr> <td>Blue Sky and Backlit</td> <td></td> <td></td> <td></td> </tr> <tr> <td>Sunsets</td> <td></td> <td></td> <td>—</td> <td>Orange</td> </tr> <tr> <td>Spotlights</td> <td></td> <td></td> <td></td> <td rowspan="3">Dark Blue</td> </tr> <tr> <td>Dark</td> <td></td> <td></td> <td></td> </tr> <tr> <td>Dark, Using Tripod</td> <td> <p>*<sup>1</sup> Not displayed for movies.</p> </td></tr></tbody></table>	Background	When Shooting Other Subjects			Icon Background Color	Other Subjects	In Motion* <sup>1</sup>	At Close Range	Bright				Gray	Bright and Backlit				With Blue Sky				Light Blue	Blue Sky and Backlit				Sunsets			—	Orange	Spotlights				Dark Blue	Dark				Dark, Using Tripod	<p>*<sup>1</sup> Not displayed for movies.</p>
Background	When Shooting Other Subjects			Icon Background Color																																							
	Other Subjects	In Motion* <sup>1</sup>	At Close Range																																								
Bright				Gray																																							
Bright and Backlit																																											
With Blue Sky				Light Blue																																							
Blue Sky and Backlit																																											
Sunsets			—	Orange																																							
Spotlights				Dark Blue																																							
Dark																																											
Dark, Using Tripod	<p>*<sup>1</sup> Not displayed for movies.</p>																																										

\*<sup>2</sup> Displayed in dark scenes when the camera is held still, as when mounted on a tripod.



- Try shooting in [P] mode (p.61) if the scene icon does not match actual shooting conditions, or if it is not possible to shoot with your expected effect, color, or brightness.

Before Use

Basic Guide

Advanced Guide

1 Camera Basics

2 Auto Mode / Hybrid Auto Mode

3 Other Shooting Modes

4 P Mode

5 Tv, Av, and M Mode

6 Playback Mode

7 Wi-Fi Functions

8 Setting Menu

9 Accessories

10 Appendix









Index



## Image Stabilization Icons



► Still Images ► Movies

Optimal image stabilization for the shooting conditions is automatically applied (Intelligent IS). Additionally, the following icons are displayed in  and **[AUTO]** modes.

	Image stabilization for still images (Normal)
	Image stabilization for still images when panning (Panning)*
	Image stabilization for macro shots. During movie recording,  is displayed, and image stabilization for macro movie recording is used (Hybrid IS).
	Image stabilization for movies, reducing strong camera shake, as when shooting while walking (Dynamic)
	Image stabilization for slow camera shake, such as when shooting movies at telephoto (Powered)
	No image stabilization, because the camera is mounted on a tripod or held still by other means. However, during movie recording,  is displayed, and image stabilization to counteract wind or other sources of vibration is used (Tripod IS).

\* Displayed when you pan, following moving subjects with the camera. When you follow subjects moving horizontally, image stabilization only counteracts vertical camera shake, and horizontal stabilization stops. Similarly, when you follow subjects moving vertically, image stabilization only counteracts horizontal camera shake.



- To cancel image stabilization, set [IS Mode] to [Off] (📖73). In this case, an IS icon is not displayed.
- In  mode, no  icon is displayed.

## On-Screen Frames

► Still Images ► Movies

In **[AUTO]** mode, a variety of frames are displayed once the camera detects subjects you are aiming the camera at.

- A white frame is displayed around the subject (or person's face) determined by the camera to be the main subject, and gray frames are displayed around other detected faces. Frames follow moving subjects within a certain range to keep them in focus. However, if the camera detects subject movement, only the white frame will remain on the screen.
- When you are pressing the shutter button halfway and the camera detects subject movement, a blue frame is displayed, and the focus and image brightness are constantly adjusted (Servo AF).



- Try shooting in **[P]** mode (📖61) if no frames are displayed, if frames are not displayed around desired subjects, or if frames are displayed on the background or similar areas.

Before Use

Basic Guide

Advanced Guide

**1** Camera Basics

**2** Auto Mode / Hybrid Auto Mode

**3** Other Shooting Modes

**4** P Mode

**5** Tv, Av, and M Mode

**6** Playback Mode

**7** Wi-Fi Functions

**8** Setting Menu

**9** Accessories

**10** Appendix

Index



## Common, Convenient Features

### Zooming In Closer on Subjects (Digital Zoom)

► Still Images ► Movies

When distant subjects are too far away to enlarge using the optical zoom, use digital zoom for up to about 200x enlargement.

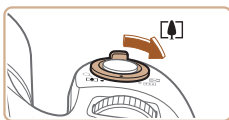

#### 1 Move the zoom lever toward [1].

- Hold the lever until zooming stops.
- Zooming stops at the largest possible zoom factor (before the image becomes noticeably grainy), which is then indicated on the screen.

#### 2 Move the zoom lever toward [1] again.

- The camera zooms in even closer on the subject.
- (1) is the current zoom factor.

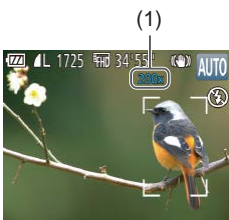

- Moving the zoom lever will display the zoom bar (which indicates the zoom position). The color of the zoom bar will change depending on the zoom range.
  - White range: optical zoom range where the image will not appear grainy.
  - Yellow range: digital zoom range where the image is not noticeably grainy (ZoomPlus).
  - Blue range: digital zoom range where the image will appear grainy.
- Because the blue range will not be available at some resolution settings (p.45), the maximum zoom factor can be achieved by following step 1.



- To deactivate digital zoom, choose MENU (p.29) > [Camera] tab > [Digital Zoom] > [Off].

Before Use

Basic Guide

Advanced Guide

1 Camera Basics

2 Auto Mode / Hybrid Auto Mode

3 Other Shooting Modes

4 P Mode

5 Tv, Av, and M Mode

6 Playback Mode

7 Wi-Fi Functions

8 Setting Menu

9 Accessories

10 Appendix

Index

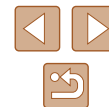

## Easily Reacquiring Subjects after Manual Zooming (Framing Assist – Seek)

► Still Images ► Movies

If you lose track of a subject while zoomed in, you can find it more easily by temporarily zooming out.

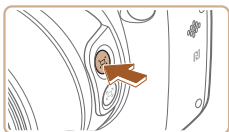

### 1 Look for the lost subject.

- Press and hold the [ ] button.
- The camera zooms out and displays a white frame around the area shown before you pressed the [ ] button.



### 2 Reacquire the subject.

- Aim the camera so that the subject enters the white frame, and then release the [ ] button.
- The previous magnification is now restored, so that the area within the white frame fills the screen again.



- Some shooting information is not displayed while the camera is zoomed out.
- During movie shooting, the white frame is not displayed if you press the [ ] button. Also note that a changed zoom factor and camera operating sounds are recorded.



- If you prefer to shoot at the zoom factor of the screen in step 1, press the shutter button all the way down.
- You can adjust the zoom factor that the camera reverts to when you release the [ ] button by moving the zoom lever to resize the white frame while you hold the [ ] button.
- To adjust the area displayed when the [ ] button is pressed, access MENU (29) > [ ] tab > [ ] Display Area, and choose one of the three options (29).
- The zoom factor cannot be changed with the [ ] button after you press the shutter button all the way down in self-timer mode (42).

## Easily Composing Shots after Manual Zooming (Framing Assist – Lock)

► Still Images ► Movies

You can reduce camera shake at the telephoto end, which makes it easier to compose shots.

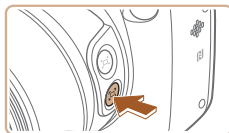

### 1 Compensate camera shake at the telephoto end.

- Press and hold the [ ] button. [ ] is displayed, and image stabilization optimal for shooting at the telephoto end is applied.

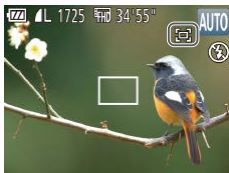

### 2 Shoot.

- While holding the [ ] button, press the shutter button halfway to focus on the subject, and then press it all the way down.

Before Use

Basic Guide

Advanced Guide

1 Camera Basics

2 Auto Mode / Hybrid Auto Mode

3 Other Shooting Modes

4 P Mode

5 Tv, Av, and M Mode

6 Playback Mode

7 Wi-Fi Functions

8 Setting Menu

9 Accessories

10 Appendix

Index





- The zoom factor cannot be adjusted by pressing the [ZOOM] button (P.39) while you are holding down the [ZOOM] button.
- Recomposing the shot while holding down the [ZOOM] button may make image stabilization less effective. In this case, [ZOOM] is displayed in gray. If this occurs, release the [ZOOM] button, compose the shot, and then press it again.
- If you start recording a movie while holding down the [ZOOM] button, image stabilization may cause the shot to be recomposed.



- Although no image stabilization icon is shown while you hold down the [ZOOM] button, image stabilization optimal for shooting at the telephoto end is applied.
- To fine-tune the size of subjects gradually, move the zoom lever while holding down the [ZOOM] button.

## Auto Zooming to Keep Faces at a Constant Size

► Still Images ► Movies

The camera automatically zooms in and out to keep a detected face (P.68) at a constant size on the screen. If the person moves closer, the camera automatically zooms out, and vice versa. This size can also be adjusted, as needed.

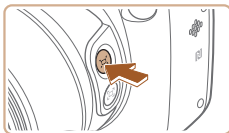

### 1 Enter [ZOOM] Auto mode.

- Press and release the [ZOOM] button quickly.
- [ZOOM] Auto: On] is displayed.

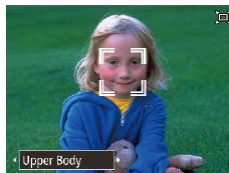

### 2 Choose the face.

- [ZOOM] is displayed once a face has been detected.
- If multiple faces are detected, press the [ZOOM] button to switch to the face to keep at a constant size.
- The camera zooms in and out to keep the face framed by [ZOOM] at a constant size on the screen.

### 3 Shoot.

- Even after you shoot, [ZOOM] remains around the face displayed at a constant size.
- To cancel constant face display size, press the [ZOOM] button again. [ZOOM] Auto: Off] is displayed.

## Adjusting the Constant Face Display Size



- When [ZOOM] Auto is on, press the [ZOOM] buttons or turn the [ZOOM] dial to choose the desired option.
- The camera zooms automatically to keep faces at the specified size.

Face	Keep faces large enough to show facial expressions clearly.
Upper Body	Keep faces small enough to show the person's upper body.
Whole Body	Keep faces small enough to show the person's entire body.
Manual	Keep faces at the size specified by moving the zoom lever. Release the zoom lever once the desired size has been obtained.

Before Use

Basic Guide

Advanced Guide

1 Camera Basics

2 Auto Mode / Hybrid Auto Mode

3 Other Shooting Modes

4 P Mode

5 Tv, Av, and M Mode

6 Playback Mode

7 Wi-Fi Functions

8 Setting Menu

9 Accessories

10 Appendix

Index

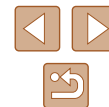





- A face may not be displayed at a constant size at some zoom factors, or if the subject's head is tilted or facing the camera indirectly.
- During movie recording, a changed zoom factor and camera operating sounds are recorded.
- When Auto is on, some shooting information is not displayed, and some shooting settings cannot be configured.



- If the person whose face is framed with moves toward the edge of the screen, the camera zooms out to keep the person in view.
- In step 3, switching to another face with the button is not possible during movie recording.
- The zoom factor remains the same after you press the shutter button all the way down in self-timer mode (p.42), even if the person's size relative to the screen changes.
- The face size can also be adjusted in MENU (p.29) > tab > Auto Settings > Auto Zoom. You can choose [Off] to deactivate this feature and use only the feature described in "Easily Reacquiring Subjects with Auto Zooming (Seek Assist)".
- You can zoom in or out with the zoom lever when [Face], [Upper Body], or [Whole Body] is selected, but the original zoom factor will be restored in a few seconds after you release the lever.
- You can clear your specified face size during movie recording by pressing the button.
- Face sizes cannot be changed during movie recording.

## Easily Reacquiring Subjects with Auto Zooming (Seek Assist)

► Still Images ► Movies

If you lose track of a subject while zoomed in and move the camera to look for it, the camera detects this movement and automatically zooms out, which makes it easier to find the subject.



### 1 Enter Auto mode (p.40).

### 2 Look for the lost subject.

- When you move the camera to look for the subject, the camera zooms out to help you find it.

### 3 Reacquire the subject.

- Once you find the subject and stop moving the camera, the camera zooms in again.



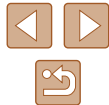

### 4 Shoot.

- To cancel this mode, press the button again. Auto: Off] is displayed.

Before Use
Basic Guide
Advanced Guide
<b>1</b> Camera Basics
<b>2</b> Auto Mode / Hybrid Auto Mode
<b>3</b> Other Shooting Modes
<b>4</b> P Mode
<b>5</b> Tv, Av, and M Mode
<b>6</b> Playback Mode
<b>7</b> Wi-Fi Functions
<b>8</b> Setting Menu
<b>9</b> Accessories
<b>10</b> Appendix
Index





- The camera does not zoom out automatically while  is displayed around a detected face, even if you move the camera.
- When the feature described in “Auto Zooming to Keep Faces at a Constant Size” is deactivated,  is displayed around a detected face, and the camera automatically zooms out when moved.
- Zooming is not possible while the shutter button is pressed halfway.
- To deactivate this feature and use only the feature described in “Auto Zooming to Keep Faces at a Constant Size”, choose MENU  >  tab >  Auto Settings > [Seek Assist] > [Off].





## Using the Self-Timer

► Still Images ► Movies

With the self-timer, you can include yourself in group photos or other timed shots. The camera will shoot about 10 seconds after you press the shutter button.



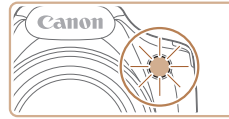

### 1 Configure the setting.

- Press the  button, choose  in the menu, and then choose  (42).
- Once the setting is complete,  is displayed.



## 2 Shoot.



- For Still Images: Press the shutter button halfway to focus on the subject, and then press it all the way down.
- For Movies: Press the movie button.
- Once you start the self-timer, the lamp will blink and the camera will play a self-timer sound.
- Two seconds before the shot, the blinking and sound will speed up. (The lamp will remain lit in case the flash fires.)
- To cancel shooting after you have triggered the self-timer, press the  button.
- To restore the original setting, choose  in step 1.

## Using the Self-Timer to Avoid Camera Shake

► Still Images ► Movies

This option delays shutter release until about two seconds after you have pressed the shutter button. If the camera is unsteady while you are pressing the shutter button, it will not affect your shot.



- Follow step 1 in “Using the Self-Timer” (42) and choose .
- Once the setting is complete,  is displayed.
- Follow step 2 in “Using the Self-Timer” (42) to shoot.

Before Use
Basic Guide
Advanced Guide
<b>1</b> Camera Basics
<b>2</b> Auto Mode / Hybrid Auto Mode
<b>3</b> Other Shooting Modes
<b>4</b> P Mode
<b>5</b> Tv, Av, and M Mode
<b>6</b> Playback Mode
<b>7</b> Wi-Fi Functions
<b>8</b> Setting Menu
<b>9</b> Accessories
<b>10</b> Appendix
Index



## Customizing the Self-Timer

► Still Images ► Movies

You can specify the delay (0 – 30 seconds) and number of shots (1 – 10).

### 1 Choose [C].

- Following step 1 in “Using the Self-Timer” (📖42), choose [C] and press the [MENU] button.



### 2 Configure the setting.

- Press the [▲][▼] buttons to choose [Delay] or [Shots].
- Press the [◀][▶] buttons to choose a value, and then press the [OK] button.
- Once the setting is complete, [C] is displayed.
- Follow step 2 in “Using the Self-Timer” (📖42) to shoot.



- For movies shot using the self-timer, [Delay] represents the delay before recording begins, but the [Shots] setting has no effect.



- When you specify multiple shots, image brightness and white balance are determined by the first shot. More time is required between shots when the flash fires or when you have specified to take many shots. Shooting will stop automatically when the memory card becomes full.
- When a delay longer than two seconds is specified, two seconds before the shot, the lamp blinking and self-timer sound will speed up. (The lamp will remain lit in case the flash fires.)

## Adding a Date Stamp

► Still Images ► Movies

The camera can add the shooting date to images, in the lower-right corner.

However, note that date stamps cannot be edited or removed, so confirm beforehand that the date and time are correct (📖20).

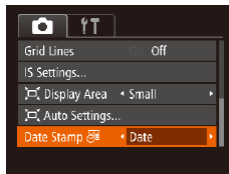
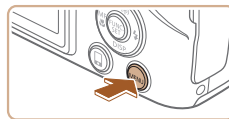

### 1 Configure the setting.

- Press the [MENU] button, choose [Date Stamp] on the [CAMERA] tab, and then choose the desired option (📖29).
- Once the setting is complete, [C] is displayed.

### 2 Shoot.

- As you take shots, the camera adds the shooting date or time to the lower-right corner of images.
- To restore the original setting, choose [Off] in step 1.



- Date stamps cannot be edited or removed.

Before Use

Basic Guide

Advanced Guide

1 Camera Basics

2 Auto Mode / Hybrid Auto Mode

3 Other Shooting Modes

4 P Mode

5 Tv, Av, and M Mode

6 Playback Mode

7 Wi-Fi Functions

8 Setting Menu

9 Accessories

10 Appendix

Index





- Shots taken without adding a date stamp can be printed with one as follows.

However, adding a date stamp this way to images that already have one may cause it to be printed twice.

- Print using printer functions (📖140)
- Use camera DPOF print settings (📖143) to print

## Continuous Shooting

▶ Still Images ▶ Movies

In [AUTO] mode, hold the shutter button all the way down to shoot continuously.

For details on the continuous shooting speed, see “Continuous Shooting Speed” (📖165).

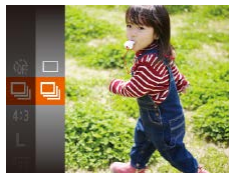

### 1 Configure the setting.

- Press the [FUNC] button, choose [ ] in the menu, and then choose [ ] (📖28).
- Once the setting is complete, [ ] is displayed.

### 2 Shoot.

- Hold the shutter button all the way down to shoot continuously.



- During continuous shooting, focus and exposure are locked at the position/level determined when you pressed the shutter button halfway.
- Cannot be used with the self-timer (📖42).
- Shooting may stop momentarily or continuous shooting may slow down depending on shooting conditions, camera settings, and the zoom position.
- As more shots are taken, shooting may slow down.
- Shooting may slow down if the flash fires.

Before Use

Basic Guide

Advanced Guide

**1** Camera Basics

**2** Auto Mode / Hybrid Auto Mode

**3** Other Shooting Modes

**4** P Mode

**5** Tv, Av, and M Mode

**6** Playback Mode

**7** Wi-Fi Functions

**8** Setting Menu

**9** Accessories

**10** Appendix

Index



## Image Customization Features

### Changing the Aspect Ratio

► Still Images ► Movies

Change the image aspect ratio (ratio of width to height) as follows.

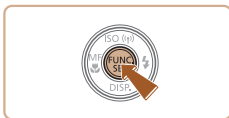

- Press the [ASPECT] button, choose [4:3] in the menu, and choose the desired option (16:9, 3:2, 4:3, 1:1).
- Once the setting is complete, the screen aspect ratio will be updated.
- To restore the original setting, repeat this process but choose [4:3].

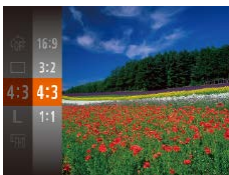

16:9	Used for display on widescreen HDTVs or similar display devices.
3:2	Same aspect ratio as 35mm film, used for printing images at 5 x 7-inch or postcard sizes.
4:3	Native aspect ratio of the camera screen, also used for display on standard-definition televisions or similar display devices, or for printing images at 3.5 x 5-inch or A-series sizes.
1:1	Square aspect ratio.



• Not available in [A/M] mode.

### Changing Image Resolution (Size)

► Still Images ► Movies

Choose from 4 levels of image resolution, as follows. For guidelines on how many shots at each resolution setting can fit on a memory card, see "Number of Shots per Memory Card" (164).

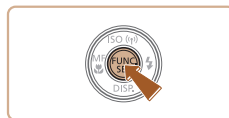

- Press the [RESOLUTION] button, choose [L] in the menu, and choose the desired option (L, M1, M2, S).
- The option you configured is now displayed.
- To restore the original setting, repeat this process but choose [L].

#### Guidelines for Choosing Resolution Based on Paper Size (for 4:3 Images)

L	A2 (16.5 x 23.4 in.)
M1	A3 – A5 (11.7 x 16.5 – 5.8 x 8.3 in.)
M2	3.5 x 5 in., 5 x 7 in., Postcard
S	For e-mailing and similar purposes



• Not available in [A/M] mode.

Before Use

Basic Guide

Advanced Guide

1 Camera Basics

2 Auto Mode / Hybrid Auto Mode

3 Other Shooting Modes

4 P Mode

5 Tv, Av, and M Mode

6 Playback Mode

7 Wi-Fi Functions

8 Setting Menu

9 Accessories

10 Appendix

Index



## Red-Eye Correction

► Still Images ► Movies

Red-eye that occurs in flash photography can be automatically corrected as follows.

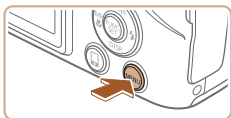

### 1 Access the [Flash Settings] screen.

- Press the [MENU] button, choose [Flash Settings] on the [ ] tab, and then press the [ ] button (129).

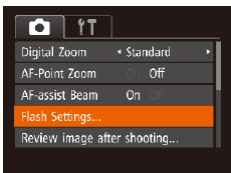

### 2 Configure the setting.

- Choose [Red-Eye Corr.], and then choose [On] (129).
- Once the setting is complete, [ ] is displayed.
- To restore the original setting, repeat this process but choose [Off].

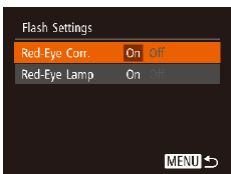

- Red-eye correction may be applied to image areas other than eyes (if the camera misinterprets red eye makeup as red pupils, for example).



- You can also correct existing images (94).
- You can also access the screen in step 2 when the flash is up by pressing the [ ] button and immediately pressing the [MENU] button.

## Changing Movie Image Quality

► Still Images ► Movies

3 image quality settings are available. For guidelines on the maximum movie length at each level of image quality that will fit on a memory card, see "Recording Time per Memory Card" (164).

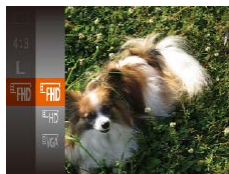
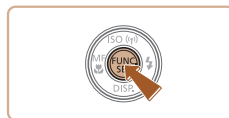

- Press the [ ] button, choose [Full HD] in the menu, and choose the desired option (28).
- The option you configured is now displayed.
- To restore the original setting, repeat this process but choose [Full HD].

Image Quality	Resolution	Frame Rate	Details
Full HD	1920 x 1080	30 fps	For shooting in Full HD
HD	1280 x 720	30 fps	For shooting in HD
VGA	640 x 480	30 fps	For shooting in standard definition



- In [Full HD] and [HD] modes, black bars displayed on the top and bottom edges of the screen indicate image areas not recorded.

Before Use

Basic Guide

Advanced Guide

1 Camera Basics

2 Auto Mode / Hybrid Auto Mode

3 Other Shooting Modes

4 P Mode

5 Tv, Av, and M Mode

6 Playback Mode

7 Wi-Fi Functions

8 Setting Menu

9 Accessories

10 Appendix

Index



## Helpful Shooting Features

### Displaying Grid Lines

► Still Images ► Movies

Grid lines can be displayed on the screen for vertical and horizontal reference while shooting.

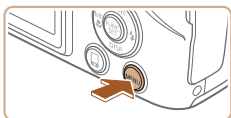

- Press the [MENU] button, choose [Grid Lines] on the [CAMERA] tab, and then choose [On] (p.29).
- Once the setting is complete, grid lines are displayed on the screen.
- To restore the original setting, repeat this process but choose [Off].

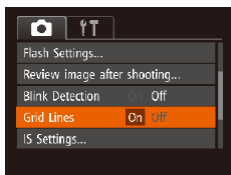

- Grid lines are not recorded in your shots.

### Magnifying the Area in Focus

► Still Images ► Movies

You can check the focus by pressing the shutter button halfway, which will enlarge the portion of the image in focus in the AF frame.

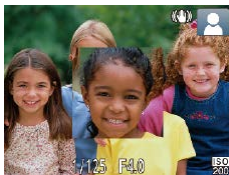
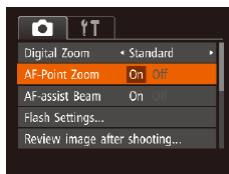

#### 1 Configure the setting.

- Press the [MENU] button, choose [AF-Point Zoom] on the [CAMERA] tab, and then choose [On] (p.29).

#### 2 Check the focus.

- Press the shutter button halfway. The face detected as the main subject is now magnified.
- To restore the original setting, choose [Off] in step 1.



- The area in focus is not magnified in the following cases when the shutter button is pressed halfway.
  - If a face was not detected, if the person is too close to the camera and their face is too large for the screen, or if the camera detects subject movement
  - When digital zoom is used (p.38)
  - When Tracking AF is used (p.69)
  - When a TV is used as a display (p.134)
- Not available in [B&W] mode.

Before Use

Basic Guide

Advanced Guide

1 Camera Basics

2 Auto Mode / Hybrid Auto Mode

3 Other Shooting Modes

4 P Mode

5 Tv, Av, and M Mode

6 Playback Mode

7 Wi-Fi Functions

8 Setting Menu

9 Accessories

10 Appendix

Index



## Checking for Closed Eyes

▶ Still Images ▶ Movies

 is displayed when the camera detects that people may have closed their eyes.

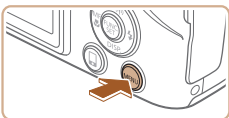

### 1 Configure the setting.

- Press the [MENU] button, choose [Blink Detection] on the  tab, and then choose [On] ([p.29](#)).

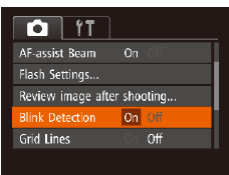

### 2 Shoot.

-  flashes when the camera detects a person whose eyes are closed.
- To restore the original setting, choose [Off] in step 1.



- When you have specified multiple shots in  mode, this function is only available for the final shot.
- A frame is displayed around people whose eyes are closed when you have selected [2 sec.], [4 sec.], [8 sec.], or [Hold] in [Display Time] ([p.49](#)).
- This feature is not available in continuous shooting mode ([p.44](#)).

## Customizing Camera Operation

Customize shooting functions on the  tab of the menu screen as follows.

For instructions on menu functions, see “Using the Menu Screen” ([p.29](#)).

## Deactivating the AF-Assist Beam

▶ Still Images ▶ Movies

You can deactivate the lamp that normally lights up to help you focus when you press the shutter button halfway in low-light conditions.

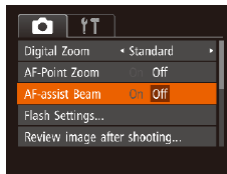

- Press the [MENU] button, choose [AF-assist Beam] on the  tab, and then choose [Off] ([p.29](#)).
- To restore the original setting, repeat this process but choose [On].

Before Use

Basic Guide

Advanced Guide

1 Camera Basics

2 Auto Mode / Hybrid Auto Mode

3 Other Shooting Modes

4 P Mode

5 Tv, Av, and M Mode

6 Playback Mode

7 Wi-Fi Functions

8 Setting Menu

9 Accessories

10 Appendix

Index





## Deactivating the Red-Eye Reduction Lamp

► Still Images ► Movies

You can deactivate the red-eye reduction lamp that lights up to reduce red-eye when the flash is used in low-light shots.

### 1 Access the [Flash Settings] screen.

- Press the [MENU] button, choose [Flash Settings] on the [📷] tab, and then press the [ⓘ] button (📖29).

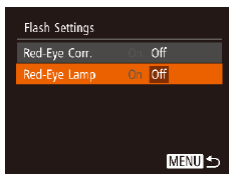

### 2 Configure the setting.

- Choose [Red-Eye Lamp], and then choose [Off] (📖29).
- To restore the original setting, repeat this process but choose [On].

## Changing the Image Display Style after Shots

► Still Images ► Movies

You can change how long images are displayed and what information is displayed immediately after shooting.

### Changing the Image Display Period after Shots

#### 1 Access the [Review image after shooting] screen.

- Press the [MENU] button, choose [Review image after shooting] on the [📷] tab, and then press the [ⓘ] button (📖29).

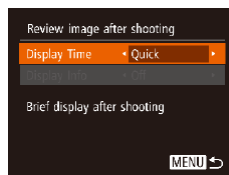

#### 2 Configure the setting.

- Choose [Display Time], and then choose the desired option.
- To restore the original setting, repeat this process but choose [Quick].

Quick	Displays images only until you can shoot again.
2 sec., 4 sec., 8 sec.	Displays images for the specified time. Even while the shot is displayed, you can take another shot by pressing the shutter button halfway again.
Hold	Displays images until you press the shutter button halfway.
Off	No image display after shots.

Before Use

Basic Guide

Advanced Guide

1 Camera Basics

2 Auto Mode /  
Hybrid Auto Mode

3 Other Shooting Modes

4 P Mode

5 Tv, Av, and M Mode

6 Playback Mode

7 Wi-Fi Functions

8 Setting Menu

9 Accessories

10 Appendix

Index

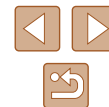

## Changing the Screen Displayed after Shots

Change the way images are displayed after shots as follows.

**1** Set [Display Time] to [2 sec.], [4 sec.], [8 sec.], or [Hold] (📖49).

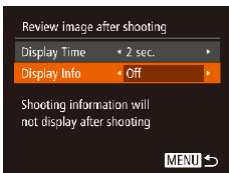

**2** Configure the setting.

- Choose [Display Info], and then choose the desired option.
- To restore the original setting, repeat this process but choose [Off].

Off	Displays only the image.
Detailed	Displays shooting details (📖153).



- When [Display Time] (📖32) is set to [Off] or [Quick], [Display Info] is set to [Off] and cannot be changed.
- By pressing the [▼] button while an image is displayed after shooting, you can switch the display information. Note that the settings of [Display Info] are not changed. You can also erase images by pressing the [🗑️] button, or protect (📖85) or tag images as favorites (📖91) by pressing the [🔖] button.

Before Use

Basic Guide

Advanced Guide

**1** Camera Basics

**2** Auto Mode / Hybrid Auto Mode

**3** Other Shooting Modes

**4** P Mode

**5** Tv, Av, and M Mode

**6** Playback Mode

**7** Wi-Fi Functions

**8** Setting Menu

**9** Accessories

**10** Appendix

Index

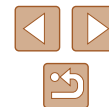

# 3

## Other Shooting Modes

Shoot more effectively in various scenes, and take shots enhanced with unique image effects or captured using special functions

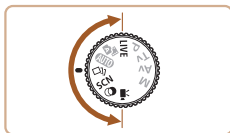

## Brightness / Color Customization (Live View Control)

► Still Images ► Movies

Image brightness or colors when shooting can be easily customized as follows.

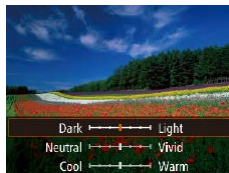

### 1 Enter [LIVE] mode.

- Set the mode dial to [LIVE].

### 2 Configure the setting.

- Press the [▼] button to access the setting screen. Press the [▲][▼] buttons to choose a setting item, and then press the [◀][▶] buttons to adjust the value as you watch the screen.
- Press the [Ⓜ] button.

### 3 Shoot.

Brightness	For brighter images, adjust the level to the right, and for darker images, adjust it to the left.
Color	For more vivid images, adjust the level to the right, and for more subdued images, adjust it to the left.
Tone	For a warm, reddish tone, adjust the level to the right, and for a cool, bluish tone, adjust it to the left.

Before Use

Basic Guide

Advanced Guide

1 Camera Basics

2 Auto Mode / Hybrid Auto Mode

3 Other Shooting Modes

4 P Mode

5 Tv, Av, and M Mode

6 Playback Mode

7 Wi-Fi Functions

8 Setting Menu

9 Accessories

10 Appendix

Index



## Enjoying a Variety of Images from Each Shot (Creative Shot)

► Still Images ► Movies

The camera determines the subject and shooting conditions, automatically applying special effects and recomposing the shot to emphasize the subject. Six still images are recorded for each shot. You can capture multiple still images with effects using camera-determined settings.



### 1 Enter [Creative Shot] mode.

- Set the mode dial to [Creative Shot].

### 2 Shoot.

- Press the shutter button all the way down. As you shoot, the shutter sound is played three times.
- After the six images are displayed in succession, they are displayed simultaneously for about two seconds.
- To keep the images displayed until you press the shutter button halfway, press the [Fn] button. For full-screen display in this state, choose an image by pressing the [▲][▼][◀][▶] buttons, and then press the [Fn] button.
- To return to the original display, press the [MENU] button.



- Shooting will take some time when the flash fires, but hold the camera steady until the shutter sound is played three times.

## Image Display during Playback

The six images from each shot are managed together as a group, and only the first image in the series is displayed during playback. To indicate that the image is part of a group, [SET] is displayed in the upper left of the screen.



- If you erase a grouped image (88), all images in the group are also erased. Be careful when erasing images.



- Grouped images can be played back individually (82) and ungrouped (82).
- Protecting (85) a grouped image will protect all images in the group.
- Grouped images can be viewed individually when played back using Image Search (81) or Smart Shuffle (85). In this case, images are temporarily ungrouped.
- The following actions are not available for grouped images: magnifying (83), tagging as favorites (91), editing (92), printing (140), setting up individual image printing (144), or adding to a photobook (145). To do these things, either view grouped images individually (82) or cancel grouping (82) first.
- Simultaneous display as shown in step 2 is only available immediately after you shoot.

Before Use

Basic Guide

Advanced Guide

1 Camera Basics

2 Auto Mode / Hybrid Auto Mode

3 Other Shooting Modes

4 P Mode

5 Tv, Av, and M Mode

6 Playback Mode

7 Wi-Fi Functions

8 Setting Menu

9 Accessories

10 Appendix

Index



## Choosing Effects

► Still Images ► Movies

You can choose effects for images captured in [ ] mode.



- After choosing [ ] mode, turn the [ ] dial to choose the effect.

Auto	All effects
Retro	Images resemble old photos
Monochrome	Images are generated in one color
Special	Bold, distinctive-looking images
Natural	Subdued, natural-looking images

## Specific Scenes

Choose a mode matching the shooting scene, and the camera will automatically configure the settings for optimal shots.



### 1 Enter [SCN] mode.

- Set the mode dial to [SCN].

### 2 Choose a shooting mode.

- Press the [ ] button, choose [ ] in the menu, and then choose a shooting mode (p.28).

### 3 Shoot.

#### Shooting Portraits (Portrait)

► Still Images ► Movies

- Take shots of people with a softening effect.

#### Shooting under Low Light (Low Light)

► Still Images ► Movies

- Shoot with minimal camera and subject shake even in low-light conditions.

Before Use

Basic Guide

Advanced Guide

1 Camera Basics

2 Auto Mode / Hybrid Auto Mode

3 Other Shooting Modes

4 P Mode

5 Tv, Av, and M Mode

6 Playback Mode

7 Wi-Fi Functions

8 Setting Menu

9 Accessories

10 Appendix

Index





## Shooting with Snowy Backgrounds (Snow)

▶ Still Images ▶ Movies

- Bright, natural-colored shots of people against snowy backgrounds.



## Shooting Fireworks (Fireworks)

▶ Still Images ▶ Movies

- Vivid shots of fireworks.



- In [❄️] mode, mount the camera on a tripod or take other measures to keep it still and prevent camera shake. Additionally, you should set [IS Mode] to [Off] when using a tripod or other means to secure the camera (📖73).



- [📷] mode resolution is [M] (2304 x 1728) and cannot be changed.
- In [❄️] mode, although no frames are displayed when you press the shutter button halfway, optimal focus is still determined.

## Image Effects (Creative Filters)

Add a variety of effects to images when shooting.



### 1 Enter [📷] mode.

- Set the mode dial to [📷].

### 2 Choose a shooting mode.

- Press the [📷] button, choose [📷] in the menu, and then choose a shooting mode (📖28).

### 3 Shoot.



## Shooting in Vivid Colors (Super Vivid)

▶ Still Images ▶ Movies

- Shots in rich, vivid colors.



## Posterized Shots (Poster Effect)

▶ Still Images ▶ Movies

- Shots that resemble an old poster or illustration.



- In [📷] and [📷] modes, try taking some test shots first, to make sure you obtain the desired results.

Before Use

Basic Guide

Advanced Guide

1 Camera Basics

2 Auto Mode / Hybrid Auto Mode

3 Other Shooting Modes

4 P Mode

5 Tv, Av, and M Mode

6 Playback Mode

7 Wi-Fi Functions

8 Setting Menu

9 Accessories

10 Appendix

Index



## Shooting with a Fish-Eye Lens Effect (Fish-Eye Effect)

► Still Images ► Movies

Shoot with the distorting effect of a fish-eye lens.

### 1 Choose [📷].

- Follow steps 1 – 2 in “Image Effects (Creative Filters)” (📖54) and choose [📷].

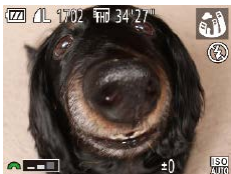

### 2 Choose an effect level.

- Turn the [🔆] dial to choose an effect level.
- A preview is shown of how your shot will look with the effect applied.

### 3 Shoot.



- Try taking some test shots first, to make sure you obtain the desired results.

## Shots Resembling Miniature Models (Miniature Effect)

► Still Images ► Movies

Creates the effect of a miniature model, by blurring image areas above and below your selected area.

You can also make movies that look like scenes in miniature models by choosing the playback speed before the movie is recorded. People and objects in the scene will move quickly during playback. Note that sound is not recorded.

### 1 Choose [📷].

- Follow steps 1 – 2 in “Image Effects (Creative Filters)” (📖54) and choose [📷].
- A white frame is displayed, indicating the image area that will not be blurred.

### 2 Choose the area to keep in focus.

- Press the [▼] button.
- Move the zoom lever to resize the frame, and press the [▲][▼] buttons to move it.



### 3 For movies, choose the movie playback speed.

- Turn the [🔆] dial to choose the speed.

### 4 Return to the shooting screen and shoot.

- Press the [📷] button to return to the shooting screen, and then shoot.



Before Use

Basic Guide

Advanced Guide

1 Camera Basics

2 Auto Mode / Hybrid Auto Mode

3 Other Shooting Modes

4 P Mode

5 Tv, Av, and M Mode

6 Playback Mode

7 Wi-Fi Functions

8 Setting Menu

9 Accessories

10 Appendix

Index



## Playback Speed and Estimated Playback Time (for One-Minute Clips)

Speed	Playback Time
5x	Approx. 12 sec.
10x	Approx. 6 sec.
20x	Approx. 3 sec.



- The zoom is not available when shooting movies. Be sure to set the zoom before shooting.
- Try taking some test shots first, to make sure you obtain the desired results.



- To switch the orientation of the frame to vertical, press the [◀][▶] buttons in step 2. To return the frame to horizontal orientation, press the [▲][▼] buttons.
- Holding the camera vertically will change the orientation of the frame.
- Movie image quality is [EVA] at an aspect ratio of [4:3] and [EHD] at an aspect ratio of [16:9] (□45). These quality settings cannot be changed.
- The zoom factor cannot be changed with the [□] button on the screens in steps 2 and 3, or while shooting movies.

## Shooting with a Toy Camera Effect (Toy Camera Effect)

▶ Still Images ▶ Movies

This effect makes images resemble shots from a toy camera by vignetting (darker, blurred image corners) and changing the overall color.

### 1 Choose [📷].

- Follow steps 1 – 2 in “Image Effects (Creative Filters)” (📖54) and choose [📷].

### 2 Choose a color tone.

- Turn the [🌞] dial to choose a color tone.
- A preview is shown of how your shot will look with the effect applied.

### 3 Shoot.



Standard	Shots resemble toy camera images.
Warm	Images have a warmer tone than with [Standard].
Cool	Images have a cooler tone than with [Standard].



- Try taking some test shots first, to make sure you obtain the desired results.

Before Use

Basic Guide

Advanced Guide

1 Camera Basics

2 Auto Mode / Hybrid Auto Mode

3 Other Shooting Modes

4 P Mode

5 Tv, Av, and M Mode

6 Playback Mode

7 Wi-Fi Functions

8 Setting Menu

9 Accessories

10 Appendix

Index





## Shooting in Monochrome

► Still Images ► Movies

Shoot images in black and white, sepia, or blue and white.

### 1 Choose [📷].

- Follow steps 1 – 2 in “Image Effects (Creative Filters)” (📖54) and choose [📷].



### 2 Choose a color tone.

- Turn the [🌞] dial to choose a color tone.
- A preview is shown of how your shot will look with the effect applied.

### 3 Shoot.

B/W	Black and white shots.
Sepia	Sepia tone shots.
Blue	Blue and white shots.

## Special Modes for Other Purposes

### Auto Shooting after Face Detection (Smart Shutter)

► Still Images ► Movies

#### Auto Shooting after Smile Detection

The camera shoots automatically after detecting a smile, even without you pressing the shutter button.

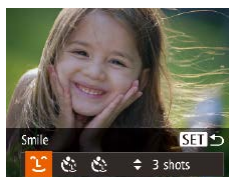

### 1 Choose [😊].

- Follow steps 1 – 2 in “Specific Scenes” (📖53) and choose [😊], and then press the [▼] button.
- Press the [◀][▶] buttons to choose [😊], and then press the [📷] button.
- The camera now enters shooting standby mode, and [Smile Detection on] is displayed.

### 2 Aim the camera at a person.

- To pause smile detection, press the [▲] button. Press the [▲] button again to resume detection.

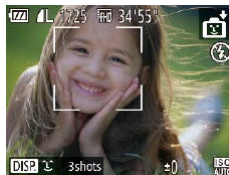

- Switch to another mode when you finish shooting, or the camera will continue shooting each time a smile is detected.

Before Use

Basic Guide

Advanced Guide

1 Camera Basics

2 Auto Mode / Hybrid Auto Mode

3 Other Shooting Modes

4 P Mode

5 Tv, Av, and M Mode

6 Playback Mode

7 Wi-Fi Functions

8 Setting Menu

9 Accessories

10 Appendix

Index

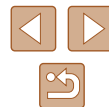



- You can also shoot as usual by pressing the shutter button.
- The camera can detect smiles more easily when subjects face the camera and open their mouth wide enough so that teeth are visible.
- To change the number of shots, press the [▲][▼] buttons after choosing [📷] in step 1. [Blink Detection] (📖48) is only available for the final shot.
- Automatic shooting is not available while you are holding down the [📷] button.

## Using the Wink Self-Timer

▶ Still Images ▶ Movies

Aim the camera at a person and press the shutter button all the way down. The camera will shoot about two seconds after a wink is detected.



### 1 Choose [📷].

- Follow steps 1 – 2 in “Specific Scenes” (📖53) and choose [📷], and then press the [▼] button.
- Press the [◀][▶] buttons to choose [📷], and then press the [📷] button.

### 2 Compose the shot and press the shutter button halfway.

- Make sure a green frame is displayed around the face of the person who will wink.

### 3 Press the shutter button all the way down.

- The camera now enters shooting standby mode, and [Wink to take picture] is displayed.
- The lamp blinks and the self-timer sound is played.



- If the wink is not detected, wink again slowly and deliberately.
- Winking may not be detected if eyes are obscured by hair, a hat, or glasses.
- Closing and opening both eyes at once will also be detected as a wink.
- If winking is not detected, the camera will shoot about 15 seconds later.
- To change the number of shots, press the [▲][▼] buttons after choosing [📷] in step 1. [Blink Detection] (📖48) is only available for the final shot.
- If no one is in the shooting area when the shutter button is pressed all the way down, the camera will shoot after a person enters the shooting area and winks.
- The zoom factor cannot be changed with the [📷] button after you press the shutter button all the way down.

## Using the Face Self-Timer

▶ Still Images ▶ Movies

The camera will shoot about two seconds after detecting that the face of another person (such as the photographer) has entered the shooting area (📖68). This is useful when including yourself in group photos or similar shots.



## 4 Face the camera and wink.

- The camera will shoot about two seconds after detecting a wink by the person whose face is inside the frame.
- To cancel shooting after you have triggered the self-timer, press the [MENU] button.

### 1 Choose [📷].

- Follow steps 1 – 2 in “Specific Scenes” (📖53) and choose [📷], and then press the [▼] button.
- Press the [◀][▶] buttons to choose [📷], and then press the [📷] button.

Before Use
Basic Guide
Advanced Guide
1 Camera Basics
2 Auto Mode / Hybrid Auto Mode
3 Other Shooting Modes
4 P Mode
5 Tv, Av, and M Mode
6 Playback Mode
7 Wi-Fi Functions
8 Setting Menu
9 Accessories
10 Appendix
Index

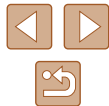

## 2 Compose the shot and press the shutter button halfway.

- Make sure a green frame is displayed around the face you focus on and white frames around other faces.

## 3 Press the shutter button all the way down.

- The camera now enters shooting standby mode, and [Look straight at camera to start count down] is displayed.
- The lamp blinks and the self-timer sound is played.

## 4 Join the subjects in the shooting area and look at the camera.

- After the camera detects a new face, the lamp blinking and self-timer sound will speed up. (When the flash fires, the lamp will remain lit.) About two seconds later, the camera will shoot.
- To cancel shooting after you have triggered the self-timer, press the [MENU] button.



- Even if your face is not detected after you join the others in the shooting area, the camera will shoot about 15 seconds later.
- To change the number of shots, press the [▲][▼] buttons after choosing [ ] in step 1. [Blink Detection] (48) is only available for the final shot.
- The zoom factor cannot be changed with the [ ] button after you press the shutter button all the way down.

## High-Speed Continuous Shooting (High-Speed Burst)

► Still Images ► Movies

You can shoot a series of shots in rapid succession by holding the shutter button all the way down. For details on the continuous shooting speed, see “Continuous Shooting Speed” (165).



### 1 Choose [ ].

- Follow steps 1 – 2 in “Specific Scenes” (53) and choose [ ].

### 2 Shoot.

- Hold the shutter button all the way down to shoot continuously.



- The resolution is [M] (2304 x 1728) and cannot be changed.
- Focus, image brightness, and color are determined by the first shot.
- Shooting may stop momentarily or continuous shooting may slow down depending on shooting conditions, camera settings, and the zoom position.
- As more shots are taken, shooting may slow down.

Before Use

Basic Guide

Advanced Guide

1 Camera Basics

2 Auto Mode / Hybrid Auto Mode

3 Other Shooting Modes

4 P Mode

5 Tv, Av, and M Mode

6 Playback Mode

7 Wi-Fi Functions

8 Setting Menu

9 Accessories

10 Appendix

Index



## Shooting Various Movies

▶ Still Images ▶ Movies

### Shooting Movies in Movie Mode

▶ Still Images ▶ Movies



#### 1 Enter [MOVIE] mode.

- Set the mode dial to [MOVIE].
- Black bars are displayed on the top and bottom edges of the screen, and the subject is slightly enlarged. The black bars indicate image areas not recorded.

#### 2 Configure the settings to suit the movie (📖 154).

#### 3 Shoot.

- Press the movie button.
- To stop movie recording, press the movie button again.

## Locking or Changing Image Brightness before Shooting

▶ Still Images ▶ Movies

Before recording, you can lock the exposure or change it in 1/3-stop increments within a range of -2 to +2 stops.



#### 1 Lock the exposure.

- Press the [LOCK] button to lock the exposure. The exposure shift bar is displayed.
- To unlock the exposure, press the [LOCK] button again.

#### 2 Adjust the exposure.

- Turn the [WHEEL] dial to adjust the exposure, as you watch the screen.

#### 3 Shoot (📖 60).

Before Use

Basic Guide

Advanced Guide

1 Camera Basics

2 Auto Mode / Hybrid Auto Mode

3 Other Shooting Modes

4 P Mode

5 Tv, Av, and M Mode

6 Playback Mode

7 Wi-Fi Functions

8 Setting Menu

9 Accessories

10 Appendix

Index

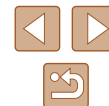

# 4

## P Mode

More discerning shots, in your preferred shooting style



- Instructions in this chapter apply to the camera with the mode dial set to **[P]** mode.
- **[P]**: Program AE; AE: Auto Exposure
- Before using a function introduced in this chapter in modes other than **[P]**, make sure the function is available in that mode (📖154).

## Shooting in Program AE ([P] Mode)

▶ Still Images ▶ Movies

You can customize many function settings to suit your preferred shooting style.



### 1 Enter [P] mode.

- Set the mode dial to **[P]**.

### 2 Customize the settings as desired (📖62 – 📖73), and then shoot.



- If adequate exposure cannot be obtained when you press the shutter button halfway, shutter speeds and aperture values are displayed in orange. In this case, try adjusting the ISO speed (📖63) or activating the flash (if subjects are dark, 📖71), which may enable adequate exposure.
- Movies can be recorded in **[P]** mode as well, by pressing the movie button. However, some FUNC. (📖28) and MENU (📖29) settings may be automatically adjusted for movie recording.

Before Use

Basic Guide

Advanced Guide

1 Camera Basics

2 Auto Mode / Hybrid Auto Mode

3 Other Shooting Modes

4 P Mode

5 Tv, Av, and M Mode

6 Playback Mode

7 Wi-Fi Functions

8 Setting Menu

9 Accessories

10 Appendix

Index

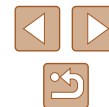

## Image Brightness (Exposure)

### Adjusting Image Brightness (Exposure Compensation)

► Still Images ► Movies

The standard exposure set by the camera can be adjusted in 1/3-stop increments, in a range of -2 to +2.

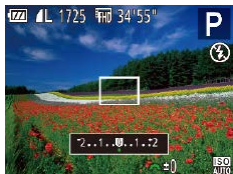

- Press the button. As you watch the screen, turn the dial to adjust brightness, and then press the button again when finished.
- The correction level you specified is now displayed.

### Locking Image Brightness / Exposure (AE Lock)

► Still Images ► Movies

Before shooting, you can lock the exposure, or you can specify focus and exposure separately.

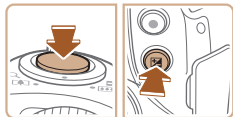

#### 1 Lock the exposure.

- Aim the camera at the subject to shoot with the exposure locked. With the shutter button pressed halfway, press the button.
- is displayed, and the exposure is locked.
- To unlock AE, release the shutter button and press the button again. In this case, is no longer displayed.

## 2 Compose the shot and shoot.



- AE: Auto Exposure
- After the exposure is locked, you can adjust the combination of shutter speed and aperture value by turning the dial (Program Shift).

### Changing the Metering Method

► Still Images ► Movies

Adjust the metering method (how brightness is measured) to suit shooting conditions as follows.



- Press the button, choose in the menu, and choose the desired option ( 28).
- The option you configured is now displayed.

Evaluative	For typical shooting conditions, including backlit shots. Automatically adjusts exposure to match the shooting conditions.
Center Weighted Avg.	Determines the average brightness of light across the entire image area, calculated by treating brightness in the central area as more important.
Spot	Metering restricted to within the  (Spot AE Point frame), displayed in the center of the screen.

Before Use

Basic Guide

Advanced Guide

1 Camera Basics

2 Auto Mode / Hybrid Auto Mode

3 Other Shooting Modes

4 P Mode

5 Tv, Av, and M Mode

6 Playback Mode

7 Wi-Fi Functions

8 Setting Menu

9 Accessories

10 Appendix

Index

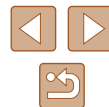

## Changing the ISO Speed

► Still Images ► Movies

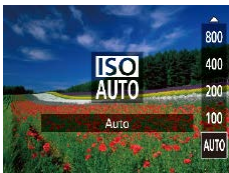

- Press the [▲] button, press the [▲][▼] buttons to choose an option, and then press the [OK] button.
- The option you configured is now displayed.

AUTO	Automatically adjusts the ISO speed to suit the shooting mode and conditions.	
100, 200	Low	For shooting outdoors in fair weather.
400, 800	Slightly Low	For shooting in cloudy conditions, or at twilight.
1600, 3200	Slightly High	For shooting night scenes, or in dark rooms.



- To view the automatically determined ISO speed when you have set the ISO speed to [AUTO], press the shutter button halfway.
- Although choosing a lower ISO speed may reduce image graininess, there may be a greater risk of subject and camera shake in some shooting conditions.
- Choosing a higher ISO speed will increase shutter speed, which may reduce subject and camera shake and increase the flash range. However, shots may look grainy.

## Correcting Image Brightness (i-Contrast)

► Still Images ► Movies

Before shooting, excessively bright or dark image areas (such as faces or backgrounds) can be detected and automatically adjusted to the optimal brightness. Insufficient overall image contrast can also be automatically corrected before shooting to make subjects stand out better.

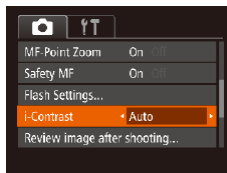

- Press the [MENU] button, choose [i-Contrast] on the [CAMERA] tab, and then choose [Auto] (p. 29).
- Once the setting is complete, [C*i*] is displayed.



- Under some shooting conditions, correction may be inaccurate or may cause images to appear grainy.



- You can also correct existing images (p. 94).

Before Use

Basic Guide

Advanced Guide

**1** Camera Basics

**2** Auto Mode / Hybrid Auto Mode

**3** Other Shooting Modes

**4** P Mode

**5** Tv, Av, and M Mode

**6** Playback Mode

**7** Wi-Fi Functions

**8** Setting Menu

**9** Accessories

**10** Appendix

Index



# Image Colors

## Adjusting White Balance

▶ Still Images ▶ Movies

By adjusting white balance (WB), you can make image colors look more natural for the scene you are shooting.



- Press the [WB] button, choose [AWB] in the menu, and choose the desired option (📖28).
- The option you configured is now displayed.

AWB	Auto	Automatically sets the optimal white balance for the shooting conditions.
☀️	Day Light	For shooting outdoors in fair weather.
☁️	Cloudy	For shooting in cloudy weather or at twilight.
💡	Tungsten	For shooting under ordinary incandescent lighting.
💡	Fluorescent	For shooting under white fluorescent lighting.
💡	Fluorescent H	For shooting under daylight fluorescent lighting.
📷	Custom	For manually setting a custom white balance (📖64).

## Custom White Balance

▶ Still Images ▶ Movies

For image colors that look natural under the light in your shot, adjust white balance to suit the light source where you are shooting. Set the white balance under the same light source that will illuminate your shot.



- Follow the steps in “Adjusting White Balance” (📖64) to choose [OFF].
- Aim the camera at a plain white subject, so that the entire screen is white. Press the [MENU] button.
- The tint of the screen changes once the white balance data has been recorded.



- Colors may look unnatural if you change camera settings after recording white balance data.

## Changing Image Color Tones (My Colors)

▶ Still Images ▶ Movies

Change image color tones as desired, such as converting images to sepia or black and white.



- Press the [WB] button, choose [OFF] in the menu, and choose the desired option (📖28).
- The option you configured is now displayed.

Before Use

Basic Guide

Advanced Guide

1 Camera Basics

2 Auto Mode / Hybrid Auto Mode

3 Other Shooting Modes

4 P Mode

5 Tv, Av, and M Mode

6 Playback Mode

7 Wi-Fi Functions

8 Setting Menu

9 Accessories

10 Appendix

Index

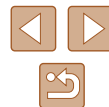



☞ My Colors Off	–
Av Vivid	Emphasizes contrast and color saturation, making images sharper.
AN Neutral	Tones down contrast and color saturation for subdued images.
As Sepia	Creates sepia tone images.
AW B/W	Creates black and white images.
AP Positive Film	Combines the effects of Vivid Blue, Vivid Green, and Vivid Red to produce intense yet natural-looking colors resembling images on positive film.
AL Lighter Skin Tone	Lightens skin tones.
AD Darker Skin Tone	Darkens skin tones.
AB Vivid Blue	Emphasizes blues in images. Makes the sky, ocean, and other blue subjects more vivid.
AG Vivid Green	Emphasizes greens in images. Makes mountains, foliage, and other green subjects more vivid.
AR Vivid Red	Emphasizes reds in images. Makes red subjects more vivid.
AC Custom Color	Adjust contrast, sharpness, color saturation, and other qualities as desired (65).



- White balance (64) cannot be set in [As] or [AW] modes.
- With [AL] and [AD] modes, colors other than people's skin tone may change. These settings may not produce the expected results with some skin tones.

## Custom Color

► Still Images ► Movies

Choose the desired level of image contrast, sharpness, color saturation, red, green, blue, and skin tones in a range of 1 – 5.

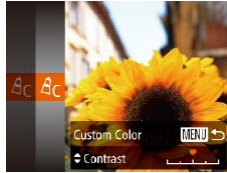

### 1 Access the setting screen.

- Follow the steps in “Changing Image Color Tones (My Colors)” (64) to choose [AC], and then press the [MENU] button.

### 2 Configure the setting.

- Press the [▲][▼] buttons to choose an option, and then specify the value by pressing the [◀][▶] buttons.
- For stronger/more intense effects (or darker skin tones), adjust the value to the right, and for weaker/lighter effects (or lighter skin tones), adjust the value to the left.
- Press the [MENU] button to complete the setting.

Before Use

Basic Guide

Advanced Guide

1 Camera Basics

2 Auto Mode / Hybrid Auto Mode

3 Other Shooting Modes

4 P Mode

5 Tv, Av, and M Mode

6 Playback Mode

7 Wi-Fi Functions

8 Setting Menu

9 Accessories

10 Appendix

Index



## Shooting Range and Focusing

### Shooting Close-Ups (Macro)

► Still Images ► Movies

To restrict the focus to subjects at close range, set the camera to [M]. For details on the focusing range, see “Shooting Range” (165).

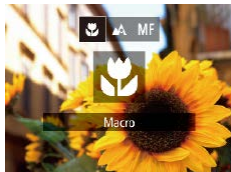

- Press the [L] button, press the [L][R] buttons to choose [M], and then press the [OK] button.
- Once the setting is complete, [M] is displayed.



- If the flash fires, vignetting may occur.
- Be careful to avoid damaging the lens.
- In the yellow bar display area below the zoom bar, [M] will turn gray and the camera will not focus.



- To prevent camera shake, try mounting the camera on a tripod and shooting with the camera set to [M] (42).

## Shooting in Manual Focus Mode

► Still Images ► Movies

When focusing is not possible in AF mode, use manual focus. You can specify the general focal position and then press the shutter button halfway to have the camera determine the optimal focal position near the position you specified. For details on the focusing range, see “Shooting Range” (165).



(1)

### 1 Choose [MF].

- Press the [L] button, press the [L][R] buttons to choose [MF], and then press the [OK] button.
- [MF] and the MF indicator are displayed.

### 2 Specify the general focal position.

- Referring to the on-screen MF indicator bar (1, which shows the distance and focal position) and the magnified display area, press the [▲][▼] buttons to specify the general focal position, and then press the [OK] button.

### 3 Fine-tune the focus.

- Press the shutter button halfway to have the camera fine-tune the focal position (Safety MF).

Before Use

Basic Guide

Advanced Guide

1 Camera Basics

2 Auto Mode / Hybrid Auto Mode

3 Other Shooting Modes

4 P Mode

5 Tv, Av, and M Mode

6 Playback Mode

7 Wi-Fi Functions

8 Setting Menu

9 Accessories

10 Appendix

Index

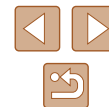



- When you focus manually, the AF frame mode (📖68) is [Center] and AF frame size is [Normal], and these settings cannot be changed.
- Focusing is possible when using the digital zoom (📖38) or digital tele-converter (📖67), or when using a TV as a display (📖134), but the magnified display will not appear.



- To focus more accurately, try attaching the camera to a tripod to stabilize it.
- To hide the magnified display area, choose MENU (📖29) > [📷] tab > [MF-Point Zoom] > [Off].
- To deactivate automatic focus fine-tuning when the shutter button is pressed halfway, choose MENU (📖29) > [📷] tab > [Safety MF] > [Off].

## Digital Tele-Converter

▶ Still Images ▶ Movies

The focal length of the lens can be increased by approximately 1.6x or 2.0x. This can reduce camera shake because the shutter speed is faster than it would be if you zoomed (including using digital zoom) in to the same zoom factor.

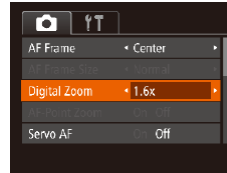

- Press the [MENU] button, choose [Digital Zoom] on the [📷] tab, and then choose the desired option (📖29).
- The view is enlarged and the zoom factor is displayed on the screen.



- The digital tele-converter cannot be used with digital zoom (📖38) or AF-point zoom (📖47).



- The shutter speed may be equivalent when you move the zoom lever all the way toward [📷] for maximum telephoto, and when you zoom in to enlarge the subject to the same size following step 2 in "Zooming In Closer on Subjects (Digital Zoom)" (📖38).

Before Use

Basic Guide

Advanced Guide

**1** Camera Basics

**2** Auto Mode / Hybrid Auto Mode

**3** Other Shooting Modes

**4** P Mode

**5** Tv, Av, and M Mode

**6** Playback Mode

**7** Wi-Fi Functions

**8** Setting Menu

**9** Accessories

**10** Appendix

Index

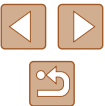

## Changing the AF Frame Mode

▶ Still Images ▶ Movies

Change the AF (auto focus) frame mode to suit the shooting conditions as follows.

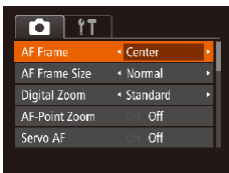

- Press the [MENU] button, choose [AF Frame] on the [CAMERA] tab, and then choose the desired option (📖29).

### Center

▶ Still Images ▶ Movies

One AF frame is displayed in the center. Effective for reliable focusing.



- A yellow AF frame is displayed with [L] if the camera cannot focus when you press the shutter button halfway.



- To reduce the AF frame size, press the [MENU] button and set [AF Frame Size] on the [CAMERA] tab to [Small] (📖29).
- The AF frame size is set to [Normal] when you use the digital zoom (📖38) or digital tele-converter (📖67), and in manual focus mode (📖66).
- To compose shots so that subjects are positioned at the edge or in a corner, first aim the camera to capture the subject in an AF frame, and then hold the shutter button halfway down. As you continue to hold the shutter button halfway, recompose the shot as desired, and then press the shutter button all the way down (Focus Lock).
- The AF frame position is enlarged when you press the shutter button halfway and [AF-Point Zoom] (📖47) is set to [On].

## Face AiAF

▶ Still Images ▶ Movies

- Detects people's faces, and then sets the focus, exposure (evaluative metering only), and white balance ([WB] only).
- After you aim the camera at the subject, a white frame is displayed around the person's face determined by the camera to be the main subject, and up to two gray frames are displayed around other detected faces.
- When the camera detects movement, frames will follow moving subjects, within a certain range.
- After you press the shutter button halfway, up to nine green frames are displayed around faces in focus.



- If faces are not detected, or when only gray frames are displayed (without a white frame), up to nine green frames are displayed in the areas in focus when you press the shutter button halfway.
- If faces are not detected when Servo AF (📖69) is set to [On], the AF frame is displayed in the center of the screen when you press the shutter button halfway.
- Examples of faces that cannot be detected:
  - Subjects that are distant or extremely close
  - Subjects that are dark or light
  - Faces in profile, at an angle, or partly hidden
- The camera may misinterpret non-human subjects as faces.
- No AF frames are displayed if the camera cannot focus when you press the shutter button halfway.

Before Use

Basic Guide

Advanced Guide

1 Camera Basics

2 Auto Mode / Hybrid Auto Mode

3 Other Shooting Modes

4 P Mode

5 Tv, Av, and M Mode

6 Playback Mode

7 Wi-Fi Functions

8 Setting Menu

9 Accessories

10 Appendix

Index



## Choosing Subjects to Focus On (Tracking AF)

► Still Images ► Movies

Shoot after choosing a subject to focus on as follows.

### 1 Choose [Tracking AF].

- Follow the steps in “Changing the AF Frame Mode” (68) to choose [Tracking AF].
- [ ] is displayed in the center of the screen.



### 2 Choose a subject to focus on.

- Aim the camera so that [ ] is on the desired subject, and then press the [ ] button.



- When the subject is detected, the camera beeps and [ ] is displayed. Even if the subject moves, the camera will continue to track the subject within a certain range.
- If no subject is detected, [ ] is displayed.
- To cancel tracking, press the [ ] button again.

### 3 Shoot.

- Press the shutter button halfway. [ ] changes to a blue [ ], which follows the subject as the camera continues to adjust the focus and exposure (Servo AF) (69).
- Press the shutter button all the way down to shoot.
- Even after your shot, [ ] is still displayed and the camera continues to track the subject.



- [Servo AF] (69) is set to [On] and cannot be changed.
- Tracking may not be possible when subjects are too small or move too rapidly, or when subject color or brightness matches that of the background too closely.
- [AF-Point Zoom] on the [ ] tab is not available.
- [ ] is not available.



- The camera can detect subjects even if you press the shutter button halfway without pressing the [ ] button. After your shot, [ ] is displayed in the center of the screen.
- When shooting in [MF] mode (66), press and hold the [ ] button for at least one second.

## Shooting with Servo AF

► Still Images ► Movies

This mode helps avoid missing shots of subjects in motion, because the camera continues to focus on the subject and adjust the exposure as long as you press the shutter button halfway.

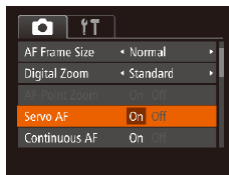

### 1 Configure the setting.

- Press the [MENU] button, choose [Servo AF] on the [ ] tab, and then choose [On] (29).

### 2 Focus.

- The focus and exposure are maintained where the blue AF frame is displayed while you are pressing the shutter button halfway.

Before Use

Basic Guide

Advanced Guide

1 Camera Basics

2 Auto Mode / Hybrid Auto Mode

3 Other Shooting Modes

4 P Mode

5 Tv, Av, and M Mode

6 Playback Mode

7 Wi-Fi Functions

8 Setting Menu

9 Accessories

10 Appendix

Index

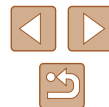



- Focusing may not be possible in some shooting conditions.
- In low-light conditions, Servo AF may not be activated (AF frames may not turn blue) when you press the shutter button halfway. In this case, the focus and exposure are set according to the specified AF frame mode.
- If adequate exposure cannot be obtained, shutter speeds and aperture values are displayed in orange. Release the shutter button, and then press it halfway again.
- AF lock shooting is not available.
- [AF-Point Zoom] on the [CAMERA] tab (p.29) is not available.
- Not available when using the self-timer (p.42).

## Changing the Focus Setting

▶ Still Images ▶ Movies

You can change default camera operation of constantly focusing on subjects it is aimed at, even when the shutter button is not pressed. Instead, you can limit camera focusing to the moment you press the shutter button halfway.



- Press the [MENU] button, choose [Continuous AF] on the [CAMERA] tab, and then choose [Off] (p.29).

On	Helps avoid missing sudden photo opportunities, because the camera constantly focuses on subjects until you press the shutter button halfway.
Off	Conserves battery power, because the camera does not focus constantly.

## Shooting with the AF Lock

▶ Still Images ▶ Movies

The focus can be locked. After you lock the focus, the focal position will not change even when you release your finger from the shutter button.

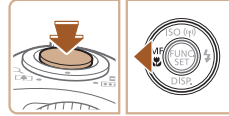

### 1 Lock the focus.

- With the shutter button pressed halfway, press the [AF-L] button.
- The focus is now locked, and [MF] and the MF indicator are displayed.
- To unlock the focus, hold the shutter button halfway down and press the [AF-L] button again.

### 2 Compose the shot and shoot.

Before Use

Basic Guide

Advanced Guide

1 Camera Basics

2 Auto Mode / Hybrid Auto Mode

3 Other Shooting Modes

4 P Mode

5 Tv, Av, and M Mode

6 Playback Mode

7 Wi-Fi Functions

8 Setting Menu

9 Accessories

10 Appendix

Index

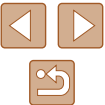

# Flash

## Changing the Flash Mode

► Still Images ► Movies

You can change the flash mode to match the shooting scene. For details on the flash range, see “Flash Range” (📖164).



### 1 Lift the flash.

### 2 Configure the setting.

- Press the [▶] button, press the [◀|▶] buttons to choose a flash mode, and then press the [OK] button.
- The option you configured is now displayed.



- The setting screen cannot be accessed by pressing the [▶] button when the flash is lowered. Lift the flash with your finger in advance.
- If the flash fires, vignetting may occur.

### Auto

Fires automatically in low-light conditions.

### On

Fires for each shot.

### Slow Synchro

Fires to illuminate the main subject (such as people) while shooting at a slower shutter speed to illuminate backgrounds out of flash range.



- In [📷] mode, mount the camera on a tripod or take other measures to keep it still and prevent camera shake. Additionally, you should set [IS Mode] to [Off] when using a tripod or other means to secure the camera (📖73).
- In [📷] mode, even after the flash fires, ensure that the main subject does not move until the shutter sound is finished playing.

### Off

For shooting without the flash.



- If a blinking [📷] icon is displayed when you press the shutter button halfway in camera-shake inducing, low-light conditions, mount the camera on a tripod or take other measures to keep it still.

Before Use

Basic Guide

Advanced Guide

1 Camera Basics

2 Auto Mode / Hybrid Auto Mode

3 Other Shooting Modes

4 P Mode

5 Tv, Av, and M Mode

6 Playback Mode

7 Wi-Fi Functions

8 Setting Menu

9 Accessories

10 Appendix

Index

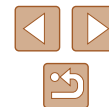

## Adjusting the Flash Exposure Compensation

► Still Images ► Movies

Just as with regular exposure compensation (📖62), you can adjust the flash exposure from -2 to +2 stops, in 1/3-stop increments.



- Raise the flash, press the [▶] button and immediately turn the [🔆] dial to choose the compensation level, and then press the [⊕] button.
- Once the setting is complete, [🔆] is displayed.



- When there is a risk of overexposure, the camera automatically adjusts the shutter speed or aperture value during the flash shots to reduce washed-out highlights and shoot at optimal exposure. However, you can deactivate automatic adjustment of the shutter speed and aperture value by accessing MENU (📖29) and choosing [📷] tab > [Flash Settings] > [Safety FE] > [Off].
- You can also configure the flash exposure compensation by accessing MENU (📖29) and choosing [📷] tab > [Flash Settings] > [Flash Exp. Comp].
- You can also access the [Flash Settings] MENU screen (📖29) when the flash is up by pressing the [▶] button and immediately pressing the [MENU] button.

## Shooting with the FE Lock

► Still Images ► Movies

Just as with the AE lock (📖62), you can lock the exposure for the flash shots.

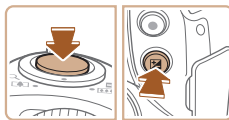

**1 Lift the flash and set the flash to [🔆] (📖71).**

**2 Lock the flash exposure.**

- Aim the camera at the subject to shoot with the exposure locked. With the shutter button pressed halfway, press the [🔆] button.
- The flash fires, and when [✳] is displayed, the flash output level is retained.
- To unlock FE, release the shutter button and press the [🔆] button again. In this case, [✳] is no longer displayed.

**3 Compose the shot and shoot.**

- After one shot, FE is unlocked and [✳] is no longer displayed.



- FE: Flash Exposure

Before Use

Basic Guide

Advanced Guide

**1** Camera Basics

**2** Auto Mode / Hybrid Auto Mode

**3** Other Shooting Modes

**4** P Mode

**5** Tv, Av, and M Mode

**6** Playback Mode

**7** Wi-Fi Functions

**8** Setting Menu

**9** Accessories

**10** Appendix

Index

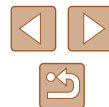



## Other Settings

### Changing the Compression Ratio (Image Quality)

► Still Images ► Movies

Choose from two compression ratios, [S] (Super Fine) and [F] (Fine), as follows. For guidelines on how many shots at each compression ratio can fit on a memory card, see “Number of Shots per Memory Card” (164).



- Press the [MENU] button, choose [F] in the menu, and choose the desired option (28).

### Changing the IS Mode Settings

► Still Images ► Movies

#### 1 Access the setting screen.

- Press the [MENU] button, choose [IS Settings] on the [CAMERA] tab, and then press the [MENU] button (29).

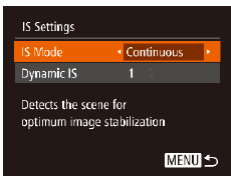

#### 2 Configure the setting.

- Choose [IS Mode], and then choose the desired option (29).

Continuous	Optimal image stabilization for the shooting conditions is automatically applied (Intelligent IS) (37).
Shoot Only*	Image stabilization is active only at the moment of shooting.
Off	Deactivates image stabilization.

\* The setting is changed to [Continuous] for movie recording.



- If image stabilization cannot prevent camera shake, mount the camera on a tripod or take other measures to hold it still. In this case, set [IS Mode] to [Off].

### Shooting Movies with Subjects at the Same Size Shown before Shooting

► Still Images ► Movies

Normally, once movie recording begins, the image display area changes and subjects are enlarged to allow for correction of significant camera shake. To shoot subjects at the same size shown before shooting, you can choose not to reduce significant camera shake.

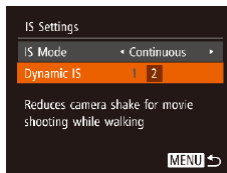

- Follow the steps in “Changing the IS Mode Settings” (73) to access the [IS Settings] screen.
- Choose [Dynamic IS], and then choose [2] (29).



- You can also set [IS Mode] to [Off], so that subjects are recorded at the same size shown before shooting.

Before Use

Basic Guide

Advanced Guide

1 Camera Basics

2 Auto Mode / Hybrid Auto Mode

3 Other Shooting Modes

4 P Mode

5 Tv, Av, and M Mode

6 Playback Mode

7 Wi-Fi Functions

8 Setting Menu

9 Accessories

10 Appendix

Index



# 5

## Tv, Av, and M Mode

Take smarter, more sophisticated shots

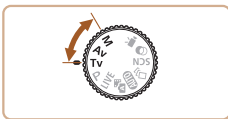

- Instructions in this chapter apply to the camera as set to the respective mode.

## Specific Shutter Speeds ([Tv] Mode)

► Still Images ► Movies

Set your preferred shutter speed before shooting as follows. The camera automatically adjusts the aperture value to suit your shutter speed. For details on available shutter speeds, see “Shutter Speed” (165).



### 1 Enter [Tv] mode.

- Set the mode dial to [Tv].

### 2 Set the shutter speed.

- Turn the  dial to set the shutter speed.



- In conditions requiring slower shutter speeds, there may be a delay before you can shoot again, as the camera processes images to reduce noise.
- When shooting at low shutter speeds on a tripod, you should set [IS Mode] to [Off] (73).
- With shutter speeds of 1.3 seconds or slower, ISO speed is  $\frac{150}{1000}$  and cannot be changed.
- Orange display of aperture values when you press the shutter button halfway indicates that the settings deviate from standard exposure. Adjust the shutter speed until the aperture value is displayed in white, or use safety shift (75).



- [Tv]: Time value

Before Use

Basic Guide

Advanced Guide

1 Camera Basics

2 Auto Mode / Hybrid Auto Mode

3 Other Shooting Modes

4 P Mode

5 Tv, Av, and M Mode

6 Playback Mode

7 Wi-Fi Functions

8 Setting Menu

9 Accessories

10 Appendix

Index

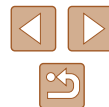

## Specific Aperture Values ([Av] Mode)

► Still Images ► Movies

Set your preferred aperture value before shooting as follows. The camera automatically adjusts the shutter speed to suit your aperture value. For details on available aperture values, see “Aperture” (165).



### 1 Enter [Av] mode.

- Set the mode dial to [Av].

### 2 Set the aperture value.

- Turn the [Aperture] dial to set the aperture value.



- Orange display of shutter speeds when you press the shutter button halfway indicates that the settings deviate from standard exposure. Adjust the aperture value until the shutter speed is displayed in white, or use safety shift (see below).



- [Av]: Aperture value (size of the opening made by the iris in the lens)
- To avoid exposure problems in [Tv] and [Av] modes, you can have the camera automatically adjust the shutter speed or aperture value, even when standard exposure cannot otherwise be obtained. Press the [MENU] button and set [Safety Shift] on the [Camera] tab to [On] (29). However, safety shift is disabled when the flash fires.

## Specific Shutter Speeds and Aperture Values ([M] Mode)

► Still Images ► Movies

Follow these steps before shooting to set your preferred shutter speed and aperture value to obtain the desired exposure. For details on available shutter speeds and aperture values, see “Shutter Speed” (165) and “Aperture” (165).



(1)

(2)

(3)

(4)



### 1 Enter [M] mode.

- Set the mode dial to [M].

### 2 Configure the setting.

- Press the [Shutter] button, choose adjustment of shutter speed (1) or aperture value (2), and turn the [Aperture] dial to specify a value.
- An exposure level mark (4) based on your specified value is shown on the exposure level indicator for comparison to the standard exposure level (3).
- The exposure level mark is shown in orange when the difference from standard exposure exceeds 2 stops. [-2] or [+2] is displayed in orange in the lower right when you press the shutter button halfway.

Before Use

Basic Guide

Advanced Guide

1 Camera Basics

2 Auto Mode / Hybrid Auto Mode

3 Other Shooting Modes

4 P Mode

5 Tv, Av, and M Mode

6 Playback Mode

7 Wi-Fi Functions

8 Setting Menu

9 Accessories

10 Appendix

Index





- After you set the shutter speed or aperture value, the exposure level may change if you adjust the zoom or recompose the shot.
- Screen brightness may change depending on your specified shutter speed or aperture value. However, screen brightness remains the same when the flash is up and the mode is set to [⚡].
- To have the setting you did not configure in step 2 (whether shutter speed or aperture value) automatically adjusted to obtain standard exposure, hold the shutter button halfway and press the [⚡] button. Note that standard exposure may not be possible with some settings.
- With shutter speeds of 1.3 seconds or slower, ISO speed is [150/100] and cannot be changed.



- [M]: Manual
- Calculation of standard exposure is based on the specified metering method (62).

## Adjusting the Flash Output

▶ Still Images ▶ Movies

Choose from the three flash levels in [M] mode.

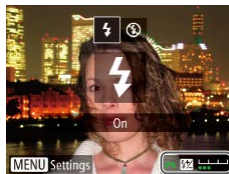

### 1 Enter [M] mode.

- Set the mode dial to [M].

### 2 Configure the setting.

- Raise the flash, press the [▶] button and immediately turn the [☀️] dial to choose the flash level, and then press the [⊞] button.
- Once the setting is complete, [⚡] is displayed.



- You can also set the flash level by accessing MENU (29) and choosing [📷] tab > [Flash Settings] > [Flash Output].
- You can set the flash level in [TV] or [Av] mode by accessing MENU (29) and choosing [📷] tab > [Flash Settings] > [Flash Mode] > [Manual].
- You can also access the [Flash Settings] MENU screen (29) when the flash is up by pressing the [▶] button and immediately pressing the [MENU] button.

Before Use

Basic Guide

Advanced Guide

1 Camera Basics

2 Auto Mode / Hybrid Auto Mode

3 Other Shooting Modes

4 P Mode

5 Tv, Av, and M Mode

6 Playback Mode

7 Wi-Fi Functions

8 Setting Menu

9 Accessories

10 Appendix

Index



# 6

## Playback Mode

Have fun reviewing your shots, and browse or edit them in many ways

- To prepare the camera for these operations, press the [▶] button to enter Playback mode.



- It may not be possible to play back or edit images that were renamed or already edited on a computer, or images from other cameras.

## Viewing

▶ Still Images ▶ Movies

After shooting images or movies, you can view them on the screen as follows.

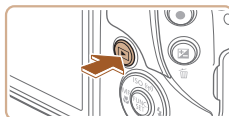

### 1 Enter Playback mode.

- Press the [▶] button.
- Your last shot is displayed.



### 2 Browse through your images.

- To view the previous image, press the [◀] button. To view the next image, press the [▶] button.

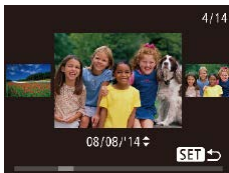

- To access this screen (Scroll Display mode), press and hold the [◀][▶] buttons for at least one second. In this mode, press the [◀][▶] buttons to browse through images.
- To return to single-image display, press the [⊞] button.
- To browse images grouped by shooting date, press the [▲][▼] buttons in Scroll Display mode.

Before Use

Basic Guide

Advanced Guide

1 Camera Basics

2 Auto Mode / Hybrid Auto Mode

3 Other Shooting Modes

4 P Mode

5 Tv, Av, and M Mode

6 Playback Mode

7 Wi-Fi Functions

8 Setting Menu

9 Accessories

10 Appendix

Index

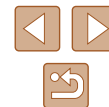



- Movies are identified by a [SET] icon. To play movies, go to step 3.

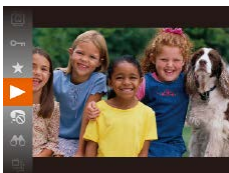

### 3 Play movies.

- To start playback, press the [M] button, press the [▲][▼] buttons to choose [▶], and then press the [M] button again.



(1)

### 4 Adjust the volume.

- Press the [▲][▼] buttons to adjust the volume.
- To adjust the volume when the volume indicator (1) is no longer displayed, press the [▲][▼] buttons.

### 5 Pause playback.

- To pause or resume playback, press the [M] button.
- After the movie is finished, [SET] icon is displayed.





- To switch to Shooting mode from Playback mode, press the shutter button halfway.
- To deactivate Scroll Display, choose MENU (129) > [▶] tab > [Scroll Display] > [Off].
- To have the most recent shot displayed when you enter Playback mode, choose MENU (129) > [▶] tab > [Resume] > [Last shot].
- To change the transition shown between images, access MENU (129) and choose your desired effect on the [▶] tab > [Transition].

## Switching Display Modes

▶ Still Images ▶ Movies

Press the [▼] button to view other information on the screen, or to hide the information. For details on the information displayed, see “Playback (Detailed Information Display)” (153).

	No Information Display
	Simple Information Display
	Detailed Information Display

Before Use

Basic Guide

Advanced Guide

1 Camera Basics

2 Auto Mode / Hybrid Auto Mode

3 Other Shooting Modes

4 P Mode

5 Tv, Av, and M Mode

6 Playback Mode

7 Wi-Fi Functions

8 Setting Menu

9 Accessories

10 Appendix

Index



## Overexposure Warning (for Image Highlights)

▶ Still Images ▶ Movies

Washed-out highlights in the image flash on the screen in detailed information display (📖78).

## Histogram

▶ Still Images ▶ Movies

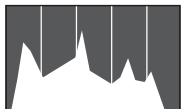

- The graph in detailed information display (📖78) is a histogram showing the distribution of brightness in the image. The horizontal axis represents the degree of brightness, and the vertical axis, how much of the image is at each level of brightness. Viewing the histogram is a way to check exposure.

## GPS Information Display

▶ Still Images ▶ Movies

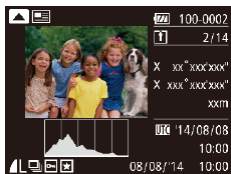

- Using a smartphone connected to the camera via Wi-Fi, you can geotag images on the camera, adding information such as latitude, longitude, and elevation (📖120). Geotagged images are labeled with a [📍] icon in detailed information display. Press the [▲] button to view the information recorded.
- Latitude, longitude, elevation, and UTC (shooting date and time) are listed from top to bottom.
- Press the [▲] button again to return to detailed information display.



- GPS information display is not available for images that lack this information.
- [---] is shown instead of numerical values for items not available on your smartphone or items not recorded correctly.



- UTC: Coordinated Universal Time, essentially the same as Greenwich Mean Time

## Viewing Short Movies Created When Shooting Still Images (Digest Movies)

▶ Still Images ▶ Movies

View digest movies recorded automatically in [📷] mode (📖34) on a day of still image shooting as follows.

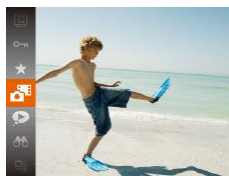

### 1 Choose an image.

- Still images shot in [📷] mode are labeled with an [SET 📷] icon.

### 2 Play the movie.

- Press the [🔍] button, and then choose [📷] in the menu (📖28).
- The movie recorded automatically on the day of still image shooting is played back, from the beginning.



- After a moment, [SET 📷] will no longer be displayed when you are using the camera with information display deactivated (📖78).

Before Use

Basic Guide

Advanced Guide

1 Camera Basics

2 Auto Mode / Hybrid Auto Mode

3 Other Shooting Modes

4 P Mode

5 Tv, Av, and M Mode

6 Playback Mode

7 Wi-Fi Functions

8 Setting Menu

9 Accessories

10 Appendix

Index



## Viewing by Date

Digest movies can be viewed by date.

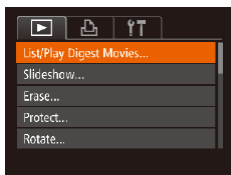

### 1 Choose a movie.

- Press the [MENU] button, choose [List/Play Digest Movies] on the [▶] tab, and then choose a date (📅29).

### 2 Play the movie.

- Press the [▶] button to start playback.

## Browsing and Filtering Images

### Navigating through Images in an Index

▶ Still Images ▶ Movies

By displaying multiple images in an index, you can quickly find the images you are looking for.

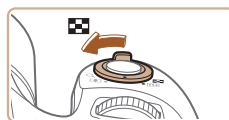

### 1 Display images in an index.

- Move the zoom lever toward [📐] to display images in an index. Moving the lever again will increase the number of images shown.
- To display fewer images, move the zoom lever toward [Q]. Fewer images are shown each time you move the lever.



### 2 Choose an image.

- Press the [▲][▼][◀][▶] buttons to choose an image.
- An orange frame is displayed around the selected image.
- Press the [Ⓜ] button to view the selected image in single-image display.

Before Use

Basic Guide

Advanced Guide

1 Camera Basics

2 Auto Mode / Hybrid Auto Mode

3 Other Shooting Modes

4 P Mode

5 Tv, Av, and M Mode

6 Playback Mode

7 Wi-Fi Functions

8 Setting Menu

9 Accessories

10 Appendix

Index





## Finding Images Matching Specified Conditions

► Still Images ► Movies

Find desired images quickly on a memory card full of images by filtering image display according to your specified conditions. You can also protect (📖85) or delete (📖88) these images all at once.

👤 People	Displays images with detected faces.
📅 Shot Date	Displays the images shot on a specific date.
★ Favorites	Displays images tagged as favorites (📖91).
📷 Still image/Movie	Displays still images, movies, or movies shot in [📷] mode (📖34).

### 1 Choose a search condition.

- Press the [🔍] button, choose [📖] in the menu, and choose a condition (📖28).
- When you have selected [📅] or [👤], choose the condition by pressing the [▲][▼][◀][▶] buttons on the screen displayed, and then press the [🔍] button.

### 2 View the filtered images.

- Images matching your conditions are displayed in yellow frames. To view only these images, press the [◀][▶] buttons.
- To cancel filtered display, choose [📷] in step 1.



- When the camera has found no corresponding images for some conditions, those conditions will not be available.



- To show or hide information, press the [▼] button in step 2.
- Options for viewing the images found (in step 2) include “Navigating through Images in an Index” (📖80), “Magnifying Images” (📖83), and “Viewing Slideshows” (📖84). You can also apply image operations to all images found, by choosing [Protect All Images in Search] in “Protecting Images” (📖85) or [Select All Images in Search] in “Erasing Multiple Images at Once” (📖88), “Adding Images to the Print List (DPOF)” (📖143), or “Adding Images to a Photobook” (📖145).
- If you edit images and save them as new images (📖92 – 📖96), a message is displayed, and the images that were found are no longer shown.

## Using the Front Dial to Jump between Images

👤 Jump to Favorites	Displays images tagged as favorites (📖91).
📅 Jump Shot Date	Jumps to the first image in each group of images that were shot on the same date.
📷 Jump 10 Images	Jumps by 10 images at a time.
📷 Jump 100 Images	Jumps by 100 images at a time.

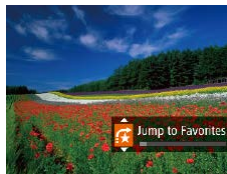

### 1 Choose a condition.

- Choose a condition (or jump method) in single-image display by turning the [📷] dial and then pressing the [▲][▼] buttons.

Before Use

Basic Guide

Advanced Guide

1 Camera Basics

2 Auto Mode / Hybrid Auto Mode

3 Other Shooting Modes

4 P Mode

5 Tv, Av, and M Mode

6 Playback Mode

7 Wi-Fi Functions

8 Setting Menu

9 Accessories

10 Appendix

Index



## 2 View images matching your specified condition, or jump by the specified amount.

- Turn the [ ] dial to view only images matching the condition or jump by the specified number of images forward or back.



- When the camera has found no corresponding images for some conditions, those conditions will not be available.



- Turning the [ ] dial when browsing images in index display will jump to the previous or next image according to the jump method chosen in single-image display. However, if you have chosen [ ] or [ ], the jump method will be switched to [ ].
- Options for viewing the images found (in step 2) include “Navigating through Images in an Index” (80), “Magnifying Images” (83), and “Viewing Slideshows” (84). You can also apply image operations to all images found, by choosing [Protect All Images in Search] in “Protecting Images” (85) or [Select All Images in Search] in “Erasing Multiple Images at Once” (88), “Adding Images to the Print List (DPOF)” (143), or “Adding Images to a Photobook” (145).
- If you edit images and save them as new images (92 – 94), a message is displayed, and the images that were found are no longer shown.

## Viewing Individual Images in a Group

► Still Images ► Movies

Images shot in [ ] or [ ] mode (52, 59) are grouped for display, and these grouped images can be viewed one at a time.



### 1 Choose a grouped image.

- Press the [ ] buttons to choose an image labeled with [SET ].



### 2 Choose [ ].

- Press the [ ] button, and then choose [ ] in the menu (28).



### 3 View images in the group individually.

- Pressing the [ ] buttons will display only images in the group.
- To cancel group playback, press the [ ] button, choose [ ] in the menu, and press the [ ] button again (28).

Before Use
Basic Guide
Advanced Guide
1 Camera Basics
2 Auto Mode / Hybrid Auto Mode
3 Other Shooting Modes
4 P Mode
5 Tv, Av, and M Mode
6 Playback Mode
7 Wi-Fi Functions
8 Setting Menu
9 Accessories
10 Appendix
Index

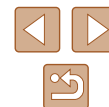



- During group playback (step 3), you can use the menu functions accessed by pressing the [MENU] button. You can also browse through images quickly “Navigating through Images in an Index” (p. 80) and magnify them “Magnifying Images” (p. 83). By choosing [Protect All Images in Search] in “Protecting Images” (p. 85) or [All Images in Group] in “Erasing Multiple Images at Once” (p. 88), “Adding Images to the Print List (DPOF)” (p. 143), or “Adding Images to a Photobook” (p. 145), all images in the group can be manipulated at once.
- To ungroup images so that they are displayed only as single still images, choose MENU > [▶] tab > [Group Images] > [Off] (p. 29). However, grouped images cannot be ungrouped during individual playback.
- In [Creative Shot] mode, the simultaneous display after step 2 in “Enjoying a Variety of Images from Each Shot (Creative Shot)” (p. 52) is only shown immediately after you shoot.

## Image Viewing Options

### Magnifying Images

▶ Still Images ▶ Movies

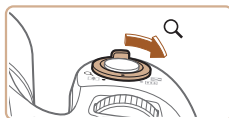

#### 1 Magnify an image.

- Moving the zoom lever toward [Q] will zoom in and magnify the image, and [SET] is displayed. You can magnify images up to about 10x by continuing to hold the zoom lever.
- The approximate position of the displayed area (1) is shown for reference.
- To zoom out, move the zoom lever toward [Q]. You can return to single-image display by continuing to hold it.

#### 2 Move the display position and switch images as needed.

- To move the display position, press the [▲][▼][◀][▶] buttons.
- While [SET] is displayed, you can switch to [SET] by pressing the [MENU] button. To switch to other images while zoomed, press the [◀][▶] buttons. Press the [MENU] button again to restore the original setting.



- You can return to single-image display from magnified display by pressing the [MENU] button.

Before Use

Basic Guide

Advanced Guide

1 Camera Basics

2 Auto Mode / Hybrid Auto Mode

3 Other Shooting Modes

4 P Mode

5 Tv, Av, and M Mode

6 Playback Mode

7 Wi-Fi Functions

8 Setting Menu

9 Accessories

10 Appendix

Index



## Viewing Slideshows

► Still Images ► Movies

Automatically play back images from a memory card as follows. Each image is displayed for about three seconds.



- Press the [MENU] button, choose [Slideshow] in the menu, and choose the desired option (📖28).
- The slideshow will start after [Loading image] is displayed for a few seconds.
- Press the [MENU] button to stop the slideshow.



- The camera's power-saving functions (📖26) are deactivated during slideshows.



- To pause or resume slideshows, press the [STOP] button.
- You can switch to other images during playback by pressing the [◀][▶] buttons. For fast-forward or fast-rewind, hold the [◀][▶] buttons down.
- In filtered display (📖81), only images matching search conditions are played.

## Changing Slideshow Settings

You can set up slideshows to repeat, and you can change the transitions between images and the display duration of each image.

### 1 Access the setting screen.

- Press the [MENU] button, and then choose [Slideshow] on the [▶] tab (📖29).

### 2 Configure the settings.

- Choose a menu item to configure, and then choose the desired option (📖29).
- To start the slideshow with your settings, choose [Start] and press the [STOP] button.
- To return to the menu screen, press the [MENU] button.

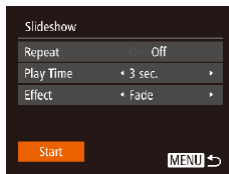

- [Play Time] cannot be modified when [Bubble] is chosen in [Effect].

Before Use

Basic Guide

Advanced Guide

1 Camera Basics

2 Auto Mode / Hybrid Auto Mode

3 Other Shooting Modes

4 P Mode

5 Tv, Av, and M Mode

6 Playback Mode

7 Wi-Fi Functions

8 Setting Menu

9 Accessories

10 Appendix

Index

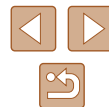

## Auto Playback of Related Images (Smart Shuffle)

► Still Images ► Movies

Based on the current image, the camera offers four images that you may wish to view. After you choose to view one of those images, the camera offers four more images. This is an enjoyable way to play back images in an unexpected order. Try this feature after you have taken many shots, in many kinds of scenes.



### 1 Choose Smart Shuffle.

- Press the [Ⓜ] button, and then choose [Smart Shuffle] in the menu (📖28).
- Four candidate images are displayed.



### 2 Choose an image.

- Press the [▲][▼][◀][▶] buttons to choose the image you want to view next.
- Your chosen image is displayed in the center, surrounded by the next four candidate images.
- For full-screen display of the center image, press the [Ⓜ] button. To restore the original display, press the [Ⓜ] button again.
- Press the [MENU] button to restore single-image display.



- Smart Shuffle is not available in the following cases:
  - There are less than 50 shots taken with this camera
  - An unsupported image is currently displayed
  - Images are shown in filtered display (📖81)
  - During group playback (📖82)

## Protecting Images

► Still Images ► Movies

Protect important images to prevent accidental erasure by the camera (📖88).

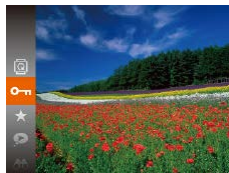

- Press the [Ⓜ] button, and then choose [Protect] in the menu (📖28). [Protected] is displayed.
- To cancel protection, repeat this process and choose [Protect] again, and then press the [Ⓜ] button.



- Protected images on a memory card will be erased if you format the card (📖127, 📖128).



- Protected images cannot be erased using the camera's erasure function. To erase them this way, first cancel protection.

Before Use

Basic Guide

Advanced Guide

1 Camera Basics

2 Auto Mode / Hybrid Auto Mode

3 Other Shooting Modes

4 P Mode

5 Tv, Av, and M Mode

6 Playback Mode

7 Wi-Fi Functions

8 Setting Menu

9 Accessories

10 Appendix

Index



## Using the Menu

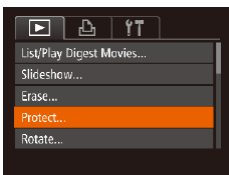

### 1 Access the setting screen.

- Press the [MENU] button and choose [Protect] on the [ ] tab (86).

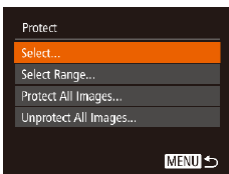

### 2 Choose a selection method.

- Choose a menu item and an option as desired (86).
- To return to the menu screen, press the [MENU] button.

## Choosing Images Individually



### 1 Choose [Select].

- Following step 2 in “Using the Menu” (86), choose [Select] and press the [ ] button.

### 2 Choose an image.

- Press the [ ] buttons to choose an image, and then press the [ ] button. [ ] is displayed.
- To cancel selection, press the [ ] button again. [ ] is no longer displayed.
- Repeat this process to specify other images.

### 3 Protect the image.

- Press the [MENU] button. A confirmation message is displayed.
- Press the [ ] buttons to choose [OK], and then press the [ ] button.

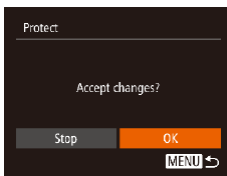

- Images will not be protected if you switch to Shooting mode or turn the camera off before finishing the setup process in step 3.

Before Use

Basic Guide

Advanced Guide

1 Camera Basics

2 Auto Mode / Hybrid Auto Mode

3 Other Shooting Modes

4 P Mode

5 Tv, Av, and M Mode

6 Playback Mode

7 Wi-Fi Functions

8 Setting Menu

9 Accessories

10 Appendix

Index



## Selecting a Range

### 1 Choose [Select Range].

- Following step 2 in “Using the Menu” (86), choose [Select Range] and press the [OK] button.

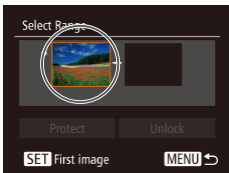

### 2 Choose a starting image.

- Press the [OK] button.

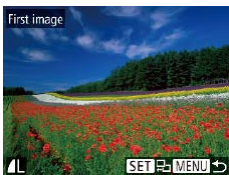

- Press the [Left][Right] buttons to choose an image, and then press the [OK] button.

### 3 Choose an ending image.

- Press the [Right] button to choose [Last image], and then press the [OK] button.

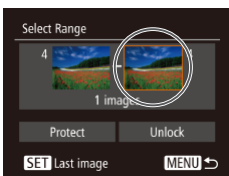

- Press the [Left][Right] buttons to choose an image, and then press the [OK] button.
- Images before the first image cannot be selected as the last image.

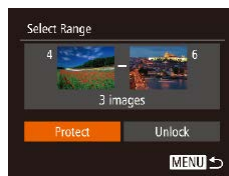

### 4 Protect the images.

- Press the [Down] button to choose [Protect], and then press the [OK] button.



- To cancel protection for groups of images, choose [Unlock] in step 4.

## Protecting All Images at Once

### 1 Choose [Protect All Images].

- Following step 2 in “Using the Menu” (86), choose [Protect All Images] and press the [OK] button.

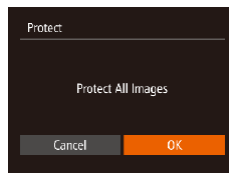

### 2 Protect the images.

- Press the [Left][Right] buttons to choose [OK], and then press the [OK] button.

### Clearing All Protection at Once

You can clear protection from all images at once. To clear protection, choose [Unprotect All Images] in step 1 of “Protecting All Images at Once”, and then complete step 2.

Before Use

Basic Guide

Advanced Guide

1 Camera Basics

2 Auto Mode / Hybrid Auto Mode

3 Other Shooting Modes

4 P Mode

5 Tv, Av, and M Mode

6 Playback Mode

7 Wi-Fi Functions

8 Setting Menu

9 Accessories

10 Appendix

Index



## Erasing Images

► Still Images ► Movies

You can choose and erase unneeded images one by one. Be careful when erasing images, because they cannot be recovered. However, protected images (📖85) cannot be erased.

### 1 Choose an image to erase.

- Press the [◀][▶] buttons to choose an image.



### 2 Erase the image.

- Press the [📄] button.
- After [Erase?] is displayed, press the [◀][▶] buttons to choose [Erase], and then press the [📄] button.
- The current image is now erased.
- To cancel erasure, press the [◀][▶] buttons to choose [Cancel], and then press the [📄] button.

## Erasing Multiple Images at Once

You can choose multiple images to erase at once. Be careful when erasing images, because they cannot be recovered. However, protected images (📖85) cannot be erased.

### Choosing a Selection Method

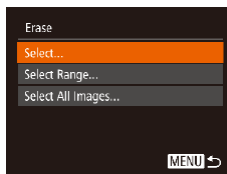
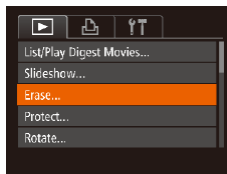

### 1 Access the setting screen.

- Press the [MENU] button, and then choose [Erase] on the [📄] tab (📖29).

### 2 Choose a selection method.

- Choose a menu item and an option as desired (📖29).
- To return to the menu screen, press the [MENU] button.

Before Use

Basic Guide

Advanced Guide

1 Camera Basics

2 Auto Mode / Hybrid Auto Mode

3 Other Shooting Modes

4 P Mode

5 Tv, Av, and M Mode

6 Playback Mode

7 Wi-Fi Functions

8 Setting Menu

9 Accessories

10 Appendix

Index

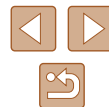



## Choosing Images Individually

### 1 Choose [Select].

- Following step 2 in “Choosing a Selection Method” (88), choose [Select] and press the [OK] button.



### 2 Choose an image.

- Once you choose an image following step 2 in “Choosing Images Individually” (86), [✓] is displayed.
- To cancel selection, press the [OK] button again. [✓] is no longer displayed.
- Repeat this process to specify other images.

### 3 Erase the image.

- Press the [MENU] button. A confirmation message is displayed.
- Press the [Left][Right] buttons to choose [OK], and then press the [OK] button.

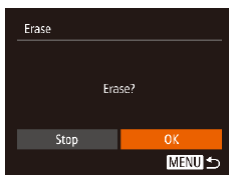

## Selecting a Range

### 1 Choose [Select Range].

- Following step 2 in “Choosing a Selection Method” (88), choose [Select Range] and press the [OK] button.

### 2 Choose images.

- Follow steps 2 – 3 in “Selecting a Range” (87) to specify images.

### 3 Erase the images.

- Press the [Down] button to choose [Erase], and then press the [OK] button.

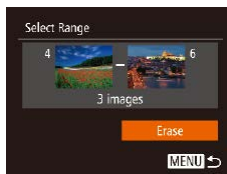

## Specifying All Images at Once

### 1 Choose [Select All Images].

- Following step 2 in “Choosing a Selection Method” (88), choose [Select All Images] and press the [OK] button.

### 2 Erase the images.

- Press the [Left][Right] buttons to choose [OK], and then press the [OK] button.

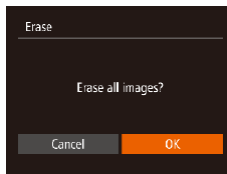

Before Use

Basic Guide

Advanced Guide

1 Camera Basics

2 Auto Mode / Hybrid Auto Mode

3 Other Shooting Modes

4 P Mode

5 Tv, Av, and M Mode

6 Playback Mode

7 Wi-Fi Functions

8 Setting Menu

9 Accessories

10 Appendix

Index

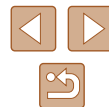

# Rotating Images

► Still Images ► Movies

Change the orientation of images and save them as follows.

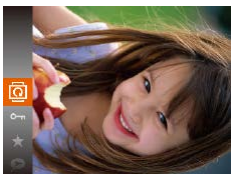

## 1 Choose [Rotate].

- Press the [MENU] button, and then choose [Rotate] in the menu (📖28).



## 2 Rotate the image.

- Press the [◀] or [▶] button, depending on the desired direction. Each time you press the button, the image is rotated 90°. Press the [MENU] button to complete the setting.

## Using the Menu

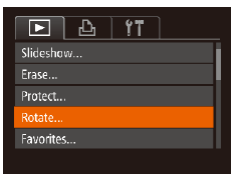

## 1 Choose [Rotate].

- Press the [MENU] button and choose [Rotate] on the [▶] tab (📖29).

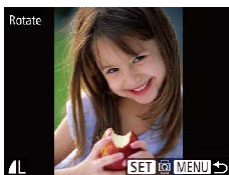

## 2 Rotate the image.

- Press the [◀] or [▶] buttons to choose an image.
- The image is rotated 90° each time you press the [MENU] button.
- To return to the menu screen, press the [MENU] button.



- Rotation is not possible when [Auto Rotate] is set to [Off] (📖90).

## Deactivating Auto Rotation

Follow these steps to deactivate automatic image rotation, which rotates images based on the current camera orientation.

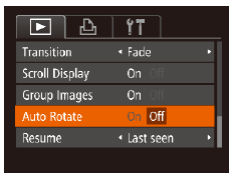

- Press the [MENU] button, choose [Auto Rotate] on the [▶] tab, and then choose [Off] (📖29).



- Images cannot be rotated (📖90) when you set [Auto Rotate] to [Off]. Additionally, images already rotated will be displayed in the original orientation.
- In Smart Shuffle (📖85) mode, even if [Auto Rotate] is set to [Off], images shot vertically will be displayed vertically, and rotated images will be displayed in the rotated orientation.

Before Use
Basic Guide
Advanced Guide
1 Camera Basics
2 Auto Mode / Hybrid Auto Mode
3 Other Shooting Modes
4 P Mode
5 Tv, Av, and M Mode
6 Playback Mode
7 Wi-Fi Functions
8 Setting Menu
9 Accessories
10 Appendix

Index



## Tagging Images as Favorites

► Still Images ► Movies

You can organize images by tagging them as favorites. By choosing a category in filtered playback, you can restrict the following operations to all of those images.

- “Viewing” (📖77), “Viewing Slideshows” (📖84), “Protecting Images” (📖85), “Erasing Images” (📖88), “Adding Images to the Print List (DPOF)” (📖143), “Adding Images to a Photobook” (📖145)

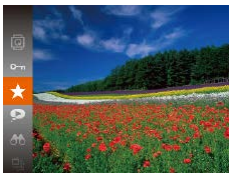

- Press the [Ⓜ] button, and then choose [★] in the menu (📖28).
- [Tagged as Favorite] is displayed.
- To untag the image, repeat this process and choose [★] again, and then press the [Ⓜ] button.

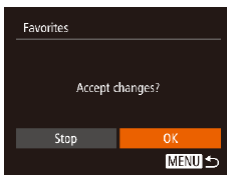

### 2 Choose an image.

- Press the [◀][▶] buttons to choose an image, and then press the [Ⓜ] button. [★] is displayed.
- To untag the image, press the [Ⓜ] button again. [★] is no longer displayed.
- Repeat this process to choose additional images.

### 3 Finish the setup process.

- Press the [MENU] button. A confirmation message is displayed.
- Press the [◀][▶] buttons to choose [OK], and then press the [Ⓜ] button.



- Images will not be tagged as favorites if you switch to Shooting mode or turn the camera off before finishing the setup process in step 3.



- Favorite images will have a three-star rating (★★★☆☆) when transferred to computers running Windows 8 or Windows 7. (Does not apply to movies.)

## Using the Menu

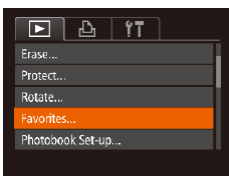

### 1 Choose [Favorites].

- Press the [MENU] button and choose [Favorites] on the [▶] tab (📖29).

Before Use

Basic Guide

Advanced Guide

1 Camera Basics

2 Auto Mode / Hybrid Auto Mode

3 Other Shooting Modes

4 P Mode

5 Tv, Av, and M Mode

6 Playback Mode

7 Wi-Fi Functions

8 Setting Menu

9 Accessories

10 Appendix

Index

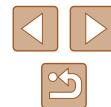

## Editing Still Images



- Image editing (📖92 – 📖94) is only available when the memory card has sufficient free space.

## Resizing Images

▶ Still Images ▶ Movies

Save a copy of images at a lower resolution.

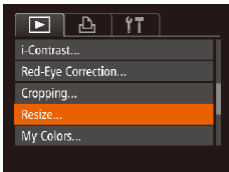

### 1 Choose [Resize].

- Press the [MENU] button and choose [Resize] on the [▶] tab (📖29).

### 2 Choose an image.

- Press the [◀][▶] buttons to choose an image, and then press the [⊕] button.

### 3 Choose an image size.

- Press the [◀][▶] buttons to choose the size, and then press the [⊕] button.
- [Save new image?] is displayed.



### 4 Save the new image.

- Press the [◀][▶] buttons to choose [OK], and then press the [⊕] button.
- The image is now saved as a new file.

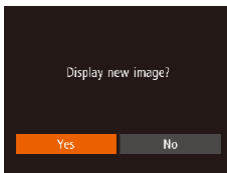

### 5 Review the new image.

- Press the [MENU] button. [Display new image?] is displayed.
- Press the [◀][▶] buttons to choose [Yes], and then press the [⊕] button.
- The saved image is now displayed.



- Editing is not possible for images shot at a resolution of [S] (📖45).



- Images cannot be resized to a higher resolution.

## Cropping

▶ Still Images ▶ Movies

You can specify a portion of an image to save as a separate image file.

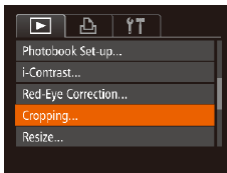

### 1 Choose [Cropping].

- Press the [MENU] button, and then choose [Cropping] on the [▶] tab (📖29).

Before Use

Basic Guide

Advanced Guide

1 Camera Basics

2 Auto Mode / Hybrid Auto Mode

3 Other Shooting Modes

4 P Mode

5 Tv, Av, and M Mode

6 Playback Mode

7 Wi-Fi Functions

8 Setting Menu

9 Accessories

10 Appendix

Index



## 2 Choose an image.

- Press the [◀][▶] buttons to choose an image, and then press the [Ⓜ] button.

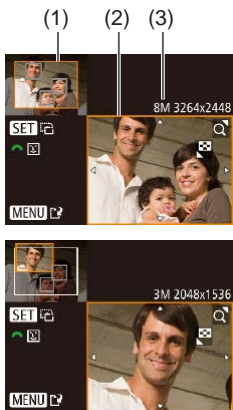

## 3 Adjust the cropping area.

- A frame is displayed around the portion of the image to be cropped (1).
- The original image is shown in the upper left, and a preview of the image as cropped (2) is shown in the lower right. You can also see the resolution after cropping (3).
- To resize the frame, move the zoom lever.
- To move the frame, press the [▲][▼][◀][▶] buttons.
- To change the frame orientation, press the [Ⓜ] button.
- Faces detected in the image are enclosed in gray frames in the upper-left image. To crop the image based on this frame, turn the [☀] dial to switch to the other frame.
- Press the [MENU] button.

## 4 Save as a new image and review.

- Follow steps 4 – 5 in “Resizing Images” (📖92).



- Editing is not possible for images shot at a resolution of [S] (📖45) or resized to [S] (📖92).



- Images supported for cropping will have the same aspect ratio after cropping.
- Cropped images will have a lower resolution than uncropped images.

## Changing Image Color Tones (My Colors)

▶ Still Images ▶ Movies

You can adjust image colors and then save the edited image as a separate file. For details on each option, see “Changing Image Color Tones (My Colors)” (📖64).

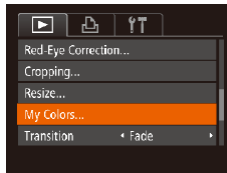

## 1 Choose [My Colors].

- Press the [MENU] button, and then choose [My Colors] on the [▶] tab (📖29).

## 2 Choose an image.

- Press the [◀][▶] buttons to choose an image, and then press the [Ⓜ] button.

## 3 Choose an option.

- Press the [◀][▶] buttons to choose an option, and then press the [Ⓜ] button.



## 4 Save as a new image and review.

- Follow steps 4 – 5 in “Resizing Images” (📖92).

Before Use

Basic Guide

Advanced Guide

1 Camera Basics

2 Auto Mode / Hybrid Auto Mode

3 Other Shooting Modes

4 P Mode

5 Tv, Av, and M Mode

6 Playback Mode

7 Wi-Fi Functions

8 Setting Menu

9 Accessories

10 Appendix

Index





- Image quality of pictures you repeatedly edit this way will be a little lower each time, and you may not be able to obtain the desired color.



- The color of images edited using this function may vary slightly from the color of images shot using My Colors (p.64).

## Correcting Image Brightness (i-Contrast)

► Still Images ► Movies

Excessively dark image areas (such as faces or backgrounds) can be detected and automatically adjusted to the optimal brightness. Insufficient overall image contrast is also automatically corrected, to make subjects stand out better. Choose from four correction levels, and then save the image as a separate file.

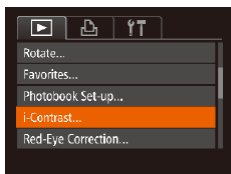

### 1 Choose [i-Contrast].

- Press the [MENU] button, and then choose [i-Contrast] on the [▶] tab (p.29).

### 2 Choose an image.

- Press the [◀][▶] buttons to choose an image, and then press the [Ⓜ] button.

### 3 Choose an option.

- Press the [◀][▶] buttons to choose an option, and then press the [Ⓜ] button.



## 4 Save as a new image and review.

- Follow steps 4 – 5 in “Resizing Images” (p.92).



- For some images, correction may be inaccurate or may cause images to appear grainy.
- Images may look grainy after repeated editing using this function.



- If [Auto] does not produce the expected results, try correcting images using [Low], [Medium], or [High].

## Correcting Red-Eye

► Still Images ► Movies

Automatically corrects images affected by red-eye. You can save the corrected image as a separate file.

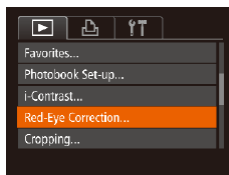

### 1 Choose [Red-Eye Correction].

- Press the [MENU] button, and then choose [Red-Eye Correction] on the [▶] tab (p.29).

### 2 Choose an image.

- Press the [◀][▶] buttons to choose an image.

Before Use
Basic Guide
Advanced Guide
<b>1</b> Camera Basics
<b>2</b> Auto Mode / Hybrid Auto Mode
<b>3</b> Other Shooting Modes
<b>4</b> P Mode
<b>5</b> Tv, Av, and M Mode
<b>6</b> Playback Mode
<b>7</b> Wi-Fi Functions
<b>8</b> Setting Menu
<b>9</b> Accessories
<b>10</b> Appendix
Index



### 3 Correct the image.

- Press the button.
- Red-eye detected by the camera is now corrected, and frames are displayed around corrected image areas.
- Enlarge or reduce images as needed. Follow the steps in "Magnifying Images" ( 83).

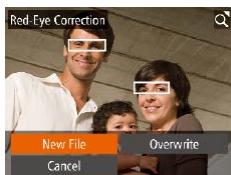

### 4 Save as a new image and review.

- Press the buttons to choose [New File], and then press the button.
- The image is now saved as a new file.
- Follow step 5 in "Resizing Images" ( 92).



- Some images may not be corrected accurately.
- To overwrite the original image with the corrected image, choose [Overwrite] in step 4. In this case, the original image will be erased.
- Protected images cannot be overwritten.

## Editing Movies

► Still Images ► Movies

You can cut movies to remove unneeded portions at the beginning or end.

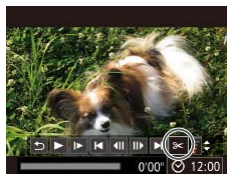

### 1 Choose .

- Following steps 1 – 5 in "Viewing" ( 77), choose and press the button.
- The movie editing panel and editing bar are now displayed.



### 2 Specify portions to cut.

- (1) is the movie editing panel, and (2) is the editing bar.
- Press the buttons to choose or .
- To view the portions you can cut (identified by on the screen), press the buttons to move . Cut the beginning of the movie (from ) by choosing , and cut the end of the movie by choosing .
- If you move to a position other than a mark, in the portion before the nearest mark on the left will be cut, while in the portion after the nearest mark on the right will be cut.

Before Use

Basic Guide

Advanced Guide

1 Camera Basics

2 Auto Mode / Hybrid Auto Mode

3 Other Shooting Modes

4 P Mode

5 Tv, Av, and M Mode

6 Playback Mode

7 Wi-Fi Functions

8 Setting Menu

9 Accessories

10 Appendix

Index

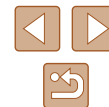

### 3 Review the edited movie.

- Press the [▲][▼] buttons to choose [▶], and then press the [⏻] button. The edited movie is now played.
- To edit the movie again, repeat step 2.
- To cancel editing, press the [▲][▼] buttons to choose [↵]. Press the [⏻] button, press the [◀][▶] buttons to choose [OK], and then press the [⏻] button again.

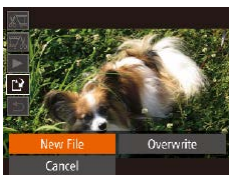

### 4 Save the edited movie.

- Press the [▲][▼] buttons to choose [↵], and then press the [⏻] button.
- Press the [▲][▼][◀][▶] buttons to choose [New File], and then press the [⏻] button.
- The movie is now saved as a new file.



- To overwrite the original movie with the cut one, choose [Overwrite] in step 4. In this case, the original movie will be erased.
- If the memory card lacks sufficient space, only [Overwrite] will be available.
- Movies may not be saved if the battery pack runs out while saving is in progress.
- When editing movies, you should use a fully charged battery pack or an AC adapter kit (sold separately, 132).

## Editing Digest Movies

▶ Still Images ▶ Movies

Individual chapters (clips) (134) recorded in [M] mode can be erased, as needed. Be careful when erasing clips, because they cannot be recovered.



### 1 Select the clip to erase.

- Follow steps 1 – 2 in “Viewing Short Movies Created When Shooting Still Images (Digest Movies)” (79) to play a movie created in [M] mode, and then press the [⏻] button to access the movie control panel.
- Press the [◀][▶] buttons to choose [◀] or [▶], and then press the [⏻] button.

### 2 Choose [⏻].

- Press the [◀][▶] buttons to choose [⏻], and then press the [⏻] button.
- The selected clip is played back repeatedly.

### 3 Confirm erasure.

- Press the [◀][▶] buttons to choose [OK], and then press the [⏻] button.
- The clip is erased, and the short movie is overwritten.

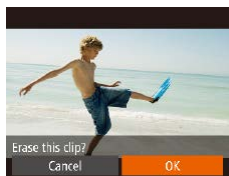

- [⏻] is not displayed if you select a clip when the camera is connected to a printer.

Before Use
Basic Guide
Advanced Guide
1 Camera Basics
2 Auto Mode / Hybrid Auto Mode
3 Other Shooting Modes
4 P Mode
5 Tv, Av, and M Mode
6 Playback Mode
7 Wi-Fi Functions
8 Setting Menu
9 Accessories
10 Appendix
Index





# 7

## Wi-Fi Functions

Send images wirelessly from the camera to a variety of compatible devices, and use the camera with Web services

### Available Wi-Fi Features

You can send and receive images and control the camera remotely by connecting it to these devices and services via Wi-Fi.

- **Smartphones and Tablets**  
Send images to smartphones and tablet computers that have Wi-Fi functions. You can also shoot remotely and geotag your shots from a smartphone or tablet.  
For convenience in this manual, smartphones, tablets, and other compatible devices are collectively referred to as “smartphones”.
- **Computer**  
Use software to save camera images to a computer connected via Wi-Fi.
- **Web Services**  
Add your account information to the camera for CANON iMAGE GATEWAY online photography service or other Web services to send camera images to the services. Unsent images on the camera can also be sent automatically to a computer or Web service via CANON iMAGE GATEWAY.
- **Printers**  
Send images wirelessly to a PictBridge-compatible printer (supporting DPS over IP) to print them.
- **Another Camera**  
Send images wirelessly between Wi-Fi compatible Canon cameras.

Before Use

Basic Guide

Advanced Guide

**1** Camera Basics

**2** Auto Mode /  
Hybrid Auto Mode

**3** Other Shooting Modes

**4** P Mode

**5** Tv, Av, and M Mode

**6** Playback Mode

**7** Wi-Fi Functions

**8** Setting Menu

**9** Accessories

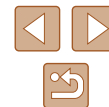

**10** Appendix

Index



## Sending Images to a Smartphone

There are several ways to connect the camera to a smartphone and send images.

- Connect via NFC (📖98)  
Simply touch an NFC-compatible Android smartphone (OS version 4.0 or later) against the camera to connect the devices.
- Connect to a device assigned to the  button (📖101)  
Simply press the  button to connect the devices. This simplifies importing images from a smartphone (📖101). Note that only one smartphone can be assigned to the  button.
- Connect via the Wi-Fi menu (📖102)  
You can connect the camera to a smartphone as you would connect it to a computer or other device. Multiple smartphones can be added.

Before connecting to the camera, you must install the free dedicated CameraWindow app on the smartphone. For details on this application (supported smartphones and included functions), refer to the Canon website.

## Sending Images to an NFC-Compatible Smartphone

Using an NFC-compatible Android smartphone (OS version 4.0 or later) simplifies the process of installing CameraWindow and connecting the devices via NFC.

Operation once the devices are connected via NFC varies depending on the camera mode when the devices are touched together.

- If the camera is off or in Shooting mode when the devices are touched together, you can choose and send images on the image selection screen. Once the devices are connected, you can also shoot remotely and geotag your shots (📖120). It's easy to reconnect to recent devices, which are listed in the Wi-Fi menu.
- If the camera is in Playback mode when the devices are touched together, you can choose and send images from the index display shown for image selection. The connection is ended automatically after image transfer.

Follow the instructions in the first section below when touching a camera that is off or in Shooting mode to another device.

### Connecting via NFC When Off or in Shooting Mode

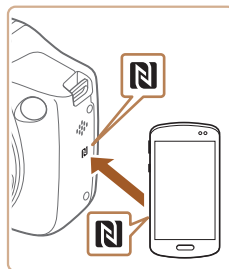

#### 1 Install CameraWindow.

- Activate NFC on the smartphone and touch the devices' N-Marks (📌) together to start Google Play on the smartphone automatically. Once the CameraWindow download page is displayed, download and install the app.

Before Use

Basic Guide

Advanced Guide

1 Camera Basics

2 Auto Mode / Hybrid Auto Mode

3 Other Shooting Modes

4 P Mode

5 Tv, Av, and M Mode

6 Playback Mode

7 Wi-Fi Functions

8 Setting Menu

9 Accessories

10 Appendix

Index



## 2 Establish the connection.

- Make sure the camera is off or in Shooting mode.
- Touch the N-Mark (N) on the smartphone with CameraWindow installed against the camera's N-Mark.
- The camera starts up automatically.
- When the [Device Nickname] screen is displayed, press the [MENU] button. Use the keyboard displayed to enter a nickname (30). On the [Device Nickname] screen, press the [▲][▼] buttons to choose [OK], and then press the [MENU] button.
- Start CameraWindow on the smartphone.
- The devices are connected automatically.

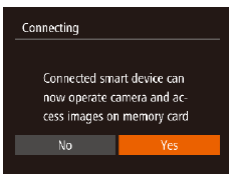
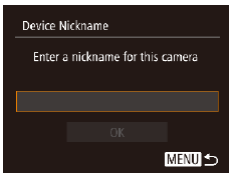

## 3 Adjust the privacy setting.

- After this screen is displayed, press the [◀][▶] buttons to choose [Yes], and then press the [MENU] button.
- You can now use the smartphone to browse, import, or geotag images on the camera or shoot remotely.



## 4 Send images.

- Press the [▲][▼][◀][▶] buttons to choose [Select and send], and then press the [MENU] button.
- Press the [▲][▼][◀][▶] buttons to choose an image to send, press the [✓] button to mark it as selected, and then press the [MENU] button.
- Press the [▲][▼][◀][▶] buttons to choose [Send], and then press the [MENU] button.
- Image transfer will begin. The screen darkens during image transfer.
- [Transfer completed] is displayed after the image is sent, and the image transfer screen is displayed again.
- To cancel the connection, press the [MENU] button, press the [◀][▶] buttons on the confirmation screen to choose [OK], and then press the [MENU] button. You can also use the smartphone to end the connection.

Before Use
Basic Guide
Advanced Guide
<b>1</b> Camera Basics
<b>2</b> Auto Mode / Hybrid Auto Mode
<b>3</b> Other Shooting Modes
<b>4</b> P Mode
<b>5</b> Tv, Av, and M Mode
<b>6</b> Playback Mode
<b>7</b> Wi-Fi Functions
<b>8</b> Setting Menu
<b>9</b> Accessories
<b>10</b> Appendix
Index

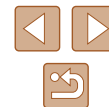



- When using NFC, keep the following points in mind.
  - Avoid strong impact between the camera and smartphone. This may damage the devices.
  - Depending on the smartphone, the devices may not recognize each other immediately. In this case, try holding the devices together in slightly different positions. If connection fails, keep the devices together until the camera screen is updated.
  - Do not place other objects between the camera and smartphone. Also, note that camera or smartphone covers or similar accessories may block communication.
- All images in the camera can be viewed from the connected smartphone when you choose [Yes] in step 3. To keep camera images private, so that they cannot be viewed from the smartphone, choose [No] in step 3.
- Once you have registered a smartphone, you can change privacy settings for it on the camera (122).



- Connections require that a memory card be in the camera.
- A message is displayed if the nickname you enter begins with a symbol or space. Press the [OK] button and enter a different nickname.
- Not all NFC-compatible smartphones have an N-Mark (N). For details, refer to the smartphone user manual.
- You can also send multiple images at once and change the image size before sending (117).
- You can send the current image by choosing [Send this image] on the screen in step 4.
- To disable NFC connections, choose MENU (29) > [↑] tab > [Wi-Fi Settings] > [NFC] > [Off].

## Connecting via NFC in Playback Mode



- Press the [▶] button to turn the camera on.
- Touch the smartphone with CameraWindow installed (98) against the camera's N-Mark (N).
- Press the [▲][▼][◀][▶] buttons to choose an image to send, and then press the [OK] button. [✓] is displayed.
- To cancel selection, press the [OK] button again. [✓] is no longer displayed.
- Repeat this process to choose additional images.
- After you finish choosing images, press the [MENU] button.
- Press the [◀][▶] buttons to choose [Send], and then press the [OK] button.
- The images are now sent. The connection is ended automatically after image transfer.





- If during connection a message on the camera or smartphone requests you to enter the nickname, follow step 2 in "Sending Images to an NFC-Compatible Smartphone" (98) to enter it.
- The camera does not keep a record of smartphones you connect to via NFC in Playback mode.
- You can preset images to transfer at your desired size (117).

Before Use
Basic Guide
Advanced Guide
<b>1</b> Camera Basics
<b>2</b> Auto Mode / Hybrid Auto Mode
<b>3</b> Other Shooting Modes
<b>4</b> P Mode
<b>5</b> Tv, Av, and M Mode
<b>6</b> Playback Mode
<b>7</b> Wi-Fi Functions
<b>8</b> Setting Menu
<b>9</b> Accessories
<b>10</b> Appendix
Index



## Sending to a Smartphone Assigned to the Button







Once you have connected to a smartphone initially by pressing the  button, you can simply press the  button after that to connect again for viewing and saving camera images on connected devices. These steps show how to use the camera as an access point, but you can also use an existing access point (104).



### 1 Install CameraWindow.



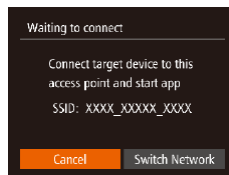
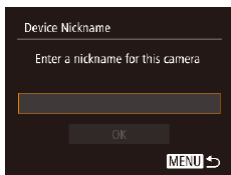

- For an iPhone, iPad, or iPod touch, find CameraWindow in the App Store and download and install the app.
- For Android smartphones, find CameraWindow in Google Play and download and install the app.

### 2 Press the button.

- Press the  button.
- When the [Device Nickname] screen is displayed, press the  button. Use the keyboard displayed to enter a nickname (30). On the [Device Nickname] screen, press the [][] buttons to choose [OK], and then press the  button.



### 3 Choose .

- Press the [][] buttons to choose , and then press the  button.
- The camera's SSID is displayed.

### 4 Connect the smartphone to the network.

- In the smartphone's Wi-Fi setting menu, choose the SSID (network name) displayed on the camera to establish a connection.

### 5 Start CameraWindow.

- Start CameraWindow on the smartphone.
- After the camera recognizes the smartphone, a device selection screen is displayed.

Before Use
Basic Guide
Advanced Guide
1 Camera Basics
2 Auto Mode / Hybrid Auto Mode
3 Other Shooting Modes
4 P Mode
5 Tv, Av, and M Mode
6 Playback Mode
7 Wi-Fi Functions
8 Setting Menu
9 Accessories
10 Appendix
Index



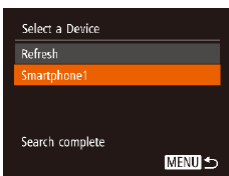

## 6 Choose a smartphone to connect to.

- Press the [▲][▼] buttons to choose the smartphone, and then press the [OK] button.
- After a connection is established with the smartphone, the smartphone name is displayed on the camera. (This screen will close in about one minute.)



## 7 Import images.

- Use the smartphone to import images from the camera to the smartphone.
- Use the smartphone to end the connection; the camera will automatically turn off.



- Connections require that a memory card be in the camera.
- A message is displayed if the nickname you enter begins with a symbol or space. Press the [OK] button and enter a different nickname.
- For better security, you can require password input on the screen in step 3 by accessing MENU (102) and choosing [F1] tab > [Wi-Fi Settings] > [Password] > [On]. In this case, in the password field on the smartphone in step 4, enter the password displayed on the camera.
- One smartphone can be registered to the [M] button. To assign a different one, first clear the current one in MENU (102) > [F1] tab > [Mobile Device Connect Button].
- Not all NFC-compatible smartphones have an N-Mark (N). For details, refer to the smartphone user manual.

## Adding a Smartphone Using the Wi-Fi Menu

These steps show how to use the camera as an access point, but you can also use an existing access point (104).

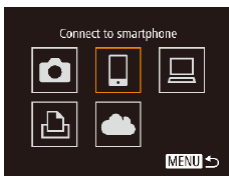
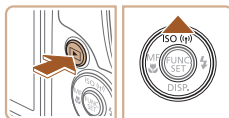

### 1 Install CameraWindow.

- For an iPhone, iPad, or iPod touch, find CameraWindow in the App Store and download and install the app.
- For Android smartphones, find CameraWindow in Google Play and download and install the app.

### 2 Access the Wi-Fi menu.

- Press the [▶] button to turn the camera on.
- Press the [▲] button.
- If a screen requesting the device nickname is displayed, enter the nickname (101).

### 3 Choose [M].

- Press the [◀][▶] buttons to choose [M], and then press the [OK] button.

Before Use

Basic Guide

Advanced Guide

1 Camera Basics

2 Auto Mode / Hybrid Auto Mode

3 Other Shooting Modes

4 P Mode

5 Tv, Av, and M Mode

6 Playback Mode

7 Wi-Fi Functions

8 Setting Menu

9 Accessories

10 Appendix

Index



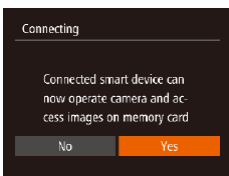
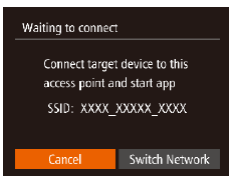
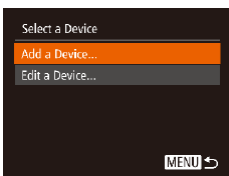

#### 4 Choose [Add a Device].

- Press the [▲][▼] buttons to choose [Add a Device], and then press the [MENU] button.

- The camera's SSID is displayed.
- Choose a smartphone to connect to, as described in steps 4 – 6 of “Sending to a Smartphone Assigned to the Button” (📖101).

#### 5 Adjust the privacy setting.

- Press the [◀][▶] buttons to choose [Yes], and then press the [MENU] button.
- You can now use the smartphone to browse, import, or geotag images on the camera or shoot remotely.

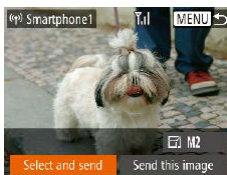

#### 6 Send images.

- Press the [▲][▼][◀][▶] buttons to choose [Select and send], and then press the [MENU] button.
- Press the [▲][▼][◀][▶] buttons to choose an image to send, press the [MENU] button to mark it as selected ([✓]), and then press the [MENU] button.
- Press the [▲][▼][◀][▶] buttons to choose [Send], and then press the [MENU] button.
- Image transfer will begin. The screen darkens during image transfer.
- [Transfer completed] is displayed after the image is sent, and the image transfer screen is displayed again.
- To cancel the connection, press the [MENU] button, press the [◀][▶] buttons on the confirmation screen to choose [OK], and then press the [MENU] button. You can also use the smartphone to end the connection.
- To add multiple smartphones, repeat the above procedures starting from step 1.



- All images in the camera can be viewed from the connected smartphone when you choose [Yes] in step 5. To keep camera images private, so that they cannot be viewed from the smartphone, choose [No] in step 5.
- Once you have registered a smartphone, you can change privacy settings for it on the camera (📖122).

Before Use
Basic Guide
Advanced Guide
<b>1</b> Camera Basics
<b>2</b> Auto Mode / Hybrid Auto Mode
<b>3</b> Other Shooting Modes
<b>4</b> P Mode
<b>5</b> Tv, Av, and M Mode
<b>6</b> Playback Mode
<b>7</b> Wi-Fi Functions
<b>8</b> Setting Menu
<b>9</b> Accessories
<b>10</b> Appendix
Index





- Connections require that a memory card be in the camera.
- Once you have connected to devices via the Wi-Fi menu, recent destinations will be listed first when you access the Wi-Fi menu. You can easily connect again by pressing the [▲][▼] buttons to choose the device and then pressing the [Ⓜ] button. To add a new device, display the device selection screen by touching [◀][▶], and then configure the setting.
- If you prefer not to display recent target devices, choose MENU (📖29) > [📶] tab > [Wi-Fi Settings] > [Target History] > [Off].
- You can also send multiple images at once and change the image size before sending (📖117).
- You can send the current image by choosing [Send this image] on the screen in step 6.
- To disable NFC connections, choose MENU (📖29) > [📶] tab > [Wi-Fi Settings] > [NFC] > [Off].

## Using Another Access Point

When connecting the camera to a smartphone with the [📶] button or through the Wi-Fi menu, you can also use an existing access point.

### 1 Prepare for the connection.

- Access the [Waiting to connect] screen. Either follow steps 1 – 3 in “Sending to a Smartphone Assigned to the Button” (📖101) or steps 1 – 4 in “Adding a Smartphone Using the Wi-Fi Menu” (📖102).

### 2 Connect the smartphone to the access point.

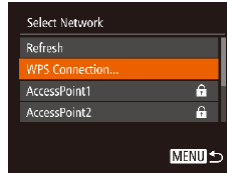
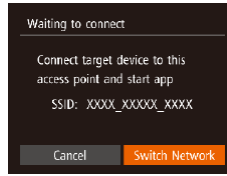

### 3 Choose [Switch Network].

- Press the [◀][▶] buttons to choose [Switch Network], and then press the [Ⓜ] button.
- A list of detected access points will be displayed.

### 4 Connect to the access point and choose the smartphone.

- For WPS-compatible access points, connect to the access point and choose the smartphone as described in steps 5 – 8 in “Using WPS-Compatible Access Points” (📖107).
- For non-WPS access points, follow steps 2 – 4 in “Connecting to Listed Access Points” (📖109) to connect to the access point and choose the smartphone.

### 5 Configure the privacy settings and send images.

- Follow steps 5 – 6 in “Adding a Smartphone Using the Wi-Fi Menu” (📖102) to configure the privacy settings and send images.

Before Use

Basic Guide

Advanced Guide

1 Camera Basics

2 Auto Mode / Hybrid Auto Mode

3 Other Shooting Modes

4 P Mode

5 Tv, Av, and M Mode

6 Playback Mode

7 Wi-Fi Functions

8 Setting Menu

9 Accessories

10 Appendix

Index

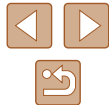



## Previous Access Points

To reconnect to a previous access point automatically, follow step 3 in “Sending to a Smartphone Assigned to the Button” (📖101) or step 4 in “Adding a Smartphone Using the Wi-Fi Menu” (📖102).

- To use the camera as an access point, choose [Switch Network] on the screen displayed when you establish a connection, and then choose [Camera Access Point Mode].
- To reconnect to a previous access point, follow the procedure from step 5 in “Using Another Access Point” (📖104).
- To switch access points, choose [Switch Network] on the screen displayed when you establish a connection, and then follow the procedure in “Using Another Access Point” (📖104) from step 4.

## Saving Images to a Computer

### Preparing to Register a Computer

#### ■ Checking Your Computer Environment

The camera can connect via Wi-Fi to computers running the following operating systems. For detailed system requirements and compatibility information, including support in new operating systems, visit the Canon website.

- Windows 8/8.1
- Windows 7 SP1
- Mac OS X 10.9
- Mac OS X 10.8.2 or later



- Windows 7 Starter and Home Basic editions are not supported.
- Windows 7 N (European version) and KN (South Korean version) require a separate download and installation of Windows Media Feature Pack.

For details, check the following website.

<http://go.microsoft.com/fwlink/?LinkId=159730>

#### ■ Installing the Software

Windows 7 and Mac OS X 10.8 are used here for the sake of illustration.

##### **1** Download the software.

- With a computer connected to the Internet, access <http://www.canon.com/icpd/>.
- Access the site for your country or region.
- Download the software.

Before Use

Basic Guide

Advanced Guide

**1** Camera Basics

**2** Auto Mode / Hybrid Auto Mode

**3** Other Shooting Modes

**4** P Mode

**5** Tv, Av, and M Mode

**6** Playback Mode

**7** Wi-Fi Functions

**8** Setting Menu

**9** Accessories

**10** Appendix

Index





## 2 Install the files.

- Click [Easy Installation] and follow the on-screen instructions to complete the installation process.
- Installation may take some time, depending on computer performance and the Internet connection.
- Click [Finish] or [Restart] on the screen after installation.

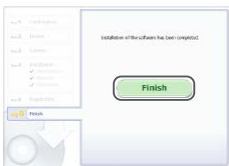

- Because the content and functions of software vary according to the camera model, if you have several cameras, you must use each camera to update to its latest version of the software.

## Configuring the Computer for a Wi-Fi Connection (Windows Only)

On a computer running Windows, configure the following settings before connecting the camera to the computer wirelessly.



### 1 Confirm that the computer is connected to an access point.

- For instructions on checking your network connection, refer to the computer user manual.

## 2 Configure the setting.

- Click in the following order: [Start] menu > [All Programs] > [Canon Utilities] > [CameraWindow] > [Wi-Fi connection setup].
- In the application that opens, follow the on-screen instructions and configure the setting.



- The following Windows settings are configured when you run the utility in step 2.
  - Turn on media streaming.  
This will enable the camera to see (find) the computer to access via Wi-Fi.
  - Turn on network discovery.  
This will enable the computer to see (find) the camera.
  - Turn on ICMP (Internet Control Message Protocol).  
This allows you to check the network connection status.
  - Enable Universal Plug & Play (UPnP).  
This will enable network devices to detect each other automatically.
- Some security software may prevent you from completing the settings as described here. Check the settings of your security software.

Before Use

Basic Guide

Advanced Guide

1 Camera Basics

2 Auto Mode / Hybrid Auto Mode

3 Other Shooting Modes

4 P Mode

5 Tv, Av, and M Mode

6 Playback Mode

7 Wi-Fi Functions

8 Setting Menu

9 Accessories

10 Appendix

Index



## Saving Images to a Connected Computer

Connect to your access point via Wi-Fi as follows. Also refer to the access point user manual.

### Confirming Access Point Compatibility

Confirm that the Wi-Fi router or base station conforms to the Wi-Fi standards in “Wi-Fi” (163).

Connection methods vary depending on whether the access point supports Wi-Fi Protected Setup (WPS, 107) or not (109). For non-WPS access points, check the following information.

- Network name (SSID/ESSID)  
The SSID or ESSID for the access point you use. Also called the “access point name” or “network name”.
- Network authentication / data encryption (encryption method / encryption mode)  
The method for encrypting data during wireless transmission. Check which security setting is used: WPA2-PSK (AES), WPA2-PSK (TKIP), WPA-PSK (AES), WPA-PSK (TKIP), WEP (open system authentication), or no security.
- Password (encryption key / network key)  
The key used when encrypting data during wireless transmission. Also called the “encryption key” or “network key”.
- Key index (transmit key)  
The key set when WEP is used for network authentication / data encryption. Use “1” as the setting.



- If system administrator status is needed to adjust network settings, contact the system administrator for details.
- These settings are very important for network security. Exercise adequate caution when changing these settings.



- For information on WPS compatibility and for instructions on checking settings, refer to the access point user manual.
- A router is a device that creates a network (LAN) structure for connecting multiple computers. A router that contains an internal Wi-Fi function is called a “Wi-Fi router”.
- This guide refers to all Wi-Fi routers and base stations as “access points”.
- If you use MAC address filtering on your Wi-Fi network, be sure to add the camera’s MAC address to your access point. You can check your camera’s MAC address by choosing MENU (29) > [↑] tab > [Wi-Fi Settings] > [Check MAC Address].

### Using WPS-Compatible Access Points

WPS makes it easy to complete settings when connecting devices over Wi-Fi. You can use either Push Button Configuration Method or PIN Method for settings on a WPS supported device.

#### 1 Confirm that the computer is connected to an access point.

- For instructions on checking the connection, refer to the device and access point user manuals.

#### 2 Access the Wi-Fi menu.

- Press the [▶] button to turn the camera on.
- Press the [▲] button.
- When the [Device Nickname] screen is displayed, press the [Ⓜ] button. Use the keyboard displayed to enter a nickname (30). On the [Device Nickname] screen, press the [▲][▼] buttons to choose [OK], and then press the [Ⓜ] button.

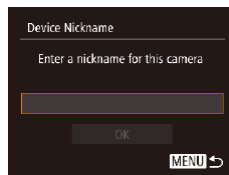
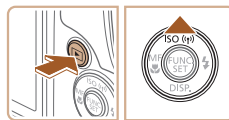

Before Use

Basic Guide

Advanced Guide

1 Camera Basics

2 Auto Mode / Hybrid Auto Mode

3 Other Shooting Modes

4 P Mode

5 Tv, Av, and M Mode

6 Playback Mode

7 Wi-Fi Functions

8 Setting Menu

9 Accessories

10 Appendix

Index



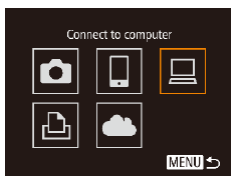

### 3 Choose [Computer].

- Press the [▲][▼][◀][▶] buttons to choose [Computer], and then press the [OK] button.

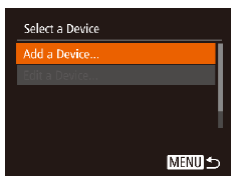

### 4 Choose [Add a Device].

- Press the [▲][▼] buttons to choose [Add a Device], and then press the [OK] button.

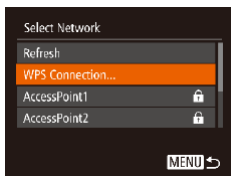

### 5 Choose [WPS Connection].

- Press the [▲][▼] buttons to choose [WPS Connection], and then press the [OK] button.

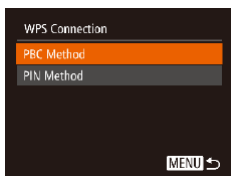

### 6 Choose [PBC Method].

- Press the [▲][▼] buttons to choose [PBC Method], and then press the [OK] button.

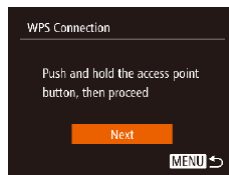

### 7 Establish the connection.

- On the access point, hold down the WPS connection button for a few seconds.
- On the camera, press the [OK] button to go to the next step.
- The camera connects to the access point and lists devices connected to it on the [Select a Device] screen.

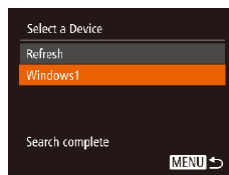

### 8 Choose the target device.

- Press the [▲][▼] buttons to choose the target device name, and then press the [OK] button.

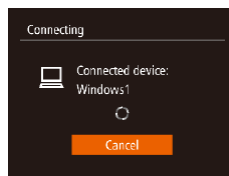

### 9 Install a driver (first Windows connection only).

- When this screen is displayed on the camera, click the Start menu on the computer, click [Control Panel], and then click [Add a device].

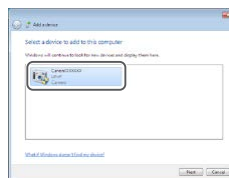
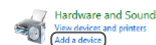

- Double-click the connected camera icon.
- Driver installation will begin.
- After driver installation is complete, and the camera and computer connection is enabled, the AutoPlay screen will be displayed. Nothing will be displayed on the camera screen.

Before Use

Basic Guide

Advanced Guide

1 Camera Basics

2 Auto Mode / Hybrid Auto Mode

3 Other Shooting Modes

4 P Mode

5 Tv, Av, and M Mode

6 Playback Mode

7 Wi-Fi Functions

8 Setting Menu

9 Accessories

10 Appendix

Index



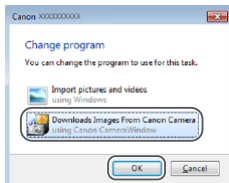

## 10 Display CameraWindow.

- Windows: Access CameraWindow by clicking [Downloads Images From Canon Camera].
- Mac OS: CameraWindow is automatically displayed when a Wi-Fi connection is established between the camera and computer.

## 11 Import images.

- Click [Import Images from Camera], and then click [Import Untransferred Images].
- Images are now saved to the Pictures folder on the computer, in separate folders named by date.
- Click [OK] in the screen that is displayed after image import is complete.



- Once you have connected to devices via the Wi-Fi menu, recent destinations will be listed first when you access the Wi-Fi menu. You can easily connect again by pressing the [▲][▼] buttons to choose the device and then pressing the [MENU] button. To add a new device, display the device selection screen by touching [◀][▶], and then configure the setting.
- If you prefer not to display recent target devices, choose MENU (129) > [↑] tab > [Wi-Fi Settings] > [Target History] > [Off].
- A message is displayed if the nickname you enter begins with a symbol or space. Press the [MENU] button and enter a different nickname.
- When the camera is connected to a computer, the camera screen is blank.
- Mac OS: If CameraWindow is not displayed, click the [CameraWindow] icon in the Dock.
- To disconnect from the camera, turn off the camera.
- If you chose [PIN Method] in step 6, a PIN code will be displayed on the screen. Be sure to set this code in the access point. Choose a device in the [Select a Device] screen. For further details, refer to the user manual included with your access point.

## Connecting to Listed Access Points

### 1 View the listed access points.

- View the listed networks (access points) as described in steps 1 – 4 of “Using WPS-Compatible Access Points” (107).

### 2 Choose an access point.

- Press the [▲][▼] buttons to choose a network (access point), and then press the [MENU] button.

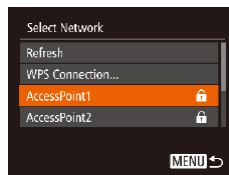

Before Use
Basic Guide
Advanced Guide
<b>1</b> Camera Basics
<b>2</b> Auto Mode / Hybrid Auto Mode
<b>3</b> Other Shooting Modes
<b>4</b> P Mode
<b>5</b> Tv, Av, and M Mode
<b>6</b> Playback Mode
<b>7</b> Wi-Fi Functions
<b>8</b> Setting Menu
<b>9</b> Accessories
<b>10</b> Appendix
Index

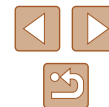

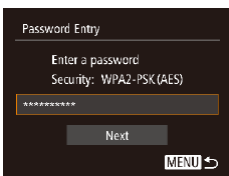

### 3 Enter the access point password.

- Press the [OK] button to access the keyboard, and then enter the password (📖30).
- Press the [▲][▼] buttons to choose [Next], and then press the [OK] button.

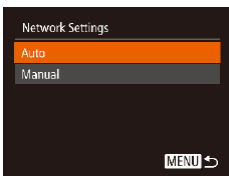

### 4 Choose [Auto].

- Press the [▲][▼] buttons to choose [Auto], and then press the [OK] button.
- To save images to a connected computer, follow the procedure from step 8 in “Using WPS-Compatible Access Points” (📖107).



- To determine the access point password, check on the access point itself or refer to the user manual.
- Up to 16 access points will be displayed. If no access points are detected even after you choose [Refresh] in step 2 to update the list, choose [Manual Settings] in step 2 to complete access point settings manually. Follow on-screen instructions and enter an SSID, security settings, and a password.
- When you use an access point that you have already connected to for connecting to another device, [\*] is displayed for the password in step 3. To use the same password, press the [▲][▼] buttons to choose [Next], and then press the [OK] button.

## Previous Access Points

You can reconnect to any previous access points automatically by following step 4 in “Using WPS-Compatible Access Points” (📖107).

- To reconnect to the access point, confirm that the target device is already connected to it, and then follow the procedure from step 8 in “Using WPS-Compatible Access Points” (📖107).
- To switch access points, choose [Switch Network] on the screen displayed after connection, and then either follow the procedure in “Using WPS-Compatible Access Points” (📖107) from step 5 or the procedure in “Connecting to Listed Access Points” (📖109) from step 2.

Before Use

Basic Guide

Advanced Guide

1 Camera Basics

2 Auto Mode / Hybrid Auto Mode

3 Other Shooting Modes

4 P Mode

5 Tv, Av, and M Mode

6 Playback Mode

7 Wi-Fi Functions

8 Setting Menu

9 Accessories

10 Appendix

Index



## Sending Images to a Registered Web Service

### Registering Web Services

Use a smartphone or computer to add to the camera Web services that you want to use.

- A smartphone or computer with a browser and Internet connection is required to complete camera settings for CANON iIMAGE GATEWAY and other Web services.
- Check the CANON iIMAGE GATEWAY website for details on browser (Microsoft Internet Explorer, etc.) requirements, including settings and version information.
- For information on countries and regions where CANON iIMAGE GATEWAY is available, visit the Canon website (<http://www.canon.com/cig/>).
- You must have an account with Web services other than CANON iIMAGE GATEWAY if you desire to use them. For further details, check the websites for each Web service you want to register.
- Separate ISP connection and access point fees may be applicable.

### Registering CANON iIMAGE GATEWAY

After linking the camera and CANON iIMAGE GATEWAY, add CANON iIMAGE GATEWAY as a destination Web service on the camera.



#### 1 Log in to CANON iIMAGE GATEWAY and access the camera web link settings page.

- From a computer or smartphone, access <http://www.canon.com/cig/> to visit CANON iIMAGE GATEWAY.
- Once the login screen is displayed, enter your user name and password to log in. If you do not have a CANON iIMAGE GATEWAY account, follow the instructions to complete member registration (free of charge).



#### 2 Choose the type of camera.

- On this camera model, [Wi-Fi] is displayed in the Wi-Fi menu.
- Once you choose [Wi-Fi], a page is displayed for entering the authentication code. On this page in step 7, you will enter the authentication code displayed on the camera after steps 3 – 6.

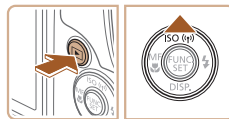

#### 3 Access the Wi-Fi menu.

- Press the [▶] button to turn the camera on.
- Press the [▲] button.
- When the [Device Nickname] screen is displayed, press the [OK] button. Use the keyboard displayed to enter a nickname (130). On the [Device Nickname] screen, press the [▲][▼] buttons to choose [OK], and then press the [OK] button.

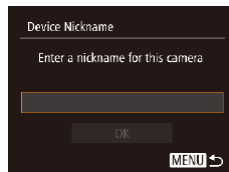

Before Use

Basic Guide

Advanced Guide

1 Camera Basics

2 Auto Mode / Hybrid Auto Mode

3 Other Shooting Modes

4 P Mode

5 Tv, Av, and M Mode

6 Playback Mode

7 Wi-Fi Functions

8 Setting Menu

9 Accessories

10 Appendix

Index

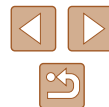

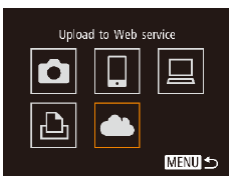

#### 4 Choose [Cloud].

- Press the [▲][▼][◀][▶] buttons to choose [Cloud], and then press the [OK] button.

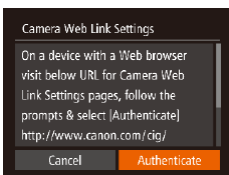

#### 5 Choose [Authenticate].

- Press the [◀][▶] buttons to choose [Authenticate], and then press the [OK] button.

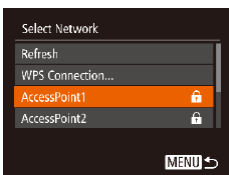

#### 6 Establish a connection with an access point.

- Connect to the access point as described in steps 5 – 7 in “Using WPS-Compatible Access Points” (107) or in steps 2 – 4 in “Connecting to Listed Access Points” (109).
- Once the camera is connected to CANON iMAGE GATEWAY via the access point, an authentication code is displayed.

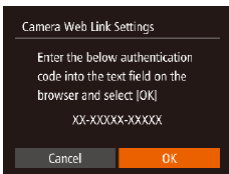

#### 7 Enter the authentication code.

- On the smartphone or computer, enter the authentication code displayed on the camera and go to the next step.
- A six-digit confirmation number is displayed.

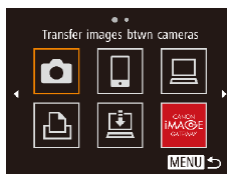
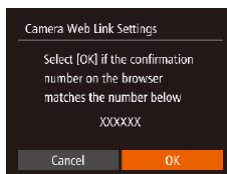

#### 8 Check the confirmation numbers and complete the setup process.

- Make sure the confirmation number on the camera matches the number on the smartphone or computer.
- Press the [◀][▶] buttons to choose [OK], and then press the [OK] button.
- Complete the setup process on the smartphone or computer.

- [Camera icon] (118) and CANON iMAGE GATEWAY are now added as destinations, and the [Cloud] icon changes to [Camera icon].
- A message is displayed on the smartphone or computer to indicate that this process is finished. To add other Web services, follow the procedure in “Registering Other Web Services” (113) from step 2.



- Connections require that a memory card with saved images be in the camera.
- Once you have connected to devices via the Wi-Fi menu, recent destinations will be listed first when you access the menu. Press the [◀][▶] buttons to access the device selection screen and choose a device.

Before Use
Basic Guide
Advanced Guide
1 Camera Basics
2 Auto Mode / Hybrid Auto Mode
3 Other Shooting Modes
4 P Mode
5 Tv, Av, and M Mode
6 Playback Mode
7 Wi-Fi Functions
8 Setting Menu
9 Accessories
10 Appendix
Index

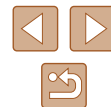



## Registering Other Web Services

You can also add Web services besides CANON iMAGE GATEWAY to the camera. Note that CANON iMAGE GATEWAY must be registered on the camera first (111).



### 1 Access the Web service settings screen.

- Follow step 1 in “Registering CANON iMAGE GATEWAY” (111) to log in to CANON iMAGE GATEWAY, and then access the Web service settings screen.



### 2 Configure the Web service you want to use.

- Follow the instructions displayed on the smartphone or computer to set up the Web service.

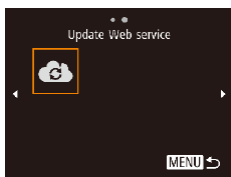

### 3 Choose [Cloud].

- In Playback mode, press the [▲] button to access the Wi-Fi menu.
- Press the [▲][▼][◀][▶] buttons to choose [Cloud], and then press the [OK] button.
- The Web service settings are now updated.



- If any configured settings change, follow these steps again to update the camera settings.

## Uploading Images to Web Services

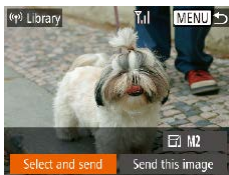
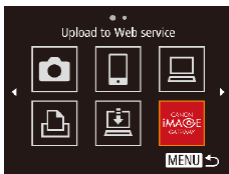
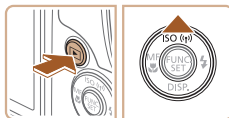

### 1 Access the Wi-Fi menu.

- Press the [▶] button to turn the camera on.
- Press the [▲] button.

### 2 Choose the destination.

- Press the [▲][▼] buttons to choose the icon of the Web service for sharing, and then press the [OK] button.
- If multiple recipients or sharing options are used with a Web service, choose the desired item on the [Select Recipient] screen by pressing the [▲][▼] buttons, and then press the [OK] button.

### 3 Send images.

- Press the [▲][▼][◀][▶] buttons to choose [Select and send], and then press the [OK] button.
- Press the [▲][▼][◀][▶] buttons to choose an image to send, press the [OK] button to mark it as selected (✓), and then press the [MENU] button.
- Press the [▲][▼][◀][▶] buttons to choose [Send], and then press the [OK] button.
- When uploading to YouTube, read the terms of service, choose [I Agree], and press the [OK] button.
- Image transfer will begin. The screen darkens during image transfer.
- After the images are sent, [OK] is displayed. Press the [OK] button to return to the playback screen.

Before Use

Basic Guide

Advanced Guide

1 Camera Basics

2 Auto Mode / Hybrid Auto Mode

3 Other Shooting Modes

4 P Mode

5 Tv, Av, and M Mode

6 Playback Mode

7 Wi-Fi Functions

8 Setting Menu

9 Accessories

10 Appendix

Index

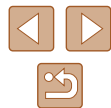



- Connections require that a memory card with saved images be in the camera.
- You can also send multiple images at once and resize images or add comments before sending (📖117).
- You can send the current image by choosing [Send this image] on the screen in step 3.

## Printing Images Wirelessly from a Connected Printer

Connect the camera to a printer via Wi-Fi to print as follows. These steps show how to use the camera as an access point, but you can also use an existing access point (📖114).

### 1 Access the Wi-Fi menu.

- Access the Wi-Fi menu as described in step 2 in “Adding a Smartphone Using the Wi-Fi Menu” (📖102).

### 2 Choose [🖨️].

- Press the [▲][▼][◀][▶] buttons to choose [🖨️], and then press the [⊕] button.



### 3 Choose [Add a Device].

- Press the [▲][▼] buttons to choose [Add a Device], and then press the [⊕] button.

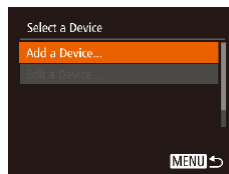

- The camera's SSID is displayed.

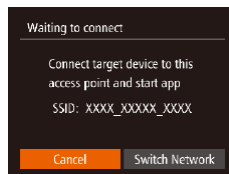

Before Use

Basic Guide

Advanced Guide

1 Camera Basics

2 Auto Mode / Hybrid Auto Mode

3 Other Shooting Modes

4 P Mode

5 Tv, Av, and M Mode

6 Playback Mode

7 Wi-Fi Functions

8 Setting Menu

9 Accessories

10 Appendix

Index



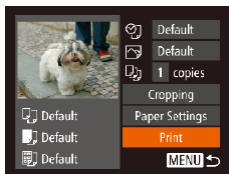
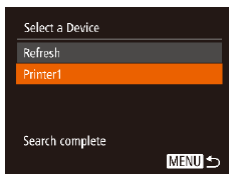

#### 4 Connect the printer to the network.

- In the printer's Wi-Fi setting menu, choose the SSID (network name) displayed on the camera to establish a connection.

#### 5 Choose the printer.

- Press the [▲][▼] buttons to choose the printer name, and then press the [⊞] button.

#### 6 Choose an image to print.

- Press the [◀][▶] buttons to choose an image.
- Press the [⊞] button, choose [📄], and press the [⊞] button again.
- Press the [⊞] button.
- Press the [▲][▼] buttons to choose [Print], and then press the [⊞] button.
- For detailed printing instructions, see "Printing Images" (📖140).
- To cancel the connection, press the [▲] button, press the [◀][▶] buttons on the confirmation screen to choose [OK], and then press the [⊞] button.



- Connections require that a memory card with saved images be in the camera.
- Once you have connected to devices via the Wi-Fi menu, recent destinations will be listed first when you access the Wi-Fi menu. You can easily connect again by pressing the [▲][▼] buttons to choose the device and then pressing the [⊞] button. To add a new device, display the device selection screen by touching [◀][▶], and then configure the setting.
- If you prefer not to display recent target devices, choose MENU (📖29) > [↑] tab > [Wi-Fi Settings] > [Target History] > [Off].
- To use another access point, follow steps 3 – 4 in "Using Another Access Point" (📖104).

Before Use
Basic Guide
Advanced Guide
<b>1</b> Camera Basics
<b>2</b> Auto Mode / Hybrid Auto Mode
<b>3</b> Other Shooting Modes
<b>4</b> P Mode
<b>5</b> Tv, Av, and M Mode
<b>6</b> Playback Mode
<b>7</b> Wi-Fi Functions
<b>8</b> Setting Menu
<b>9</b> Accessories
<b>10</b> Appendix
Index



## Sending Images to Another Camera

Connect two cameras via Wi-Fi and send images between them as follows.

- Only Canon-brand cameras equipped with a Wi-Fi function can be connected to wirelessly. Even Canon-brand cameras that support Eye-Fi cards cannot be connected to if they do not have a Wi-Fi function. You cannot connect to PowerShot SD430 DIGITAL ELPH WIRELESS/DIGITAL IXUS WIRELESS cameras with this camera.

### 1 Access the Wi-Fi menu.

- Access the Wi-Fi menu as described in step 2 in “Adding a Smartphone Using the Wi-Fi Menu” (102).

### 2 Choose [Camera].

- Press the [▲][▼][◀][▶] buttons to choose [Camera], and then press the [OK] button.

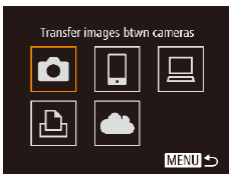

### 3 Choose [Add a Device].

- Press the [▲][▼] buttons to choose [Add a Device], and then press the [OK] button.
- Follow steps 1 – 3 on the target camera too.
- Camera connection information will be added when [Start connection on target camera] is displayed on both camera screens.

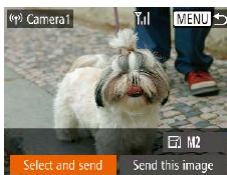
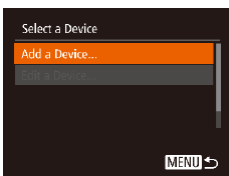

### 4 Send images.

- Press the [▲][▼][◀][▶] buttons to choose [Select and send], and then press the [OK] button.
- Press the [▲][▼][◀][▶] buttons to choose an image to send, press the [OK] button to mark it as selected ([✓]), and then press the [MENU] button.
- Press the [▲][▼][◀][▶] buttons to choose [Send], and then press the [OK] button.
- Image transfer will begin. The screen darkens during image transfer.
- [Transfer completed] is displayed after the image is sent, and the image transfer screen is displayed again.
- To cancel the connection, press the [MENU] button, press the [◀][▶] buttons on the confirmation screen to choose [OK], and then press the [OK] button.



- Connections require that a memory card be in the camera.
- Once you have connected to devices via the Wi-Fi menu, recent destinations will be listed first when you access the Wi-Fi menu. You can easily connect again by pressing the [▲][▼] buttons to choose the device and then pressing the [OK] button. To add a new device, display the device selection screen by touching [◀][▶], and then configure the setting.
- If you prefer not to display recent target devices, choose MENU (129) > [↑] tab > [Wi-Fi Settings] > [Target History] > [Off].
- You can also send multiple images at once and change the image size before sending (117).
- You can send the current image by choosing [Send this image] on the screen in step 4.

Before Use

Basic Guide

Advanced Guide

1 Camera Basics

2 Auto Mode / Hybrid Auto Mode

3 Other Shooting Modes

4 P Mode

5 Tv, Av, and M Mode

6 Playback Mode

7 Wi-Fi Functions

8 Setting Menu

9 Accessories

10 Appendix

Index

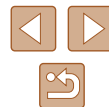

## Image Sending Options

You can choose multiple images to send at once and change the image resolution (size) before sending. Some Web services also enable you to annotate the images you send.

### Notes on Sending Images

- Keep your fingers or other objects off the Wi-Fi antenna area (📖4). Covering this may decrease the speed of your image transfers.
- Depending on the condition of the network you are using, it may take a long time to send movies. Be sure to keep an eye on the camera battery level.
- Up to 50 images can be sent together at once. You can send movies together as long as the total playback time is within two minutes. However, Web services may limit the number of images or length of movies you can send. For details, refer to the Web service you are using.
- When sending movies to smartphones, note that the supported image quality varies depending on the smartphone. For details, refer to the smartphone user manual.
- On the screen, wireless signal strength is indicated by the following icons.  
📶 high, 📶 medium, 📶 low, 📶 weak
- Sending images to Web services will take less time when resending images you have already sent that are still on the CANON iMAGE GATEWAY server.

## Choosing the Image Resolution (Size)

On the image transfer screen, choose [📷] by pressing the [▲][▼] buttons, and then press the [📷] button. On the screen displayed, choose the resolution by pressing the [▲][▼] buttons, and then press the [📷] button.

- To send images at original size, select [No] as the resizing option.
- Choosing [M2] or [S] will resize images that are larger than the selected size before sending.
- Movies cannot be resized.



- Image size can also be configured in MENU (📖29) > [📷] tab > [Wi-Fi Settings] > [Resize for Sending]. Images will also be sent at this size when you send the current image in single-image display via NFC.

Before Use

Basic Guide

Advanced Guide

**1** Camera Basics

**2** Auto Mode / Hybrid Auto Mode

**3** Other Shooting Modes

**4** P Mode

**5** Tv, Av, and M Mode

**6** Playback Mode

**7** Wi-Fi Functions

**8** Setting Menu

**9** Accessories

**10** Appendix

Index

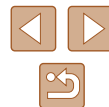

## Adding Comments

Using the camera, you can add comments to images that you send to e-mail addresses, social networking services, etc. The number of characters and symbols that can be entered may differ depending on the Web service.

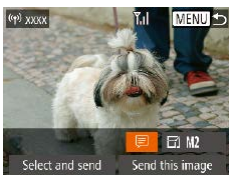

### 1 Access the screen for adding comments.

- On the image transfer screen, choose [ ] by pressing the [▲][▼][◀][▶] buttons, and then press the [ ] button.

### 2 Add a comment ( 30).

### 3 Send the image.



- When a comment is not entered, the comment set in CANON iMAGE GATEWAY is automatically sent.
- You can also annotate multiple images before sending them. The same comment is added to all images sent together.

## Sending Images Automatically (Image Sync)

Images on the memory card that have not been transferred already can be sent to a computer or Web services via CANON iMAGE GATEWAY. Note that images cannot be sent only to Web services.

## Initial Preparations

### ■ Preparing the Camera

Register [ ] as the destination. You can also assign [ ] to the [ ] button, so that you can simply press the [ ] button to send any unsent images on the memory card to a computer via CANON iMAGE GATEWAY.



### 1 Add [ ] as a destination.

- Add [ ] as a destination, as described in "Registering CANON iMAGE GATEWAY" ( 111).
- To choose a Web service as the destination, follow the steps in "Registering Other Web Services" ( 113) to update the camera settings.

### 2 Choose the type of images to send (only when sending movies with images).

- Press the [MENU] button and choose [Wi-Fi Settings] on the [ ] tab ( 29).
- Press the [▲][▼] buttons to choose [Image Sync], and then press the [◀][▶] buttons to choose [Stills/Movies].

Before Use

Basic Guide

Advanced Guide

1 Camera Basics

2 Auto Mode / Hybrid Auto Mode

3 Other Shooting Modes

4 P Mode

5 Tv, Av, and M Mode

6 Playback Mode

7 Wi-Fi Functions

8 Setting Menu







9 Accessories

10 Appendix

Index



### 3 Assign to the button (only when sending images by pressing the button).

- Clear the  button setting if a smartphone is already assigned to the button ( 101).
- Access the mobile connection screen as described in step 2 in “Sending to a Smartphone Assigned to the Button” ( 101), press the  buttons to choose , and then press the  button.

## ■ Preparing the Computer



Install and configure the software on the destination computer.



### 1 Install the software.

- Install the software on a computer connected to the Internet ( 105).







### 2 Register the camera.

- Windows: In the taskbar, right-click , and then click [Add new camera].
- Mac OS: In the menu bar, click , and then click [Add new camera].
- A list of cameras linked to CANON iMAGE GATEWAY is displayed. Choose the camera from which images are to be sent.
- Once the camera is registered and the computer is ready to receive images, the icon changes to .

## Sending Images

Images sent from the camera are automatically saved to the computer. If the computer that you intend to send images to is turned off, the images will be stored temporarily on the CANON iMAGE GATEWAY server. Stored images are regularly erased, so make sure to turn on the computer and save the images.

### 1 Send images.

- If you have already assigned  to the  button, press the  button.
- If you have not assigned the button this way, choose  as described in steps 1 – 2 in “Uploading Images to Web Services” ( 113).
- Once the connection is established, the images are sent. When the images have been sent successfully to the CANON iMAGE GATEWAY server,  is displayed on the screen.

### 2 Save the images to the computer.

- Images are automatically saved to the computer when you turn it on.
- Images are automatically sent to Web services from the CANON iMAGE GATEWAY server, even if the computer is off.



- When sending images, you should use a fully charged battery pack or an AC adapter kit (sold separately,  132).

Before Use
Basic Guide
Advanced Guide
1 Camera Basics
2 Auto Mode / Hybrid Auto Mode
3 Other Shooting Modes
4 P Mode
5 Tv, Av, and M Mode
6 Playback Mode
7 Wi-Fi Functions
8 Setting Menu
9 Accessories
10 Appendix
Index

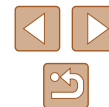



- Even if images were imported to the computer through a different method, any images not sent to the computer via CANON iMAGE GATEWAY will be sent to the computer.
- Sending is faster when the destination is a computer on the same network as the camera, because images are sent via the access point instead of CANON iMAGE GATEWAY. Note that images stored on the computer are sent to CANON iMAGE GATEWAY, so the computer must be connected to the Internet.

## Using a Smartphone to View Camera Images and Control the Camera

You can do the following with the dedicated smartphone app CameraWindow.

- Browse images on the camera and save them to the smartphone
- Geotag images on the camera (📖120)
- Shoot remotely (📖121)



- In camera settings, the smartphone must be allowed to view camera images (📖101, 📖102, 📖122).

## Geotagging Images on the Camera

GPS data recorded on a smartphone using the dedicated CameraWindow application can be added to images on the camera. Images are tagged with information including the latitude, longitude, and elevation.



- Before shooting, make sure the date and time and your home time zone are set correctly, as described in “Setting the Date and Time” (📖20). Also follow the steps in “World Clock” (📖125) to specify any shooting destinations in other time zones.
- Others may be able to locate or identify you by using location data in your geotagged still images or movies. Be careful when sharing these images with others, as when posting images online where many others can view them.

Before Use

Basic Guide

Advanced Guide

**1** Camera Basics

**2** Auto Mode / Hybrid Auto Mode

**3** Other Shooting Modes

**4** P Mode

**5** Tv, Av, and M Mode

**6** Playback Mode

**7** Wi-Fi Functions

**8** Setting Menu

**9** Accessories

**10** Appendix

Index





## Shooting Remotely

As you check a shooting screen on your smartphone, you can use it to shoot remotely.

### 1 Secure the camera.

- Once remote shooting begins, the camera lens will come out. Lens motion from zooming may also move the camera out of position. Keep the camera still by mounting it on a tripod or taking other measures.

### 2 Connect the camera and smartphone (📖101, 📖102).

- In the privacy settings, choose [Yes].

### 3 Choose remote shooting.

- In CameraWindow on the smartphone, choose remote shooting.
- The camera lens will come out. Do not press near the lens, and make sure no objects will obstruct it.
- Once the camera is ready for remote shooting, a live image from the camera will be displayed on the smartphone.
- At this time, a message is displayed on the camera, and all operations except pressing the power button are disabled.

### 4 Shoot.

- Use the smartphone to shoot.



- The camera works in [P] mode during remote shooting. However, some FUNC. and MENU settings you have configured in advance may be changed automatically.
- Movie shooting is not available.



- Any jerky subject motion shown on the smartphone due to the connection environment will not affect recorded images.
- No AF frames are displayed. Capture a test image to check the focus.
- Captured images are not transferred to the smartphone. Use the smartphone to browse and import images from the camera.

Before Use

Basic Guide

Advanced Guide

1 Camera Basics

2 Auto Mode / Hybrid Auto Mode

3 Other Shooting Modes

4 P Mode

5 Tv, Av, and M Mode

6 Playback Mode

7 Wi-Fi Functions

8 Setting Menu

9 Accessories

10 Appendix

Index

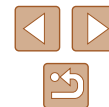

## Editing or Erasing Wi-Fi Settings

Edit or erase Wi-Fi settings as follows.

### Editing Connection Information

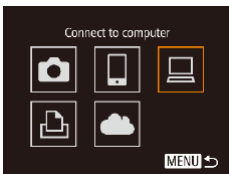

#### 1 Access the Wi-Fi menu and choose the device to edit.

- Press the [▶] button to turn the camera on.
- Press the [▲] button.
- Press the [◀][▶] buttons to access the device selection screen, press the [▲][▼][◀][▶] buttons to choose the icon of a device to edit, and then press the [⊞] button.

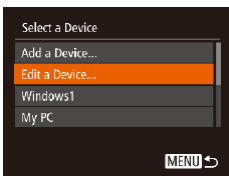

#### 2 Choose [Edit a Device].

- Press the [▲][▼] buttons to choose [Edit a Device], and then press the [⊞] button.

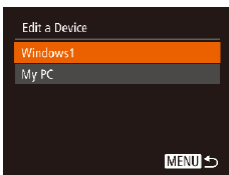

#### 3 Choose a device to edit.

- Press the [▲][▼] buttons to choose the device to edit, and then press the [⊞] button.

#### 4 Choose an item to edit.

- Press the [▲][▼] buttons to choose an item to edit, and then press the [⊞] button.
- The items you can change depend on what device or service the camera will access.

Configurable Items	Connection				
	📷	📱	💻	🖨️	Web Services
[Change Device Nickname] (📖122)	○	○	○	○	–
[View Settings] (📖101)	–	○	–	–	–
[Erase Connection Info] (📖123)	○	○	○	○	–

○ : Configurable – : Not configurable

#### Changing a Device Nickname

You can change the device nickname (display name) that is displayed on the camera.

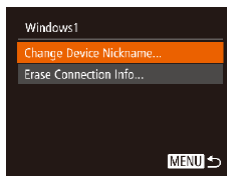

- Following step 4 in “Editing Connection Information” (📖122), choose [Change Device Nickname] and press the [⊞] button.
- Select the input field and press the [⊞] button. Use the keyboard displayed to enter a new nickname (📖30).

Before Use

Basic Guide

Advanced Guide

1 Camera Basics

2 Auto Mode / Hybrid Auto Mode

3 Other Shooting Modes

4 P Mode

5 Tv, Av, and M Mode

6 Playback Mode

7 Wi-Fi Functions

8 Setting Menu

9 Accessories

10 Appendix

Index

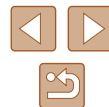

## Erasing Connection Information

Erase connection information (information about devices that you have connected to) as follows.

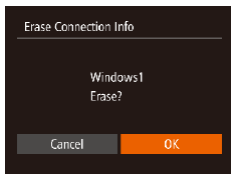

- Following step 4 in “Editing Connection Information” (122), choose [Erase Connection Info] and press the [MENU] button.
- After [Erase?] is displayed, press the [◀][▶] buttons to choose [OK], and then press the [MENU] button.
- The connection information will be erased.

## Returning the Wi-Fi Settings to Default

Return the Wi-Fi settings to default if you transfer ownership of the camera to another person, or dispose of it.

Resetting the Wi-Fi settings will also clear all Web service settings. Be sure that you want to reset all Wi-Fi settings before using this option.

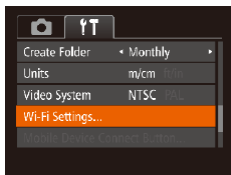

### 1 Choose [Wi-Fi Settings].

- Press the [MENU] button and choose [Wi-Fi Settings] on the [↑] tab (29).

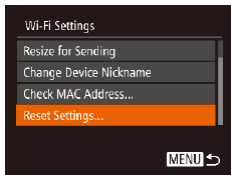

### 2 Choose [Reset Settings].

- Press the [▲][▼] buttons to choose [Reset Settings], and then press the [MENU] button.

### 3 Restore the default settings.

- Press the [◀][▶] buttons to choose [OK], and then press the [MENU] button.
- The Wi-Fi settings are now reset.



- To reset other settings (aside from Wi-Fi) to defaults, choose [Reset All] on the [↑] tab (130).

Before Use

Basic Guide

Advanced Guide

1 Camera Basics

2 Auto Mode / Hybrid Auto Mode

3 Other Shooting Modes

4 P Mode

5 Tv, Av, and M Mode

6 Playback Mode

7 Wi-Fi Functions

8 Setting Menu

9 Accessories

10 Appendix

Index

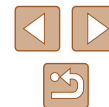

# 8

## Setting Menu

Customize or adjust basic camera functions for greater convenience

### Adjusting Basic Camera Functions

MENU (📖29) functions on the (🔼🔽) tab can be configured. Customize commonly used functions as desired, for greater convenience.

#### Silencing Camera Operations

Silence camera sounds and movies as follows.

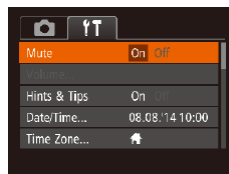

- Choose [Mute], and then choose [On].



- Operation can also be silenced by holding down the [▼] button as you turn the camera on.
- Sound is not played during movies (📖77) if you mute camera sounds. To restore sound during movies, press the [▲] button. Adjust volume with the [▲][▼] buttons, as needed.

#### Adjusting the Volume

Adjust the volume of individual camera sounds as follows.

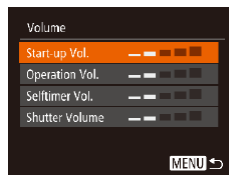

- Choose [Volume], and then press the (🔊) button.
- Choose an item, and then press the [◀][▶] buttons to adjust the volume.

Before Use
Basic Guide
Advanced Guide
<b>1</b> Camera Basics
<b>2</b> Auto Mode / Hybrid Auto Mode
<b>3</b> Other Shooting Modes
<b>4</b> P Mode
<b>5</b> Tv, Av, and M Mode
<b>6</b> Playback Mode
<b>7</b> Wi-Fi Functions
<b>8</b> Setting Menu
<b>9</b> Accessories
<b>10</b> Appendix
Index



## Hiding Hints and Tips

Hints and tips are normally shown when you choose FUNC. (📖28) or MENU (📖29) items. If you prefer, you can deactivate this information.

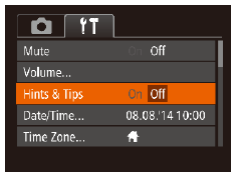

- Choose [Hints & Tips], and then choose [Off].

## Date and Time

Adjust the date and time as follows.

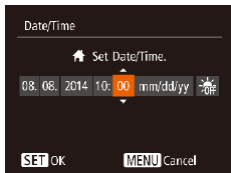

- Choose [Date/Time], and then press the [OK] button.
- Press the [◀][▶] buttons to choose an option, and then press the [▲][▼] buttons to adjust the setting.

## World Clock

To ensure that your shots will have the correct local date and time when you travel abroad, simply register the destination in advance and switch to that time zone. This convenient feature eliminates the need to change the Date/Time setting manually.

Before using the world clock, be sure to set the date and time and your home time zone, as described in "Setting the Date and Time" (📖20).

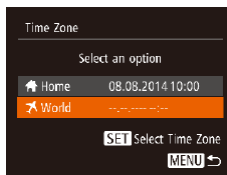

### 1 Specify your destination.

- Choose [Time Zone], and then press the [OK] button.
- Press the [▲][▼] buttons to choose [World], and then press the [OK] button.
- Press the [◀][▶] buttons to choose the destination.
- To set daylight saving time (1 hour ahead), choose [☀] by pressing the [▲][▼] buttons, and then choose [☀] by pressing the [◀][▶] buttons.
- Press the [OK] button.

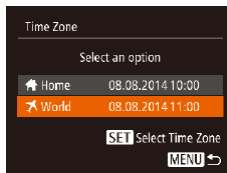

### 2 Switch to the destination time zone.

- Press the [▲][▼] buttons to choose [World], and then press the [MENU] button.
- [World] is now shown on the shooting screen (📖152).



- Adjusting the date or time while in [World] mode (📖20) will automatically update your [Home] time and date.

Before Use

Basic Guide

Advanced Guide

1 Camera Basics

2 Auto Mode / Hybrid Auto Mode

3 Other Shooting Modes

4 P Mode

5 Tv, Av, and M Mode

6 Playback Mode

7 Wi-Fi Functions

8 Setting Menu

9 Accessories

10 Appendix

Index

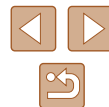

## Lens Retraction Timing

The lens is normally retracted for safety about one minute after you press the [ ] button in Shooting mode (25). To have the lens retracted immediately after you press the [ ] button, set the retraction timing to [0 sec.].

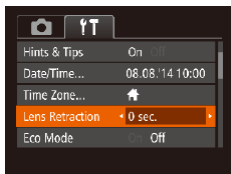

- Choose [Lens Retraction], and then choose [0 sec.].

## Using Eco Mode

This function allows you to conserve battery power in Shooting mode. When the camera is not in use, the screen quickly darkens to reduce battery consumption.

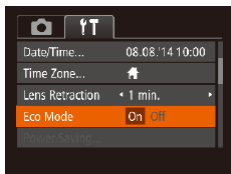

### 1 Configure the setting.

- Choose [Eco Mode], and then choose [On].
- [ECO] is now shown on the shooting screen (152).
- The screen darkens when the camera is not used for approximately two seconds; approximately ten seconds after darkening, the screen turns off. The camera turns off after approximately three minutes of inactivity.

### 2 Shoot.

- To activate the screen and prepare for shooting when the screen is off but the lens is still out, press the shutter button halfway.

## Power-Saving Adjustment

Adjust the timing of automatic camera and screen deactivation (Auto Power Down and Display Off, respectively) as needed (26).

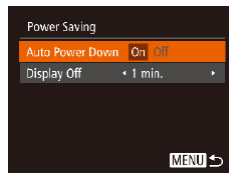

- Choose [Power Saving], and then press the [ ] button.
- After choosing an item, press the [ ][ ] buttons to adjust it as needed.



- To conserve battery power, you should normally choose [On] for [Auto Power Down] and [1 min.] or less for [Display Off].



- The [Display Off] setting is applied even if you set [Auto Power Down] to [Off].
- These power-saving functions are not available when you have set Eco mode (126) to [On].

Before Use

Basic Guide

Advanced Guide

1 Camera Basics

2 Auto Mode / Hybrid Auto Mode

3 Other Shooting Modes

4 P Mode

5 Tv, Av, and M Mode

6 Playback Mode

7 Wi-Fi Functions

8 Setting Menu

9 Accessories

10 Appendix

Index



## Screen Brightness

Adjust screen brightness as follows.

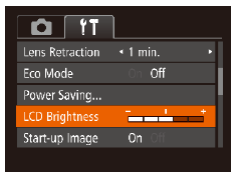

- Choose [LCD Brightness], and then press the [◀][▶] buttons to adjust the brightness.



- For maximum brightness, press and hold the [▼] button for at least one second when the shooting screen is displayed or when in single-image display. (This will override the [LCD Brightness] setting on the [↑] tab.) To restore the original brightness, press and hold the [▼] button again for at least one second or restart the camera.

## Hiding the Start-Up Screen

If you prefer, you can deactivate display of the start-up screen normally shown when you turn the camera on.

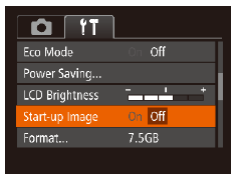

- Choose [Start-up Image], and then choose [Off].

## Formatting Memory Cards

Before using a new memory card or a card formatted in another device, you should format the card with this camera.

Formatting erases all data on a memory card. Before formatting, copy images on the memory card to a computer, or take other steps to back them up.

### 1 Access the [Format] screen.

- Choose [Format], and then press the [Ⓜ] button.

### 2 Choose [OK].

- Press the [▲][▼] buttons to choose [Cancel], press the [◀][▶] buttons to choose [OK], and then press the [Ⓜ] button.

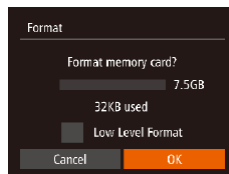

### 3 Format the memory card.

- To begin the formatting process, press the [▲][▼] buttons to choose [OK], and then press the [Ⓜ] button.
- When formatting is finished, [Memory card formatting complete] is displayed. Press the [Ⓜ] button.

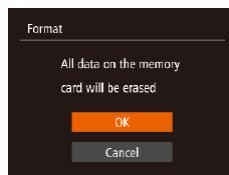

- Formatting or erasing data on a memory card only changes file management information on the card and does not erase the data completely. When transferring or disposing of memory cards, take steps to protect personal information if necessary, as by physically destroying cards.

Before Use

Basic Guide

Advanced Guide

1 Camera Basics

2 Auto Mode / Hybrid Auto Mode

3 Other Shooting Modes

4 P Mode

5 Tv, Av, and M Mode

6 Playback Mode

7 Wi-Fi Functions

8 Setting Menu

9 Accessories

10 Appendix

Index

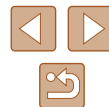



- The total card capacity indicated on the formatting screen may be less than the advertised capacity.

## Low-Level Formatting

Perform low-level formatting in the following cases: [Memory card error] is displayed, the camera is not working correctly, card image reading/writing is slower, continuous shooting is slower, or movie recording suddenly stops. Low-level formatting erases all data on a memory card. Before low-level formatting, copy images on the memory card to a computer, or take other steps to back them up.

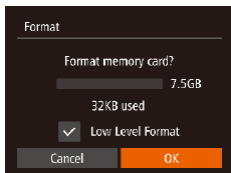

- On the screen in step 2 of “Formatting Memory Cards” (📖127), press the [▲][▼] buttons to choose [Low Level Format], and then press the [◀][▶] buttons to select this option. A [✓] icon is displayed.
- Follow steps 2 – 3 in “Formatting Memory Cards” (📖127) to continue with the formatting process.



- Low-level formatting takes longer than “Formatting Memory Cards” (📖127), because data is erased from all storage regions of the memory card.
- You can cancel low-level formatting in progress by choosing [Stop]. In this case, all data will be erased, but the memory card can be used normally.

## File Numbering

Your shots are automatically numbered in sequential order (0001 – 9999) and saved in folders that store up to 2,000 images each. You can change how the camera assigns file numbers.

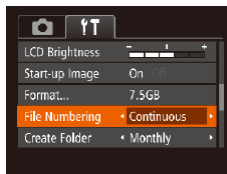

- Choose [File Numbering], and then choose an option.

Continuous	Images are numbered consecutively (until the 9999th shot is taken/saved) even if you switch memory cards.
Auto Reset	Image numbering is reset to 0001 if you switch memory cards, or when a new folder is created.



- Regardless of the option selected in this setting, shots may be numbered consecutively after the last number of existing images on newly inserted memory cards. To start saving shots from 0001, use an empty (or formatted (📖127)) memory card.

Before Use

Basic Guide

Advanced Guide

**1** Camera Basics

**2** Auto Mode / Hybrid Auto Mode

**3** Other Shooting Modes

**4** P Mode

**5** Tv, Av, and M Mode

**6** Playback Mode

**7** Wi-Fi Functions

**8** Setting Menu

**9** Accessories

**10** Appendix

Index





## Date-Based Image Storage

Instead of saving images in folders created each month, you can have the camera create folders each day you shoot to store shots taken that day.

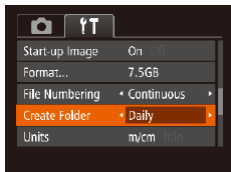

- Choose [Create Folder], and then choose [Daily].
- Images will now be saved in folders created on the shooting date.

## Metric / Non-Metric Display

Change the unit of measurement shown in GPS elevation information (120), the zoom bar (32), the MF indicator (66), and elsewhere from m/cm to ft/in as needed.

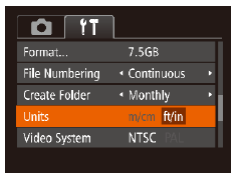

- Choose [Units], and then choose [ft/in].

## Checking Certification Logos

Some logos for certification requirements met by the camera can be viewed on the screen. Other certification logos are printed in this guide, on the camera packaging, or on the camera body.

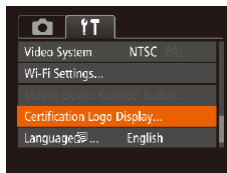

- Choose [Certification Logo Display], and then press the [MENU] button.

## Display Language

Change the display language as needed.



- Choose [Language] (33), and then press the [MENU] button.
- Press the [▲][▼][◀][▶] buttons to choose a language, and then press the [MENU] button.



- You can also access the [Language] screen in Playback mode by pressing and holding the [MENU] button and immediately pressing the [MENU] button.

Before Use

Basic Guide

Advanced Guide

**1** Camera Basics

**2** Auto Mode / Hybrid Auto Mode

**3** Other Shooting Modes

**4** P Mode

**5** Tv, Av, and M Mode

**6** Playback Mode

**7** Wi-Fi Functions

**8** Setting Menu

**9** Accessories

**10** Appendix

Index

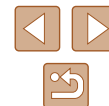

## Adjusting Other Settings

The following settings can also be adjusted on the [f] tab.

- [Video System] (134)
- [Wi-Fi Settings] (97)
- [Mobile Device Connect Button] (101)

## Restoring Defaults

If you accidentally change a setting, you can restore default camera settings.

### 1 Access the [Reset All] screen.

- Choose [Reset All], and then press the [⏏] button.

### 2 Restore default settings.

- Press the [◀][▶] buttons to choose [OK], and then press the [⏏] button.
- Default settings are now restored.

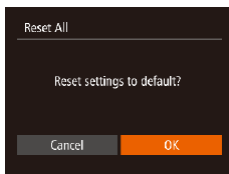

- The following functions are not restored to default settings.
  - [f] tab settings [Date/Time] (125), [Time Zone] (125), [Language] (129), and [Video System] (134)
  - Custom white balance data you have recorded (64)
  - Shooting mode chosen in **ISCRi** (53) and [O] (54) modes
  - Wi-Fi settings (97)

Before Use

Basic Guide

Advanced Guide

1 Camera Basics

2 Auto Mode / Hybrid Auto Mode

3 Other Shooting Modes

4 P Mode

5 Tv, Av, and M Mode

6 Playback Mode

7 Wi-Fi Functions

8 Setting Menu

9 Accessories

10 Appendix

Index

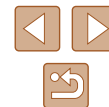

# 9

## Accessories

Enjoy the camera in more ways with optional Canon accessories and other compatible accessories sold separately

## System Map

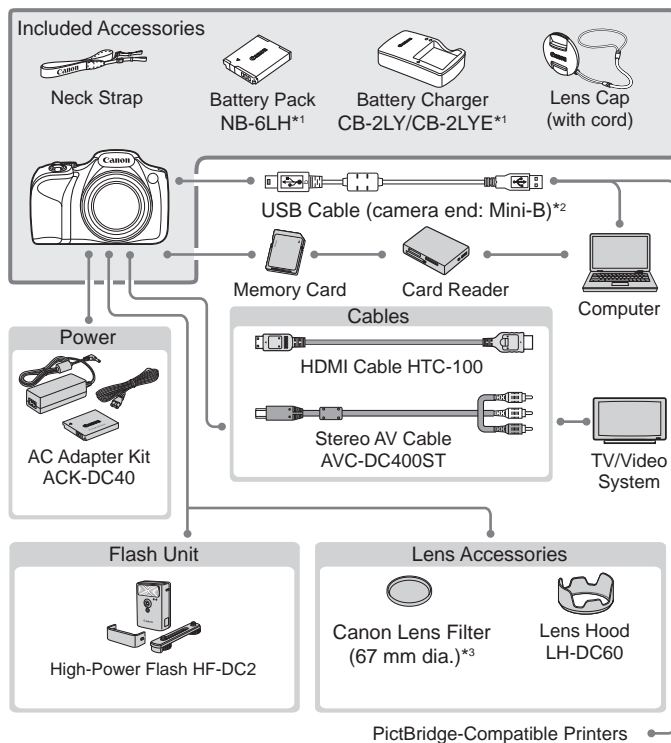

\*1 Also available for purchase separately.

\*2 A genuine Canon accessory is also available (Interface Cable IFC-400PCU).

\*3 Requires Filter Adapter FA-DC67A.

Before Use

Basic Guide

Advanced Guide

**1** Camera Basics

**2** Auto Mode / Hybrid Auto Mode

**3** Other Shooting Modes

**4** P Mode

**5** Tv, Av, and M Mode

**6** Playback Mode

**7** Wi-Fi Functions

**8** Setting Menu

**9** Accessories

**10** Appendix

Index



### Use of genuine Canon accessories is recommended.

This product is designed to achieve excellent performance when used with genuine Canon accessories. Canon shall not be liable for any damage to this product and/or accidents such as fire, etc., caused by the malfunction of non-genuine Canon accessories (e.g., a leakage and/or explosion of a battery pack). Please note that this warranty does not apply to repairs arising out of the malfunction of non-genuine Canon accessories, although you may request such repairs on a chargeable basis.

## Optional Accessories

The following camera accessories are sold separately. Note that availability varies by area, and some accessories may no longer be available.

### Power Supplies

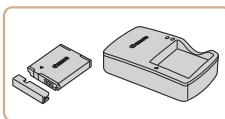

#### Battery Pack NB-6LH

- Rechargeable lithium-ion battery

#### Battery Charger CB-2LY/CB-2LYE

- Charger for Battery Pack NB-6LH

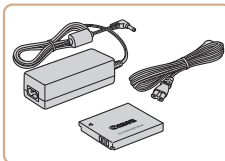

#### AC Adapter Kit ACK-DC40

- For powering the camera using household power. Recommended when using the camera over extended periods, or when connecting the camera to a printer or computer. Cannot be used to charge the battery pack in the camera.



- The battery pack includes a convenient cover which you can attach to know the charge status at a glance. Attach the cover so that ▲ is visible on a charged battery pack, and attach it so that ▲ is not visible on an uncharged battery pack.
- Battery Pack NB-6L is also supported.

Before Use

Basic Guide

Advanced Guide

**1** Camera Basics

**2** Auto Mode /  
Hybrid Auto Mode

**3** Other Shooting Modes

**4** P Mode

**5** Tv, Av, and M Mode

**6** Playback Mode

**7** Wi-Fi Functions

**8** Setting Menu

**9** Accessories

**10** Appendix

Index





- The battery charger and AC adapter kit can be used in areas with 100 – 240 V AC power (50/60 Hz).
- For power outlets in a different format, use a commercially available adapter for the plug. Never use an electrical transformer designed for traveling, which may damage the battery pack.

## Flash Unit



### High-Power Flash HF-DC2

- External flash for illuminating subjects that are out of range of the built-in flash.



- High-Power Flash units cannot be used in **[M]** shooting mode, or in **[Av]** or **[Tv]** mode when [Flash Mode] is set to [Manual].

## Other Accessories

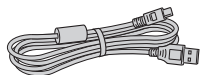

### Interface Cable IFC-400PCU

- For connecting the camera to a computer or printer.

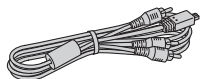

### Stereo AV Cable AVC-DC400ST

- Connect the camera to a TV to enjoy playback on the larger TV screen.

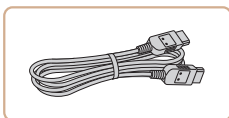

### HDMI Cable HTC-100

- For connecting the camera to an HDMI input of a high-definition TV.

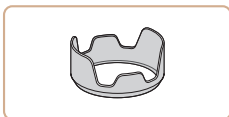

### Lens Hood LH-DC60

- Prevents extraneous light outside the angle of view from entering the lens and causing flares or ghosting, which reduce image quality.



### Filter Adapter FA-DC67A

- Adapter required when mounting a 67 mm filter.



- A lens filter and lens cap cannot be attached to the camera at the same time.

## Printer

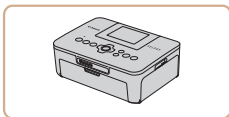

### Canon-Brand PictBridge-Compatible Printers

- Even without using a computer, you can print images by connecting the camera directly to a printer. For details, visit your nearest Canon retailer.

Before Use
Basic Guide
Advanced Guide
<b>1</b> Camera Basics
<b>2</b> Auto Mode / Hybrid Auto Mode
<b>3</b> Other Shooting Modes
<b>4</b> P Mode
<b>5</b> Tv, Av, and M Mode
<b>6</b> Playback Mode
<b>7</b> Wi-Fi Functions
<b>8</b> Setting Menu
<b>9</b> Accessories
<b>10</b> Appendix
Index



## Using Optional Accessories

▶ Still Images ▶ Movies

### Playback on a TV

▶ Still Images ▶ Movies

By connecting the camera to a TV, you can view your shots on the larger screen of the TV.

For details on connection or how to switch inputs, refer to the TV manual.



- Some information may not be displayed when viewing images on a TV (153).

### Playback on a High-Definition TV

▶ Still Images ▶ Movies

Connecting the camera to an HDTV with the HDMI Cable HTC-100 (sold separately) enables you to view your shots on the larger screen of the TV. Movies shot at a resolution of [FHD] or [HD] can be viewed in high definition.

**1** Make sure the camera and TV are off.

**2** Connect the camera to the TV.

- On the TV, insert the cable plug fully into the HDMI input as shown.

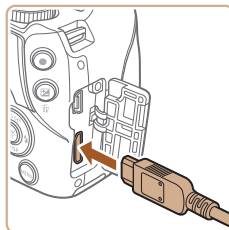
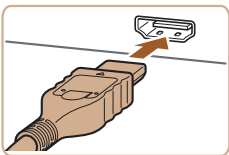

- On the camera, open the terminal cover and insert the cable plug fully into the camera terminal.

**3** Turn the TV on and switch to video input.

- Switch the TV input to the video input you connected the cable to in step 2.

**4** Turn the camera on.

- Press the [▶] button to turn the camera on.
- Images from the camera are now displayed on the TV. (Nothing is displayed on the camera screen.)
- When finished, turn off the camera and TV before disconnecting the cable.

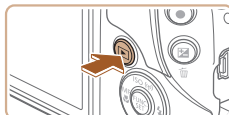

- Camera operating sounds are not played while the camera is connected to an HDTV.

### Playback on a Standard-Definition TV

▶ Still Images ▶ Movies

Connecting the camera to a TV with the Stereo AV Cable AVC-DC400ST (sold separately) enables you to view your shots on the larger screen of the TV as you control the camera.

**1** Make sure the camera and TV are off.

Before Use
Basic Guide
Advanced Guide
<b>1</b> Camera Basics
<b>2</b> Auto Mode / Hybrid Auto Mode
<b>3</b> Other Shooting Modes
<b>4</b> P Mode
<b>5</b> Tv, Av, and M Mode
<b>6</b> Playback Mode
<b>7</b> Wi-Fi Functions
<b>8</b> Setting Menu
<b>9</b> Accessories
<b>10</b> Appendix
Index



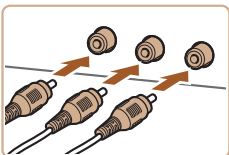

## 2 Connect the camera to the TV.

- On the TV, insert the cable plugs fully into the video inputs as shown.
- Make sure the cable plugs are in video inputs of the same color.

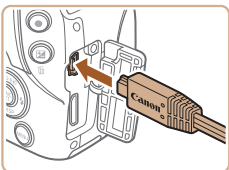

- On the camera, open the terminal cover and insert the cable plug fully into the camera terminal.

## 3 Display images.

- Follow steps 3 – 4 in “Playback on a High-Definition TV” (134) to display images.



- Correct display is not possible unless the camera video output format (NTSC or PAL) matches the TV format. To change the video output format, press the [MENU] button and choose [Video System] on the [F1] tab.



- When the camera and TV are connected, you can also shoot while previewing shots on the larger screen of the TV. To shoot, follow the same steps as when using the camera screen. However, AF-Point Zoom (47) and MF-Point Zoom (66) are not available.

## Powering the Camera with Household Power

► Still Images ► Movies

Powering the camera with AC Adapter Kit ACK-DC40 (sold separately) eliminates the need to monitor the remaining battery level.

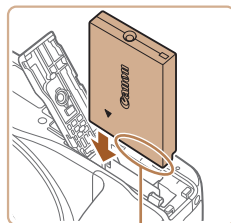

(1)

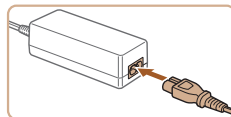
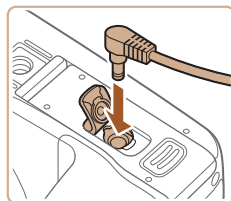

### 1 Make sure the camera is off.

### 2 Insert the coupler.

- Follow step 1 in “Inserting the Battery Pack and Memory Card” (19) to open the cover.
- Holding the coupler with the terminals (1) facing as shown, insert the coupler just as you would a battery pack (following step 2 in “Inserting the Battery Pack and Memory Card” (19)).
- Follow step 4 in “Inserting the Battery Pack and Memory Card” (19) to close the cover.

### 3 Connect the adapter to the coupler.

- Open the cover and insert the adapter plug fully into the coupler.

### 4 Connect the power cord.

- Insert one end of the power cord into the compact power adapter, and then plug the other end into a power outlet.
- Turn the camera on and use it as desired.
- When finished, turn the camera off and unplug the power cord from the outlet.

Before Use

Basic Guide

Advanced Guide

1 Camera Basics

2 Auto Mode / Hybrid Auto Mode

3 Other Shooting Modes

4 P Mode

5 Tv, Av, and M Mode

6 Playback Mode

7 Wi-Fi Functions

8 Setting Menu

9 Accessories

10 Appendix

Index





- Do not disconnect the adapter or unplug the power cord while the camera is still on. This may erase your shots or damage the camera.
- Do not attach the adapter or adapter cord to other objects. Doing so could result in malfunction or damage to the product.

## Using a Lens Hood (Sold Separately)

► Still Images ► Movies

For wide-angle shots of backlit subjects without using the flash, attach optional Lens Hood LH-DC60 to prevent light outside the angle of view from entering the lens.

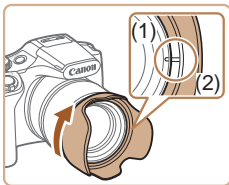

- Make sure the camera is off.
- Align the lens hood mark (2) with the camera mark (1), and turn the lens hood in the direction of the arrow until it locks in place.
- To remove the lens hood, turn it in the opposite direction.

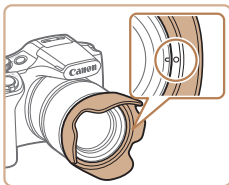

- To attach the lens hood inverted (as shown) when the hood is not used, align the lens hood mark (2) with the camera mark (1), and turn the lens hood in the direction of the arrow until it locks in place.

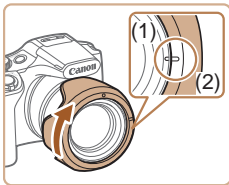

- Vignetting may occur if you use the built-in flash when the lens hood is attached.



- The filter adapter and a lens hood cannot be attached to the camera at the same time.

## Using Lens Filters (Sold Separately)

► Still Images ► Movies

Attaching a lens filter to the camera protects the lens and allows you to shoot with various effects. To attach a lens filter, you will need Filter Adapter FA-DC67A (sold separately).

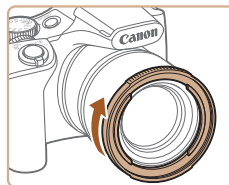

### 1 Attach the filter adapter.

- Make sure the camera is off.
- Align the notches on the camera and the filter adapter and turn the adapter in the direction of the arrow until locked.
- To remove the filter adapter, turn it in the opposite direction.

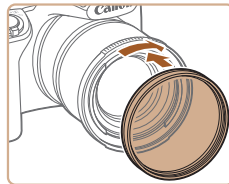

### 2 Attach a filter.

- Turn the filter in the direction of the arrow to attach it to the camera.
- Make sure not to attach the filter too tightly. Doing so could prevent removal of the filter and damage the camera.

Before Use

Basic Guide

Advanced Guide

1 Camera Basics

2 Auto Mode / Hybrid Auto Mode

3 Other Shooting Modes

4 P Mode

5 Tv, Av, and M Mode

6 Playback Mode

7 Wi-Fi Functions

8 Setting Menu

9 Accessories

10 Appendix

Index







- We recommend the use of genuine Canon filters (67 mm dia.).
- When not using auto focus to shoot, set the manual focus option [Safety MF] to [On].
- If you use the built-in flash with the filter adapter attached, portions of the image may appear darker.
- When using the filter adapter, be sure to use only one filter at a time. Attaching multiple filters, or accessories such as a heavy lens, may cause the attachments to fall off and become damaged.
- Do not grip the filter adapter tightly.
- Remove the filter adapter when not using a filter.



- The filter adapter and a lens hood cannot be attached to the camera at the same time.

## Using the Software

The software available for download from the Canon website is introduced below, with instructions for installation and saving images to a computer.

### Software

After downloading the software from the Canon website and installing it, you can do the following things on your computer.

- CameraWindow
  - Import images and change camera settings



- Internet access is required, and any ISP account charges and access fees must be paid separately.

Before Use

Basic Guide

Advanced Guide

**1** Camera Basics

**2** Auto Mode / Hybrid Auto Mode

**3** Other Shooting Modes

**4** P Mode

**5** Tv, Av, and M Mode

**6** Playback Mode

**7** Wi-Fi Functions

**8** Setting Menu

**9** Accessories

**10** Appendix

Index

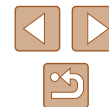

## Computer Connections via a Cable

### Checking Your Computer Environment

The software can be used on the following computers. For detailed system requirements and compatibility information, including support in new operating systems, visit the Canon website.

Operating System*	Windows	Mac OS
	Windows 8/8.1 Windows 7 SP1	Mac OS X 10.9 Mac OS X 10.8

\* When sending images to a computer via Wi-Fi, check the system requirements in "Checking Your Computer Environment" (105).



- Check the Canon website for the latest system requirements, including supported OS versions.

### Installing the Software

For software installation instructions, see "Installing the Software" (105).

## Saving Images to a Computer

Windows 7 and Mac OS X 10.8 are used here for the sake of illustration.

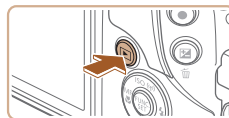
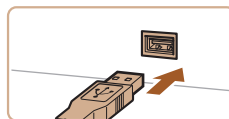
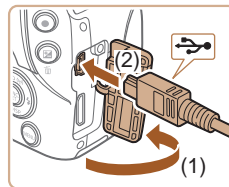

### 1 Connect the camera to the computer.

- With the camera turned off, open the cover (1). With the smaller plug of the USB cable in the orientation shown, insert the plug fully into the camera terminal (2).

- Insert the larger plug of the USB cable in the computer's USB port. For details about USB connections on the computer, refer to the computer user manual.

### 2 Turn the camera on to access CameraWindow.

- Press the [▶] button to turn the camera on.
- Mac OS: CameraWindow is displayed when a connection is established between the camera and computer.
- Windows: Follow the steps introduced below.
- In the screen that displays, click the [ ] link to modify the program.

Before Use

Basic Guide

Advanced Guide

1 Camera Basics

2 Auto Mode / Hybrid Auto Mode

3 Other Shooting Modes

4 P Mode

5 Tv, Av, and M Mode

6 Playback Mode

7 Wi-Fi Functions

8 Setting Menu

9 Accessories

10 Appendix

Index



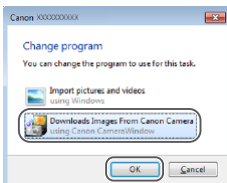

- Choose [Downloads Images From Canon Camera] and then click [OK].



- Double-click [CameraWindow].



### 3 Save the images to the computer.

- Click [Import Images from Camera], and then click [Import Untransferred Images].
- Images are now saved to the Pictures folder on the computer, in separate folders named by date.
- After images are saved, close CameraWindow, press the [▶] button to turn the camera off, and unplug the cable.
- To view the saved images, use the operating system's standard image-viewing software.



- Windows 7: If the screen in step 2 is not displayed, click the [CameraWindow] icon in the taskbar.
- Mac OS: If CameraWindow is not displayed after step 2, click the [CameraWindow] icon in the Dock.
- Although you can save images to a computer simply by connecting your camera to the computer without using the software, the following limitations apply.
  - It may take a few minutes after you connect the camera to the computer until camera images are accessible.
  - Images shot in vertical orientation may be saved in horizontal orientation.
  - Image protection settings may be cleared from images saved to a computer.
  - Some problems may occur when saving images or image information, depending on the operating system version, the software in use, or image file sizes.

## Before Use

## Basic Guide

## Advanced Guide

### 1 Camera Basics

### 2 Auto Mode / Hybrid Auto Mode

### 3 Other Shooting Modes

### 4 P Mode

### 5 Tv, Av, and M Mode

### 6 Playback Mode

### 7 Wi-Fi Functions

### 8 Setting Menu

### 9 Accessories

### 10 Appendix

## Index



## Printing Images

▶ Still Images ▶ Movies

Your shots can easily be printed by connecting the camera to a printer. On the camera, you can specify images to set up batch printing, prepare orders for photo development services, and prepare orders or print images for photobooks.

A Canon SELPHY CP series compact photo printer is used here for the sake of illustration. Screens displayed and available functions vary by printer. Also refer to the printer manual for additional information.

### Easy Print

▶ Still Images ▶ Movies

Easily print your shots by connecting the camera to a PictBridge-compatible printer (sold separately) with the USB cable.

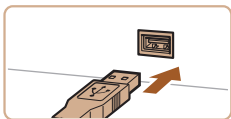
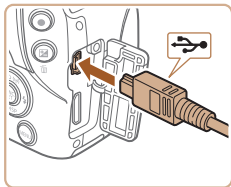

#### 1 Make sure the camera and printer are off.

#### 2 Connect the camera to the printer.

- Open the terminal cover. Holding the smaller cable plug in the orientation shown, insert the plug fully into the camera terminal.
- Connect the larger cable plug to the printer. For other connection details, refer to the printer manual.

#### 3 Turn the printer on.

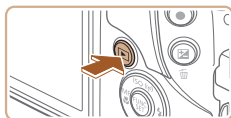

#### 4 Turn the camera on.

- Press the [▶] button to turn the camera on.

#### 5 Choose an image.

- Press the [◀][▶] buttons to choose an image.

#### 6 Access the printing screen.

- Press the [⊕] button, choose [Print], and press the [⊕] button again.

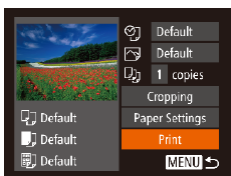
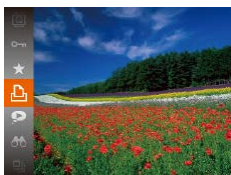

#### 7 Print the image.

- Press the [▲][▼] buttons to choose [Print], and then press the [⊕] button.
- Printing now begins.
- To print other images, repeat the above procedures starting from step 5 after printing is finished.
- When you are finished printing, turn the camera and printer off and disconnect the cable.



- For Canon-brand PictBridge-compatible printers (sold separately), see "Printer" (133).

Before Use

Basic Guide

Advanced Guide

1 Camera Basics

2 Auto Mode / Hybrid Auto Mode

3 Other Shooting Modes

4 P Mode

5 Tv, Av, and M Mode

6 Playback Mode

7 Wi-Fi Functions

8 Setting Menu

9 Accessories

10 Appendix

Index



## Configuring Print Settings

▶ Still Images ▶ Movies

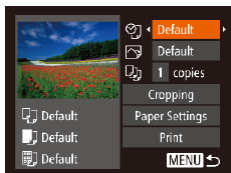

### 1 Access the printing screen.

- Follow steps 1 – 6 in “Easy Print” (📖140) to access this screen.

### 2 Configure the settings.

- Press the [▲][▼] buttons to choose an item, and then press the [◀][▶] buttons to choose an option.

📄	Default	Matches current printer settings.
	Date	Prints images with the date added.
	File No.	Prints images with the file number added.
	Both	Prints images with both the date and file number added.
	Off	–
📄	Default	Matches current printer settings.
	Off	–
	On	Uses information from the time of shooting to print under optimal settings.
	Red-Eye 1	Corrects red-eye.
📄	No. of Copies	Choose the number of copies to print.
Cropping	–	Specify a desired image area to print (📖141).
Paper Settings	–	Specify the paper size, layout, and other details (📖142).

## ▶ Cropping Images before Printing

▶ Still Images ▶ Movies

By cropping images before printing, you can print a desired image area instead of the entire image.

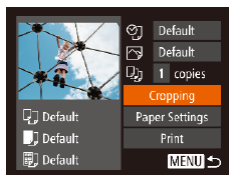

### 1 Choose [Cropping].

- After following step 1 in “Configuring Print Settings” (📖141) to access the printing screen, choose [Cropping] and press the [⏏] button.
- A cropping frame is now displayed, indicating the image area to print.

### 2 Adjust the cropping frame as needed.

- To resize the frame, move the zoom lever.
- To move the frame, press the [▲][▼][◀][▶] buttons.
- To rotate the frame, press the [⏏] button.
- Press the [MENU] button, press the [▲][▼] buttons to choose [OK], and then press the [⏏] button.

### 3 Print the image.

- Follow step 7 in “Easy Print” (📖140) to print.



- Cropping may not be possible at small image sizes, or at some aspect ratios.
- Dates may not be printed correctly if you crop images shot with [Date Stamp 📅] selected.

Before Use

Basic Guide

Advanced Guide

1 Camera Basics

2 Auto Mode / Hybrid Auto Mode

3 Other Shooting Modes

4 P Mode

5 Tv, Av, and M Mode

6 Playback Mode

7 Wi-Fi Functions

8 Setting Menu

9 Accessories

10 Appendix

Index



## Choosing Paper Size and Layout before Printing

► Still Images ► Movies

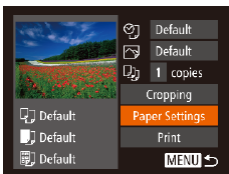

### 1 Choose [Paper Settings].

- After following step 1 in “Configuring Print Settings” (📖141) to access the printing screen, choose [Paper Settings] and press the [OK] button.

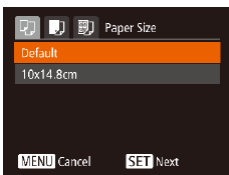

### 2 Choose a paper size.

- Press the [▲][▼] buttons to choose an option, and then press the [OK] button.

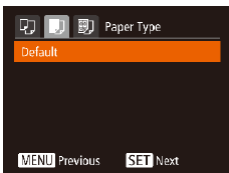

### 3 Choose a type of paper.

- Press the [▲][▼] buttons to choose an option, and then press the [OK] button.

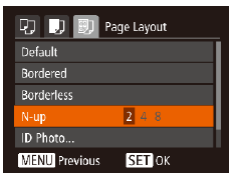

### 4 Choose a layout.

- Press the [▲][▼] buttons to choose an option.
- When choosing [N-up], press the [◀][▶] buttons to specify the number of images per sheet.
- Press the [OK] button.

### 5 Print the image.

## Available Layout Options

Default	Matches current printer settings.
Bordered	Prints with blank space around the image.
Borderless	Borderless, edge-to-edge printing.
N-up	Choose how many images to print per sheet.
ID Photo	Prints images for identification purposes. Only available for images with a resolution of L and an aspect ratio of 4:3.
Fixed Size	Choose the print size. Choose from 3.5 x 5 in., postcard, or wide-format prints.

## Printing ID Photos

► Still Images ► Movies

### 1 Choose [ID Photo].

- Following steps 1 – 4 in “Choosing Paper Size and Layout before Printing” (📖142), choose [ID Photo] and press the [OK] button.

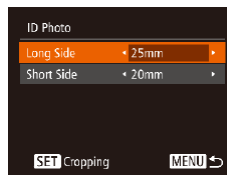

### 2 Choose the long and short side length.

- Press the [▲][▼] buttons to choose an item. Choose the length by pressing the [◀][▶] buttons, and then press the [OK] button.



### 3 Choose the printing area.

- Follow step 2 in “Cropping Images before Printing” (📖141) to choose the printing area.

### 4 Print the image.

Before Use
Basic Guide
Advanced Guide
1 Camera Basics
2 Auto Mode / Hybrid Auto Mode
3 Other Shooting Modes
4 P Mode
5 Tv, Av, and M Mode
6 Playback Mode
7 Wi-Fi Functions
8 Setting Menu
9 Accessories
10 Appendix
Index



## Printing Movie Scenes

▶ Still Images ▶ Movies

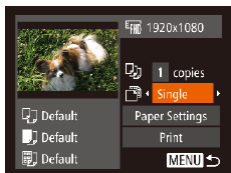

### 1 Access the printing screen.

- Follow steps 1 – 6 in “Easy Print” (140) to choose a movie. This screen is displayed.

### 2 Choose a printing method.

- Press the [▲][▼] buttons to choose [Single], and then press the [Left][Right] buttons to choose the printing method.

### 3 Print the image.

## Movie Printing Options

Single	Prints the current scene as a still image.
Sequence	Prints a series of scenes, a certain interval apart, on a single sheet of paper. You can also print the folder number, file number, and elapsed time for the frame by setting [Caption] to [On].



- To cancel printing in progress, press the [OK] button, choose [OK], and then press the [OK] button again.
- [ID Photo] and [Sequence] cannot be chosen on Canon-brand PictBridge-compatible printers from CP720/CP730 and earlier models.

## Adding Images to the Print List (DPOF)

▶ Still Images ▶ Movies

Batch printing (145) and ordering prints from a photo development service can be set up on the camera. Choose up to 998 images on a memory card and configure relevant settings, such as the number of copies, as follows. The printing information you prepare this way will conform to DPOF (Digital Print Order Format) standards.

## Configuring Print Settings

▶ Still Images ▶ Movies

Specify the printing format, whether to add the date or file number, and other settings as follows. These settings apply to all images in the print list.

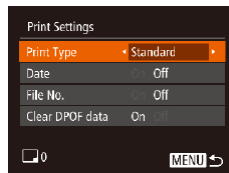

- Press the [MENU] button, and then choose [Print Settings] on the [Print] tab. Choose and configure items as desired (29).

Print Type	Standard	One image is printed per sheet.
	Index	Smaller versions of multiple images are printed per sheet.
	Both	Both standard and index formats are printed.
Date	On	Images are printed with the shooting date.
	Off	–
File No.	On	Images are printed with the file number.
	Off	–
Clear DPOF data	On	All image print list settings are cleared after printing.
	Off	–

Before Use

Basic Guide

Advanced Guide

1 Camera Basics

2 Auto Mode / Hybrid Auto Mode

3 Other Shooting Modes

4 P Mode

5 Tv, Av, and M Mode

6 Playback Mode

7 Wi-Fi Functions

8 Setting Menu

9 Accessories

10 Appendix

Index





- Not all of your DPOF settings may be applied in printing by the printer or photo development service, in some cases.
- [!] may be displayed on the camera to warn you that the memory card has print settings that were configured on another camera. Changing the print settings using this camera may overwrite all previous settings.
- Setting [Date] to [On] may cause some printers to print the date twice.



- Specifying [Index] will prevent you from choosing [On] for both [Date] and [File No.] at the same time.
- Index printing is not available on some Canon-brand PictBridge-compatible printers (sold separately).
- The date is printed in a format matching setting details in [Date/Time] on the [Fn] tab (p.20).

## Setting Up Printing for Individual Images

▶ Still Images ▶ Movies

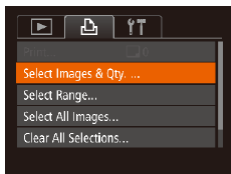

### 1 Choose [Select Images & Qty.].

- Press the [MENU] button, choose [Select Images & Qty.] on the [Fn] tab, and then press the [OK] button.

### 2 Choose an image.

- Press the [◀][▶] buttons to choose an image, and then press the [OK] button.
- You can now specify the number of copies.
- If you specify index printing for the image, it is labeled with a [✓] icon. To cancel index printing for the image, press the [OK] button again. [✓] is no longer displayed.



### 3 Specify the number of prints.

- Press the [▲][▼] buttons to specify the number of prints (up to 99).
- To set up printing for other images and specify the number of prints, repeat steps 2 – 3.
- Printing quantity cannot be specified for index prints. You can only choose which images to print, by following step 2.
- When finished, press the [MENU] button to return to the menu screen.

## Setting Up Printing for a Range of Images

▶ Still Images ▶ Movies

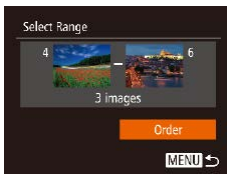

- Following step 1 in “Setting Up Printing for Individual Images” (p.144), choose [Select Range] and press the [OK] button.
- Follow steps 2 – 3 in “Selecting a Range” (p.87) to specify images.
- Press the [▲][▼] buttons to choose [Order], and then press the [OK] button.

## Setting Up Printing for All Images

▶ Still Images ▶ Movies

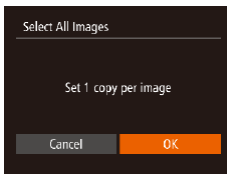

- Following step 1 in “Setting Up Printing for Individual Images” (p.144), choose [Select All Images] and press the [OK] button.
- Press the [◀][▶] buttons to choose [OK], and then press the [OK] button.

Before Use

Basic Guide

Advanced Guide

1 Camera Basics

2 Auto Mode / Hybrid Auto Mode

3 Other Shooting Modes

4 P Mode

5 Tv, Av, and M Mode

6 Playback Mode

7 Wi-Fi Functions

8 Setting Menu

9 Accessories

10 Appendix

Index

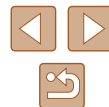



## Clearing All Images from the Print List

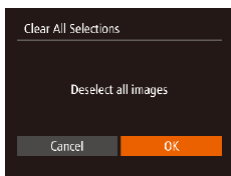

- Following step 1 in “Setting Up Printing for Individual Images” (143 – 144), choose [Clear All Selections] and press the [OK] button.
- Press the [◀][▶] buttons to choose [OK], and then press the [OK] button.

## Printing Images Added to the Print List (DPOF)

► Still Images ► Movies

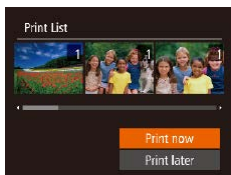

- When images have been added to the print list (143 – 144), this screen is displayed after you connect the camera to a PictBridge-compatible printer. Press the [▲][▼] buttons to choose [Print now], and then simply press the [OK] button to print the images in the print list.
- Any DPOF print job that you temporarily stop will be resumed from the next image.

## Adding Images to a Photobook

► Still Images ► Movies

Photobooks can be set up on the camera by choosing up to 998 images on a memory card and importing them into the software on your computer, where they are stored in their own folder. This is convenient when ordering printed photobooks online or printing photobooks with your own printer.

## Choosing a Selection Method

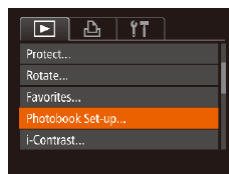

- Press the [MENU] button, choose [Photobook Set-up] on the [▶] tab, and then choose how you will select images.



- [!] may be displayed on the camera to warn you that the memory card has print settings that were configured on another camera. Changing the print settings using this camera may overwrite all previous settings.

Before Use

Basic Guide

Advanced Guide

1 Camera Basics

2 Auto Mode / Hybrid Auto Mode

3 Other Shooting Modes

4 P Mode

5 Tv, Av, and M Mode

6 Playback Mode

7 Wi-Fi Functions

8 Setting Menu

9 Accessories

10 Appendix

Index



## Adding Images Individually

▶ Still Images ▶ Movies

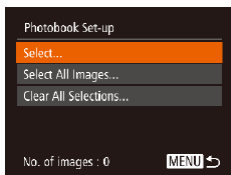

### 1 Choose [Select].

- Following the procedure in “Choosing a Selection Method” (145), choose [Select] and press the [OK] button.



### 2 Choose an image.

- Press the [◀][▶] buttons to choose an image, and then press the [OK] button.
- [✓] is displayed.
- To remove the image from the photobook, press the [OK] button again. [✓] is no longer displayed.
- Repeat this process to specify other images.
- When finished, press the [MENU] button to return to the menu screen.

## Adding All Images to a Photobook

▶ Still Images ▶ Movies

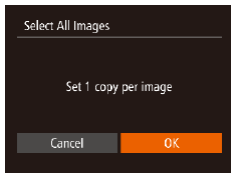

- Following the procedure in “Choosing a Selection Method” (145), choose [Select All Images] and press the [OK] button.
- Press the [◀][▶] buttons to choose [OK], and then press the [OK] button.

## Removing All Images from a Photobook

▶ Still Images ▶ Movies

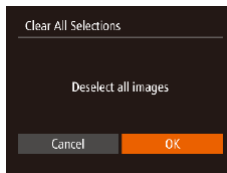

- Following the procedure in “Choosing a Selection Method” (145), choose [Clear All Selections] and press the [OK] button.
- Press the [◀][▶] buttons to choose [OK], and then press the [OK] button.

Before Use

Basic Guide

Advanced Guide

1 Camera Basics

2 Auto Mode / Hybrid Auto Mode

3 Other Shooting Modes

4 P Mode

5 Tv, Av, and M Mode

6 Playback Mode

7 Wi-Fi Functions

8 Setting Menu

9 Accessories

10 Appendix

Index



# 10

## Appendix

Helpful information when using the camera

### Troubleshooting

If you think there is a problem with the camera, first check the following. If the items below do not solve your problem, contact a Canon Customer Support Help Desk.

#### Power

Nothing happens when the power button is pressed.

- Confirm that the battery pack is charged (18).
- Confirm that the battery pack is inserted facing the correct way (19).
- Confirm that the memory card/battery cover is fully closed (19).
- Dirty battery terminals reduce battery performance. Try cleaning the terminals with a cotton swab and reinserting the battery pack a few times.

The battery pack runs out of power quickly.

- Battery performance decreases at low temperatures. Try warming the battery pack a little by putting it in your pocket, for example, ensuring that the terminals do not touch any metal objects.
- Dirty battery terminals reduce battery performance. Try cleaning the terminals with a cotton swab and reinserting the battery pack a few times.
- If these measures do not help and the battery pack still runs out of power soon after charging, it has reached the end of its life. Purchase a new battery pack.

The lens is not retracted.

- Do not open the memory card/battery cover while the camera is on. Close the cover, turn the camera on, and then turn it off again (19).

The battery pack is swollen.

- Battery swelling is normal and does not pose any safety concerns. However, if battery swelling prevents the battery pack from fitting in the camera, contact a Canon Customer Support Help Desk.

#### Display on a TV

Camera images look distorted or not displayed on a TV (134).

Before Use

Basic Guide

Advanced Guide

1 Camera Basics

2 Auto Mode /  
Hybrid Auto Mode

3 Other Shooting Modes

4 P Mode

5 Tv, Av, and M Mode

6 Playback Mode

7 Wi-Fi Functions

8 Setting Menu

9 Accessories

10 Appendix

Index



## Shooting

Cannot shoot.

- In Playback mode (📖77), press the shutter button halfway (📖26).

Strange display on the screen under low light (📖27).

Strange display on the screen when shooting.

- Note that the following display problems are not recorded in still images but are recorded in movies.
  - The screen may flicker and horizontal banding may appear under fluorescent or LED lighting.

No date stamp is added to images.

- Configure the [Date Stamp] (📖) setting (📖20). Note that date stamps are not added to images automatically, merely because you have configured the [Date/Time] setting (📖43).
- Date stamps are not added in shooting modes (📖157) in which this setting cannot be configured (📖43).

⚡ flashes on the screen when the shutter button is pressed, and shooting is not possible (📖35).

📷 is displayed when the shutter button is pressed halfway (📖35).

- Set [IS Mode] to [Continuous] (📖73).
- Raise the flash and set the flash mode to ⚡ (📖71).
- Increase the ISO speed (📖63).
- Mount the camera on a tripod or take other measures to keep it still. Additionally, you should set [IS Mode] to [Off] when using a tripod or other means to secure the camera (📖73).

Shots are out of focus.

- Press the shutter button halfway to focus on subjects before pressing it all the way down to shoot (📖26).
- Make sure subjects are within focusing range (📖165).
- Set [AF-assist Beam] to [On] (📖48).
- Confirm that unneeded functions such as macro are deactivated.
- Try shooting with focus lock or AF lock (📖70).

No AF frames are displayed and the camera does not focus when the shutter button is pressed halfway.

- To have AF frames displayed and the camera focus correctly, try composing the shot with higher-contrast subject areas centered before you press the shutter button halfway. Otherwise, try pressing the shutter button halfway repeatedly.

Subjects in shots look too dark.

- Raise the flash and set the flash mode to ⚡ (📖71).
- Adjust brightness by using exposure compensation (📖62).
- Adjust contrast by using i-Contrast (📖63, 📖94).
- Use AE lock or spot metering (📖62, 📖62).

Subjects look too bright, highlights are washed-out.

- Lower the flash and set the flash mode to ☹️ (📖32).
- Adjust brightness by using exposure compensation (📖62).
- Use AE lock or spot metering (📖62, 📖62).
- Reduce the lighting on subjects.

Shots look too dark despite the flash firing (📖35).

- Shoot within flash range (📖164).
- Adjust brightness by using flash exposure compensation or changing the flash output level (📖72, 📖76).
- Increase the ISO speed (📖63).

Subjects in flash shots look too bright, highlights are washed-out.

- Shoot within flash range (📖164).
- Lower the flash and set the flash mode to ☹️ (📖32).
- Adjust brightness by using flash exposure compensation or changing the flash output level (📖72, 📖76).

White spots appear in flash shots.

- This is caused by light from the flash reflecting off dust or airborne particles.

Shots look grainy.

- Lower the ISO speed (📖63).

Subjects are affected by red-eye (📖46).

- Set [Red-Eye Lamp] to [On] (📖49) to activate the red-eye reduction lamp (📖4) in flash shots. Note that while the red-eye reduction lamp is on (for about one second), it is not possible to shoot, because the lamp is counteracting red-eye. For best results, have subjects look at the red-eye reduction lamp. Also try increasing the lighting in indoor scenes and shooting at closer range.
- Edit images using red-eye correction (📖94).

Recording to the memory card takes too long, or continuous shooting is slower.

- Use the camera to perform low-level formatting of the memory card (📖128).

Shooting settings or FUNC. menu settings are not available.

- Available setting items vary by shooting mode. Refer to "Functions Available in Each Shooting Mode", "FUNC. Menu", and "Shooting Tab" (📖154 – 📖157).

Before Use

Basic Guide

Advanced Guide

1 Camera Basics

2 Auto Mode / Hybrid Auto Mode

3 Other Shooting Modes

4 P Mode

5 Tv, Av, and M Mode

6 Playback Mode

7 Wi-Fi Functions

8 Setting Menu

9 Accessories

10 Appendix

Index

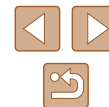

## Shooting Movies

The elapsed time shown is incorrect, or recording is interrupted.

- Use the camera to format the memory card, or switch to a card that supports high-speed recording. Note that even if the elapsed time display is incorrect, the length of movies on the memory card corresponds to the actual recording time (📖127, 📖164).

**[!]** is displayed and shooting stops automatically.

- The camera's internal memory buffer filled up as the camera could not record to the memory card quickly enough. Try one of the following measures.
  - Use the camera to perform low-level formatting of the memory card (📖128).
  - Lower the image quality (📖46).
  - Switch to a memory card that supports high-speed recording (📖164).

Zooming is not possible.

- Zooming is not possible when shooting movies in **[📷]** mode (📖55).

Subjects look distorted.

- Subjects that pass in front of the camera quickly may look distorted. This is not a malfunction.

## Playback

Playback is not possible.

- Image or movie playback may not be possible if a computer is used to rename files or alter the folder structure.

Playback stops, or audio skips.

- Switch to a memory card that you have performed low-level formatting on with the camera (📖128).
- There may be brief interruptions when playing movies copied to memory cards that have slow read speeds.
- When movies are played on a computer, frames may be dropped and audio may skip if computer performance is inadequate.

Sound is not played during movies.

- Adjust the volume (📖124) if you have activated **[Mute]** (📖124) or the sound in the movie is faint.
- No sound is played for movies shot in **[📷]** mode (📖55) because audio is not recorded in this mode.

## Memory Card

The memory card is not recognized.

- Restart the camera, with the memory card in it (📖25).

## Computer

Cannot transfer images to a computer.

- When attempting to transfer images to the computer via a cable, try reducing the transfer speed as follows.
  - Press the **[▶]** button to enter Playback mode. Hold the **[MENU]** button down as you press the **[▲]** and **[📷]** buttons at the same time. On the next screen, press the **[◀|▶]** buttons to choose **[B]**, and then press the **[📷]** button.

## Wi-Fi

Cannot access the Wi-Fi menu by pressing the **[▲]** button.

- The Wi-Fi menu is not available in Shooting mode. Switch to Playback mode and try again.
- In Playback mode, the Wi-Fi menu cannot be accessed during detailed information display, magnified display, or index display. Switch to single-image display and a viewing mode other than detailed information display. Similarly, the Wi-Fi menu cannot be accessed during group playback or filtered image display according to specified conditions. Cancel group or filtered image playback.
- The Wi-Fi menu cannot be accessed while the camera is connected to a printer, computer, or TV via a cable. Disconnect the cable.

Cannot add a device/destination.

- A total of 20 items of connection information can be added to the camera. Erase unneeded connection information from the camera first, and then add new devices/destinations (📖122).
- Use a computer or smartphone to register Web services (📖111).
- To add a smartphone, first install the dedicated application CameraWindow on your smartphone (📖98).
- To add a computer, first install the software CameraWindow on your computer. Also check your computer and Wi-Fi environment and settings (📖105, 📖107).
- Do not use the camera near sources of Wi-Fi signal interference, such as microwave ovens, Bluetooth devices, or other equipment operating on the 2.4 GHz band.
- Bring the camera closer to the other device you are trying to connect to (such as the access point), and make sure there are no objects between the devices.

Before Use

Basic Guide

Advanced Guide

**1** Camera Basics

**2** Auto Mode /  
Hybrid Auto Mode

**3** Other Shooting Modes

**4** P Mode

**5** Tv, Av, and M Mode

**6** Playback Mode

**7** Wi-Fi Functions

**8** Setting Menu

**9** Accessories

**10** Appendix

Index



Cannot connect to the access point.

- Confirm that the access point channel is set to a channel supported by the camera (📖163). Note that instead of auto channel assignment, it is advisable to specify a supported channel manually.

Cannot send images.

- The destination device has insufficient storage space. Increase the storage space on the destination device and resend the images.
- The write-protect tab of the memory card in the destination camera is set to the locked position. Slide the write-protect tab to the unlocked position.
- Images are not sent to CANON iMAGE GATEWAY or other Web services if you move or rename image files or folders on the computer that received images sent using Image Sync via an access point (📖118). Before moving or renaming these image files or folders on the computer, make sure the images have already been sent to CANON iMAGE GATEWAY or other Web services.

Cannot resize images for sending.

- Images cannot be resized to be bigger than the resolution setting of their original size.
- Movies cannot be resized.

Images take a long time to send./The wireless connection is disrupted.

- Multiple images may take a long time to send. Try resizing the image to [M2] or [S] to reduce sending time (📖117).
- Movies may take a long time to send.
- Do not use the camera near sources of Wi-Fi signal interference, such as microwave ovens, Bluetooth devices, or other equipment operating on the 2.4 GHz band. Note that images may take a long time to send even when [Wi-Fi] is displayed.
- Bring the camera closer to the other device you are trying to connect to (such as the access point), and make sure there are no objects between the devices.

Want to erase Wi-Fi connection information before disposing of the camera or giving it to someone else.

- Reset the Wi-Fi settings (📖123).

## On-Screen Messages

If an error message is displayed, respond as follows.

### Capture or Playback

No memory card

- The memory card may be inserted facing the wrong way. Reinsert the memory card facing the correct way (📖19).

Memory card locked

- The write-protect tab of the memory card is set to the locked position. Switch the write-protect tab to the unlocked position (📖19).

Cannot record!

- Shooting was attempted without a memory card in the camera. To shoot, insert a memory card facing the correct way (📖19).

Memory card error (📖128)

- If the same error message is displayed even after you have formatted a supported memory card (📖2) and have inserted it facing the correct way (📖19), contact a Canon Customer Support Help Desk.

Insufficient space on card

- There is not enough free space on the memory card to shoot (📖32, 📖51, 📖61, 📖74) or edit images (📖92). Either erase unneeded images (📖88) or insert a memory card with enough free space (📖19).

Charge the battery (📖18)

No Image.

- The memory card does not contain any images that can be displayed.

Protected! (📖85)

Unidentified Image/Incompatible JPEG/Image too large./Cannot play back MOV

- Unsupported or corrupt images cannot be displayed.
- It may not be possible to display images that were edited or renamed on a computer, or images shot with another camera.

Before Use

Basic Guide

Advanced Guide

1 Camera Basics

2 Auto Mode / Hybrid Auto Mode

3 Other Shooting Modes

4 P Mode

5 Tv, Av, and M Mode

6 Playback Mode

7 Wi-Fi Functions

8 Setting Menu

9 Accessories

10 Appendix

Index



Cannot magnify/Cannot play back this content in Smart Shuffle/Cannot rotate/Cannot modify image/Cannot modify/Cannot assign to category/Unselectable image.

- The following functions may be unavailable for images that were renamed or already edited on a computer, or images shot with another camera. Note that starred (\*) functions are not available for movies. Magnify\* (📄83), Smart Shuffle\* (📄85), Rotate\* (📄90), Favorites (📄91), Edit\* (📄92), Print List\* (📄143), and Photobook Set-up\* (📄145).

Invalid selection range

- When specifying a range for image selection (📄87, 📄89, 📄144), you attempted to choose an initial image that was after the final image, or vice-versa.

Exceeded selection limit

- More than 998 images were selected for Print List (📄143) or Photobook Set-up (📄145). Choose 998 images or less.
- Print List (📄143) or Photobook Set-up (📄145) settings could not be saved correctly. Reduce the number of selected images and try again.
- You attempted to choose more than 500 images in Protect (📄85), Erase (📄88), Favorites (📄91), Print List (📄143), or Photobook Set-up (📄145).

Naming error!

- The folder could not be created or images could not be recorded, because the highest supported folder number (999) for storing images on the card has been reached and the highest supported image number (9999) for images in folders has been reached. On the **[📄]** tab, change [File Numbering] to [Auto Reset] (📄128), or format the memory card (📄127).

Lens Error

- This error may occur if the lens is held while it is moving, or when the camera is used in dusty or sandy locations.
- Frequent display of this error message may indicate camera damage. In this case, contact a Canon Customer Support Help Desk.

A camera error was detected (*error number*)

- If this error message is displayed immediately after a shot, the image may not have been saved. Switch to Playback mode to check for the image.
- Frequent display of this error message may indicate camera damage. In this case, write down the error number (*Exx*) and contact a Canon Customer Support Help Desk.

File Error

- Correct printing (📄140) may not be possible for photos from other cameras or images that have been altered using computer software, even if the camera is connected to the printer.

Print error

- Check the paper size setting (📄142). If this error message is displayed when the setting is correct, restart the printer and complete the setting on the camera again.

Ink absorber full

- Contact a Canon Customer Support Help Desk to request assistance with ink absorber replacement.

## Wi-Fi

Connection failed

- No access points were recognized. Check the access point settings (📄107).
- A device could not be found. Turn the camera off and on again, and retry the connection.
- Check the device you want to connect to and make sure it is ready for connection.

Cannot determine access point

- The WPS buttons on numerous access points were pressed simultaneously. Try reconnecting again.

No access points found

- Check to make sure that the access point is turned on.
- When connecting to an access point manually, make sure that you entered the correct SSID.

Incorrect password/Incorrect Wi-Fi security settings

- Check the access point security settings (📄107).

IP address conflict

- Reset the IP address so that it does not conflict with another.

Disconnected/Receiving failed/Sending failed

- You may be in an environment where Wi-Fi signals are obstructed.
- Avoid using the camera's Wi-Fi function around microwave ovens, Bluetooth devices, and other devices that operate on the 2.4 GHz band.
- Bring the camera closer to the other device you are trying to connect to (such as the access point), and make sure there are no objects between the devices.
- Check the connected device to make sure it is not experiencing errors.

Before Use

Basic Guide

Advanced Guide

**1** Camera Basics

**2** Auto Mode / Hybrid Auto Mode

**3** Other Shooting Modes

**4** P Mode

**5** Tv, Av, and M Mode

**6** Playback Mode

**7** Wi-Fi Functions

**8** Setting Menu

**9** Accessories

**10** Appendix

Index

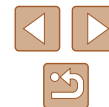

### Sending failed

#### Memory card error

- If the same error message is displayed even when you have inserted a formatted memory card facing the correct way, contact a Canon Customer Support Help Desk.

### Receiving failed

#### Insufficient space on card

- There is not enough free space on the memory card in the target camera to receive images. Erase images to create space on the memory card, or insert a memory card with sufficient space.

### Receiving failed

#### Memory card locked

- The write-protect tab of the memory card in the camera to receive the images is set to the locked position. Slide the write-protect tab to the unlocked position.

### Receiving failed

#### Naming error!

- When the highest folder number (999), and the highest image number (9999) have been reached on the receiving camera, images cannot be received.

### Insufficient space on server

- Delete unnecessary images uploaded to CANON iMAGE GATEWAY to create space.
- Save the images sent via Image Sync (📖118) to your computer.

### Check network settings

- Check to make sure your computer can connect to the Internet with the current network settings.

## On-Screen Information

### Shooting (Information Display)

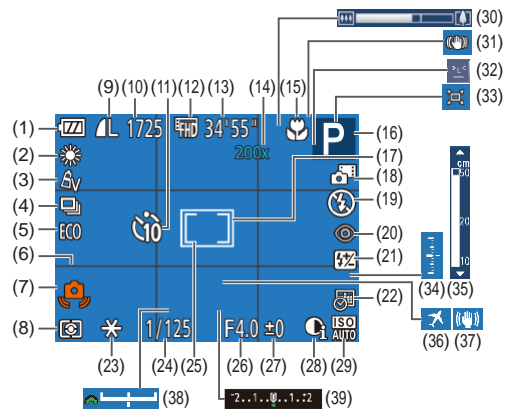

- |  |  |
|--|--|
| (1) Battery level (📖153)                               | (11) Self-timer (📖42)  |
| (2) White balance (📖64)                                | (12) Movie quality (📖46)   |
| (3) My Colors (📖64)                                    | (13) Remaining time (📖164)   |
| (4) Drive mode (📖44)                                   | (14) Digital zoom magnification (📖38),<br>Digital tele-converter (📖67) |
| (5) Eco mode (📖126)                                    | (15) Focusing range (📖66,<br>📖66), AF lock (📖70)                       |
| (6) Grid lines (📖47)                                   | (16) Shooting mode (📖154), Scene<br>icon (📖36)                         |
| (7) Camera shake warning (📖35)                         | (17) AF frame (📖68)  |
| (8) Metering method (📖62)                              | (18) Hybrid Auto mode (📖34)  |
| (9) Still image compression (📖73),<br>Resolution (📖45) | (19) Flash mode (📖71)  |
| (10) Recordable shots (📖164)*                          |  |

### Before Use

### Basic Guide

### Advanced Guide

## 1 Camera Basics

## 2 Auto Mode / Hybrid Auto Mode

## 3 Other Shooting Modes

## 4 P Mode

## 5 Tv, Av, and M Mode

## 6 Playback Mode

## 7 Wi-Fi Functions

## 8 Setting Menu

## 9 Accessories

## 10 Appendix

### Index





- (20) Red-eye correction (📖46)
- (21) Flash exposure compensation / Flash output level (📖72, 📖76)
- (22) Date stamp (📖43)
- (23) AE lock (📖62), FE lock (📖72)
- (24) Shutter speed (📖74, 📖75)
- (25) Spot AE point frame (📖62)
- (26) Aperture value (📖75, 📖75)
- (27) Exposure compensation level (📖62)
- (28) i-Contrast (📖63)
- (29) ISO speed (📖63)
- (30) Zoom bar (📖32)
- (31) IS mode icon (📖37)
- (32) Blink detection (📖48)
- (33) ƒ, Auto (📖40)
- (34) Exposure level (📖75)
- (35) MF indicator (📖66)
- (36) Time zone (📖125)
- (37) Image stabilization (📖73)
- (38) Exposure shift bar (📖73)
- (39) Exposure compensation bar (📖62)

\* In [📷] mode, indicates the number of shots available.

## Battery Level

An on-screen icon or message indicates the battery charge level.

Display	Details
	Sufficient charge
	Slightly depleted, but sufficient
	Nearly depleted—charge the battery pack soon
[Charge the battery]	Depleted—charge the battery pack immediately

## Playback (Detailed Information Display)

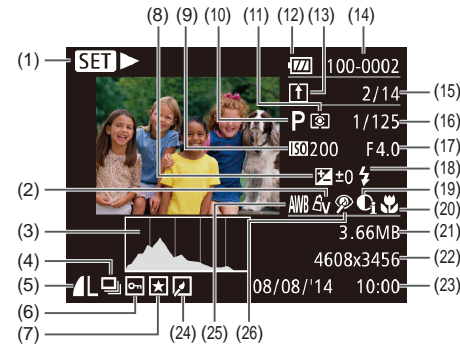

- (1) Movies (📖32, 📖77)
- (2) My Colors (📖64, 📖93)
- (3) Histogram (📖79)
- (4) Group playback (📖82)
- (5) Compression (image quality) (📖73) / Resolution (📖45), MP4 (movies)
- (6) Protection (📖85)
- (7) Favorites (📖91)
- (8) Exposure compensation level (📖62), Exposure shift level (📖60)
- (9) ISO speed (📖63), Playback speed (📖56)
- (10) Shooting mode (📖154)
- (11) Metering method (📖62)
- (12) Battery level (📖153)
- (13) Image Sync (📖118)
- (14) Folder number - File number (📖128)
- (15) Current image no. / Total no. of images
- (16) Shutter speed (still images) (📖74, 📖75), Image quality / Frame rate (movies) (📖46)
- (17) Aperture value (📖75)
- (18) Flash (📖71), Flash exposure compensation (📖72)
- (19) i-Contrast (📖63, 📖94)
- (20) Focusing range (📖66)
- (21) File size
- (22) Still images: Resolution (📖164) Movies: Playback time (📖164)
- (23) Shooting date/time (📖20)
- (24) Image editing (📖92)

### Before Use

### Basic Guide

### Advanced Guide

#### 1 Camera Basics

#### 2 Auto Mode / Hybrid Auto Mode

#### 3 Other Shooting Modes

#### 4 P Mode

#### 5 Tv, Av, and M Mode

#### 6 Playback Mode

#### 7 Wi-Fi Functions

#### 8 Setting Menu

#### 9 Accessories

#### 10 Appendix

### Index

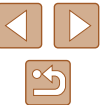





## FUNC. Menu

### Metering Method (📖62)



M / Av / Tv / P / LIVE / / AUTO / / / / / / /



M / Av / Tv / P / LIVE / / AUTO / / / / / / /

### My Colors (📖64)



M / Av / Tv / P / LIVE / / AUTO / / / / / / /

Av / AN / \*1 / \*1 / Ap / AL / AD / AB / AG / AR / AC\*2

M / Av / Tv / P / LIVE / / AUTO / / / / / / /

### White Balance (📖64)



M / Av / Tv / P / LIVE / / AUTO / / / / / / /



M / Av / Tv / P / LIVE / / AUTO / / / / / / /

### Self-Timer (📖42)



M / Av / Tv / P / LIVE / / AUTO / / / / / / /



M / Av / Tv / P / LIVE / / AUTO / / / / / / /

### Self-Timer Settings (📖43)

Delay\*3

M / Av / Tv / P / LIVE / / AUTO / / / / / / /

Shots\*4

M / Av / Tv / P / LIVE / / AUTO / / / / / / /

### Drive Mode (📖44)



M / Av / Tv / P / LIVE / / AUTO / / / / / / /



M / Av / Tv / P / LIVE / / AUTO / / / / / / /

### Still Image Aspect Ratio (📖45)

16:9

M / Av / Tv / P / LIVE / / AUTO / / / / / / /

3:2 / 1:1

M / Av / Tv / P / LIVE / / AUTO / / / / / / /

4:3

M / Av / Tv / P / LIVE / / AUTO / / / / / / /

Before Use

Basic Guide

Advanced Guide

**1** Camera Basics

**2** Auto Mode / Hybrid Auto Mode

**3** Other Shooting Modes

**4** P Mode

**5** Tv, Av, and M Mode

**6** Playback Mode

**7** Wi-Fi Functions

**8** Setting Menu

**9** Accessories

**10** Appendix

Index







### Red-Eye Corr.

On



Off



### Red-Eye Lamp

On/Off



### Safety FE

On



Off



### i-Contrast (63)

Auto



Off



### Safety Shift (75)

On



Off



### Review image after shooting (49)

Display Time

Off



Quick



2 sec./4 sec./8 sec./Hold



Display Info

Off



Detailed



### Blink Detection (48)

On



Off



### Before Use

### Basic Guide

### Advanced Guide

### 1 Camera Basics

### 2 Auto Mode / Hybrid Auto Mode

### 3 Other Shooting Modes

### 4 P Mode

### 5 Tv, Av, and M Mode

### 6 Playback Mode

### 7 Wi-Fi Functions

### 8 Setting Menu

### 9 Accessories

### 10 Appendix

### Index







## Set Up Tab

Item	Ref. Page
Mute	📖124
Volume	📖124
Hints & Tips	📖125
Date/Time	📖20
Time Zone	📖125
Lens Retraction	📖126
Eco Mode	📖126
Power Saving	📖26, 📖126
LCD Brightness	📖127
Start-up Image	📖127
Format	📖127, 📖128
File Numbering	📖128
Create Folder	📖129
Units	📖129
Video System	📖134
Wi-Fi Settings	📖97
Mobile Device Connect Button	📖101
Certification Logo Display	📖129
Language 🗣️	📖21
Reset All	📖130

## Playback Tab

Item	Ref. Page
List/Play Digest Movies	📖80
Slideshow	📖84
Erase	📖88
Protect	📖85
Rotate	📖90
Favorites	📖91
Photobook Set-up	📖145
i-Contrast	📖94
Red-Eye Correction	📖94
Cropping	📖92
Resize	📖92
My Colors	📖93
Transition	📖77
Scroll Display	📖77
Group Images	📖82
Auto Rotate	📖90
Resume	📖77

Before Use

Basic Guide

Advanced Guide

**1** Camera Basics

**2** Auto Mode / Hybrid Auto Mode

**3** Other Shooting Modes

**4** P Mode

**5** Tv, Av, and M Mode

**6** Playback Mode

**7** Wi-Fi Functions

**8** Setting Menu

**9** Accessories

**10** Appendix

Index



## Print Tab

Item	Ref. Page
Print	–
Select Images & Qty.	144
Select Range	144
Select All Images	144
Clear All Selections	145
Print Settings	143

## Playback Mode FUNC. Menu

Item	Ref. Page
Rotate	90
Protect	85
Favorites	91
Print	140
Group Playback	82
Play Movie	77
List/Play Digest Movies	80
Smart Shuffle	85
Image Search	81
Slideshow	84

## Handling Precautions

- The camera is a high-precision electronic device. Avoid dropping it or subjecting it to strong impact.
- Never bring the camera near magnets, motors, or other devices that generate strong electromagnetic fields, which may cause malfunction or erase image data.
- If water droplets or dirt adheres to the camera or screen, wipe with a dry soft cloth, such as an eyeglass cloth. Do not rub hard or apply force.
- Never use cleaners containing organic solvents to clean the camera or screen.
- Use a blower brush to remove dust from the lens. If cleaning is difficult, contact a Canon Customer Support Help Desk.
- To prevent condensation from forming on the camera after sudden temperature changes (when the camera is transferred from cold to warm environments), put the camera in an airtight, resealable plastic bag and let it gradually adjust to the temperature before removing it from the bag.
- If condensation does form on the camera, stop using it immediately. Continuing to use the camera in this state may damage it. Remove the battery pack and memory card, and wait until the moisture has evaporated before resuming use.
- Before long-term battery storage, use up the battery pack's remaining charge, remove it from the camera, and store it in a plastic bag or similar container. Storing a partially charged battery pack over extended periods (about a year) may shorten its life or affect performance.

Before Use

Basic Guide

Advanced Guide

**1** Camera Basics

**2** Auto Mode / Hybrid Auto Mode

**3** Other Shooting Modes

**4** P Mode

**5** Tv, Av, and M Mode

**6** Playback Mode

**7** Wi-Fi Functions

**8** Setting Menu

**9** Accessories

**10** Appendix

Index

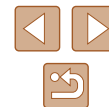

# Specifications

## Camera Specifications

Camera Effective Pixels (Max.)	Approx. 16 million pixels
Lens Focal Length	50x zoom: 4.3 (W) – 215.0 (T) mm (35mm film equivalent: 24 (W) – 1200 (T) mm)
LCD Monitor	3.0-type color TFT LCD Effective Pixels: Approx. 461,000 dots
File Format	Design rule for Camera File system, DPOF (version 1.1) compliant
Data Type	Still Images: Exif 2.3 (JPEG) Movies: MP4 (Video: MPEG-4 AVC/H.264; Audio: MPEG-4 AAC-LC (stereo))
Interface	Hi-speed USB HDMI output Analog audio output (stereo) Analog video output (NTSC/PAL)
Power Source	Battery Pack NB-6LH AC Adapter Kit ACK-DC40
Dimensions (Based on CIPA Guidelines)	120.0 x 81.7 x 91.9 mm (4.72 x 3.22 x 3.62 in.)
Weight (Based on CIPA Guidelines)	Approx. 442 g (approx. 15.59 oz.; including the battery pack and memory card) Approx. 418 g (approx. 14.74 oz.; camera body only)

## Wi-Fi

Standards	IEEE 802.11b/g/n* * 2.4 GHz band only
Transmission Methods	OFDM modulation (IEEE 802.11g/n) DSSS modulation (IEEE 802.11b)
Communication Modes	Infrastructure mode*1, Ad hoc mode*2 *1 Supports Wi-Fi Protected Setup *2 Wi-Fi CERTIFIED IBSS
Supported Channels	1 – 11 (PC2200/PC2199) or 1 – 13 (PC2157) Model numbers indicated in parentheses
Security	WEP, WPA-PSK (AES/TKIP), WPA2-PSK (AES/TKIP)

## Digital Zoom Focal Length (35mm film equivalent)

Digital Zoom [Standard]	24 – 4800 mm (Represents the combined focal length of optical and digital zoom.)
Digital Tele-Converter 1.6x	38.4 – 1920.0 mm
Digital Tele-Converter 2.0x	48.0 – 2400.0 mm

## Number of Shots/Recording Time, Playback Time

Number of Shots	Approx. 210
Number of Shots (Eco Mode On)	Approx. 290
Movie Recording Time*1	Approx. 45 minutes
Movie Recording Time (Continuous Shooting*2)	Approx. 1 hour, 20 minutes
Playback Time	Approx. 5 hours

\*1 Time under default camera settings, when normal operations are performed, such as shooting, pausing, turning the camera on and off, and zooming.

\*2 Time available when shooting the maximum movie length (until recording stops automatically) repeatedly.

Before Use

Basic Guide

Advanced Guide

**1** Camera Basics

**2** Auto Mode / Hybrid Auto Mode

**3** Other Shooting Modes

**4** P Mode

**5** Tv, Av, and M Mode

**6** Playback Mode

**7** Wi-Fi Functions

**8** Setting Menu

**9** Accessories









**10** Appendix

Index





- The number of shots that can be taken is based on measurement guidelines of the Camera & Imaging Products Association (CIPA).
- Under some shooting conditions, the number of shots and recording time may be less than mentioned above.
- Number of shots/time with a fully charged battery pack.



### Number of Shots per Memory Card

Recording Pixels	Compression Ratio	Number of Shots per Memory Card (Approx. shots)	
		8 GB	32 GB
<b>L</b> (Large) 16M/4608x3456		1058	4272
		1705	6883
<b>M1</b> (Medium 1) 8M/3264x2448		1996	8059
		3069	12391
<b>M2</b> (Medium 2) 3M/2048x1536		4723	19064
		8469	34184
<b>S</b> (Small) 0.3M/640x480		27291	110150
		40937	165225



- The values in the table are based on Canon measurement conditions and may change depending on the subject, memory card and camera settings.

### Recording Time per Memory Card

Image Quality	Recording Time per Memory Card	
	8 GB	32 GB
	34 min. 38 sec.	2 hr. 19 min. 58 sec.
	2 hr. 00 min. 15 sec.	8 hr. 05 min. 48 sec.
	4 hr. 15 min. 32 sec.	17 hr. 12 min. 20 sec.

- The values in the table are based on Canon measurement conditions and may change depending on the subject, memory card and camera settings.
- Recording will automatically stop when the clip file size reaches 4 GB, or when the recording time reaches approximately 29 minutes and 59 seconds when shooting in  or , or approximately 1 hour when shooting in .
- Recording may stop even if the maximum clip length has not been reached on some memory cards. SD Speed Class 4 or higher memory cards are recommended.

### Flash Range

Maximum wide angle (  )	50 cm – 5.5 m (1.6 – 18 ft.)
Maximum telephoto (  )	1.3 – 3.0 m (4.3 – 9.8 ft.)

Before Use

Basic Guide

Advanced Guide

**1** Camera Basics

**2** Auto Mode / Hybrid Auto Mode

**3** Other Shooting Modes

**4** P Mode

**5** Tv, Av, and M Mode

**6** Playback Mode

**7** Wi-Fi Functions

**8** Setting Menu



**9** Accessories

**10** Appendix

Index



## Shooting Range

Shooting Mode	Focusing Range	Maximum Wide Angle (W)	Maximum Telephoto (T)
<b>AUTO</b>	–	0 cm (0.0 in.) – infinity	1.3 m (4.3 ft.) – infinity
Other modes		5 cm (2.0 in.) – infinity	1.3 m (4.3 ft.) – infinity
		0 – 50 cm (0.0 in. – 1.6 ft.)	–
	<b>MF*</b>	0 cm (0.0 in.) – infinity	1.3 m (4.3 ft.) – infinity

\* Not available in some shooting modes.

## Continuous Shooting Speed

Shooting Mode	Speed
<b>AUTO P</b>	Approx. 1.6 shots/sec.
	Approx. 10 shots/sec.

## Shutter Speed

[ <b>AUTO</b> ] mode, automatically set range	1 – 1/2000 sec.
Available values in [ <b>TV</b> ] mode (sec.)	15, 13, 10, 8, 6, 5, 4, 3.2, 2.5, 2, 1.6, 1.3, 1, 0.8, 0.6, 0.5, 0.4, 0.3, 1/4, 1/5, 1/6, 1/8, 1/10, 1/13, 1/15, 1/20, 1/25, 1/30, 1/40, 1/50, 1/60, 1/80, 1/100, 1/125, 1/160, 1/200, 1/250, 1/320, 1/400, 1/500, 1/640, 1/800, 1/1000, 1/1250, 1/1600, 1/2000

## Aperture

f/number	f/3.4 – f/8.0 (W), f/6.5 – f/8.0 (T)
Available values in [ <b>Av</b> ] mode*	f/3.4, f/4.0, f/4.5, f/5.0, f/5.6, f/6.3, f/7.1, f/8.0

\* Depending on the zoom position, some aperture values may not be available.

## Battery Pack NB-6LH

Type:	Rechargeable lithium-ion battery
Nominal Voltage:	3.7 V DC
Nominal Capacity:	1060 mAh
Charging Cycles:	Approx. 300 times
Operating Temperatures:	0 – 40 °C (32 – 104 °F)
Dimensions:	34.4 x 41.8 x 6.9 mm (1.35 x 1.65 x 0.27 in.)
Weight:	Approx. 22 g (approx. 0.78 oz.)

## Battery Charger CB-2LY/CB-2LYE

Rated Input:	100 – 240 V AC (50/60 Hz), 0.085 A (100 V) – 0.05 A (240 V)
Rated Output:	4.2 V DC, 0.7 A
Charging Time:	Approx. 2 hr. (when using NB-6LH)
Charge Indicator:	Charging: orange / Fully charged: green (two-indicator system)
Operating Temperatures:	0 – 40 °C (32 – 104 °F)

## Lens Hood LH-DC60 (Sold Separately)

Camera Mount:	Bayonet
Max. Diameter x Length:	φ69.6 x 27.0 mm (φ2.74 x 1.06 in.)
Weight:	Approx. 10 g (approx. 0.35 oz.)

Before Use
Basic Guide
Advanced Guide
<b>1</b> Camera Basics
<b>2</b> Auto Mode / Hybrid Auto Mode
<b>3</b> Other Shooting Modes
<b>4</b> P Mode
<b>5</b> Tv, Av, and M Mode
<b>6</b> Playback Mode
<b>7</b> Wi-Fi Functions
<b>8</b> Setting Menu
<b>9</b> Accessories
<b>10</b> Appendix
Index



# Index

## A

AC adapter kit 132, 135  
Accessories 132  
AE lock 62  
AF frames 68  
AF lock 70  
Aspect ratio 45  
AUTO mode (shooting mode) 22, 32  
Av (shooting mode) 75  
AV cable 134

## B

Batteries → Date/time (date/time battery)  
    Power saving 26  
Battery charger 2, 132  
Battery pack  
    Charging 18  
    Eco mode 126  
    Level 153  
    Power saving 26  
Black and white images 65  
Blink detection 48

## C

Camera  
    Reset all 130  
Camera access point mode 105  
CameraWindow (computer) 105, 137  
CameraWindow (smartphone) 98  
CANON IMAGE GATEWAY 97, 111  
Center (AF frame mode) 68  
Clock 31

Color (white balance) 64  
Compression ratio (image quality) 73  
Connecting via an access point 107  
Continuous shooting  
    High-speed burst (shooting mode) 59  
Creative filters (shooting mode) 54  
Creative Shot 52  
Cropping 92, 141  
Custom white balance 64

## D

Date/time  
    Adding date stamps 43  
    Changing 20  
    Date/time battery 21  
    Settings 20  
    World clock 125  
DC coupler 135  
Defaults → Reset all  
Digital tele-converter 67  
Digital zoom 38  
Display language 21  
DPOF 143

## E

Eco mode 126  
Editing  
    Cropping 92  
    i-Contrast 94  
    My Colors 93  
    Red-eye correction 94  
    Resizing images 92

Editing or erasing connection information 122

Erasing 88  
Error messages 150  
Exposure  
    AE lock 62  
    Compensation 62  
    FE lock 72

## F

Face AiAF (AF frame mode) 68  
Face self-timer (shooting mode) 58  
Favorites 91  
FE lock 72  
File numbering 128  
Fireworks (shooting mode) 54  
Fish-eye effect (shooting mode) 55  
Flash  
    Flash exposure compensation 72  
    On 71  
    Slow synchro 71  
Focusing  
    AF frames 68  
    AF lock 70  
    AF-point zoom 47  
    Servo AF 69  
Focusing range  
    Macro 66  
    Manual focus 66

Focus lock 68  
FUNC. menu  
    Basic operations 28  
    Table 156, 162

## G

GPS information display 79  
Grid lines 47

## H

HDMI cable 133, 134  
High-speed burst (shooting mode) 59  
Household power 135  
Hybrid Auto (shooting mode) 34

## I

i-Contrast 63, 94  
Image quality → Compression ratio (image quality)  
Images  
    Display period 49  
    Erasing 88  
    Playback → Viewing  
    Protecting 85  
Image stabilization 73  
Image Sync 118  
Indicator 30, 48, 49  
ISO speed 63

## L

Live View Control (shooting mode) 51  
Low light (shooting mode) 53

## M

M (shooting mode) 75  
Macro (focusing range) 66  
Magnified display 83  
Manual focus (focusing range) 66  
Memory cards 2  
    Recording time 164  
Menu  
    Basic operations 29  
    Table 154  
Metering method 62  
Miniature effect (shooting mode) 55  
Mobile device connection button 101

Before Use

Basic Guide

Advanced Guide

**1** Camera Basics

**2** Auto Mode /  
Hybrid Auto Mode

**3** Other Shooting Modes

**4** P Mode

**5** Tv, Av, and M Mode

**6** Playback Mode

**7** Wi-Fi Functions

**8** Setting Menu

**9** Accessories

**10** Appendix

Index



Monochrome (shooting mode) 57  
Movies  
  Editing 95  
  Image quality (resolution/frame rate) 45, 46  
  Recording time 164  
My Colors 64, 93

**N**  
Neck strap → Strap

**P**  
P (shooting mode) 61  
Package contents 2  
Photobook set-up 145  
PictBridge 133, 140  
Playback → Viewing  
Portrait (shooting mode) 53  
Poster effect (shooting mode) 54  
Power 132 → AC adapter kit,  
  → Battery charger, → Battery pack  
Power saving 26  
Printing 140  
Program AE 61  
Protecting 85

**R**  
Red-eye correction 46, 94  
Remote shooting 121  
Reset all 130  
Resizing images 92  
Resolution (image size) 45  
Rotating 90

**S**  
Saving images to a computer 105,  
  138

Screen  
  Display language 21  
  Icons 152, 153  
  Menu → FUNC. menu, Menu  
SD/SDHC/SDXC memory cards  
  → Memory cards  
Searching 81  
Self-timer 42  
  2-second self-timer 42  
  Customizing the self-timer 43  
  Face self-timer (shooting mode)  
    58  
  Wink self-timer (shooting mode)  
    58  
Sending images 117  
Sending images to a computer 105  
Sending images to another camera  
  116  
Sending images to a printer 114  
Sending images to a smartphone 98  
Sending images to Web services 113  
Sepia tone images 65  
Servo AF 69  
Shooting  
  Shooting date/time → Date/time  
  Shooting information 152  
Slideshow 84  
Smart Shuffle 85  
Smart Shutter (shooting mode) 57  
Smile (shooting mode) 57  
Snow (shooting mode) 54  
Software  
  Installation 105  
  Saving images to a computer  
    105, 138  
Sounds 124  
Stereo AV cable 133, 134

Strap 2, 17  
Super vivid (shooting mode) 54

## T

Terminal 134, 135, 140  
Toy camera effect (shooting mode)  
  56  
Tracking AF 69  
Traveling with the camera 125  
Troubleshooting 147  
TV display 134  
Tv (shooting mode) 74

## V

Viewing 23  
  Image search 81  
  Index display 80  
  Magnified display 83  
  Single-image display 23  
  Slideshow 84  
  Smart Shuffle 85  
  TV display 134

## W

White balance (color) 64  
Wi-Fi functions 97  
Wi-Fi menu 102  
Wink self-timer (shooting mode) 58  
World clock 125

## Z

Zoom 22, 33, 38  
Zoom framing assist 39

Before Use

Basic Guide

Advanced Guide

**1** Camera Basics

**2** Auto Mode /  
Hybrid Auto Mode

**3** Other Shooting Modes

**4** P Mode

**5** Tv, Av, and M Mode

**6** Playback Mode

**7** Wi-Fi Functions

**8** Setting Menu

**9** Accessories

**10** Appendix

Index

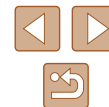

## Wi-Fi (Wireless LAN) Precautions

- Countries and Regions Permitting WLAN Use
  - Use of WLAN is restricted in some countries and regions, and illegal use may be punishable under national or local regulations. To avoid violating WLAN regulations, visit the Canon website to check where use is allowed.  
Note that Canon cannot be held liable for any problems arising from use in other countries and regions.
- Doing any of the following may incur legal penalties:
  - Altering or modifying the product
  - Removing the certification labels from the product
- According to foreign exchange and foreign trade law regulations, export permission (or service transaction permission) from the Japanese government is necessary to export strategic resources or services (including this product) outside Japan.
- Because this product includes American encryption software, it falls under U.S. Export Administration Regulations, and cannot be exported to or brought into a country under U.S. trade embargo.
- Be sure to make notes of the wireless LAN settings you use. The wireless LAN settings saved to this product may change or be erased due to incorrect operation of the product, the effects of radio waves or static electricity, or accident or malfunction. Be sure to make notes of wireless LAN settings as a precaution. Please note that Canon accepts no responsibility for direct or indirect damages or loss of earnings resulting from a degradation or disappearance of content.
- When transferring this product to another person, disposing of it, or sending it for repair, be sure to note the wireless LAN settings and reset the product to its default settings (erase settings) if necessary.
- Canon will not make compensation for damages resulting from loss or theft of the product.  
Canon accepts no responsibility for damages or loss resulting from unauthorized access or use of target devices registered on this product due to loss or theft of the product.

- Be sure to use the product as directed in this guide. Be sure to use the wireless LAN function of this product within the guidelines noted in this guide. Canon accepts no responsibility for damages or loss if the function and product are used in ways other than as described in this guide.
- Do not use the wireless LAN function of this product near medical equipment or other electronic equipment. Use of the wireless LAN function near medical equipment or other electronic equipment may affect operation of those devices.

## Radio Wave Interference Precautions

- This product may receive interference from other devices that emit radio waves. To avoid interference, be sure to use this product as far away as possible from such devices, or avoid using the devices at the same time as this product.

## Security Precautions

Because Wi-Fi uses radio waves to transmit signals, security precautions more stringent than when using a LAN cable are required. Keep the following points in mind when using Wi-Fi.

- Only use networks you are authorized to use. This product searches for Wi-Fi networks in the vicinity and displays the results on the screen. Networks you are not authorized to use (unknown networks) may also be displayed. However, attempting to connect to or using such networks could be regarded as unauthorized access. Be sure to use only networks you are authorized to use, and do not attempt to connect to other unknown networks.

Before Use

Basic Guide

Advanced Guide

**1** Camera Basics

**2** Auto Mode / Hybrid Auto Mode

**3** Other Shooting Modes

**4** P Mode

**5** Tv, Av, and M Mode

**6** Playback Mode

**7** Wi-Fi Functions

**8** Setting Menu

**9** Accessories

**10** Appendix

Index





If security settings have not been properly set, the following problems may occur.

- **Transmission monitoring**  
Third parties with malicious intent may monitor Wi-Fi transmissions and attempt to acquire the data you are sending.
- **Unauthorized network access**  
Third parties with malicious intent may gain unauthorized access to the network you are using to steal, modify, or destroy information. Additionally, you could fall victim to other types of unauthorized access such as impersonation (where someone assumes an identity to gain access to unauthorized information) or springboard attacks (where someone gains unauthorized access to your network as a springboard to cover their tracks when infiltrating other systems).

To prevent these types of problems from occurring, be sure to thoroughly secure your Wi-Fi network.

Only use this camera's Wi-Fi function with a proper understanding of Wi-Fi security, and balance risk and convenience when adjusting security settings.



The camera can print to PictBridge-compatible printers via Wi-Fi. PictBridge technical standards make it easy to connect digital cameras, printers, and other devices directly. Additionally, a new standard called DPS over IP enables PictBridge connections in network environments, and the camera is also compatible with this standard.

## Trademarks and Licensing

- Microsoft and Windows are trademarks or registered trademarks of Microsoft Corporation in the United States and/or other countries.
- Macintosh and Mac OS are trademarks of Apple Inc., registered in the U.S. and other countries.
- App Store, iPhone, and iPad are trademarks of Apple Inc.
- The SDXC logo is a trademark of SD-3C, LLC.
- HDMI, the HDMI logo and High-Definition Multimedia Interface are trademarks or registered trademarks of HDMI Licensing, LLC.
- Wi-Fi®, Wi-Fi Alliance®, WPA™, WPA2™ and Wi-Fi Protected Setup™ are trademarks or registered trademarks of the Wi-Fi Alliance.
- The N-Mark is a trademark or registered trademark of NFC Forum, Inc. in the United States and in other countries.
- All other trademarks are the property of their respective owners.
- This device incorporates exFAT technology licensed from Microsoft.
- This product is licensed under AT&T patents for the MPEG-4 standard and may be used for encoding MPEG-4 compliant video and/or decoding MPEG-4 compliant video that was encoded only (1) for a personal and non-commercial purpose or (2) by a video provider licensed under the AT&T patents to provide MPEG-4 compliant video. No license is granted or implied for any other use for MPEG-4 standard.

## Disclaimer

- Unauthorized reproduction of this guide is prohibited.
- All measurements based on Canon testing standards.
- Information subject to change without notice, as are product specifications and appearance.
- Illustrations and screenshots in this guide may differ slightly from the actual equipment.
- The above items notwithstanding, Canon cannot be held liable for any loss arising from the use of this product.

Before Use

Basic Guide

Advanced Guide

**1** Camera Basics

**2** Auto Mode / Hybrid Auto Mode

**3** Other Shooting Modes

**4** P Mode

**5** Tv, Av, and M Mode

**6** Playback Mode

**7** Wi-Fi Functions

**8** Setting Menu

**9** Accessories

**10** Appendix

Index

