

Canon

PUB. DIM-1067-000A



**VIXIA**  
HF G20

HD Camcorder  
**Instruction Manual**

English

Caméscope HD  
**Manuel d'instruction**

Français

Videocámara HD  
**Manual de Instrucciones**

Español

**NTSC**

**HDMI** **AVCHD™**

# Important Usage Instructions

**WARNING**

**TO REDUCE THE RISK OF FIRE OR ELECTRIC SHOCK, DO NOT EXPOSE THIS PRODUCT TO RAIN OR MOISTURE.**

**WARNING**

**TO REDUCE THE RISK OF ELECTRIC SHOCK AND TO REDUCE ANNOYING INTERFERENCE, USE THE RECOMMENDED ACCESSORIES ONLY.**

**COPYRIGHT WARNING:**

**Unauthorized recording of copyrighted materials may infringe on the rights of copyright owners and be contrary to copyright laws.**

2

HD Camcorder, VIXIA HF G20 systems

This device complies with Part 15 of the FCC Rules. Operation is subject to the following two conditions: (1) This device may not cause harmful interference, and (2) this device must accept any interference received, including interference that may cause undesired operation.

Note: This equipment has been tested and found to comply with the limits for class B digital device, pursuant to Part 15 of the FCC Rules. These limits are designed to provide reasonable protection against harmful interference in a residential installation. This equipment generates, uses and can radiate radio frequency energy and, if not installed and use in accordance with the instructions, may cause harmful interference to radio communications. However, there is no guarantee that interference will not occur in a particular installation. If this equipment does cause harmful interference to radio or television reception, which can be determined by turning the equipment off and on, the user is encouraged to try to correct the interference by one or more of the following measures:

- Reorient or relocate the receiving antenna.
- Increase the separation between the equipment and receiver.
- Connect the equipment into an outlet on a circuit different from that to which the receiver is connected.
- Consult the dealer or an experienced radio/TV technician for help.

Use of shielded cable is required to comply with class B limits in Subpart B of Part 15 of FCC Rules.

Do not make any changes or modifications to the equipment unless otherwise specified in the manual. If such changes or modifications should be made, you could be required to stop operation of the equipment.

Canon U.S.A., Inc.

One Canon Park, Melville, New York 11747, USA

Tel No. 1-800-OK-CANON (1-800-652-2666)

The Mains plug is used as the disconnect device. The Mains plug shall remain readily operable to disconnect the plug in case of an accident.

**CAUTION:**

- Danger of explosion if the wrong type of batteries are attached. Use only the same type of batteries.
- Do not expose batteries or product to excessive heat such as the inside of a car under direct sunlight, fire, etc.

## Important Warning



The lightning flash with arrowhead symbol, within an equilateral triangle, is intended to alert the user to the presence of uninsulated "dangerous voltage" within the product's enclosure, that may be of sufficient magnitude to constitute a risk of electric shock to persons.

**CAUTION:**

**TO REDUCE THE RISK OF ELECTRIC SHOCK, DO NOT REMOVE COVER (OR BACK). NO USER-SERVICEABLE PARTS INSIDE. REFER SERVICING TO QUALIFIED SERVICE PERSONNEL.**



The exclamation point, within an equilateral triangle, is intended to alert the user to the presence of important operating and maintenance (servicing) instructions in the literature accompanying the product.

# IMPORTANT SAFETY INSTRUCTIONS

In these safety instructions the word "product" refers to the Canon HD Camcorder VIXIA HF G20 and all its accessories.

- 1 Read these instructions.
- 2 Keep these instructions.
- 3 Heed all warnings.
- 4 Follow all instructions.
- 5 Do not use this apparatus near water.
- 6 Clean only with dry cloth.
- 7 Do not install near any heat sources such as radiators, heat registers, stoves, or other apparatus (including amplifiers) that produce heat.
- 8 Do not defeat the safety purpose of the polarized or grounding-type plug. A polarized plug has two blades with one wider than the other. A grounding type plug has two blades and a third grounding prong. The wide blade or the third prong are provided for your safety. If the provided plug does not fit into your outlet, consult an electrician for replacement of the obsolete outlet.
- 9 Protect the power cord from being walked on or pinched particularly at plugs, convenience receptacles, and the point where they exit from the apparatus.
- 10 Only use attachments/accessories specified by the manufacturer.
- 11 Unplug this apparatus during lightning storms or when unused for long periods of time.
- 12 Refer all servicing to qualified service personnel. Servicing is required when the apparatus has been damaged in any way, such as power-supply cord or plug is damaged, liquid has been spilled or objects have fallen into the apparatus, the apparatus has been exposed to rain or moisture, does not operate normally, or has been dropped.

3

CA-570 identification plate is located on the bottom.

This Class B digital apparatus complies with Canadian ICES-003.

## Trademark Acknowledgements

- SD, SDHC and SDXC Logos are trademarks of SD-3C, LLC.
- Microsoft and Windows are trademarks or registered trademarks of Microsoft Corporation in the United States and/or other countries.
- Apple and Mac OS are trademarks of Apple Inc., registered in the U.S. and other countries.
- "x.v.Color" and the "x.v.Color" logo are trademarks.
- HDMI, the HDMI logo and High-Definition Multimedia Interface are trademarks or registered trademarks of HDMI Licensing LLC in the United States and other countries.
- "AVCHD" and the "AVCHD" logo are trademarks of Panasonic Corporation and Sony Corporation.
- Manufactured under license from Dolby Laboratories.
  - "Dolby" and the double-D symbol are trademarks of Dolby Laboratories.
- YouTube is a trademark of Google Inc.
- Facebook is a registered trademark of Facebook, Inc.
- Other names and products not mentioned above may be trademarks or registered trademarks of their respective companies.
- This device incorporates exFAT technology licensed from Microsoft.
- "Full HD 1080" refers to Canon camcorders compliant with high-definition video composed of 1,080 vertical pixels (scanning lines).
- ANY USE OF THIS PRODUCT OTHER THAN CONSUMER PERSONAL USE IN ANY MANNER THAT COMPLIES WITH THE MPEG-2 STANDARD FOR ENCODING VIDEO INFORMATION FOR PACKAGED MEDIA IS EXPRESSLY PROHIBITED WITHOUT A LICENSE UNDER APPLICABLE PATENTS IN THE MPEG-2 PATENT PORTFOLIO, WHICH LICENSE IS AVAILABLE FROM MPEG LA, L.L.C., 250 STEELE STREET, SUITE 300, DENVER, COLORADO 80206.
- This product is licensed under AT&T patents for the MPEG-4 standard and may be used for encoding MPEG-4 compliant video and/or decoding MPEG-4 compliant video that was encoded only (1) for a personal and non-commercial purpose or (2) by a video provider licensed under the AT&T patents to provide MPEG-4 compliant video. No license is granted or implied for any other use for MPEG-4 standard.



# Highlights of the VIXIA HF G20

The Canon VIXIA HF G20 HD Camcorder is a high-performance camcorder whose compact size makes it ideal in a variety of situations. The following are just some of the many functions featured in the camcorder.

4

## HD Recording

### HD CMOS PRO and DIGIC DV III processor

The camcorder is equipped with a 1/3-inch CMOS sensor that captures video at an effective pixel count of approximately 2.07 megapixels (1920x1080). The video is then processed by the state-of-the-art DIGIC DV III image processor. This allows the camcorder to excel in low-light situations and produce a wide dynamic range.

### Wide zoom lens

With a focal length at full wide angle of 30.4 mm (35 mm equivalent), the camcorder has superb wide-angle shooting capability. The minimum object distance is 60 cm (2 ft.) throughout the entire zoom range, which means that you can create a pleasing blurred background effect at full telephoto. The 8-bladed iris aperture also enhances the blurred background effect.

### Shoot cinematic video

Using CINEMA mode and the cinema-look filters (☐ 101), you can make recordings that truly look and feel cinematic.

## Operability

### Emphasis on versatility

This camcorder has features to make it usable as a main camera but is also small enough to be very portable. The advanced image stabilization (☐ 55) will let you shoot in a variety of situations in the field. Moreover, in full-automatic mode, Intelligent IS (☐ 40) will select the optimal type of image stabilization for the recording situation.

### Manual controls at your fingertips

The focus ring helps you achieve the focus you are looking for. Furthermore, you can assign certain frequently used functions to a customizable button and adjust those functions with the accompanying dial (☐ 84).

### Face detection

When a subject's face is detected, the camcorder can track and focus on it (☐ 49). Furthermore, you can have the camcorder in manual focus but switch to autofocus only when a face is detected, ensuring that important subjects are in focus.

### Relay recording and double slot recording

When you use relay recording (☐ 35), you can use the double memory card slot to keep on recording video without interruption. Double slot recording (☐ 36) allows you to record movies simultaneously to two memory cards, which is a convenient way to back up your recordings.

## Other Features

### Audio

With the audio scene select function (☐ 68), you can optimize the audio settings of the built-in microphone by selecting the audio scene that matches your surroundings. Your audience will feel even more immersed in the scene during playback.

### Smart AUTO

Smart AUTO (☐ 40) automatically selects the best scene mode for the scene you want to shoot. You get spectacular recordings every time without worrying about settings.

### **LCD screen and viewfinder**

The LCD screen and viewfinder both have 100% frame coverage, which will ensure that you can accurately check that your shots are framed how you want them.

### **Touch AE**

By simply touching the screen, you can make dark areas in the picture appear brighter (📖 60). This operation is simple yet allows you to shoot with the desired exposure.

### **Added and improved functionality**

Other functions include two types of video scopes (📖 79), conversion to standard definition (📖 133) and Story Creator mode (📖 99), which allows you to create engrossing video stories.

# Enjoying your Recordings on Other Devices

6

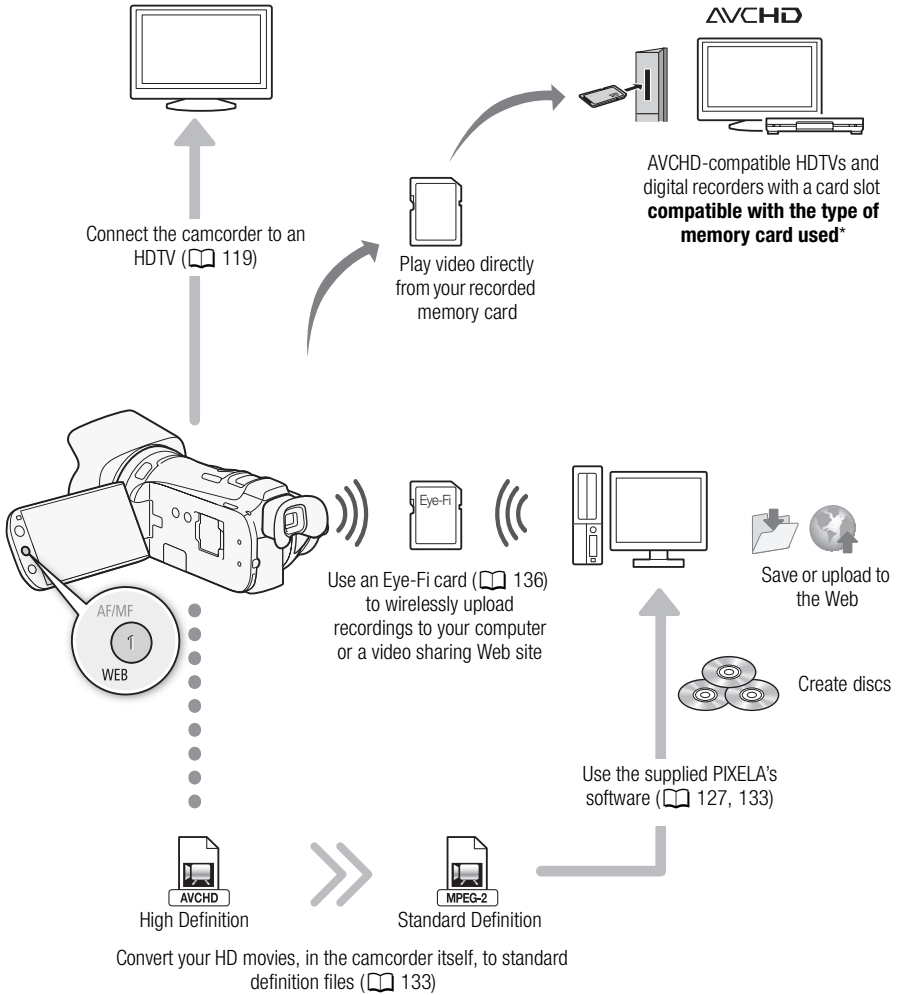

\* Refer to the instruction manual of the device. Depending on the device used, correct playback may not be possible even if the device is AVCHD-compatible. In such case, play back the recordings on the memory card using the camcorder.

# Table of contents

## 1 Introduction 10

- About this Manual 10
  - Conventions Used in this Manual 10
- Supplied Accessories and CD-ROMs 12
- Names of Parts 14

## 2 Preparations 20

- Charging the Battery Pack 20
- Preparing the Camcorder 22
  - Attaching the Lens Hood 22
  - Using the Viewfinder 22
  - Adjusting the Position and Brightness of the LCD Screen 23
  - Grip Belt and Straps 24
  - Wireless Controller 25
  - Using a Tripod 26

### Basic Operation of the Camcorder 27

- Using the Touch Screen 27
- Operating Modes 28
- Using the Menus 29

### First Time Settings 31

- Setting the Date and Time 31
- Changing the Language 31
- Changing the Time Zone 32

### Using a Memory Card 33

- Memory Cards Compatible for Use with the Camcorder 33
- Inserting and Removing a Memory Card 34
- Selecting the Memory for the Recordings 34
- Relay Recording 35
- Double Slot Recording 36
- Initializing the Memory 36

## 3 Recording 38

- Recording Movies and Photos 38
  - Preparing to Record 38
  - Recording in AUTO Mode 39
  - Recording in **M** (Manual) Mode 42
- Quick Start Function 44
- Selecting the Video Quality (Recording Mode) 45
- Selecting the Frame Rate 46

### Focus Adjustment 47

- Manual Focus 47
- Autofocus 48
- Face Detection 49
- Touch & Track 51

### Zooming 52

- Using the Zoom Lever or Wireless Controller 52
- Using the Touch Screen's Zoom Controls 53
- Soft Zoom Control 54
- Digital Tele-Converter 54

### Advanced Image Stabilization 55

### Automatic Gain Control (AGC) Limit 56

### Automatic Exposure Recording Programs 57

### Exposure Adjustment 59

- Using the Manual Exposure Recording Program 59
- Exposure Compensation 60

### White Balance 62

### Special Scene Recording Programs 64

### Image Effects 66

### Self Timer 67

### Audio Scenes and Other Audio Settings 68

- Audio Recording Level 69
- Built-In Microphone Directionality 70
- Audio Equalizer 71
- Auto Wind Screen 71
- Audio Mix 72

### Using Headphones 73

### Using the Mini Advanced Shoe 74

### Using an External Microphone 75

- Using the SM-V1 Surround Microphone or DM-100 Directional Stereo Microphone 75
- Using the WM-V1 Wireless Microphone 76
- Using Commercially Available Microphones 76

### Using an External Video Light 77

### Color Bars/Audio Reference Signal 78

- Video Scopes 79
  - Displaying the Waveform Monitor during [P Programmed AE] Recording Program 79
  - Displaying the Waveform Monitor during [M Manual Exposure] Recording Program 79
  - Displaying the Edge Monitor 79
- Video Snapshot 80
- Pre-Recording 81
- Onscreen Displays and Data Code 82
- Faders 83

## 4 Customization 84

- Custom Button and Dial 84
- Assignable Buttons 85
  - Changing the Assigned Function 85
  - Using an Assignable Button 85
- Saving and Loading Menu Settings 86
  - Saving Menu Settings to a Memory Card 86
  - Loading Menu Settings from a Memory Card 86

## 5 Playback 87

- Playing Back Video 87
  - Adjusting the volume 88
  - 3D Flip View 90
- The Index Selection Screen: Selecting the Content to Play Back 91
- Deleting Scenes and Stories 92
  - Deleting a Single Scene 92
  - Deleting Scenes from the Date Index Screen 92
  - Deleting a Single Scene from a Story 93
  - Deleting Scenes from a Story by Rating 93
  - Deleting Stories 94
- Dividing Scenes 95
- Selecting the Playback Starting Point 96
- Capturing Video Snapshot Scenes and Photos from a Movie 97
  - Capturing a Video Snapshot Scene 97
  - Capturing Photos 98

## 6 Video Stories and Cinema Style 99

- Using Story Creator to Create Video Stories 99
  - Creating a New Story 99
  - Recording a Scene within a Story 99
  - Recording Additional Scenes within an Existing Story 100
- CINEMA Mode and Cinema-Look Filters 101
- Adding Decorations 103
  - Decorating Scenes while Recording 103
  - Decorating Scenes during Playback 106
- Playing Back Stories from the Gallery 107
- Rating Scenes 109
  - Rating Scenes Immediately After Recording 109
  - Rating Scenes from the List of Scenes 109
  - Rating Scenes during Playback 109
- Playback with Background Music 110
  - Using One of the Supplied Music Tracks as Background Music 110
  - Using an External Audio Player for Background Music 111
- Copying and Moving Scenes Within/ Between Stories 113
- Selecting a Story's Thumbnail Image 114
- Changing a Story's Title 115

## 7 External Connections 116

- Terminals on the Camcorder 116
- Connection Diagrams 117
- Playback on a TV Screen 119

## 8 Photos 120

- Viewing Photos 120
  - Photo Jump Function 121
- Slideshow 122
- Deleting Photos 123
  - Deleting a Single Photo 123
  - Deleting Photos from the Index Screen 123



## 9 Saving/Sharing

### Recordings 124

#### Copying Recordings to a Memory Card 124

Copying Scenes from the Date Index  
Screen 124

Copying Scenes from a Story by  
Rating 125

Copying a Single Photo 125

Copying Photos from the Index  
Screen 126

#### Saving Recordings on a Computer 127

Saving Movies (Windows only) 127

Saving Photos (Windows/Mac OS) 128

#### Copying Recordings to an External Video Recorder 131

In High Definition 131

In Standard Definition 131

#### Uploading Recordings to the Web 133

Converting Scenes into Standard  
Definition from the Date Index  
Screen 133

Converting Scenes into Standard  
Definition from a Story by Rating 135

Converting Only Part of a Scene or  
Story 135

Uploading your Videos Wirelessly 136

Uploading Photos to the Web 137

## 10 Additional Information 138

### Appendix: Menu Options Lists 138

FUNC. Panel 138

Setup Menus 141

### Appendix: Onscreen Icons and Displays 150

#### Troubleshooting 154

List of Messages 159

#### Handling Precautions 165

Camcorder 165

Battery Pack 166

Memory Card 166

Built-in Rechargeable Lithium  
Battery 167

Lithium Button Battery 167

Disposal 167

#### Maintenance/Others 168

Cleaning 168

Condensation 168

Using the Camcorder Abroad 169

#### Optional Accessories 170

#### Specifications 175

#### Index 179

---

# 1





# Introduction

## About this Manual

Thank you for purchasing the Canon VIXIA HF G20. Please read this manual carefully before you use the camcorder and retain it for future reference. Should your camcorder fail to operate correctly, refer to *Troubleshooting* (📖 154).

10

## Conventions Used in this Manual

-  **IMPORTANT:** Precautions related to the camcorder's operation.
-  **NOTES:** Additional topics that complement the basic operating procedures.
-  **POINTS TO CHECK:** Restrictions or requirements regarding the function described.
- : Reference page number within this manual.
- The following terms are used in this manual:
  - When not specified as “memory card” or “built-in memory”, the term “memory” by itself refers to both.
  - “Scene” refers to one movie unit from the point you press the **START/STOP** button to start recording until you press again to pause the recording.
- The photos included in this manual are simulated pictures taken with a still camera.
- Some screenshots in this manual have been simplified to show only relevant icons.

**AUTO** indicates that a function is available in the operating mode indicated and **[AUTO]** indicates that the function is not available. For a detailed explanation refer to *Operating Modes* (📖 28).

Brackets [ ] are used to refer to control buttons and menu options you will touch on the screen and to other onscreen messages and displays.

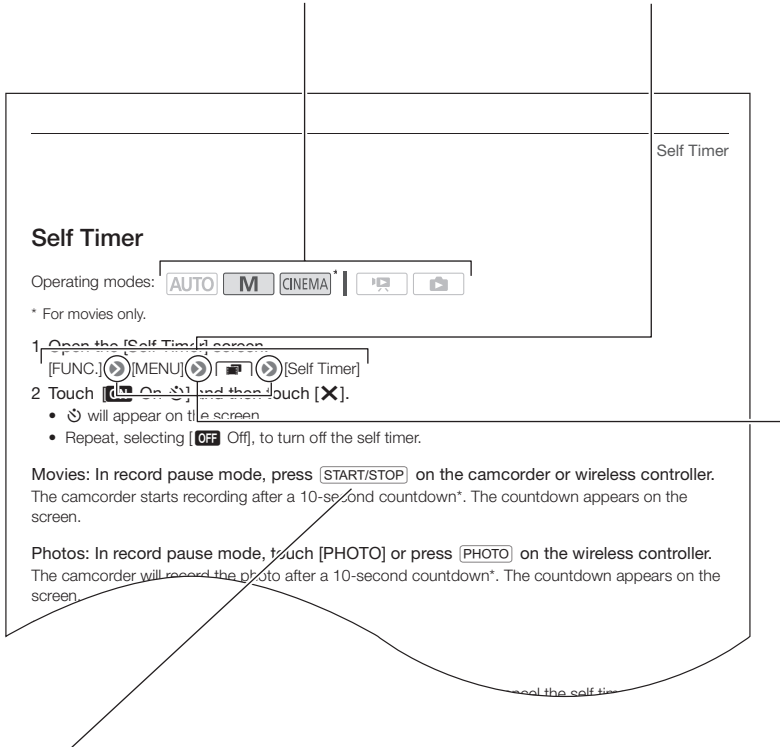

The names of physical buttons and switches on the camcorder are indicated within a "button" frame.  
For example **[START/STOP]**.

The **➤** arrow is used to abbreviate menu selections. For a detailed explanation on how to use the menus, refer to *Using the Menus* (📖 29). For a concise summary of all available menu options and settings, refer to the appendix *Menu Options Lists* (📖 138).

## Supplied Accessories and CD-ROMs

The following accessories are supplied with the camcorder:

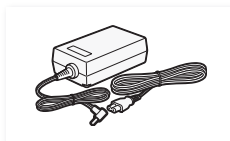

CA-570 Compact Power Adapter  
(incl. power cord)



BP-808 Battery Pack



WL-D89 Wireless Controller  
(incl. CR2025 lithium button battery)



Stylus Pen

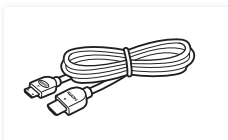

HTC-100/S High Speed HDMI Cable

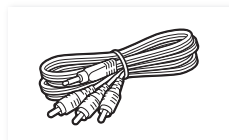

STV-250N Stereo Video Cable

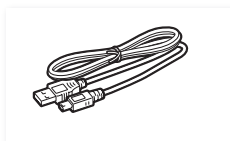

IFC-300PCU/S USB Cable



Lens hood with lens barrier



Lens cap



Startup Guide for PIXELA's Software

The following CD-ROMs and software are supplied with the camcorder:

- **PIXELA's VideoBrowser** CD-ROM\*
  - Software for saving, managing, editing and playing back your movies. Additionally, using **VideoBrowser** you can transfer to the camcorder music files that can be used as background music during playback.
- **Canon VIXIA** CD-ROM. Contains the following components.
  - **ImageBrowser EX** - Software for saving, managing and editing your photos. The supplied VIXIA CD-ROM contains an automatic installer for **ImageBrowser EX**. An Internet connection is required to fully install the software.
  - Music data - Music files that can be used as background music during playback. These music files are for exclusive use with the supplied PIXELA's software. The disc cannot be played back on CD players.
  - Image mix data - Image files that can be used with the image mix function (image mix frames).

\* The CD-ROM includes the instruction manual of the software (on PDF file).

## Names of Parts

### Left side view

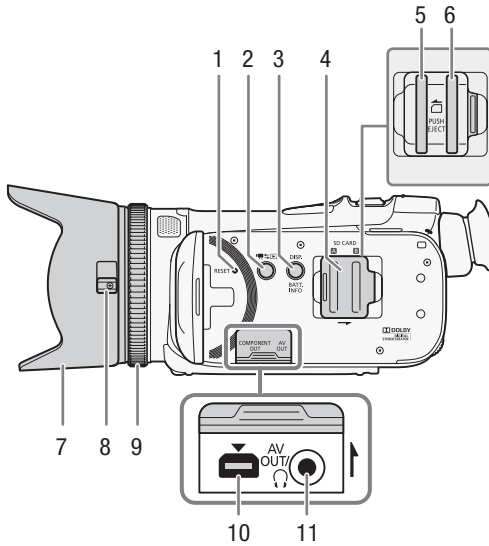

- 1 RESET button (📖 157)
- 2 📷➡️▶️ (camera/play) button (📖 28)
- 3 DISP. (onscreen display) button (📖 82)/BATT. INFO (battery info) button (📖 153)
- 4 Double memory card slot cover
- 5 Memory card slot **A** (📖 34)
- 6 Memory card slot **B** (📖 34)
- 7 Lens hood (📖 22)
- 8 Lens barrier switch (📖 38)
- 9 Focus ring (📖 47)
- 10 COMPONENT OUT terminal (📖 116, 117)
- 11 AV OUT terminal (📖 116, 118)/🎧 (headphones) terminal (📖 73)

## Right side view

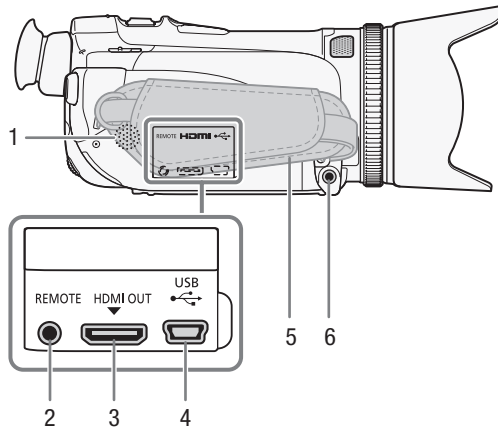

- 1 Built-in speaker (📖 88)
- 2 REMOTE terminal  
For connecting commercially available remote controllers.
- 3 HDMI OUT terminal (📖 116, 117)
- 4 USB terminal (📖 116, 118)
- 5 Grip belt (📖 24)
- 6 MIC terminal (📖 76, 111)

Front view

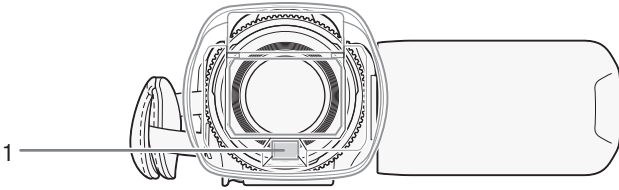

Back view

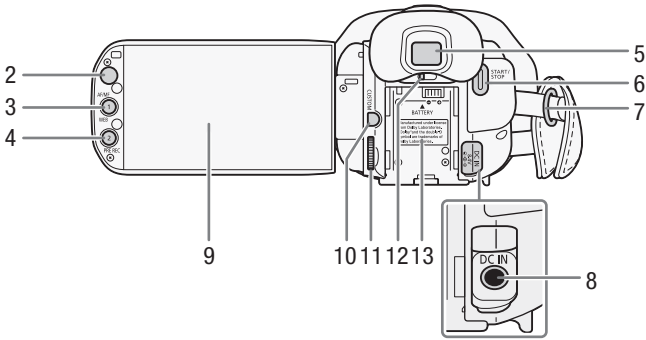

- |  |  |
|--|--|
| 1 Instant AF sensor ( 48, 168)   | 7 Strap mount ( 24)                      |
| 2 Remote sensor ( 25)  | 8 DC IN terminal ( 20)                   |
| 3 AF/MF button ( 47)/<br>WEB button ( 133)/<br>Assignable button 1 ( 85) | 9 LCD touch screen ( 23, 27)             |
| 4 PRE REC (pre-recording) button<br>( 81)/<br>Assignable button 2 ( 85)  | 10 CUSTOM (customizable) button<br>( 84) |
| 5 Viewfinder ( 22)   | 11 CUSTOM (customizable) dial ( 84)      |
| 6 START/STOP button ( 38)  | 12 Dioptic adjustment lever ( 22)        |
|  | 13 Battery attachment unit ( 20)         |



## Top view

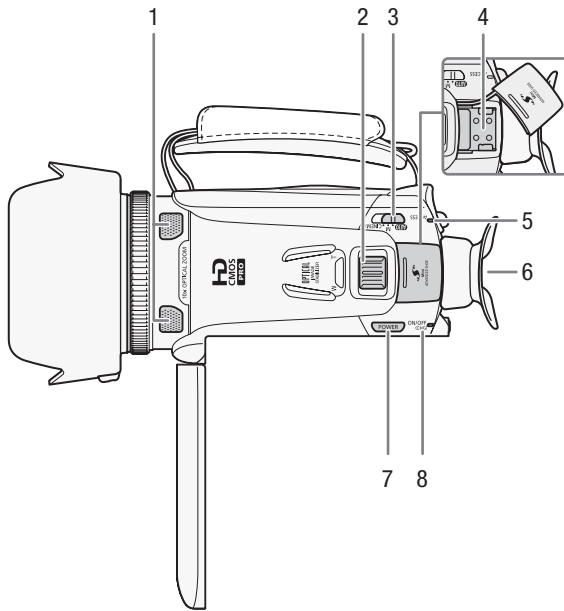

- |   |  |   |   |
|---|--|---|---|
| 1 | Built-in stereo microphone<br>( <a href="#">70, 71</a> ) | 6 | Eye cup ( <a href="#">22</a> )                |
| 2 | Zoom lever ( <a href="#">52</a> )                        | 7 | POWER button                                  |
| 3 | Mode switch ( <a href="#">28</a> )                       | 8 | ON/OFF (CHG) indicator ( <a href="#">20</a> ) |
| 4 | Mini advanced shoe ( <a href="#">74, 75</a> )            |   | Green - ON                                    |
| 5 | ACCESS indicator ( <a href="#">38</a> )                  |   | Orange - Standby ( <a href="#">44</a> )       |
|   |  |   | Red - Charging ( <a href="#">20</a> )         |

Bottom view

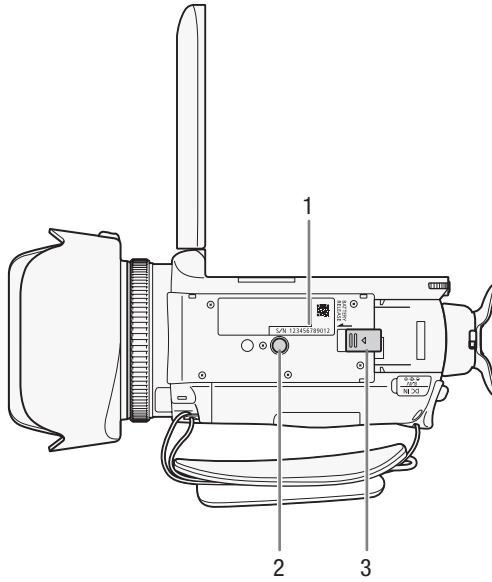







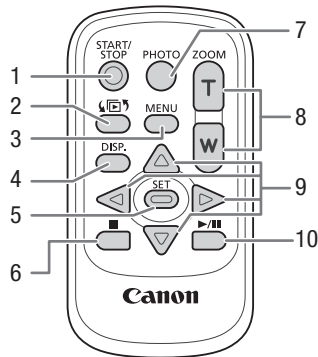

1 Serial number



- 2 Tripod socket ( 26)
- 3 BATTERY RELEASE switch ( 21)

## Wireless Controller WL-D89



- 1 START/STOP button (📖 38)
- 2  (index selection) button (📖 91)  
Press and hold for more than 2 seconds to switch between shooting and playback mode.
- 3 MENU button (📖 30, 141)
- 4 DISP. (onscreen display) button (📖 82)
- 5 SET button
- 6  (stop) button (📖 87)
- 7 PHOTO button (📖 38)
- 8 Zoom buttons (📖 52)
- 9 Navigation buttons (///)
- 10  (play/pause) button (📖 87)

# 2 Preparations

## Charging the Battery Pack

The camcorder can be powered with a battery pack or directly using the compact power adapter. For approximate charging times and recording/playback times with a fully charged battery pack, refer to *Charging, Recording and Playback Times* (📖 171).

- 1 Connect the power cord to the compact power adapter.
- 2 Plug the power cord into a power outlet.
- 3 Connect the compact power adapter to the camcorder's DC IN terminal.

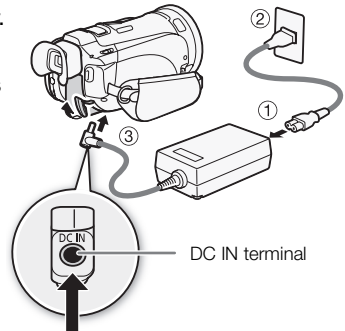

- 4 Attach the battery pack to the camcorder.
  - Press the battery pack softly into the battery attachment unit and slide it forward until it clicks in place.

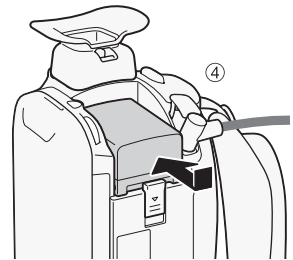

- 5 Charging will start when the camcorder is turned off.

- If the camcorder was on, the green ON/OFF (CHG) indicator will go out when you turn off the camcorder. After a moment, the ON/OFF (CHG) indicator will turn on in red (battery pack charging). The red ON/OFF (CHG) indicator will go out when the battery pack is fully charged.
- If the indicator flashes, refer to *Troubleshooting* (📖 156).

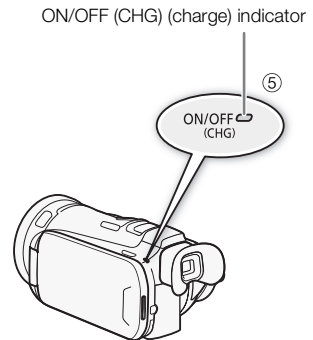

## To remove the battery pack

- 1 Slide **BATTERY RELEASE** in the direction of the arrow and hold it pressed down.
- 2 Slide the battery pack and then pull it out.

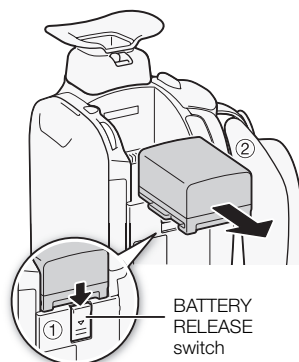

### ! IMPORTANT

- Turn off the camcorder before connecting or disconnecting the compact power adapter. After pressing **POWER** to turn off the camcorder, important data is updated in the memory. Be sure to wait until the green ON/OFF (CHG) indicator goes out.
- Do not connect to the camcorder's DC IN terminal or to the compact power adapter any electrical equipment that is not expressly recommended for use with this camcorder.
- To prevent equipment breakdowns and excessive heating, do not connect the supplied compact power adapter to voltage converters for overseas travels or special power sources such as those on aircraft and ships, DC-AC inverters, etc.

### i NOTES

- We recommend charging the battery pack in temperatures between 10 °C and 30 °C (50 °F and 86 °F). If either the ambient temperature or the battery pack's temperature is outside the range of approx. 0 °C to 40 °C (32 °F to 104 °F), charging will not start.
- The battery pack will be charged only when the camcorder is off.
- If the power supply was disconnected while charging a battery pack, make sure the ON/OFF (CHG) indicator has gone out before restoring the power supply.
- If remaining battery time is an issue, you can power the camcorder using the compact power adapter so the battery pack will not be consumed.
- Charged battery packs continue to discharge naturally. Therefore, charge them on the day of use, or the day before, to ensure a full charge.
- The first time you use a battery pack, fully charge it and then use the camcorder until the battery pack is completely exhausted. Doing so will ensure that the remaining recording time will be displayed accurately.
- We recommend that you prepare battery packs to last 2 to 3 times longer than you think you might need.
- **USA and Canada only:** The Lithium ion/polymer battery that powers the product is recyclable. Please call 1-800-8-BATTERY for information on how to recycle this battery.



## Preparing the Camcorder

This section covers the basic preparations for the camcorder such as attaching the lens hood, adjusting the grip belt and adjusting the viewfinder and LCD screen. When attaching the lens hood, grip belt and straps, be careful not to drop the camcorder.

### Attaching the Lens Hood

Attach the lens hood to protect the lens and reduce the amount of stray light that may hit the lens. Remove the lens cap before attaching the lens hood.

Place the lens hood on the front of the lens so that the groove on the lens hood is aligned with the bottom of the lens (①), and then turn the lens hood clockwise until it stops with a click (②).

- Be careful not to deform the lens hood.
- Make sure that the lens hood is aligned with the thread.
- To remove the lens hood, turn it counterclockwise.

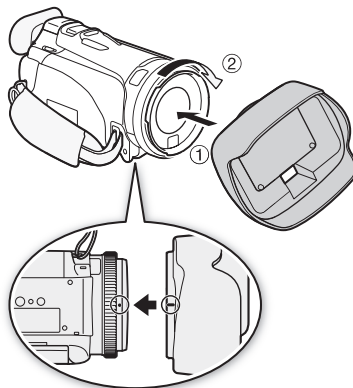

### Using the Viewfinder

If it is difficult to use the LCD screen while the LCD backlight is on (☐ 24), you can use the viewfinder. You can also use the viewfinder when you rotate the LCD panel 180 degrees to let the subject watch the recording.

- 1 Pull out the viewfinder.
- 2 Press **POWER** to turn on the camcorder.
- 3 Adjust the viewfinder using the dioptic adjustment lever.
  - You can close the LCD panel or rotate it toward the subject as you prefer.
  - The LCD backlight setting (☐ 24) is common to the LCD screen and the viewfinder.

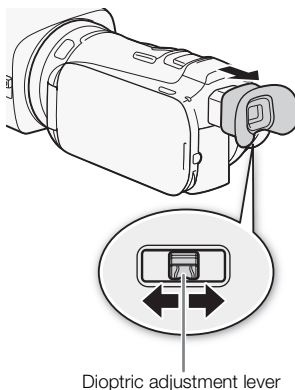

Dioptic adjustment lever

- If you wear glasses, you may find the viewfinder easier to use if you flip back the outer edge of the eye cup toward the camcorder body.

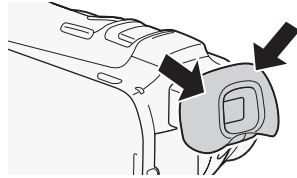

### **i** NOTES

- Make sure you keep the eye cup attached when using the camcorder.
- For details about how to take care of the viewfinder, refer to *Handling Precautions* (📖 165), *Cleaning* (📖 168).

## Adjusting the Position and Brightness of the LCD Screen

### Rotating the LCD Panel

Open the LCD panel 90 degrees.

- You can rotate the panel 90 degrees downward.
- You can rotate the panel 180 degrees toward the lens. Rotating the LCD panel 180 degrees can be useful in the following cases:
  - To allow the subject to monitor the LCD screen while you use the viewfinder.
  - To include yourself in the picture when recording with the self timer.
  - To allow the camcorder to be operated with the wireless controller from the front.

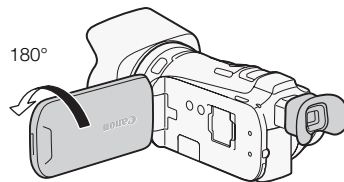
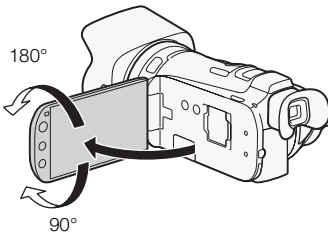

Subject can monitor the LCD screen  
(you can use the viewfinder at the same time)

### **i** NOTES

- **About the LCD and viewfinder screens:** The screens are produced using extremely high-precision manufacturing techniques, with more than 99.99% of the pixels operating to specification. Less than 0.01% of the pixels may occasionally misfire or appear as black, red, blue or green dots. This has no effect on the recorded image and does not constitute a malfunction.

## LCD Backlight

When recording in bright places it may be difficult to use the LCD screen. Turn on the LCD backlight to make it brighter.

With the camcorder on, hold **[DISP.]** pressed down for more than 2 seconds.

- Repeat this action to switch the LCD backlight between off (normal) and on (bright).

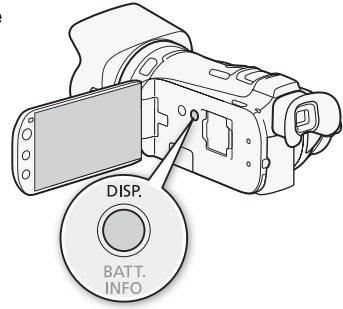

### **i** NOTES

- Adjusting the brightness does not affect the brightness of the recordings.
- Using the bright setting will shorten the effective usage time of the battery pack.
- You can further adjust the brightness of the LCD screen with the **[ ]** **[ ]** **[ ]** **[ ]** [LCD Brightness] setting, or dim it with the **[ ]** **[ ]** **[ ]** **[ ]** [LCD Screen Dimmer] setting to use in places where the light from the LCD screen can be a nuisance.
- For details about how to take care of the touch screen, refer to *Handling Precautions* ( 165), *Cleaning* ( 168).

## Grip Belt and Straps

Fasten the grip belt.

- Adjust the grip belt so that you can reach the zoom lever with your index finger, and the **[START/STOP]** button with your thumb.
- You can attach the supplied stylus pen to the grip belt.

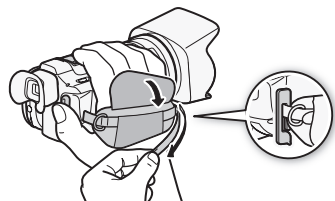

## Attaching an optional wrist strap

Attach the wrist strap to the strap mount on the grip belt, adjust the length and fasten.

- You can use both for extra convenience and protection.

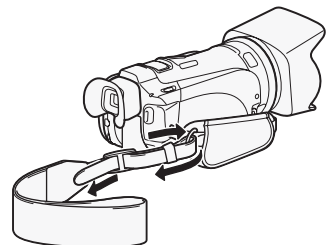



## Attaching an optional shoulder strap

Pass the ends of the shoulder strap through the strap mount on the grip belt and adjust the length of the strap.

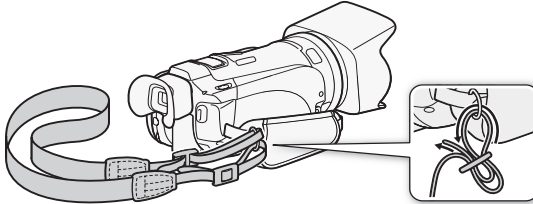

## Wireless Controller

First, insert the supplied CR2025 lithium button battery into the wireless controller.

- 1 Press the tab in the direction of the arrow and pull out the battery holder.
- 2 Place the lithium button battery with the + side facing up.
- 3 Insert the battery holder.

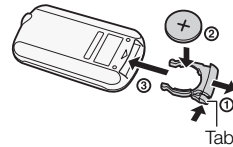

## To use the wireless controller

Point the wireless controller at the camcorder's remote sensor when you press the buttons.

- You can rotate the LCD panel 180 degrees to use the wireless controller from the front of the camcorder.

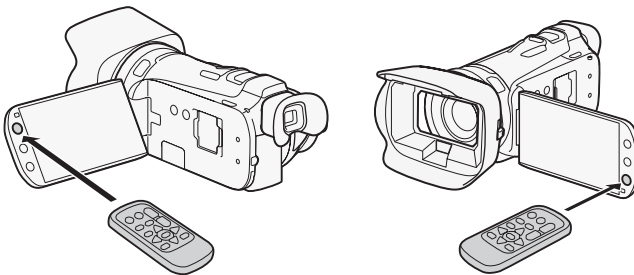

### **i** NOTES

- When the camcorder cannot be operated with the wireless controller, or when it can only be operated at very close range, replace the battery.
- The wireless controller may not work properly when the remote sensor is situated under strong light sources or direct sunlight.

## Using a Tripod

You can mount the camcorder on a tripod but do not use tripods with mounting screws longer than 6.5 mm (0.26 in.) as this may cause damage to the camcorder.

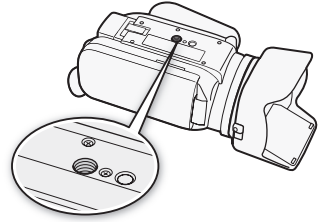

## Basic Operation of the Camcorder

### Using the Touch Screen

The control buttons and menu items that appear on the touch screen change dynamically depending on the operating mode and the task you are performing. With the intuitive touch screen interface you have all the controls at your fingertips. You can also use the supplied stylus pen for a more precise operation.

27

#### Touch

Press firmly on an element displayed on the touch screen. Used to start playing back a scene in an index screen, to select a setting from the menus, to select the subject whom the camcorder will recognize as the main subject of the scene, etc.

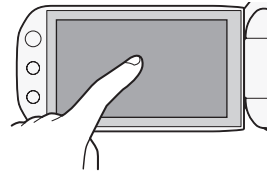

#### Drag

While applying pressure, swipe your finger up and down or left and right across the screen. Used to scroll menus, to browse through index screen pages or to adjust slider controls like the volume.

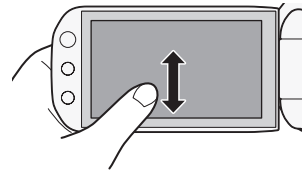







#### ! IMPORTANT

- **The camcorder uses a pressure-sensitive touch screen. Press firmly when using touch operations.**
- In the following cases, you may not be able to perform touch operations correctly.
  - Using your fingernails or hard-tipped objects other than the supplied stylus pen, such as ballpoint pens.
  - Operating the touch screen with wet or gloved hands.
  - Applying excessive force or forcefully scratching the touch screen.
  - Attaching commercially available screen protectors or adhesive film onto the touch screen's surface.



## Operating Modes



### Recording

In recording mode, the camcorder's operating mode is determined by the position of the mode switch.

Operating mode	Mode switch	Operation
		Let the camcorder take care of all the settings while you concentrate on recording (📖 39). This operating mode is suitable if you just prefer not to bother with detailed camcorder settings.
		Enjoy full access to menus, settings and advanced functions (📖 42).
		Give your recordings a cinematic look and use cinema-look filters to create unique movies (📖 101).

### Playback

Press the camera/play button  to switch the camcorder between camera (recording) mode and playback mode. You can press  when the camcorder is off to turn it on directly in playback mode.

Operating mode	Operation
	Playing back movies (📖 87).
	Viewing photos (📖 120).

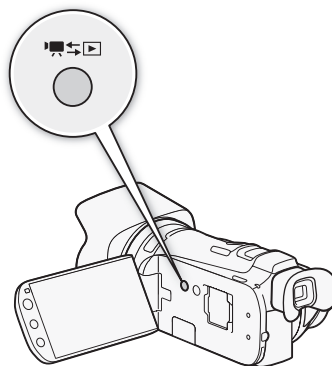

#### NOTES

- When switching to a playback mode, the memory selected for playback will be the same currently used for recording.
- You can also press and hold  on the wireless controller for more than 2 seconds to switch between recording and playback mode.

## Using the Menus

Many of the camcorder's functions can be adjusted from the FUNC. panel and the setup menus. For details about the available menu options and settings, refer to the appendix *Menu Options Lists* (138).

### FUNC. Panel

Operating modes: **AUTO** **M** CINEMA |  

The FUNC. panel shows a convenient overview of frequently used shooting functions. Touch [FUNC.] to access the FUNC. panel and then touch the function you want to set or adjust. You may need to drag your finger up and down the screen to find the control button of the desired function. In **AUTO** mode, access to functions is limited.

FUNC. panel in **M** mode

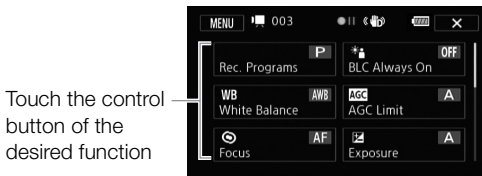

### Edit Panel

Operating modes: **AUTO** **M** CINEMA |  

Touch [Edit] to display a panel showing available operations (copying, deleting, etc.), and then touch the operation you want to perform.

Edit panel in  mode

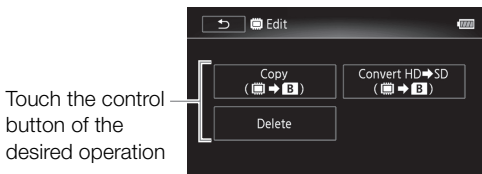

## Setup Menus

Operating modes: **AUTO**\* **M** **CINEMA** |  

\* In **AUTO** mode setup menu cannot be accessed and most menu settings will be reset to default values.

30

1 **M** or **CINEMA** mode only: Touch [FUNC.]

2 Touch [MENU] to open the setup menus.

- You can also press [MENU] on the wireless controller.

3 Touch the tab of the desired menu.

4 Drag your finger up and down to bring the setting you want to change into the orange selection bar.

- Menu items not available appear grayed out.
- You can touch any menu item on the screen to bring it directly into the selection bar.

5 When the desired menu item is inside the selection bar, touch the orange frame on the right.

6 Touch the desired option and touch [X].

- You can touch [X] to close the menu at any time.

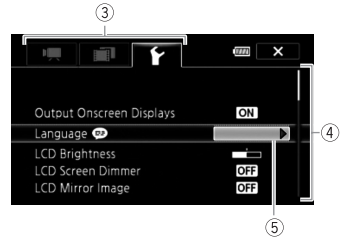

### NOTES

- For brevity's sake, references in the text to settings in the setup menu will include only the tab of the desired menu and the setting name. For example, "You can adjust the date and time later on with the  [Date/Time] setting."

## First Time Settings



### Setting the Date and Time

You will need to set the date and time of the camcorder before you can start using it. The [Date/Time] screen will appear automatically when the camcorder's clock is not set.



- 1 Press **[POWER]** to turn on the camcorder.
  - The [Date/Time] screen appears and the year will be selected.
- 2 Touch a field you want to change (year, month, day, hours or minutes).
- 3 Touch **[▲]** or **[▼]** to change the field as necessary.
- 4 Set the correct date and time by changing all the fields in the same way.
- 5 Touch [Y.M.D], [M.D.Y] or [D.M.Y] to select the date format you prefer.
  - In some screens, the date will be displayed in short form (numbers instead of month names or only the day and month), but it will still follow the order you selected.
- 6 Touch [24H] to use 24-hour clock or leave it unselected to use 12-hour clock (AM/PM).
- 7 Touch **[OK]** to start the clock and close the setup screen.

#### NOTES







- You can adjust the date and time later on with the   [Date/Time] setting.
- When you do not use the camcorder for about 3 months, the built-in rechargeable lithium battery may discharge completely and the date and time setting may be lost. In such case, recharge the built-in lithium battery ( 167) and set the time zone, date and time again.

### Changing the Language

The default language of the camcorder is English. You can set it to one of 27 languages.



Operating modes: **[AUTO]** **[M]** **[CINEMA]** |  

- 1 Open the [Language ] screen.  
[FUNC.]  [MENU]    [Language ]
- 2 Touch the desired language and then touch **[X]**.

#### NOTES

- Some control buttons, such as [ZOOM], [FUNC.] and [MENU], will appear in English regardless of the language selected.

## Changing the Time Zone

Change the time zone to match your location. The default setting is New York. In addition, the camcorder is able to retain the date and time of an additional location. This is convenient when you travel so that you can set the camcorder to match the time of your home location or that of your travel destination.



Operating modes:    |  



32

1 Open the [Time Zone/DST] screen.

[FUNC.] ➤ [MENU] ➤  ➤ [Time Zone/DST]

- Touching [FUNC.] is necessary only when performing the procedure in a recording mode.

2 Touch [] to set the home time zone, or [] to set the time zone of your destination when you are traveling.

3 Touch [] or [] to set the desired time zone. If necessary, touch [] to adjust for daylight saving time.

4 Touch [] to close the menu.









## Using a Memory Card

### Memory Cards Compatible for Use with the Camcorder

You can use the following types of commercially available Secure Digital (SD) cards with this camcorder.

As of December 2012, the movie recording function has been tested using SD/SDHC/SDXC memory cards made by Panasonic, Toshiba and SanDisk. For the latest information on cards that can be used, visit your local Canon Web site.

33

Memory card type:  SD memory card,  SDHC memory card,  SDXC memory card  
 SD Speed Class\*:  CLASS 2  CLASS 4  CLASS 6  CLASS 10  
 Capacity: 128 MB or larger\*\*.

\* When using an SD memory card without a speed class rating or one rated SD Speed Class 2, you may not be able to record movies, depending on the memory card used.

\*\*SD memory cards with a capacity of 64 MB or smaller cannot be used to record movies.

#### NOTES

- **About the Speed Class:** Speed Class is a standard that indicates the minimum guaranteed data transfer speed of memory cards. When you buy a new memory card, look for the Speed Class logo on the package.

We recommend using memory cards rated SD Speed Class 4, 6 or 10.

### SDXC Memory Cards

You can use SDXC memory cards with this camcorder. When using memory cards with other devices, such as digital recorders, computers and card readers, **make sure that the external device is compatible with SDXC cards**. For information about the compatibility of SDXC cards, contact the computer, operating system or memory card manufacturer.

#### IMPORTANT

- If you use an SDXC memory card with a computer OS that is not SDXC-compatible, you may be prompted to format the memory card. In such case, **cancel the operation to prevent data loss**.
- After repeatedly recording, deleting and editing scenes (fragmented memory), it will take longer to write data on the memory and recording may stop. Save your recordings and initialize the memory using the camcorder.

### Eye-Fi Cards

This product is not guaranteed to support Eye-Fi card functions (including wireless transfer). In case of an issue with an Eye-Fi card, please check with the card manufacturer.

Also note that an approval is required to use Eye-Fi cards in many countries or regions. Without approval, use of the card is not permitted. If it is unclear whether the card has been approved for use in the area, please check with the card manufacturer.

## Inserting and Removing a Memory Card

Make sure to initialize (☞ 36) all memory cards before using them with this camcorder.

### 1 Turn off the camcorder.

- Make sure the ON/OFF (CHG) indicator is off.

### 2 Open the double memory card slot cover.

### 3 Insert the memory card straight, with the label facing the front of the camcorder, all the way into one of the memory card slots until it clicks.

- You can also use two memory cards, one in each memory card slot.
- To use the wireless communication features of an Eye-Fi card, insert it into memory card slot **B**. Be sure you understand the information provided in *Eye-Fi Cards* (☞ 33) before using an Eye-Fi card.

### 4 Close the double memory card slot cover.

- Do not force the cover closed if the memory card is not correctly inserted.

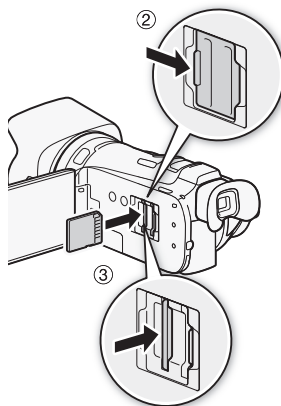

## To remove the memory card

Push the memory card once to release it. When the memory card springs out, pull it all the way out.

### ! IMPORTANT

- Observe the following precautions while the ACCESS indicator is flashing. Failure to do so may result in permanent data loss.
  - Do not disconnect the power source or turn off the camcorder.
  - Do not remove the memory card.
- Turn off the camcorder before inserting or removing a memory card. Inserting or removing the memory card with the camcorder on may result in permanent data loss.
- Memory cards have front and back sides that are not interchangeable. Inserting a memory card facing the wrong direction can cause a malfunction of the camcorder. Be sure to insert the memory card as described in step 3.

## Selecting the Memory for the Recordings

You can select to record your movies and photos in the built-in memory or on a memory card. The default memory for recording both is the built-in memory.

Operating modes: **AUTO** **M** **CINEMA** | **[Rec Media for Photos]**\* **[Movie]**

\* Only [Rec Media for Photos] is available from the date index screen or gallery.

### ✓ POINTS TO CHECK

- Be sure you understand the information provided in *Eye-Fi Cards* (☞ 33) before using an Eye-Fi card.

### 1 Open the [Rec Media for Movies] or [Rec Media for Photos] screen.

[FUNC.] ➤ [MENU] ➤  ➤ [Rec Media for Movies] or [Rec Media for Photos]

- Touching [FUNC.] is necessary only when performing the procedure in a recording mode.

### 2 Touch (built-in memory), [A] (memory card **A**) or [B] (memory card **B**) and then touch .

- When selecting the memory, you can check the approximate available recording time/number of photos, based on currently used settings.
- In recording mode, after closing the menu, the icon of the selected memory will appear on the screen.



35

### NOTES

- Select to record movies in the built-in memory or memory card **A** if you later want to convert the movies to standard definition in order to upload them to the Web.

## Relay Recording

You can activate relay recording so if the memory you are using becomes full while recording movies, the recording will continue uninterrupted on a memory card.



When recording on memory card **A**, you can use memory card **B** for relay recording (). When recording in the built-in memory, you can choose to use only memory card **A** for relay recording (), or use both memory cards (.

Operating modes:    |  



### 1 Insert a memory card that contains no video recordings into the card slot of the memory card you want to use for relay recording.

- When relay recording from the built-in memory: memory card slot **A** or both memory card slots.
- When relay recording from memory card **A**: memory card slot **B** only.

### 2 Open the [Relay Recording] screen.

[FUNC.] ➤ [MENU] ➤  ➤ [Rec Media for Movies] ➤  or [A] ➤ [Relay Recording]

### 3 Touch the desired option and then touch .

-  or  will appear on the screen and the approximate available recording time will now reflect the combined space in the memories used for relay recording.

### NOTES

- You cannot use relay recording from the built-in memory to memory card **B**. When using a single memory card, be sure to insert it into memory card slot **A**.
- There will be a momentary stop in the scene at the point where the camcorder switches from one memory to another.
- Any of the following actions will deactivate the relay recording function:
  - Turning off the camcorder.
  - Opening the double memory card slot cover.
  - Changing the camcorder's operating mode.
  - Changing the memory used for recording movies.

## Double Slot Recording

Double slot recording allows you to record the same scene simultaneously to both memory cards. This is a convenient way to make a backup copy of your recording while you record.

Operating modes:    |  

1 Insert memory cards into memory card slot **A** and memory card slot **B**.

2 Open the [Rec Media for Movies] screen.

[FUNC.] ➤ [MENU] ➤  ➤ [Rec Media for Movies]

3 Activate double slot recording.

[**A**] ➤ [Double Slot Rec] ➤ [**ON**]

4 Touch [**X**].

-  will appear on the screen.

### NOTES

- If a memory card becomes full during double slot recording, recording on both cards will stop.
- If an error occurs with one of the memory cards, recording will continue on the other card.

## Initializing the Memory

Initialize memory cards when you use them with this camcorder for the first time. You can also initialize a memory card or the built-in memory to permanently delete all the recordings it contains.

At the time of purchase, the built-in memory comes pre-initialized and contains music files for use as background music and images for use with the image mix function (image mix frames).

Operating modes:    |  

1 Power the camcorder using the compact power adapter.

- Do not disconnect the power source or turn off the camcorder until the initialization is completed.

2 Open the initialization screen for the desired memory.

[FUNC.] ➤ [MENU] ➤  ➤ [Initialize / ] ➤ [ Built-in Mem.], [**A** Mem. Card A] or [**B** Mem. Card B] ➤ [Initialize]

- Touching [FUNC.] is necessary only when performing the procedure in a recording mode.
- In the initialization screen, touch [Complete Initialization] to physically erase all the data rather than just clear the file allocation table of the memory.

3 Touch [Yes].

- If you selected the [Complete Initialization] option, you can touch [Cancel] to cancel the initialization while it is in progress. All recordings will be erased and the memory can be used without any problem.

4 Touch [OK] and then touch [**X**].

 IMPORTANT

- Initializing the memory will permanently erase all recordings. Lost original recordings cannot be recovered. Make sure you save important recordings in advance using an external device (📖 124).
- Initializing a memory card will permanently erase any music files and images you may have transferred to the card. (The music files and image mix frames that come pre-installed in the built-in memory will be restored after it is initialized.) To transfer music files from the supplied VIXIA CD-ROM to the memory card:
  - Windows users: Use the supplied software **VideoBrowser**. For details, refer to the Software Guide (PDF file) of the supplied PIXELA's software.
  - Mac OS users: Use Finder to transfer music files from the "MUSIC" folder on the supplied VIXIA CD-ROM to the memory card. Refer to *About the music files* (📖 178) for the folder structure of the memory card.
- At the time of purchase, Eye-Fi cards contain the necessary network configuration software. Be sure to install the software and complete the required configuration setup before you initialize the Eye-Fi card prior to using it with this camcorder.

# 3 Recording

## Recording Movies and Photos

By default, movies and photos are recorded in the built-in memory. You can select the memory that will be used to record movies and photos (📖 34).

38 Please read the IMPORTANT section (📖 43) before using an Eye-Fi card.

### 👉 POINTS TO CHECK

- **Before you begin recording**, make a test recording first to check that the camcorder is operating correctly.

## Preparing to Record

- 1 Attach a charged battery pack to the camcorder (📖 20).
- 2 Turn on the camcorder.
- 3 Select the memory for recording (📖 34).
  - To use relay recording (📖 35), insert a memory card into memory card slot **A** or both memory card slots.
  - To use double slot recording (📖 36), insert memory cards into both memory card slots.
- 4 Open the lens barrier.
  - Set the lens barrier switch to OPEN.
- 5 If you need to use the viewfinder, pull it out and, if necessary, adjust it using the diopter adjustment lever.

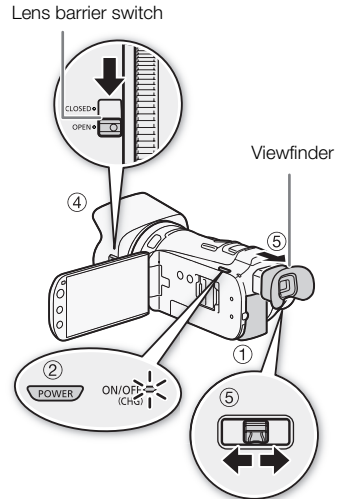

## Recording in AUTO Mode

When you use **AUTO** mode to shoot video and take photos, the camcorder will automatically adjust various settings for you.

Operating modes: **AUTO** **M** **CINEMA** |  

- 1 Set the mode switch to **AUTO**.
- 2 Turn on the camcorder.

### To record video

Press **START/STOP** to begin recording.

- During recording, ● will appear on the screen.
- The ACCESS indicator will flash from time to time while the scene is being recorded.
- Press **START/STOP** again to pause the recording.
- You can also press **START/STOP** on the wireless controller.
- You can turn on the scene rating option in recording mode (  109).

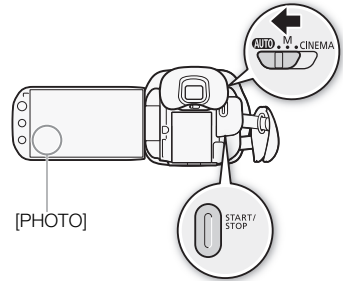

### To take photos

Touch **[PHOTO]**.

- A green icon (●) will appear momentarily on the screen and the ACCESS indicator will flash as the photo is recorded.
- You can record photos simultaneously while recording a movie. In that case, the green icon will not appear. Instead, the ► icon will appear momentarily in the upper right of the screen.
- You can also press **[PHOTO]** on the wireless controller.

### When you have finished recording

- 1 Set the lens barrier switch to **CLOSED** to close the lens barrier.
- 2 Make sure that the ACCESS indicator is off.
- 3 Turn off the camcorder.
- 4 Close the LCD panel and return the viewfinder to its retracted position.

### About AUTO mode





- Only the following functions are available in **AUTO** mode.
  - Quick Start (📖 44).
  - Zoom (📖 52).
  - Audio scenes other than [**♪** Custom Setting] (📖 68).
  - Video snapshot (📖 80).
  - Smart AUTO (see below)
  - Intelligent IS (see below)
  - Face detection (📖 49) to get beautiful shots of people every time, tracking the subject even if the person moves.
  - Touch & Track (📖 51) to track other moving subjects, keeping them in focus and using the best settings to record them.
  - Story Creator (📖 99) to transform your movies into compelling video stories by following simple scripts for various scenarios.
  - Decoration (📖 103) to add a fun personal touch using stamps, drawings, image mix and more.





### Smart AUTO

In **AUTO** mode, the camcorder will automatically detect certain characteristics of the subject, background, lighting conditions, etc. It will then adjust various settings (focus, exposure, color, image stabilization, image quality, among others), selecting the best settings for the scene you want to shoot. The Smart AUTO icon will change to one of the icons in the *Smart AUTO icons* table (📖 41).

### Intelligent IS































Intelligent IS allows the camcorder to select the best image stabilization option based on your shooting method. The Intelligent IS icon will change to one of the following icons. In **M** and **CINEMA** modes, you can set the image stabilization mode manually (📖 55).







Shooting method	Icon
Most general situations; Zooming out (zooming toward <b>W</b> ); Following subjects at a distance moving left or right	 (Dynamic IS)
Zooming in (zooming toward <b>T</b> )	 (Powered IS)*
Close-up of a subject	 (Macro IS)
Remaining stationary, such as when using a tripod	 (Tripod mode)

\* With the [FUNC.]  [IS Intelligent IS] setting, you can select whether Powered IS can be set automatically as one of the Intelligent IS modes ( With  or  Without ).



## Smart AUTO icons

Background (color of the icon) →	Bright <sup>1</sup> (gray)	Blue skies <sup>1</sup> (light blue)	Vivid colors <sup>1</sup> (green/red)	Sunsets <sup>1</sup> (orange)
Subject ↓				
People (stationary)	 (  )	 (  )	 (  )	—
People (moving)	 (  )	 (  )	 (  )	—
Subjects other than people, such as landscapes	 (  )	 (  )	 (  )	
Close objects	 /  <sup>2</sup> (  /  <sup>2</sup> )	 /  <sup>2</sup> (  /  <sup>2</sup> )	 /  <sup>2</sup> (  /  <sup>2</sup> )	—

Background (color of the icon) →	Dark (dark blue)		
Subject ↓	Spotlight	Night scene	
People (stationary)		—	—
People (moving)		—	—
Subjects other than people, such as landscapes			
Close objects	 /  <sup>2</sup>	—	—









<sup>1</sup> The icon in parentheses appears under backlight conditions.

<sup>2</sup> This icon will appear under tele macro conditions. Tele macro is activated automatically when you zoom toward the telephoto end and close in on the subject. Tele macro allows you to get closer shots of small subjects and adds a soft focus to the background, so the subject not only looks larger but also stands out more.

### ! IMPORTANT

- Observe the following precautions while the ACCESS indicator is on or flashing. Failing to do so may result in permanent data loss or damage to the memory.
  - Do not open the double memory card slot cover.
  - Do not disconnect the power source or turn off the camcorder.
  - Do not change the camcorder's operating mode.
- Be sure to save your recordings regularly (📖 124), especially after making important recordings. Canon shall not be liable for any loss or corruption of data.
- If supported recordings were made on an Eye-Fi card in memory card slot **B**, wireless upload will start automatically after setting the camcorder to playback mode, if you are within the range of a configured network. Always verify that Eye-Fi cards have been approved in the country/region of use. See also *Using an Eye-Fi Card* (📖 136).

## NOTES

- **About the power saving mode:** If   [Power Saving Mode]  [Auto Power Off] is set to **[ON On]**, the camcorder will shut off automatically to save power when it is powered by a battery pack and is left without any operation for 5 minutes. Press **[POWER]** to turn on the camcorder.
- When recording in bright places, it may be difficult to use the LCD screen. In such cases, you can turn on the LCD backlight ( 24) or adjust the brightness of the LCD screen with the   [LCD Brightness] setting. Alternatively, you can also use the viewfinder ( 22).
- Under certain conditions, the Smart AUTO icon that appears on the screen may not match the actual scene. Especially when shooting against orange or blue backgrounds, the sunset or one of the blue skies icons may appear and the colors may not look natural. In such case, we recommend recording in **[M]** mode ( 42).
- Photos are recorded as JPG files. The photo size (1920x1080) and quality cannot be changed. At this size, a 1 GB memory card can hold approximately 670 photos. However, the actual number of photos that can be recorded will vary depending on the subject and shooting conditions.
- Photos cannot be recorded while the digital zoom is activated, during double slot recording or while fading in or fading out a scene.
- When you need to record for a long time with the camcorder set on a tripod (a school recital, for example), you can close the LCD panel and use only the viewfinder in order to save power when using a battery pack ( 22).

## Recording in **M** (Manual) Mode

When the mode switch is set to **M** (Manual mode), you can enjoy full access to the menus and manually adjust the exposure, focus, white balance and many more of the camcorder's settings to your preference. Even in **[M]** mode, though, the camcorder can help you with the settings. For example, by using Special Scene recording programs ( 64).

Operating modes:  **[M]**  |  

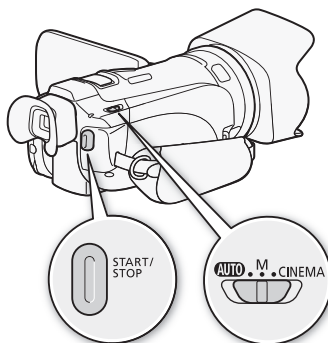

- 1 Set the mode switch to **M**.
- 2 Turn on the camcorder.
- 3 Record movies and photos.
  - The procedure is the same as in **[AUTO]** mode ( 39).



## Reviewing the Latest Scene Recorded

You can review the last 4 seconds of the last scene recorded with the camcorder without switching to playback mode. While reviewing the latest scene, the picture will be played back without sound.

Operating modes:    |  



- 1 Set the mode switch to **M** or **CINEMA**.
- 2 Review the last 4 seconds of the scene.  
[FUNC.]  [ Review Recording]

43









### NOTES

- When double slot recording is activated, only the scene recorded on memory card **A** will be played back.

### IMPORTANT

- Observe the following precautions while the ACCESS indicator is on or flashing. Failing to do so may result in permanent data loss or damage to the memory.
  - Do not open the double memory card slot cover.
  - Do not disconnect the power source or turn off the camcorder.
  - Do not change the camcorder's operating mode.
- Be sure to save your recordings regularly (, especially after making important recordings. Canon shall not be liable for any loss or corruption of data.
- If supported recordings were made on an Eye-Fi card in memory card slot **B**, wireless upload will start automatically after setting the camcorder to playback mode, if you are within the range of a configured network. Always verify that Eye-Fi cards have been approved in the country/region of use. See also *Using an Eye-Fi Card* (.

### NOTES

- **About the power saving mode:** If   [Power Saving Mode]  [Auto Power Off] is set to [**ON** On], the camcorder will shut off automatically to save power when it is powered by a battery pack and is left without any operation for 5 minutes. Press **[POWER]** to turn on the camcorder.
- When recording in bright places, it may be difficult to use the LCD screen. In such cases, you can turn on the LCD backlight () or adjust the brightness of the LCD screen with the   [LCD Brightness] setting. Alternatively, you can also use the viewfinder (.
- When you need to record for a long time with the camcorder set on a tripod (a school recital, for example), you can close the LCD panel and use only the viewfinder in order to save power when using a battery pack (.

## Quick Start Function

When you close the LCD panel with the camcorder on, the camcorder enters the standby mode. In standby mode the camcorder consumes only about 1/3 the power used when recording, saving energy when you are using a battery pack. Additionally, when you open the LCD panel or pull out the viewfinder, the camcorder is ready to start recording in approximately 1 second\*, allowing you to record the subject right away.

\* The actual time required varies depending on the shooting conditions.

Operating modes: **AUTO** **M** **CINEMA** |  

### 1 With the camcorder on and in a recording mode, close the LCD panel.

- A beep will sound and the green ON/OFF (CHG) indicator will change to orange to indicate the camcorder entered standby mode.
- When using only the viewfinder (with the LCD panel closed), you can return the viewfinder to its retracted position to set the camcorder in standby mode.

### 2 When you wish to resume recording, open the LCD panel.

- The ON/OFF (CHG) indicator turns back green and the camcorder is ready to record.
- You can also pull out the viewfinder to start recording with the LCD panel closed.





#### IMPORTANT

- Do not disconnect the power source during standby mode (while the ON/OFF (CHG) indicator is lit in orange).



#### NOTES

- The camcorder will not enter standby mode while the ACCESS indicator is on or flashing, while the setup menus are being displayed or while using the viewfinder. The camcorder may also not enter standby mode when the battery charge is too low. Check that the ON/OFF (CHG) indicator changes to orange.
- **About standby mode and auto power off:**
  - The camcorder will power off automatically if left in standby mode for 10 minutes. Press **POWER** to turn on the camcorder.
  - You can select the length of time until auto power off or turn off the Quick Start function altogether with the   [Power Saving Mode]  [Quick Start (Standby)] setting.
  - The usual 5-minute auto power off setting of [Power Saving Mode] is not applicable while the camcorder is in standby mode.
- Changing the position of the mode switch while the camcorder is in standby mode will reactivate the camcorder in the operating mode selected.

## Selecting the Video Quality (Recording Mode)

The camcorder offers 5 recording modes. Changing the recording mode will change the recording time available on the memory. Select MXP or FXP mode for better movie quality; select LP mode for longer recording times. The following table gives approximate recording times.

Operating modes:    |  

1 Open the [Recording Mode] screen.

[FUNC.] ➤ [MENU] ➤  ➤ [Recording Mode]

2 Touch the desired recording mode and then touch [X].

### NOTES

- Movies recorded in MXP mode cannot be saved on AVCHD discs. Use an external Blu-ray Disc recorder to copy MXP movies onto Blu-ray discs or use the supplied software **VideoBrowser** to create AVCHD discs\*.
- The camcorder uses a variable bit rate (VBR) to encode video so the actual recording times will vary depending on the content of the scenes.
- The camcorder retains the last setting used even if you set the camcorder to  mode.

\* MXP scenes will be converted to an image quality similar to that of FXP scenes.

### Approximate recording times

◆ Default value

Recording mode → Memory ↓	MXP <sup>1</sup>	FXP <sup>1</sup> , ◆	XP+	SP	LP
4 GB Memory card	20 min.	30 min.	40 min.	1 hr. 10 min.	1 hr. 30 min.
8 GB Memory card	40 min.	1 hr.	1 hr. 25 min.	2 hr. 20 min.	3 hr.
16 GB Memory card	1 hr. 25 min.	2 hr. 5 min.	2 hr. 50 min.	4 hr. 45 min.	6 hr. 5 min.
32 GB Memory card/ Built-in memory <sup>2</sup>	2 hr. 55 min.	4 hr. 10 min.	5 hr. 45 min.	9 hr. 35 min.	12 hr. 15 min. <sup>3</sup>

<sup>1</sup> Recorded in 1920 x 1080 resolution. Movies recorded using other recording modes are recorded in 1440 x 1080 resolution.

<sup>2</sup> At the time of purchase, the built-in memory contains about 70 MB of music files (background music) and 5 MB of image files (image mix frames).

<sup>3</sup> A single scene can be recorded continuously for 12 hours; at that point, the camcorder will stop for about 3 seconds before resuming recording.

## Selecting the Frame Rate

You can change the frame rate (the number of frames recorded per second) to change the look of your movies.

Operating modes:    |  

1 Open the [Frame Rate] screen.

[FUNC.] ➤ [MENU] ➤  ➤ [Frame Rate]

2 Touch the desired frame rate and then touch [X].

### Options

**[60i 60i (Standard)]** 60 fields per second, interlaced. Standard frame rate of NTSC analog TV signals.

**[PF30 PF30]** Shooting at 30 frames per second, progressive\*. Use this frame rate to easily edit your recordings, for example, to post them on the Web.

**[PF24 PF24]** Shooting at 24 frames per second, progressive\*. Using this frame rate will give your recordings a cinematic look. Recording in  mode will further enhance the effect.

**[24P 24P]** 24 frames per second, progressive. Using this frame rate will achieve the same cinematic look as **[PF24 PF24]**, the difference being that video is recorded as true 24p.

\* Recorded as 60i.

### NOTES

- Movies recorded with the **[24P 24P]** frame rate cannot be converted to standard definition using the camcorder. If you want to upload your movies to video sharing Web sites, set the frame rate to **[PF24 PF24]** or convert the movies to standard definition using the supplied software **VideoBrowser**.

## Focus Adjustment

You can adjust the focus manually and use the peaking function to assist you or you can let the camcorder focus for you by using autofocus. With autofocus, you can set the autofocus speed. The camcorder also features two more focusing functions, face detection and Touch & Track.

Operating modes: **AUTO** **M** **CINEMA** |  



### POINTS TO CHECK

- Adjust the zoom before you start the procedure.

## Manual Focus

Use the focus ring to focus manually. You can also use peaking to help you focus more accurately.

### 1 Open the focus controls.

[FUNC.] ➤ [Focus]





- To switch to autofocus without opening the focus controls, press **AF/MF**. In such case, Touch AF (step 3) will not be available. Skip directly to step 4.

### 2 Touch **[MF]**.

### 3 Touch a subject that appears inside the frame.

- The Touch AF mark () will flash and the focusing distance will be adjusted automatically. You have the option to further adjust the focus manually as necessary.

### 4 If necessary, turn the focus ring to further adjust the focus.

- The center of the screen will be magnified to help you focus more easily. You can also turn off this function with the  ➤ [Focus Assistance] setting.
- The focusing distance displayed will change as you adjust the focus. You can change the units used for the distance display with the  ➤ [Distance Units] setting.
- You can use the  ➤ [Focus Ring Response] setting to adjust the sensitivity of the focus ring.
- You can use the  ➤ [Focus Ring Direction] setting to select which direction to turn the focus ring.

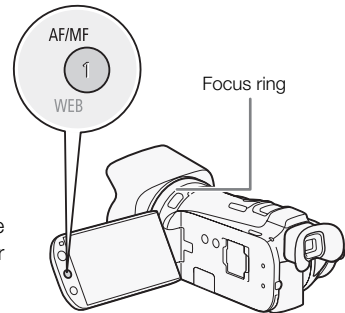

## Focus Preset

When focusing manually, you can set a preset position for the focus in advance so that you can later return to that preset focus position instantly.

### 1 Open the focus controls.



[FUNC.] ➤ [Focus]

### 2 Touch **[MF]**.

### 3 Use Touch AF or turn the focus ring to obtain the desired focus position.

### 4 Touch **[SET]** to set the preset focus position.

5 After adjusting the focus, touch [ON] to return to the preset focus position.

- Touch [SET] again to cancel the current preset focus position.
- [ON] will be grayed out while adjusting the focus or zoom.
- You can use the   [Focus Preset Speed] setting to adjust the speed at which the camcorder returns to the preset focus position.

 NOTES

- The preset focus position will be canceled when the camcorder is turned off.
- When the camcorder is in **AUTO** mode, the focus preset function cannot be used.

### Peaking

When peaking is activated, the edges of objects in focus will be highlighted in red, blue or yellow on the screen. In addition, you can choose to switch the screen to black & white, further emphasizing the edges.

1 Open the focus controls.

[FUNC.]   Focus]



2 Touch .

For the black & white setting: Touch [Off] or [On]

For the peaking color: Touch [Red], [Blue] or [Yellow]

3 Touch .

4 Touch .

- Peaking is activated and edges are highlighted. You can turn the focus ring on this screen or touch  to hide the focus controls.
- Touch  again to turn off the peaking effect.

 NOTES

- The peaking effect and black & white picture will not appear in your recordings.

### Autofocus

When autofocus is activated, the camcorder continuously adjusts the focus on the subject in the center of the screen. The focusing range is 2 cm (0.8 in.; at full wide-angle, measured from the front of the lens barrel) to  $\infty$  and 60 cm (2 ft.; throughout the zoom range, measured from the front of the lens barrel) to  $\infty$ . Perform the following procedure to set the autofocus speed.

1 Open the [AF Mode] screen.

[FUNC.]  [MENU]   [AF Mode]

2 Touch the desired option and then touch .

- The icon of the selected option appears on the screen.



**Options** ( Default value)

**[LAF Instant AF]** Sets the autofocus to Instant AF. The focus is adjusted at the highest speed. This mode is useful even when recording in very bright or low-light surroundings. This mode uses both the TTL system and external sensor for focusing.

**[MAF Medium AF]** Sets the autofocus to Medium AF. The camcorder focuses more smoothly on the subject than when using the **[LAF Instant AF]** setting. This mode uses both the TTL system and external sensor for focusing.

**[AF Normal AF]** Sets the autofocus to Normal AF. The autofocus adjustment is made at a stable speed.

**i** NOTES

- When recording in bright surroundings, the camcorder closes down the aperture. This may cause the picture to appear blurred and is more noticeable toward the wide angle end of the zoom range. In such case, select the **[Av Aperture-Pri. AE]** or **[M Manual Exposure]** recording program and set **[ND Filter]** to **[A Automatic]**.
- When you set **[Conversion Lens]** to a setting other than **[OFF Off]**, the **[LAF Instant AF]** and **[MAF Medium AF]** settings are not available.
- Autofocus takes longer to focus when the frame rate is set to **[PF30 PF30]**, **[PF24 PF24]** or **[24P 24P]** than when it is set to **[60i 60i (Standard)]**.
- When recording under dark conditions, the focusing range narrows and the picture may appear blurred.
- While using autofocus, you can turn the manual ring to focus manually. When you stop turning the ring, the camcorder returns to autofocus. This is useful in situations such as when focusing on a subject on the other side of a window.
- Autofocus may not work well on the following subjects or in the following cases. In such case, focus manually.
  - Reflective surfaces
  - Subjects with low contrast or without vertical lines
  - Fast moving subjects
  - Through dirty or wet windows
  - Night scenes

**Face Detection**

The camcorder automatically detects people's faces and uses this information to select the optimal focus and exposure settings.

Operating modes: **AUTO** \* **M** **CINEMA** | **[Night Scene]** **[Low Light]** **[Fireworks]** **[M Manual Exposure]**

\* Face detection is always activated in **AUTO** mode.

**✔** POINTS TO CHECK

- Select a recording program other than **[Night Scene]**, **[Low Light]**, **[Fireworks]** or **[M Manual Exposure]**.

By default, face detection is activated. If the function was turned off, perform the following procedure to turn it on.

1 Open the [Face Detection & Tracking] screen.

[FUNC.] ➤ [MENU] ➤ [Face Detection & Tracking]

2 Touch [ON] On [Face Detection & Tracking] and then touch [X].

50

### To select the main subject

If there is more than one person in the picture, the camcorder will automatically select one person it determines is the main subject. The main subject is indicated by a white face-detection frame and the camcorder will optimize the settings for that person. Other faces will have gray frames.

Touch a different face on the touch screen to optimize the camcorder's settings for that person using the Touch & Track function.

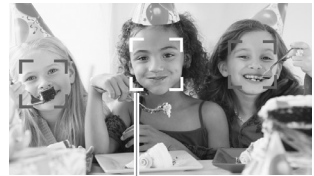

Main subject

### Limiting Autofocus to Faces

While using autofocus, you can limit the autofocus function only to cases when a subject's face is detected and use manual focus for all other scenes. The camcorder will also adjust the brightness when focusing automatically on the subject's face.

Set an assignable button to [Face Only AF] (85) and press the button.

- [Face Only AF] appears on the screen.

#### NOTES

- The camcorder may mistakenly detect the faces of non-human subjects. In such case, turn face detection off.
- In certain cases, faces may not be detected correctly. Typical examples include:
  - Faces extremely small, large, dark or bright in relation to the overall picture.
  - Faces turned to the side, at a diagonal or partially hidden.
- Face detection cannot be used in the following cases.
  - When the shutter speed used is slower than 1/30 (1/24 if the frame rate is set to [PF24 PF24] or [24P 24P]).
  - When the digital zoom is activated at more than 40x zoom (dark blue area on the zoom bar).
  - When [Scan Reverse Rec] is set to an option other than [OFF Off].
- When face detection is activated, the slowest shutter speed used by the camcorder is 1/30 (1/24 if the frame rate is set to [PF24 PF24] or [24P 24P]).

## Touch & Track

When recording a group of people using face detection, the camcorder will automatically detect one person as the main subject. You can use Touch & Track to tell the camcorder to track and optimize settings for a different person. You can also use Touch & Track to always keep in focus other moving subjects, such as pets or moving vehicles.

Operating modes: **AUTO** **M** CINEMA |  

### 1 Make sure face detection (📖 49) and autofocus (📖 48) are activated.

- Face detection is always activated in **AUTO** mode.

### 2 Point the camcorder at a moving subject and touch the subject on the touch screen.

- A white double frame will appear around the subject and track it as it moves.
- Touch [Cancel 



### NOTES

- Touching somewhere with a color or pattern unique to the subject will make it easier to track. However, if there is another subject in the vicinity that shares similar characteristics to the selected subject, the camcorder may start tracking the incorrect subject. Touch the screen again to select the desired subject.
- In certain cases, Touch & Track may not be able to track the subject. Typical examples include:
  - Subjects extremely small or large in relation to the overall picture.
  - Subjects too similar to the background.
  - Subjects lacking sufficient contrast.
  - Fast moving subjects.
  - When shooting indoors with insufficient lighting.

## Zooming

Operating modes: **AUTO** **M** **CINEMA** |  

There are three ways you can zoom in and out: using the zoom lever on the camcorder, using the zoom buttons on the wireless controller or using the zoom controls on the touch screen.

In addition to the 10x optical zoom, in **M** mode, you can turn on the digital zoom\* (40x or 200x) with the   [Digital Zoom] setting.

This camcorder also features a digital tele-converter, which allows you to enlarge the image on the screen digitally.

\* Digital zoom is not available in **AUTO** and **CINEMA** modes.

### Using the Zoom Lever or Wireless Controller

Move the zoom lever toward **W** (wide angle) to zoom out.

Move it toward **T** (telephoto) to zoom in.

- You can also use the zoom buttons on the wireless controller.
- By default, the zoom lever operates at a variable speed – press gently for a slow zoom; press harder for faster zooms.

### Setting the Zoom Speed

You can set the zoom speed for the zoom lever and wireless controller.

#### To set the zoom lever's zoom speed

For the zoom lever, first set the overall zoom speed to one of three levels. Next, select whether the zoom lever operates at a variable or constant speed. Refer to the following table for a summary of the zoom speed.

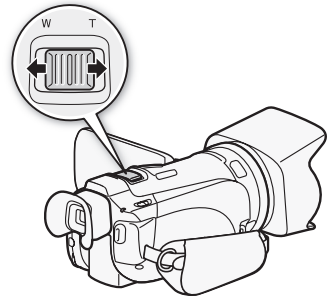





**W** Zoom out





**T** Zoom in



1 Open the [Zoom Speed Level] screen.

[FUNC.]  [MENU]    [Zoom Speed Level]

2 Touch  Fast],  Normal] or  Slow] and then touch .

3 Touch [Zoom Lever Zoom Speed].

4 Touch  VAR] for variable speed or  CONST] for constant speed.

- If you selected  CONST], touch  or  or drag your finger along the bar to select a constant speed.

5 Touch .

## Approximate zoom speeds\* (zoom lever)

[Zoom Lever Zoom Speed] setting	Selected constant speed	[Zoom Speed Level] setting		
		[>] Slow	[>>] Normal	[>>>] Fast
[VAR] (variable)	–	4 sec. to 4 min. 45 sec.	3 sec. to 3 min.	2 sec.** to 1 min.
[CONST] (constant)	1 (slowest)	4 min. 45 sec.	3 min.	1 min.
	16 (fastest)	4 sec.	3 sec.	2 sec.**

\* Measured from full wide-angle to full telephoto.

\*\*When the zoom speed is too fast (approximately 2 seconds end-to-end), the camcorder will have more trouble focusing automatically while zooming.

## To set the wireless controller's zoom speed

For the wireless controller, first set the overall zoom speed to one of three levels. The wireless controller operates at a constant speed that you can select. Refer to the following table for a summary of the zoom speed.

- 1 Open the [Zoom Speed Level] screen.  
[FUNC.] ➤ [MENU] ➤ [ ] ➤ [Zoom Speed Level]
- 2 Touch [>>>] Fast], [>>] Normal] or [>] Slow] and then touch [↔].
- 3 Touch [Wireless Ctrlr Zoom Speed].
- 4 Touch [↑] or [↓] or drag your finger along the bar to select the desired constant speed.
- 5 Touch [X].

## Approximate zoom speeds\* (wireless controller)

[Wireless Ctrlr Zoom Speed] setting	[Zoom Speed Level] setting		
	[>] Slow	[>>] Normal	[>>>] Fast
1 (slowest)	4 min. 45 sec.	3 min.	1 min.
16 (fastest)	4 sec.	3 sec.	2 sec.**

\* Measured from full wide-angle to full telephoto.

\*\*When the zoom speed is too fast (approximately 2 seconds end-to-end), the camcorder will have more trouble focusing automatically while zooming.

## Using the Touch Screen's Zoom Controls

- 1 Display the zoom controls on the touch screen.  
[FUNC.] ➤ [ZOOM]
  - The zoom controls appear on the left side of the screen.
- 2 Touch the zoom controls to operate the zoom.
  - Touch anywhere within the **W** area to zoom out or anywhere within the **T** area to zoom in. Touch closer to the center for a slow zoom; touch closer to the **W/T** icons for faster zooms.
- 3 Touch [X] to hide the zoom controls.



## Soft Zoom Control

Soft zoom control allows you to start and/or stop the zoom gradually.

1 Open the [Soft Zoom Control] screen.

[FUNC.] ➤ [MENU] ➤  ➤ [Soft Zoom Control]

2 Touch the desired option and then touch [X].

**Options** (\* Default value)

**[OFF Off]**\* Use this setting if you do not intend to use soft zoom control.

**[START Start]** Zoom starts gradually.

**[STOP Stop]** Zoom stops gradually.

**[START/STOP Start & Stop]** Zoom start and stops gradually.

## Digital Tele-Converter

Using the digital tele-converter, you can digitally increase the focal length of the camcorder by a factor of approx. 2 and record the enlarged image at full HD resolution.

Operating modes:    |  

1 Open the [Digital Zoom] screen.



[FUNC.] ➤ [MENU] ➤  ➤ [Digital Zoom]

2 Touch [ Digital Tele-conv.] and then touch [X].

3 Open the zoom controls.

[FUNC.] ➤ [ZOOM]

4 Touch [] (digital tele-converter) and then touch [X].

- The center of the screen will be enlarged approximately 2 times and the  icon will appear.
- Touch [] again before closing the screen to deactivate the digital tele-converter.

### NOTES

- You can attach the optional tele-converter and use it in conjunction with this function to increase the effect.
- The digital tele-converter cannot be turned on while recording.
- The image is digitally processed so the image will deteriorate throughout the zoom range.

## Advanced Image Stabilization

The image stabilizer reduces camcorder blur (blur due to the camcorder moving) so you can get nice, stable shots. Select the image stabilization mode according to the shooting conditions.

Operating modes:    |  

- 1 Open the [Image Stabilizer] screen.  
[FUNC.] ➤ [Image Stabilizer]
- 2 Touch the desired IS mode and then touch [X].



### Options <sup>(♦ Default value)</sup>

 **Dynamic**♦ Compensates for a higher degree of camcorder shake, such as when shooting while walking, and is more effective as the zoom approaches full wide angle.







 **Standard** Compensates for a lower degree of camcorder shake, such as when shooting while remaining stationary, and is suitable for shooting natural-looking scenes.

 **Off** Use this setting when the camcorder is mounted on a tripod.



### Powered IS

After setting an assignable button to  Powered IS] ( 85), you can use Powered IS to make the image stabilization even more powerful. Powered IS is most effective when you are stationary and zooming in on far subjects using high zoom ratios (the more you approach the telephoto end). Holding the LCD panel with your left hand will add to the stability of the shot.

Operating modes:    |  

- 1 Set an assignable button to  Powered IS] ( 85).
- 2 Press and hold the assignable button as long as you want to activate Powered IS.
  -  appears in yellow while Powered IS is activated.
  - You can change the operation of the assignable button set to  Powered IS] (long press or toggle on/off) with the  ➤ [POWERED IS Button] setting.
  - Powered IS is available even when [Image Stabilizer] is set to  Off].

### NOTES

- If the degree of camcorder shake is too high, the image stabilizer may not be able to fully compensate.
- For surveying and following shots, when you pan the camcorder from side to side or tilt it up and down, we recommend setting [Image Stabilizer] to  Dynamic] or  Standard].

## Automatic Gain Control (AGC) Limit

When recording in dark surroundings, the camcorder will automatically increase the gain to try to get a brighter picture. However, using higher gain values may result in more noticeable video noise. You can select the AGC limit to curb the amount of noise by setting the maximum gain value to be used. The smaller the AGC limit, the darker the picture but the less noise it will contain.

Operating modes:    |  



### POINTS TO CHECK

- Select a recording program other than the Special Scene recording programs or **[M Manual Exposure]**.

#### 1 Open the AGC limit adjustment screen.

[FUNC.] ➤ **[AGC AGC Limit]** ➤ **[M Manual]**

- Touch **[A Automatic]** to remove the AGC limit.

#### 2 Touch **[◀]** or **[▶]** to set the AGC limit.



- You can also drag your finger along the dial.

#### 3 Touch **[X]**.

- The selected AGC limit will appear on the screen.



### NOTES

- If you set  ➤ **[Custom Key/Dial]** to **[AGC AGC Limit]** ( 84), you can adjust the AGC limit with the CUSTOM dial.







## Automatic Exposure Recording Programs

With the automatic exposure (AE) recording programs, the camcorder will adjust the shutter speed and/or aperture value to obtain the optimal exposure. When using the AE recording programs, you can change functions like the white balance and image effects.

Operating modes:    |  

1 Open the screen of the desired recording program.

[FUNC.]  [Rec. Programs]  [TV Shutter-Pri. AE] or [AV Aperture-Pri. AE]

2 Touch [] or [] to set the desired shutter speed (TV) or aperture value (AV) and then touch [].

- You can also drag your finger along the dial.
- The selected shutter speed or aperture value will appear on the screen next to the recording program icon.

**Options**  Default value)

**[P Programmed AE]**  The camcorder automatically adjusts the aperture AE and shutter speed to obtain the optimal exposure for the subject.

**[TV Shutter-Pri. AE]** Set the shutter speed value. The camcorder automatically sets the appropriate aperture value.

**[AV Aperture-Pri. AE]** Set the aperture value. The camcorder automatically sets the appropriate shutter speed.



Available shutter speed settings

[1/8]	[1/15]	[1/30]	[1/60]	[1/100]
[1/250]	[1/500]	[1/1000]	[1/2000]	

Available shutter speed settings when the frame rate is set to **[PF24 PF24]** or **[24P 24P]**



[1/6]	[1/12]	[1/24]	[1/48]	[1/60]
[1/100]	[1/250]	[1/500]	[1/1000]	[1/2000]

Available aperture value settings

Because []  [ND Filter] is set to [**A** Automatic] by default, ND filter settings will be available for aperture values [F4.0] and higher.

[F1.8]	[F2.0]	[F2.2]	[F2.4]	[F2.6]	[F2.8]
[F3.2]	[F3.4]	[F3.7]	[F4.0]	[F4.4]	[F4.8]
[F5.2]	[F5.6]	[F6.2]	[F6.7]	[F7.3]	[F8.0]

 NOTES

- [TV Shutter-Pri. AE]:
  - On screen only the denominator is displayed – [TV 250] indicates a shutter speed of 1/250 second, etc.
  - When recording in dark surroundings, you can obtain a brighter picture by using slow shutter speeds; however, image quality may not be as good and autofocus may not work well.
  - The image may flicker when recording with fast shutter speeds.
  - **Recording movies under fluorescent lights:** If the screen starts to flicker, select [TV Shutter-Pri. AE] and set the shutter speed to 1/100.
- [Av Aperture-Pri. AE]: The actual range of values available for selection will vary depending on the initial zoom position.
- When setting a numeric value (aperture or shutter speed), the number displayed will flash if the aperture value or shutter speed is not appropriate for the recording conditions. In such case, select a different value.
- During exposure lock, the aperture value/shutter speed cannot be changed. Set the aperture value or shutter speed before manually adjusting the exposure.
- If you set  [Custom Key/Dial] to [ Tv / Av] ( 84), you can adjust the shutter speed or aperture value with the CUSTOM dial.

## Exposure Adjustment

At times, backlit subjects may appear too dark (underexposed) or subjects under very strong lights may appear too bright or glaring (overexposed). In such cases, adjusting the exposure will correct this. This camcorder features a dedicated recording program, **[M Manual Exposure]**, for adjusting the exposure manually. However, you can also compensate the exposure when using other recording programs.

### Using the Manual Exposure Recording Program

Using the **[M Manual Exposure]** recording program, you can adjust the aperture, shutter speed and gain to achieve the desired exposure.

Operating modes: **AUTO** **M** **CINEMA** |  

- 1 Activate the **[M Manual Exposure]** recording program.  
[FUNC.] ➤ [Rec. Programs] ➤ **[M Manual Exposure]**
- 2 Touch the control button of the setting you wish to adjust.

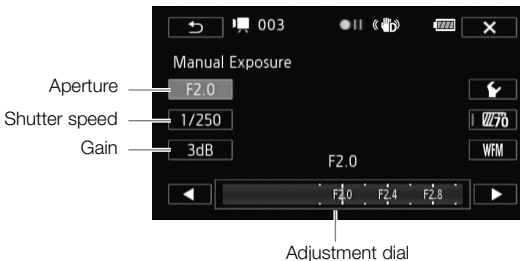

- 3 Touch **[◀]** or **[▶]** to set the desired value.
  - You can also drag your finger along the dial.
  - The exposure will change according to the setting's new value. Repeat steps 2 and 3 to adjust other settings.
  - Before touching **[X]**, you can also use the zebra pattern (see below) and waveform monitor (📖 79).
- 4 Touch **[X]**.

#### NOTES

- If you set  ➤ [Custom Key/Dial] to **[M Manual Exposure]** (📖 84), you can adjust the aperture, shutter speed and gain with the CUSTOM dial.

### Using the Zebra Pattern

You can use the zebra pattern to identify areas that might be overexposed, so you can correct the exposure appropriately. The camcorder offers two levels of zebra pattern: With 100% only areas that will lose detail in the highlight areas will be identified, while 70% will identify also areas that are dangerously close to losing detail.

- 1 From the exposure adjustment screen, touch [] to select the zebra level.
- 2 Touch [70%] or [100%] and then touch [].
- 3 Touch [] or [] and then touch [].
  - The zebra pattern will appear on the overexposed areas of the picture.
  - Touch again to turn off the zebra pattern.

NOTES

- Using the zebra pattern will not affect your recordings.

## Exposure Compensation

When you use a recording program other than [**M** Manual Exposure], the camcorder will adjust the exposure automatically. However, you can compensate and lock the exposure or use the Touch AE function to automatically set the optimal exposure for the subject you select. This is convenient when the brightness of the subject you want to shoot is noticeably brighter/darker than the general brightness of the image.

Operating modes: |

POINTS TO CHECK

- Select a recording program other than [ Fireworks] or [**M** Manual Exposure].

1 Open the exposure adjustment screen.

[FUNC.] [ Exposure]

2 Touch a subject that appears inside the frame.

- The Touch AE mark () will flash and the exposure will be adjusted automatically so the area you touched will be correctly exposed. You have the option to further adjust the exposure manually as necessary. Depending on the subject, you may want to use the [Highlights] setting as described below.
- You can touch [**M**] instead to compensate the exposure without activating the Touch AE function.
- The manual adjustment dial appears and the adjustment value is set at  $\pm 0$ .
- Touch [**M**] again to return the camcorder to automatic exposure.

3 Touch [] or [] or drag your finger along the dial to set the exposure compensation value.

- The adjustment range may vary depending on the initial brightness of the image, and some values may be grayed out.
- Before touching [], you can also use the zebra pattern ( 59) and waveform monitor ( 79).



4 Touch [] to lock the exposure at the selected value.

- During exposure lock, and the selected exposure compensation value will appear on the screen.



### To adjust the Touch AE function for highlights (Highlight AE)







Certain subjects, like clouds or white objects, are easily overexposed and can end up appearing as bright areas where all detail is lost. Using the [Highlights] setting, you can touch the brightest area inside the  frame and the camcorder will automatically make corrections so that area is not overexposed. When you touch a dark area in the picture or the highlights are too bright, the camcorder may not be able to correctly adjust the exposure.

After step 1 above:



- 1 Touch [.
- 2 Touch [Highlights] and then touch [].
  - Touch [Normal] to return the camcorder to normal Touch AE settings.

### To use backlight correction

When recording in situations in which the subject is constantly backlit, you can use backlight correction to make the entire picture brighter, especially dark areas. This will take precedence over the   [Auto Backlight Correction] setting, which is useful in situations in which the subject is not constantly backlit.

- 1 Open the [ BLC Always On] screen.  
[FUNC.]  [ BLC Always On]
- 2 Touch [ On] and then touch [].
  - Alternatively, you can set an assignable button to [ BLC Always On] ( 85). In that case, press the assignable button to turn the backlight correction on and off.

### NOTES

- If the recording program is changed during exposure lock, the camcorder will return to automatic exposure.
- You can adjust the exposure compensation value with the CUSTOM dial ( 84), which is set to [ Exposure] by default.

## White Balance

The white balance function helps you to accurately reproduce colors under different lighting conditions.

Operating modes:    |  



### POINTS TO CHECK

- Select a recording program other than the Special Scene recording programs.

#### 1 Open the white balance screen.

[FUNC.] ➤ [WB White Balance]

#### 2 Touch the desired option and then touch [X].

- When you select [**K** Color Temperature], [Set 1] or [Set 2], set the color temperature or a custom white balance with the appropriate procedure below before touching [X].
- The icon of the selected option will appear on the screen.

#### To set the color temperature ([**K** Color Temperature])

Touch [◀] or [▶] to set the desired value.

- You can also drag your finger along the dial.

#### To set a custom white balance ([Set 1] or [Set 2])

Point the camcorder at a white object, so it fills the whole screen, and touch [Set WB].

When the adjustment is completed,  stops flashing and disappears. The camcorder will retain the custom white balance even if you turn it off.

#### Options (\* Default value)

[**AWB Automatic**]\* The camcorder automatically sets the white balance for natural looking colors.

[ **Daylight**] To record outdoors on a bright day.

[ **Shade**] To record in shaded places.

[ **Cloudy**] To record on a cloudy day.

[ **Fluorescent**] To record under warm white, cool white or warm-white-type (3-wavelength) fluorescent lighting.

[ **Fluorescent H**] To record under daylight or daylight-type (3-wavelength) fluorescent lighting.

[ **Tungsten**] To record under tungsten and tungsten-type (3-wavelength) fluorescent lighting.



[**K Color Temperature**] Allows you to set the color temperature between 2,000 K and 15,000 K.



[Set 1], [Set 2] Use the custom white balance settings, to make white subjects appear white under colored lighting.



### NOTES

#### • When you select a custom white balance:

- Set [] ➤ [Digital Zoom] to [**OFF** Off].
- Reset the white balance when you change locations or the lighting or other conditions change.
- Depending on the light source,  may keep flashing. The result will still be better than with [**AWB Automatic**].

- Using a custom white balance may provide better results in the following cases:
  - Changing lighting conditions
  - Close-ups
  - Subjects in a single color (sky, sea or forest)
  - Under mercury lamps, certain types of fluorescent lights and LED lights
- Depending on the type of fluorescent light, optimal color balance may not be obtained with [ Fluorescent] or [ Fluorescent H]. If the color looks unnatural, select [**AWB** Automatic] or a custom white balance setting.

## Special Scene Recording Programs

Recording in a very bright ski resort or capturing the full colors of a sunset or a fireworks display becomes as easy as selecting a Special Scene recording program.

Operating modes: **AUTO** **M** CINEMA | [Portrait] [Video]

1 Open the **SCN** recording programs screen.

[FUNC.] ► [Rec. Programs] ► **[SCN]** [Portrait]

2 Touch the desired recording program and then touch **[X]**.

**Options** (♦ Default value)

**[Portrait]** ♦ The camcorder uses a large aperture, to achieve a sharp focus on the subject while blurring the background.



**[Sports]** To record sports scenes such as tennis or golf.



**[Night Scene]** To record nightscapes with lower noise.



**[Snow]** To record in bright ski resorts without the subject being underexposed.



**[Beach]** To record on a sunny beach without the subject being underexposed.



**[Sunset]** To record sunsets in vibrant colors.



**[Low Light]** To record in low-light situations.













[ **Spotlight**] To record spotlit scenes.



[ **Fireworks**] To record fireworks.



### NOTES

- [ Portrait]/[ Sports]/[ Snow]/[ Beach]: The picture may not appear smooth during playback.
- [ Portrait]: The blur effect of the background increases the more you zoom in (**T**).
- [ Snow]/[ Beach]: The subject may become overexposed on cloudy days or in shaded places. Check the image on the screen.
- [ Low Light]:
  - Moving subjects may leave a trailing afterimage.
  - Picture quality may not be as good as in other modes.
  - White points may appear on the screen.
  - Autofocus may not work as well as in other modes. In such case, adjust the focus manually.
- [ Fireworks]: To avoid camcorder blur (blur due to the camcorder moving) we recommend using a tripod.

## Image Effects

You can adjust the color depth, brightness, contrast, and sharpness of the image.

Operating modes:    |  



### POINTS TO CHECK

66

- Select a recording program other than the Special Scene recording programs.

#### 1 Open the image effects screen.

[FUNC.]  [Image Effects]

#### 2 Touch [ON] and then touch [Color Depth], [Sharpness], [Contrast] or [Brightness].

- Select [OFF] to turn off the image effects.

#### 3 Touch [◀] or [▶] or drag your finger along the dial to adjust the effect level.

- + levels: richer colors, sharper image, stronger contrast, brighter image.
- levels: shallower colors, softer image, softer contrast, darker image.
- To adjust other parameters, touch  to return to the image effects screen. Touch the desired control button and repeat step 3.



#### 4 Touch [X] to save and apply the customized picture settings.

- **A**c will appear on the screen.

## Self Timer

Operating modes:    |  

\* For movies only.



- 1 Open the [Self Timer] screen.  
[FUNC.] ➤ [MENU] ➤  ➤ [Self Timer]
- 2 Touch [**ON** On ] and then touch [**X**].
  -  will appear on the screen.
  - Repeat, selecting [**OFF** Off], to turn off the self timer.

**Movies:** In record pause mode, press  on the camcorder or wireless controller. The camcorder starts recording after a 10-second countdown\*. The countdown appears on the screen.

**Photos:** In record pause mode, touch [PHOTO] or press  on the wireless controller. The camcorder will record the photo after a 10-second countdown\*. The countdown appears on the screen.

\* 2 seconds when using the wireless controller.

### NOTES

- Once the countdown has begun, any of the following actions will cancel the self timer.
  - Pressing , when recording movies.
  - Pressing  (on the wireless controller) or touching [PHOTO] (on the screen), when recording photos.
  - Turning off the camcorder.
  - Changing the camcorder's operating mode.
  - Closing the LCD panel to set the camcorder to standby mode.

## Audio Scenes and Other Audio Settings

You can have the camcorder optimize the audio settings of the built-in microphone by selecting the audio scene that matches your surroundings. This will greatly enhance the sense of "being there". Alternatively, you can select [🎵 Custom Setting] in order to adjust the camcorder's various audio settings to your liking.

See the following table for the settings used by each audio scene.

Operating modes: **AUTO** **M** **CINEMA** |  

### 1 Open the audio scene selection screen.

[FUNC.] ➤ [AUDIO Audio Scene]

### 2 Touch the desired option and then touch [✕].

- When you select [🎵 Custom Setting], customize the audio settings to your preference with the relevant procedures (see the reference pages in the following table).

### Options (♦ Default value)

[📺 Standard] To record most general situations. The camcorder records with standard settings.

[🎵 Music] To vibrantly record music performances and singing indoors.

[👤 Speech] Best for recording human voices and dialog.

[🌳 Forest and Birds] To record birds and scenes in forests. The camcorder clearly captures sound as it spreads.

[🔇 Noise Suppression] To record scenes while reducing noise from wind, passing vehicles and similar ambient sound. Ideal for recording at the beach or in places with a lot of noise.

[🎵 Custom Setting]♦ Allows you to adjust the audio settings to your liking. The settings that you can adjust are the [🔇 Mic. Level] setting in the FUNC. panel and the following settings in the [🔧] menu: [Auto Wind Screen], [Microphone Attenuator], [Built-in Mic Freq. Response] (audio equalizer), and [Built-in Mic Directionality].

### Settings for each audio scene

	[🔇 Mic. Level]	[Microphone Attenuator]	[Auto Wind Screen]	[Built-in Mic Freq. Response]	[Built-in Mic Directionality]
[📺 Standard]	[M] (manual): 70	[A] Automatic	[H] High	[NORM] Normal	[NORM] Normal
[🎵 Music]	[M] (manual): 70	[A] Automatic	[L] Low 	[LHB] Boost HF+LF Range	[2ch WIDE] Wide
[👤 Speech]	[M] (manual): 86	[A] Automatic	[H] High	[MB] Boost MF Range	[2ch MONO] Monaural
[🌳 Forest and Birds]	[M] (manual): 80	[A] Automatic	[H] High	[LC] Low Cut Filter	[2ch WIDE] Wide
[🔇 Noise Suppression]	[M] (manual): 70	[A] Automatic	[H] High	[LC] Low Cut Filter	[2ch MONO] Monaural
[🎵 Custom Setting]	Selected by user				
	(📖 69)	(📖 142)	(📖 71)	(📖 71)	(📖 70)

## NOTES

- Audio scenes cannot be selected in the following cases:
  - When an external microphone is attached to the mini advanced shoe.
  - When an external microphone is connected to the MIC terminal with  ➤ [Audio Mix] set to **[OFF Off]**.
- [**♪ Custom Setting**] is not available in **[AUTO]** mode. After setting [**AUDIO Audio Scene**] to [**♪ Custom Setting**], if the camcorder is then set to **[AUTO]** mode, this setting will change to [**♪ Standard**].

## Audio Recording Level

You can adjust the audio recording level of the built-in or an external microphone. You can display the audio level indicator while recording.

Operating modes: **[AUTO]** **[M]** **[CINEMA]** |  



## POINTS TO CHECK

- Set [**AUDIO Audio Scene**] to [**♪ Custom Setting**] ([book 68](#)).

### 1 Open the manual audio recording level adjustment screen.

[FUNC.] ➤ [**🔇 Mic. Level**] ➤ [**M Manual**]

- The audio level indicator and current audio recording level will appear on the screen.
- Touch [**A Automatic**] to return the camcorder to automatic audio recording levels.

Manual audio level adjustment

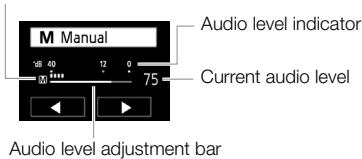

Audio level adjustment bar

### 2 Touch and hold [**◀**] or [**▶**] to adjust the audio recording level as necessary.

- As a guideline, adjust the audio recording level so that the audio level meter will go to the right of the -12 dB mark only occasionally.
- When  ➤ [Audio Mix] is set to **[ON On]**, two audio level indicators will appear; the top one ([INT]) for the built-in microphone, and the bottom one ([EXT]) for the external audio.

### 3 Touch [**✕**] to lock the audio recording level at the current level.

## To display the audio level indicator





Usually, the audio level indicator will be displayed only after activating the manual adjustment of the audio recording level. You can choose to display it also when the audio level is adjusted automatically.

### 1 Open the automatic audio recording level screen.

[FUNC.] ➤ [**🔇 Mic. Level**] ➤ [**A Automatic**]

### 2 Touch [Audio Level Indicator] and then touch [**✕**].

 NOTES



- When the audio level meter reaches the red point (0 dB), the sound may be distorted.
- We recommend using headphones to check the sound level while adjusting the audio recording level or when the microphone attenuator is activated.
- If you set   [Custom Key/Dial] to  Mic. Level] ( 84), you can adjust the microphone's audio recording level with the CUSTOM dial.

## Built-In Microphone Directionality

You can change the directionality of the built-in microphone to have more control over how sound is recorded.

Operating modes:    |  

 POINTS TO CHECK

- Set [AUDIO Audio Scene] to  Custom Setting] ( 68).





1 Open the [Built-in Mic Directionality] screen.

[FUNC.]  [MENU]    [Built-in Mic Directionality]

2 Touch the desired option and then touch [X].

### Options Default value)



 **Monaural** Mono recording that emphasizes sound coming from the front of the camcorder/microphone.

 **Normal**  Standard stereo recording; a middle point between the  Wide and  Monaural] settings in reach.

 **Wide** Stereo recording of ambient sound over a more extensive area that adds to the sense of presence of movies.

 **Zoom** Stereo recording with the sound linked to the zoom position. The larger the subject appears on the screen, the louder the sound will be.

 NOTES

- Except when using the audio mix function, an external microphone overrides the built-in microphone. In the following cases, the built-in microphone's directionality cannot be changed.
  - When an external microphone is connected to the MIC terminal with   [Audio Mix] set to  Off].
  - When an external microphone is attached to the mini advanced shoe.

## Audio Equalizer

You can use the audio equalizer to adjust sound levels by specifically targeting the high- or low-frequency range and selecting one of 3 available levels. The audio equalizer settings are only available when recording sound using the built-in microphone.

Operating modes: **AUTO** **M** **CINEMA** |  



### POINTS TO CHECK

- Set [AUDIO Audio Scene] to [🎵 Custom Setting] (📖 68).

- 1 Open the [Built-in Mic Freq. Response] screen.  
[FUNC.] ➤ [MENU] ➤  ➤ [Built-in Mic Freq. Response]
- 2 Touch the desired option and then touch [X].

### Options <sup>(♦ Default value)</sup>

**[NORM Normal]♦** Appropriate for balanced sound under most normal recording conditions.

**[LB Boost LF Range]** Accentuates the low-frequency range for more powerful sound.

**[LC Low Cut Filter]** Filters the low-frequency range to reduce the noise of blowing wind, a car's engine and similar ambient sounds.

**[MB Boost MF Range]** Best for recording human voices and dialog.

**[LHB Boost HF+LF Range]** Best, for example, for recording live music and clearly capture the special sound characteristics of a variety of instruments.



## Auto Wind Screen

The camcorder automatically reduces the background sound of wind when recording outdoors. You can select from two levels or turn off the auto wind screen.



### POINTS TO CHECK

- Set [AUDIO Audio Scene] to [🎵 Custom Setting] (📖 68).

- 1 Open the [Auto Wind Screen] screen.  
[FUNC.] ➤ [MENU] ➤  ➤ [Auto Wind Screen]
- 2 Touch the desired wind screen level and then touch [X].
  - Touch **[OFF Off]**  to turn off the auto wind screen.



### NOTES



- Some low-frequency sounds will be suppressed along with the sound of wind. When recording in surroundings unaffected by wind or if you want to record low-frequency sounds, we recommend setting [Auto Wind Screen] to **[OFF Off]** .

## Audio Mix

When recording, you can mix audio from the built-in microphone with external audio from the MIC terminal and adjust the mix balance for original sound effects. The external audio input can be from the optional WM-V1 Wireless Microphone, a commercially available external microphone or from an external audio player (analog Line In).

Operating modes:    |  

72

- 1 Connect the external source to the MIC terminal.
- 2 Open the [MIC Terminal Input] screen.  
[FUNC.] ➤ [MENU] ➤  ➤ [MIC Terminal Input]
- 3 Touch [**LINE** External Audio] or [**MIC** Microphone] and then touch [].
  - This step is not necessary after connecting the optional WM-V1 Wireless Microphone.
- 4 Activate the audio mix.  
[Audio Mix] ➤ [**ON** On]
- 5 Adjust the audio mix balance as necessary.
  - Touch [INT] (more of the sound from the built-in microphone) or [EXT] (more of the sound from the external audio) or drag your finger along the audio mix bar to adjust the mix balance as desired.
- 6 Touch [**X**] to set the audio mix and close the menu.



## Using Headphones

Use headphones for playback or to check the audio level while recording. The headphones are connected to the AV OUT/🎧 terminal, which is used for both the headphones and the audio/video output. Before connecting the headphones, follow the procedure below to change the function of the terminal from AV output to 🎧 (headphones) output. Do not connect the headphones to the AV OUT/🎧 terminal if the 🎧 icon does not appear on the screen. The noise output in such case may be harmful to your hearing.

Operating modes: **AUTO**\* **M** CINEMA | 📺 📷

\* Headphones can be used also in **AUTO** mode but the function of the terminal cannot be changed in this mode. Change the setting in advance in one of the other operating modes.

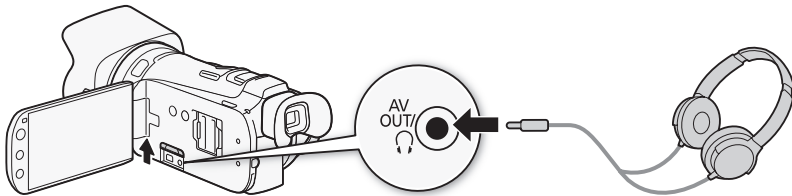

- 1 Open the [AV/Headphones] screen.  
[FUNC.] ➤ [MENU] ➤ [🔍] ➤ [AV/Headphones]
  - Touching [FUNC.] is necessary only when performing the procedure in a recording mode.
- 2 Touch [🎧 Headphones] and then touch [➡].
- 3 Connect the headphones to the AV OUT/🎧 terminal.
- 4 Back in the menu, touch [Volume].
- 5 Touch [🔊] or [🔊] to adjust the volume and then touch [X].
  - You can also drag your finger along the [Headphones] bar.
  - 🎧 will appear on the screen.

### To adjust the volume during playback

In 📺 mode, and in 📷 mode during slideshow playback, adjust the headphones volume the same way you adjust the speaker's volume (📖 88).

### ! IMPORTANT

- When using headphones, make sure to lower the volume to an appropriate level.

### i NOTES

- Use commercially available headphones with a Ø 3.5 mm minijack.
- Even if [AV/Headphones] was set to [🎧 Headphones] in a playback mode, the function of the AV OUT/🎧 terminal will return automatically to AV output when you turn off the camcorder.

## Using the Mini Advanced Shoe

Using the mini advanced shoe, you can attach to the camcorder a range of optional accessories to expand its functionality. For details about optional accessories available for use with your camcorder, refer to *Optional Accessories* (p. 170). For details about how to attach and use the accessories, refer also to the instruction manual of the accessory used.

- 1 Open the mini advanced shoe cover.
- 2 Attach the optional accessory to the mini advanced shoe.
  - When a compatible accessory is attached to the mini advanced shoe,  will appear on the screen.

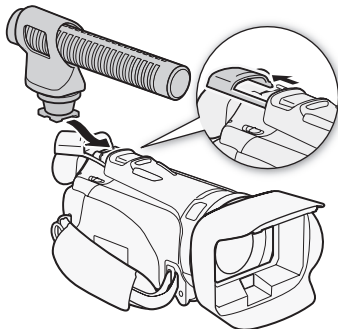

Example: Attaching an optional DM-100 Directional Stereo Microphone.

### NOTES

- Accessories designed for the Advanced Accessory Shoe cannot be used with this camcorder. Look for video accessories bearing this logo to ensure compatibility with the **mini advanced shoe**.



## Using an External Microphone

When recording in very quiet surroundings, the built-in microphone may pick up the sound of the camcorder's internal machinery. When recording outside, the built-in microphone may pick up excessive noise from wind. In such cases, we recommend using an external microphone with a wind screen.

### Using the SM-V1 Surround Microphone or DM-100 Directional Stereo Microphone

Using the SM-V1\* you can add a sense of depth and presence to your recordings with 5.1ch surround sound. Using the DM-100 you can accurately record audio coming directly from the direction you are recording. In either case, to reduce the amount of noise due to wind, we recommend that you use the wind screen supplied with the microphone.

\* When you use the optional SM-V1 Surround Microphone with this camcorder for the first time, you will need to update the camcorder's firmware using the memory card supplied with the SM-V1.

Operating modes: **AUTO** **M** **CINEMA** |  



Attach the optional SM-V1 Surround Microphone or DM-100 Directional Stereo Microphone to the mini advanced shoe.

Refer to *Using the Mini Advanced Shoe* (📖 74).

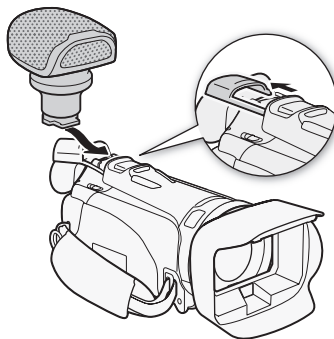
 will appear on the screen. For details about using the optional external microphone, refer to the instruction manual of the accessory used.



#### NOTES

- **When using the optional SM-V1 Surround Microphone:**
  - Change the microphone's directionality mode with the   [Surround Mic Directionality] setting.
  - You can enjoy the full effect of recordings made with 5.1ch surround sound on HDTVs compatible with 5.1ch surround sound connected to the camcorder using the supplied High Speed HDMI cable. Audio output from the AV OUT/ terminal (including headphone output) will be converted to 2ch stereo. The camcorder's built-in speaker is monaural.

## Using the WM-V1 Wireless Microphone

Using the WM-V1 you can reliably record sound even when recording subjects at a distance exceeding the practical range of the built-in microphone. You can also mix and record audio from the WM-V1 with audio from the built-in microphone. For details about using the WM-V1, refer to the instruction manual supplied with the microphone.

Operating modes: **AUTO** **M** CINEMA |  

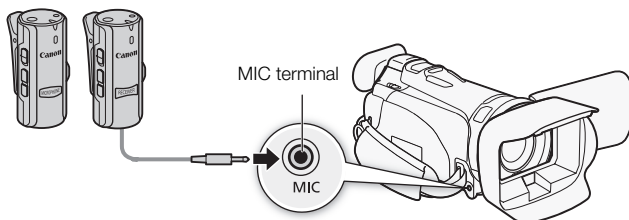

## Using Commercially Available Microphones

You can also use commercially available condenser microphones with their own power supply. You can connect almost any stereo microphone with a  $\varnothing$  3.5 mm plug but audio recording levels may vary.

Operating modes: **AUTO**\* **M** CINEMA |  

\* An external microphone can be used also in **AUTO** mode but the function of the terminal cannot be changed in this mode. Change the setting in advance in one of the other operating modes.

1 Connect the external microphone to the MIC terminal.

2 Open the [MIC Terminal Input] screen.



[FUNC.]  $\blacktriangleright$  [MENU]  $\blacktriangleright$    $\blacktriangleright$  [MIC Terminal Input]

3 Touch [**MIC** Microphone] and then touch [**X**].

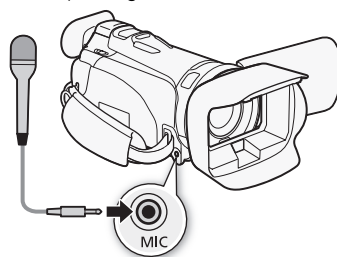
- If necessary, activate and adjust the audio mix balance (p. 72).



### NOTES

- When an external microphone is connected to the camcorder,   $\blacktriangleright$  [Auto Wind Screen] will automatically be set to [**OFF** Off ].
- If the audio level is too high and the sound gets distorted, adjust the audio recording level manually (p. 69).
- When using an external microphone, make sure that the jacket covering above the plug is smaller than  $\varnothing$  9.5 mm (0.37 in.).

## Using an External Video Light

You can use the optional VL-5 Video Light or VFL-2 Video Flash Light when you need to record movies in dark locations.

Operating modes:   CINEMA |  

Attach the optional video light to the mini advanced shoe.

- Refer to *Using the Mini Advanced Shoe* (□□ 74).
-  will appear on the screen when you turn on the optional video light (ON or AUTO). For details about using the optional video light, refer to the instruction manual of the accessory used.
- The optional VFL-2 Video Flash Light cannot be used as a flash with this camcorder.

## Color Bars/Audio Reference Signal

You can have the camcorder output and record color bars and a 1 kHz audio reference signal.

Operating modes:    |  

1 Open the [Color Bars & Test Tone] screen.

[FUNC.] ➤ [MENU] ➤  ➤ [Color Bars & Test Tone]

2 Touch the desired option and then touch [X].

**Options** (♦ Default value)

 Select this option if you do not intend to use the color bars or audio reference signal.

 **Color Bars** Displays a standard SMPTE color bar pattern.

 **Color Bars & Tone** In addition to the color bar pattern, an audio reference signal is output.





## Video Scopes

The camcorder can display a simplified waveform monitor. It can also display an edge monitor\* to help you focus. The video scopes appear only on the LCD screen. They do not appear in the viewfinder or on an external monitor.



\* The edge monitor looks at the focus of the entire picture and displays the results as a waveform.

Operating modes:    |  





### Displaying the Waveform Monitor during [P Programmed AE] Recording Program

- 1 Make sure the recording program is [P Programmed AE].  
[FUNC.] ➤ [Rec. Programs] ➤ [P Programmed AE]
- 2 Open the exposure adjustment screen.  
[FUNC.] ➤  Exposure
- 3 Touch [M] (manual adjustment) and then touch  (waveform monitor).
  - The waveform monitor will appear in a window on the screen. Touch the window to close it.
  - You can adjust the exposure using the dial at the bottom of the screen or by touching inside the  frame ( 60). You can see the results immediately in the waveform monitor.

### Displaying the Waveform Monitor during [M Manual Exposure] Recording Program

- 1 Open the [M Manual Exposure] screen.  
[FUNC.] ➤ [Rec. Programs] ➤ [M Manual Exposure]
- 2 Touch  (waveform monitor).
  - The waveform monitor will appear in a window on the screen. Touch the window to close it.
  - You can adjust the exposure by using the controls on the screen ( 59). You can see the results immediately in the waveform monitor.

### Displaying the Edge Monitor

- 1 Open the focus adjustment screen.  
[FUNC.] ➤  Focus
- 2 Touch [MF] (manual focus) and then touch  (waveform monitor).
  - The edge monitor will appear at the bottom of the screen. Touch the edge monitor to close it.
  - You can adjust the focus using the focus ring or by touching the inside the  frame ( 47). You can see the results immediately in the edge monitor.

## Video Snapshot

Record a series of short scenes. Then, play back your video snapshot scenes set to your favorite background music (📖 110).

The default length of a video snapshot scene is 4 seconds but you can change it to 2 or 8 seconds, or to the length recommended for the selected story scene (category) in Story Creator, with the [📷] ➤ [Video Snapshot Length] setting.

80

Operating modes: **AUTO** **M** **CINEMA** | [📺] [📺]

### 1 Open the [Video Snapshot] screen.

[FUNC.] ➤ [📷] Video Snapshot]

- Alternatively, you can set an assignable button to [📷] Video Snapshot] (📖 85). In that case, press the assignable button and continue to step 3.

### 2 Touch [ON On].

- A blue border appears on the screen.
- Touch [OFF Off] to return to normal video recording mode.

### 3 Press [START/STOP].

- The camcorder records for a few seconds (the blue frame serves as a visual progress bar) and then automatically returns to record pause mode.
- When the camcorder stops recording, the screen will momentarily turn black as if a camera shutter had released.

### NOTES

- Changing the camcorder's operating mode will deactivate the video snapshot mode.



## Pre-Recording

The camcorder will start recording 3 seconds before you press **[START/STOP]**, ensuring you do not miss important shooting opportunities. This is especially useful when it is difficult to predict when to start recording.

By default, the pre-recording function is assigned to assignable button 2.

Operating modes: **AUTO** **M** **CINEMA** |  

1 Press **[PRE REC]**.



-  will appear on the screen.
- Press **[PRE REC]** again to turn off pre-recording.

2 Press **[START/STOP]**.

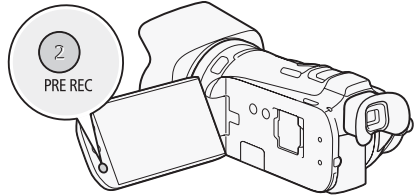
- The scene recorded in the memory will start 3 seconds before **[START/STOP]** was pressed.



### NOTES

- The camcorder will not record the full 3 seconds prior to pressing **[START/STOP]** if the button was pressed within 3 seconds of having turned on pre-recording or having finished the previous recording.
- Any of the following actions will deactivate the pre-recording function.
  - Leaving the camcorder without any operation for 1 hour.
  - Changing the position of the mode switch.
  - Pressing .
  - Activating video snapshot.
  - Opening the decoration screen.
  - Setting the camcorder to standby mode.
  - Touching any of the following control buttons in the FUNC. panel: **[MENU]**, **[Rec. Programs]**, **[WB White Balance]**, **[AGC AGC Limit]**, **[AUDIO Audio Scene]**, **[Image Stabilizer]**, **[Faders]**, **[ Decoration]** or **[ Review Recording]**.

## Onscreen Displays and Data Code

You can turn most onscreen displays on or off.

Operating modes: **AUTO** **M** **CINEMA** |  

Repeatedly press **DISP.** to turn the onscreen displays on/off in the following sequence:

82

**M**, **CINEMA** mode:

- All displays on
- Most displays off<sup>1</sup>

,  mode<sup>2</sup>:

- Only data code on
- All displays on

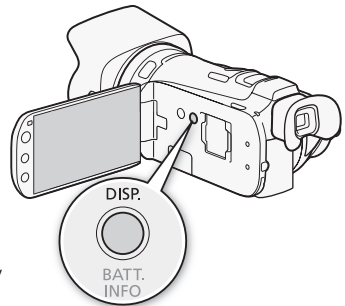

<sup>1</sup> Pressing **DISP.** will turn off most of the icons and displays that appear automatically but will not remove control buttons ([FUNC.], [PHOTO], etc.) and onscreen displays that were turned on manually (for example, onscreen markers or the audio level meter).

<sup>2</sup> In these modes, pressing **DISP.** has the same effect as touching the screen. During single photo view and while playing back a scene, the playback controls are displayed only momentarily.



### About the Data Code

With every scene or photo recorded, the camcorder keeps a data code (date/time of recording, information about the camera setup, etc.).

You can select the information to be displayed with the  /   [Data Code] setting.

## Faders

The camcorder offers two professional looking transition effects to fade-in or fade-out scenes. You have the option to activate the fader only one time or every time you start or stop recording.

Operating modes:    |  



### 1 Open the fader selection screen.

[FUNC.] ➤  Faders



### 2 Touch the desired fader and then touch [X].

- You can preview the transition effect on the screen.
- The icon of the selected fader appears in green.

### To fade in/out

Press  in record pause mode () to start recording with a fade in. Press  while recording () to fade out and pause the recording.

### NOTES

- When you apply a fader, not only the picture but also the sound will fade in or out.
- Faders cannot be used in the following cases:
  - While using the [Old Movies] cinema-look filter in  mode.
  - When recording scenes with decorations.
  - When recording video snapshot scenes.
  - While pre-recording is activated.
- You can select whether to fade to/from a black screen or a white screen with the  ➤ [Fader Setting] setting.

# 4 Customization

## Custom Button and Dial

You can assign to **CUSTOM** and the CUSTOM dial one of several frequently used functions. You can then adjust the selected function using **CUSTOM** and the CUSTOM dial, without having to access the menu.

Operating modes: **AUTO** **M** **CINEMA** |  

1 Open the [Custom Key/Dial] screen.

[FUNC.] ➤ [MENU] ➤  ➤ [Custom Key/Dial]

2 Touch the desired option and then touch [X].

**Options** (♦ Default value)

**[🔇 Mic. Level]** When you set [AUDIO Audio Scene] in the FUNC. panel to [🔊 Custom Setting], you can adjust the microphone's audio recording level. Press **CUSTOM** to display the audio level indicator and then use the CUSTOM dial to adjust the audio recording level.

**[📷 Tv/Av]** When you set the recording program to [TV Shutter-Pri. AE] or [Av Aperture-Pri. AE], you can adjust the shutter speed or aperture value with the CUSTOM dial.

**[M Manual Exposure]** When you set the recording program to [M Manual Exposure], repeatedly press **CUSTOM** to toggle between the aperture value, shutter speed and gain. Next, use the CUSTOM dial to adjust the setting.

**[AGC AGC Limit]** Adjusts the AGC limit. Press **CUSTOM** to display the current AGC limit value and then use the CUSTOM dial to adjust it.

**[☑ Exposure]♦** When using a recording program other than [🎆 Fireworks] or [M Manual Exposure], you can compensate the automatic exposure set by the camcorder. Press **CUSTOM** to display the exposure compensation value and then use the CUSTOM dial to adjust it.

**[OFF Off]** Use this setting if you do not intend to use **CUSTOM** or the CUSTOM dial.

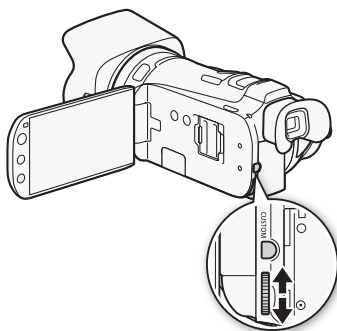

### NOTES

- Instead of the procedure above, you can press and hold **CUSTOM** to display a quick menu of the options. Use the CUSTOM dial to select an option and then press **CUSTOM**.

## Assignable Buttons

The camcorder conveniently features 2 buttons to which you can assign various functions. By assigning often used functions, you can quickly access them with a single press of a button.



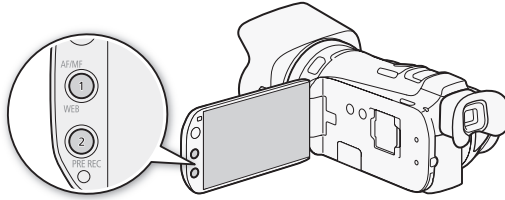



Operating modes: **AUTO** **M** **CINEMA** |  



### Changing the Assigned Function

- 1 Open the selection screen for the desired assignable button.  
[FUNC.] ➤ [MENU] ➤  ➤ [Assign Button 1] or [Assign Button 2]
- 2 Select the desired option and then touch [X].



**Options** (♦ Default value for assignable button 1, ♦♦ default value for assignable button 2)

- [ **Powered IS**] Turns Powered IS on/off (📖 55).
- [ **BLC Always On**] Turns backlight correction on/off (📖 61).
- [ **Face Only AF**] Turns face only autofocus on/off (📖 50).
- [ **Story Creator**] Activates Story Creator mode (📖 99).
- [ **Video Snapshot**] Turns video snapshot on/off (📖 80).
- [**WB WB Priority**] Turns white balance priority on/off (📖 148).
- [**AF/MF** AF/MF]♦ Switches between autofocus and manual focus (📖 47). This option is available only for assignable button 1.
- [ **Pre REC**]♦♦ Turns pre-recording on/off (📖 81). This option is available only for assignable button 2.
- [**OFF Off**] Does not assign a function to the assignable button.

### Using an Assignable Button

After you assign a function to one of the buttons, press the button to activate the function.

#### NOTES

- Even if an assignable button was set to one of the following functions in **M** or **CINEMA** mode, the button will be disabled if you set the camcorder to **AUTO** mode: [ **Powered IS**], [ **BLC Always On**], [ **Face Only AF**], [**WB WB Priority**] or [**AF/MF** AF/MF].

## Saving and Loading Menu Settings

After you adjust the cinema-look filters and other settings in the FUNC. panel and setup menus, you can save those settings on a memory card.

Operating modes:    |  

### 86 Saving Menu Settings to a Memory Card

Menu settings must be saved to memory card **B**. If the memory card already has menu settings on it, they will be overwritten.

- 1 Insert a memory card into memory card slot **B**.
- 2 Open the [Backup Menu Settings **B**] screen.  
[FUNC.] ➤ [MENU] ➤  ➤ [Backup Menu Settings **B**]
- 3 Touch [Save] and then touch [Yes].
  - The current settings are saved to the memory card.
- 4 Touch [OK] and then touch [**X**].

### Loading Menu Settings from a Memory Card

- 1 Insert a memory card with menu settings into memory card slot **B**.
- 2 Open the [Backup Menu Settings **B**] screen.  
[FUNC.] ➤ [MENU] ➤  ➤ [Backup Menu Settings **B**]
- 3 Touch [Load] and then touch [Yes].
  - After the camcorder's current settings are replaced with the settings saved on the memory card, the screen will turn black momentarily and the camcorder will restart.

#### NOTES

- This camcorder can load settings only from other VIXIA HF G20 camcorders.

# 5 Playback

## Playing Back Video

Operating modes: **AUTO** **M** **CINEMA** |  

1 Press .

- You can also press and hold  on the wireless controller for more than 2 seconds to switch between shooting and playback mode.

2 Open the date index screen, if it is not displayed.

   Date

3 Look for the scene you want to play back.

- Move the zoom lever toward **W** to show 15 scenes per page; move it toward **T** to show 6 scenes per page.

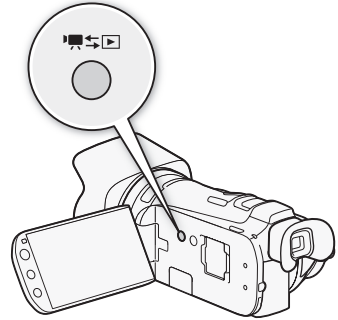

87



1 Memory being read.

2 Recording date.

3 Division line between recording dates.

4 Drag your finger left for the next index page\*.

5 Drag your finger right for the previous index page\*.

6 Open the  Index Selection screen (91).

7 3D Flip View (90).

8 Scene's timeline (96).

\* While browsing through index pages, a scroll bar will appear at the bottom of the screen for a few seconds. When you have a large number of scenes it may be more convenient to drag your finger along the scroll bar.

4 Touch the desired scene to play it back.

- Playback will start from the scene selected and continue until the end of the last scene in the index screen.
- Touch the screen to display the playback controls. During playback, the playback controls will disappear automatically after a few seconds without operation. In playback pause, touch the screen again to hide the playback controls.

During playback:

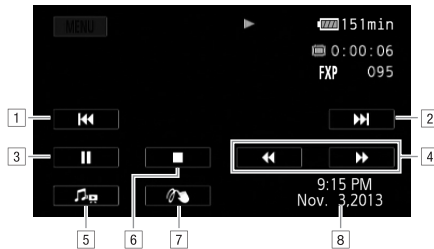

- 1 Jump to the beginning of the scene. Double-tap to jump to the previous scene.
- 2 Jump to the beginning of next scene.
- 3 Pause the playback.
- 4 Fast playback\* backward/forward.
- 5 Display the volume (88) and background music mix balance (110) controls.
- 6 Stop the playback.
- 7 Decoration (103).
- 8 Data code ([Date and Time] setting shown) (82).

\* Touch several times to increase the playback speed to approximately 5x → 15x → 60x the normal speed. During fast playback, touch anywhere on the screen to return to normal playback.

### Adjusting the volume

1 During playback, touch the screen to display the playback controls.

2 Touch [Speaker Volume], drag your finger along the [Speaker Volume] bar to adjust the volume and touch [Speaker].

- When [AV/Headphones] is set to [Headphones], adjust the [Headphone Volume] bar instead.



During playback pause:

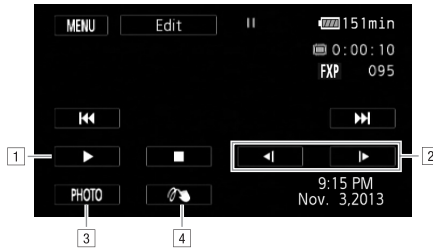

- 1 Resume playback.
- 2 Slow playback\* backward/forward.
- 3 Capture the displayed frame as a photo ( 98).
- 4 Decoration ( 103).

\* Touch several times to increase the playback speed 1/8 → 1/4 the normal speed. During slow playback, touch anywhere on the screen to return to playback pause.

### ! IMPORTANT

- Observe the following precautions while the ACCESS indicator is on or flashing. Failing to do so may result in permanent data loss.
  - Do not open the double memory card slot cover.
  - Do not disconnect the power source or turn off the camcorder.
  - Do not change the camcorder's operating mode.
- You may not be able to play back with this camcorder movies recorded using another device.

### i NOTES

- Fast/slow playback modes are not available for scenes converted to standard definition. Scenes in the [ SD Movies] index screen can only be played back at normal speed.
- You can turn off the recording date and time display or change the information displayed with the [Data Code] setting.
- Depending on the recording conditions, you may notice brief stops in video or sound playback between scenes.
- During fast/slow playback, you may notice some anomalies (blocky video artifacts, banding, etc.) in the playback picture.
- The speed indicated on the screen is approximate.
- Slow reverse playback will look the same as continuous frame reverse.

### 3D Flip View

Touch [ ] in the date index screen to switch to 3D Flip View. This convenient way of displaying scenes grouped by recording date in a 3D layout can be useful to flip through a large number of recordings.





- 1 Recording date.
- 2 Drag your finger left to go to the next date with recordings.
- 3 Drag your finger up and down to browse through the scenes recorded in the displayed date.
- 4 Drag your finger right to go to the previous date with recordings.
- 5 Return to the date index screen.
- 6 Current scene / Total number of scenes recorded on the selected date.
- 7 Touch the scene in the front to play it back.

## The Index Selection Screen: Selecting the Content to Play Back

From the index selection screen you can select the content you want to play back (original scenes by date or by story, or photos, for example). You can also select the memory from which you want to play back your recordings.

Operating modes: **AUTO** **M** **CINEMA** |  

In any index screen, touch [].

During single photo view, touch the screen once to display the controls then touch [] to open the [Photos] index screen.





- 1 Touch the tab of the desired memory: built-in memory, memory card **A** or memory card **B**.
- 2 Touch a control button to select the content you want to play back.

### Options

[ **Date**] Scenes organized by recording date.

[ **Gallery**] Scenes organized by story ( 107).

[ **Photos**] Photos' index screen.

[ **SD Movies**] (only when a memory card is selected) Scenes that were converted to standard definition to upload them to the Web ( 133).

### Two playback modes: the date index screen vs. the gallery

In the **date index screen** you can find all the movies you have recorded, conveniently organized by recording date. When you play back scenes from the date index screen, they will be played back in chronological order.

In the **gallery**, you can find your scenes grouped as video stories. If you record movies using the Story Creator function ( 99), your scenes will appear in the story you created; scenes recorded without using this function will appear in the [Unsorted] story (or [Video Snapshot] story, in the case of video snapshot scenes). When you play back a story from the gallery, scenes will be played back in the order of the story's outline, regardless of their recording date.





## Deleting Scenes and Stories

You can delete those scenes and stories that you are not interested in keeping. Deleting scenes allows you also to free up space on the memory.



Operating modes:    |  

92



### Deleting a Single Scene

- 1 Play back the scene you wish to delete ( 91).
- 2 Touch the screen to display the playback controls.
- 3 Open the [Delete] screen.  
  [Edit]  [Delete]
- 4 Touch [Yes].
  - The scene is deleted.
- 5 Touch [OK].

### Deleting Scenes from the Date Index Screen

- 1 Open the date index screen ( 91).
  - To delete all the scenes recorded on a specific date, drag your finger left/right until the desired date appears in the title bar.
- 2 Open the [Delete] screen.  
[Edit]  [Delete]
- 3 Touch the desired option.
  - When you select [Select], perform the following procedure to select the individual scenes you want to delete before touching [Yes].
- 4 Select [Yes].
  - Touch [Stop] to interrupt the operation while it is in progress. Some scenes may be deleted nevertheless.
  - The selected scenes are deleted.
- 5 Touch [OK].

#### To select individual scenes

- 1 Touch on the individual scenes you want to delete.
  - A checkmark  will appear on the scenes you touch. The total number of selected scenes will appear next to the  icon.
  - Touch a selected scene to remove the checkmark. To remove all checkmarks at once, touch [Remove All]  [Yes].
- 2 After selecting all the desired scenes, touch [OK].

#### Options

**[date]** Delete all the scenes recorded on the date shown in the control button.

**[Select]** Select individual scenes to delete.

**[All Scenes]** Delete all the scenes.

## Deleting a Single Scene from a Story

- 1 Open the list of scenes of the story that contains the scene you want to delete.  
[Home] ➤ [Library Gallery] ➤ Bring the desired story to the front ➤ [Scene List]
- 2 In the [Scene List] screen, drag your finger up/down to select the scene you want to delete.
- 3 Touch the orange box on the right to open the [Edit Scene] screen.
- 4 Touch [Delete] and then touch [Yes].
  - The selected scene is deleted.
- 5 Touch [OK] and then touch [Done].

## Deleting Scenes from a Story by Rating

- 1 Open the information screen of the story that contains the scenes you want to delete.  
[Home] ➤ [Library Gallery] ➤ Bring the desired story to the front ➤ [Story Details]
- 2 Open the rating selection screen.  
[Edit Story] ➤ [Delete]
- 3 Touch one or more of the rating buttons to select all the applicable scenes.
  - A grayed out rating button indicates that no scenes in the story have been given that particular rating.
  - Touch the rating button again to remove those scenes from the selection.
  - The number of selected scenes appears on the screen.
- 4 Delete all applicable scenes.  
[Set] ➤ [Yes]
  - Touch [Stop] to interrupt the operation while it is in progress. Some scenes may be deleted nevertheless.
- 5 Touch [OK] and then touch [Done].

## Deleting Stories

Deleting a story permanently deletes all the scenes it contains. The two preexisting stories, [Unsorted] and [Video Snapshot], cannot be deleted.

### 1 Select the story you want to delete.

[📁] ➤ [📁 Gallery] ➤ Bring the desired story to the front

### 2 Open the [Delete Story] screen.

[Story Details] ➤ [Edit Story] ➤ [Delete Story]

### 3 Touch [Yes].

- Touch [Stop] to interrupt the operation while it is in progress. Some scenes may be deleted nevertheless.

### 4 Touch [OK].

#### IMPORTANT

- Be careful when deleting recordings. Once deleted, scenes cannot be recovered.
- Deleting a story permanently deletes all the scenes it contains.
- When deleting scenes, scenes will be removed from the date index screen and from any stories in the gallery they may have belonged to, regardless of the method used to delete them.
- Save copies of important scenes before deleting them (📖 127).
- Observe the following precautions while the ACCESS indicator is on or flashing (while scenes are being deleted).
  - Do not open the double memory card slot cover.
  - Do not disconnect the power source or turn off the camcorder.
  - Do not change the camcorder's operating mode.

#### NOTES

- To delete all movies and make all recordable space available again you may prefer to initialize the memory (📖 36).

## Dividing Scenes

You can divide scenes in order to leave out the best parts and later cut out the rest.

Operating modes:    |  

- 1 Play back the scene you want to divide.
- 2 Pause the playback at the point where you want to divide the scene.
- 3 Open the scene division screen.  
[Edit] ► [Divide]
- 4 Bring the scene to a precise point, if necessary.
  - Playback controls will appear on the screen ([88](#)). Use any special playback modes (fast playback, frame reverse/advance) as necessary to locate the desired point.
- 5 Divide the scene.  
[✂ Divide] ► [Yes]
  - The video from the division point to the end of the scene will appear as a new scene in the index screen.

### NOTES

- When advancing/reversing frames while dividing the scenes, the interval between frames is about 0.5 seconds.
- If the scene cannot be divided at the point where you paused the playback, advance/reverse a frame and then divide the scene.
- During the playback of a scene that was divided, you may notice some anomalies in the picture/sound at the point where the scene was cut.
- The following scenes cannot be divided:
  - Scenes that are too short (less than 3 seconds).
  - Scenes that were edited using the supplied software **VideoBrowser** and were then transferred back to the camcorder.
- Scenes cannot be divided within 1 second from the beginning or the end of the scene.

## Selecting the Playback Starting Point

If you have a very long scene, you may want to start playing back the scene from a certain point. You can use the movie timeline to break the scene to segments at fixed time intervals ranging from 6 seconds to 6 minutes.

Operating modes: **AUTO** **M** **CINEMA** |  

96

1 Open the date index screen ( 91).

2 Open the scene's [Timeline] screen.

  Desired scene

- The [Timeline] screen appears. The large thumbnail will show the first frame of the scene. Below it, the timeline ruler shows frames taken from the scene at fixed intervals.

3 Touch the desired frame in the timeline ruler to start playing back the scene from that point.

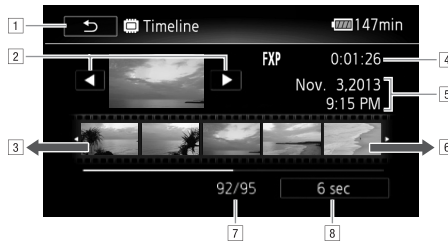

- 1 Touch twice to return to the index screen.
- 2 Previous/next scene.
- 3 Drag your finger left along the ruler to display the next 5 frames.
- 4 Scene's recording mode and length.
- 5 Recording date and time.
- 6 Drag your finger right along the ruler to display the previous 5 frames.
- 7 Current scene / Total number of scenes.
- 8 Currently selected interval between frames.

To change the interval between frames

1 Touch [6 sec].

2 Select the desired interval and then touch .





## Capturing Video Snapshot Scenes and Photos from a Movie

You can capture video snapshot scenes, single photos or a series of continuous photos from a previously recorded scene. For example, you may want to print photos from video recorded at a party or create a small video clip using video snapshot scenes from the highlights of an event.

Operating modes:    |  

### Capturing a Video Snapshot Scene

- 1 Play back the scene or story from which you want to capture the video snapshot scene.
- 2 Press **[START/STOP]** to capture the video snapshot scene.
  - The camcorder captures the video snapshot scene for about 4 seconds (the blue frame serves as a visual progress bar), and then enters playback pause mode. You can change the length of the video snapshot scenes you capture to 2 or 8 seconds with the   [Video Snapshot Length] setting.
- 3 Touch **[■]** to stop the playback.

#### NOTES



- A video snapshot scene can be captured only during playback; it cannot be captured during playback pause mode.
- The captured video snapshot scene is saved to the same memory that contains the source scene.
- Video snapshot scenes cannot be captured from any of the following types of scenes.
  - Scenes shorter than 1 second.
  - Scenes that were edited using the supplied software **VideoBrowser** and were then transferred back to the camcorder.
- When the source scene is itself a video snapshot scene, you may not be able to capture a video snapshot scene depending on the length of the source scene and the length currently selected for video snapshot scenes.
- When you start capturing a video snapshot scene less than 1 second from the end of the scene, the video snapshot scene will be captured starting from the beginning of the following scene.
- During the playback of video snapshot scenes captured from a previously recorded movie, you may notice some anomalies in the picture/sound at the point where the playback switches to a new scene.

## Capturing Photos

You can capture a single photo or a series of photos. The size of the captured photos will be 1920x1080 and it cannot be changed.

Please read the IMPORTANT section (📖 98) before using an Eye-Fi card.

### To select the photo capture settings

- 1 Open the [Photo Capture from Video] screen.  
[MENU] ➤  ➤ [Photo Capture from Video]
- 2 Touch [ Single Photo] or [ Photo Sequence] and then touch [**X**].

### To capture the photos

- 1 Play back the scene or story from which you want to capture the photo.
- 2 Pause the playback at the point you want to capture.
- 3 Touch [PHOTO].
  - To capture a photo sequence, keep touching [PHOTO]. The scene will be played back frame-by-frame and each frame captured as a separate photo.
- 4 Touch [] to stop the playback.

### IMPORTANT

- If photos and video snapshot scenes (with compatible cards only) were captured onto an Eye-Fi card in memory card slot **B**, wireless upload will start automatically if you are within the range of a configured network. Always verify that Eye-Fi cards have been approved in the country/region of use. See also *Using an Eye-Fi card* (📖 136).

### NOTES

- The data code of the photos will reflect the date and time of recording of the original scene.
- Photos captured from a scene with a lot of fast movement may be blurred.
- Photos will be recorded on the memory selected for recording photos.
- [ Photo Sequence]:
  - Up to 100 photos can be captured at a time.
  - The photo sequence capture will stop when the end of the scene is reached (playback will pause at the beginning of the following scene).
  - Photos will be captured at intervals of 1/30 second (1/24 second, if the scene was recorded at a frame rate of [**PF24** PF24] or [**24P** 24P]).

---

# 6 Video Stories and Cinema Style

## Using Story Creator to Create Video Stories

Story Creator is a helpful function that offers suggestions for typical scenes in a number of situations. With Story Creator, creating a video story with a structured yet interesting storyline is as easy as selecting one of the story themes, such as [Travel], [Kids & Pets] or [Blog], and following the suggested categories to record video. You can even select [Unrestricted] to group recordings as a single story without following the other storylines. During playback, select your story from the gallery to play back the scenes you recorded as a single, compelling video story (📖 107).

Operating modes: **AUTO** **M** **CINEMA** |  

### Creating a New Story

#### 1 Start Story Creator mode.

[FUNC.] ➔  Story Creator]

- Alternatively, you can set an assignable button to  Story Creator] (📖 85).
- If the memory already contains other stories, the story selection screen will appear. In that case, touch [New Story].

#### 2 Select the desired theme.

- Drag your finger left/right to browse through the themes and touch the thumbnail of the desired theme.
- A list of the suggested categories (story scenes) for the selected theme will appear.

#### 3 Drag your finger up/down to select a category and touch [OK].

#### 4 In the confirmation screen, touch [Yes] to create the story.

- Initially, the current date will be used as the story's title, but you can change it by touching  (📖 115).
- A new story will be created and the camcorder will enter record pause mode. The selected story scene category will appear at the bottom of the screen.

### Recording a Scene within a Story

Press **START/STOP** to record movies within the selected story scene (category).

- Use the displayed recommended length as a reference when recording scenes.
- Scenes will be recorded under the story and category currently selected.
- You can also record video snapshot scenes (📖 80).

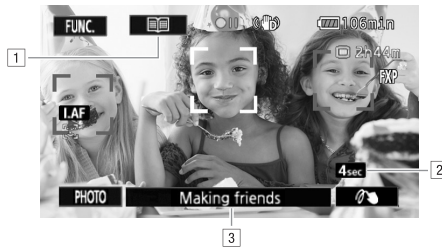

- 1 Return to the list of story scenes (categories).
- 2 Recommended length of scenes in this category.
- 3 Currently selected story scene (category). You can also touch here to return to the list of story scenes.

### To select a different story scene (category)

- 1 Touch [📖] to return to the list of story scenes.
  - Alternatively, when the story scene title (currently selected category) appears at the bottom of the screen, you can touch it instead.
- 2 Drag your finger up/down to select another category and touch the orange frame on the right (number of scenes).

### To exit Story Creator mode

- 1 Touch [FUNC.] and then touch [📷 Story Creator].
- 2 Touch [Yes].

### NOTES

- When recording video snapshot scenes, you can have the camcorder automatically link the length of video snapshot scenes to the recommended length of story scenes with the [📷] ➔ [Video Snapshot Length] setting.
- During Story Creator mode, relay recording and double slot recording are not available.

## Recording Additional Scenes within an Existing Story

- 1 Start Story Creator mode.  
[FUNC.] ➔ [📷 Story Creator]
  - Alternatively, you can set an assignable button to [📷 Story Creator] (📖 85).
- 2 Select the story to which you want to add new scenes.
  - The list of story scenes will appear. The orange frame on the right will show how many scenes you have recorded in each story scene (category).
- 3 Drag your finger up/down to select a category and touch the orange frame on the right (number of scenes).
  - The camcorder will enter record pause mode and the selected story scene category will appear at the bottom of the screen.
- 4 Press [START/STOP] to record a scene within the selected story scene.

## CINEMA Mode and Cinema-Look Filters

In **CINEMA** mode, the camcorder will adjust the frame rate and several other picture-related settings to give your recordings a cinematic look. In this mode you can also use a variety of professional cinema-look filters to create unique movies with a distinctive appearance.

Operating modes: **AUTO** **M** **CINEMA** |  

- 1 Set the mode switch to **CINEMA**.
- 2 Touch **[FILTER 1]** to open the cinema-look filter selection screen.
- 3 Drag your finger up and down along the photos to select the desired cinema-look filter and then touch **[OK]**.
  - You can change the effect level before touching **[OK]**. **[Cinema Standard]** offers different adjustment options than the other cinema-look filters.
  - The selected cinema-look filter will be applied and its number will appear on the control button.

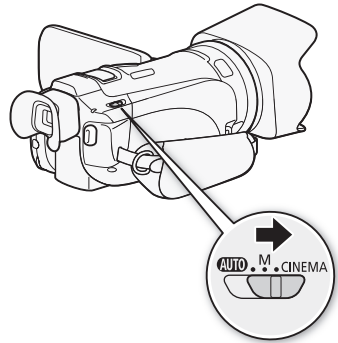

101

### To select the effect level of **[Cinema Standard]**

- 1 Open the parameter selection screen.
  - [👉] ▶ [ON]**
- 2 Touch **[Color Depth]**, **[Softening Filter]**, **[Key (Brightness)]** or **[Contrast]**.
- 3 Touch the desired level or touch **[◀]** or **[▶]** to adjust the parameter.
  - You can also drag your finger along the dial.
  - The picture will change immediately according to the adjustment.
  - To adjust other parameters, touch **[↶]** to return to the previous screen. Touch the desired control button and repeat step 3.
- 4 Touch **[↷]** and then touch **[OK]**.

### To select the effect level of the other cinema-look filters

- 1 Touch **[👉]** to open the adjustment screen.
- 2 Touch **[L]** (low), **[M]** (medium) or **[H]** (high).
- 3 Touch **[↷]** and then touch **[OK]**.

**Options** (♦ Default value)

The camcorder offers 9 cinema-look filters. Select the desired filter while previewing the effect on the screen.

[1: Cinema Standard]♦

[2: Vivid]

[3: Dream]

[4: Cool]

[5: Nostalgic]

[6: Sepia]

[7: Old Movies]

[8: Memory]

[9: Dramatic B&W]



- 1 Filter number (will appear on the control button)
- 2 Filter name
- 3 Preview the effect on the screen
- 4 Select the effect level
- 5 Brief description (onscreen guidance)

**i** NOTES

- Photos cannot be recorded while the camcorder is set to **CINEMA** mode.

## Adding Decorations

Using the decoration function, you can add various graphical elements to the picture, such as stamps, watermarks, the date/time, and even your own freehand drawings. Freehand drawings can help emphasize a portion of the picture to attract viewers' attention. The supplied stylus pen will be especially useful for adding decorations.

You can decorate scenes as they are being recorded, during playback or when converting them to standard definition.

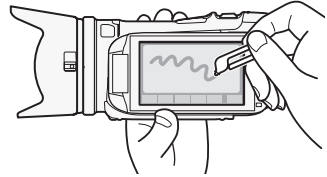

## Decorating Scenes while Recording

Operating modes: **AUTO** **M** **CINEMA** |  

### 1 Open the decoration screen.

[FUNC.]   Decoration

- When  [Autostart Decoration] is set to **[ON On]** (default value), the decoration screen will open automatically also when you stow the LCD panel with the touch screen facing out.

### 2 Use a tool from the toolbar as explained in the following procedures.

### 3 Press **[START/STOP]** to record movies with your decorations.

- You can add decorations even while recording a scene.

### 4 Touch **[X]** to exit the decoration screen.

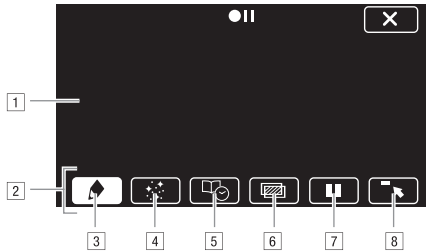

- 1 [Canvas] - The area where you will draw and see your decorations in action.
  - 2 [Toolbar].
  - 3 [Pens and Stamps] Select the type of pen or stamp and its color. You can also save a canvas or load a previously saved canvas.
  - 4 [Animated Stamps] Select animated stamps to add to your decoration.
  - 5 [Captions] Add the date, date and time, story title or story theme category as a caption that will be included in the recording.
  - 6 [Image Mix]\* Choose one of 27 different frames to add onto the canvas. Image mix can be used in combination with the pens, stamps and animated stamps. During playback, you can add a watermark to the picture using image mix.
  - 7 [Pause/Resume]\* In recording mode: pause the live video. Touch [▶||◀] to restore the live video. You can add decorations to the frozen image and even record it. In playback mode: pause the playback. Touch [▶] to resume playing back the scene.
  - 8 [Minimize/Restore] Minimize the toolbar to the top of the screen to view almost all of the canvas. Touch [📄] to restore the toolbar.
- \* Not available in **CINEMA** mode.

### To use [Pens and Stamps]

- 1 Touch [Pens and Stamps].
  - The [Pens and Stamps] screen will appear.
- 2 Select the desired pen or stamp from [Tools].
  - The main decoration screen will appear again.
- 3 Draw freely on the canvas.
  - To select a different pen or stamp: Repeat steps 1 and 2.
  - To change color: Touch [Pens and Stamps] and then touch the white or black button under [Colors]. Alternatively, touch [Pens and Stamps] ➤ [Color] and select a color from the color palette.
  - To clear your freehand drawings and stamps: Touch [Pens and Stamps] ➤ [Clear] ➤ [Yes] ➤ [↵].
  - To save your freehand drawings and stamps in the built-in memory: Touch [Pens and Stamps] ➤ [Save] ➤ [Yes] ➤ [↵].
  - To load a previously saved canvas (freehand drawings and stamps only) from the built-in memory: Touch [Pens and Stamps] ➤ [Load] ➤ [Yes] ➤ [↵].



### To use [Animated Stamps]

- 1 Touch [👉].
  - The [Animated Stamps] screen will appear.
- 2 Touch one of the control buttons.
- 3 Touch anywhere on the canvas to place the selected animated stamp. You can also drag the animated stamp to a different location.

### To use [Captions]

- 1 Touch [👉].
  - The [Captions] screen will appear.
- 2 Touch [Date] or [Time].
  - When recording a scene using Story Creator, you can also select [Title] (the story's title) or [Story Scene] (the story scene category).
- 3 Select the desired text settings and touch [👉].
  - Touch [A] (white text on dark background), [A] (white text) or [A] (black text).
  - The selected caption will appear on the screen.
- 4 Touch the caption and drag it to the desired location.

### To use image mix

- 1 Open the [Select Image] screen.  
[👉] ➤ [ON]
- 2 Touch [+] or [-] to select a different image mix frame.
  - You can touch one of the memory icons at the bottom of the screen to read image mix frames saved in the built-in memory (only when recording on or playing back scenes from a memory card).
- 3 Touch [👉] to mix the selected frame with the live video.

#### Mixing Your Own Images with Live Video





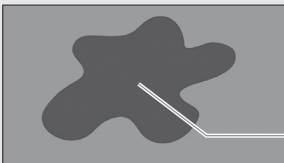



You can use images you created on your computer for the image mix (Chroma Key) function. Make sure that the image you want to use has a blue or green area, which will be replaced by the live video using Chroma Key mixing. Refer to *About the image files for the Image Mix function* (📖 178) for details about the types of image files that can be used and where to transfer them.

Example of an image used for Chroma Key



Blue/Green area that will be replaced by the live video

### To use the Chroma Key function



- 1 Open the [Select Image] screen of the image mix function ( 105).
- 2 Touch [+] or [-] to select the image you created.
- 3 Touch  to open the [Chroma Key] screen.
- 4 Touch [Green] or [Blue] depending on the characteristics of the image you want to use and touch  or  or drag your finger along the bottom bar to adjust the chroma key setting as necessary.
- 5 Touch  at the top of the screen to open the [Transparency] screen.
- 6 Touch  or  or drag your finger along the bottom bar to adjust the overall transparency of the image as necessary.
- 7 Touch  to mix your image with live video.

### Decorating Scenes during Playback

Operating modes:    |  

- 1 Play back the scene you want to decorate.
- 2 Touch the screen to display the playback controls.
- 3 Touch  to open the decoration screen.
- 4 Decorate the scene using the tools from the toolbar as explained in the previous section.
  - In playback mode, the decorations will not be saved with the original recording.

#### NOTES

- Initializing a memory will erase any [Pens and Stamps] drawing canvas and image files you may have saved. (The image mix frames that come pre-installed in the built-in memory will be restored after it is initialized.)
- Animated stamps and captions cannot be used at the same time.
- When   [Rec Media for Movies] is set to  (the built-in memory), you will not be able to select image mix frames saved on a memory card.
- Image mix cannot be selected during playback or while converting a scene to standard definition. Select the image mix during playback pause or before starting the conversion.
- Decorations will appear in the thumbnails of scenes in the date index screen and gallery.

## Playing Back Stories from the Gallery

You can play back recordings made using Story Creator to play them back as a single compelling video story following the storyline order. Regular scenes and video snapshot scenes recorded without using Story Creator, will appear in the gallery under the [Unsorted] or [Video Snapshot] stories. When playing back stories from the gallery, you can choose to play back only scenes with a certain rating.

Operating modes: **AUTO** **M** **CINEMA** |  

### 1 Open the gallery.

   Gallery



- 1 Drag your finger right or left to select a story.
- 2 Story's theme.
- 3 Selected story (large thumbnail in the front).
- 4 Story's title (📖 115).
- 5 Open the  Index Selection screen (📖 91).
- 6 Details about the story (number of scenes, total playback time) and editing options.
- 7 List of scenes recorded in the selected story.

### 2 Select the story you want to play back.

- Drag your finger right/left to bring the desired story to the front.
- To play back only scenes with a certain rating, proceed to step 3. If not, skip to step 5.

### 3 Open the [Play by Rating] screen.

[Story Details]  [Play by Rating]

### 4 Touch the desired rating and touch twice.

### 5 Touch the story's thumbnail to start the playback.

- All applicable scenes will be played back from the first scene to the last. When playback ends, the camcorder will return to the gallery.
- During the playback of a story other than [Unsorted] or [Video Snapshot], touch the screen and then touch  to display the scene's category during playback. Touch the control button again to turn the story scene display off.
- Playback controls are the same as when playing back scenes from the date index screen (📖 88).

 IMPORTANT

- Observe the following precautions while the ACCESS indicator is on or flashing. Failing to do so may result in permanent data loss.
  - Do not open the double memory card slot cover.
  - Do not disconnect the power source or turn off the camcorder.
  - Do not change the camcorder's operating mode.

 NOTES

- If playback of a scene in the gallery is interrupted, you cannot resume playback at the point it stopped. The story will start over from the beginning the next time you play it back.

## Rating Scenes

You can rate story scenes immediately after recording them or during playback. You can then select multiple scenes with the same rating, for example, in order to play back or copy only your favorite scenes.

### Rating Scenes Immediately After Recording

Operating modes: **AUTO** **M** CINEMA |  

- 1 Open the [Rate Scenes (Recording)] screen.  
[FUNC.] ➤ [MENU] ➤  ➤ [Rate Scenes (Recording)]
- 2 Touch [**ON** On] and then touch [**X**].

#### To rate scenes



Immediately after recording a scene, rating buttons will appear at the bottom of the screen. Touch one of the rating buttons to rate the scene from one to three stars. You can touch [• • •] to leave the scene unrated or [— — —] to classify it in a separate category (for example, just for outtakes).

#### To turn off the scene rating function

When the rating buttons appear after recording a scene, touch [**X**] and then touch [Off]. This will also leave the current the scene unrated.



### Rating Scenes from the List of Scenes

Operating modes: **AUTO** **M** CINEMA |  

- 1 Open the list of scenes of the story that contains the scenes you want to rate.  
[] ➤ [ Gallery] ➤ Bring the desired story to the front ➤ [Scene List]
- 2 In the [Scene List] screen, drag your finger up/down to select the scene you want to rate.
- 3 Touch the orange box on the right to open the [Edit Scene] screen.
- 4 Touch the control button of the desired rating and touch [] twice to return to the gallery.

### Rating Scenes during Playback

Operating modes: **AUTO** **M** CINEMA |  

- 1 Play back from the gallery the story that contains the scenes you want to rate.
- 2 During playback of a scene you want to rate, touch the screen to display the playback controls.
- 3 Open the [Rating] screen.  
[] ➤ [Edit] ➤ [Rating]
- 4 Touch the desired rating and then touch [**X**].
- 5 Touch [] to resume the playback and rate other scenes in the same way or touch [] to return to the gallery.

## Playback with Background Music

Play back movies (or a photo slideshow) with background music. You can use one of the supplied music tracks or connect an external audio player to use your favorite songs as background music.

Operating modes: **AUTO** **M** **CINEMA** |  

110

### Using One of the Supplied Music Tracks as Background Music

The supplied VIXIA CD-ROM contains 3 music tracks you can use as background music. The music files come pre-installed in the built-in memory.

You can mix the original audio and the background music and adjust the background music mix balance to your preference.

#### POINTS TO CHECK

- To play back scenes or a slideshow of photos recorded on a memory card, you will need to transfer the music tracks to the memory card in advance. See the NOTES section ( 112).

1 Open the gallery or date index screen.

[] > [ Gallery] or [ Date]

2 Open the [Select Music] screen.

[MENU] > [] > [Select Music] > [**ON** On]

3 Touch [] or [] to select the desired music track.

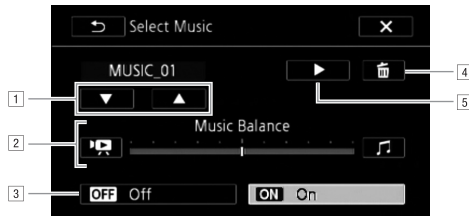

1 Select the desired music track.



2 Adjust the background music balance.

3 Play back the original sound (no background music).

4 Delete the music track selected.

5 Listen to the music track selected. Touch again () to stop the playback.

4 Adjust the mix balance between the original sound and the background music.

- Touch [] (more of the original sound) or [] (more of the background music) or drag your finger along the [Music Balance] bar to adjust the background music balance as desired.

5 Touch [] and then touch a story or scene to start the playback with the selected background music.

### To adjust the background music balance during playback

- 1 During playback, touch the screen to display the playback controls.
- 2 Touch [], drag your finger along the [Music Balance] bar to adjust the background music balance as desired and touch [].

### To delete a music track

- In the [Select Music] screen, touch [] or [] to select the track you want to delete.  
Touch [] and then touch [Yes].

## Using an External Audio Player for Background Music

Use your favorite songs as background music by connecting an external player.



### POINTS TO CHECK

- You will need a commercially available audio cable with at least one mini-stereo plug (to connect to the MIC terminal on the camcorder); the other end will depend on external player used).
  - Make sure that the jacket covering above the mini-stereo plug is smaller than  $\varnothing$  9.5 mm (0.37 in.).
- 1 Connect the external player to the camcorder's MIC terminal.
  - 2 Open the gallery or date index screen.  
[] ➤ [ Gallery] or [ Date]
  - 3 Open the [External Audio Input] screen.  
[MENU] ➤ [] ➤ [External Audio Input]
  - 4 Touch [**ON** On ].
  - 5 Adjust the audio input as necessary.
    - Start the music playback on the external player and adjust its volume according to the onscreen indications.
    - Touch [External Player Link] to link the video playback to the start/end of the music from the external player.
    - When the audio input is in the correct range, stop the music playback and touch [**X**] on the camcorder.

### Playback with the video linked to the external audio

- 6 Start the music playback on the external player.
  - Playback will start from the first scene in the story or index screen.
  - When the external audio input stops, video playback will pause. When the external audio input is restored, video playback will resume automatically.
  - Even when the video playback stops, audio playback on the external player will not stop automatically.

### Playback with the video not linked to the external audio

- 6 Touch a story or scene to start the video playback.
- 7 Start the music playback on the external player.

 IMPORTANT

- If you use copyrighted songs and music tracks in your video creations, remember that music under copyright may not be used without permission from the copyright holder, except for cases permitted under applicable laws, such as for personal use. Make sure to follow applicable laws when using music files.

112  NOTES





- Initializing a memory card will permanently erase any music files you may have transferred to the card. (The music files that come pre-installed in the built-in memory will be restored after it is initialized.) To transfer music files from the supplied VIXIA CD-ROM to the memory card:
  - Windows users: Use the supplied software **VideoBrowser**. For details, refer to the Software Guide (PDF file) of the supplied PIXELA's software.
  - Mac OS users: Use Finder to transfer music files from the "MUSIC" folder on the supplied VIXIA CD-ROM to the memory card. Refer to *About the music files* (□ 178) for the folder structure of the memory card.
- Transfer music files to the memory card that contains the recordings you want to play back with background music.
- In some cases, the video playback may not be correctly linked to the external player. For example, if the volume of the external player is too low or if the audio signal contains a lot of noise, etc.



## Copying and Moving Scenes Within/Between Stories

You can copy and move scenes in the gallery within the same story scene (category), between story scenes in the same story, and between stories recorded in the same memory.

Operating modes: **AUTO** **M** **CINEMA** |  

- 1 Open the list of scenes of the story that contains the scene you want to copy or move.   [Gallery]  Bring the desired story to the front  [Scene List]
- 2 In the [Scene List] screen, drag your finger up/down to select the scene you want to copy/move.
- 3 Touch the orange box on the right to open the [Edit Scene] screen and touch [Copy] or [Move].
- 4 Select the destination.
  - Drag your finger right/left to select the desired story and touch its thumbnail. Then, drag your finger up/down to select the desired category and touch the orange frame on the right (number of scenes). And last, drag your finger up/down to move the orange bar within the category to select the position of the scene.
- 5 Touch [Set] and then touch [Yes].
  - Touching [Set] is not necessary when copying/moving a scene into a story scene category that contains no other scenes.
  - When copying a scene, you can touch [Stop] to interrupt the operation while it is in progress.
- 6 After moving a scene: Touch .
 

After copying a scene: Touch [OK] and then touch .

### NOTES

- You cannot copy or move scenes to the two preexisting stories, [Unsorted] and [Video Snapshot].

## Selecting a Story's Thumbnail Image

Initially, the image used as the story's thumbnail is the first frame of the first scene in the story. You can set your favorite scene as the thumbnail that will represent the story in the gallery.

Operating modes:    |  

1 Open the information screen of the story whose thumbnail you want to change.

 ➤  Gallery ➤ Bring the desired story to the front ➤  [Story Details]

2 Open the [Story Thumbnail] screen.

[Edit Story] ➤  [Story Thumbnail]

3 Locate the frame you want to use as the story's thumbnail.

- Playback controls will appear on the screen ( 88). Use any special playback modes (fast/slow playback, frame reverse/advance) as necessary to locate the desired image.

4 Touch [Set] to change the story's thumbnail.

5 Touch  to return to the gallery.

## Changing a Story's Title

When you first create a story, the current date will be used as the story's title but you can change the title later on. The title can be up to 14 characters long (available characters are limited). The title of the two preexisting stories, [Unsorted] and [Video Snapshot] cannot be changed.

Operating modes: **AUTO** **M** **CINEMA** |  

1 Open the information screen of the story whose title you want to change.

   Gallery  Bring the desired story to the front  [Story Details]

2 Open the [Edit Title] screen.

[Edit Story]  [Edit Title]

3 Use the virtual keyboard to change the title.

4 Touch [OK] and then touch  twice to return to the gallery.



- 1] Switch between letters and numbers/special characters.
- 2] Change the position of the cursor.
- 3] Delete the character to the cursor's left (backspace).
- 4] Caps Lock. When the numerical keyboard is displayed, [#%?] / [\*&+] switches between set 1 and set 2 of special characters.

### NOTES

- We recommend using the supplied stylus pen to enter characters.
- When you save recordings on a computer with the supplied software **VideoBrowser** using the option to join and import music and video files from the gallery, some special characters in the story's title (/ , \ , < , > , : , \* , " , | , ?) will be changed to an underscore ( \_ ) in the file name.

# 7 External Connections

## Terminals on the Camcorder

116

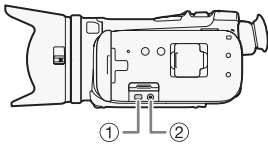

### ① COMPONENT OUT Terminal\*

Access: Open the LCD panel and terminal cover.  
The component video terminal is for video only. When you use connection [2], do not forget the audio connections using the AV OUT/🔊 terminal.



### ② AV OUT/🔊 Terminal

Access: Open the LCD panel and terminal cover.  
Sound from the built-in speaker will be muted while the STV-250N Stereo Video Cable is connected to the camcorder. Adjust the volume on the connected TV.

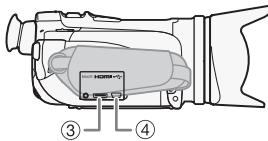

HDMI OUT



### ③ HDMI OUT Terminal\*

Access: Open the side terminal cover.  
The HDMI OUT terminal offers a high-quality digital connection that combines audio and video in a single convenient cable. This terminal is an HDMI Mini Connector. When using a commercially available HDMI Connector, make sure the HDMI cable is Type A to Type C.

USB



### ④ USB Terminal

Access: Open the side terminal cover.

\* When connecting a cable to the camcorder, make sure to align the triangle marks on the cable's connector and on the camcorder's terminal.

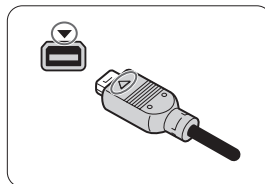
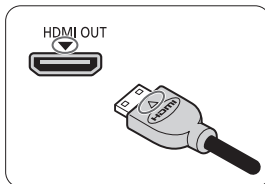

## Connection Diagrams

In the following connection diagrams, the left side shows the terminals on the camcorder and the right side shows (for reference only) an example of terminals on a connected device.

Connection 1

HDMI

**Type: Digital • Quality: High definition • Output only**

Connect to a high-definition TV (HDTV) with an HDMI input terminal. If your HDTV supports HDMI-CEC or 1080p input, you can activate these functions with the [Control for HDMI] and [HDMI 1080p Output] settings, respectively. You can check the standard of the current output signal with the [HDMI Status] setting.

117

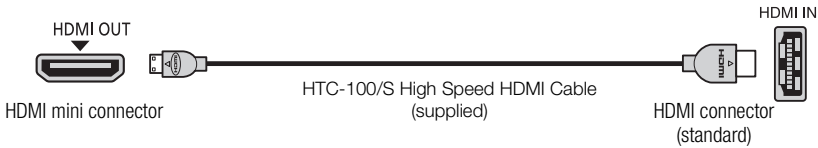

### About the HDMI™ connection

The HDMI (High-Definition Multimedia Interface) connection (1) is a convenient all-digital connection using a single cable for both video and audio. When you connect the camcorder to an HDTV equipped with an HDMI terminal, you can enjoy video and audio playback at the highest quality.

- The HDMI OUT terminal on the camcorder is for output only. Do not connect it to an HDMI output terminal on an external device, as this may damage the camcorder.
- While the camcorder is connected to an HDTV using connection 1, there will be no video output from other terminals.
- Correct operation cannot be guaranteed when connecting the camcorder to DVI monitors.
- Depending on the HDTV, correct playback of personal video content may not be possible using connection 1. Try one of the other connections.

Connection 2

Component Video

**Type: Analog • Quality: High Definition • Output only**

Connect to a high-definition TV (HDTV) with component video input terminals. Set [AV/Headphones] to [AV AV] on the camcorder.

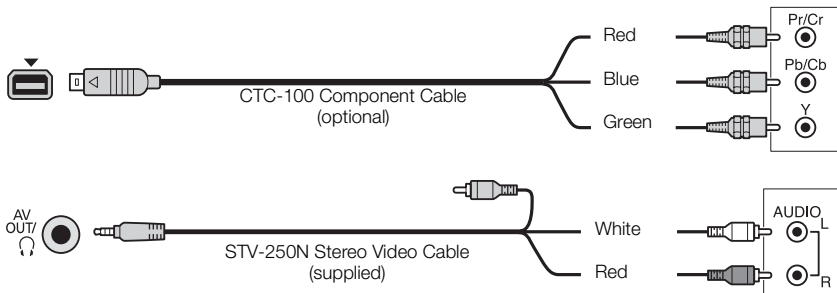

Connection 3

Composite Video

**Type: Analog • Quality: Standard definition • Output only**

Connect to a standard TV or a VCR with audio/video input terminals. Change the following settings on the camcorder:

- [ ] > [TV Type] according to the TV set (widescreen or 4:3), if the TV cannot automatically detect and change the aspect ratio
- [ ] > [AV/Headphones] to [AV] AV

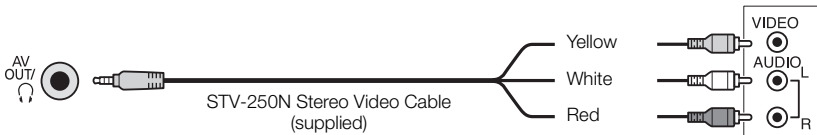

Connection 4

USB

**Type: Digital data connection**

Connect to a computer to save your recordings, or to a compatible digital video recorder to copy your recordings.

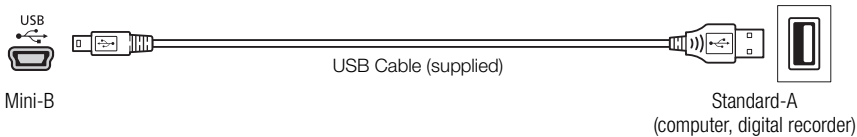



**i** NOTES

- Power the camcorder using the compact power adapter and only then connect it to the computer using the supplied USB cable in the following cases.
  - To write back scenes recorded with this camcorder that were previously saved on a computer. For details, refer to the Software Guide (PDF file) of the supplied PIXELA's software.
  - To transfer music files from the supplied VIXIA CD-ROM to a memory card in the camcorder in order to use them as background music. For details, refer to the Software Guide (PDF file) of the supplied PIXELA's software.

## Playback on a TV Screen

Connect the camcorder to a TV to view and check your recordings. Playback on an HDTV using one of the high-definition connections will ensure the best playback quality.

Operating modes:    |  

- 1 Turn off the camcorder and the TV.
- 2 Connect the camcorder to the TV.
  - Refer to *Connection Diagrams* (📖 117) and select the most appropriate connection for your TV.
- 3 Turn on the connected TV.
  - On the TV, select as the video input the same terminal to which you connected the camcorder. Refer to the instruction manual of the connected TV.
- 4 Turn on the camcorder and set it to  or  mode.
  - Play back the movies or photos.

### NOTES

- To correctly play back movies recorded with x.v.Color (📖 145) on an HDTV compatible with this standard, additional settings may be required on the connected HDTV. Refer to the TV's instruction manual.
- We recommend powering the camcorder using the compact power adapter.
- Connection [3](#): When you play back your 16:9 movies on standard TV sets with a 4:3 aspect ratio, the TV set will switch automatically to widescreen mode if it is compatible with the Video ID-1 system. Otherwise, change the aspect ratio of the TV manually.
- You can also play video directly from your memory card on AVCHD-compatible HDTVs and digital recorders with a card slot **compatible with the type of memory used\***.



\* Refer to the instruction manual of the device. Depending on the device used, correct playback may not be possible even if the device is AVCHD-compatible. In such case, play back the recordings on the memory card using the camcorder.

# 8 Photos

## Viewing Photos

Operating modes: **AUTO** **M** **CINEMA** |  

120

- 1 Press .
- 2 Open the [Photos] index screen, if it is not displayed.  
  [Photos]
- 3 Look for the photo you want to play back.
  - Move the zoom lever toward **W** to show 15 photos per page; move it toward **T** to show 6 photos per page.

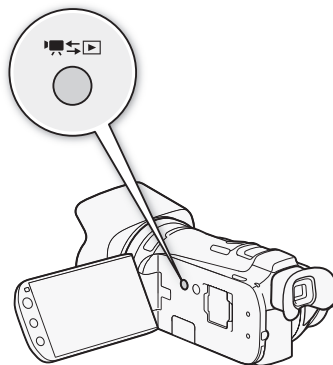

- 1 Memory being read.
- 2 Drag your finger left for the next index page.\*
- 3 Drag your finger right for the previous index page.\*
- 4 Open the [ Index Selection] screen ([91](#)).

\* While browsing through index pages, a scroll bar will appear at the bottom of the screen for a few seconds. When you have a large number of photos it may be more convenient to drag your finger along the scroll bar.

- 4 Touch the photo you wish to view.
  - The photo is displayed in single photo view.
  - Drag your finger left/right to browse through the photos one by one.



To return to the index screen from single photo view

- 1 Touch the screen to display the playback controls.
- 2 Touch .



## Photo Jump Function

When you have recorded a large number of photos, you can jump easily through the photos using the scroll bar.

- 1 Touch the screen to display the playback controls.
- 2 Touch .
- 3 Drag your finger left and right along the scroll bar and then touch .



### IMPORTANT

- Observe the following precautions while the ACCESS indicator is on or flashing. Failing to do so may result in permanent data loss.
  - Do not open the double memory card slot cover.
  - Do not disconnect the power source or turn off the camcorder.
  - Do not change the camcorder's operating mode.
- The following image files may not be displayed correctly.
  - Images not recorded with this camcorder.
  - Images edited on a computer.
  - Images whose file names have been changed.

## Slideshow



You can play a slideshow of all the photos and even set it to music.

Operating modes:    |  

1 Open the [Photos] index screen.

  [Photos]

2 Select the background music to use during the photo slideshow.

- Music tracks: Steps 2 - 3 ( 110). External audio: Steps 1 - 4 ( 111).

### Slideshow set to a music track

3 Touch the photo that will open the slideshow to display it in single photo view.

4 Touch the screen to display the playback controls, then touch  to play back the slideshow set to the selected music track.

### Slideshow not linked to the external audio

3 Touch the photo that will open the slideshow to display it in single photo view.

4 Touch the screen to display the playback controls, then touch  to start the slideshow.

5 Start the music playback on the external player.

### Slideshow linked to the external audio

3 Start the music playback on the external player.

- Playback will start from the first photo in the index screen.
- Photos will be displayed continuously until the music stops. When the external audio input stops, the slideshow will stop as well.





### During the photo slideshow

- Touch the screen and drag your finger left and right along the volume bar to adjust the volume.
- Touch the screen and touch  to stop the slideshow.

### To change the slideshow's transition effects

1 Open the [Slideshow Transition] screen.

[MENU]   [Slideshow Transition]



2 Touch  Off],  Dissolve] or  Slide Image] and then touch .

## Deleting Photos

You can delete those photos that you are not interested in keeping.

Operating modes:    |  

### Deleting a Single Photo

- 1 In single photo view, select the photo you want to delete.
- 2 Touch the screen to display the playback controls.
- 3 Open the [Delete] screen.  
[Edit] ➤ [Delete]
- 4 Touch [ Proceed] and then touch [Yes].
  - The photo is deleted.
- 5 Drag your finger left/right to select another photo to delete or touch [].

### Deleting Photos from the Index Screen

- 1 Open the [Photos] index screen.  
[] ➤ [Photos]
- 2 Open the [Delete] screen.  
[Edit] ➤ [Delete]
- 3 Touch the desired option and then touch [Yes].
  - When you select [Select], perform the following procedure to select the individual photos you want to delete before touching [Yes].
  - Touch [Stop] to interrupt the operation while it is in progress. Some photos will be deleted nevertheless.
- 4 Touch [OK].

#### To select individual photos

- 1 Touch on the individual photos you want to delete.
  - A checkmark ✓ will appear on the photos you touch. The total number of selected photos will appear next to the  icon.
  - Touch a selected photo to remove the checkmark. To remove all checkmarks at once, touch [Remove All] ➤ [Yes].
- 2 After selecting all the desired photos, touch [OK].

#### Options

**[Select]** Select individual photos to delete.

**[All Photos]** Delete all the photos.

#### IMPORTANT

- Be careful when deleting photos. Deleted photos cannot be recovered.
- Photos that were protected with other devices cannot be deleted with this camcorder.

## Copying Recordings to a Memory Card



To copy your recordings, you must select recordings in the built-in memory or on memory card **A**. In either case, the recordings will be copied to memory card **B**. Scenes and photos will be copied from the index screen or from a story in the gallery on the source memory to the same index screen or story on memory card **B**.

Please read the IMPORTANT section (📖 126) before using an Eye-Fi card.

## Copying Scenes from the Date Index Screen

Operating modes:    |  

1 Open the date index screen (📖 91).

- Check that you have selected the  tab (built-in memory) or  tab (memory card **A**).
- To copy all the scenes recorded on a specific date, drag your finger left/right until the desired date appears in the title bar.

2 Open the screen to copy scenes.

[Edit] ➤ [Copy ( ➤ )] or [Copy ( ➤ )]

3 Touch the desired option and then touch [Yes].

- When you select [Select], perform the following procedure to select the individual scenes you want to copy before touching [Yes].
- Touch [Stop] to interrupt the operation while it is in progress.

4 Touch [OK].

### To select individual scenes

1 Touch on the individual scenes you want to copy.

- A checkmark ✓ will appear on the scenes you touch. The total number of selected scenes will appear next to the  icon.
- Touch a selected scene to remove the checkmark. To remove all checkmarks at once, touch [Remove All] ➤ [Yes].

2 After selecting all the desired scenes, touch [OK].

### Options











**[date]** Copy all the scenes recorded on the date shown in the control button.

**[Select]** Select individual scenes to copy.

**[All Scenes]** Copy all the scenes.









## Copying Scenes from a Story by Rating

Operating modes:    |  

- 1 Open the gallery and bring the desired story to the front.  
[] > [ Gallery] > Desired story
  - Check that you have selected the  tab (built-in memory) or  tab (memory card ).
- 2 Open the [Play by Rating] screen.  
[Story Details] > [Play by Rating]
- 3 Touch the desired rating and then touch [].
- 4 Open the screen to copy scenes.  
[Edit Story] > [Copy ( > )] or [Copy ( > )]
- 5 Touch [Yes].
  - Touch [Stop] to interrupt the operation while it is in progress.
  - The selected scenes are copied.
- 6 Touch [OK] and then touch [].

## Copying a Single Photo



Operating modes:    |  

- 1 In single photo view, select the photo you want to copy.
  - Check that you are viewing photos recorded in the built-in memory or on memory card .  
( or  appears next to the photo number.)
- 2 Touch the screen to display the playback controls.
- 3 Open the screen to copy photos.  
[Edit] > [Copy ( > )] or [Copy ( > )]
- 4 Touch [ Proceed] and then touch [Yes].
  - The photo is copied.
- 5 Drag your finger left/right to select another photo to copy or touch [].

## Copying Photos from the Index Screen

Operating modes:    |  

1 Open the [Photos] index screen ( 91).

- Check that you have selected the  tab (built-in memory) or  tab (memory card **A**).

2 Open the screen to copy photos.

[Edit]  [Copy ( )] or [Copy ( )]



3 Touch the desired option and then touch [Yes].

- When you select [Select], perform the following procedure to select the individual photos you want to copy before touching [Yes].
- Touch [Stop] to interrupt the operation while it is in progress.
- The selected photos are copied.

4 Touch [OK].

### To select individual photos

1 Touch on the individual photos you want to copy.

- A checkmark  will appear on the photos you touch. The total number of selected photos will appear next to the  icon.
- Touch a selected photo to remove the checkmark. To remove all checkmarks at once, touch [Remove All]  [Yes].

2 After selecting all the desired photos, touch [OK].

### Options

**[Select]** Select individual photos to copy.

**[All Photos]** Copy all the photos.

### IMPORTANT

- Observe the following precautions while the ACCESS indicator is on or flashing. Failing to do so may result in permanent data loss.
  - Do not open the double memory card slot cover.
  - Do not disconnect the power source or turn off the camcorder.
  - Do not change the camcorder's operating mode.
- If supported recordings are copied onto an Eye-Fi card in memory card slot **B**, wireless upload will start automatically if you are within the range of a configured network. Always verify that Eye-Fi cards have been approved in the country/region of use. See also *Using an Eye-Fi card* ( 136).

### NOTES

- In the following cases, you will not be able to copy recordings to the memory card:
  - If the double memory card slot is open.
  - If the LOCK switch on memory card **B** is set to prevent writing.
  - If there is no memory card in memory card slot **B**.
- Scenes that were edited using the supplied software **VideoBrowser** and were then transferred back to the camcorder cannot be copied to the memory card.
- If there is not enough space on memory card **B**, as many photos as possible will be copied before stopping the operation.

## Saving Recordings on a Computer

Movies recorded with this camcorder are saved in the built-in memory or on a memory card. Because space is limited, make sure to save your recordings on a computer on a regular basis.

Use the supplied software **VideoBrowser** to save your movies and the supplied software **ImageBrowser EX** to save your photos.

### Saving Movies (Windows only)

With the supplied software **VideoBrowser** you can save to your computer the scenes you have recorded. **VideoBrowser** offers also many options for organizing your video library, editing video, creating discs and more.

### Installation

Install the software before you connect the camcorder to the computer for the first time. Refer to the Startup Guide (supplied leaflet) and follow the instructions in the Software Guide (PDF file) to install the supplied PIXELA's software.

### Connecting the Camcorder to a Computer

Operating modes:    |  

#### 1 Power the camcorder using the compact power adapter.

- If the camcorder is connected to the computer while it is powered only by the battery pack, previously saved video files cannot be transferred back to the camcorder and music files cannot be transferred from the supplied VIXIA CD-ROM to a memory card in the camcorder.

#### 2 Open the date index screen ( 91).



#### 3 Connect the camcorder to the computer using the supplied USB cable.

- Connection . Refer to *Connection Diagrams* ( 118).

#### 4 Camcorder: Select [All (for PC only)].

- Camcorder: When the connection is successfully established, [USB Connection] appears on the screen.

#### 5 Computer: **VideoBrowser** will start up automatically.

- Click  in the menu panel to start transferring files. For details about using the software, click  to open the Software Guide (PDF file).

## Saving Photos (Windows/Mac OS)

With the supplied software **ImageBrowser EX** you can save photos to your computer and easily organize them. The main system requirements are as follows.

OS	CPU	Memory
Windows 8 (32/64-bit)	1.6 GHz	1 GB (for 32-bit) 2 GB (for 64-bit)
Windows 7 (SP1, 32/64-bit)		
Windows Vista (SP2, 32/64-bit)		1 GB
Windows XP (SP3, 32-bit only)		512 MB
Mac OS X v10.7, v10.8	Intel® Core™ Duo, 1.83 GHz	2 GB
Mac OS X v10.6		1 GB

## Installation

Install the software before you connect the camcorder to the computer for the first time. Make sure to install the software even if you have a different version of **ImageBrowser EX** on your computer. The auto-update function of the software may make available to you features optimized for this camcorder. The 'ImageBrowser EX' User Guide will also be installed with the software.



### POINTS TO CHECK

- Before installing the software, make sure your computer is connected to the Internet.
- 1 Insert the VIXIA CD-ROM into the computer's disc drive.
  - 2 Windows: Open the drive into which you inserted the CD-ROM using Windows Explorer.  
Mac OS: Use Finder and click the CD-ROM icon.
  - 3 Click/Double-click the Disc\_Setup icon .
  - 4 Follow the onscreen instructions to select your area (continent), country/region and language.
    - Available options will vary depending on your country/region.
  - 5 In the main installer panel click [Easy Installation].
    - For Windows users, if a User Account Control dialog box appears, follow the instructions.
  - 6 Follow the onscreen instructions to complete the installation.
    - During the installation process, you may be prompted to install Microsoft Silverlight. Follow the instructions to do so.

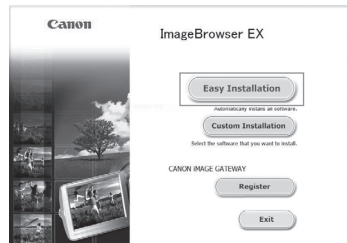



## To check that the software was installed correctly

You can check that the software was installed correctly by looking for the **ImageBrowser EX** icon in the following location.

**Windows 7, Windows Vista, Windows XP:** From the Start menu, All Programs > Canon Utilities > ImageBrowser EX

**Windows 8:** On the Desktop screen.

**Mac OS X:** In the Dock, on the Desktop.





If you cannot find the icon, check your Internet connection and install the software again.

## First-time connection to a computer running Windows

The first time you connect the camcorder to the computer, you also need to select the CameraWindow auto-launch setting.

## Connecting the Camcorder to a Computer

Operating modes:    |  



- 1 Power the camcorder using the compact power adapter.
- 2 Open the [Photos] index screen ( 91).
  - Select in advance the memory that contains the photos you want to save.
- 3 Connect the camcorder to the computer using the supplied USB cable.
  - Connection  4]. Refer to *Connection Diagrams* ( 118).
  - Camcorder: When the connection is successfully established, [USB Connection] appears on the screen.
- 4 Save the photos onto the computer.
  - Refer to relevant sections in the 'ImageBrowser EX' User Guide.



### IMPORTANT

- **When the camcorder is connected to a computer:**
  - Do not open the double memory card slot cover and do not remove the memory cards.
  - Do not access, change or delete any of the camcorder's folders or files directly from the computer as this may result in permanent data loss. Always use only the supplied software to save your movies on the computer and, if necessary, to transfer back previously saved video files to the camcorder.
- Observe the following precautions while the ACCESS indicator is on or flashing. Failing to do so may result in permanent data loss.
  - Do not open the double memory card slot cover.
  - Do not disconnect the USB cable.
  - Do not turn off the camcorder or the computer.
  - Do not change the camcorder's operating mode.
- When transferring back previously saved video files to the camcorder, do not disconnect the USB cable or turn off the camcorder or computer. Doing so may result in scenes that cannot be played back on the camcorder.
- Operation may not work correctly depending on the software and the specifications/settings of your computer.
- If you wish to use the image files on your computer, make copies of them first. Use the copied files, retaining the originals.

 NOTES

- Refer also to the computer's instruction manual.
- With the supplied software **VideoBrowser**, you can also choose to save complete stories from the gallery. In such case, all the scenes in the story will be merged and saved as a single video file.
- **Users of Windows 8, Windows 7, Windows Vista, Windows XP and Mac OS X:**  
Your camcorder is equipped with the standard Picture Transfer Protocol (PTP) allowing you to transfer photos (JPEG only) simply by connecting the camcorder to a computer using the supplied USB cable, without having to install the supplied software **ImageBrowser EX**.
- If you connect the camcorder to the computer while it is set to  mode, the process of creating scene thumbnails will start automatically. If your intention was to save photos to the computer, you can touch [Skip] to stop the process and use the computer's Safely Remove Hardware function (Windows) or Eject function (Mac OS) to end the connection to the camcorder. Disconnect the USB cable, set the camcorder to  mode and restore the connection.

## Copying Recordings to an External Video Recorder



Operating modes:    |  

### In High Definition

Connect the camcorder to Blu-ray Disc recorders and other AVCHD-compatible digital video recorders using the supplied USB cable to make perfect copies of your movies in high definition. If the external digital video recorder has an SD memory card slot\*, you can use the memory card to copy your movies without connecting the camcorder.

\* Make sure the external device is compatible with the type of memory card used.

### Connecting

- 1 Power the camcorder using the compact power adapter.
- 2 Open the date index screen or gallery ( 91).
- 3 Connect the camcorder to the digital video recorder using the supplied USB cable.
  - Connection  4. Refer to *Connection Diagrams* ( 118).
- 4 Camcorder: Select the memory that contains the scenes you want to copy.
  - Select an option other than [All (for PC only)].
  - Camcorder: When the connection is successfully established, [USB Connection] appears on the screen.

### Recording

Details will vary depending on the device used so be sure to refer to the instruction manual of the digital video recorder.





### In Standard Definition

You can copy your movies by connecting the camcorder to a VCR or a digital video recorder with analog audio/video inputs. Video output will be in standard definition, although the original scenes are in high definition.

### Connecting

Connect the camcorder to the VCR using Connection  3. Refer to *Connection Diagrams* ( 118).

### Recording

- 1 External recorder: Load a blank cassette or disc and set the recorder to record pause mode.
- 2 Turn on the camcorder and set it to  mode.
  - We recommend powering the camcorder using the compact power adapter.
  - Verify that   [AV/Headphones] is set to [ AV AV].
- 3 Camcorder: Locate the scene or story you wish to copy and pause the playback just before the desired scene.

**4 Camcorder: Resume playback.**

- By default, onscreen displays will be embedded in the output video signal. You can change this using the  [Output Onscreen Displays] setting.

**5 External recorder: Start recording when the scene you wish to copy appears; stop recording when it ends.**

**6 Camcorder: Stop playback.**

## Uploading Recordings to the Web

In order to share your high-definition scenes on YouTube and Facebook, you need to convert them to standard definition. This conversion can be completed in the camcorder itself or on a computer using the supplied software **VideoBrowser**. Photos can be uploaded using the supplied software **ImageBrowser EX** (📖 137).



### POINTS TO CHECK

- Make sure the supplied software **VideoBrowser** is correctly installed before you connect the camcorder to the computer for the first time. Refer to the Startup Guide (supplied leaflet) and follow the instructions in the Software Guide (PDF file) to install the supplied PIXELA's software.



## Converting Scenes into Standard Definition from the Date Index Screen

Operating modes: **AUTO** **M** **CINEMA** | **📺** **📷**

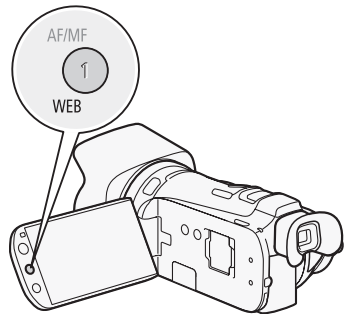
- 1 Power the camcorder using the compact power adapter.
- 2 Make sure there is a memory card in memory card slot **B** with sufficient available space.
- 3 Open the date index screen (📖 91).
  - Check that you have selected the **📷** tab (built-in memory) or **A** tab (memory card **A**).
  - To convert all the scenes recorded on a specific date, drag your finger left/right until the desired date appears in the title bar.
- 4 Press **[WEB]** to convert all the scenes recorded in the selected date. Alternatively, touch **[Edit]** ➤ **[Convert HD➔SD (📷➔B)]** or **[Convert HD➔SD (A➔B)]** and select one of the options for converting multiple scenes.
  - You can convert all the scenes recorded on the date shown in the control button, select individual scenes to convert or convert all the scenes.
  - When you select **[Select]**, perform the procedure described below to select the individual scenes you want to convert.
  - If a copyright notice appears, read it carefully and touch **[OK]** if you agree.
- 5 Review the conversion settings and touch **[Next]**.
  - The number and estimated size of the converted SD movies will be displayed on the screen, within the **B** box.
  - Before touching **[Next]**, you can touch **[👉]** to change the conversion settings as described below.
- 6 Touch **[START]** to convert the scenes.
  - Before touching **[START]**, you can touch **[🎨]** to add graphical elements to the converted SD movies (📖 103), or touch **[🔊]** to adjust the volume (📖 88) and background music balance (📖 111).
  - You can also decorate the scenes as they are being converted.
  - Touch **[STOP]** to interrupt the operation while it is in progress.



**7 When the conversion is completed, a confirmation screen will appear.**

- Continue the procedure if you want to connect the camcorder to the computer and upload your videos immediately.
- Alternatively, you can touch [End Without Connecting] to connect the camcorder to a computer at a later time. When you are ready to upload your movies, set the camcorder to  mode and save your movies and SD movies ( 127). Then, use the supplied software **VideoBrowser** to upload your recordings to the Web.

**8 Connect the camcorder to the computer using the supplied USB cable.**



- Connection . Refer to *Connection Diagrams* ( 118).

**9 Computer: VideoBrowser will start up automatically.**

- Follow the software's instructions to upload your SD movies to the Web. For details about using the software, click  to open the Software Guide (PDF file).

**To select individual scenes (step 4)**

**1 Touch on the individual scenes you want to convert.**

- A checkmark  will appear on the scenes you touch. The total number of selected scenes will appear next to the  icon.
- Touch a selected scene to remove the checkmark. To remove all checkmarks at once, touch [Remove All]  [Yes].

**2 After selecting all the desired scenes, touch [OK].**

**To select the bit rate (step 5)**

Using a higher bit rate will result in better video quality for the converted scenes, while a lower bit rate will result in smaller file sizes and faster uploads.

**1 Touch .**

**2 Touch [Bit Rate (Quality)].**

**3 Touch the desired option and then touch  twice.**

**To automatically divide scenes (step 5)**

If you are converting a long scene, you can have the camcorder divide it into 10-minute SD movies to make uploading easier.

**1 Touch .**

**2 Touch [Auto Divide].**

**3 Touch [On] and then touch  twice.**









 **IMPORTANT**

- While the camcorder is connected to the computer, do not open the double memory card slot cover and do not remove the memory cards.
- Observe the following precautions while the ACCESS indicator is on or flashing. Failing to do so may result in permanent data loss.
  - Do not open the double memory card slot cover.
  - Do not disconnect the USB cable.
  - Do not disconnect the compact power adapter or turn off the camcorder or the computer.

### NOTES

- The time required to convert scenes is approximately equal to the total playback time of the converted scenes. In most cases this is still faster than converting the scenes in the computer so we recommend you convert scenes in the camcorder.
- The maximum total playback time of the scenes to be converted to standard definition is 12 hours.
- Video snapshot scenes and photos cannot be captured from scenes converted to standard definition.
- Scenes cannot be converted to standard definition when memory card **B** already contains the maximum number of folders or scenes ( 145).
- You can play back and delete the converted SD movies from the [SD Movies] index screen on the memory card used for the conversion.



## Converting Scenes into Standard Definition from a Story by Rating

- 1 Open the gallery and bring the desired story to the front.  
  Gallery  Desired story
  - Check that you have selected the  tab (built-in memory) or  tab (memory card **A**).
- 2 Open the [Play by Rating] screen.  
 [Story Details]  [Play by Rating]
- 3 Touch the desired rating and then touch [].
- 4 Press  and continue the conversion to standard definition from step 5 in the previous procedure ( 133).

### NOTES

- **When converting scenes from a story:**
  - All the scenes are merged into one converted SD movie.
  - If the converted SD movie is too large, it will be split into smaller 10-minute long movies when [Auto Divide] ( 134) is set to [On].
  - The maximum total playback time of the scenes to be converted is 2 hours and 30 minutes.

## Converting Only Part of a Scene or Story

- 1 Play back the scene or story that you want to partially convert.
  - Check that you have selected a scene recorded in the built-in memory or on memory card **A**.
- 2 Pause the playback where you want the converted SD movie to begin.
- 3 Press  and continue the conversion to standard definition from step 5 in the previous procedure ( 133).
  - The video from the playback pause until the end of the scene/story (or up to a maximum of 10 minutes, in case of longer scenes/stories) will be converted to standard definition.











## Uploading your Videos Wirelessly

If you are using an Eye-Fi card, you can automatically upload movies to your favorite video sharing Web site. You will need to have installed the software supplied with your Eye-Fi card and completed all the required configuration setup in advance. Refer to the instruction manual of the Eye-Fi card. Also, note that not all Eye-Fi cards can upload AVCHD movies. Check compatibility in advance. Please read the IMPORTANT section before using an Eye-Fi card.

136

1 Insert your Eye-Fi card into memory card slot **B** and make sure there is sufficient available space on the memory card.

2 Set the camcorder to  mode.

- **To upload movies (AVCHD):** Scenes that were recorded on (or copied onto) memory card **B** will be automatically uploaded to the Web if you are within range of a configured network.
- **To upload SD movies:** Convert the desired scenes ( 133). At the end of the procedure, touch [End Without Connecting]. The converted SD movies on memory card **B** will be automatically uploaded to the Web if you are within range of a configured network.
- The status of the wireless communication is shown by the Eye-Fi icon as follows:
  -  (grayed out) Communication not established
  -  (white, flashing) Connecting;  (white, continuously on) Wireless upload on standby
  -  (animated) Wireless upload in progress
  -  [Eye-Fi Communication] is set to [OFF Off]
  -  Wireless upload stopped by the camcorder ( 158)
  -  Error reading from the Eye-Fi card ( 157)

### IMPORTANT



#### Using an Eye-Fi Card

- This product is not guaranteed to support Eye-Fi card functions (including wireless transfer). In case of an issue with an Eye-Fi card, please check with the card manufacturer. Also note that an approval is required to use Eye-Fi cards in many countries or regions. Without approval, use of the card is not permitted. If it is unclear whether the card has been approved for use in the area, please check with the card manufacturer.
- Do not use Eye-Fi cards on airplanes and in other places where wireless communication is forbidden. Remove the Eye-Fi card from the camcorder beforehand.

### NOTES

- Depending on the amount of data to be uploaded and the network's wireless connection conditions, it can take some time to upload video files. If the wireless connection is too weak, the wireless upload may fail and the video files will be registered as incomplete uploads.
- **About power saving:**
  - Wireless communication drains the power of the battery pack faster than usual. We recommend powering the camcorder using the compact power adapter.
  - While files are being uploaded wirelessly, the camcorder's automatic power off function will be disabled.
- Wirelessly uploading files is not possible when the Eye-Fi card is in memory card slot **A** (the Eye-Fi icon will not appear on the screen). Be sure to insert the Eye-Fi card into memory card slot **B**.
- While using an Eye-Fi Card, the ACCESS indicator may flash from time to time.
- Wireless communication is available only in playback mode. Any wireless transfer in progress will be stopped if you set the camcorder to recording mode.



- Wireless communication is not available when the optional WM-V1 Wireless Microphone is attached to the camcorder. Any wireless transfer in progress will be stopped the moment you attach the WM-V1 to the camcorder.
- You can turn off the wireless communication with the  [Eye-Fi Communication]\* setting.
- If the LOCK switch on the Eye-Fi card is set to prevent writing, you will not be able to turn the wireless communication on/off and the status icon will change to . To use wireless communication make sure the switch on the Eye-Fi card is not in the LOCK position.

\* This menu option will appear only when using an Eye-Fi card.

## Uploading Photos to the Web

With the supplied software **ImageBrowser EX**, you can upload your photos to Facebook after saving them on your computer. Additionally, you can use CANON iMAGE GATEWAY\* to make photo albums and more. After saving your photos on a computer ( 128), refer to the relevant sections in the 'ImageBrowser EX' User Guide (PDF file).

\* This service may not be available in all countries/regions.

## Installation

Install the software before you connect the camcorder to the computer for the first time. The software is compatible with computers running Windows or Mac OS operating systems. Refer to *Saving Photos (Windows/Mac OS)* ( 128).

# 10 Additional Information







































## Appendix: Menu Options Lists

Menu items not available appear grayed out. For details about how to select an item, refer to *Using the Menus* (□ 29). For details about each function, see the reference page. Menu options without a reference page are explained after the tables. Underlined menu options indicate default values.

138

### FUNC. Panel

#### FUNC. Panel - Recording Modes

Control Button	Setting options/Function	AUTO	M	CINEMA	
[MENU]	Open the menus	–	●	●	30
[Rec. Programs]	[ <b>P</b> Programmed AE], [ <b>TV</b> Shutter-Pri. AE], [ <b>AV</b> Aperture-Pri. AE], [ <b>M</b> Manual Exposure]	–	●	●	57, 59
	[  Portrait], [  Sports], [  Night Scene], [  Snow], [  Beach], [  Sunset], [  Low Light], [  Spotlight], [  Fireworks]	–	●	–	64
[  BLC Always On]	[ <b>ON</b> On], [ <b>OFF</b> Off]	–	●	●	61
[WB White Balance]	[ <b>AWB</b> Automatic], [  Daylight], [  Shade], [  Cloudy], [  Fluorescent], [  Fluorescent H], [  Tungsten], [ <b>K</b> Color Temperature], [  Set 1], [  Set 2]	–	●	●	62
[ <b>AGC</b> AGC Limit]	[ <b>A</b> Automatic], [ <b>M</b> Manual]	–	●	●	56
[  Focus]	Touch AF frame; [ <b>MF</b> ] (manual focus): Toggle on or <u>off</u> ; [ <b>PEAK</b> ] (peaking): Toggle on or off; [  ] (settings): [Peaking and B&W], [Peaking Color] When [ <b>MF</b> ] is on - [SET] (focus preset), [ <b>WFM</b> ] (edge monitor) When [SET] is on - [ON] (return to preset focus position)	–	●	●	47
[  Exposure]	Touch AE frame; [ <b>M</b> ] (manual adjustment): Toggle on or <u>off</u> , [  ] (settings): [AE Lock (touch)], [Zebra Pattern]; [  70] or [  100] (zebra pattern): Toggle on or <u>off</u> When [ <b>M</b> ] is on - [ <b>WFM</b> ] (waveform monitor), exposure adjustment dial	–	●	●	60
[ <b>AUDIO</b> Audio Scene] <sup>1, 2</sup>	[  Standard], [  Music], [  Speech], [  Forest and Birds], [  Noise Suppression]	●	●	●	68
	[  Custom Setting]	–	●	●	
[  Mic. Level] <sup>1</sup>	[ <b>A</b> Automatic], [ <b>M</b> Manual] [Audio Level Indicator]: Toggle on or <u>off</u>	–	●	●	69
[IS Intelligent IS]	[  With  ], [  Without  ]	●	–	–	40
[ZOOM]	Zoom controls, [START]/[STOP] control (for movies)	●	●	●	53
	[PHOTO] control (for photos)	●	●	–	
[Image Stabilizer]	[  Dynamic], [  Standard], [  Off]	–	●	●	55

Control Button	Setting options/Function	AUTO	M	CINEMA	
[Image Effects]	[ON], [OFF] When [ON] - [Color Depth], [Sharpness], [Contrast], [Brightness]: ±0 (-2 to +2)	-	●	-	66
[ Faders] <sup>1</sup>	[ Off], [ Fade Trigger/Once], [ Fade Trigger/ Always], [ Wipe/Once], [ Wipe/Always]	-	●	●	83
[ Decoration] <sup>1, 2</sup>	[ Pens and Stamps], [ Animated Stamps], [ Captions]	●	●	●	103
	[ (image mix): Toggle on or off, [ (pause live video)	●	●	-	
	[ (minimize toolbar)	●	●	●	
[ Story Creator] <sup>2</sup>	Story themes, [New Story]	●	●	●	99
[ Video Snapshot] <sup>2</sup>	[ On], [ Off]	●	●	●	80
[ Review Recording] <sup>1</sup>	-	-	●	●	43

<sup>1</sup> Option available only for recording movies.

<sup>2</sup> The setting is maintained when the camcorder is switched from or mode to mode.  
(Except for [ Custom Setting] under [AUDIO Audio Scene].)

### Edit Panel - Mode

Control Button	Date Index Screen	[SD Movies] Index Screen	Playback Pause	
[Copy ( → )] <sup>1</sup>	<date>, [Select], [All Scenes]	-	-	124
[Copy ( → )] <sup>1</sup>				
[Convert HD → SD ( → )] <sup>1</sup>	<date>, [Select], [All Scenes]	-	-	133
[Convert HD → SD ( → )] <sup>1</sup>				
[Delete] or []	<date>, [Select], [All Scenes]	[This Scene], [All Scenes]	[This Scene]	92
[Divide]	-	-	●	95

From the gallery:

Control Button	[Edit Story] from the [Story Details] screen	[Edit Scene] from the [Scene List] screen	Playback Pause	
[Copy ( → )] <sup>1</sup>	<by scene rating>	-	-	125
[Copy ( → )] <sup>1</sup>				
[Convert HD → SD ( → )] <sup>1</sup>	<by scene rating>	-	-	135
[Convert HD → SD ( → )] <sup>1</sup>				

Control Button	[Edit Story] from the [Story Details] screen	[Edit Scene] from the [Scene List] screen	Playback Pause	
[Delete] or []	<by scene rating>	[This Scene]	[This Scene]	92
[Delete Story] <sup>2</sup>	●	–	–	94
[Story Thumbnail] <sup>2</sup>	●	–	–	114
[Edit Title] <sup>2</sup>	●	–	–	115
[Copy]	–	●	–	113
[Move]	–	●	–	113
[Divide]	–	–	●	95
[Rating]	–	[★★★★], [★★★●], [★★●●], [●●●] (unrated), [— — —] (others)		109

<sup>1</sup> Operation not available for recordings on memory card ( tab).

<sup>2</sup> Operation not available for the two preexisting stories, [Unsorted] and [Video Snapshot].





Edit Panel - Mode

Control Button	Index Screen	Single Photo View	
[Copy ( → )]*	[Select], [All Photos]	●	125
[Copy ( → )]*			
[Delete]		●	123

\* Operation not available for recordings on memory card ( tab).

## Setup Menus

 Camera Setup

Menu item	Setting options	M	CINEMA	
[Digital Zoom] <sup>1</sup>	[ <b>OFF</b> Off], [ <b>40x</b> 40x], [ <b>200x</b> 200x], [ <b>20x</b> Digital Tele-conv.]	●	–	–
[Soft Zoom Control] <sup>2</sup>	[ <b>OFF</b> Off], [ <b>START</b> Start], [ <b>STOP</b> Stop], [ <b>START/STOP</b> Start & Stop]	●	●	54
[Zoom Speed Level] <sup>2</sup>	[ <b>Fast</b> Fast], [ <b>Normal</b> Normal], [ <b>Slow</b> Slow]	●	●	52
[Zoom Lever Zoom Speed] <sup>2</sup>	[ <b>VAR</b> ] (variable speed), [ <b>CONST</b> ] (constant speed) When [ <b>CONST</b> ] is selected: 1-16 (8)	●	●	52
[Wireless Ctrlr Zoom Speed] <sup>2</sup>	1-16 (8)	●	●	53
[AF Mode] <sup>2</sup>	[ <b>LAF</b> Instant AF], [ <b>MAF</b> Medium AF], [ <b>AF</b> Normal AF]	●	●	48
[Focus Assistance] <sup>1, 2</sup>	[ <b>ON</b> On], [ <b>OFF</b> Off]	●	●	–
[Face Detection & Tracking]	[ <b>ON</b> On  ], [ <b>OFF</b> Off]	●	●	49
[Auto Backlight Correction]	[ <b>ON</b> On], [ <b>OFF</b> Off]	●	●	61
[Auto Slow Shutter] <sup>2</sup>	[ <b>ON</b> On], [ <b>OFF</b> Off]	●	●	–
[ND Filter]	[ <b>A</b> Automatic], [ <b>OFF</b> Off]	●	●	–
[Conversion Lens] <sup>2</sup>	[ <b>Tele</b> Tele-converter], [ <b>Wide</b> Wide-converter], [ <b>OFF</b> Off]	●	●	–
[Fader Setting] <sup>1</sup>	[ <b>BLACK</b> Black Screen], [ <b>WHITE</b> White Screen]	●	●	83
[Onscreen Markers]	[ <b>OFF</b> Off], [ <b>W</b> Level (White)], [ <b>G</b> Level (Gray)], [ <b>W</b> Grid (White)], [ <b>G</b> Grid (Gray)]	●	●	–
[Auto Wind Screen] <sup>1</sup>	[ <b>H</b> High], [ <b>L</b> Low  ], [ <b>OFF</b> Off  ]	●	●	71
[Microphone Attenuator] <sup>1</sup>	[ <b>A</b> Automatic], [ <b>ON</b> On <b>ATT</b> ]	●	●	–
[MIC Terminal Input] <sup>1</sup>	[ <b>LINE</b> External Audio], [ <b>MIC</b> Microphone]	●	●	72
[Audio Mix] <sup>1</sup>	[ <b>OFF</b> Off], [ <b>ON</b> On] When [ <b>ON</b> On] is selected: [INT] ..... [EXT], [Internal Microphone]/[MIC Terminal Input]	●	●	72
[Built-in Mic Freq. Response] <sup>1</sup>	[ <b>NORM</b> Normal], [ <b>LB</b> Boost LF Range], [ <b>LC</b> Low Cut Filter], [ <b>MB</b> Boost MF Range], [ <b>LHB</b> Boost HF+LF Range]	●	●	71
[Built-in Mic Directionality] <sup>1</sup>	[ <b>2ch Mono</b> Monaural], [ <b>NORM</b> Normal], [ <b>2ch Wide</b> Wide], [ <b>2ch Zoom</b> Zoom]	●	●	70
[Surround Mic Directionality] <sup>1, 3</sup>	[ <b>5.1ch Surround</b> ], [ <b>5.1ch Zoom</b> ], [ <b>5.1ch Shotgun</b> ]	●	●	–

<sup>1</sup> Option available only for recording movies.

<sup>2</sup> The setting is maintained when the camcorder is switched from **M** or **CINEMA** mode to **AUTO** mode.

<sup>3</sup> Option available only when the optional SM-V1 Surround Microphone is attached to the camcorder after having updated the camcorder's firmware using the memory card supplied with the SM-V1.

**[Digital Zoom]:** Determines the operation of the digital zoom. The color of the indicator indicates the zoom.

- When [40x 40x] or [200x 200x] is selected, the camcorder will switch automatically to digital zoom when you zoom in beyond the optical zoom range.
- With the digital zoom the image is digitally processed, so the image resolution will deteriorate the more you zoom in.
- For an explanation of the digital tele-converter, see *Digital Tele-Converter* (54).

Optical zoom	Digital zoom	
White	Light blue	Dark blue
Up to 10x	10x - 40x	40x - 200x

**[Focus Assistance]:** When focus assistance is activated, the image at the center of the screen is magnified to help you focus manually (47).

- Using focus assistance will not affect the recordings. It will be cancelled automatically after 4 seconds or when you start recording.

**[Auto Slow Shutter]:** The camcorder automatically uses slow shutter speeds to obtain brighter recordings in places with insufficient lighting.

- Minimum shutter speed used: 1/30; 1/12 when the frame rate is set to [PF24 PF24] or [24P 24P]; 1/15 when it is set to [PF30 PF30].
- The auto slow shutter can only be activated when the recording program is set to [P Programmed AE], but the setting will not change even if you set the camcorder to [AUTO] mode.
- If a trailing afterimage appears, set the slow shutter to [OFF Off].

**[ND Filter]:** Only available during the [Av Aperture-Pri. AE] and [M Manual Exposure] recording programs. When set to [A Automatic], the ND filter can be selected when adjusting the aperture. Depending on the selected setting, [ND1/2], [ND1/4] or [ND1/8] will appear on the screen next to the aperture value.

**[Conversion Lens]:** When you attach to the camcorder the optional TL-H58 Tele-converter or WD-H58W Wide-converter, set the appropriate conversion lens setting. The camcorder will then optimize the image stabilization and adjust the minimum object distance. The minimum object distance throughout the entire zoom range will be 130 cm (4 ft. 3 in.) for the TL-H58 and 40 cm (1 ft. 3 in.) for the WD-H58W.

- When you select a setting other than [OFF Off], the AF mode is automatically set to [AF Normal AF].
- The approximate subject distance displayed on the screen will change depending on the setting. If you are not using a conversion lens, select [OFF Off].

**[Onscreen Markers]:** You can display a grid or a horizontal line at the center of the screen. Use the markers as a reference to make sure your subject is framed correctly (vertically and/or horizontally).

- Using the onscreen markers will not affect the recordings.

**[Microphone Attenuator]:** Helps prevent audio distortions. You can use this setting when using an external microphone or when [AUDIO Audio Scene] is set to [Jc Custom Setting].

[A Automatic]: The camcorder will automatically activate the microphone attenuator as necessary for optimal audio recording levels so high audio levels will not be distorted.

[ON On [ATT] ]: The microphone attenuator will be activated at all times to reproduce more faithfully the sound dynamics. [ATT] will appear on the screen.

**[Surround Mic Directionality]:** Sets the directionality mode of the optional SM-V1 Surround Microphone.















**[5.1ch Surround]:** Records 5.1ch surround sound.

**[Zoom]:** Records 5.1 audio channels. Additionally, the audio is linked to the zoom position. The larger the subject appears on the screen, the louder the sound will be as well.

**[Sound]:** Shotgun): Records monaural audio with a highly directional setting that is most sensitive to sound coming directly from the front of the camcorder/microphone.

## / Playback Setup

143

Menu item	Setting options			
[Select Music]	[OFF Off], [ON On] <sup>1</sup> When [ON On] - list of music tracks,  .....  (Original sound/Background music)	●	●	110
[External Audio Input]	[OFF Off], [ON On  When [ON On  ] - [External Player Link]: Toggle on or off	●	●	111
[Data Code]	[OFF Off], [  Date], [  Time], [  Date and Time], [  Camera Data]	●	●	-
[Slideshow Transition]	[OFF Off], [  Dissolve], [  Slide Image]	-	●	122
[TV Type] <sup>2</sup>	[  4:3 TV], [  Wide TV]	●	●	-

<sup>1</sup> Default in  mode.

<sup>2</sup> Option not available when the camcorder is connected to an HDTV using the supplied High Speed HDMI cable.

**[Data Code]:** Displays the date and/or time when the scene or photo was recorded.

**[ Camera Data]:** Displays the aperture (f-stop) and shutter speed used when recording the scene or photo.

**[TV Type]:** When you connect the camcorder to a TV using the supplied STV-250N Stereo Video Cable, select the setting according to the type of TV in order to display the picture in full and in the correct aspect ratio.

**[4:3] 4:3 TV]:** TV sets with 4:3 aspect ratio.

**[16:9] Wide TV]:** TV sets with 16:9 aspect ratio.

- When the TV type is set to **[4:3] 4:3 TV],** during the playback of video originally recorded with an aspect ratio of 16:9, the picture will not be displayed fullscreen.

Recording & Connections Setup

Menu item	Setting options	M	CINEMA			
[Self Timer]	[ON] On , [OFF] Off	●	●	–	–	67
[Video Snapshot Length] <sup>1, 2</sup>	[2sec] 2 sec], [4sec] 4 sec], [8sec] 8 sec], [Story Length-Based]: Toggle on or off	●	●	–	–	80, 97
	[2sec] 2 sec], [4sec] 4 sec], [8sec] 8 sec]	–	–	●		
[Rate Scenes (Recording)] <sup>1, 2</sup>	[ON] On], [OFF] Off]	●	●	–	–	109
[Rec Media for Movies] <sup>1, 2</sup>	(built-in memory), [A] (memory card A), [B] (memory card B), When set to  or [A]: [Relay Recording]: [OFF], → A],  → A → B], [A → B] When set to [A]: [Double Slot Rec]: [OFF], [ON]	●	●	–	–	34
[Recording Mode] <sup>1, 2</sup>	[MXP High Quality 24 Mbps], [FXP High Quality 17 Mbps], [XP+ High Quality 12 Mbps], [SP Standard Play 7 Mbps], [LP Long Play 5 Mbps]	●	●	–	–	45
[Frame Rate] <sup>1, 2, 3</sup>	[60i] 60i (Standard)], [PF24] PF24], [PF30] PF30], [24P] 24P]	●	●	–	–	46
[Rec Media for Photos] <sup>4</sup>	(built-in memory), [A] (memory card A), [B] (memory card B)	●	–	●	–	34
[Photo Capture from Video] <sup>4</sup>	<input type="checkbox"/> Single Photo], [] Photo Sequence]	–	–	●	–	98
[Scan Reverse Rec] <sup>1, 2</sup>	[OFF] Off], [V] Vertical], [H] Horizontal], [B] Both]	●	●	–	–	–
[Memory Info]	(built-in memory), [A] (memory card A), [B] (memory card B)	●	●	●	●	–
[x.v.Color]	[ON] On color], [OFF] Off]	●	●	–	–	–
[Color Bars & Test Tone] <sup>1</sup>	[OFF] Off], [] Color Bars], [] Color Bars & Tone]	●	●	–	–	78
[File Numbering] <sup>1</sup>	Reset], [] Continuous]	●	–	●	●	–

<sup>1</sup> The setting is maintained when the camcorder is switched from **M** or **CINEMA** mode to **AUTO** mode.

<sup>2</sup> Option available only for recording movies.

<sup>3</sup> Can be set independently for **M** and **CINEMA** mode. The default value in **CINEMA** mode is [**PF24** PF24].

<sup>4</sup> Option available only for recording photos.

**[Scan Reverse Rec]:** Inverts the recorded image horizontally, vertically or horizontally and vertically.

**[Memory Info]:** Displays a screen where you can verify how much of the built-in memory or the memory card is currently in use ( total recording time and total number of photos) and how much space remains available for recording.

- Estimated figures about available movie recording time and available number of photos are approximate and based on the recording mode currently in use and a photo size of 1920x1080.
- In the information screen of a memory card you can also check its Speed Class.
- The [Total space] shown for the built-in memory indicates actually usable space. It may be slightly smaller than the nominal built-in memory capacity listed in the specifications.





**[x.v.Color]:** Uses a color space with an extended gamut to achieve deeper colors, closer to real life.

- Use this function to record video only when you intend to play back your recordings on an HDTV compatible with x.v.Color, connected to the camcorder using the supplied High Speed HDMI cable. If recordings made with x.v.Color are played back on a non-compatible TV, colors may not be reproduced correctly.

**[File Numbering]:** Select the file numbering method to be used on a new memory card. Photos and SD movies are automatically assigned consecutive numbers from 0101 to 9900, and stored in folders containing up to 100 files. Folders are numbered from 101 to 998.

[ Reset]: File numbers will restart from 101-0101 every time you insert a new memory card.

[ Continuous]: File numbers will continue from the number following that of the last file recorded with the camcorder.

- If the memory card you insert already contains a file with a larger number, a new file will be assigned a number one higher than that of the last file on the memory card.
- We recommend using the [ Continuous] setting.
- The file number indicates the name and location of the file on the memory card. For example, the file name of a photo numbered 101-0107 is "IMG\_0107.JPG", stored under the folder "DCIM\101\CANON" while an SD movie with the same file number will have the file name "MVI\_0107.MPG".

System Setup

Menu item	Setting options	M	CINEMA			
[Output Onscreen Displays]	[ <b>ON</b> On], [ <b>OFF</b> Off]	●	●	●	●	–
[Language ] <sup>1</sup>	[Česky], [Dansk], [Deutsch], [Ελληνικά], [English], [Español], [Français], [Italiano], [Magyar], [Melayu], [Nederlands], [Norsk], [Polski], [Português], [Română], [Suomi], [Svenska], [Türkçe], [Русский], [Українська], [العربية], [فارسی], [ภาษาไทย], [简体中文], [繁體中文], [한국어], [日本語]	●	●	●	●	31
[LCD Brightness] <sup>1</sup>	*  *	●	●	●	●	–
[LCD Screen Dimmer] <sup>1</sup>	[ <b>ON</b> On], [ <b>OFF</b> Off]	●	●	●	●	–
[LCD Mirror Image] <sup>1</sup>	[ <b>ON</b> On], [ <b>OFF</b> Off]	●	●	–	–	–
[AV/Headphones] <sup>1</sup>	[ <b>AV</b> AV], [ Headphones]	●	●	●	●	73, 131
[Volume] <sup>1</sup>	[Speaker]: ,	–	–	●	●	88
	[Headphones]: ,	●	●	●	●	73
[Notification Sounds] <sup>1</sup>	[ High Volume], [ Low Volume], [ <b>OFF</b> Off]	●	●	●	●	–
[Wireless Remote Control] <sup>1</sup>	[ <b>ON</b> On], [ <b>OFF</b> Off	●	●	●	●	–
[Powered IS Button]	[ <b>ON</b> ] Press and Hold], [ <b>ON/OFF</b> ] Toggle On/Off]	●	●	–	–	–
[Custom Key/Dial]	[ Mic. Level], [ Tv/Av], [ <b>M</b> Manual Exposure], [ AGC Limit], [ Exposure], [ <b>OFF</b> Off]	●	●	–	–	84
[Assign Button 1] <sup>1</sup>	[ Powered IS], [ BLC Always On], [ Face Only AF], [ Story Creator], [ Video Snapshot], [ WB Priority], [ AF/MF], [ <b>OFF</b> Off]	●	●	–	–	85
[Assign Button 2] <sup>1</sup>	[ Powered IS], [ BLC Always On], [ Face Only AF], [ Story Creator], [ Video Snapshot], [ WB Priority], [ Pre REC], [ <b>OFF</b> Off]	●	●	–	–	–
[Set WB Priority]	[AWB Automatic], [ Daylight], [ Shade], [ Cloudy], [ Fluorescent], [ Fluorescent H], [ Tungsten], [ Color Temperature], [ Set 1], [ Set 2]	●	●	–	–	–
[Focus Ring Direction]	[ <b>NORM</b> Normal], [ <b>REV</b> Reverse]	●	●	–	–	–
[Focus Ring Response]	[ Fast], [ Normal], [ Slow]	●	●	–	–	–

Menu item	Setting options	M	CINEMA			
[Focus Preset Speed]	[ Fast], [ Normal], [ Slow]	●	●	–	–	–
[Autostart Decoration] <sup>1</sup>	[ <b>ON</b> On], [ <b>OFF</b> Off]	●	●	–	–	103
[Power Saving Mode] <sup>1</sup>	[Auto Power Off]: [ <b>OFF</b> Off], [ <b>ON</b> On] [Quick Start (Standby)]: [Off], [10 min], [20 min], [30 min]	●	●	●	●	–
[Initialize / ]	[ Built-in Mem.], [ <b>A</b> Mem. Card A], [ <b>B</b> Mem. Card B] [Complete Initialization]: Toggle on or <u>off</u>	●	●	●	●	36
[Time Zone/DST] <sup>1</sup>	[] (home time zone) or [] (travel time zone): [New York], list of world time zones [*] (DST adjustment): Toggle on or <u>off</u>	●	●	●	●	32
[Date/Time] <sup>1</sup>	[Date/Time]: – [Date Format]: [Y.M.D.], [M.D.Y], [D.M.Y] (Y- year, M- month, D- day) [24H]: Toggle on (24-hour clock) or <u>off</u> (12-hour clock)	●	●	●	●	31
[Battery Info]	–	●	●	●	●	–
[Control for HDMI] <sup>1, 2</sup>	[ <b>ON</b> On], [ <b>OFF</b> Off]	●	●	●	●	–
[HDMI 1080p Output] <sup>1, 2</sup>	[ <b>ON</b> On], [ <b>OFF</b> Off]	●	●	●	●	–
[HDMI Status]	–	●	●	●	●	–
[Distance Units]	[ <b>m</b> meters], [ <b>ft</b> feet]	●	●	–	–	–
[Backup Menu Settings ]	[Save], [Load]	●	●	–	–	86
[Demo Mode] <sup>1</sup>	[ <b>ON</b> On], [ <b>OFF</b> Off]	●	●	–	–	–
[Firmware]	–	–	–	–	●	–
[Eye-Fi Communication] <sup>3</sup>	[ <b>A</b> Automatic], [ <b>OFF</b> Off]	●	●	●	●	136

<sup>1</sup> The setting is maintained when the camcorder is switched from **M** or **CINEMA** mode to **AUTO** mode. (Except for some of the [Assign Button 1]/ [Assign Button 2] settings.)

<sup>2</sup> Option not available when the camcorder is connected to an HDTV using the supplied High Speed HDMI cable.

<sup>3</sup> Option available only after having inserted an Eye-Fi card into memory card slot **B**.

**[Output Onscreen Displays]:** When set to [**ON** On], the camcorder's onscreen displays will appear also on the screen of a TV or monitor connected to the camcorder.

**[LCD Brightness]:** Adjusts the brightness of the LCD screen.

- Changing the brightness of the LCD screen does not affect the brightness of your recordings or the brightness of the playback image on a TV.

**[LCD Screen Dimmer]:** When set to [**ON** On], the LCD screen is dimmed. Doing so is ideal when using the camcorder in locations where the LCD's illumination could become a nuisance to others. Hold [**DISP**] pressed down for about 2 seconds to restore the LCD screen to its previous brightness setting.



- Dimming the LCD screen does not affect the brightness of your recordings or the brightness of the playback image on a TV.
- When the screen dimmer is set to [**OFF** Off], the LCD screen will return to the brightness level that was in use before the screen was dimmed.

**[LCD Mirror Image]:** When set to [**ON** On], you can rotate the LCD panel 180 degrees to let the subject check the image while you record. While the LCD panel is rotated toward the subject you will not be able to decorate the scene.

**[Notification Sounds]:** A beep will accompany some operations like turning on the camcorder, the self-timer countdown, etc.

- While pre-recording ( 81) is activated, the camcorder will not emit any notification sounds.

**[Wireless Remote Control]:** Allows the camcorder to be operated with the wireless controller.

**[Powered IS Button]:** Determines the operation mode of the assignable button set to ( Powered IS) ( 55).

[**ON**] Press and Hold]: Powered IS will be activated while you hold the button pressed down.

[**ON/OFF**] Toggle On/Off]: Each press of the button will turn the Powered IS function on and off.

**[Set WB Priority]:** You can press an assignable button set to [**WB** WB Priority] to switch between the current white balance and the white balance setting selected for [Set WB Priority].

**[Focus Ring Direction]:** Changes the direction the focus ring needs to be turned.

**[Focus Ring Response]:** Selects the sensitivity of the response when operating the focus ring.

**[Focus Preset Speed]:** Determines the speed at which the focus changes to the preset position.





**[Power Saving Mode]:** Controls the camcorder's automatic power off settings.

[Auto Power Off]: In order to save power when the camcorder is powered by a battery pack, it will automatically shut off if left without any operation for 5 minutes.



- Approximately 30 seconds before the camcorder shuts off, [Auto Power Off] will appear.
- In standby mode, the camcorder will shut off after the time selected for the [Quick Start (Standby)] setting.

[Quick Start (Standby)]: Select whether to activate the Quick Start function ( 44) when you close the LCD panel in a recording mode and the length of time after which the camcorder will end the standby mode and shut off automatically.

- You can set Quick Start to [Off], for example, if the camcorder is set on a fixed position and you want to keep recording video with the LCD panel closed in order to conserve the battery's power.

**[Battery Info]:** When you are using a battery pack that is compatible with Intelligent System, this option displays a screen where you can verify the battery charge (as a percentage) and the remaining recording time (  mode) or playback time (,  mode).

**[Control for HDMI]:** Activates the HDMI-CEC (Consumer Electronics Control) function. When you connect the camcorder to an HDTV compatible with HDMI-CEC using the supplied High Speed HDMI cable, you can control the camcorder's playback using the remote control of the TV.

- If set to **[ON On]**, when the camcorder is connected to a compatible HDTV using the supplied High Speed HDMI cable, the video input on the TV will automatically be set to the camcorder's video input. Then, you can use the up/down/left/right buttons and the OK or SET button on the TV's remote control to play back your recordings.
- Depending on the TV set, additional settings may be required on the TV itself to activate the HDMI-CEC function. Refer to the TV's instruction manual.
- Correct operation of the HDMI-CEC function cannot be guaranteed even when connecting the camcorder to compatible TV sets. If you cannot use the remote control of the TV, set [Control for HDMI] to **[OFF Off]** and operate the camcorder directly or use the camcorder's wireless controller.
- The remote control of the TV can only be used to play back movies or photos ( or  mode only). If the camcorder is connected to the TV while it is set to **AUTO**, **M** or **CINEMA** mode, depending on the TV used, turning off the TV will automatically turn off the camcorder even if it is recording at the time.
- We recommend not connecting more than 3 HDMI-CEC compatible devices at a time.

**[HDMI 1080p Output]:** If set to **[ON On]**, when the camcorder is connected using the supplied High Speed HDMI cable to an HDTV that supports the 1080p standard, your video recordings (made in 1080i) will be converted and output as 1080p.

**[HDMI Status]:** Displays a screen where you can verify the standard of the output signal from the HDMI OUT terminal.

**[Distance Units]:** Selects the units to use for the focusing distance display during manual focus.

**[Demo Mode]:** The demonstration mode displays the camcorder's main features. It starts automatically when the camcorder is powered with the compact power adapter if you leave it turned on without a memory card for more than 5 minutes.

- To cancel the demo mode once it has started, press any button or turn off the camcorder.

**[Firmware]:** You can verify the current version of the camcorder's firmware. This menu option is usually unavailable.

## Appendix: Onscreen Icons and Displays

### **AUTO** Recording Movies (using Story Creator)

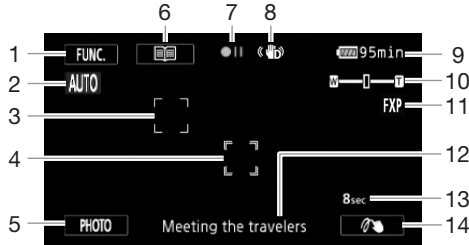

150

- 1 Control button [FUNC.]: Open the FUNC. panel (📖 29)
- 2 Smart AUTO (📖 40)
- 3 Face detection frame (📖 49)
- 4 Touch & Track frame (📖 51)
- 5 Control button [PHOTO]: Take a photo (📖 39, 98)
- 6 Control button [📖]: Return to the list of story scenes (📖 99)
- 7 Memory operation (📖 153)
- 8 Intelligent IS (📖 40)
- 9 Remaining battery time (📖 153)
- 10 Zoom (📖 53)
- 11 Recording mode (📖 45)
- 12 Current story scene (category) (📖 99)
- 13 Recommended scene length (📖 99)
- 14 Control button: Last FUNC. panel function used ([👉 Decoration] (📖 103) in this case)

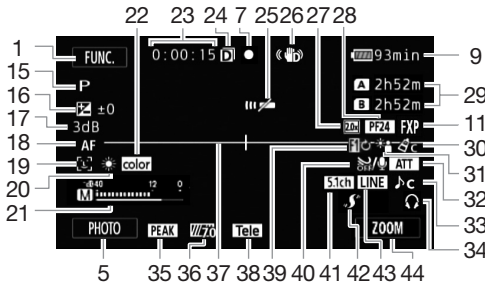
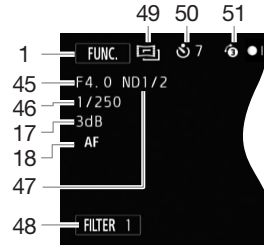
**[M]**, **[CINEMA]** Recording Movies**M** Manual mode**CINEMA** mode

- |    |   |    |  |
|----|---|----|--|
| 15 | Recording program ( 57, 64)   | 33 | Audio scene select ( 68)   |
| 16 | Exposure compensation ( 60)   | 34 | Headphone output ( 73)   |
| 17 | AGC limit ( 56); Gain (during the [M Manual Exposure] recording program) ( 59)  | 35 | Peaking ( 48)  |
| 18 | Autofocus mode ( 48); MF Manual focus ( 47)   | 36 | Zebra pattern ( 59)  |
| 19 | [ ] Face detection ( 49); [ ] Autofocus only for faces ( 50)  | 37 | Level marker ( 142)  |
| 20 | White balance ( 62)   | 38 | Conversion lens (Tele-converter shown) ( 142)  |
| 21 | Audio level indicator ( 69)   | 39 | Fader ( 83)  |
| 22 | x.v.Color ( 145)  | 40 | Auto wind screen off ( 71)   |
| 23 | While recording/during playback:<br>Scene counter (hours : minutes : seconds)   | 41 | Built-in microphone directionality ( 70); [51ch] Directionality of the optional SM-V1 Surround Microphone ( 143) |
| 24 | Double slot recording ( 36)   | 42 | Mini advanced shoe ( 74)   |
| 25 | Remote sensor off ( 148)  | 43 | External audio input from the MIC terminal ( 72)   |
| 26 | Image stabilizer ( 55)  | 44 | Control button: Last FUNC. panel function used ([ZOOM] in this case)   |
| 27 | Digital tele-converter ( 54)  | 45 | Aperture value ( 57, 59)   |
| 28 | Frame rate ( 46)  | 46 | Shutter speed ( 57, 59)  |
| 29 | Remaining recording time<br>[A]/[B] On the memory card<br>[ ] In the built-in memory<br>[ ]/[A] Relay recording ( 35) | 47 | ND filter ( 142)   |
| 30 | Image effects ( 66)   | 48 | Control button [FILTER 1]: Cinema-look filters ( 101)  |
| 31 | Backlight correction ( 61)  | 49 | [CINEMA] mode ( 101)   |
| 32 | Microphone attenuator ( 142)  | 50 | Self timer ( 67)   |
|    |   | 51 | Pre-recording ( 81)  |

 **Playing Movies (during playback)**

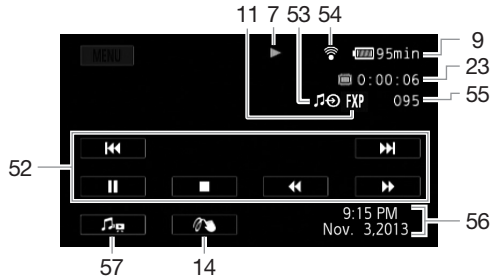



- 52 Playback control buttons (📖 88)
- 53 External audio input (📖 111)
- 54 Eye-Fi wireless communication (📖 136)

- 55 Scene number
- 56 Data code (📖 82, 143)
- 57 Volume and background music balance controls (📖 88, 111)

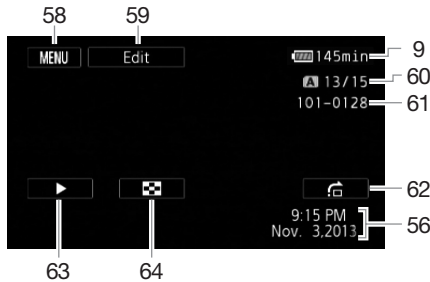
 **Viewing Photos**



- 58 Control button [MENU]: Open the setup menus (📖 30, 141)
- 59 Control button [Edit]: Open the Edit panel (📖 140)
- 60 Current photo / Total number of photos

- 61 File number (📖 145)
- 62 Control button []: Photo jump (📖 121)
- 63 Control button []: Slideshow (📖 122)
- 64 Control button []: Return to the [Photos] index screen (📖 120)

 **NOTES**

- You can press **[DISP.]** to turn off most icons and displays.



## 7 Memory operation

- Record, ●|| Record pause, ► Playback, || Playback pause, ►► Fast playback, ◀◀ Fast reverse playback, ► Slow playback, ◀ Slow reverse playback, ||► Frame advance, ◀|| Frame reverse.

## 9 Remaining battery time

- The icon shows a rough estimate of the remaining charge as a percentage of the full charge of the battery pack. The remaining recording/playback time of the battery pack is displayed, in minutes, next to the icon.

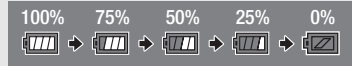

- When the battery charge becomes low, the icon will appear in yellow. When the battery pack is exhausted, the icon will appear in red. Replace or charge the battery pack.
- When you attach an empty battery pack, the power may turn off without displaying the icon.
- Depending on the conditions under which the camcorder and the battery pack are used, the actual battery charge may not be indicated accurately.
- When the camcorder is off, press **[BATT.INFO]** to display the charge status of a battery pack. The Intelligent System will display the charge status (as a percentage) and the remaining recording time (in minutes) for 5 seconds. If the battery pack is exhausted, the battery information may not be displayed.

## 29 Remaining recording time

When there is no more free space on the memory, **[A End]** (built-in memory), **[A End]** (memory card **A**) or **[B End]** (memory card **B**) will be displayed in red and the recording will stop.

## Troubleshooting

If you have a problem with your camcorder, refer to this section. Sometimes what you think is a malfunction of the camcorder may have the simplest of solutions - please read the "CHECK THIS FIRST" box before going on to the more detailed problems and solutions. Consult your dealer or a Canon Service Center if the problem persists.

### CHECK THIS FIRST

#### Power supply

- Is the battery charged? Is the compact power adapter correctly connected to the camcorder? (☐ 20)

#### Recording

- Did you turn the camcorder on and correctly set it to a recording mode? (☐ 38) If you are recording on a memory card, is one correctly inserted into the camcorder? (☐ 34)

#### Playback

- Did you turn the camcorder on and correctly set it to playback mode? (☐ 87, 120) If you are playing back recordings from a memory card, is one correctly inserted into the camcorder? (☐ 34) Does it contain any recordings?

#### Other

- Does the camcorder make a rattling sound? The internal lens fixture can move when the camcorder is turned off or in a playback mode. This is not a malfunction.

### Power source

#### The camcorder will not turn on or it turns off by itself.

- The battery pack is exhausted. Replace or charge the battery pack.
- Remove the battery pack and reattach it correctly.

#### Cannot charge the battery pack.

- Make sure the camcorder is off so charging can start.
- The temperature of the battery pack is outside its operating range (approximately 0 – 40 °C (32 – 104 °F)). Remove the battery pack, warm it or let it cool down, as necessary, and try charging it again.
- Charge the battery pack in temperatures between approximately 0 °C and 40 °C (32 °F and 104 °F).
- The battery pack is faulty. Replace the battery pack.
- The camcorder cannot communicate with the battery pack attached. Battery packs not recommended by Canon for use with this camcorder cannot be charged using this camcorder.
- If you are using a battery pack recommended by Canon for use with this camcorder, there may be a problem with the camcorder or battery pack. Consult a Canon Service Center.

#### A noise can be heard from the compact power adapter.

- A faint sound can be heard while the compact power adapter is connected to a power outlet. This is not a malfunction.

#### The battery pack is exhausted extremely quickly even at normal temperatures.

- The battery may have reached the end of its battery life. Buy a new battery pack.

## Recording

### Pressing **START/STOP** will not start recording.

- You cannot record while the camcorder is writing previous recordings onto the memory (while the ACCESS indicator is on or flashing). Wait until the camcorder has finished.
- The memory is full or it already contains the maximum number of scenes (3,999 scenes). Delete some recordings (□ 92, 123) or initialize the memory (□ 36) to free some space.

### The point where **START/STOP** was pressed does not match the beginning/end of the recording.

- There is a slight interval between pressing **START/STOP** and the actual start/end of recording. This is not a malfunction.

### The camcorder will not focus.

- Autofocus does not work on the subject. Focus manually (□ 47).
- The lens or Instant AF sensor is dirty. Clean the lens or sensor with a soft lens-cleaning cloth (□ 168). Never use tissue paper to clean the lens.

### When a subject flits across in front of the lens, the image appears slightly bent.

- This is a phenomenon typical of CMOS image sensors. When a subject crosses very quickly in front of the camcorder, the image may seem slightly warped. This is not a malfunction.

### Changing the operating mode between recording (●)/record pause (●||)/playback (▶) takes longer than usual.

- When the memory contains a large number of scenes, some operations may take longer than usual. Save your recordings (□ 127) and initialize the memory (□ 36).

### Movies or photos cannot be recorded properly.

- This may occur as movies and photos are recorded/deleted over time. Save your recordings (□ 127) and initialize the memory (□ 36).

### Cannot record a photo while recording movies.

- You cannot take photos in **CINEMA** mode, while the digital zoom is activated (□ 142), while fading in or fading out a scene (□ 83) or while using double slot recording (□ 36).

### After using the camcorder for a long time, it becomes hot.

- The camcorder may become hot after using it continuously for long periods of time; this is not a malfunction. If the camcorder becomes unusually hot or it becomes hot after using it only for a short while, it may indicate a problem with the camcorder. Consult a Canon Service Center.

### Cannot create a new story.

- A memory can contain a maximum of 98 user-created stories. Delete some stories from the gallery (□ 94) or select a different memory (□ 34).

## Playback

### Cannot copy/move scenes in a story.

- The memory is full. Delete some recordings (□ 92, 123) to free some space.

### Cannot delete a scene.

- You may not be able to delete scenes recorded or edited using another device.

### Deleting scenes takes longer than usual.

- When the memory contains a large number of scenes, some operations may take longer than usual. Save your recordings (□ 127) and initialize the memory (□ 36).

### Cannot capture a video snapshot scene from a movie.

- You cannot capture video snapshot scenes from scenes recorded or edited using another device.
- The memory is full. Delete some recordings (□ 92, 123) to free some space.

**When playing back scenes/slideshow with background music, the music track is not played back correctly.**

- This can occur when you transfer the music files to a memory card after repeatedly recording and deleting scenes (fragmented memory). Save your recordings (📄 127) and initialize the memory card (📄 36). Then, transfer the music files first and only then transfer the video files.
- Music tracks will not play back correctly if the connection was interrupted while transferring the music files to a memory card. Delete the music tracks and transfer the music files again.
- The transfer rate of the memory card used is too slow. Use a recommended memory card (📄 33).

**When playing scenes/a slideshow linked to external audio, the video playback is not correctly linked to the external player.**

- The volume of external player may be too low. Try increasing the volume of the external player.

**Cannot divide scenes**

- You cannot divide scenes recorded or edited using another device.
- The memory is full. Delete some recordings (📄 92, 123) to free some space.

**Cannot copy scenes/photos**

- You may not be able to copy scenes/photos recorded or edited using another device.

**Cannot mark individual scenes/photos in the index screen with a checkmark ✓**

- You cannot select more than 100 scenes/photos individually. Select the [All Scenes] or [All Photos] option instead of [Select].

## Indicators and Onscreen Displays

 lights up in red.

- Battery pack is exhausted. Replace or charge the battery pack.

 appears on the screen.

- The camcorder cannot communicate with the battery pack attached so the remaining battery time cannot be displayed.

 /  lights up in red.

- A memory card error occurred. Turn off the camcorder. Remove and reinsert the memory card. Initialize the memory card if the display does not change back to normal.
- The memory card is full. Replace the memory card or delete some recordings (📄 92, 123) to free some space on the memory card.

**Even after stopping recording, the ACCESS indicator does not go off.**

- The scene is being recorded in the memory. This is not a malfunction.

**The red ON/OFF (CHG) indicator flashes rapidly (🔴🔴🔴 one flash at 0.5-second intervals).**

- Charging has stopped because the compact power adapter or the battery pack is faulty. Consult a Canon Service Center.

**The red ON/OFF (CHG) indicator flashes very slowly (🔴.....🔴 one flash at 2-second intervals).**

- The temperature of the battery pack is outside its operating range (approximately 0 – 40 °C (32 – 104 °F)). Remove the battery pack, warm it or let it cool down, as necessary, and try charging it again.
- Charge the battery pack in temperatures between approximately 0 °C and 40 °C (32 °F and 104 °F).
- The battery pack is damaged. Use a different battery pack.

** appears on the screen**

- The LOCK switch on the Eye-Fi card is set to prevent accidental erasure. Change the position of the LOCK switch.
- An error occurred when trying to access control data on the Eye-Fi card. Turn the camcorder off then on again. If the icon appears often, there might be a problem with the Eye-Fi card. Contact the card manufacturer's customer care.

**Picture and Sound****The screen appears too dark.**

- The LCD screen was dimmed. Hold **[DISP]** pressed down for 2 seconds to restore the LCD screen to its previous brightness setting.

**Screen displays turn on and off repeatedly.**

- The battery pack is exhausted. Replace or charge the battery pack.
- Remove the battery pack and reattach it correctly.

**Abnormal characters appear on the screen and the camcorder does not operate properly.**

- Disconnect the power source and reconnect it after a short time. If the problem still persists, remove the battery pack and disconnect all other power sources from the camcorder. Then, press the RESET button with a pointed object to reset all the camcorder's settings to default values.

**Video noise appears on screen.**

- Keep a distance between the camcorder and devices that emit strong electromagnetic fields (plasma TVs, cellular phones, etc.).

**Horizontal bands appear on the screen.**

- This is a phenomenon typical of CMOS image sensors when recording under some types of fluorescent, mercury or sodium lamps. To reduce the symptoms, set the recording program to [Programmed AE] or [Shutter-Pri. AE] ( 57). This is not a malfunction.

**Viewfinder picture is blurred.**

- Adjust the viewfinder with the dioptic adjustment lever ( 22).

**No picture appears on the viewfinder.**

- Pull out the viewfinder to activate it.
- No picture will be output to the viewfinder if a cable is connected to the HDMI OUT, COMPONENT OUT or AV OUT/ terminal in playback mode. Remove the cable.

**Audio cannot be recorded.**

- When using a microphone connected to the MIC terminal, make sure the microphone is turned on. Also, make sure its battery is not exhausted.
- The audio recording level is not set correctly ( 69).



**Sound is distorted or is recorded at lower levels.**

- When recording near loud sounds (such as fireworks, shows or concerts), sound may become distorted or it may not be recorded at the actual levels. Adjust the audio recording level manually ( 69).

**There are brief stops in the sound recorded with the optional WM-V1 Wireless Microphone.**

- This may occur if the LOCK switch on the Eye-Fi card was set to prevent writing, causing wireless communication to occur while recording. Change the position of the LOCK switch.

**The picture is displayed correctly but there is no sound from the built-in speaker.**

- Speaker volume is turned off. Adjust the volume.
- If the STV-250N Stereo Video Cable is connected to the camcorder, disconnect it.
- The AV terminal is set to headphone output. Set   [AV/Headphones] to [AV].

## Memory Card and Accessories

### Cannot insert the memory card.

- The memory card was not facing the correct direction. Turn the memory card over and insert it.

### Cannot record on the memory card.

- The memory card is full. Delete some recordings (☐ 92, 123) to free some space or replace the memory card.
- Initialize the memory card (☐ 36) when you use it with the camcorder for the first time.
- The LOCK switch on the memory card is set to prevent accidental erasure. Change the position of the LOCK switch.
- A compatible memory card must be used to be able to record movies on a memory card (☐ 33).
- The folder and file numbers have reached their maximum value. Set [ ] ➤ [File Numbering] to [Reset] and insert a new memory card.

### The wireless controller will not work.

- Set [ ] ➤ [Wireless Remote Control] to [On].
- Replace the battery of the wireless controller.

### Cannot upload files wirelessly using an Eye-Fi card.

- You may have inserted the Eye-Fi card into memory card slot **A**. Insert it into memory card slot **B**.
- [ ] ➤ [Eye-Fi Communication] is set to [Off] (☹ appears onscreen). Set it to [Automatic].
- Wireless communication is not available in recording mode or while the optional WM-V1 Wireless Microphone is attached to the camcorder. Set the camcorder to playback mode or remove the WM-V1.
- Opening the LCD panel may help when the wireless connection is not strong enough.
- During wireless transfer, wireless communication may stop when the wireless signal conditions worsen (☹ appears onscreen). Perform wireless transfer in a place with good signal conditions.
- Contact the card manufacturer's customer care.

### The wireless communication status icon does not appear

- You may have inserted the Eye-Fi card into memory card slot **A**. Insert it into memory card slot **B**.

## Connections with External Devices

### Video noise appears on the TV screen.

- When using the camcorder in a room where a TV is located, keep a distance between the compact power adapter and the power or antenna cables of the TV.

### Playback looks fine on the camcorder but there is no image on the TV screen.

- The video input on the TV is not set to the video terminal to which you connected the camcorder. Select the correct video input.
- There will be no video output from the AV OUT terminal while an optional CTC-100 Component Cable is connected to the camcorder's COMPONENT OUT terminal. Disconnect the CTC-100 Component Cable in advance to use the AV OUT terminal.

### There is no sound from the TV.

- When connecting the camcorder to an HDTV using an optional CTC-100 Component Cable, make sure to connect also the audio connections using the white and red plugs of the STV-250N Stereo Video Cable.

The camcorder is connected using the supplied High Speed HDMI cable, but there is no picture or sound from the HDTV.

- Disconnect the High Speed HDMI cable and then restore the connection or turn the camcorder off and then on again.

The camcorder is connected using the supplied High Speed HDMI cable, but HDMI-CEC does not work (cannot play back using the TV's remote control).

- Disconnect the High Speed HDMI cable and turn off the camcorder and the TV. After a short while turn them on again and restore the connection.
-  [Control for HDMI] is set to [Off]. Set it to [On].
- HDMI-CEC is not activated on the connected TV. Activate this function on the TV.
- Even with TV sets compatible with HDMI-CEC the range of functions available differs depending on the type of TV. Refer to the instruction manual of the connected TV.

The computer does not recognize the camcorder even though the camcorder is connected correctly.

- Disconnect the USB cable and turn off the camcorder. After a short while, turn it on again and restore the connection.
- Connect the camcorder to a different USB port on the computer.

**Cannot save photos on my computer**

- When the memory contains too many photos (Windows – 2,500 photos or more, Mac OS – 1,000 photos or more), you may not be able to transfer photos to a computer. Try using a card reader to transfer the photos on the memory card. To transfer the photos in the built-in memory, copy them to the memory card in advance ( 126).

## List of Messages (in alphabetical order)



**Accessing the memory card. Do not remove the memory card.**

- You opened the double memory card slot cover while the camcorder was accessing the memory card or the camcorder started accessing the memory card as you opened the double memory card slot cover. Do not remove the memory card until this message disappears.

**Back up recordings regularly**

- This message may appear when you turn on the camcorder. In the event of a malfunction, recordings may be lost so back up your recordings regularly.





**Buffer overflow. Recording was stopped.**

- The data transfer rate was too high for the memory card in use and the recording was stopped. Replace the memory card with one rated SD Speed Class 2, 4, 6 or 10.
- After repeatedly recording, deleting and editing scenes (fragmented memory), it will take longer to write data on the memory and recording may stop. Save your recordings ( 127) and initialize the memory ( 36).

**Built-in memory error**

- The built-in memory could not be read. Contact a Canon Service Center.

**Built-in memory is full**

- The built-in memory is full ( End] appears on the screen). Delete some recordings ( 92, 123) to free some space. Alternatively, save your recordings ( 127) and initialize the built-in memory ( 36).

**Built-in memory writing error Attempt recovering the data?**

- This message will appear the next time you turn on the camcorder if power supply was accidentally interrupted while the camcorder was writing to the memory. Select [Recover] to try to recover the recordings.



**Cannot access the built-in memory**

- There is a problem with the built-in memory. Contact a Canon Service Center.

**Cannot communicate with the battery pack. Continue using this battery pack?**

- You attached a battery pack that is not recommended by Canon for use with this camcorder.
- If you are using a battery pack recommended by Canon for use with this camcorder, there may be a problem with the camcorder or battery pack. Consult a Canon Service Center.

**Cannot convert**

- Cannot access the memory card. Check the memory card and make sure it is inserted correctly.
- You inserted a MultiMedia Card (MMC) into the camcorder. Use a recommended memory card (□ 33).
- There was an error creating the file name. Set [  ] [  ] [File Numbering] to [Reset] and initialize the memory card (□ 36) or delete all the photos (□ 123) and converted SD movies (□ 92).

**Cannot copy**

- The total size of the scenes you selected to copy exceeds the available space on the memory card. Delete some recordings on the memory card (□ 92, 123) or reduce the number of scenes to copy.
- The memory card already contains the maximum number of scenes (3,999 scenes). Delete some scenes (□ 92) to free some space.
- The gallery already contains the maximum number of stories (98 stories in any one given memory). Delete some stories (□ 94) to free some space.

**Cannot divide the scene. Initialize only using the camcorder.**

- The scene could not be divided because the camcorder's internal scene management data log is full. Save your recordings (□ 127) and initialize the memory (□ 36). Transfer back the backup files and try dividing the scene again.
- Use the supplied software VideoBrowser to save the scene and divide it on the computer.

**Cannot enter standby mode now**

- The camcorder cannot enter standby mode if the remaining battery charge is too low. Charge or replace the battery pack (□ 20).

**Cannot load canvas**

- The canvas file that was saved on the memory is corrupted.
- Canvas data cannot be read from canvas files created using other devices.

**Cannot play back**

- You cannot play back scenes that were recorded or edited using another device and then written back to the built-in memory.
- If a memory card was recorded on with another device and then the LOCK switch was set to prevent writing, gallery information cannot be accessed correctly so playback is not possible from the gallery screen. Play back scenes from the date index screen or change the position of the LOCK switch on the memory card.
- There is a problem with the memory. If this message appears often without apparent reason, contact a Canon Service Center.

**Cannot play back Cannot access the built-in memory**

- There is a problem with the built-in memory. Save your recordings (□ 127) and initialize the built-in memory using the [Complete Initialization] option (□ 36). If the problem persists, contact a Canon Service Center.

**Cannot play back Check the memory card**

- There is a problem with the memory card. Save your recordings (□ 127) and initialize the memory card using the [Complete Initialization] option (□ 36). If the problem persists, use a different memory card.



**Cannot play the movies in the built-in memory Initialize only using the camcorder**

- The camcorder's built-in memory was initialized using a computer. Initialize the built-in memory with this camcorder (□ 36).

**Cannot play the movies on this memory card**

- Movies cannot be played back from a 64 MB or smaller memory card. Use a recommended memory card (□ 33).

**Cannot play the movies on this memory card Initialize only using the camcorder**

- The memory card in the camcorder was initialized using a computer. Initialize the memory card with this camcorder (□ 36).

**Cannot record**

- You cannot capture video snapshot scenes from scenes recorded or edited using another device.
- There is a problem with the memory. If this message appears often without apparent reason, contact a Canon Service Center.

**Cannot record Cannot access the built-in memory**

- There is a problem with the built-in memory. Save your recordings (□ 127) and initialize the built-in memory using the [Complete Initialization] option (□ 36). If the problem persists, contact a Canon Service Center.

**Cannot record Check the memory card**

- There is a problem with the memory card. Save your recordings (□ 127) and initialize the memory card using the [Complete Initialization] option (□ 36). If the problem persists, use a different memory card.

**Cannot record movies in the built-in memory Initialize only using the camcorder**

- The camcorder's built-in memory was initialized using a computer. Initialize the built-in memory with this camcorder (□ 36).

**Cannot record movies on this memory card**

- Movies cannot be recorded on a 64 MB or smaller memory card. Use a recommended memory card (□ 33).

**Cannot record movies on this memory card Initialize only using the camcorder**

- The memory card in the camcorder was initialized using a computer. Initialize the memory card with this camcorder (□ 36).

**Cannot save the canvas**

- Cannot save your [Pens and Stamps] drawings on the memory. Save your recordings (□ 127) and initialize the memory (□ 36).

**Change the battery pack**

- Battery pack is exhausted. Replace or charge the battery pack.

**Check the memory card**

- Cannot access the memory card. Check the memory card and make sure it is inserted correctly.
- A memory card error occurred. The camcorder cannot record or display the image. Try removing and reinserting the memory card, or use a different memory card.
- You inserted a MultiMedia Card (MMC) into the camcorder. Use a recommended memory card (□ 33).
- If after the message disappears, **A/B** appears in red, perform the following: Turn off the camcorder and remove and reinsert the memory card. If **A/B** turns back to green you can resume recording/playback. If the problem persists, save your recordings (□ 127) and initialize the memory card (□ 36).





**Do not disconnect the power source. Cannot write data with this connection. To write data to the camcorder, connect the compact power adapter then reconnect the camcorder and computer. Do not disconnect the USB cable unless you first use the computer to safely end the connection.**

- The camcorder cannot be operated while it is not being powered by the compact power adapter and is connected to a computer with the supplied USB cable. In addition, scenes cannot be written back and music files cannot be transferred to the camcorder. To avoid corrupting the data in the camcorder's memory, use the computer's Safely Remove Hardware function to end the connection and disconnect the USB cable before using the camcorder.
- To be able to write back scenes and to transfer music files to the camcorder, use the computer's Safely Remove Hardware function to end the connection, disconnect the USB cable, power the camcorder using the compact power adapter and only then connect it to the computer again.

**Do not disconnect the power source. Do not disconnect the USB cable unless you first use the computer to safely end the connection.**

- When the camcorder is in  mode and is connected to the computer with the supplied USB cable, the camcorder cannot be operated. Disconnecting the USB cable or power source while this message appears may result in permanent loss of the recordings in the camcorder. Use the computer's Safely Remove Hardware function to end the connection and disconnect the USB cable before using the camcorder.
- To be able to write back scenes and to transfer music files to the camcorder, power the camcorder using the compact power adapter and only then connect it to the computer using the supplied USB cable.

**File name error**

- The folder and file numbers have reached their maximum value. Set   [File Numbering] to [Reset] and delete all the photos on the memory card ( 123) or initialize it ( 36).

**Initialize only using the camcorder**

- There is a problem with the file system that prevents accessing the selected memory. Initialize the memory with this camcorder ( 36).

**LCD Screen has been dimmed**

- Hold  pressed for 2 seconds to restore the LCD screen to its previous brightness setting.

**May not be possible to record movies on this memory card**

- You may not be able to record movies on a memory card without a Speed Class rating or rated SD Speed Class 2. Replace the memory card with one rated SD Speed Class 4, 6 or 10.

**Mem. Card Number of scenes already at maximum**

- The memory card already contains the maximum number of scenes (3,999 scenes); no further scenes can be copied onto the memory card. Delete some scenes ( 92) to free some space.

**Mem. Card Unable to recognize the data**

- The memory card contains scenes recorded using a video configuration that is not supported (PAL or SECAM). Play back the recordings in the memory card with the device originally used to record them.

**Memory card cover is open**

- After inserting a memory card, close the double memory card slot cover.

**Memory card is full**

- The memory card is full. Delete some recordings ( 92, 123) to free some space or replace the memory card.

**Memory card is write-protected**

- The LOCK switch on the memory card is set to prevent accidental erasure. Change the position of the LOCK switch.

**Memory card writing error Attempt recovering the data?**

- This message will appear the next time you turn on the camcorder if power supply was accidentally interrupted while the camcorder was writing to the memory. Select [Recover] to try to recover the recordings. If you inserted a memory card that contains scenes recorded using another device, we recommend that you select [No].

**Need to recover files from the memory card. Change the position of the LOCK switch on the memory card.**

- This message will appear the next time you turn on the camcorder if power supply was accidentally interrupted while the camcorder was writing on the memory card and later the position of the card's LOCK switch was changed to prevent erasure. Change the position of the LOCK switch.

**No memory card**

- Insert a compatible memory card into the camcorder (☐ 34).

**No photos**

- There are no photos to play back.

**No scenes**

- There are no scenes in the memory selected.

**Not enough available space**

- Delete some recordings on the memory card (☐ 92, 123) or select the [3 Mbps] bit rate for the conversion to SD.

**Number of scenes already at maximum**

- The maximum number of scenes (3,999 scenes) has been reached. Delete some scenes (☐ 92) to free some space.

**Number of stories already at maximum**

- The gallery already contains the maximum number of stories (98 user-created stories in any one given memory). Delete some stories (☐ 94) or change the recording memory for movies (☐ 34).

**Scene recorded using another device. Cannot divide the scene.**

- Scenes that were not recorded with this camcorder cannot be divided with this camcorder.

**Scene recorded using another device. Cannot play back the scene.**

- Scenes that were not recorded with this camcorder cannot be played back.

**Select the desired scene number**

- A number of scenes have the same recording date but different file control information. This can occur, for example, when you edit movies on a computer and then transfer the files back to the camcorder. Select a number to display the corresponding group of scenes.

**Some scenes could not be converted**

- Some scenes selected for conversion to SD were recorded using another device. These scenes were not converted.
- Among the scenes selected for conversion to SD there are scenes recorded with the camcorder or another device using 24p frame rate. When converting scenes to SD, leave out scenes recorded using 24p frame rate.

**Some scenes could not be deleted**

- Movies that were protected/edited with other devices cannot be deleted with this camcorder.

**Some scenes were recorded using another device and cannot be copied.**

- Scenes that were not recorded with this camcorder cannot be copied to memory card **B**.

**Task in progress. Do not disconnect the power source.**

- The camcorder is updating the memory. Wait until the operation ends and do not disconnect the compact power adapter or remove the battery pack.

**There are no scenes with the selected rating**

- No scenes have been rated yet. Rate the scenes as you like (□ 109).
- The criteria you used to select scenes by rating resulted in no applicable scenes. Change the criteria used to select scenes by rating.

**This memory card contains scenes. Delete all scenes to use relay recording.**

- Save your movies (□ 127) if necessary, and delete all the movies from the memory card (□ 92).

**This photo cannot be displayed**

- You may not be able to display photos taken with other devices or image files created or edited on a computer.

**This scene was recorded using another device and cannot be copied.**

- Scenes that were not recorded with this camcorder cannot be copied to memory card **B**.

**To record video on this memory card, it is recommended to use only the XP+/SP/LP recording modes**

- Movies may not be recorded correctly on this memory card if the recording mode is set to MXP or FXP mode (□ 45).

**To use the wireless function, insert the Eye-Fi card into slot B.**

- You may have inserted the Eye-Fi card into memory card slot **A**. Insert it into memory card slot **B**.

**To use this function change the camcorder's mode from **AUTO** to M/CINEMA**

- **CUSTOM**, the CUSTOM dial (□ 84) and some of the functions that can be assigned to the assignable buttons (□ 85) cannot be used in **AUTO** mode. Set the mode switch to **M** (**M** mode) or **CINEMA** (**CINEMA** mode) to use them.

**Too many photos. Disconnect the USB cable.**

- Disconnect the USB cable. Try using a memory card reader or decrease the number of photos on the memory card to fewer than 2,500 photos (Windows), or 1,000 photos (Mac OS).
- If a dialog box appeared on the computer screen, close it. Disconnect the USB cable, and restore the connection after a short while.

**Total play time is too long**

- When converting scenes from a story, the maximum total playback time of the scenes to be converted is 12 hours (when converting individual scenes) or 2 hours and 30 minutes (when converting stories). Reduce the number of scenes to be converted to SD.

**Unable to recognize the data**

- You transferred data to the camcorder recorded using a video configuration that is not supported (PAL or SECAM). Play back the recordings with the device originally used to record them.

**Unable to recover data**

- Could not recover a corrupted file. Save your recordings (□ 127) and initialize the memory using the [Complete Initialization] option (□ 36).

**Unsupported gallery data detected. Cannot record or edit. Delete gallery data?**

- The gallery data of the movies in the selected memory card is not supported. The movies can be played back but you cannot edit them or record additional scenes to this gallery. Select [Yes] to delete the unsupported gallery data. Note that after doing so, you will not be able to play back the movies with the device originally used to record the unsupported gallery data.

## Handling Precautions

### Camcorder

Be sure to observe the following precautions to ensure maximum performance.

- **Save your recordings periodically.** Make sure to transfer your recordings to an external device such as a computer or digital video recorder (□ 124) and save them on a regular basis. This will protect your important recordings in case of damage and create more free space on the memory. Canon shall not be liable for any data loss.
- Do not carry the camcorder by the LCD panel. Be careful when closing the LCD panel. When using a wrist strap, do not allow the camcorder to swing and hit an object.
- **Handle the touch screen with care.** Do not apply excessive force and, with the exception of the supplied stylus pen, do not use ballpoint pens or other hard-tipped tools to operate the touch screen. This may damage the touch screen's surface or the pressure-sensitive layer beneath it.
- Do not attach protective film on the touch screen. The touch screen's operation is based on detecting applied pressure, so you may not be able to correctly operate the touch screen with an additional protective layer.
- Do not leave the camcorder in places subject to high temperatures (like the inside of a car parked under direct sunlight), or high humidity.
- Do not use the camcorder near strong electromagnetic fields such as above TVs, near plasma TVs or mobile phones.
- Do not point the lens or viewfinder at strong light sources. Do not leave the camcorder pointed at a bright subject.
- Do not use or store the camcorder in dusty or sandy places. The camcorder is not waterproof – avoid also water, mud or salt. If any of the above should get into the camcorder it may damage the camcorder and/or the lens.
- Be careful of heat generated by lighting equipment.
- Do not disassemble the camcorder. If the camcorder does not function properly, consult qualified service personnel.
- Handle the camcorder with care. Do not subject the camcorder to shocks or vibration as this may cause damage.
- When mounting the camcorder on a tripod, make sure that the tripod's fastening screw is shorter than 6.5 mm (0.26 in.). Using other tripods may damage the camcorder.
- **When recording movies, try to get a calm, stable picture.**  
Excessive camcorder movement while shooting and extensive use of fast zooms and panning can result in jittery scenes. In extreme cases, the playback of such scenes may result in visually induced motion sickness. If you experience such a reaction, stop the playback immediately and take a rest break as necessary.
- Do not insert the supplied stylus pen into the mouth. If swallowed, seek medical assistance immediately.
- Handle the supplied stylus pen with extreme care and keep it out of the reach of children. If mishandled, the stylus pen can present a risk of severe eye injury and even blindness.

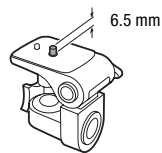

## Long-term storage

If you do not intend to use the camcorder for a long time, store it in a place free of dust, in low humidity, and at temperatures not higher than 30 °C (86 °F).

## Battery Pack

### **DANGER!**

#### **Treat the battery pack with care.**

- Keep it away from fire (or it might explode).
  - Do not expose the battery pack to temperature higher than 60 °C (140 °F). Do not leave it near a heater or inside a car in hot weather.
  - Do not try to disassemble or modify it.
  - Do not drop it or subject it to shocks.
  - Do not get it wet.
- Dirty terminals may cause a poor contact between the battery pack and the camcorder. Wipe the terminals with a soft cloth.



## Long-term storage

- Store battery packs in a dry place at temperatures no higher than 30 °C (86 °F).
- To extend the battery life of the battery pack, discharge it completely before storing it.
- Charge and discharge all your battery packs fully at least once a year.

## Remaining battery time

When you are using a battery pack that is compatible with Intelligent System, if the remaining battery time displayed is not correct, charge the battery pack fully. Still, the correct time may not be displayed after a large number of repeated uses, if a fully charged battery pack is left unused, or if a battery pack is used for long periods of time in high temperatures. Use the time shown on the screen as an approximation.

## Regarding the use of non-Canon battery packs

- For your safety, battery packs that are not genuine Canon battery packs will not be charged even if you attach them to this camcorder or to the optional CG-800 Battery Charger.
- We recommend using genuine Canon battery packs bearing the Intelligent System mark.  Intelligent Li-ion Battery
- If you attach to the camcorder battery packs that are not genuine Canon battery packs,  will appear and the remaining battery time will not be displayed.

## Memory Card

- We recommend backing up the recordings on the memory card onto your computer. Data may be corrupted or lost due to memory card defects or exposure to static electricity. Canon shall not be liable for lost or corrupted data.
- Do not touch or expose the terminals to dust or dirt.
- Do not use memory cards in places subject to strong magnetic fields.

- Do not leave memory cards in places subject to high humidity and high temperature.
- Do not disassemble, bend, drop, or subject memory cards to shocks and do not expose them to water.
- Check the direction before inserting the memory card. Forcing a memory card into a slot if it is not correctly oriented may damage the memory card or the camcorder.
- Do not attach any labels or stickers on the memory card.
- Secure Digital (SD) memory cards have a physical switch to prevent writing on the card so as to avoid the accidental erasure of the card's content. To write-protect the memory card set the switch to the LOCK position.

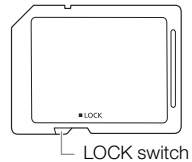

## Built-in Rechargeable Lithium Battery

The camcorder has a built-in rechargeable lithium battery to keep the date/time and other settings. The built-in lithium battery is recharged while you use the camcorder; however, it will discharge completely if you do not use the camcorder for about 3 months.

**To recharge the built-in lithium battery:** Connect the compact power adapter to the camcorder and leave it connected for 24 hours with the camcorder off.

## Lithium Button Battery

### WARNING!

- The battery used in this device may present a fire or chemical burn hazard if mishandled.
- Do not disassemble, modify, immerse in water, heat above 100 °C (212 °F) or incinerate the battery.
- Replace with a CR2025 battery made by Panasonic, Hitachi Maxell, Sony, FDK, or with Duracell2025. Use of other batteries may present a risk of fire or explosion.
- Do not insert the battery into the mouth. If swallowed, seek medical assistance immediately. The battery case may break and the battery fluids may cause internal injuries.
- Keep the battery out of the reach of children.
- Do not recharge, short-circuit or insert the battery in the wrong direction.
- Dispose of the used battery according to applicable recycling regulations.

- Do not pick up the battery using tweezers or other metal tools, as this will cause a short circuit.
- Wipe the battery with a clean dry cloth to ensure proper contact.
- **For California, USA only:** The lithium battery included contains Perchlorate Material – special handling may apply.  
See [www.dtsc.ca.gov/hazardouswaste/perchlorate](http://www.dtsc.ca.gov/hazardouswaste/perchlorate) for details.

## Disposal

When you delete movies or initialize the memory, only the file allocation table is altered and stored data is not physically erased. When you dispose of the camcorder or memory card or give either to another person, initialize it using the [Complete Initialization] option (□ 36). Fill it up with unimportant recordings, and then initialize it again using the same option. This makes recovering the original recordings very difficult.

## Maintenance/Others

### Cleaning

#### Camcorder Body

168

- Use a soft, dry cloth to clean the camcorder body. Never use chemically treated cloths or volatile solvents such as paint thinner.

#### Lens, Viewfinder and Instant AF Sensor

- If the lens surface or Instant AF sensor is dirty, autofocus may not work properly.
- Remove any dust or dirt particles using a non-aerosol type blower brush.
- Use a clean, soft lens-cleaning cloth to gently wipe the lens or viewfinder. Never use tissue paper.

#### LCD Touch Screen

- Clean the LCD touch screen using a clean, soft lens-cleaning cloth.
- Condensation may form on the surface of the screen when the temperature changes suddenly. Wipe it with a soft dry cloth.

### Condensation

Moving the camcorder rapidly between hot and cold temperatures may cause condensation (water droplets) to form on its internal surfaces. Stop using the camcorder if condensation is detected. Continued use may damage the camcorder.

#### Condensation may form in the following cases:

- When the camcorder is moved quickly from cold to warm places
- When the camcorder is left in a humid room
- When a cold room is heated rapidly

#### To avoid condensation

- Do not expose the camcorder to sudden or extreme changes in temperature.
- Remove the memory card and battery pack. Then, place the camcorder in an airtight plastic bag and let it adjust gradually to temperature changes before removing it from the bag.

#### When condensation is detected

The precise time required for water droplets to evaporate will vary depending on the location and weather conditions. As a general rule, wait for 2 hours before resuming use of the camcorder.



---

## Using the Camcorder Abroad

### Power Sources

You can use the compact power adapter to operate the camcorder and to charge battery packs in any country with power supply between 100 and 240 V AC, 50/60 Hz. Consult a Canon Service Center for information on plug adapters for overseas use.

### Playback on a TV Screen

You can only play back your recordings on TVs compatible with the NTSC system. NTSC is used in the following regions/countries:

**Americas:** All of North America and Central America; most Caribbean islands (except in French territories like Guadeloupe and Martinique); most of South America (except in Argentina, Brazil and Uruguay). **Asia:** Only in Japan, the Philippines, South Korea, Taiwan and Myanmar. **Oceania:** US territories (Guam, American Samoa, etc.) and some Pacific islands like Micronesia, Samoa and Tonga.

## Optional Accessories (Availability differs from area to area)

The following optional accessories are compatible with this camcorder. Select accessories are described in more detail in the following pages.



BP-808, BP-809(B),  
BP-809(S), BP-819,  
BP-827 Battery Pack



CG-800  
Battery Charger

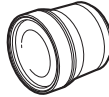

TL-H58  
Tele-converter

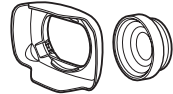

WD-H58W  
Wide-converter

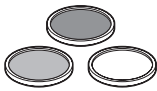

Protect Filter 58 mm,  
ND4L Filter 58 mm,  
ND8L Filter 58 mm



VL-5 Video Light



VFL-2 Video Flash  
Light



WM-V1 Wireless  
Microphone



SM-V1  
Surround Microphone



DM-100 Directional  
Stereo Microphone



SS-600/SS-650  
Shoulder Strap

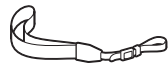

WS-20  
Wrist Strap

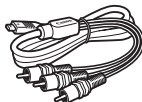

CTC-100  
Component Cable



SC-2000  
Soft Carrying Case

### NOTES

- Accessories that are compatible with the Advanced Accessory Shoe cannot be attached to this camcorder. Look for the **Mini ADVANCED SHOE** logo to ensure compatibility with the mini advanced shoe.

Call or visit your local retailer/dealer for genuine Canon video accessories. You can also obtain genuine accessories for your Canon camcorder by calling: 1-800-828-4040, Canon U.S.A. Information Center.

**Use of genuine Canon accessories is recommended.**

This product is designed to achieve excellent performance when used with genuine Canon accessories. Canon shall not be liable for any damage to this product and/or accidents such as fire, etc., caused by the malfunction of non-genuine Canon accessories (e.g., a leakage and/or explosion of a battery pack). Please note that this warranty does not apply to repairs arising out of the malfunction of non-genuine Canon accessories, although you may request such repairs on a chargeable basis.

### Battery Packs

When you need extra battery packs, select one of the following models: BP-808\*, BP-809(B)\*, BP-809(S)\*, BP-819, or BP-827.

\* Please note that the shape/color of this battery does not match the external design of the camcorder.

When you use battery packs bearing the Intelligent System mark, the camcorder will communicate with the battery and display the remaining usage time (accurate to 1 minute). You can only use and charge these battery packs with camcorders and chargers compatible with Intelligent System.



### CG-800 Battery Charger

Use the battery charger to charge the battery packs. It plugs directly into a power outlet without a cable.

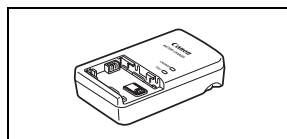

### Charging, Recording and Playback Times

The charging times given in the following table are approximate and vary according to charging conditions and initial charge of the battery pack.

Battery pack→	BP-808	BP-819	BP-827
Charging conditions↓	BP-809		
Using the camcorder	150 min.	260 min.	385 min.
Using the CG-800 Battery Charger	105 min.	190 min.	260 min.

Recording and playback times given in the following tables are approximate and vary according to recording mode and charging, recording or playback conditions. The effective usage time of the battery pack may decrease when recording in cold surroundings, when using the brighter screen settings, etc.

Using the built-in memory

Battery pack	Recording mode	Recording (maximum)		Recording (typical)*		Playback
		LCD	Viewfinder	LCD	Viewfinder	LCD
BP-808 BP-809	MXP	105 min.	110 min.	60 min.	65 min.	145 min.
	FXP	105 min.	115 min.	65 min.	65 min.	150 min.
	XP+	110 min.	120 min.	65 min.	70 min.	150 min.
	SP	110 min.	120 min.	65 min.	70 min.	150 min.
	LP	110 min.	120 min.	65 min.	70 min.	150 min.
BP-819	MXP	215 min.	240 min.	135 min.	145 min.	315 min.
	FXP	220 min.	235 min.	140 min.	150 min.	305 min.
	XP+	225 min.	240 min.	145 min.	155 min.	310 min.
	SP	230 min.	245 min.	145 min.	155 min.	310 min.
	LP	230 min.	245 min.	145 min.	155 min.	310 min.
BP-827	MXP	330 min.	350 min.	200 min.	215 min.	455 min.
	FXP	335 min.	355 min.	205 min.	220 min.	460 min.
	XP+	345 min.	370 min.	210 min.	225 min.	470 min.
	SP	345 min.	370 min.	210 min.	225 min.	475 min.
	LP	345 min.	370 min.	210 min.	225 min.	475 min.

Using a memory card

Battery pack	Recording mode	Recording (maximum)		Recording (typical)*		Playback
		LCD	Viewfinder	LCD	Viewfinder	LCD
BP-808 BP-809	MXP	105 min.	115 min.	65 min.	65 min.	145 min.
	FXP	105 min.	115 min.	65 min.	65 min.	150 min.
	XP+	110 min.	120 min.	65 min.	70 min.	150 min.
	SP	110 min.	120 min.	65 min.	70 min.	155 min.
	LP	110 min.	120 min.	65 min.	70 min.	155 min.
BP-819	MXP	220 min.	235 min.	140 min.	145 min.	300 min.
	FXP	220 min.	235 min.	140 min.	150 min.	305 min.
	XP+	230 min.	245 min.	145 min.	155 min.	310 min.
	SP	230 min.	245 min.	145 min.	155 min.	315 min.
	LP	230 min.	245 min.	145 min.	155 min.	315 min.
BP-827	MXP	330 min.	355 min.	205 min.	220 min.	455 min.
	FXP	335 min.	360 min.	205 min.	220 min.	455 min.
	XP+	345 min.	370 min.	210 min.	225 min.	475 min.
	SP	350 min.	375 min.	215 min.	230 min.	475 min.
	LP	350 min.	375 min.	215 min.	230 min.	480 min.

\* Approximate times for recording with repeated operations such as start/stop, zooming, and power on/off.

**TL-H58 Tele-converter**

This Tele-converter lens increases the focal length of the camcorder lens by a factor of 1.5.

- The Tele-converter cannot be used together with the supplied lens hood with lens barrier.
- The image stabilizer is not as effective when the Tele-converter is attached.
- The minimum focusing distance at full telephoto with the Tele-converter is 1.3 m (4.3 ft.).

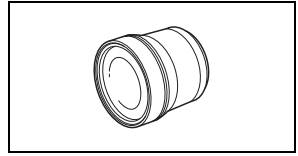
**WD-H58W Wide-converter**

This Wide-converter lens decreases the focal length by a factor of 0.8, giving you a wide perspective for indoor shots or panoramic views.

- The Wide-converter cannot be used together with the supplied lens hood with lens barrier.

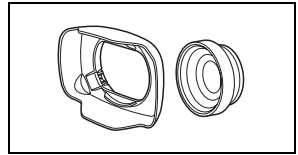
**Protect Filter 58 mm, ND4L Filter 58 mm, ND8L Filter 58 mm**

Neutral density and MC protector filters help you to control difficult lighting conditions.

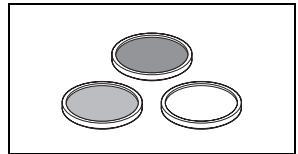
**VL-5 Video Light**

This video light enables you to record brightly in color even in dark places. It attaches to the camcorder's mini advanced shoe for cable-free operation.

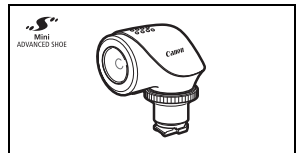
**VFL-2 Video Flash Light**

This video flash light allows you to record photos and movies even at night or in dark places. It attaches to the camcorder's mini advanced shoe for cable-free operation.

- The VFL-2 cannot be used as a flash with this camcorder.

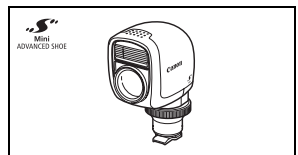
**WM-V1 Wireless Microphone**

Reliably record rich sound even when shooting subjects at a distance. The transmitter is conveniently equipped with a clothing clip and the receiver can be attached to the camcorder's grip belt.

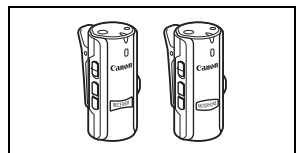
**SM-V1 Surround Microphone**

Use 5.1ch surround sound to add a sense of presence to your movies. You can link the surround sound to the zoom position or use the microphone as a highly directional shotgun microphone (monaural).

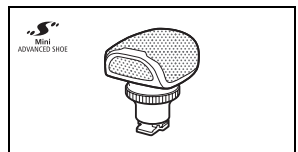

### DM-100 Directional Stereo Microphone

This highly sensitive, super-directional microphone attaches to the camcorder's mini advanced shoe. It can be used as directional microphone (monaural) or stereo microphone.

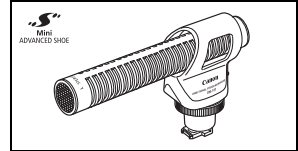

174

### SC-2000 Soft Carrying Case

A handy camcorder bag with padded compartments and plenty of space for accessories.

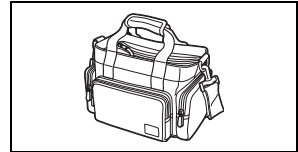

This mark identifies genuine Canon video accessories. When you use Canon video equipment, we recommend Canon-brand accessories or products bearing the same mark.



# Specifications

## VIXIA HF G20

◆ – Values given are approximate figures.

### System

#### • Recording System

Movies: AVCHD Video compression: MPEG-4 AVC/H.264;  
 Audio compression: Dolby Digital 2ch; Dolby Digital 5.1ch\*  
 \* Only when using the optional SM-V1 Surround Microphone.

Photos: DCF (Design rule for Camera File system), compatible with Exif\* Ver. 2.2

Image compression: JPEG

\* This camcorder supports Exif 2.2 (also called "Exif Print"). Exif Print is a standard for enhancing the communication between camcorders and printers. By connecting to an Exif Print-compliant printer, the camcorder's image data at the time of shooting is used and optimized, yielding extremely high quality prints.

#### • Video Signal Configuration

1080/60i\* or 1080/24p (only recordings made with the [24P] frame rate)

\* Recordings made with the [PF24], [PF30] frame rate are converted and recorded on the memory as 60i.

#### • Recording Media

- Built-in memory: 32 GB  
 - SD, SDHC (SD High Capacity) or SDXC (SD eXtended Capacity) memory card (not included)

#### • Maximum Recording Time◆

32 GB built-in memory:

**MXP** mode: 2 hr. 55 min.    **FXP** mode: 4 hr. 10 min.    **XP+** mode: 5 hr. 45 min.

**SP** mode: 9 hr. 35 min.    **LP** mode: 12 hr. 15 min.

Commercially available 8 GB memory card:

**MXP** mode: 40 min.    **FXP** mode: 1 hr.    **XP+** mode: 1 hr. 25 min.

**SP** mode: 2 hr. 20 min.    **LP** mode: 3 hr.

#### • Image Sensor

1/3-inch CMOS, 2,370,000 pixels◆

Effective pixels: 2,070,000 pixels◆

• **LCD Touch Screen:** 3.5 in., wide, TFT color, 922,000 dots◆, 100% coverage, touch operation

• **Viewfinder:** 0.24 in., wide, color, equivalent to 260,000 dots◆, 100% coverage

• **Microphone:** Stereo electret condenser microphone

#### • Lens

f=4.25-42.5 mm, F/1.8-2.8, 10x optical zoom, iris aperture

35 mm equivalent: 30.4 – 304 mm◆

• **Lens Configuration:** 12 elements in 10 groups (2 double-sided aspheric elements)

#### • AF System

Autofocus (TTL + external distance sensor when set to [Instant AF] or [Medium AF]) or Manual focus

- **Filter Diameter:** 58 mm
- **Minimum Focusing Distance**  
60 cm (2 ft.); 2 cm (0.39 in.) at full wide angle
- **White Balance**  
Auto white balance, Custom white balance (2 settings), User-defined color temperature or Preset white balance settings: Daylight, Shade, Cloudy, Fluorescent, Fluorescent H, Tungsten
- **Minimum Illumination**  
0.1 lx ([Low Light] recording program, Shutter speed at 1/2)  
1.2lx ([Programmed AE] recording program, Auto slow shutter [On], Shutter speed at 1/30)
- **Recommended Illumination:** More than 100 lx
- **Image Stabilization:** Optical-Shift Image Stabilizer
- **Size of Video Recordings**  
**MXP, FXP** mode: 1920 x 1080 pixels; **XP+, SP, LP** mode: 1440 x 1080 pixels
- **Size of Photos:** 1920 x 1080 pixels

## Terminals

- **AV OUT/Ⓜ Terminal**  
Ø 3.5 mm minijack; output only (dual purpose terminal also for headphones stereo output)  
Video: 1 Vp-p / 75 Ω unbalanced  
Audio: -10 dBV (47 kΩ load) / 3 kΩ or less
- **USB Terminal:** mini-B, USB 2.0 (Hi-Speed USB)
- **COMPONENT OUT Terminal (proprietary mini-D terminal)**  
Luminance (Y): 1 Vp-p / 75 Ω; Chrominance (P<sub>B</sub>/P<sub>R</sub>): ±350 mV / 75 Ω  
1080i (D3) compatible; output only
- **HDMI OUT Terminal**  
HDMI mini connector; output only; compatible with HDMI-CEC and x.v.Color
- **MIC Terminal**  
Ø 3.5 mm stereo minijack (unbalanced)  
Sensitivity:  
For microphone input: -65 dBV (auto volume, full scale -12 dB) / 5 kΩ  
For line input: -30 dBV (auto volume, full scale -12 dB) / 5 kΩ  
Microphone attenuator: 20 dB

## Power/Others

- **Power supply (rated)**  
7.4 V DC (battery pack), 8.4 V DC (compact power adapter)
- **Power consumption**◆:  
3.2 W (FXP mode, AF on, LCD normal brightness)  
3.0 W (FXP mode, AF on, viewfinder)  
Maximum rated power consumption: 10.9 W



- Operating temperature♦: 0 – 40 °C (32 – 104 °F)
- Dimensions♦ [W x H x D] (excluding the grip belt)  
Camcorder only: 77 x 78 x 161 mm (3.0 x 3.1 x 6.3 in.)  
Camcorder with the lens hood attached: 95 x 82 x 210 mm (3.7 x 3.2 x 8.3 in.)
- Weight♦ (camcorder with grip belt and lens hood attached): 575 g (1.3 lb.)

### CA-570 Compact Power Adapter

- Power supply: 100 – 240 V AC, 50/60 Hz
- Rated output / consumption: 8.4 V DC, 1.5 A / 29 VA (100 V) – 39 VA (240 V)
- Operating temperature♦: 0 – 40 °C (32 – 104 °F)
- Dimensions♦: 52 x 29 x 90 mm (2.1 x 1.1 x 3.5 in.)
- Weight♦: 135 g (4.8 oz.)

### BP-808 Battery Pack

- Battery type  
Rechargeable lithium ion battery, compatible with Intelligent System
- Rated voltage: 7.4 V DC
- Operating temperature♦: 0 – 40 °C (32 – 104 °F)
- Battery capacity: 890 mAh (typical); 6.3 Wh / 850 mAh (minimum)
- Dimensions♦: 30.7 x 23.3 x 40.2 mm (1.2 x 0.9 x 1.6 in.)
- Weight♦: 46 g (1.6 oz.)

### About the music files

The specifications of the music files compatible with the camcorder are as follows.

**Audio encoding:** Linear PCM

**Audio sampling:** 48 kHz, 16 bits, 2 channels

**Minimum length:** 1 second

**File type:** WAV

The music data is saved in the memory under the following folders. Sample music tracks can be found in the "MUSIC" folder of the supplied VIXIA CD-ROM.

In the built-in memory:

\CANON\MY\_MUSIC\MUSIC\_01.WAV to MUSIC\_99.WAV

On the memory card:

\CANON\PRIVATE\MY\_MUSIC\MUSIC\_01.WAV to MUSIC\_99.WAV

### About the image files for the Image Mix function

The specifications of image files that can be used with the image mix function are as follows.

**Image size:** 1920x1080 pixels

**File type:** Baseline JPEG

**Color sampling:** 4:2:2 or 4:2:0

Image files are saved in the memory under the following folders. Sample image mix frames can be found in the "MY\_PICT" folder of the supplied VIXIA CD-ROM.

In the built-in memory:

\CANON\MY\_PICT\MIX\_01.JPG to MIX\_99.JPG

On the memory card:

\CANON\PRIVATE\MY\_PICT\MIX\_01.JPG to MIX\_99.JPG

# Index

3D Flip View ..... 90

## A

Abroad, using the camcorder ..... 169  
AGC (automatic gain control) limit ..... 56  
Aperture (f number) ..... 57, 59  
Aspect ratio of a connected  
  TV (TV type) ..... 143  
Assignable buttons ..... 85  
Audio equalizer ..... 71  
Audio mix ..... 72  
Audio recording level ..... 69  
Audio reference signal ..... 78  
Audio scene select ..... 68  
Audio settings ..... 68  
AUTO mode ..... 39  
Auto slow shutter ..... 142  
Auto wind screen ..... 71  
Av (recording program) ..... 57  
AV OUT/ $\square$  terminal ..... 73, 116, 118

## B

Background music ..... 110  
Backlight correction ..... 61  
Battery pack  
  Battery information ..... 148  
  Charging ..... 20  
  Remaining charge indicator ..... 153  
Beach (recording program) ..... 64  
Built-in backup battery ..... 167

## C

Capturing photos/video snapshot scenes from  
  a movie ..... 97  
Chroma key ..... 105  
CINEMA mode ..... 101  
Cinema-look filters ..... 101  
Color bars ..... 78  
COMPONENT OUT terminal ..... 116, 117  
Condensation ..... 168  
Connections to external devices ..... 117  
Copying recordings to a memory card ..... 124  
CUSTOM button ..... 84  
CUSTOM dial ..... 84

## D

Data code ..... 82, 143  
Date and time ..... 31  
Decoration ..... 103

## Deleting

  Movies ..... 92  
  Photos ..... 123  
Digital tele-converter ..... 54  
Dividing scenes ..... 95  
Double slot recording ..... 36

## E

Edge monitor ..... 79  
Edit panel ..... 29, 139  
Editing stories ..... 113  
Error messages ..... 159  
Exposure compensation ..... 60  
External audio input ..... 72, 111  
External microphone ..... 75  
Eye-Fi card ..... 136

## F

Face detection ..... 49  
Faders ..... 83  
File numbering ..... 145  
Fireworks (recording program) ..... 65  
Focus preset ..... 47  
Focus ring ..... 47  
Frame rate ..... 46  
FUNC. panel ..... 29, 138

## G

Gallery ..... 91, 107

## H

HD to SD conversion ..... 133, 135  
HDMI OUT terminal ..... 116, 117  
HDMI-CEC ..... 149  
Headphones ..... 73  
Highlight AE ..... 61

## I

Image effects ..... 66  
Image mix ..... 105  
Image stabilizer ..... 55  
Index screen selection ..... 91  
Initializing the memory ..... 36  
Intelligent IS ..... 40

## L

Language ..... 31  
LCD screen dimmer ..... 148  
LCD touch screen ..... 23, 27

- Lens barrier switch .....38
- Lens hood .....22
- Low light (recording program) .....64

**M**

- M (Manual) mode .....42
- Maintenance .....168
- Manual exposure .....59
- Manual focus .....47
- Markers .....142
- Memory card .....33, 166
- Menu settings, saving and loading .....86
- MIC terminal .....76, 111
- Microphone attenuator .....142
- Microphone directionality .....70
- Mini advanced shoe .....74
- Mode switch .....28

**N**

- ND filter .....142
- Night scene (recording program) .....64
- Notification sounds .....148

**O**

- Onscreen display selection .....82
- Onscreen icons .....150

**P**

- P (recording program) .....57
- Peaking .....48
- Playback
  - Movies .....87, 107
  - Photos .....120
- Portrait (recording program) .....64
- Power saving .....42, 43
- Powered IS .....55
- Pre-recording .....81

**Q**

- Quick Start .....44

**R**

- Rating scenes .....109
- Recording
  - Movies .....39, 42, 101
  - Photos .....39, 42
- Recording mode .....45
- Recording programs .....57, 59, 64
- Recording time .....45

- Relay recording .....35
- Remote sensor .....25
- Resetting all camcorder settings .....157
- Reviewing recordings .....43

**S**

- Saving recordings
  - Transferring to a computer .....127
  - Using external video recorders .....131
- Scan reverse recording .....144
- Selecting the memory
  - for playback .....91
  - for recording .....34
- Self timer .....67
- Serial number .....18
- Setup menus .....30, 141
- Shutter speed .....57, 59
- Slideshow .....122
- Smart AUTO .....40
- Snow (recording program) .....64
- Sports (recording program) .....64
- Spotlight (recording program) .....65
- Story Creator .....99
- Sunset (recording program) .....64

**T**

- Telephoto .....52
- Time zone/DST .....32
- Timeline .....96
- Touch & Track .....51
- Touch AE .....60
- Touch AF .....47
- Touch screen operations .....27
- Tripod .....26, 165
- Troubleshooting .....154
- Turning off notification sounds .....148
- Tv (recording program) .....57

**U**

- Uploading recordings to the Web .....133
- USB terminal .....116, 118, 131

**V**

- Video snapshot .....80
- Viewfinder .....22
- Volume .....88

## **W**

Waveform monitor .....	79
White balance .....	62
Wide angle .....	52
Wireless controller .....	19, 25

## **Z**

Zebra pattern .....	59
Zoom .....	52
Digital zoom .....	142
Soft zoom control .....	54
Zoom speed .....	52



## CANON CONSUMER DIGITAL VIDEO EQUIPMENT LIMITED WARRANTY FOR THE UNITED STATES

The limited warranty set forth below is given by Canon U.S.A., Inc. ("Canon USA") with respect to Canon Consumer Digital Video Equipment (the "Equipment") purchased in the United States. This limited warranty is only effective upon presentation of your Bill of Sale or other proof of purchase.

The Equipment is warranted under normal, non-commercial, personal use, against defective materials or workmanship as follows:

Parts: Defective parts will be exchanged for new parts or comparable rebuilt parts for a period of ONE YEAR from the date of original purchase, except for a defective Video Head, which will be exchanged for a period of three months from the date of purchase.

Labor: For a period of ONE YEAR from the date of original purchase, labor will be provided free of charge by our factory service centers or designated service facilities located in the United States.

When returning Equipment under this warranty, you must pre-pay the shipping charges, and you must enclose the Bill of Sale or other proof of purchase with a complete explanation of the problem. During the ONE-YEAR warranty period, repairs will be made and the Equipment will be return-shipped to you free of charge. For repairs after the warranty period is over, you will be given an estimate of the cost of repair and an opportunity to approve or disapprove of the repair expense before it is incurred. If you approve, repairs will be made and the Equipment will be return-shipped to you. (shipping charges apply). If you disapprove, we will return-ship the equipment at no charge to you.

**Non-Canon brand peripheral equipment and software which may be distributed with, or factory loaded on, the Equipment, are sold "AS IS" without warranty of any kind by Canon USA, including any implied warranty regarding merchantability or fitness for a particular purpose. The sole warranty with respect to such non-Canon brand items is given by the manufacturer or producer thereof. If the Equipment contains a hard disk drive, Canon USA recommends that data stored on that drive be duplicated or backed up to prevent its loss in the event of failure or other malfunction of such drive.**

Canon USA shall have no responsibility under this limited warranty for use of the Equipment in conjunction with incompatible peripheral equipment and incompatible software.

In order to obtain warranty service, contact the authorized Canon retail dealer from whom you purchased the Equipment or call the CANON INFORMATION CENTER AT 1-800-OK-CANON). You will be directed to the nearest service facility for your Equipment.

This Limited Warranty covers all defects encountered in normal use of the Equipment and does not apply in the following cases:

- A) Loss or damage to the Equipment due to abuse, mishandling, accident, improper maintenance, or failure to follow operating instructions;
- B) If the Equipment is defective as a result of leaking batteries, sand, dirt or water damage;
- C) If defects or damages are caused by the use of unauthorized parts or by service other than by Canon USA's factory service centers or authorized service facilities;
- D) If the Equipment is used for commercial or industrial use.

This Limited Warranty does not cover cabinet (exterior finish), video cassette tape, head cleanings, nor does it apply to Equipment purchased outside the United States. This warranty does not cover units sold to rental firms, military operations, hotels, schools, hospitals or for other commercial, industrial, or institutional applications. These uses are covered only by such specific warranty as Canon may issue with such sales.

This Limited Warranty does not apply to accessories or consumables for the Equipment, which are sold "AS IS", without warranty of any kind by Canon USA. Please retain this warranty card and your Bill of Sale as a permanent record of your purchase. This card is most important in order to be sure you are contacted right away should there be a safety inspection, modification or product recall under applicable laws or regulations.

**NO IMPLIED WARRANTY, INCLUDING MERCHANTABILITY AND FITNESS FOR A PARTICULAR PURPOSE APPLIES TO THIS EQUIPMENT AFTER THE APPLICABLE PERIOD OF EXPRESS WARRANTY OR GUARANTEE, EXCEPT AS MENTIONED ABOVE, GIVEN BY ANY PERSON, FIRM OR CORPORATION WITH RESPECT TO THIS EQUIPMENT SHALL BIND THE UNDERSIGNED (SOME STATES DO NOT ALLOW LIMITATIONS ON HOW LONG AN IMPLIED WARRANTY LASTS, SO THE ABOVE LIMITATION OR EXCLUSION MAY NOT APPLY TO YOU). CANON USA SHALL NOT BE LIABLE FOR LOSS OF REVENUES OR PROFITS, EXPENSE FOR SUBSTITUTE EQUIPMENT OR SERVICE, STORAGE CHARGES, LOSS OR CORRUPTION OF DATA, INCLUDING WITHOUT LIMITATION, LOSS OR CORRUPTION OF DATA STORED ON THE EQUIPMENT'S HARD DRIVE, OR ANY OTHER SPECIAL, INCIDENTAL OR CONSEQUENTIAL DAMAGES CAUSED BY THE USE, MISUSE OR INABILITY TO USE THE EQUIPMENT, REGARDLESS OF THE LEGAL THEORY ON WHICH THE CLAIM IS BASED, AND EVEN IF CANON USA HAS BEEN ADVISED OF THE POSSIBILITY OF SUCH DAMAGES. NOR SHALL RECOVERY OF ANY KIND AGAINST CANON USA BE GREATER THAN THE PURCHASE PRICE OF THE EQUIPMENT SOLD BY CANON USA AND CAUSING THE ALLEGED DAMAGE. WITHOUT LIMITING THE FOREGOING, YOU ASSUME ALL RISK AND LIABILITY FOR LOSS, DAMAGE OR INJURY TO YOU AND YOUR PROPERTY AND TO OTHERS AND THEIR PROPERTY ARISING OUT OF USE, MISUSE OR INABILITY TO USE THE EQUIPMENT NOT CAUSED DIRECTLY BY THE NEGLIGENCE OF CANON USA. (SOME STATES DO NOT ALLOW THE EXCLUSION OR LIMITATION OF INCIDENTAL OR CONSEQUENTIAL DAMAGES, SO THE ABOVE LIMITATION MAY NOT APPLY TO YOU). THIS WARRANTY SHALL NOT EXTEND TO ANYONE OTHER THAN THE ORIGINAL PURCHASER OF THIS EQUIPMENT OR THE PERSON FOR WHOM IT WAS PURCHASED AS A GIFT.**

This warranty gives you specific legal rights, and you may also have other rights which vary from state to state.  
CANON U.S.A., INC.

## CANON CONSUMER DIGITAL VIDEO EQUIPMENT LIMITED WARRANTY

The limited warranty set forth below is given by Canon Canada Inc. ("Canon Canada") with respect to Canon Consumer Digital Video Equipment (the "Equipment") purchased in Canada. This limited warranty is only effective upon presentation of a bill of sale or other proof of purchase for this Equipment to a Canon Service Facility when repairs are required.

The Equipment is warranted under normal, non-commercial, personal use, against defective materials or workmanship as follows:

Parts: Defective parts will be exchanged for new parts or, at Canon Canada's option, comparable rebuilt parts for a period of one year from the date of original purchase, except Video Heads which will be exchanged for a period of 3 months from the date of purchase.

Labour: For a period of one year from the date of original purchase, labour will be provided free of charge by our Canon Service Facilities in Canada.

This limited warranty covers all defects except where:

(a) The loss or damage to the product results from:

- i) accident, natural disaster, mishandling, abuse, neglect, unauthorized product modification or failure to follow instructions contained in the instruction manual;
- ii) the use of accessories, attachments, products, supplies, parts or devices with the Equipment that do not conform to Canon specifications or that cause abnormally frequent service problems;
- iii) repairs or services performed by any party other than a Canon Service Facility;
- iv) defective batteries or any exposure to water, sand or dirt;
- v) shipping (claim must be presented to the shipper);

(b) Any serial number on the video equipment is altered or removed.

(c) The Equipment is used for commercial, professional or industrial purposes.

This limited warranty does not cover the cabinet (exterior finish) of the Equipment, media, nor does it apply to Equipment purchased outside Canada.

If the Equipment contains a hard disk drive, Canon Canada recommends that data stored on that drive be duplicated or backed up to prevent its loss in the event of a failure or other malfunction of such drive.

### TO OBTAIN WARRANTY SERVICE

Ship your Equipment in its original carton, box or equivalent, properly packed, fully insured with shipping charges prepaid, together with a copy of your bill of sale or other proof of purchase and a description of the problem to any of the Canon Service Facilities in Canada.

### LIMITATIONS

Except as otherwise required by applicable legislation, this warranty is in lieu of all other warranties, conditions, guarantees or representations, express or implied, statutory or otherwise, relative to the Equipment, including implied warranties or conditions of merchantability or fitness for a particular purpose.

Canon Canada assumes no liability for special, consequential or incidental damages, loss or corruption of data including, without limitation, data stored on the hard disk drive of the Equipment or loss that may arise, whether on account of negligence or otherwise, from the use, misuse or inability to use the Equipment (including loss of profit, revenue, media or enjoyment) or from failure to conform to any express or implied warranties, conditions, guarantees or representations. Any recovery under this limited warranty shall not exceed the purchase price of the equipment. Canon Canada does not assume or authorize any other person to assume for Canon Canada any other liability with respect to this equipment.

This warranty does not extend to any person other than the original purchaser of the Equipment or the person for whom it was purchased as a gift and states your exclusive remedy.

### NOTICE TO CONSUMER

If you plan to take important videos or if the product has not been used for some time, please check all functions with the instruction book before using it.



---

<b>USA</b>	<b>CANON U.S.A., INC. NEW JERSEY OFFICE</b> 100 Jamesburg Road, Jamesburg, NJ 08831 USA <b>CANON U.S.A., INC. CHICAGO OFFICE</b> 100 Park Blvd., Itasca, IL 60143 USA <b>CANON U.S.A., INC. LOS ANGELES OFFICE</b> 15955 Alton Parkway, Irvine, CA 92618 USA <b>CANON U.S.A., INC. HONOLULU OFFICE</b> 210 Ward Avenue, Suite 200, Honolulu, HI 96814 USA  ❖ If you have any questions, call the Canon U.S.A. Information Center toll-free at 1-800-828-4040 (USA only).
<b>CANADA</b>	<b>CANON CANADA INC.</b> 6390 Dixie Road, Mississauga, ON L5T 1P7  ❖ If you have any questions, call the Canon Canada Information Center toll free (in Canada only) at 1-800-OK-CANON (1-800-652-2666).  ❖ Si vous avez des questions, veuillez téléphoner 1-800-OK-CANON (1-800-652-2666, sans frais au Canada seulement).
<b>MÉXICO</b>	<b>CANON MEXICANA, S DE RL DE CV</b> Blvd. Manuel Ávila Camacho No. 138, Piso 17 Col. Lomas de Chapultepec, C.P. 11000 México, D.F., México <b>CANON U.S.A., INC. NEW JERSEY OFFICE</b> 100 Jamesburg Road, Jamesburg, NJ 08831 USA
<b>CENTRO Y SURAMÉRICA</b>	<b>CANON LATIN AMERICA, INC.</b> 703 Waterford Way, Suite 400, Miami, FL 33126 USA
<b>ASIA</b>	<b>CANON HONGKONG COMPANY LTD.</b> 19/F, The Metropolis Tower, 10 Metropolis Drive, Hunghom, Kowloon, Hong Kong Tel: +852 3191 2333, Fax: +852 2428 3963

---

- For support concerning the supplied PIXELA's software, please call PIXELA customer support (see the back cover of the Startup Guide for PIXELA's software).
- Pour le support technique concernant le logiciel de PIXELA fourni, veuillez appeler le support technique PIXELA (reportez-vous au dos du Guide de démarrage du logiciel de PIXELA).
- Para soporte relacionado con el software de PIXELA suministrado, llame al centro de ayuda al cliente de PIXELA (puede encontrar los detalles en la Guía de inicio para el software PIXELA).