

Wireless File Transmitter

WFT-E6

To comply with local radio wave regulations, Canon offers five region-specific versions of the transmitter (WFT-E6A, E6B, E6C, E6D, and E6E) in various areas around the world (See Areas of Use and Restrictions.). For convenience, we refer to the product in this manual simply as “the transmitter,” without reference to versions A, B, C, D, or E.

This product also supports the EOS C300. When using the transmitter, refer to “Guide for Canon Camcorders”.

Thank you for purchasing a Canon product.

The Wireless File Transmitter WFT-E6 is an accessory for EOS-1D X cameras. In addition to time syncing with other cameras (over a wireless LAN connection) and Bluetooth connectivity with GPS devices, the transmitter enables the following operations.

Wireless LAN Functions

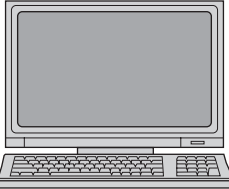

FTP Transfer

Transfer images to an FTP server



EOS Utility

Use EOS Utility to capture, view, and download images remotely



WFT Server

Use a web browser to capture, view, and download images remotely



Media Server

View images on a DLNA-compatible TV or other devices

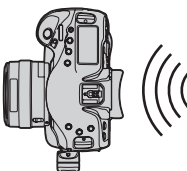

Linked Shooting

Wirelessly trigger shooting by slave cameras linked to a master camera

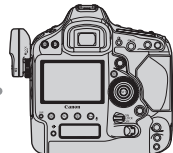

Sync the Camera Time Wirelessly

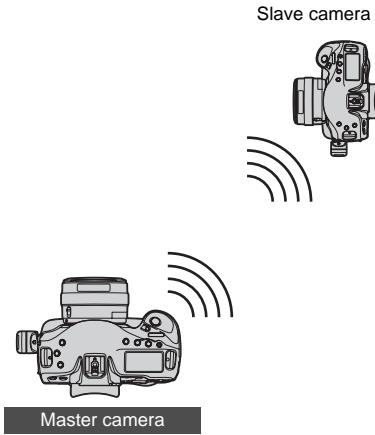

Connect to GPS Devices (commercially available) via Bluetooth

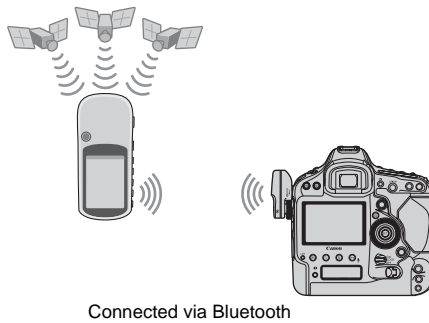

Add the latitude, longitude, altitude, date and time, and other shooting information to images

Conventions Used in this Manual

- These instructions should be followed only after your wireless LAN and FTP server settings are complete. For details on configuring these settings, refer to the documentation provided with the respective equipment.
- Terms in brackets [] indicate button or icon names or other software elements. Brackets also denote camera menu items.
- Page numbers in parentheses indicate where you can find additional information.
- Instructions on camera operations should be followed only after you have read the Camera Instruction Manual and are familiar with operating the camera.
- Sections of this manual labeled with the following symbols contain information of the corresponding nature.



: Warnings to avoid potential problems are labeled with a caution symbol.



: Supplemental information is labeled with a note symbol.

- Windows is a trademark or registered trademark of Microsoft Corporation in the United States and other countries.
- Macintosh is a registered trademark of Apple Corporation in the United States and other countries.
- Wi-Fi is a registered trademark of the Wi-Fi Alliance.
- Wi-Fi Certified, WPA, WPA2, and the Wi-Fi Certified logo are trademarks of the Wi-Fi Alliance.
- WPS as used on camera settings screens and in this manual signifies Wi-Fi Protected Setup.
- UPnP is a trademark of the UPnP Implementers Corporation.
- Bluetooth and the Bluetooth logos are trademarks owned by Bluetooth SIG, Inc.
- All other corporate and brand names in this manual are trademarks or registered trademarks of their respective owners.

Using the transmitter for remote image transfer, capture, or viewing requires adequate knowledge of configuring your wireless LAN and FTP server.

Canon cannot provide support for configuring wireless LANs or FTP servers.

Note that Canon cannot be held liable for any loss or damage to the transmitter from erroneous network or FTP server settings. In addition, Canon cannot be held liable for any other loss or damage caused by use of the transmitter.

Chapter List

	Introduction	2	■
1	Basic Network Settings	13	■
2	Transferring Images to an FTP Server	27	■
3	Remote Capture Using EOS Utility	43	■
4	Remote Capture Using WFT Server	49	■
5	Using the Transmitter as a Media Server	61	■
6	Linked Shooting	65	■
7	Managing Settings Information	79	■
8	Synchronizing the Camera Time Wirelessly	89	■
9	Using Bluetooth GPS Devices	93	■
10	Troubleshooting	97	■
11	Reference	113	■

Contents

Introduction	
Conventions Used in this Manual	4
Chapter List.....	5
Contents.....	6
Safety Warnings.....	8
Nomenclature.....	9
Attaching to the Camera	10
Subsequent Organization of This Manual.....	11
1 Basic Network Settings 13	
Getting Ready	14
Displaying the Connection Wizard.....	15
Selecting the Communication Method and LAN Type	16
Using the Wizard to Establish a Connection.....	19
WPS Connections (PBC Mode).....	21
WPS Connections (PIN Mode)	22
Configuring Network Settings	23
2 Transferring Images to an FTP Server 27	
Configuring FTP Communication Settings.....	28
Automatic Image Transfer After Each Shot	30
Transferring Images Individually.....	33
Batch Transfer	36
Checking Image Transfer History	41
Viewing Transferred Images.....	42
3 Remote Capture Using EOS Utility 43	
Configuring EOS Utility Communication Settings	44
Using EOS Utility	47
4 Remote Capture Using WFT Server 49	
Configuring WFT Server Communication Settings	50
Displaying WFT Server	52
Viewing Images.....	53
Remote Capture [Camera control].....	55
Remote Capture [Simple control].....	58
Remote Capture.....	59
Using WFT Server in Linked Shooting.....	60
5 Using the Transmitter as a Media Server 61	
Configuring Media Server Communication Settings	62
Displaying Captured Images on a Television.....	63

6	Linked Shooting	65
	Preparing Slave Cameras.....	66
	Basic Linked Shooting.....	67
	Arranging the Slave Cameras.....	68
	Using the Transmitter with WFT Server.....	70
7	Managing Settings Information	79
	Checking Settings.....	80
	Changing Settings.....	82
	Saving and Loading Settings.....	85
8	Synchronizing the Camera Time Wirelessly	89
	Synchronizing the Time.....	90
9	Using Bluetooth GPS Devices	93
	Connecting GPS Devices via Bluetooth.....	94
10	Troubleshooting	97
	Responding to Error Messages.....	98
	Wireless LAN Notes.....	111
	Checking Network Settings.....	112
11	Reference	113
	Creating and Registering Captions.....	114
	Specifications.....	115
	Index.....	124

Safety Warnings

The following precautions are intended to prevent harm to you and others as well as damage to equipment. Become familiar with the precautions before using the transmitter to ensure correct and safe operation.

Warning Preventing Serious Injury or Death

- To prevent fire, excessive heat, chemical leakage, or explosion, follow these safety guidelines.
 - Do not insert metallic objects between electrical contacts of the transmitter, accessories, or connecting cables.
- Do not use the transmitter where there is flammable gas. There is a risk of explosion or fire.
- If the transmitter is dropped and internal parts are exposed, do not touch the exposed parts. There is a risk of electrical shock.
- Do not disassemble or modify the transmitter. High-voltage internal parts may cause electrical shock.
- Do not store the transmitter in dusty or humid places. There is a risk of fire or electrical shock.
- Before using the transmitter on board airplanes or in hospitals, make sure use is permitted. Electromagnetic waves emitted by the transmitter may interfere with instrumentation or medical equipment.

Caution Preventing Injury or Equipment Damage

- Do not leave the transmitter inside a vehicle in hot weather or near a heat source. The transmitter may become hot and cause burns if touched.
- Do not cover or wrap the transmitter with a cloth. This may trap heat inside, posing a risk of case deformation or fire.
- Do not use paint thinner, benzene, or other organic solvents to clean the transmitter. This poses a risk of fire and may be hazardous to your health.

If the product malfunctions, becomes damaged, or requires repair, contact your dealer or the nearest Canon Service Center.

Handling Precautions

- The transmitter is a precision instrument. Do not drop it or subject it to shock.
- The transmitter is not waterproof. Do not use it underwater.
- Wipe off any moisture with a clean, dry cloth. If the transmitter has been exposed to salty air, wipe it with a clean damp cloth after wringing it out to remove excess water.
- Never leave the transmitter near any equipment that generates a strong magnetic field, such as magnets or electric motors.
- Do not leave the transmitter in excessive heat, such as in a vehicle in direct sunlight. High temperature may damage the transmitter.
- Do not wipe the transmitter using cleaners containing organic solvents. If the transmitter becomes difficult to clean, take it to the nearest Canon Service Center.
- To avoid corrosion, do not store the transmitter where there are strong chemicals, such as in darkrooms or chemical labs.

Nomenclature

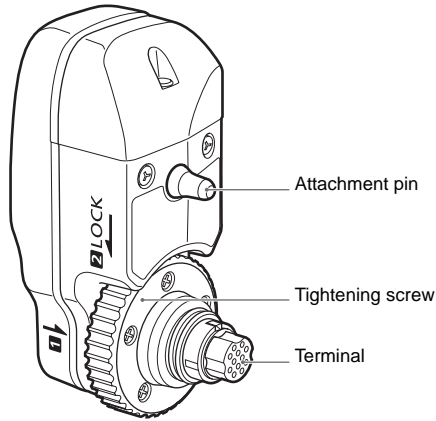

Transmitter Case

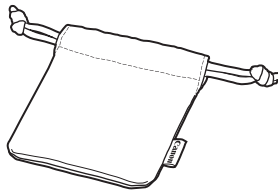

EOS-1D X rear LCD panel

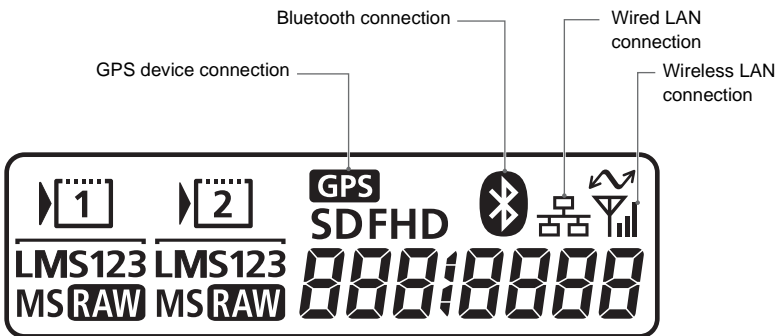

Attaching to the Camera

Turn off the camera before attaching the transmitter.

The transmitter is powered by the camera. Ensure the camera battery has sufficient charge. If the charge drops below 19%, you cannot transfer captured images.

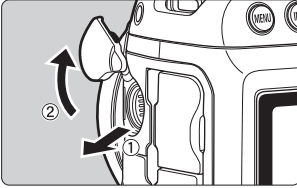

1 Open the terminal cover on the camera.

- Pull out the system extension terminal cover and rotate it toward the front.

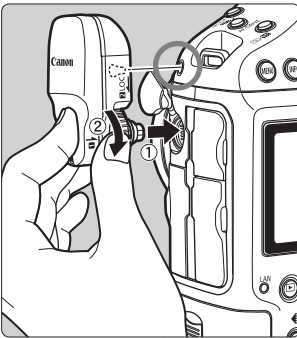

2 Attach the transmitter.

- Align the transmitter terminal and attachment pin with the corresponding camera terminal and hole.
- Push the terminal firmly into the camera.
- As you push the terminal into the camera with your left index finger, turn the tightening screw with your right index finger until it stops rotating to attach the transmitter securely.

Removal

- Turn off the camera.
- Loosen the tightening screw until it spins freely.
- Pull the terminal out of the camera.

Subsequent Organization of This Manual

Click one of the following chapter titles to view the corresponding page.

1 Basic Network Settings (p.13)

2 Transferring Images to an FTP Server (p.27)

3 Remote Capture Using EOS Utility (p.43)

4 Remote Capture Using WFT Server (p.49)

5 Using the Transmitter as a Media Server (p.61)

6 Linked Shooting (p.65)

7 Managing Settings Information (p.79)

8 Synchronizing the Camera Time Wirelessly (p.89)

9 Using Bluetooth GPS Devices (p.93)



1

Basic Network Settings

Complete the basic network settings by following transmitter connection instructions on the camera menu screen.

Getting Ready

[FTP trans.], [EOSUtility], [WFTserver]

The connection instructions help you follow the steps to connect the transmitter to an existing wireless LAN.

Set up the wireless LAN terminal (wireless LAN access point or adapter) and computer in advance so that the transmitter can join the wireless network. When configuring the basic network settings, bring the transmitter within 3 m / 9.8 ft. of the wireless LAN terminal.

Wireless Transmission of Movie

Individual movie files are large, and wireless file transmission takes some time. When setting up an environment for stable transmission to the wireless LAN terminal, refer to the information on page 111.

[MediaServ.]

Set up a DLNA*-compatible television, digital photo frame, or similar media player so that it is ready for use after the transmitter is connected to its network.

* DLNA: Digital Living Network Alliance

[LinkedShot]

Set up the camera attached with this transmitter, and other cameras compatible with linked shooting with WFT units attached.

Displaying the Connection Wizard

This section describes the process of following the connection instructions. If an error is displayed, refer to “Troubleshooting” in Chapter 10 (p.97) and check the settings.

- Pressing the shutter button or other camera controls during configuration by the connection instructions will close the connection instructions. Do not press the shutter button or other controls until configuration is finished.
- On the [F2] tab, set [Auto power off] to [Disable]. If auto power off is activated, the connection instructions will be closed during the configuration process.

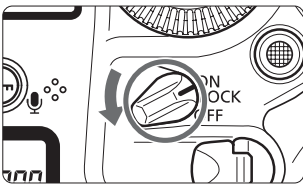

1 Turn the camera on.



2 Display the transmitter menu.

- On the camera, press the <MENU> button.
- On the [F3] tab, select [Communication settings] and press <SET>.

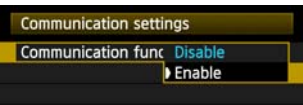

3 Select [Communication func].

- Set [Communication func] to [Enable], and then press <SET>.

▶ [Network settings] is now available.

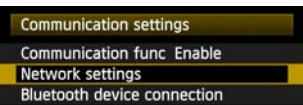

4 Select [Network settings].

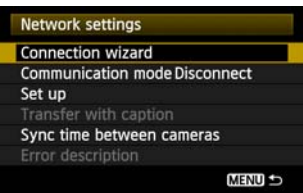

5 Select [Connection wizard].

- ▶ The [Select communication method] screen is displayed.

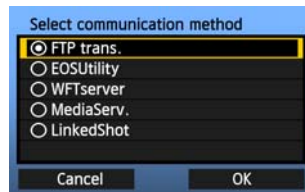



- ▶ The <LAN> lamp on the camera starts blinking.

Selecting the Communication Method and LAN Type ■

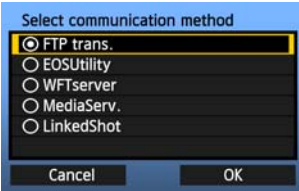
Selecting the Communication Method



- Turn the <  > dial to select the communication method, and then press <  >.
- Select [OK] and press <  > to go to the next screen.

• FTP trans.

Select this option to transfer captured images to an FTP server.

Images can be automatically transferred as you shoot them, or you can select images to be transferred later.

Computer Operating Systems

Use of [FTP trans.] requires that one of the following operating systems be installed on your computer. In addition, the computer must be set up as an FTP server in advance.

- **Windows 7 (Professional, Enterprise, or Ultimate Edition for 32- or 64-bit systems)**
- **Windows Vista (Business, Enterprise, or Ultimate Edition for 32- or 64-bit systems)**
- **Windows XP Professional**
- **Mac OS X 10.6 or 10.7**

For instructions on setting up your computer as an FTP server, refer to the computer documentation.

The following operating systems cannot be used because FTP server functionality is not provided.

- **Windows 7 Home Premium**
- **Windows Vista Home Premium/Home Basic Edition**
- **Windows XP Home Edition**

• EOSUtility

Select this option for remote capture over a wireless LAN using the EOS Utility software included with your camera.

In addition to remote capture, all camera operations in EOS Utility are supported. With this option, a wireless network is used instead of the USB cable.

Requires a computer with EOS Utility (included with EOS-1D X cameras) installed.

• **WFTserver**

Select this option for remote capture over a wireless LAN with the transmitter acting as a server.

Additionally, images on a memory card in the camera can be viewed and downloaded to a computer.

The camera can be accessed like browsing a webpage, by users at up to three computers.

Computer Operating Systems

Any computer with a web browser can be used, regardless of the operating system.

Even devices other than computers can be used, if they feature a web browser. However, if the web browser does not support JavaScript, WFT Server functions will be limited. Also note that devices with limited performance may display images more slowly, and downloading images to these devices may not be possible.

• **MediaServ.**

Select this option to view images on a memory card in the camera over a wireless LAN on a television.

This function requires a DLNA-compatible television, digital photo frame, or similar media player.

• **LinkedShot**

Select this option when performing linked shooting, using multiple compatible cameras with WFT units attached. Up to 10 slave cameras can be linked to the master camera on which you will release the shutter. Note that there will be a slight delay after you release the master camera shutter before the slave cameras shoot. Movie shooting is not supported.

For further instructions on [LinkedShot], refer to page 65 of this manual.

Selecting the LAN Type

For [LinkedShot] instructions, refer to page 65. Note that no information about [LinkedShot] is given in this chapter.

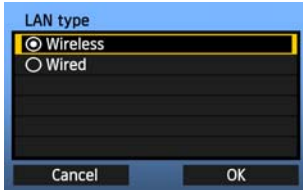

- Turn the dial to select the type of LAN, and then press .
- Select [OK] and press to go to the next screen.

Wireless LAN

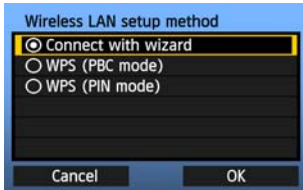

The [Wireless LAN setup method] screen is displayed.

[Connect with wizard]: See p.19

[WPS (PBC mode)]: See p.21

[WPS (PIN mode)]: See p.22

Select [WPS (PBC mode)] or [WPS (PIN mode)] when using a wireless LAN terminal compatible with Wi-Fi Protected Setup (WPS).

Wired LAN

With this option, a wired LAN connection is established using the Ethernet RJ-45 terminal on the EOS-1D X. For details, refer to the Wired LAN Instruction Manual included with the EOS-1D X.

Using the Wizard to Establish a Connection

Selecting the Wireless Network

When you select **[Connect with wizard]**, active wireless LAN terminals in your area are listed, accompanied by information about them. Select the SSID (or ESS-ID) of your desired wireless LAN terminal.

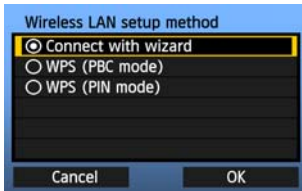

1

Select **[Connect with wizard]**.

- Turn the <◂> dial to select **[Connect with wizard]**, and then press <SET>.

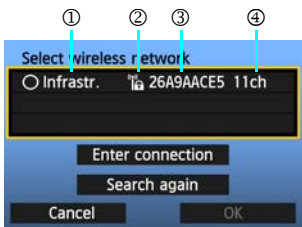

2

Select the wireless LAN terminal.

- To select the wireless LAN terminal, press <SET>.
- Turn the <◂> dial to select the wireless LAN terminal, and then press <SET>.
- Select **[OK]** and press <SET> to go to the next screen.

- ① Indicates whether the device is in infrastructure or ad hoc mode
- ② An icon is displayed if the wireless LAN terminal is encrypting communication
- ③ Indicates the first 9 characters of the SSID
- ④ Indicates the channel used

Encryption by Wireless LAN Terminals

If the wireless LAN terminal is encrypting communication, select the corresponding method in **[Authentication]** and **[Encryption]**.

- **[Authentication]**: Open system, Shared key, WPA-PSK, or WPA2-PSK
- **[Encryption]**: WEP, TKIP, or AES

[Enter connection] and **[Search again]**

- To configure settings for the wireless LAN terminal manually, select **[Enter connection]** and press <SET>. Complete the settings for the items displayed, one after another.
- To search for wireless LAN terminals again, select **[Search again]** and press <SET>.

Entering the Wireless LAN Encryption Key

Next, enter the encryption key of the wireless LAN terminal. For details on the encryption key, refer to the device's instruction manual.

Note that the screens displayed in steps 1 to 3 below vary depending on the authentication and encryption of the wireless LAN terminal.

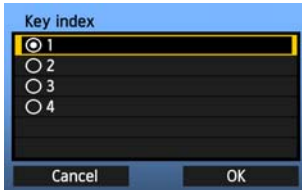

1

- The [**Key index**] screen is displayed only if WEP encryption is used by the wireless LAN terminal.
- Turn the <◂> dial to select the key index number specified as the access point, and then press <SET>.
- Select [**OK**] and press <SET> to go to the next screen.

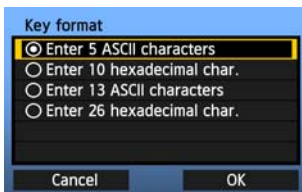

2

- Turn the <◂> dial to select the key format, and then press <SET>.
- Select [**OK**] and press <SET> to go to the next screen.

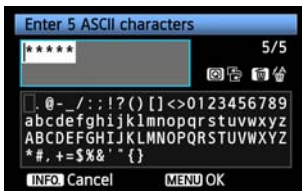

3

- Enter the encryption key.
- To switch between input areas, press the <Q> button.
- To move the cursor, turn the <◂> dial.
- In the bottom input area, turn the <◂> dial and press <SET> to enter the encryption key.
- If you make a mistake, press the <⏮> button to erase it.
- When you press the <MENU> button to complete the connection with the wireless LAN terminal, the [**Network**] screen (p.23) is displayed.
- To return to the previous screen, press the <INFO.> button. The entry is erased.

WPS Connections (PBC Mode)

This is a connection mode when using a wireless LAN terminal compatible with Wi-Fi Protected Setup (WPS). Pushbutton Connection mode (PBC mode) makes it easy to establish a connection between the camera and the wireless LAN terminal by pressing the WPS button on the wireless LAN terminal.

Note that if multiple wireless LAN terminals are active in your area, it may be harder to establish a connection. In this case, try using **[WPS (PIN mode)]** to establish a connection.

Confirm the position of the WPS button on the wireless LAN terminal in advance.

It may take about one minute to establish connection.

Connection may not be possible if stealth functions are enabled on the wireless LAN terminal. Deactivate stealth functions.

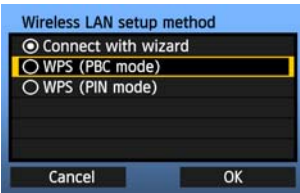

1

Select **[WPS (PBC mode)]**.

- Turn the <⊙> dial to select **[WPS (PBC mode)]**, and then press <SET>.
- Select **[OK]** and press <SET> to go to the next screen.

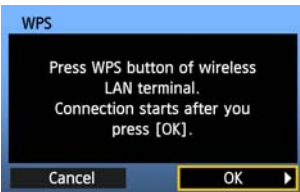

2

Establish a connection with the wireless LAN terminal.

- Press the WPS button on the wireless LAN terminal. For details about where the button is located and how long to press it, refer to the instruction manual of the wireless LAN terminal.
- Select **[OK]** and press <SET> to establish a connection with the wireless LAN terminal.
- When the connection with the wireless LAN terminal is established, the **[Network]** screen (p.23) is displayed.

WPS Connections (PIN Mode)

This is a connection mode when using a wireless LAN terminal compatible with Wi-Fi Protected Setup (WPS). In PIN code connection mode (PIN mode), an 8-digit identification number specified on the camera is set on the wireless LAN terminal to establish a connection.



Even if there are multiple wireless LAN terminals active in your area, this is a relatively reliable method of establishing a connection using a shared identification number.

It may take about one minute to establish connection.

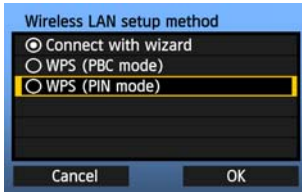
Connection may not be possible if stealth functions are enabled on the wireless LAN terminal. Deactivate stealth functions.



1 Select [WPS (PIN mode)].

- Turn the  dial to select [WPS (PIN mode)], and then press .
- Select [OK] and press  to go to the next screen.

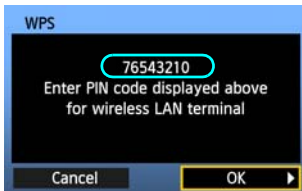

2 Specify the PIN code on the wireless LAN terminal.

- On the wireless LAN terminal, specify the 8-digit PIN code shown on camera LCD monitor.
- For instructions on setting PIN codes on the wireless LAN terminal, refer to the instruction manual of the wireless LAN terminal.
- Select [OK] and press  to display the confirmation screen.



3 Establish a connection with the wireless LAN terminal.

- Select [OK] and press  to establish a connection with the wireless LAN terminal.
- When the connection with the wireless LAN terminal is established, the [Network] screen (p.23) is displayed.

Configuring Network Settings

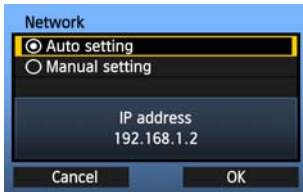

- Turn the <⊙> dial to select how to configure the network settings, and then press <SET>.
- Select [OK] and press <SET> to go to the next screen.

[Auto setting]

- Settings otherwise configured with [Manual setting] can be configured automatically. However, the IP address and similar settings must be automatically assigned and configured in environments using DHCP servers or wireless LAN terminals or routers supporting DHCP server functions. If an error is displayed, select [Manual setting] regardless of whether the IP address and similar settings are automatically assigned and configured.

[Manual setting]

The [IP address set.] screen is displayed after you select [Manual setting]. If [Auto setting] results in an error, enter the IP address manually. As the IP address, enter the IP address assigned to the camera.

Enter the [IP address], [Subnet mask], [Gateway], and [DNS address] on each screen as they are displayed. If you are not sure what to enter, refer to page 112, “Checking Network Settings,” or ask the network administrator or another person knowledgeable about the network.

- When entering numbers for the IP address, subnet mask, and so on, press <SET> to move the input position and turn the <⊙> dial to enter the number.

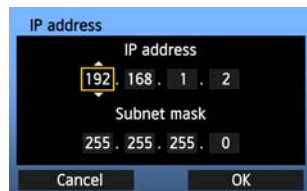
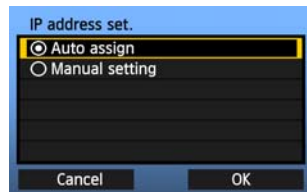

Completing Settings for the Communication Method

The following instructions are for settings screens that vary depending on the communication method (FTP Transfer, EOS Utility, WFT Server, or Media Server), as shown below. Read the page that introduces the selected communication method.

FTP trans.

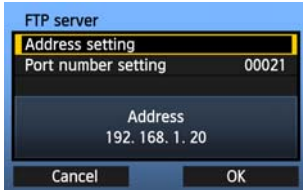

Chapter 2 (p.27)

EOSUtility

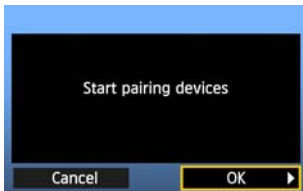

Chapter 3 (p.43)

Windows 7 and Windows Vista Users

Before performing the operations from page 43, perform the operations below. If these operations are not performed, the WFT Pairing Software described on page 44 may not start.

Open the [C Drive] → [Program Files] → [Canon] → [EOS Utility] → [WFTPairing] folder (in this order), and then double-click the [WFT FirewallSettings] icon.

After performing this operation, perform the operation on page 43.

WFTserver

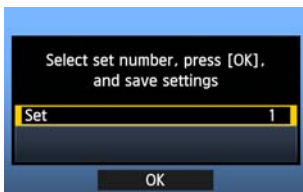

Chapter 4 (p.49)

MediaServ.

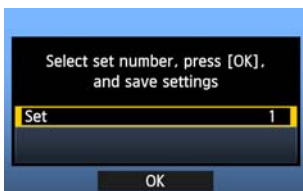

Chapter 5 (p.61)

Virtual Keyboard Operation

The virtual keyboard is displayed during entry of the encryption key, server name, and other information.

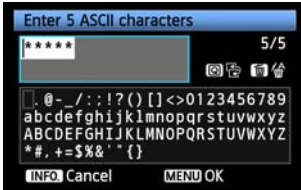

Switching to other input areas

To switch between input areas, press the <[Q]> button.

Moving the cursor

To move the cursor, turn the <[DIAL]> dial.

You can also move the cursor using <[DIRECTIONAL KEYS]>.

Entering text

In the bottom input area, turn the <[DIAL]> dial to move the cursor and press <[SET]> to enter text.

You can also move the cursor using <[DIRECTIONAL KEYS]>.

You can check how many characters you have entered by referring to [* / 5] in the upper-right corner of the screen.

Deleting text

If you make a mistake, press the <[ERASE]> button to erase it.

Confirming entries

Press the <[MENU]> button to confirm what you have entered and go to the next screen.

Canceling entries

Press the <[INFO]> button to erase the entry and return to the previous screen.



2

Transferring Images to an FTP Server

With FTP transfer, you can automatically transfer each image to the FTP server as you shoot or transfer a set of shots together.

Configuring FTP Communication Settings

These instructions are continued from Chapter 1.

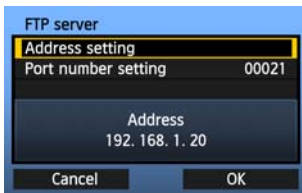

1

- Turn the <⊙> dial to select **[Address setting]**, and then press <SET>.



2

- If you have set the DNS server setting to **[Disable]**, the screen on the left is displayed.
- Press <SET> to select the input position, and then turn the <⊙> dial to enter the IP address of the FTP server.



- If you have set the DNS server IP address setting to **[Auto assign]** or **[Manual setting]**, the screen on the left is displayed.
- For instructions on screen operations, refer to “Virtual Keyboard Operation” (p.25).
- Enter the FTP server’s server name or IP address.

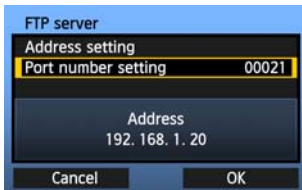

3

- In **[Port number setting]**, enter 00021, in most cases.
- Turn the <⊙> dial to select **[OK]**, and then press <SET> to go to the next screen.

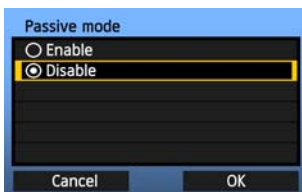

4

- Complete the **[Passive mode]** settings.
- If an Error 41 (“Cannot connect to FTP server”) is displayed in step 8, setting **[Passive mode]** to **[Enable]** may resolve it.

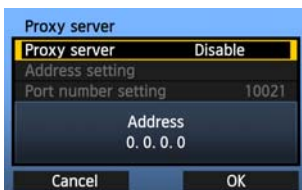

5

- Complete the **[Proxy server]** settings.
- Turn the <⊙> dial to select **[OK]**, and then press <SET> to go to the next screen.



6

- Complete the [**Login method**] settings.
- Turn the <⌂> dial to select [**OK**], and then press <SET> to go to the next screen.

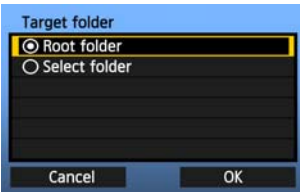

7

- Complete the [**Target folder**] settings.
- Select [**Root folder**] to have images saved in the root folder as specified in FTP server settings. (p.42)
- Select [**Select folder**] to specify a subfolder in the root folder. If no folder exists, a folder will be created automatically.
- Turn the <⌂> dial to select [**OK**], and then press <SET> to connect to the FTP server.



8

- On the confirmation screen displayed next, select [**OK**] and press <SET>.
- ▶ The <LAN> lamp on the camera is lit in green.

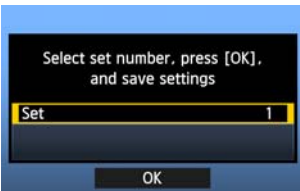

9

- Press <SET>. Turn the <⌂> dial to select the set number, and then press <SET>.
- Turn the <⌂> dial to select [**OK**], and then press <SET>. After the connection wizard is closed, the display reverts to the menu screen.

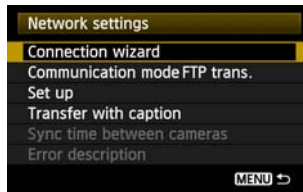

- Settings information is stored on the camera. It is not stored on the transmitter.

The network settings for FTP transfer are now complete.

During image transfer, the <LAN> lamp on the camera blinks in green.

Automatic Image Transfer After Each Shot

An image can be automatically transferred to the FTP server immediately after shooting. You can also continue still photo shooting even while images are being transferred.

Before shooting, be sure to insert a memory card in the camera. If you shoot without recording images, they cannot be transferred.

Note that automatic transfer of movie is not supported. Transfer the movie after shooting, as described on pages 33-40.



1 Select **[Communication settings]**.

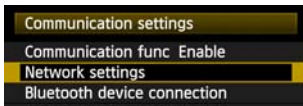

2 Select **[Network settings]**.

- Once you have set **[Communication func]** to **[Enable]**, you can select **[Network settings]**.

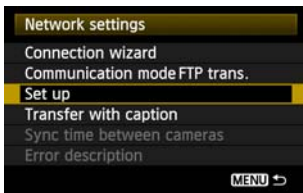

3 Select **[Set up]**.

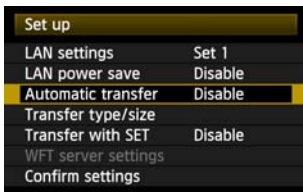

4 Select **[Automatic transfer]**.

- Select **[Enable]**.

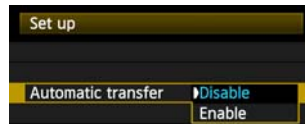

5 Take the picture.

- ▶ The captured image is transferred to the FTP server.



- During continuous shooting, images are transferred to the FTP server in the order they are captured.
- The captured images are also stored on the memory card.
- Any images for which transfer fails or is interrupted will be transferred automatically when the wireless LAN connection is recovered (p.32). These images can also be transferred in batch manually at a later time (p.36).

Selecting Particular Sizes or Types of Images to Transfer

With automatic transfer, you can select which images to transfer when recording images of different sizes to separate cards, or when recording both RAW and JPEG images.

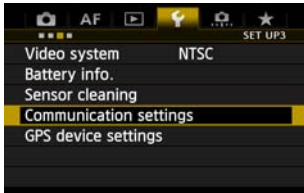

1 Select [Communication settings].

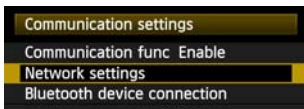

2 Select [Network settings].

- Once you have set [Communication func] to [Enable], you can select [Network settings].

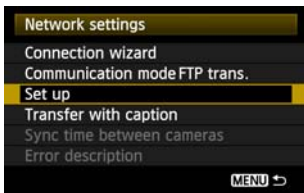

3 Select [Set up].

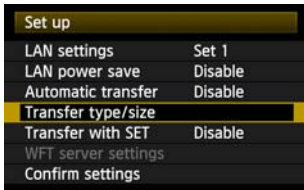

4 Select [Transfer type/size].

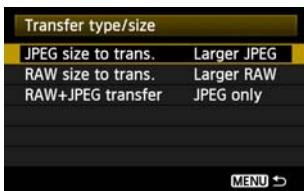

5 Select the size and type of images to transfer.

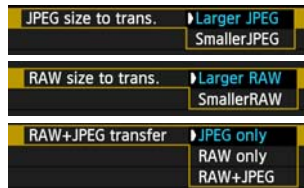

- To transfer smaller JPEGs when the camera is set up to record larger JPEGs to one card and smaller JPEGs to the other, set [**JPEG size to trans.**] to [**Smaller JPEG**].
- To transfer either RAW or JPEG images when the camera is set up to record RAW images to one card and JPEGs to the other, specify which images to transfer in the [**RAW+JPEG transfer**] setting. Similarly, complete the same setting when RAW+JPEG images are recorded simultaneously to a single memory card.
- When images of the same size are recorded to both cards simultaneously, images recorded to card 1 are transferred, regardless of image quality (compression).

Auto Retry if Transfer Fails

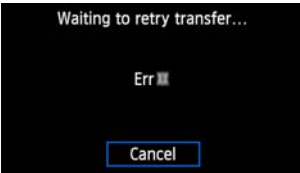

If transfer fails, the <LAN> lamp on the camera blinks in red. In this case, press the <MENU> button, select [**Communication settings**] on the [**1/3**] tab, and press <SET>. When the screen shown on the left is displayed, check the error number and see page 98 to eliminate the cause of the error.

Once the cause of the error is eliminated, the images whose transfer previously failed will be transferred automatically. With this option activated, transfer is attempted again automatically after failure, whether when automatic transfer is used or when transferring captured images via FTP. Note that when you cancel image transfer, or turn off the camera, the image will not be re-transferred automatically. See page 36 and transfer the image manually.

Enabling LAN Power Management

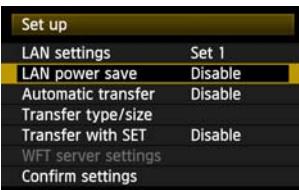

- In the menu, select [**Communication settings**] → [**Network settings**] → [**Set up**] → [**LAN power save**].
- When this option is set to [**Enable**], the transmitter will log off from the FTP server after transfer and switch to standby mode. Wireless connectivity will be restored automatically when you attempt to transfer images, and the transmitter will reconnect to the FTP server.

Transferring Images Individually

Simply select an image and press <SET> to transfer it. You can also add a caption before transferring images. You can also continue still photo shooting even while images are being transferred.

Transferring the Current Image



1 Select [Communication settings].

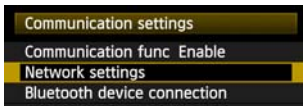

2 Select [Network settings].

- Once you have set [Communication func] to [Enable], you can select [Network settings].



3 Select [Set up].

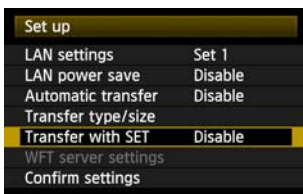

4 Select [Transfer with SET].

- Select [Enable].

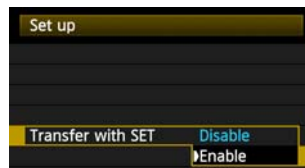

5 Select the image.

- Press the <▶> button on the camera.
- Select the image to transfer, and then press <SET> to transfer the image.
- **Movie cannot be transferred this way. Selecting movie and pressing <SET> will display the movie playback panel.**

Adding a Caption Before Transfer

You can add a registered caption to each image before transfer. This is convenient if you want to inform the recipient the printing quantity, for example. The caption is also added to images stored on the camera.

For instructions on creating and registering captions, refer to page 114.

You can check for captions added to images by examining the Exif information, in the user comments.

1 Take the picture.

2 Select [Communication settings].

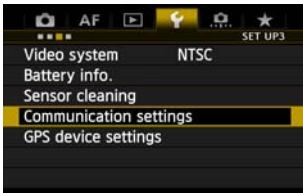

3 Select [Network settings].

- Once you have set [Communication func] to [Enable], you can select [Network settings].

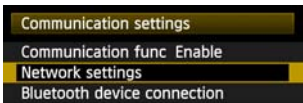

4 Select [Transfer with caption].

- ▶ The last captured image is displayed.

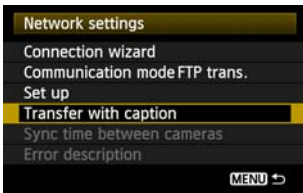

- It is not possible to select other images on the [Transfer with caption] screen. To select another image for transfer with a caption, view that image before following these steps.



5 Select a caption.

- Turn the <◂> dial to select the **[Caption]** frame, and then press <SET>.
- Turn the <◂> dial to select the content of the caption, and then press <SET>.



6 Transfer the image.

- Turn the <◂> dial to select **[Transfer]**, and then press <SET>.

Batch Transfer

After shooting, you can select multiple images as desired and transfer them all at once. You can also transfer unsent images or images that could not be sent previously. You can also continue still photo shooting even while images are being transferred.

Selecting Images to Transfer

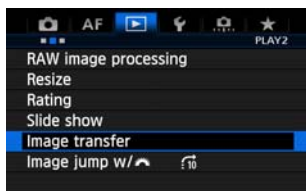

1 On the [PLAY2] tab, select [Image transfer].

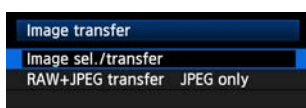

2 Select [Image sel./transfer].

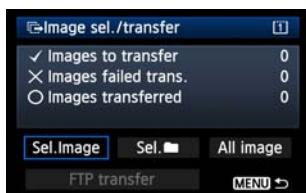

3 Select [Sel. Image].
▶ An image is displayed.



4 Select images to transfer.

- Press <SET>. Turn the <DISP> dial to display <✓> in the upper left corner of the image to transfer.
- Press <SET> to confirm your selection. You can select up to 9,999 images.
- To display three images per screen, hold the <Q> button and turn the <DISP> dial left. To display one image per screen, hold the <Q> button and turn the <DISP> dial right.



- After selecting images to transfer, press the <MENU> button.



5 Transfer the images.

- Select **[FTP Trans.]**.
- Select **[OK]** on the confirmation screen displayed next.
- ▶ A transfer progress screen is displayed.



[RAW+JPEG transfer] Options

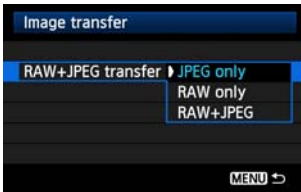

Selecting **[RAW+JPEG transfer]** in step 2 on the preceding page will give you the option of transferring RAW images, JPEG images, or both types of images. You will have the same options whether you specify **[Sel. Image]**, **[Sel. [Folder]]**, or **[All image]** as the image selection method.

Menu Operation During Image Transfer

You can use the menu even during image transfer. However, to prevent transfer problems, some menu items are unavailable during transfer, including **[Network settings]**, **[Protect images]**, **[Erase images]**, **[Format card]**, and **[Record func+card/folder sel.]**.



If you shoot a movie during the image transfer of captured images, the image transfer will be temporary cancelled during movie shooting.

Batch Transfer of Images in a Folder

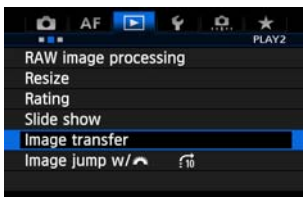

1 On the [▶2] tab, select [Image transfer].

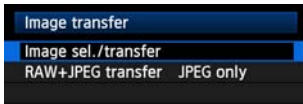

2 Select [Image sel./transfer].



3 Select [Sel. [Folder]].

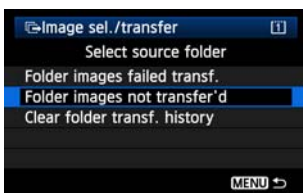

4 Select [Folder images not transfer'd].

- To transfer images that could not previously be transferred, select [Folder images failed transf.].



5 Select a folder.



6 Transfer the images.

- Select [**FTP Trans.**].
- Select [**OK**] on the confirmation screen displayed next.
- ▶ A transfer progress screen is displayed.



Selecting [**Clear folder transf. history**] will set the transfer history of images in the selected folder to "unsent." This enables you to resend all the images in the folder later by selecting [**Folder images not transfer'd**].

Batch Transfer of Images on Memory Cards

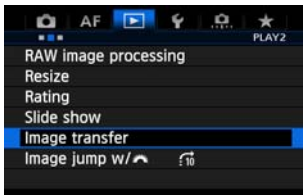

1 On the [▶2] tab, select [Image transfer].

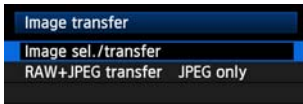

2 Select [Image sel./transfer].



3 Select [All image].

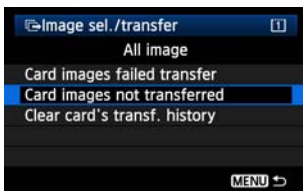

4 Select [Card images not transferred].

- To transfer images that could not previously be transferred, select [Card images failed transfer].

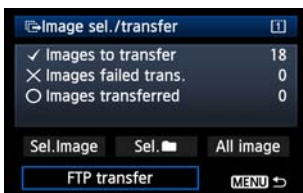

5 Transfer the images.

- Select [FTP Trans.].
- Select [OK] on the confirmation screen displayed next.
- ▶ A transfer progress screen is displayed.



Selecting [Clear card's transf. history] will set the transfer history of images on the memory card to "unset." This enables you to resend all the images on the card later by selecting [Card images not transferred].

Checking Image Transfer History

Checking the Transfer History of Individual Images

To check the transfer history in [Image sel./transfer], select [Sel.Image].

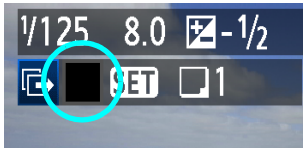

Image not selected for transfer (no icon)



Image selected for transfer



Image could not be transferred

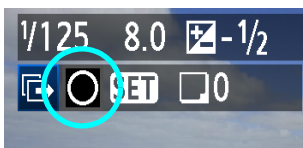

Image transferred

Checking the Transfer History of Memory Cards



On the [Image sel./transfer] screen, you can check the number of images for transfer as well as the transfer history of images in the memory card. Specifically, you can check the number of images classified as [Images failed trans.] and [Images transferred].

Viewing Transferred Images

Images transferred to the FTP server are stored in the following folder as specified in the FTP server settings.

Windows

- Under the default settings of the FTP server, images are stored in **[C drive]** → **[Inetpub]** folder → **[ftproot]** folder, or in a subfolder of this folder.
- If the root folder of the transfer destination has been changed in the FTP server settings, ask the FTP server administrator where images are transferred.

Macintosh

- Open the **[Macintosh HD]** → **[Users]** folder. The folder where images are stored is located in the folder of the user currently logged on, or in a subfolder there.

Folders for Image Storage

Under the default transmitter settings, transferred images will be stored in the root folder specified in the FTP server settings, in a folder structure such as **A/DCIM/100EOS1D** which is automatically created.

Additionally, when you have selected card 1 for recording and playback, a folder structure such as “**A/DCIM/100EOS1D**” is automatically created for image storage. For card 2, the folder structure is “**B/DCIM/100EOS1D**”. (Images are stored separated, with card 1 images in folder A and card 2 images in folder B.)

3

Remote Capture Using EOS Utility

You can use EOS Utility to shoot remotely over a wireless LAN. In addition to remote capture, all EOS Utility camera operations except firmware updating are supported, because this option utilizes a wireless network instead of a USB cable.

 The WFT-E6 cannot be used with the Mac version of EOS Utility (as of November 2011). Check the Canon website for the latest system requirements, including supported OS versions.

Configuring EOS Utility Communication Settings

These instructions are continued from Chapter 1.

With EOS Utility, you can use the included WFT Pairing Software to establish a connection between the transmitter and a computer.

WFT Pairing Software is installed automatically during easy installation of the software provided with the camera. If it is not installed, install it on the computer for communication with the transmitter before this procedure.

The configuration procedure is as follows, using Windows 7 as an example.

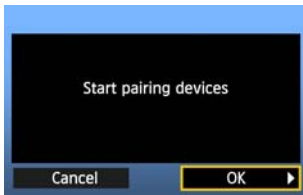

1

- First, the pairing screen is displayed.
- Turn the <◀▶> dial to select [OK]. When you press <SET>, the following message is displayed. ***** represents the last six digits of the MAC address of the WFT-E6 for the connection.



2

- Start the pairing software.
- Normally, it is installed in the same location as EOS Utility.

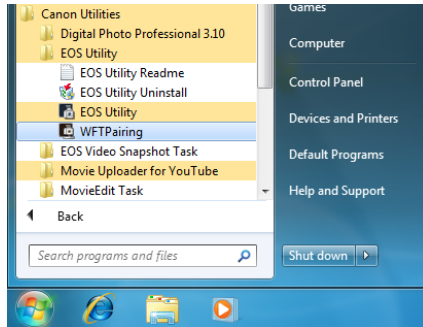

- ▶ After the pairing software starts up, an icon is displayed in the task bar.
- ▶ When the camera is detected, a message is displayed.

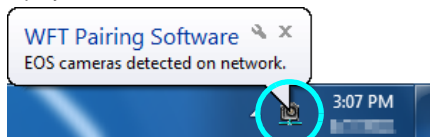

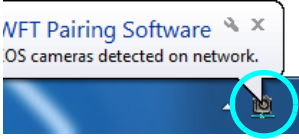

3

- Double-click the pairing software icon.
- ▶ Detected cameras are listed. Cameras that have already been connected are not included in the list.

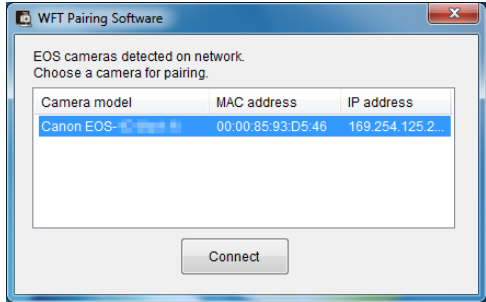

- Click **[Connect]**.
- If multiple cameras are displayed, identify the camera to connect to by its **[MAC address]** or **[IP address]**.
- You can check the **[MAC address]** and **[IP address]** by accessing **[Confirm settings]** in the menu (p.80).

4

- When the camera detects the computer on which you clicked **[Connect]** in step 3, the message on the left is displayed.
- Turn the **<DISP>** dial to select **[OK]**, and then press **<SET>**.

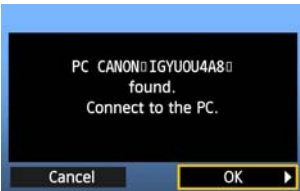

5

- Press **<SET>**. Turn the **<DISP>** dial to select the set number, and then press **<SET>**.
- After you turn the **<DISP>** dial to select **[OK]** and press **<SET>**, the connection wizard is closed and EOS Utility starts up.
- ▶ The **<LAN>** lamp on the camera is lit in green.
- Settings information is stored on the camera. It is not stored on the transmitter.

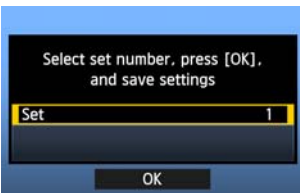



The EOS Utility network settings are now complete.

- There is no need to complete pairing again if you will continue using a particular camera, transmitter, and computer together after pairing without changing the settings. Before your next PTP session, simply turn on the camera to which the transmitter is attached and start the pairing software. The connection between the camera and computer will be established automatically.
- You can add the pairing software to the software launched at startup of your computer. In EOS Utility on the **[Preferences]** → **[Basic Settings]** tab, select [**Add WFT Pairing Software to the Startup folder**].

Using EOS Utility

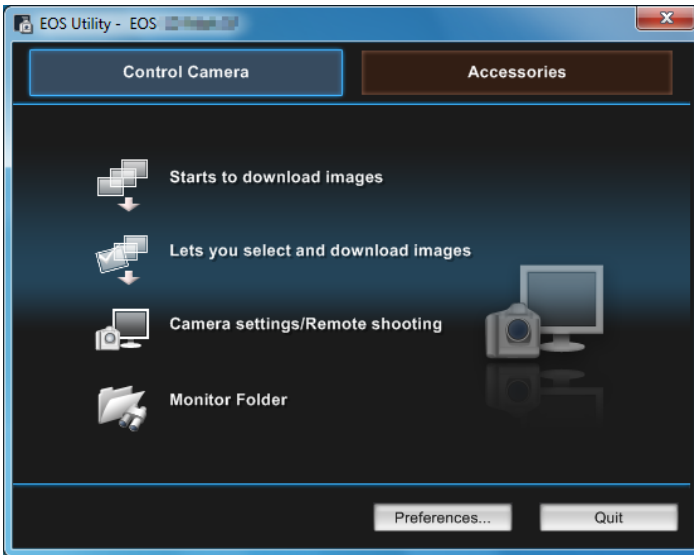
For EOS Utility instructions, refer to the Software Instruction Manual (PDF). You can take full advantage of EOS Utility via the transmitter just as via a USB connection, without restrictions.



 In Remote Live View shooting, the rate of image transmission is slower than via USB. The motion of moving subjects cannot be displayed smoothly.



4

Remote Capture Using WFT Server

Using a web browser, you can view images on a memory card in the camera and download them to a computer.

Additionally, you can shoot remotely over a wireless LAN. Note that bulb, mirror lockup, and movie shooting are not supported.

Configuring WFT Server Communication Settings ■

These instructions are continued from Chapter 1.

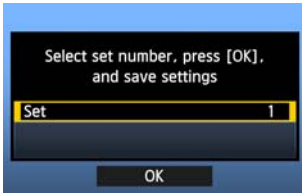

- Press <SET>. Turn the <⌚> dial to select the set number, and then press <SET>.
- Press <SET> again. After the connection wizard is closed, the display reverts to the menu screen.
- ▶ The <LAN> lamp on the camera is lit in green.

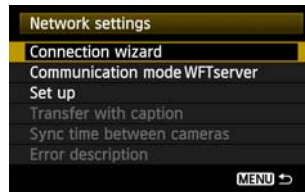

- Settings information is stored on the camera. It is not stored on the transmitter.

Setting up an Account

Enter a logon name and password for accessing the camera from a computer. The logon name and password you specify here are used on the computer when connecting to the camera.



1

- Turn the <⌚> dial to select [**Set up**], and then press <SET>.

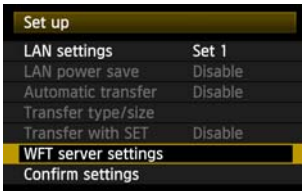

2

- Turn the <⌚> dial to select [**WFT server settings**], and then press <SET>.

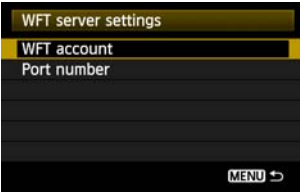

3

- Turn the <⊙> dial to select [**WFT account**], and then press <Ⓜ>.
- When changing the port number, turn the <⊙> dial to select [**Port number**] and press <Ⓜ>. Note that there is normally no need to change the port number (80).

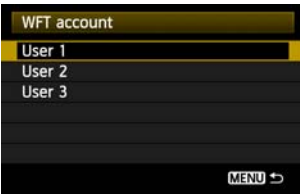

4

- Select a user number.
- With WFT Server, you can connect the camera to up to three computers. Select a user number to prevent conflicts when users at other computers are connected to the transmitter simultaneously.
- Turn the <⊙> dial to select [**User ***], and then press <Ⓜ>.

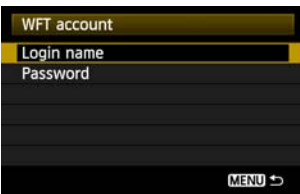

5

- After you select [**Login name**] and [**Password**], the following input screen is displayed.
- For instructions on input screen operations, refer to “Virtual Keyboard Operation” (p.25).



The WFT Server network settings are now complete.

Displaying WFT Server

In the web browser, display WFT Server, a screen for transmitter operations. Make sure you have already established a connection between the camera and computer.

1 Start the web browser.

- First, start Internet Explorer or another web browser.



2 Enter the URL.

- In the address field, enter the IP address assigned to the camera.
- Press the <Enter> key.



3 Complete the [Login name] and [Password] settings.

- Enter the login name and password as specified in the procedure on page 51. Click [OK] to display the WFT Server screen.
- Web browsers that support JavaScript now display the screen on the left below in step 4. Otherwise, a message is displayed if JavaScript is not supported. Choosing not to use JavaScript will display the screen on the right below in step 4, with limited functions.

4 Select the language.

- Select a language at the bottom of the screen.

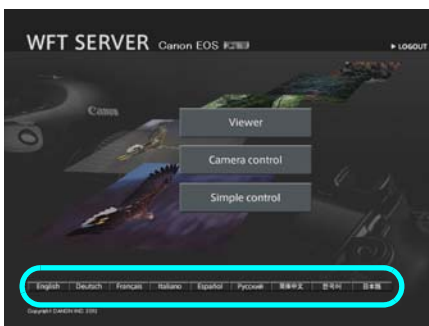

JavaScript supported

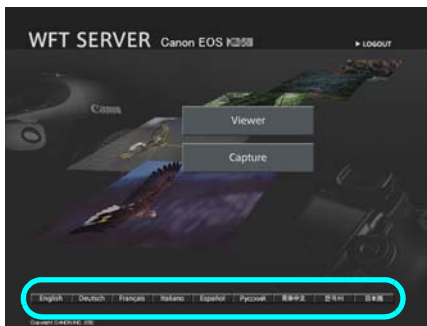

JavaScript not supported



If you don't know the URL (IP address)

You can check the URL (IP address) by accessing [Confirm settings] in the menu (p.80).

Viewing Images

Browse images on the camera's memory card as follows.

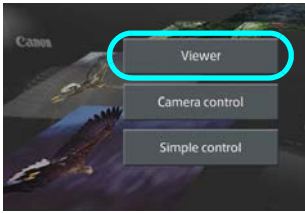

1

Click [Viewer].

- ▶ The image viewing screen is displayed.

2

Select the memory card.

- Click [CF1] or [CF2].
- Click the [DCIM] folder and select the folder containing the images.

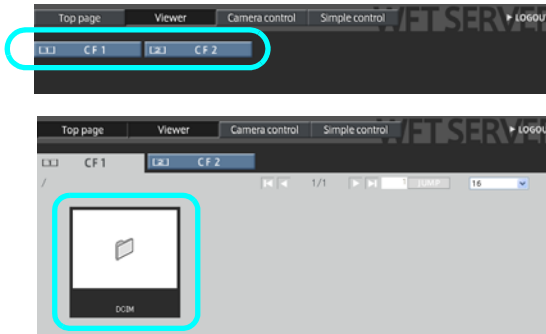

3

Select an image.

- To view another image, click the < [Left Arrow] [Right Arrow] > buttons or jump to other pages.
- In JavaScript-compatible web browsers, you can specify how many thumbnails are shown per screen by clicking the pull-down list in the upper-right corner of the screen.

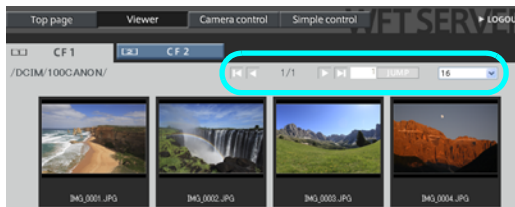

4 Download images to the computer.

- Click a thumbnail.
- ▶ The image is displayed at a larger size.
- To download the image to your computer, click .
- Click **[Return]** to return to the image viewing screen.



Although actual RAW images and movies are not displayed here, they can be downloaded to the computer in the same way as JPEGs.

Remote Capture [Camera control]

First, set up the camera for Live View shooting. Note that remote capture of movies is not supported.

For web browsers that do not support JavaScript, refer to page 59, "Remote Capture."

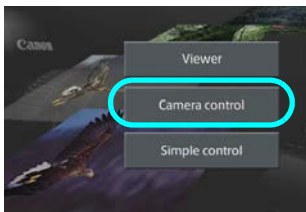

1 Click [Camera control].

▶ The advanced capture screen is displayed.

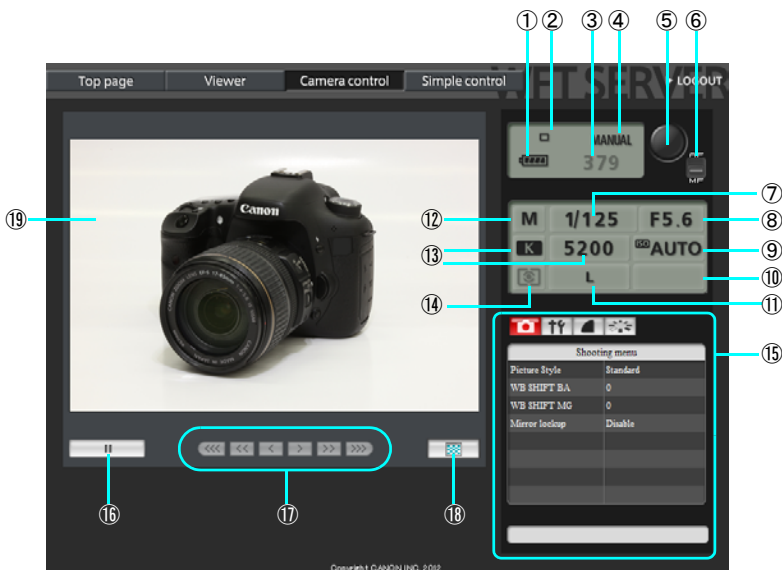

①	Battery check
②	Drive mode
③	Possible shots
④	AF mode
⑤	Release button
⑥	AF/MF switch
⑦	Shutter speed
⑧	Aperture
⑨	ISO speed
⑩	Exposure compensation

⑪	Quality
⑫	Shooting mode
⑬	White balance
⑭	Metering mode
⑮	Menu
⑯	Live View shooting button
⑰	Manual focus button
⑱	Live View image size switching button

* Items that cannot be set via WFT Server are shaded on the screen.

2 Set the lens focus mode switch to <AF>.

- Under these conditions, click the release button (⑤). When you let go of the button, the camera autofocuses and the picture is taken.
- With One-Shot AF, the picture is not taken if focus is not achieved. Try following the next steps to display Live View image and focus manually.



3 Display Live View image.

- Click the Live View shooting button (⑩).
- ▶ The AF/MF switch (⑥) is set to <MF>, and Live View image is displayed.
- If Live View image is not displayed, enable Live View shooting in the menu (⑮).
- To make Live View image display more responsive, click the Live View image size switching button (⑰). Live View image is now displayed at a smaller size, improving responsiveness. To restore the original size, click this button again.

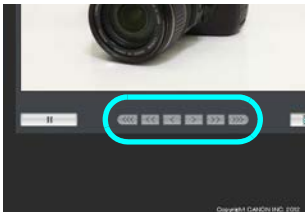

4 Manually adjust the focus.

- Click the buttons <◀◀◀>, <◀◀>, <◀>, <▶>, <▶▶>, and <▶▶▶> to adjust the focus. Note that autofocus is not supported during Live View image display.
- To focus more closely, click <◀◀◀>, <◀◀>, or <◀>. To focus farther away, click <▶>, <▶▶>, or <▶▶▶>.
- Three levels of focus adjustment are available.
 - <◀◀◀> <▶▶▶> : Largest increment
 - <◀◀> <▶▶> : Intermediate increment
 - <◀> <▶> : Smallest increment

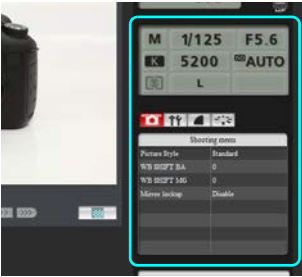

5 Configure the shooting settings.

- Click setting items (such as quality) to view the setting details, which you can configure.
- Complete the settings as needed.

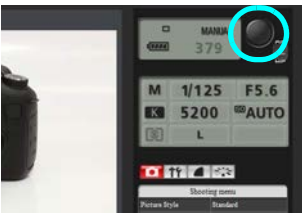

6 Take the picture.

- Click the release button (Ⓢ). When you let go of the button, the picture is taken.
- ▶ The captured image is now displayed.
- Captured images are stored on the memory card.
- To download images to your computer, refer to page 53, and use the **[Viewer]** function.



The Live View image may freeze when shooting if the camera is accessed by multiple computers.

Remote Capture [Simple control]

First, set up the camera for Live View shooting. Note that remote capture of movies is not supported.

For web browsers that do not support JavaScript, refer to page 59, "Remote Capture."

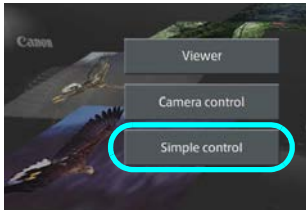

1 Click [Simple control].

- ▶ The basic capture screen is displayed, and then Live View image is displayed.

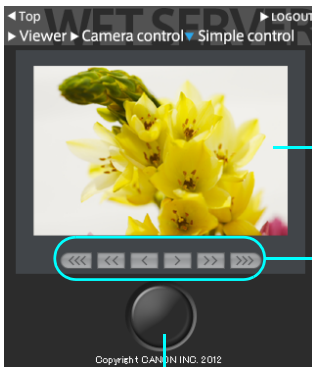

Live View image screen

Manual focus button

< <<<< > < << > < < > > >>> > : Focuses more closely

< > > > > > > > > > : Focuses farther away

Levels of focus adjustment

< <<<< > < >>>> > : Largest increment

< << > < >> > : Intermediate increment

< < > < > > : Smallest increment

Release button

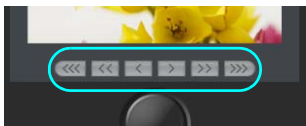

2 Manually adjust the focus.

- Set the lens focus mode switch to <AF>.
- Click the buttons < <<<< > < << > < < > > >>> > , < << > < << > < < > > >>> > , < > > > > > > > > > > to adjust the focus.

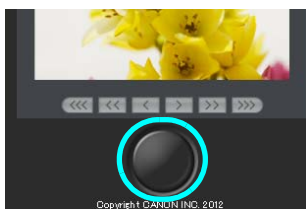

3 Take the picture.

- Click the release button. When you let go of the button, the picture is taken.
- ▶ The captured image is now displayed.
- Captured images are stored on the memory card.
- To download images to your computer, refer to page 53, and use the [Viewer] function.

Remote Capture

The following instructions are for remote capture with web browsers that do not support JavaScript.

First, set up the camera for Live View shooting. Note that remote capture of movies is not supported.

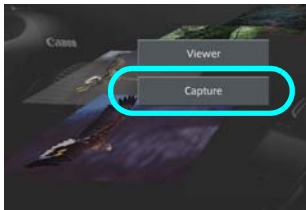

1 Click [Capture].

- ▶ The capture screen is displayed.
- Live View image is not displayed.

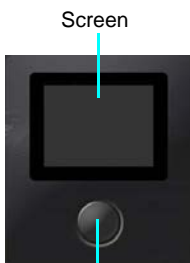

2 Take the picture.

- Set the lens focus mode switch to <MF>. Adjust the focus on the camera.
- Click the release button. When you let go of the button, the picture is taken.
- ▶ The captured image is now displayed.
- Captured images are stored on the memory card.



3 Download images to the computer.

- Click the image.
- ▶ The image is displayed at a larger size.
- To download the image to your computer, click .
- Click [Return] to return to the capture screen.

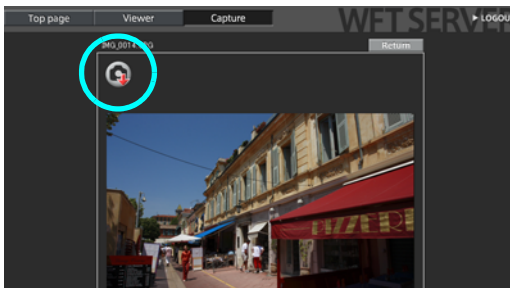

Although actual RAW images are not displayed here, they can be downloaded to the computer in the same way as JPEGs.

Using WFT Server in Linked Shooting

Remote Capture in WFT Server can be used in conjunction with the transmitter's "Linked Shooting" function (p.70). Additionally, you can view and download images on master or slave camera memory cards.

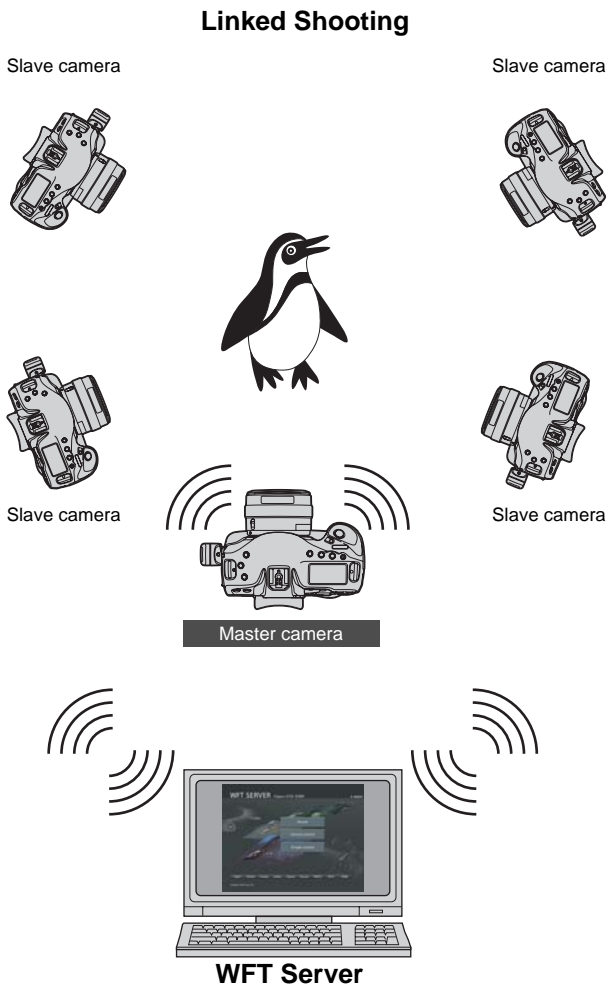

5

Using the Transmitter as a Media Server

Images on a memory card in the camera can be viewed over a wireless LAN on a television.

This function requires a DLNA*-compatible television, digital photo frame, or similar media player. (Subsequently, this equipment is collectively referred to as the media player.)

* DLNA: Digital Living Network Alliance

Configuring Media Server Communication Settings

These instructions are continued from Chapter 1.

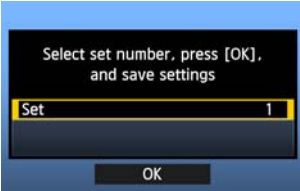

- Press $\langle \text{SET} \rangle$. Turn the $\langle \odot \rangle$ dial to select the set number, and then press $\langle \text{SET} \rangle$.
- Press $\langle \text{SET} \rangle$ again. After the connection wizard is closed, the display reverts to the menu screen.



- The information you specified is stored on the camera. It is not stored on the transmitter.

The media server network settings are now complete.

Displaying Captured Images on a Television

Operate the media player controls to display on a television the images on the camera's memory card. Note that RAW images and movies cannot be displayed.

The following operations are done on the media player. For details, refer to the media player instruction manual.

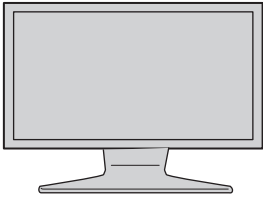

1 Display the media player settings screen on your television.

- Using the media player functions, display the <  EOS1D > (media server) icon on the television.
- A different icon may be displayed, depending on the media player. In that case, locate the icon labeled EOS1D.



2 Select the < EOS1D > (media server) icon.

- Selecting the <  EOS1D > icon will display an icon of the memory card. After you select this icon, you can select folders and images.
- Select an image to display it at a larger size on the television. For details, refer to the media player instruction manual.

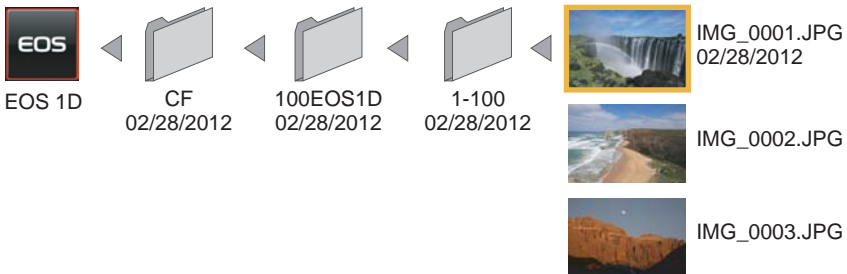

- Information overlay and details displayed on the television vary depending on the media player. Note that depending on the media player, image information may not be displayed.
- Icons labeled 1-100 (for example) contain images grouped by file number in the selected folder (**EOS1D).
- Date information shown for images is based on Exif information added to the images.
- Date information shown for memory cards or folders may be the current date set on the camera, in some cases.



6

Linked Shooting

With linked shooting, up to 10 slave cameras can be linked in a wireless network (via IEEE 802.11g in ad hoc mode) to the master camera on which you will release the shutter.

Note that there will be a slight delay after you release the master camera shutter until the slave camera shutters are released. Movie shooting is not supported.



Slave camera



Master camera

Preparing Slave Cameras

After setting up the slave cameras as described on this page, follow the steps on the next page for basic linked shooting. For instructions to view or download to your computer the images stored on cameras, refer to page 70.



1 Select **[Communication settings]**.

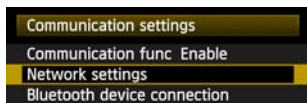

2 Select **[Network settings]**.

- Once you have set **[Communication func]** to **[Enable]**, you can select **[Network settings]**.



3 Select **[Connection wizard]**.

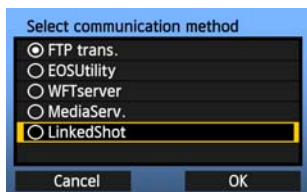

4 Select **[LinkedShot]**.

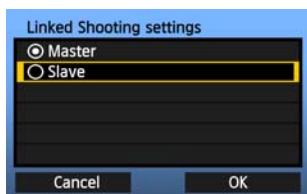

5 Set up the slave cameras.

- Select **[Slave]**.
- ▶ The slave cameras are now ready, with the following screen displayed.

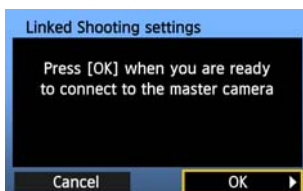

- When using multiple slave cameras, set up all slave cameras to slave state.
- Once the settings are complete, slaves cannot be added or removed. You must repeat the setup process from step 1.

Basic Linked Shooting

Shoot with the master camera linked to slave cameras as follows.

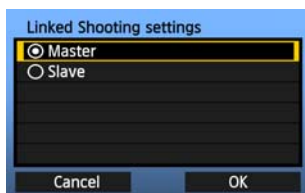

1 Set up the master camera.

- Configure the settings on the master camera following steps 1-3 on the preceding page, and then select [**Master**].

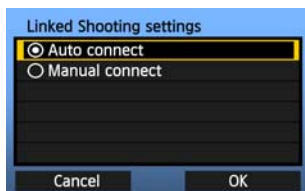

2 Select [**Auto connect**].

- For [**Manual connect**] instructions, refer to page 71.

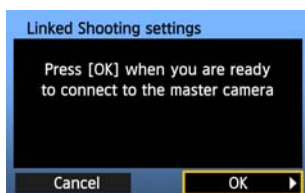

3 Switch to setting up the slave cameras.

- On the slave cameras, select [**OK**].

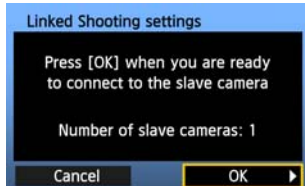

4 Check the number of slave cameras.

- ▶ On the master camera LCD monitor, the number of slave cameras detected is displayed.

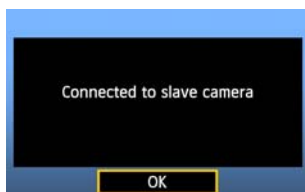

5 Establish the connection.

- On the master camera and all slave cameras, select [**OK**].
- ▶ A screen confirming the connection of the camera is displayed.
- Settings information is stored on the cameras. It is not stored on the transmitters.

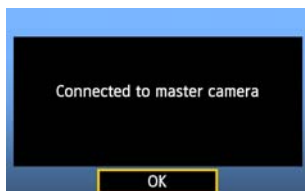

Arranging the Slave Cameras

Slave camera

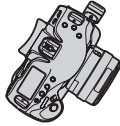

Slave camera

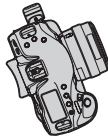
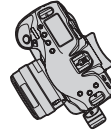

Slave camera

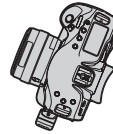

Slave camera

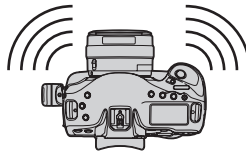

Master camera

- Arrange the slave cameras in clear view of the master camera, without objects between them.
- You can arrange master camera in an overall circumference of up to approximately 100 m / 328 ft. However, the distance supported for linked shooting may be shorter depending on the wireless communication conditions, which are affected by how the cameras are arranged, the environment of use, and weather conditions.
- Pressing the shutter button halfway on the master camera puts slave cameras in the same state, as if the shutter buttons were pressed halfway. Similarly, fully pressing the shutter button on the master camera has the same effect on slave cameras, which respond as if the shutter buttons were fully pressed.
- There will be a slight delay after you release the master camera shutter until the slave camera shutters are released. (Simultaneous capture is not possible.)



- Do not use multiple flash units. Although slight, there is a difference in the shutter release timing which may cause out-of-sync flash firing and inadequate exposure.
- Linked shooting is not possible when master and slave cameras are set to [**Mirror lockup**] [**Enable**] or [**Enable:Mirror down w/ S&T**].



- During linked shooting, when you press the AE lock or depth-of-field preview button, the camera adjusts the focus and meters as if you had pressed the shutter button halfway.
- Once you have established a connection between the master camera and slave cameras, the settings are retained even after you replace the batteries.
- If you will no longer use a slave camera in linked shooting, set [**Communication mode**] to [**Disconnect**] on that slave camera.
- Any cameras compatible with linked shooting, when they have WFT series transmitters attached, can be used as slave cameras, regardless of model.

Using the Transmitter with WFT Server

Using WFT Server, you can shoot remotely with a master camera linked to slave cameras that will shoot at the same time. WFT Server can also be used to access master or slave cameras for Live View display, and you can adjust the focus and configure remote capture settings as needed.

Additionally, images on camera memory cards can be viewed and downloaded.

Linked Shooting

Slave camera

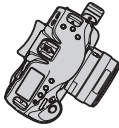

Slave camera

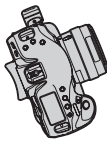
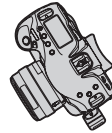

Slave camera

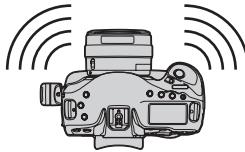

Master camera

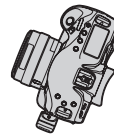

Slave camera

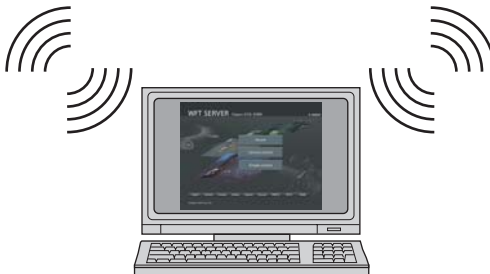

WFT Server

Connect the Master and Slave Cameras

1 Set up the slave cameras.

Set up the slave cameras as described on page 66.



2 Set up the master camera.

- Complete settings on the master camera following steps 1–3 on page 66, and then select **[Master]**.

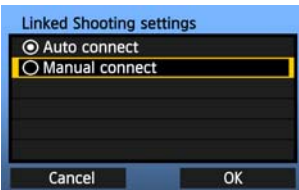

3 Select **[Manual connect]**.

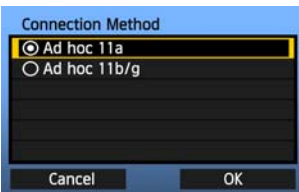

4 Select the connection mode.

- Select the wireless LAN ad hoc mode supported by the computer.

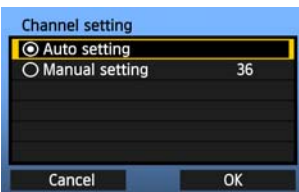

5 Specify the channel.

- When selecting **[Manual setting]**, specify the same channel on the master camera, slave cameras, and computer.

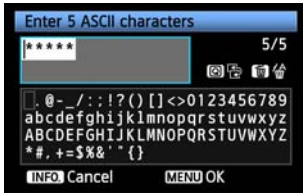

6 Enter the encryption key.

- Enter a 5-digit encryption (WEP) key and press the <MENU> button.
- The key entered here will be saved on the computer and used to access the master camera from the computer.

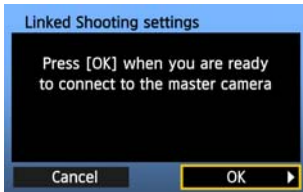

7 Switch to setting up the slave cameras.

- ▶ On the slave cameras, select [OK].



8 Check the number of slave cameras.

- ▶ On the master camera LCD monitor, the number of slave cameras detected is displayed.



9 Establish the connection.

- On the master camera and all slave cameras, select [OK].
- ▶ A screen confirming the connection of the camera is displayed.
- Settings information is stored on the cameras. It is not stored on the transmitters.



Check the Camera Settings

Check the network settings on the master and slave cameras as follows. Note that without a good understanding of these settings, you cannot access the cameras from a computer.

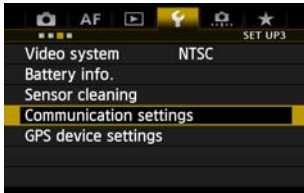

1 On the master camera, select **[Communication settings]**.

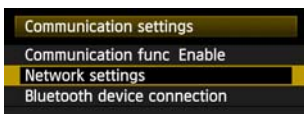

2 Select **[Network settings]**.

- Once you have set **[Communication func]** to **[Enable]**, you can select **[Network settings]**.

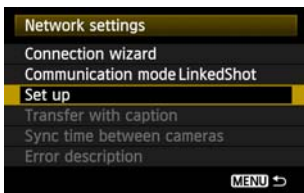

3 Select **[Set up]**.

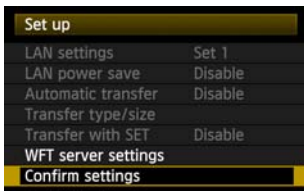

4 Select **[Confirm settings]**.

- The settings are displayed.

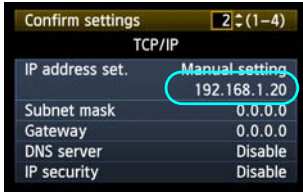

5

Check the settings.

- Turn the <⊙> dial to display other screens.
- Write down the IP address and SSID.



6

Check the slave camera settings.

- Check network settings on the slave cameras just as you checked the master camera settings.
- Write down the IP address of all slave cameras. Each camera has a different address.
- The SSID will match the master camera SSID.

Configure WFT Server Communication Settings

Enter a login name and password for accessing WFT Server on cameras from a computer. Although you can specify different login names and passwords for each camera, it is also possible to use the same information for all cameras.



1 On the master camera, select **[Communication settings]**.

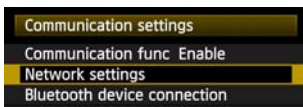

2 Select **[Network settings]**.

- Once you have set **[Communication func]** to **[Enable]**, you can select **[Network settings]**.

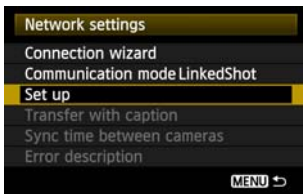

3 Select **[Set up]**.

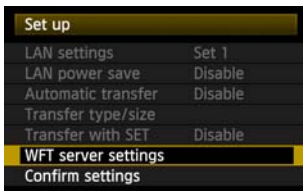

4 Select **[WFT server settings]**.

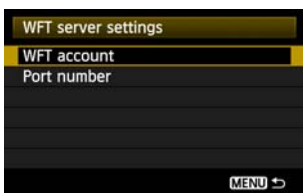

5 Select **[WFT account]**.

- Note that there is normally no need to change **[Port number]**.

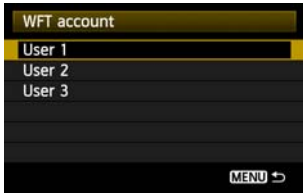

6 Select a user number.

- WFT Server can accept connections from up to three computers per camera. Select a user number to prevent conflicts when users at other computers are connected to the transmitter at the same time.

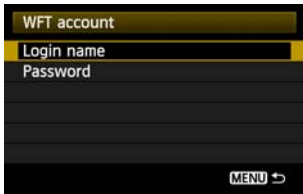

7 Complete the [Login name] and [Password] settings.

- After you select [Login name] and [Password], the following input screen is displayed.
- For instructions on input screen operations, refer to “Virtual Keyboard Operation” (p.25).



IP Addresses Assigned to Computers

IP addresses assigned to cameras end in 1–11, as in 192.168.1.1–192.168.1.11.

For this reason, assign computer IP addresses that end in a number higher than 11, as in 192.168.1.12.

Access the Cameras from the Computer

To access the cameras from the computer, use the computer's standard search function to detect wireless LAN terminals. For details, refer to the computer instruction manual.

1 From the computer, find cameras on the network.

- Use built-in searching on the computer to detect wireless LAN terminals.

2 Connect to a camera.

- Select a device with the same ID as the SSID you wrote down in steps 5 and 6 on page 74.
- After the computer requests an encryption (WEP) key, enter the key set in step 6 on page 72.
- ▶ The computer is now connected to the camera.

Display WFT Server

1 Start a web browser on the computer.

- First, start Internet Explorer or another web browser.



2 Select the camera to connect to.

- Enter the IP address you wrote down in steps 5 and 6 on page 74.
- ▶ The browser now connects to the camera with the IP address you entered.
- To access a different camera, change the IP address in this step.



3 Complete the [Login name] and [Password] settings.

- Enter the [Login name] and [Password] as specified in the procedure on page 76. Click [OK] to display the WFT Server screen.

4 Select the language.

- Select a language on the bottom of the screen.
- Web browsers that support JavaScript now display the screen on the left.

A message is displayed if JavaScript is not supported. Selecting not to use JavaScript will display the screen on the right, with limited functions.

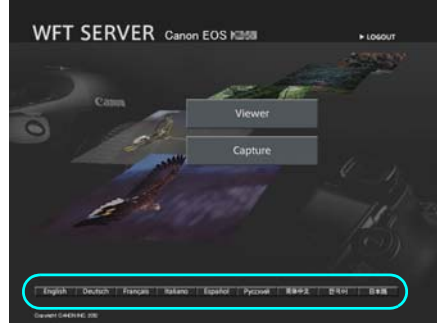
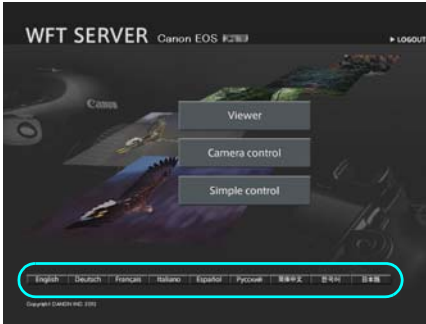

View Images on the Camera

- Refer to “Viewing Images” on page 53.
- Images on camera memory cards can be viewed and downloaded. To switch cameras, enter the IP address of the master or slave camera in the web browser.

Shoot Remotely

- Refer to “Remote Capture [Camera control]” on page 55. Remote capture as described on pages 58 and 59 is also possible.
- To switch cameras, enter the IP address of the master or slave camera in the web browser. You can access slave cameras, adjust the focus and configure shooting functions, and then use the master camera for linked shooting.
- When shooting remotely with linked shooting, access the master camera. If you connect to a slave camera, only that slave camera will shoot, without linked shooting.

7

Managing Settings Information

Checking Settings

Check the network settings as follows.



1 Select [Communication settings].

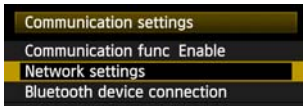

2 Select [Network settings].

- Once you have set [Communication func] to [Enable], you can select [Network settings].

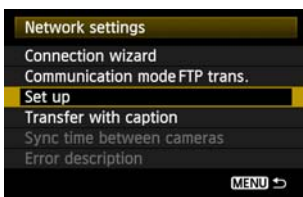

3 Select [Set up].

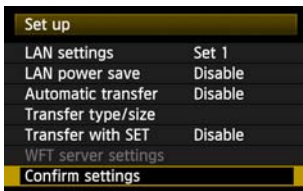

4 Select [Confirm settings].

- ▶ The settings are displayed.

Example of FTP transfer and wired LAN settings

Confirm settings 1 (1-3)	
Basic settings	
Communication mode	FTP trans.
LAN type	Wired
MAC address	11:11:11:11:11:17
Set up	Set 2
Settings name	

Confirm settings 2 (1-3)	
TCP/IP	
IP address set.	Auto assign
	0.0.0.0
Subnet mask	0.0.0.0
Gateway	0.0.0.0
DNS server	Auto assign
IP security	Disable

Confirm settings 3 (1-3)	
FTP trans.	
Address	192.168.1.20
Login name	anonymous

Example of FTP transfer and wireless LAN settings

Confirm settings 1 (1-4)	
Basic settings	
Communication mode	FTP trans.
LAN type	Wireless
MAC address	
Set up	Set 1
Settings name	

Confirm settings 2 (1-4)	
TCP/IP	
IP address set.	Auto assign
	0.0.0.0
Subnet mask	0.0.0.0
Gateway	0.0.0.0
DNS server	Disable
IP security	Disable

Confirm settings 3 (1-4)	
Wireless	
Connect'n method	Infrastructure
SSID	Wft-canon
Channel	
Authentication	Open system
Encryption	None

Confirm settings 4 (1-4)	
FTP trans.	
Address	192.168.1.20
Login name	anonymous

Changing Settings

Settings originally completed using the connection wizard can be changed as follows. You can also change IP security settings (IPsec) that cannot be set using the connection wizard, as well as other settings, such as when an image with the same file name as an existing file is sent to the FTP server. (p.83)



1 Select [Communication settings].

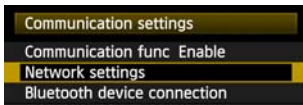

2 Select [Network settings].

- Once you have set [Communication func] to [Enable], you can select [Network settings].

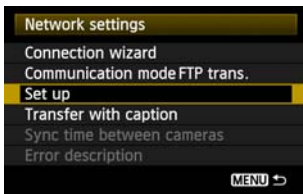

3 Select [Set up].

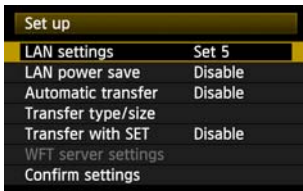

4 Select [LAN settings].

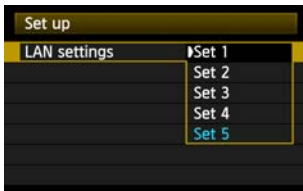

5 Select the settings number.

- Select the settings number that identifies the LAN settings.



6 Select [Change].

- After selecting **[Change settings name]**, you can rename the settings.

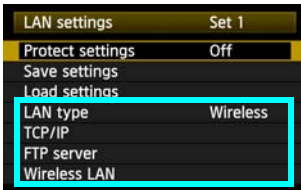

7 Select the item to change.

- Select the desired item from **[LAN type]**, **[TCP/IP]**, **[FTP server]**, or **[Wireless LAN]** and change the setting.

IP Security (IPsec)

Configured in **[TCP/IP]** → **[Security]**.

IPsec is a set of standards for encrypted communication over the Internet. It provides effective security for both wireless and wired LANs. To use this function, you must enable IPsec in the network settings of your computer. When IPsec is employed, only transport mode is supported, and 3DES or AES encryption and SHA1 authentication are used. Note that the IP address of the computer for communication with the transmitter must be entered in **[Destination address]** on the settings screen.

Directory Structure of the Target Folder

Configured in **[FTP server]** → **[Directory structure]**.

Selecting **[Camera]** automatically creates a folder structure matching that of the camera's (such as A/DCIM/100EOS1D) in the server's root folder for image storage. If you have created a subfolder in the root folder by changing the **[Target folder]** setting, a folder structure such as A/DCIM/100EOS1D is automatically created in that folder for image storage.

Selecting **[Default]** will use the root folder for image storage. If you have created a subfolder in the root folder by changing the **[Target folder]** setting, images are saved in that folder.

Overwriting Files of the Same Name

Configured in [FTP server] → [Overwrite same file].

When the transmitter is configured to prevent overwriting

If there is already a file of the same name in the target folder on the FTP server, the new file is saved with an extension consisting of an underscore and a number, as in IMG_0003_1.JPG.

When you resend images if initial transfer fails

Even if the transmitter is configured to overwrite files of the same name, if you resend an image file that could not be transferred initially, the existing file may not be overwritten in some cases. If this happens, the new file is saved with an extension consisting of an underscore, a letter, and a number, as in IMG_0003_a1.JPG.

Passive Mode

Configured in [FTP server] → [Passive mode].

Enable this setting in network environments protected by a firewall. If an Error 41 occurs (“Cannot connect to FTP server”), setting passive mode to [Enable] may enable access to the FTP server.

Preventing Changes to Settings

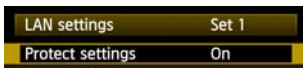

To prevent accidental changes to LAN settings, set [Protect settings] to [On].

Saving and Loading Settings

Network settings can be saved on a memory card for use with other cameras.

Saving Settings



1 Select [Communication settings].

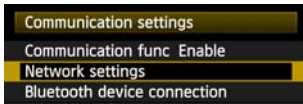

2 Select [Network settings].

- Once you have set [Communication func] to [Enable], you can select [Network settings].

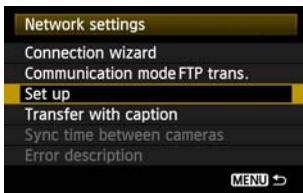

3 Select [Set up].

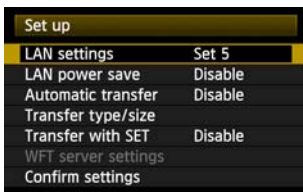

4 Select [LAN settings].

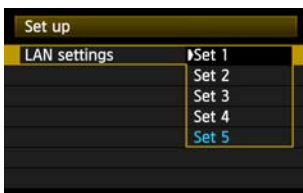

5 Select the settings number.

- Select the settings number that identifies the LAN settings.



6 Select [Change].

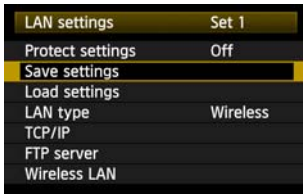

7 Select [Save settings].



8 Select [Save].

- ▶ The settings are now saved as a file on the memory card.
- The settings are saved as a file (WFTNPF**.NIF) in the area of the memory card shown when the card is opened (in the root directory).
- The file name is determined automatically by the camera: WFTNPF, followed by a number (01 to 99) and the extension NIF. You can rename the file as desired by selecting [**Change file name**].

Loading Settings

Load settings files stored on a memory card as follows.

Make sure the settings file is saved in the folder shown when the memory card is opened (that is, the root directory).

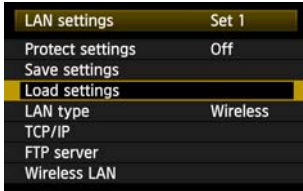

1 Select [Load settings].

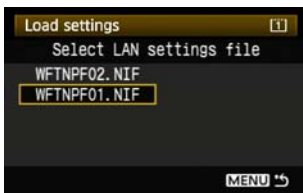

2 Select the settings file.
▶ Select a settings file that matches your network environment.



3 Load the settings file.
▶ Information from the settings file is loaded into the selected settings number.



8

Synchronizing the Camera Time Wirelessly

The time on EOS-1D X cameras can be synchronized over a wired LAN connection. Also you can wirelessly synchronize multiple EOS-1D X cameras when WFT-E6 units are attached.

Set the master camera time on up to 10 slave cameras, as needed. Note that even after synchronization, there will be a slight margin of error between master and slave camera time of ± 0.05 seconds, at most.

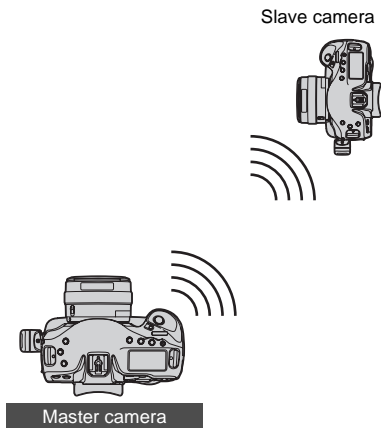

Synchronizing the Time

Steps 1–5 are the same on master and slave cameras.



1 On the [**f3**] tab, select [**Communication settings**].

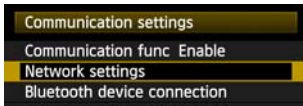

2 Select [**Network settings**].

- Once you have set [**Communication func**] to [**Enable**], you can select [**Network settings**].

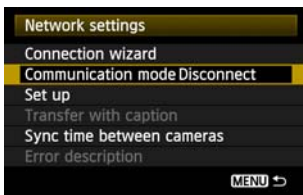

3 Set [**Communication mode**] to [**Disconnect**].

- Once you have set [**Communication mode**] to [**Disconnect**], you can select [**Sync time between cameras**].

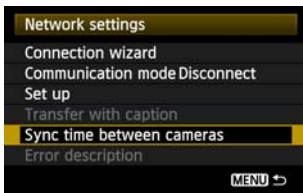

4 Select [**Sync time between cameras**].

- ▶ Select [**OK**] on the next screen displayed, shown below.

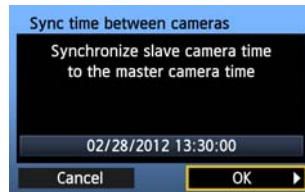

5 Select [**Wireless**].

- After selecting [**Wireless**], select [**OK**].



6 Set up the master camera.

- After configuring the master camera settings following steps 1–5 on the preceding page, select **[Master]**.
- ▶ When the next screen is displayed, the master camera is ready. Go to step 7 to set up the slave cameras.



7 Set up the slave cameras.

- After configuring the slave camera settings following steps 1–5 on the preceding page, select **[Slave]**.
- ▶ Select **[OK]** on the next screen displayed, shown below.

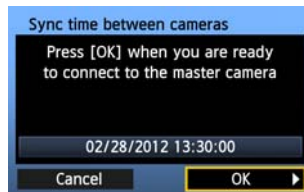

- To set the time on multiple slave cameras, follow these steps on each slave camera. The master camera screen shown in step 8 indicates the number of slave cameras.

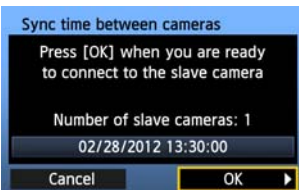

8 On the master camera, select **[OK]**.

- Check the number of slave cameras, and then select **[OK]**.
- ▶ The time on slave cameras is now synchronized to the master camera time.

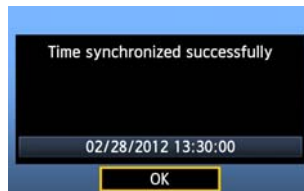

- Select **[OK]** to return to the **[Network settings]** screen.



9

Using Bluetooth GPS Devices

Information including the latitude, longitude, elevation, and date and time can be obtained from commercially-available GPS devices connected via Bluetooth and added to images. The additional information can be checked on the camera as well as by using commercially-available GPS-compatible mapping software.

For a list of specific GPS devices supported, contact the Canon Service Center.

For GPS device instructions, refer to the device's instruction manual or contact the manufacturer.

Connecting GPS Devices via Bluetooth



1 On the [**43**] tab, select [**Communication settings**].

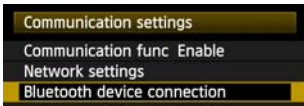

2 Select [**Bluetooth device connection**].

- Once you have set [**Communication func**] to [**Enable**], you can select [**Bluetooth device connection**].
- ▶ Press <SET> when the next screen shown below is displayed.

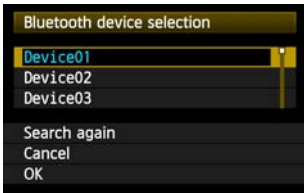
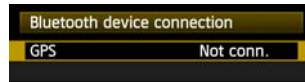

3 Select the **GPS device**.

- Nearby Bluetooth® devices in use are listed.
- Turn the <DIAL> dial to select the GPS device, and then press <SET>.
- Select [**OK**] and press <SET>.
- If a Bluetooth® password has been set on the GPS device, a password input screen is displayed. Enter the password.
- ▶ The transmitter now starts to establish a connection with the GPS device.
- It may take a few minutes to establish a connection with the GPS device.

Camera operations such as shooting, menu display, or image playback are not possible until the connection is established.



4 When the confirmation message is displayed, select [OK].

- The GPS connection status changes to **[Connected]**. Pressing $\langle \text{SET} \rangle$ under these conditions will enable you to disconnect the GPS device.

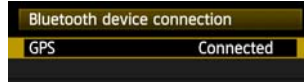

- While the Bluetooth connection is active, $\langle \text{GPS} \rangle$ and the $\langle \text{GPS} \rangle$ are shown on the EOS-1D X rear LCD panel.

5 Confirm operation of the GPS device.

- Make sure the GPS device has determined the current location.

6 Take the picture.

- After confirming that $\langle \text{GPS} \rangle$ is shown on the EOS-1D X rear LCD panel, shoot when ready.
- **If the $\langle \text{GPS} \rangle$ icon is blinking when you shoot, accurate GPS data will not be added to images.**



From top to bottom: latitude, longitude, altitude, and Coordinated Universal Time

7 Check the GPS data.

- Playback the image in single image display.
- Press the $\langle \text{INFO.} \rangle$ button to display the shooting information screen with GPS data.

! When the camera's power is turned off and on or when it wakes up from auto power off, do not shoot until the $\langle \text{GPS} \rangle$ lamp remains lit. If you shoot while the lamp is blinking, the correct GPS information may not be added to images.

i The date and time indicated is the Coordinated Universal Time (UTC) as obtained by the GPS device, which is nearly the same as Greenwich Mean Time (GMT). In some cases, the date and time of the zone specified on the GPS device is indicated.

Canceling the Bluetooth Connection

The Bluetooth connection with the GPS device will not be terminated if you simply turn off the camera. To cancel the connection, follow these steps.



1 On the [**43**] tab, select [**Communication settings**].

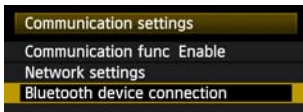

2 Select [**Bluetooth device connection**].

- Once you have set [**Communication func**] to [**Enable**], you can select [**Bluetooth device connection**].
- ▶ Press <SET> when the next screen shown below is displayed.

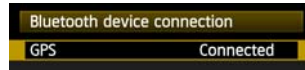

3 Select [**OK**].

- ▶ The Bluetooth connection is canceled.



- Select [**OK**] to return to the [**Bluetooth device connection**] screen.

10

Troubleshooting



Transfer speed in ad hoc mode may become extremely slow when the transmitter is used with certain types of computer. For more information, contact your dealer or nearest Canon Service Center.

Responding to Error Messages

If transmitter errors are displayed on the camera LCD monitor, refer to the examples of corrective actions in this section to eliminate the cause of the error. In case of errors, the <LAN> lamp on the camera starts blinking. The error details can also be checked on the [🔑3] tab [Communication settings] → [Network settings] → [Error description].

Click the error number in the following chart to jump to the corresponding page.

11 (p.99)	12 (p.99)			
21 (p.99)	22 (p.100)	23 (p.100)	24 (p.101)	25 (p.102)
26 (p.102)				
41 (p.103)	42 (p.104)	43 (p.104)	44 (p.104)	45 (p.105)
46 (p.105)	47 (p.106)			
51 (p.106)	52 (p.106)	53 (p.106)	54 (p.106)	
61 (p.107)	62 (p.107)	63 (p.108)	64 (p.108)	65 (p.108)
66 (p.109)	67 (p.109)	68 (p.109)	69 (p.109)	
71 (p.110)	72 (p.110)	73 (p.110)		
82 (p.110)				
91 (p.110)				

If [Waiting to retry transfer...] is displayed



If image transfer via FTP fails after shooting, the screen on the left is displayed, and the camera's <LAN> lamp blinks in red. Check the error number and eliminate the cause of the error.

Once the cause of the error is eliminated, the images whose transfer previously failed will be transferred automatically.

Note that if you cancel image transfer or turn off the camera, auto retry is not performed. Follow the steps on page 36 to transfer the images.

11: Connection target not found

- **Is the pairing software running?**
 - ▶ Start the pairing software and follow the instructions to re-establish the connection (p.44).
- **Are the transmitter and wireless LAN terminal configured with the same encryption key for authentication?**
 - ▶ This error occurs if the encryption keys do not match when the authentication method for encryption is **[Open system]**.
The setting is case-sensitive, so check upper- and lower-case characters. Make sure the correct encryption key for authentication is entered on the transmitter (p.20).

12: Connection target not found

- **Are the target computer and wireless LAN terminal on?**
 - ▶ Turn on the target computer and wireless LAN terminal.

21: No address assigned by DHCP server

What to check on the transmitter

- **On the transmitter, the network setting is [Auto setting] or the IP address setting is [Auto assign]. Does the error occur under these settings?**
 - ▶ If no DHCP server is used, set the transmitter's network setting to **[Manual setting]** and IP address setting to **[Manual setting]** (p.23).

What to check on the DHCP server

- **Is the DHCP server on?**
 - ▶ Turn the DHCP server on.
- **Are there enough addresses for assignment by the DHCP server?**
 - ▶ Increase the number of addresses assigned by the DHCP server.
 - ▶ Remove devices assigned addresses by the DHCP server from the network to reduce the number of addresses in use.
- **Is the DHCP server working correctly?**
 - ▶ Check the DHCP server settings to make sure it is working correctly as a DHCP server.
 - ▶ If applicable, ask your network administrator to ensure the DHCP server is available.



Responding to Error Messages 21 - 26

Also check the following points when responding to errors numbered 21 - 26.

Are the transmitter and wireless LAN terminal configured with the same encryption key for authentication?

- ▶ This error occurs if the encryption keys do not match when the authentication method for encryption is **[Open system]**. The setting is case-sensitive, so check upper- and lower-case characters. Make sure the correct encryption key for authentication is entered on the transmitter (p.20).

22: No response from DNS server

What to check on the transmitter

- On the transmitter, the DNS address setting is [Auto assign] or [Manual setting].
Does the error occur under these settings?
- ▶ If no DNS server is used, set the transmitter's DNS address setting to [Disable] (p.23).
- On the transmitter, does the DNS server's IP address setting match the server's actual address?
- ▶ Configure the IP address on the transmitter to match the actual DNS server address (p.23, 112).

What to check on the DNS server

- Is the DNS server on?
- ▶ Turn the DNS server on.
- Are the DNS server settings for IP addresses and the corresponding names correct?
- ▶ On the DNS server, make sure IP addresses and the corresponding names are entered correctly.
- Is the DNS server working correctly?
- ▶ Check the DNS server settings to make sure the server is working correctly as a DNS server.
- ▶ If applicable, ask your network administrator to ensure the DNS server is available.

What to check on the network as a whole

- Does your network include a router or similar device that serves as a gateway?
- ▶ If applicable, ask your network administrator for the network gateway address and enter it on the transmitter (p.23, 112).
- ▶ Make sure the gateway address setting is correctly entered on all network devices, including the transmitter.

23: Duplicate IP address

What to check on the transmitter

- Is another device on the transmitter network using the same IP address as the transmitter?
- ▶ Change the transmitter's IP address to avoid using the same address as another device on the network. Otherwise, change the IP address of the device that has a duplicate address.
- ▶ In network environments with a DHCP server, if the transmitter's IP address setting is [Manual setting], change it to [Auto assign] (p.23).

24: No response from proxy server

What to check on the transmitter

- **The transmitter's proxy server setting is [Enable]. Does the error occur under this setting?**
 - ▶ If no proxy server is used, set the transmitter's proxy server setting to [**Disable**] (p.28).
- **Do the transmitter's [Address setting] and [Port No.] settings match those of the proxy server?**
 - ▶ Configure the transmitter's proxy server address and port number to match those of the proxy server (p.28).
- **In the transmitter's [Proxy server] settings, have you only entered [Server name]?**
 - ▶ If the proxy server's [**Address**] setting is not configured on the transmitter, enter it along with the DNS server address (p.23). Make sure the server name and port number for the proxy server are entered correctly (p.28).

What to check on the proxy server

- **Is the proxy server on?**
 - ▶ Turn the proxy server on.
- **Is the proxy server working correctly?**
 - ▶ Check the proxy server settings to make sure the server is working correctly as a proxy server.
 - ▶ If applicable, ask your network administrator for the proxy server address or server name and port number, and then enter them on the transmitter.

What to check on the network as a whole

- **Does your network include a router or similar device that serves as a gateway?**
 - ▶ If applicable, ask your network administrator for the network gateway address and enter it on the transmitter.
 - ▶ Make sure the gateway address setting is correctly entered on all network devices, including the transmitter.

25: Another terminal has set the same IP address

- **Is another device on the transmitter network using the same IP address as the transmitter?**
- ▶ This error occurs if the transmitter is connected to a network where another device subsequently connects with the same IP address. Change the transmitter's IP address to avoid using the same address as another device on the network. Otherwise, change the IP address of the device that has a duplicate address.

26: No response from DHCP server

What to check on the transmitter

- **On the transmitter, the network setting is [Auto setting]. Does the error occur under this setting?**
- ▶ If no DHCP server is used, set the transmitter's network setting to [Manual setting] (p.23).

What to check on the DHCP server

- **Is the DHCP server on?**
- ▶ Turn the DHCP server on.
- **Are the DHCP server settings for IP addresses and the corresponding names correct?**
- ▶ On the DHCP server, make sure IP addresses and the corresponding names are entered correctly.
- **Is the DHCP server working correctly?**
- ▶ Check the DHCP server settings to make sure it is working correctly as a DHCP server.
- ▶ If applicable, ask your network administrator to ensure the DHCP server is available.

What to check on the network as a whole

- **Does your network include a router or similar device that serves as a gateway?**
- ▶ If applicable, ask your network administrator for the network gateway address and enter it on the transmitter (p.23).
- ▶ Make sure the gateway address setting is correctly entered on all network devices, including the transmitter.

41: Cannot connect to FTP server

What to check on the transmitter

- **On the transmitter, does the FTP server's IP address setting match the server's actual address?**
 - ▶ Configure the IP address on the transmitter to match the actual FTP server address (p.28).
- **Are the transmitter and wireless LAN terminal configured with the same encryption key for authentication?**
 - ▶ This error occurs if the encryption keys do not match when the authentication method for encryption is **[Open system]**.
The setting is case-sensitive, so check upper- and lower-case characters. Make sure the correct encryption key for authentication is entered on the transmitter (p.20).
- **On the transmitter, does the [Port number setting] for the FTP server match the actual port number of the FTP server?**
 - ▶ Configure the same port number (usually 21) on the transmitter and FTP server. Configure the port number on the transmitter to match the actual FTP server port number (p.28).
- **If only the FTP server's [Server name] is configured on the transmitter, are the DNS server settings complete?**
 - ▶ If the FTP server's [Address] setting is not configured on the transmitter, enable use of the DNS server on the transmitter and enter its address (p.23). Make sure the FTP server name is entered correctly (p.28).

What to check on the FTP server

- **Is the FTP server working correctly?**
 - ▶ Configure the computer correctly to function as an FTP server.
 - ▶ If applicable, ask your network administrator for the FTP server address and port number, and then enter them on the transmitter.
- **Is the FTP server on?**
 - ▶ Turn the FTP server on. The server may have been turned off because of an energy-saving mode.
- **On the transmitter, does the FTP server's IP address setting (in [Address]) match the server's actual address?**
 - ▶ Configure the IP address on the transmitter to match the actual FTP server address (p.28).
- **Is a firewall or other security software enabled?**
 - ▶ Some security software uses a firewall to restrict access to the FTP server. Change the firewall settings to allow access to the FTP server.
 - ▶ You may be able to access the FTP server by setting **[Passive mode]** to **[Enable]** on the transmitter (p.84).

- **Are you connecting to the FTP server via a broadband router?**
 - ▶ Some broadband routers use a firewall to restrict access to the FTP server. Change the firewall settings to allow access to the FTP server.
 - ▶ You may be able to access the FTP server by setting **[Passive mode]** to **[Enable]** on the transmitter (p.84).
- **If you are using Windows XP Service Pack 2 or later, is access to the FTP server blocked by [Windows Firewall]?**
 - ▶ Change the Windows Firewall settings to allow access to the FTP server.

What to check on the network as a whole

- **Does your network include a router or similar device that serves as a gateway?**
 - ▶ If applicable, ask your network administrator for the network gateway address and enter it on the transmitter (p.23).
 - ▶ Make sure the gateway address setting is correctly entered on all network devices, including the transmitter.

42: FTP server rejected connection

What to check on the FTP server

- **Is the FTP server configured to restrict access to only some IP addresses?**
 - ▶ Change the FTP server settings to allow access from the **[IP address]** configured on the transmitter in the TCP/IP settings.

43: Cannot connect to FTP server. Error code received from server.

What to check on the FTP server

- **Have you exceeded the maximum number of FTP server connections?**
 - ▶ Disconnect some network devices from the FTP server or increase the maximum number of connections.

44: Cannot disconnect FTP server. Error code received from server.

- **This error occurs if the transmitter fails to disconnect from the FTP server for some reason.**
 - ▶ Turn off and on the FTP server and camera.

45: Cannot login to FTP server. Error code received from server.**What to check on the transmitter**

- **On the transmitter, is the [Login name] entered correctly?**
 - ▶ Check the logon name for accessing the FTP server. The setting is case-sensitive, so check upper- and lower-case characters. Make sure the correct logon name is entered on the transmitter (p.29).
- **On the transmitter, is the [Login password] entered correctly?**
 - ▶ If a logon password is configured on the FTP server, check the upper- and lower-case characters to make sure the password on the transmitter matches it (p.29).

What to check on the FTP server

- **Do the user rights for the FTP server allow reading, writing, and log access?**
 - ▶ Configure the FTP server's user rights to allow reading, writing, and log access.
- **Is the folder specified as the transfer destination on the FTP server named with ASCII characters (p.25)?**
 - ▶ Use ASCII characters for the folder name.

46: For the data session, error code received from FTP server**What to check on the FTP server**

- **The connection was terminated by the FTP server.**
 - ▶ Restart the FTP server.
- **Do the user rights for the FTP server allow reading, writing, and log access?**
 - ▶ Configure the FTP server's user rights to allow reading, writing, and log access.
- **Do user rights allow access to the target folder on the FTP server?**
 - ▶ Configure the user rights for access to the target folder on the FTP server to allow saving images from the transmitter.
- **Is the FTP server on?**
 - ▶ Turn the FTP server on. The server may have been turned off because of an energy-saving mode.
- **Is the hard disk of the FTP server full?**
 - ▶ Increase available space on the hard disk.

47: Image file transfer completion not confirmed by FTP server

- **This error occurs if, for some reason, the transmitter fails to receive confirmation from the FTP server that image file transfer is complete.**
- ▶ Turn off and on the FTP server and camera and transfer the images again.

51: Connection to Bluetooth device lost

- **Is the transmitter too far from the GPS device?**
- ▶ Bring the GPS device closer to the transmitter.
- **Are any obstacles blocking the line of sight between the transmitter and the GPS device?**
- ▶ Move the GPS device to a position visible from the point of view of the transmitter.
- **The transmitter and GPS device were disconnected, for some reason, and the connection cannot be restored.**
- ▶ The connection is more likely to be lost if there are nearby wireless LAN terminals, cordless telephones, microphones, microwave ovens, or similar devices operating on the same 2.4 GHz band used for Bluetooth communication. Also note that the connection is more likely to be lost in poor weather or high humidity.
- **Is the GPS device on?**
- ▶ Turn the GPS device on.

52: Bluetooth device cannot be found

- **Is the GPS device ready for the Bluetooth connection?**
- ▶ Turn the GPS device on and set it up for connection via Bluetooth.
- **Is the transmitter too far from the GPS device?**
- ▶ Bring the GPS device closer to the transmitter.
- **Is the GPS device on?**
- ▶ Turn the GPS device on.

53: Incorrect Bluetooth password

- **Is the same password set on the transmitter and GPS device?**
- ▶ The setting is case-sensitive, so check upper- and lower-case characters. Make sure the correct password is entered on the GPS device and transmitter.

54: No compatible Bluetooth service available on connected device

- **The GPS device does not support SPP (Serial Port Profile).**
- ▶ Confirm that the GPS device supports SPP.

61: Selected SSID wireless LAN network not found

- **Are any obstacles blocking the line of sight between the transmitter and the antenna of the wireless LAN terminal?**
- ▶ Move the antenna to a position clearly visible from the point of view of the transmitter (p.111).

What to check on the transmitter

- **On the transmitter, does the SSID setting match that of the wireless LAN terminal?**
- ▶ Check the SSID on the wireless LAN terminal, and configure the same SSID on the transmitter (p.19).

What to check on the wireless LAN terminal

- **Is the wireless LAN terminal on?**
- ▶ Turn on the wireless LAN terminal.
- **If you are filtering by MAC address, did you register the transmitter's MAC address on the wireless LAN terminal?**
- ▶ Register the transmitter's MAC address (p.80) on the wireless LAN terminal.

62: No response from wireless LAN terminal

What to check on the transmitter

- **Is the transmitter configured for communication in infrastructure mode?**
- ▶ Configure the transmitter for communication in ad hoc mode.

What to check on the wireless LAN terminal

- **Is there a nearby wireless LAN terminal for ad hoc communication?**
- ▶ Set up a wireless LAN terminal for ad hoc communication near the transmitter.

63: Wireless LAN authentication failed

- **Are the transmitter and wireless LAN terminal configured for the same authentication method?**
 - ▶ The transmitter supports these authentication methods: [Open system], [Shared key], [WPA-PSK], and [WPA2-PSK] (p.19).
 - ▶ When using an AirPort for communication in infrastructure mode, [Open system] is not supported. Configure a [Shared key] on the transmitter (p.19).
- **Are the transmitter and wireless LAN terminal configured with the same encryption key for authentication?**
 - ▶ The setting is case-sensitive, so check upper- and lower-case characters. Make sure the correct encryption key for authentication is entered on the transmitter and wireless LAN terminal (p.20).
- **If you are filtering by MAC address, did you register the transmitter's MAC address on the wireless LAN terminal?**
 - ▶ Register the transmitter's MAC address (p.80) on the wireless LAN terminal.

64: Cannot connect to wireless LAN terminal

- **Are the transmitter and wireless LAN terminal configured for the same encryption method?**
 - ▶ The transmitter supports these encryption methods: [WEP], [TKIP], and [AES] (p.19).
- **If you are filtering by MAC address, did you register the transmitter's MAC address on the wireless LAN terminal?**
 - ▶ Register the transmitter's MAC address (p.80) on the wireless LAN terminal.

65: Wireless LAN connection lost

- **Are any obstacles blocking the line of sight between the transmitter and the antenna of the wireless LAN terminal?**
 - ▶ Move the antenna to a position clearly visible from the point of view of the transmitter (p.111).
- **The wireless LAN connection was lost, for some reason, and the connection cannot be restored.**
 - ▶ The following are possible reasons: excessive access to the wireless LAN terminal from other terminals, a microwave oven or similar appliance in use nearby (interfering with IEEE 802.11b/g/n reception on the 2.4 GHz band), or poor weather or high humidity (p.111).

66: Incorrect wireless LAN encryption key

- **Are the transmitter and wireless LAN terminal configured with the same encryption key for authentication?**
 - ▶ The setting is case-sensitive, so check upper- and lower-case characters. Make sure the correct encryption key for authentication is entered on the transmitter and wireless LAN terminal (p.20).
Note that if the authentication method is **[Open system]**, an Error 41 (“Cannot connect to FTP server”) is displayed.

67: Incorrect wireless LAN encryption method

- **Are the transmitter and wireless LAN terminal configured for the same encryption method?**
 - ▶ The transmitter supports these encryption methods: **[WEP]**, **[TKIP]**, and **[AES]** (p.19).
- **If you are filtering by MAC address, did you register the transmitter’s MAC address on the wireless LAN terminal?**
 - ▶ Register the transmitter’s MAC address (p.80) on the wireless LAN terminal.

68: Cannot connect to wireless LAN terminal. Retry from the beginning.

- **Have you pressed the Wi-Fi Protected Setup (WPS) button on the wireless LAN terminal for as long as indicated in the wireless LAN terminal instructions?**
 - ▶ Refer to the instruction manual for the wireless LAN terminal to determine how long to hold the WPS button.
- **Are you attempting to establish the connection near the wireless LAN terminal?**
 - ▶ Try establishing the connection when both devices are within reach of each other.

69: Multiple wireless LAN terminals have been found. Cannot connect. Retry from the beginning.

- **Connection is in progress by other wireless LAN terminals in Pushbutton Connection mode (PBC mode) of Wi-Fi Protected Setup (WPS).**
 - ▶ Wait a while before trying to establish the connection, or try to establish a connection in PIN code connection mode (PIN mode) (p.22).

71: Cannot connect to slave camera

- **Are you following the correct procedure to establish the connection with slave cameras?**
 - ▶ Operate slave cameras by following the correct instructions (p.66, 67).
- **Are the slave cameras too far from the master camera?**
 - ▶ Bring the slave cameras closer to the master camera.

72: Cannot connect to master camera

- **Are you following the correct procedure to establish the connection with master camera?**
 - ▶ Operate the master camera by following the correct instructions (p.66, 67).
- **Is the master camera too far from the slave cameras?**
 - ▶ Bring the master camera closer to the slave cameras.

73: Could not synchronize the time

- **Are you following the correct procedure to establish a connection between the master and slave cameras?**
 - ▶ Operate the master and slave cameras by following the correct instructions (p.90, 91).
- **Are the master and slave cameras too far apart?**
 - ▶ Bring the master and slave cameras closer together.

82: Wireless File Transmitter not connected

- **Is the transmitter attached correctly?**
 - ▶ Make sure the transmitter is securely inserted in the camera (p.10).

91: Other error

- **Another problem has occurred, identified with an error number other than 11 to 82.**
 - ▶ Turn the camera's power switch off and on.

Wireless LAN Notes

When using the transmitter with a wireless LAN, try the following corrective actions if the transmission rate drops, the connection is lost, or other problems occur.

Wireless LAN Terminal Installation and Antenna Position

- When using the transmitter indoors, install the wireless LAN terminal in the same room where you are shooting.
- Install the wireless LAN terminal higher than the transmitter.
- Install the device where people or objects do not come between it and the camera.
- Install the device as close as possible to the camera. In particular, note that during outdoor use in poor weather, rain may absorb radio waves and disrupt the connection.

Nearby Electronic Devices

If the transmission rate over a wireless LAN drops because of interference from the following electronic devices, switching to a wired LAN can resolve the problem.

- The transmitter communicates over wireless LANs via IEEE 802.11b/g/n and Bluetooth using radio waves in the 2.4 GHz band. For this reason, the wireless LAN transmission rate may drop if there are nearby microwave ovens, cordless telephones, microphones, or similar devices operating on the same frequency band.
- If a wireless LAN terminal on the same frequency band as the transmitter is used nearby, the transmission rate of the wireless LAN may drop.

Using Multiple Transmitters

- If multiple transmitters are connected to a single wireless LAN terminal, be careful not to use duplicate camera IP addresses.
- Note that the transmission rate drops when multiple transmitters access a single wireless LAN terminal.
- To reduce radio wave interference when there are multiple wireless IEEE 802.11b/g/n devices on the 2.4 GHz band, leave a gap of four channels between each wireless LAN channel. For example, use channels 1, 6, and 11, channels 2, 7, and 12, or channels 3, 8, and 13.
When IEEE 802.11a/n can be used (on the 5 GHz band), switch to IEEE 802.11a/n (on the 5 GHz band) and specify a different channel.

Security

- Wireless LAN radio waves can be easily intercepted. For this reason, we recommend activating encrypted communication in the wireless LAN terminal settings.

Checking Network Settings

Windows

Click the Windows **[Start]** button → **[All Programs]** → **[Accessories]** → **[Command Prompt]**. Type **ipconfig/all** and press the **<Enter>** key.

The IP address assigned to the computer is displayed, as well as the subnet mask, gateway, and DNS server information.

To avoid using the same IP address for the computer and other devices on the network when configuring the IP address assigned to the camera (page 23), change the rightmost numbers here.

Macintosh

In Mac OS X, open the **[Terminal]** application, type **ifconfig -a**, and press the **<Return>** key.

The IP address assigned to the computer is indicated in the **[en0]** item by **[inet]**, in the format *****.***.***.*****.

To avoid using the same IP address for the computer and other devices on the network when configuring the IP address assigned to the camera (page 23), change the rightmost numbers here.

* For information on the **[Terminal]** application, refer to the Mac OS X help.

11

Reference

Creating and Registering Captions

Follow these steps to create captions and register them on the camera, as introduced in “Adding a Caption Before Transfer” (p.34). When creating and registering captions, use a computer on which EOS Utility is installed.

Before you start, attach the transmitter to the camera and use the USB cable provided with the camera to connect the camera to the computer. For instructions on connecting the camera to the computer with the USB cable and starting EOS Utility, refer to the Software Instruction Manual (PDF) provided with the camera.

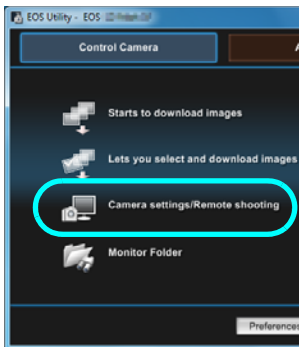

1 Start EOS Utility and select [Camera settings/Remote shooting].

- ▶ The camera settings/remote capture screen is displayed.



2 On the [Tf] tab, select [WFT Captions].

- ▶ The screen for caption creation is displayed.
- To acquire caption data stored on the camera, select [Load settings].



3 Enter the caption or captions.

- Enter up to 31 characters (in ASCII format).

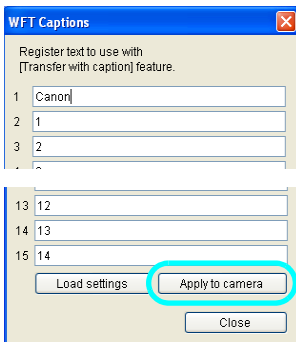

4 Register the captions on the camera.

- Select [Apply to camera] to register your new captions on the camera.

Specifications

■ Type

Type: IEEE 802.11a/b/g/n wireless image transfer accessory (IPsec-compatible) with Bluetooth connectivity for GPS devices

■ Wireless LAN

Standards compliance: IEEE 802.11a
IEEE 802.11b
IEEE 802.11g
IEEE 802.11n

Transmission method: DS-SS modulation (IEEE 802.11b)
OFDM modulation (IEEE 802.11a/g/n)

Transmission range: Approx. 150 m / 492 ft.
* With no obstructions between the transmitting and receiving antennas and no radio interference
* With a large, high-performance antenna attached to the wireless LAN access point

Transmission frequency (central frequency):

Version	Frequency	Channels
WFT-E6A	2412–2462 MHz	1–11
	5180–5320 MHz	36–64
	5745–5825 MHz	149–165
WFT-E6B	2412–2472 MHz	1–13
	5180–5320 MHz	36–64
	5500–5700 MHz	100–140
WFT-E6C	2412–2472 MHz	1–13
	5745–5805 MHz	149–161
WFT-E6D	2412–2462 MHz	1–11
	5280–5320 MHz	56–64
	5500–5700 MHz	100–140
WFT-E6E	2412–2472 MHz	1–13
	5180–5320 MHz	36–64
	5500–5700 MHz	100–140
	5745–5825 MHz	149–165

Connection method: Infrastructure or ad hoc mode

* Wi-Fi Protected Setup supported

Security: Authentication method: Open, shared key, WPA-PSK, and WPA2-PSK
Encryption: WEP, TKIP, and AES

■ Network Functions

- FTP transfer: Automatic transfer
Image selection and transfer
Transfer using SET button
Transfer with captions
- EOS Utility: EOS Utility remote control functions over wireless LAN
- WFT Server: Camera control, simple control, basic shooting,
image viewing, and downloading
- Media Server: DLNA compatible
- Linked shooting: Shooting with up to 10 slave cameras linked to a master camera
Transmission range: Approx. 100 m / 328 ft.
- Wireless time syncing: Syncing up to 10 slave cameras to the master camera time
Margin of error with master camera: Approx. ±0.05 seconds

■ Bluetooth connection

- Standards compliance: Bluetooth 2.0+EDR
- Supported devices: Wireless connectivity with Bluetooth GPS devices

■ Number of Possible Shots

Approx. number of shots

Connection	Normal Temperature (23°C / 73°F)	Low Temperature (0°C / 32°F)
Wireless LAN	950	750

- * Using a fully charged LP-E4N Battery Pack.
- * Based on Camera & Imaging Products Association (CIPA) standards.
- * Fewer images can be captured when transferring images consecutively over wireless LAN.

■ Dimensions and Weight

- Dimensions (W x H x D): 24.7 x 57.0 x 34.1 mm / 0.97 x 2.24 x 1.34 in.
- Weight: Approx. 38 g / 1.34 oz. (body only)

■ Operating Environment

- Temperature: 0°C–45°C / 32°F–113°F
- Humidity: 85% or less

- All preceding specifications are based on Canon testing standards.
- Transmitter specifications and appearance are subject to change without notice.

Index

A

Account	50
Ad hoc	19
Area of use Areas of Use and Restrictions	
Authentication.....	19, 83
Auto power off	15

B

Batch transfer	36, 38, 40
Bluetooth	93
Browser	52

C

Camera control	55
Caption	34
Channel..... Areas of Use and Restrictions	
Connection	15
Coordinated Universal Time.....	95

D

DHCP server	23
Digital photo frame	61
DLNA.....	61
DNS address	23
DNS server.....	28

E

Encryption	19, 83
Encryption key.....	20
EOS Utility.....	11, 43, 47
EOSUtility	16
Error	98
ESS-ID	19

F

File of same name.....	84
Folder	29, 42
FTP server.....	11, 27
FTP trans.....	16

G

Gateway	23
GPS.....	93

I

IEEE 802.11a/b/g/n	Areas of Use and Restrictions
Image transfer	11, 27

Infrastructure.....	19
IP address.....	23, 28
IPsec.....	83

J

JPEG.....	31
-----------	----

K

Key format.....	20
Keyboard.....	25

L

LCD panel.....	9
Linked shooting.....	11, 65
LinkedShot.....	17
Login	29
Logon name.....	50

M

MAC address	44
Master camera.....	67, 91
Media player	61
Media Server.....	11, 61
MediaServ.....	17
Movie	30, 54, 55

N

Network.....	13
--------------	----

O

Open system.....	19
------------------	----

P

Pairing.....	24, 44
Passive mode	84
Password	50, 94
PBC mode.....	21
PIN code connection mode.....	22
PIN mode	22
Port number	28
Protect settings	84
Proxy.....	28
Pushbutton connection mode	21

R

RAW.....	31
RAW+JPEG	32
Remote capture	11, 43, 49, 55, 58, 59

Router..... 23

S

Select folder 29
 Settings information..... 79
 Shared key 19
 Simple control..... 58
 Slave camera 66, 91
 SSID 19
 Stealth functions..... 21, 22
 Storage..... 42
 Subnet mask 23
 Sync camera time..... 89

T

Target 29
 Target folder 83
 Television 61, 63
 TKIP 19
 Transfer after shooting 36
 Transfer history 41
 Transfer with SET..... 33
 Transferred images 42
 Transferring images, automatic..... 30
 Transferring images, individual images..... 33
 Troubleshooting..... 97

U

URL 52
 UTC 95

V

Viewing images 53

W

Web 52
 WEP 19
 WFT Server 11, 49
 WFTserver..... 17
 Wi-Fi Protected Setup 21
 Wired LAN 18
 Wireless LAN specification
 Areas of Use and Restrictions
 Wizard 15
 WPA2-PSK..... 19
 WPA-PSK..... 19
 WPS (Wi-Fi Protected Setup)..... 21, 22



CANON INC.

30-2, Shimomaruko 3-chome, Ohta-ku, Tokyo 146-8501, Japan

CANON EUROPA N.V.

Bovenkerkerweg 59, 1185 XB Amstelveen, The Netherlands

This instruction manual is current as of February 2012. For information on using the transmitter with accessories introduced after this date, contact your nearest Canon Service Center.