

Canon

Exif Print

**BUBBLE JET
DIRECT**

PictBridge

**WiFi[®]
CERTIFIED**

Photo Printer

PIXMA iP4000R Series

Quick Start Guide



Getting Help from Canon

Help Us Help You Better

Before you contact Canon, please record the following information.

Serial Number (located on the inside of the printer): _____

Model Number (located on the front of the printer): _____

Setup Software & User's Guide CD version number
(USCD X.X) located on your CD-ROM: _____

Purchase Date: _____

Canon U.S.A. Customer Technical Support Sequence*

1. Internet — www.canontechsupport.com

For quick and comprehensive self-help in an intuitively guided interactive troubleshooting environment, the place to start is our helpful tech support web site. In addition, the latest driver downloads, answers to frequently asked questions, product information, and “where to buy” instructions are found here.

2. Email Tech Support — www.canontechsupport.com

For individual attention to a special issue, try emailing our friendly technical engineers, specially trained to communicate quick, easy, and logical solutions to your inquiries within 24 hours.

3. Toll-Free Live Tech Support — (1-800-828-4040)

This option provides live telephone technical support, free of service charges, Monday-Saturday (excluding holidays), during your product's 1 year limited warranty period. Telephone Device for the Deaf (TDD) support is available at (1-866-251-3752).

4. Extended Service and Support — www.canonesp.com

Canon CarePAK Extended Service Plan is a cost-attractive and easy-to-use extended service program that provides up to three full years of service and support coverage at a very attractive price. CarePAK offers toll-free Canon technical support and includes Canon's superb InstantExchange product replacement program. For further information about extending your Canon service and support, call (1-800-385-2155), or visit our web site at www.canonesp.com. CarePAK must be purchased during your product's warranty period.

For more information and updated program specifics, please visit our web site at www.canontechsupport.com.

* Support program specifics are subject to change without notice.

Canon

PIXMA iP4000R

Photo Printer

Quick Start Guide

Canon PIXMA iP4000R Photo Printer Quick Start Guide.

Copyright

This manual is copyrighted by Canon U.S.A., Inc. with all rights reserved. Under the copyright laws, this manual may not be reproduced in any form, in whole or in part, without the prior written consent of Canon U.S.A., Inc.

© 2004 Canon U.S.A., Inc.

Disclaimer

Canon U.S.A., Inc. has reviewed this manual thoroughly in order that it will be an easy-to-use guide to your Canon PIXMA iP4000R Photo Printer. All statements, technical information and recommendations in this manual and in any guides or related documents are believed reliable, but the accuracy and completeness thereof are not guaranteed or warranted, and they are not intended to be, nor should they be understood to be, representation or warranties concerning the products described.

Specifications are subject to change without notice.



As an ENERGY STAR partner, Canon U.S.A., Inc., has determined that this product meets the ENERGY STAR guidelines for energy efficiency.

All information regarding non-Canon products was compiled from publicly available information. No representation is made regarding the accuracy thereof.

Trademarks

- Canon is a registered trademark of Canon Inc.
- PIXMA is a trademark of Canon Inc.
- PhotoRecord is a trademark of Canon Information System Research Australia.
- Macintosh, Mac and the Mac logo are registered trademarks of Apple Computer, Inc., registered in the U.S. and other countries.
- Microsoft® and Windows® are registered trademarks of Microsoft Corporation in the U.S. and other countries.
- Wi-Fi® is a registered trademark of the Wi-Fi Alliance.
- Wi-Fi CERTIFIED is a certification mark of the Wi-Fi Alliance.
- All other product and brand names are trademarks of their respective owners.

Canon U.S.A., Inc.
One Canon Plaza
Lake Success, NY 11042

Contents

Basic Printing

Turning on the Printer	2
Loading Paper	3
Using Specialty Media	13
Printing with Windows	15
Printing with Macintosh	18
Canceling Printing	21

Advanced Printing

Printing Photographs Directly from a Digital Camera	22
Accessing the Printer Driver	28
Adjusting the Print Quality for Photographs	29
Using the Bundled Software	37
Printing Borderless Photographs	38

Printing Maintenance

Replacing an Ink Tank	42
When Printing Becomes Faint or Colors are Incorrect	48
Printing the Nozzle Check Pattern	49
Print Head Cleaning	53
Print Head Deep Cleaning	57
Aligning the Print Head	61

Troubleshooting

Cannot Install the Printer Driver	66
Print Quality is Poor or Contains Errors	67
Troubleshooting Printer Hardware	69
Paper Does Not Feed Properly	71
Paper Jams	72
Handling Error Messages	75
An Error Message Appears on the Screen	77
Cannot Print Properly from the Digital Camera	81

Appendix

User's Guide Table of Contents	83
Specifications	84
Safety Precautions	88
Regulatory Information	90
CANON U.S.A., INC. LIMITED WARRANTY --- (USA Only)	91

Index	93
-------------	----

Basic Printing

 **Note** This *Quick Start Guide* describes some of the features of your printer and how to use them. For more information, view the *iP4000R User's Guide* on the *Setup Software & User's Guide CD-ROM*, or use the online help within your printer driver interface:

Windows

While in the printer's properties window, press the **F1** key, or click ? in the upper right corner. Then click the feature you want to know more about, or click the **Help** button when displayed.

Macintosh

While in the **Page Setup** dialog box or **Print** dialog box, click ? in the lower left corner.

Clicking ? provides detailed information about each setting.
When the Help window appears, select your desired topic.

Turning on the Printer

- 1** Press the **POWER** button.

The **POWER** lamp flashes while the printer warms up and changes to steady (non-flashing) green when the printer is ready.

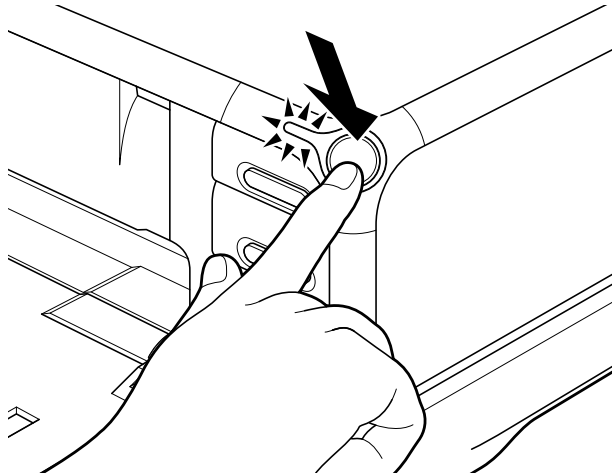

- **Important** ● Before unplugging the power cord, turn off the printer and ensure that the green lamp has gone out.
- If the **POWER** lamp changes to orange and begins flashing, refer to “Handling Error Messages” on page 75.

Loading Paper

This section describes how to load paper in the Sheet Feeder and the Cassette.

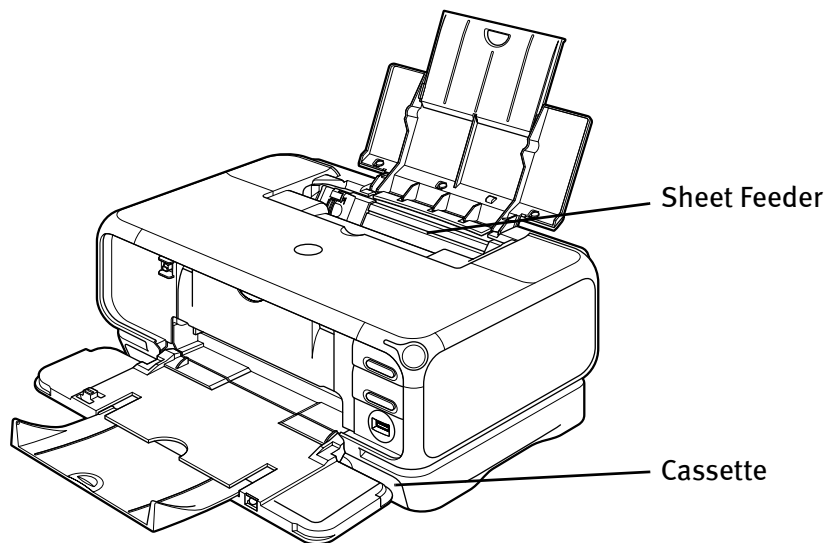

■ Print Media to Avoid

Do not use the following types of paper. Using such paper will not only produce unsatisfactory results, but can also cause the printer to jam or malfunction.

- Folded, curled or wrinkled paper
- Damp paper
- Excessively thin paper (less than 64 gsm or 17 lb)
- Excessively thick paper* (more than 105 gsm or 28 lb)
 - * non-Canon branded paper
- Picture postcards
- Postcards affixed with photos or stickers
- Envelopes with double flaps
- Envelopes with sticker flaps
- Envelopes with an embossed or treated surface
- Any type of paper with holes (Loose-leaf paper is an exception; it is printable when loaded from the Sheet Feeder.)

■ Using the Sheet Feeder and the Cassette

You can load paper in both the Sheet Feeder and Cassette.

Loading paper in the Sheet Feeder is easy, and is convenient if you frequently switch to and print on various sizes or types of paper.

Loading paper in the Cassette allows you to print without reloading paper for each job. This is convenient for loading a large volume of the type of paper you regularly print onto.

Loading paper in both the Sheet Feeder and Cassette makes the following paper feed methods available:

- Changing the paper source to feed different types/sizes of paper

If you load plain paper in the Cassette and photo paper in the Sheet Feeder, changing the paper source allows you to print on both types of paper without removing and reloading paper. To change the paper source, use the Paper Feed Switch on the printer or printer driver.

You can also specify the type/size of paper to be fed from the Cassette for regular use with the printer driver. For example, you can specify that Letter-sized plain paper is always fed from the Cassette whenever you print.

 **Note** For information on the printer driver settings, refer to “Changing the Paper Source” in the *User’s Guide*.

- Continuous printing on the same type/size of paper by using both the Sheet Feeder and Cassette together

If the Sheet Feeder or Cassette runs out of paper, the paper source automatically switches to the other one. This is useful for printing onto a large volume of paper. To use this feature, you need to configure the printer driver beforehand.

 **Note** For information on the printer driver settings, refer to “Changing the Paper Source” in the *User’s Guide*.

- Choosing the paper source to match the location of the printer

You can use just the Sheet Feeder or Cassette according to the location of the printer.

For example, if you intend to install the printer in a small place, such as on a shelf with minimal space, you can use just the Cassette for printing.

 **Note** Legal-sized paper and 2.13" x 3.39"/ 54.0 x 86.0 mm size paper are not loadable in the Cassette.

For more information on the media loadable in the Sheet Feeder and the Cassette, refer to “Printing Media” in the *User’s Guide*.

■ Loading Plain Paper in the Sheet Feeder

-  **Note**
- For detailed information on the specialty media Canon provides for use with its various printers, refer to “Using Specialty Media” on page 13.
 - See “Printing Media” in the *User’s Guide* for detailed instructions on how to load envelopes and specialty media into the printer.

1 Flatten the four corners of the paper before loading it.

-  **Important** When paper is curled, hold the opposing curled corners and gently bend them in the opposite direction until the paper becomes completely flat.

2 Prepare to load paper.

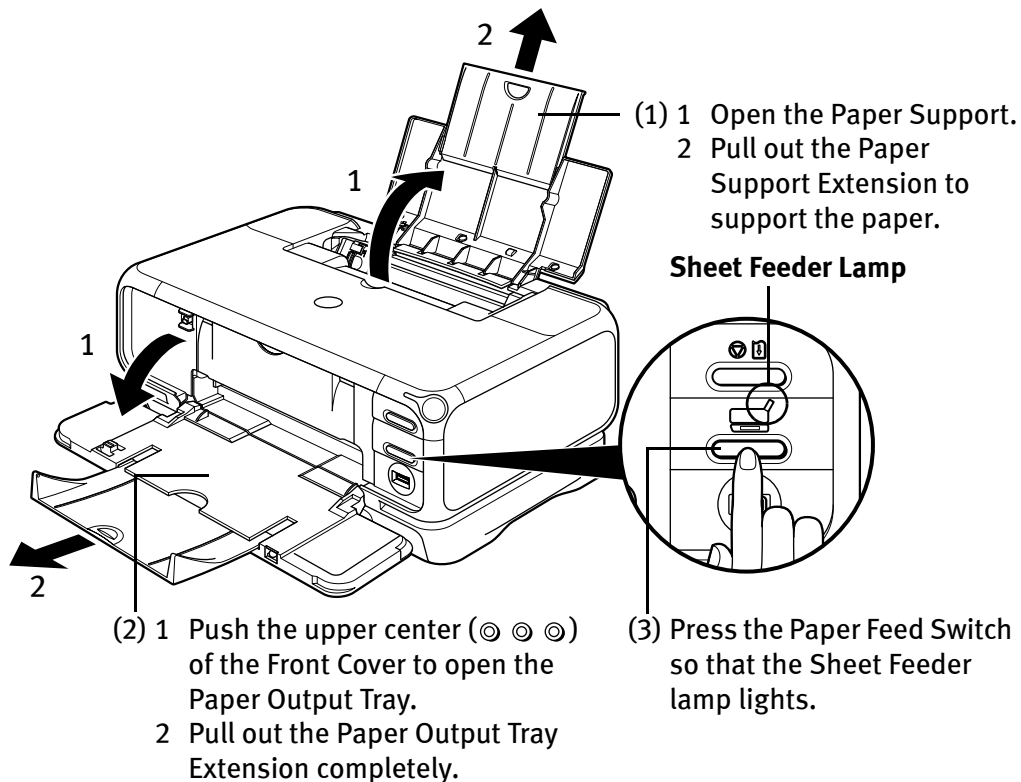

-  **Important** Support the Front Cover with your hand when opening the tray.

-  **Note** You can also select the paper source with the printer driver. For details, refer to “Changing the Paper Source” in the *User’s Guide*.

3 Load the paper.

Load Limit Mark

Do not load beyond this Load Limit Mark.

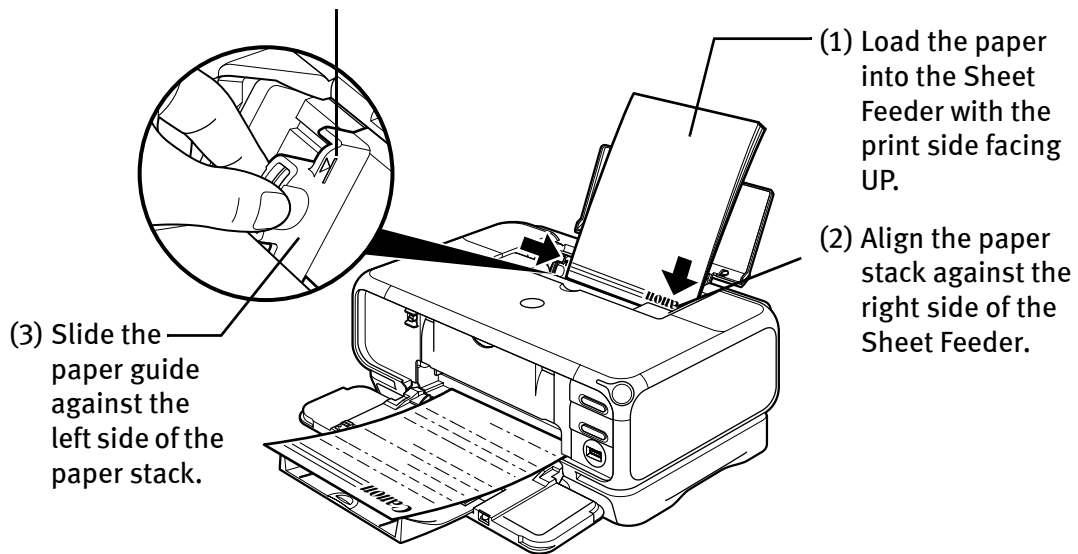

-  **Note**
- You can use general copy paper or Canon's Super White Paper SW-201.
 - You can load up to 150 sheets of plain paper (64 gsm or 17 lb, 13 mm or 0.52 inches in height) in the Sheet Feeder. However, do not stack more than 50 sheets in the Paper Output Tray.

■ Loading 4" x 6"-Sized Paper in the Sheet Feeder

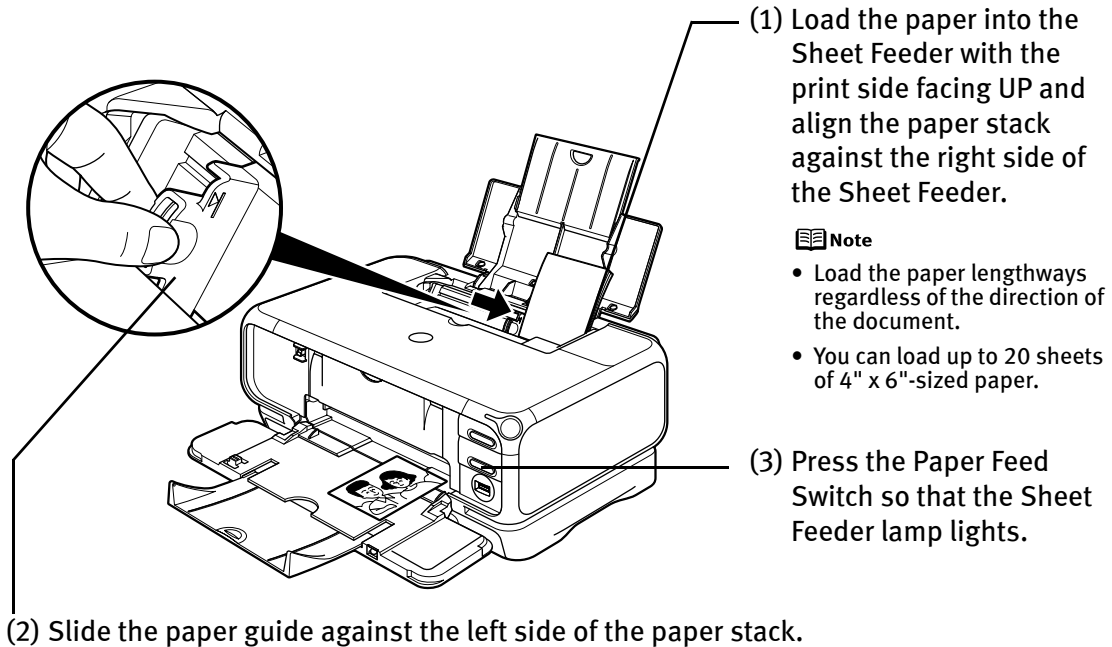

(4) Select **4" x 6"** from **Paper Size** in the printer driver.

For a detailed description of the printer driver settings, refer to “**Printing with Windows**” on page 15, or “**Printing with Macintosh**” on page 18.

■ Loading Plain Paper in the Cassette

-  **Note**
- For detailed information on the specialty media Canon provides for use with its various printers, refer to “Using Specialty Media” on page 13.
 - See “Printing Media” in the *User’s Guide* for detailed instructions on how to load envelopes and specialty media into the printer.

1 Flatten the four corners of the paper before loading it.

-  **Important** When paper is curled, hold the opposing curled corners and gently bend them in the opposite direction until the paper becomes completely flat.

2 Prepare to load paper.

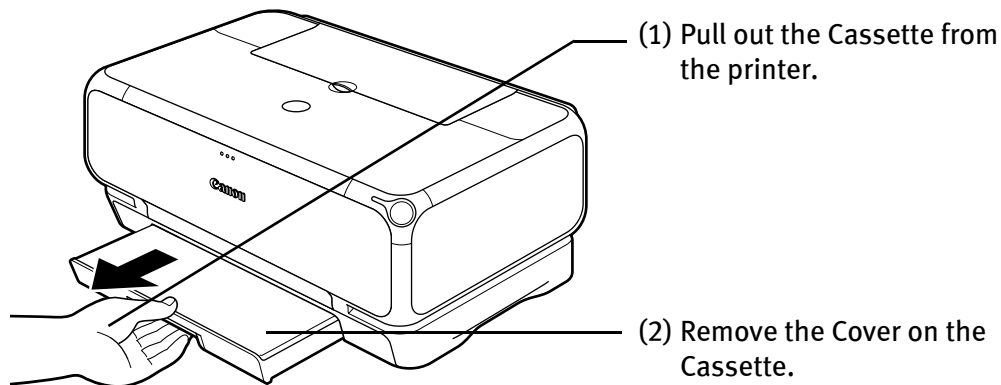

(3) Pinch the tab and extend the Cassette if needed.

 **Note**

- When loading A5- or larger sized paper (nonstandard-size paper: 203 mm / 8 inches or longer in length), extend the Cassette.
- When loading 5" x 7"- or smaller sized paper (nonstandard-size paper: 202 mm / 8 inches or shorter in length), do not extend the Cassette.
- Legal-sized and 2.13" x 3.39" / 54.0 x 86.0 mm size paper are not loadable in the Cassette.

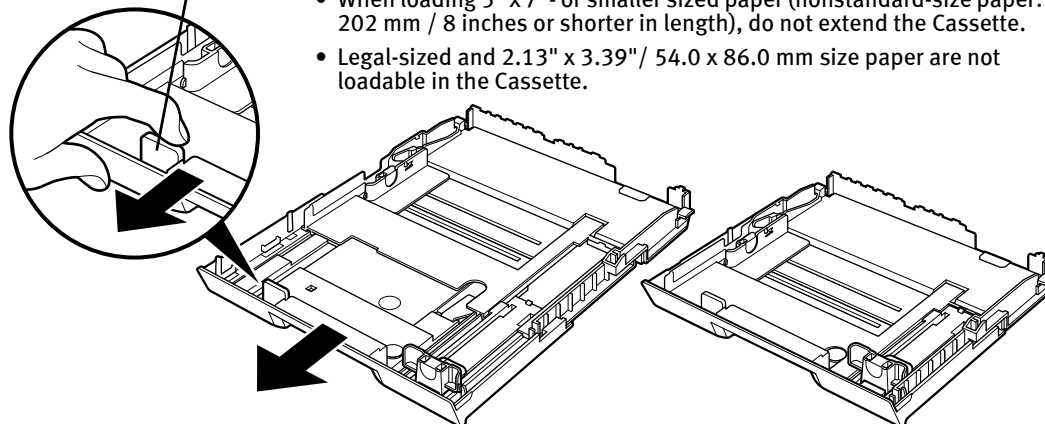

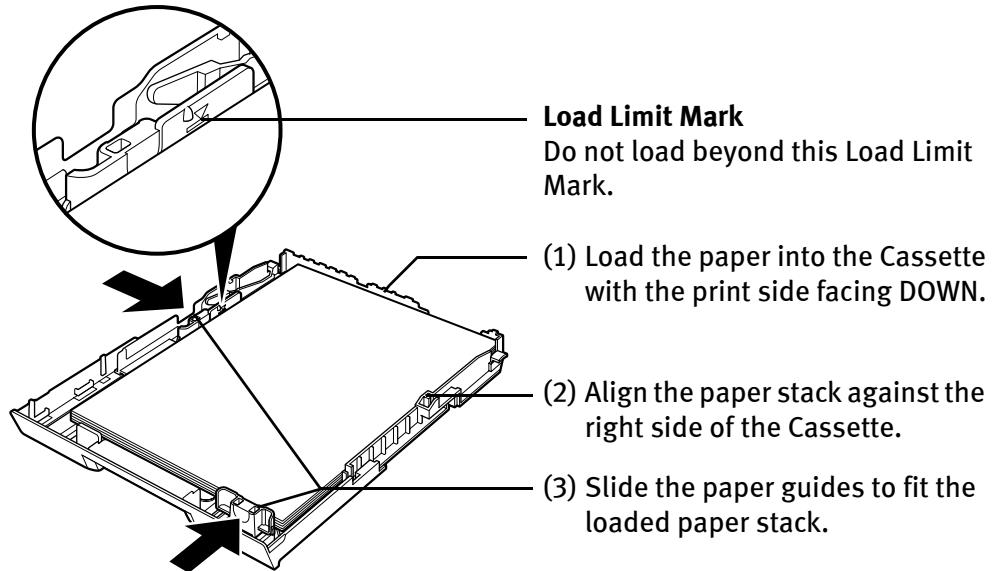

3 Load the paper.

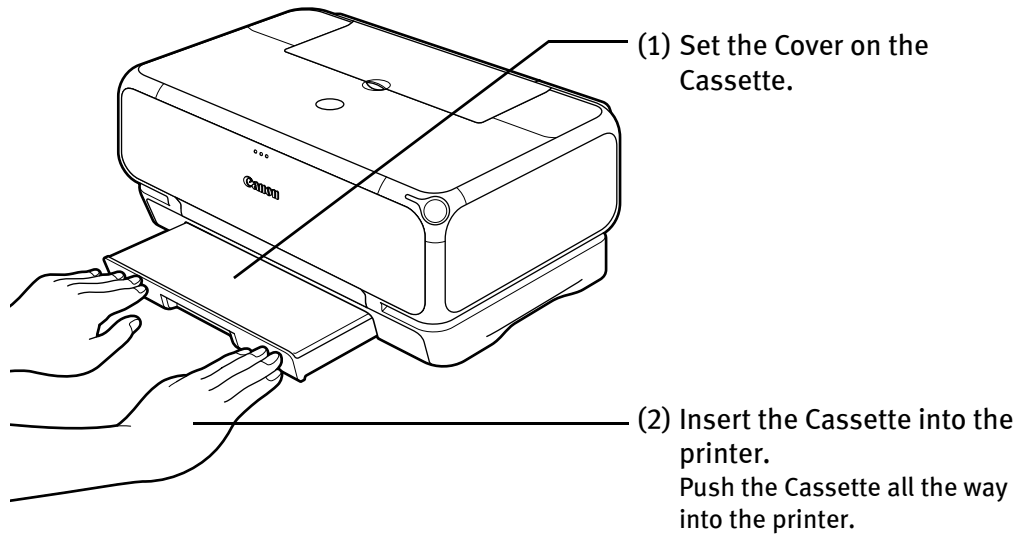

- Note**
- You can use general copy paper or Canon's Super White Paper SW-201.
 - You can load up to 150 sheets of plain paper (64 gsm or 17 lb, 13 mm or 0.52 inches in height) in the Cassette. However, do not stack more than 50 sheets in the Paper Output Tray.

4 Insert the Cassette into the printer.



 **Note** If the Cassette has been extended to accommodate paper sizes larger than 5" x 7", the front edge of the cassette will extend beyond the front of the printer.

5 Prepare the Paper Output Tray.

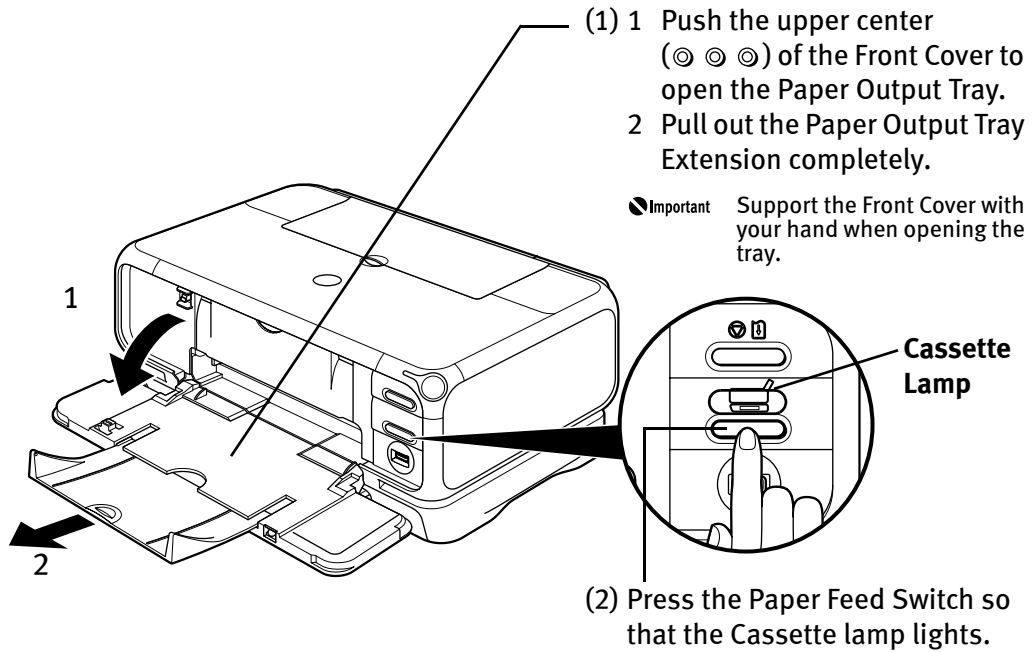

Note You can also select the paper source with the printer driver. For details, refer to “Changing the Paper Source” in the *User’s Guide*.

■ Loading 4" x 6"-Sized Paper in the Cassette

⚠ **Important** Do not leave photo paper, such as Photo Paper Pro, in the Cassette for a long time. This may cause paper discoloration due to natural aging.

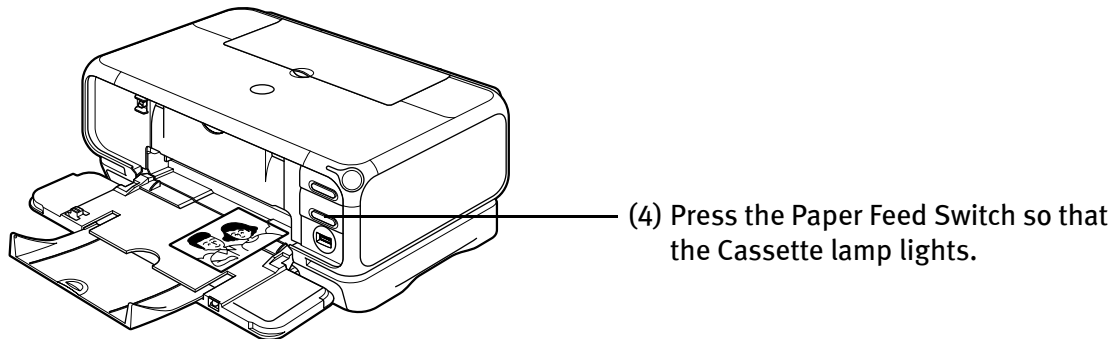
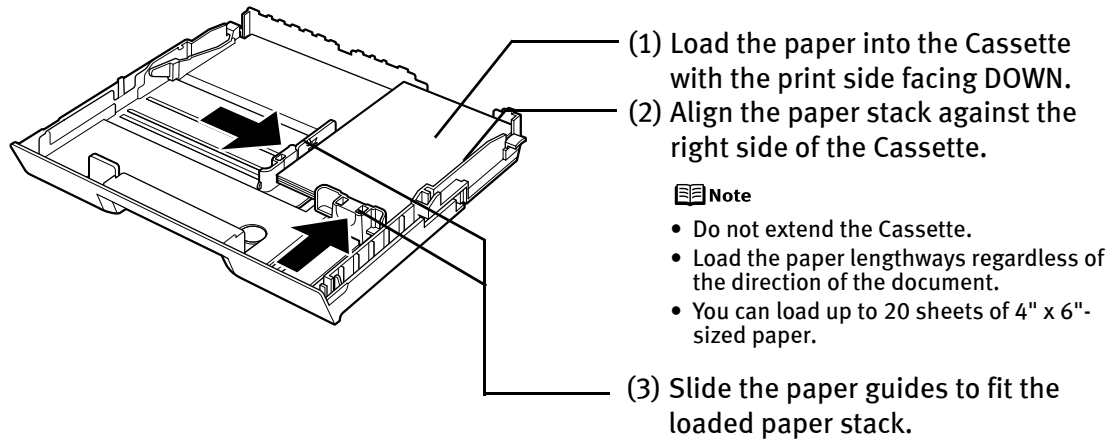

(5) Select 4" x 6" from **Paper Size** in the printer driver.

For a detailed description of the printer driver settings, refer to “Printing with Windows” on page 15, or “Printing with Macintosh” on page 18.

Using Specialty Media

Canon recommends that you use genuine Canon media to ensure optimal print quality.

■ Photo Quality Media

- Photo Paper Pro
- Photo Paper Plus Glossy
- Photo Paper Plus Double Sided
- Photo Paper Plus Semi-gloss
- Matte Photo Paper
- Glossy Photo Paper
- High Resolution Paper



■ Media Suited for Business Documents

- High Resolution Paper
- Transparencies



■ **Canon Specialty Media**

Media Type	Paper Support Load Limit		Printer Driver Setting for Media Type
	Sheet Feeder	Cassette	
Super White Paper	Up to 13 mm or 0.52 inches	Up to 13 mm or 0.52 inches	Plain Paper
Photo Paper Pro	Letter: up to 10 sheets* 4" x 6": up to 20 sheets	Letter: up to 10 sheets* 4" x 6": up to 20 sheets	Photo Paper Pro
Photo Paper Plus Glossy	Letter: up to 10 sheets 5" x 7": up to 10 sheets 4" x 6": up to 20 sheets	Letter: up to 10 sheets 5" x 7": up to 10 sheets 4" x 6": up to 20 sheets	Photo Paper Plus Glossy
Photo Paper Plus Double Sided	Letter: up to 10 sheets 5" x 7": up to 10 sheets	Letter: up to 10 sheets 5" x 7": up to 10 sheets	Photo Paper Plus Double Sided
Photo Paper Plus Semi-gloss	Letter: up to 10 sheets 4" x 6": up to 20 sheets	Letter: up to 10 sheets 4" x 6": up to 20 sheets	Photo Paper Plus Glossy
Matte Photo Paper	Up to 10 sheets	Up to 10 sheets	Matte Photo Paper
Glossy Photo Paper	Letter: up to 10 sheets 4" x 6": up to 20 sheets 2.13" x 3.39": up to 20 sheets	Letter: up to 10 sheets 4" x 6": up to 20 sheets 2.13" x 3.39": not loadable	Glossy Photo Paper
High Resolution Paper	Up to 80 sheets	Up to 80 sheets	High Resolution Paper
T-Shirt Transfers	1 sheet	1 sheet	T-Shirt Transfer
Transparencies	Up to 30 sheets	Up to 30 sheets	Transparency

* If paper does not feed properly, fan the paper to prevent sticking together. Then, load one sheet at a time.

-  **Note**
- When using plain paper (64 gsm or 17 lb), up to 150 sheets (13 mm or 0.52 inches in height) can be loaded in the Sheet Feeder and Cassette respectively. Select **Plain Paper** from **Media Type** in the printer driver.
 - For a detailed description of printing media types, refer to the *User's Guide*.

Windows

Printing with Windows

-  **Note**
- The menu screens and dialog boxes that appear may vary, depending on the software application you are using.
 - The steps described in this section are for printing in Windows XP.

- 1** Turn on the printer.
See “Turning on the Printer” on page 2.
- 2** Load the paper in the printer.
See “Loading Paper” on page 3.
- 3** Ensure that the proper paper source is selected.

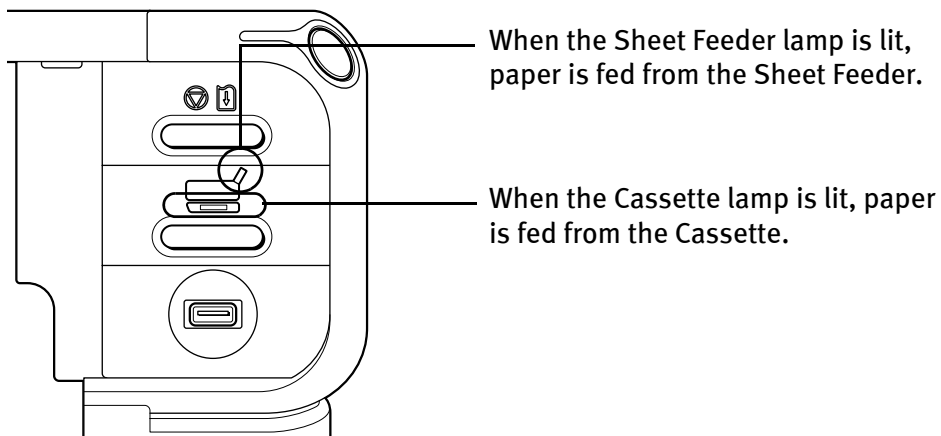

- 4** Create a document or open a file to print.

Basic Printing

5 Open the printer properties dialog box.

- (1) Select **Print** from the application software's **File** menu.
The **Print** dialog box opens.

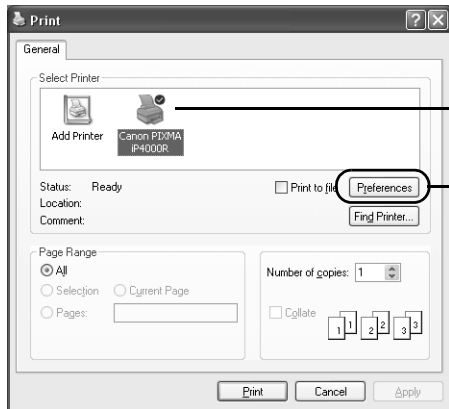

(2) Ensure that your printer is selected.

(3) Click **Preferences** or **Properties**.

6 Specify the required settings.

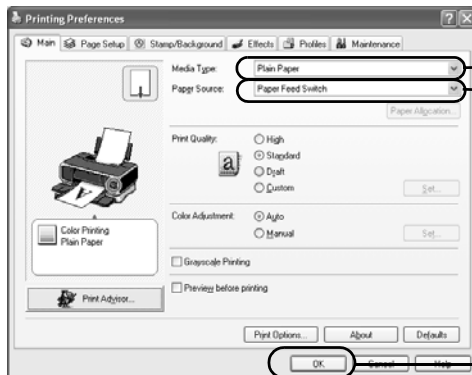

(1) Click **Media Type** to select the type of media loaded in the printer.

Ensure that **Paper Feed Switch** is selected from **Paper Source**.

(2) Click **OK**.

-  **Note**
- From the **Page Setup** tab, select the correct document size to be printed.
 - This section describes the procedure for selecting the paper source with the Paper Feed Switch on the printer. For a detailed description of the **Paper Source** settings, refer to “Changing the Paper Source” in the *User’s Guide*.
 - To adjust the **Print Quality** settings, select **Custom** and click **Set** on the **Main** tab. You can control the print quality in the **Set Print Quality** dialog box.
 - For details about other printer driver functions, refer to “Printer Driver Functions (Windows)” in the *User’s Guide* or **Help**.
 - Selecting the **Preview before printing** check box displays a preview screen that allows you to confirm the selected printing effects and how your document will look when printed. Some applications do not have a preview function.

7 Print the document.

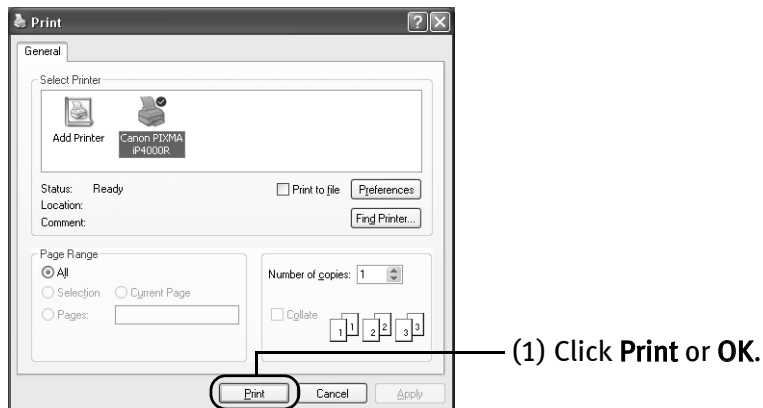

-  **Note**
- You can cancel a print job in progress by simply pressing the **RESUME/CANCEL** button on the printer. See “Canceling Printing” on page 21.
 - Click **Cancel Printing** on **BJ Status Monitor** to stop printing. To show **BJ Status Monitor**, click **Canon PIXMA iP4000R** on the taskbar. **BJ Status Monitor** opens automatically when a printer error occurs.

Macintosh

Printing with Macintosh

-  **Note**
- The menu screens and dialog boxes that appear may vary, depending on the software application you are using.
 - The steps described in this section are for printing in Mac OS X v.10.3.x.

- 1 Turn on the printer.**
See “Turning on the Printer” on page 2.
- 2 Load the paper on the printer.**
See “Loading Paper” on page 3.
- 3 Ensure that the proper paper source is selected.**

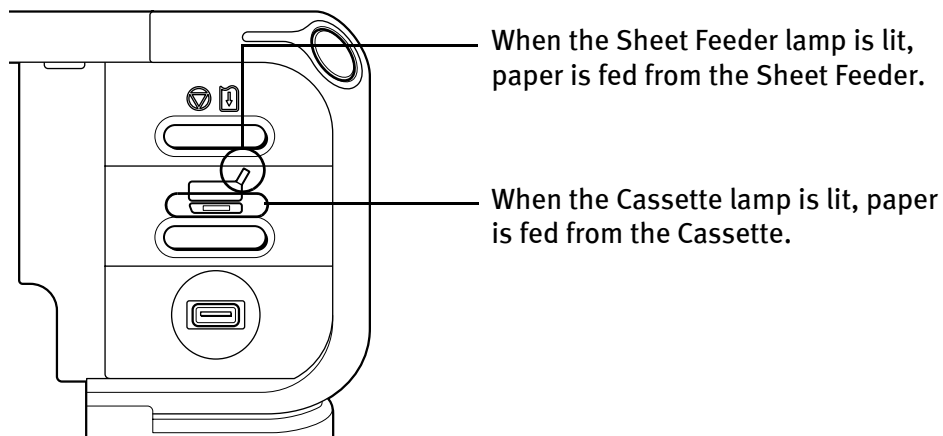

- 4 Create a document or open a file to print.**

5 Select Paper Size.

- (1) Select **Page Setup** from the application software's **File** menu.
The **Page Setup** dialog box opens.

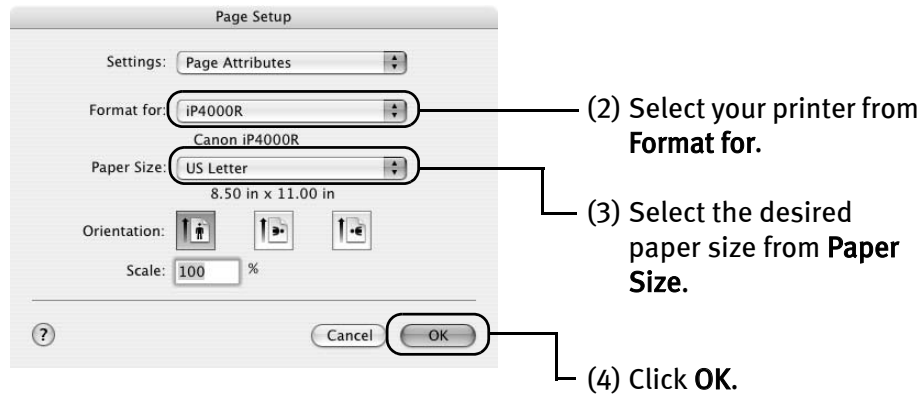

6 Specify the required settings.

- (1) Select **Print** from the application software's **File** menu.
The **Print** dialog box opens.

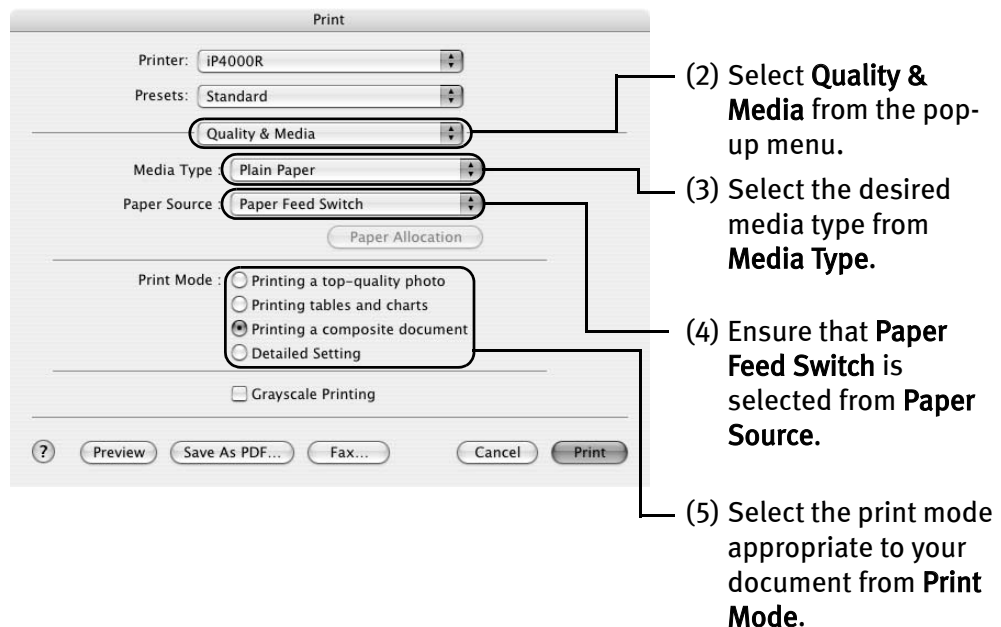

Basic Printing

-  **Note**
- This section describes the procedure for selecting the paper source with the Paper Feed Switch on the printer. For a detailed description of the **Paper Source** settings, refer to “Changing the Paper Source” in the *User’s Guide*.
 - When you select the print mode appropriate to your document from **Print Mode**, the document will be printed in color and at a print quality suited to the characteristics of the **Media Type** you have selected.
 - **Printing a top-quality photo:** Select when printing documents consisting mainly of photographs and graphics featuring fine color gradation.
 - **Printing tables and charts:** Select when printing documents consisting mainly of graphs and graphics (illustrations) with strong color definition.
 - **Printing a composite document:** Select when printing documents consisting mainly of text.
 - **Detailed Setting:** Select to fine-tune the **Print Quality** and **Halftoning** settings. See “Adjusting Print Quality” on page 29.

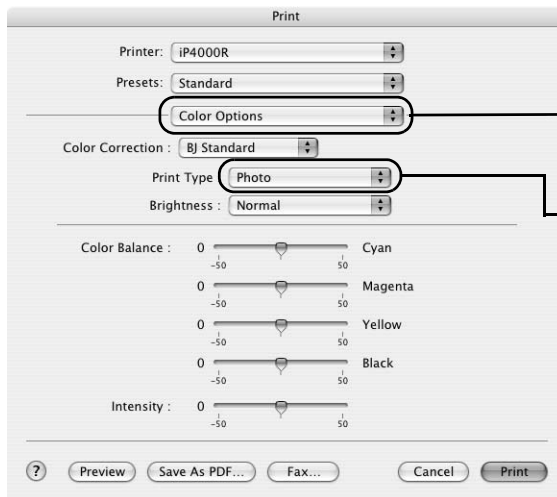

(6) Select **Color Options** from the pop-up menu.

(7) Select the type of the document from **Print Type**.

-  **Note**
- For details about other printer driver functions, refer to “Printer Driver Functions (Macintosh)” in the *User’s Guide* or **Help**.
 - Clicking the **Preview** button displays a preview screen that allows you to confirm the selected printing effects and how your document will look when printed. Some applications do not have a preview function.

7 Print the document.

- (1) Click **Print**.

 **Note** Double-clicking the name of your printer in the **Printer** list displays a dialog that prompts you to confirm the status of the print job(s). To cancel a job in progress, select the desired document, then click **Delete**. To temporarily stop a job in progress, click **Pause**. To cancel all the jobs in the list, click **Stop Printing**.

Canceling Printing

You can cancel a print job while printing, with the **RESUME/CANCEL** button on the printer.

- 1** Press the **RESUME/CANCEL** button while printing.

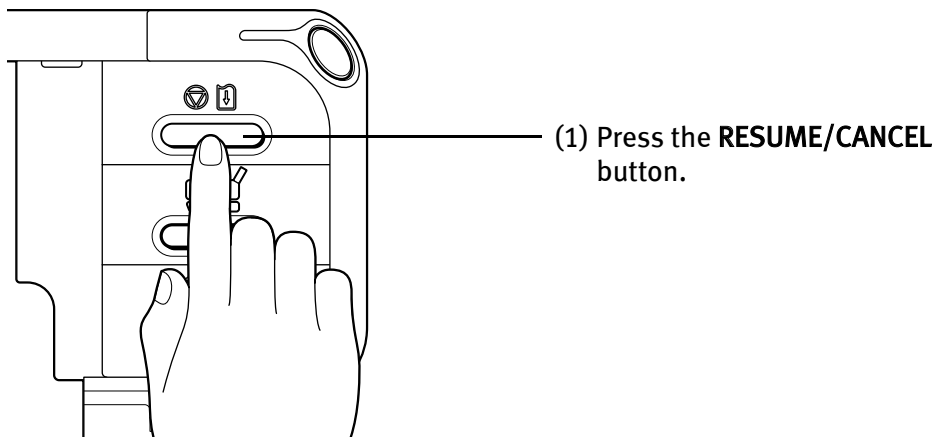

Printing is canceled and paper is fed out.

Advanced Printing

Printing Photographs Directly from a Digital Camera

Connecting a compatible digital still camera or camcorder to the printer allows you to print recorded images directly without using a computer. This printer supports both PictBridge and Canon Bubble Jet Direct.

-  **Note**
- PictBridge is an industry standard enabling a range of digital photo solutions, including the direct printing of photos from compatible digital still cameras or digital video camcorders* without the need to use a computer.
 - Canon Bubble Jet Direct allows you to print photos from Canon Bubble Jet Direct compatible (PictBridge incompatible) digital camera or digital video camcorder without a computer, by simply connecting the digital camera or digital camcorder to this printer.

* Hereafter, the digital still camera and digital video camcorder are collectively called a digital camera or camera.

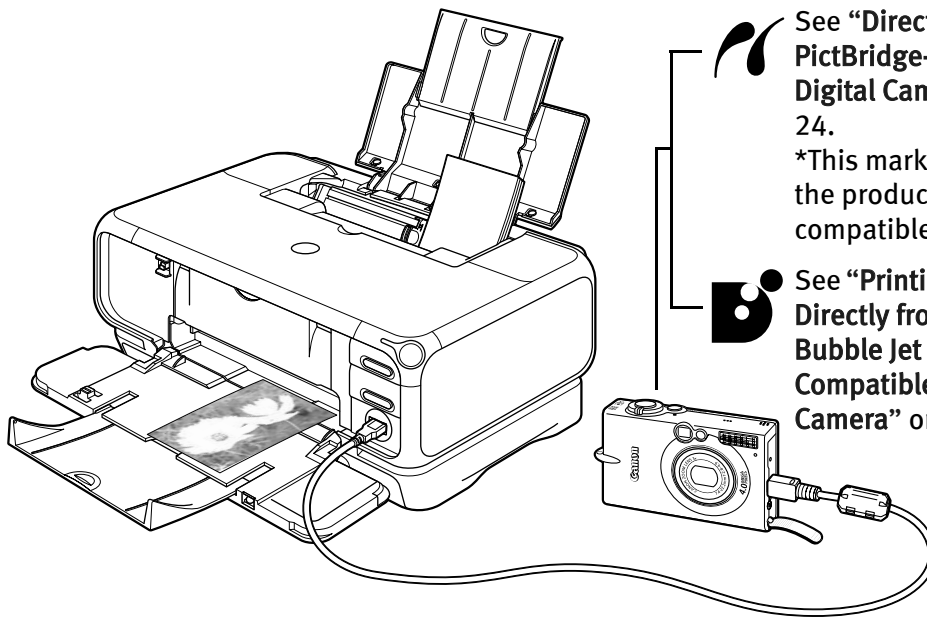

See “Direct Printing from PictBridge-compatible Digital Cameras” on page 24.

*This mark indicates that the product is PictBridge-compatible.

See “Printing Photographs Directly from a Canon Bubble Jet Direct Compatible Digital Camera” on page 27.

■ Connecting to a Digital Camera

▲ Caution Do not connect any equipment other than the camera ready for PictBridge or Canon Bubble Jet Direct to the Direct Print Port of the printer. If you do so, electric shock, fire, or damage to the camera could result.

- 📖 Note**
- When printing photos with the digital camera connected to the printer, it is advisable to use the AC adapter supplied with the camera. If you use the camera battery, be sure to charge it fully.
 - The Print Head cannot be aligned using the controls of the digital camera. The print head alignment can be performed simply by pressing the **RESUME/CANCEL** button on the printer, or by connecting the printer to the computer and then executing automatic print head alignment. Refer to “Aligning the Print Head” on page 61.
 - Depending on the model or brand of your camera, you may have to select a print mode compliant with PictBridge before connecting the camera.
You may also have to turn on the camera or select Play mode manually after connecting the camera to the printer.
Perform necessary operations according to the instruction manual supplied with your camera.
 - When printing from your PC, be sure to unplug the cable connecting the digital camera.

1 Set up the printer.

2 Turn on the printer.

See “Turning on the Printer” on page 2.

3 Load the paper in the printer.

See “Loading Paper” on page 3.

4 Connect the digital camera to the printer.

(1) Make sure the camera is turned off.

(2) Connect the camera to the printer using the USB cable (for connection to a computer) supplied with the camera.

Advanced Printing

- (3) Turn on and set up the camera for direct printing.

When the connection between the camera and printer has been established, the **POWER** lamp on the printer flashes once.

* The power-on sequence may differ depending on the model or brand of the camera.

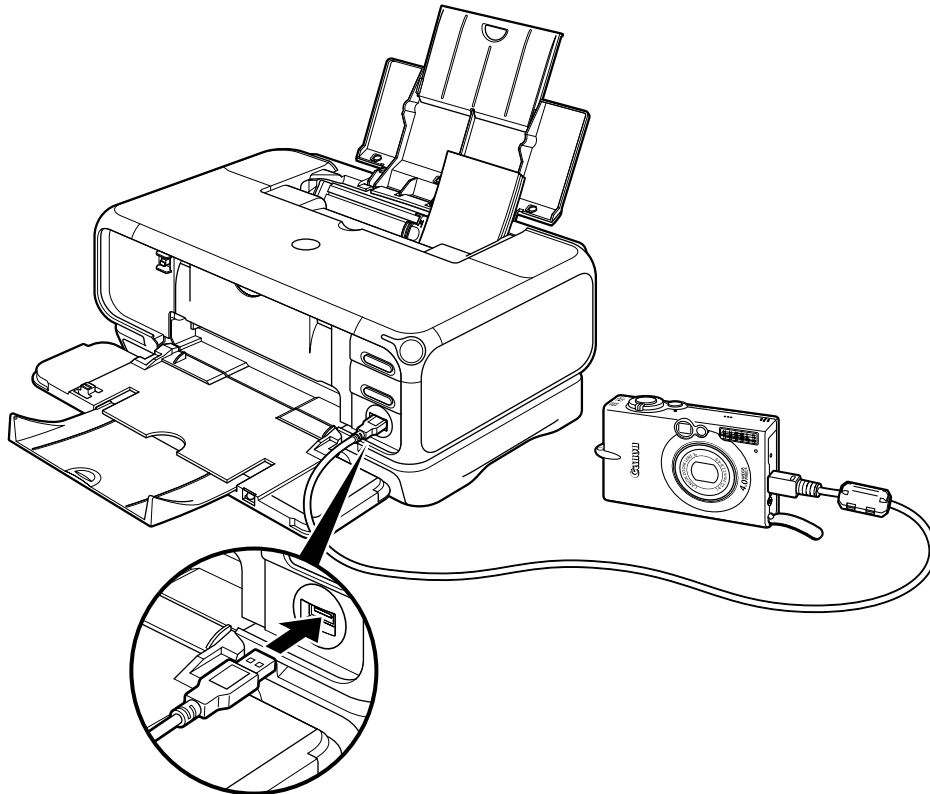

Either of the following icons will display on the LCD display of the digital camera when the printer is correctly connected.



A PictBridge-compatible digital camera.



A Canon Bubble Jet Direct compatible digital camera.

■ Direct Printing from PictBridge-compatible Digital Cameras

Default Camera Settings

When a PictBridge-compatible camera is connected and printing is started with no printing option selected, this printer operates based on the following default settings:

- Paper size 4" x 6"
- Paper type..... Photo (Photo Paper Plus Glossy)

- LayoutBorderless
- TrimmingOff (No trimming)
- Image optimizeOn (ExifPrint)
- Date print.....Off (No printing)

Additional settings

The settings explained below cannot be made on some cameras. If any setting cannot be made, the default setting explained above is used.

Names of settings that are displayed on Canon PictBridge-compatible cameras are used in the description given below. Different names may be displayed on your camera depending on the brand or model.

For details, refer to your camera’s instruction manual.

About Paper size and Paper type

To change the paper size or paper type, operate from the camera to select the PictBridge print setup mode and confirm or check the settings.

By default, **4" x 6"** is selected from **Paper size** and **Photo** (Photo Paper Plus Glossy) is selected from **Paper type** for this printer. To use Photo Paper Pro, select **Fast Photo** from **Paper type**.

If using a Canon PictBridge-compatible camera, you can select **5" x 7"** from **Paper size**. The following sizes and types of paper can be loaded in the printer by selecting options from **Paper size** and **Paper type**.

Paper size setting	Paper type setting	Paper loaded in printer
10 x 15 cm/4" x 6" (Default)	Photo (Default)	Photo Paper Plus Glossy
	Fast Photo	Photo Paper Pro
	Photo	Photo Paper Plus Semi-gloss
	Photo	Glossy Photo Paper
13 x 18 cm/5" x 7"	Photo	Photo Paper Plus Glossy
A4/8.5" x 11" (Letter)	Photo	Photo Paper Plus Glossy
	Fast Photo	Photo Paper Pro
	Photo	Photo Paper Plus Semi-gloss
	Photo	Glossy Photo Paper
5.4 x 8.6 cm/Credit Card	Photo	Glossy Photo Paper

When **4" x 6"** is selected from **Paper size**, “2-up”, “4-up”, “9-up”, and “16-up” options may be available in **Layout**.

Advanced Printing

About Image optimize

If you use a Canon PictBridge-compatible camera, you can select **VIVID**, **NR**, or **VIVID+NR**. (Note that these options cannot be selected for some models.)

-  **Note**
- When **VIVID** is selected, green and blue portions of photos are printed vividly.
 - When **NR** (Noise Reduction) is selected, noise in blue portions, such as the sky, and dark portions is removed.
 - When **VIVID+NR** is selected, functions of both **VIVID** and **NR** are performed.

About Date print

If “On” is selected, the shooting date recorded in Exif image data is printed on the lower-right corner of each photo.

-  **Note**
- This printer can handle only Exif/JPEG image data to produce photos using PictBridge.
 - Never disconnect the USB cable during printing.
 - When disconnecting the USB cable between the digital camera and printer, follow the instructions given in the Instruction Manual of Camera.
 - Controls of the digital camera cannot be used for the following functions:
 - Print quality setting
 - Printer maintenance
 - For the digital camera operation method and troubleshooting, refer to your digital camera manual. For print error messages, see “Cannot Print Properly from the Digital Camera” on page 81.

■ Printing Photographs Directly from a Canon Bubble Jet Direct Compatible Digital Camera

Media Types for Digital Camera

When you connect a digital camera, you can use the following media:

Digital Camera Setting	Media Type
Card #1	Photo Paper Pro 4" x 6" / 101.6 x 152.4 mm
Card #2	Photo Paper Plus Glossy 4" x 6" / 101.6 x 152.4 mm
	Photo Paper Plus Semi-gloss 4" x 6" / 101.6 x 152.4 mm
	Glossy Photo Paper 4" x 6" / 101.6 x 152.4 mm
Card #3	Photo Paper Plus Glossy 5" x 7" / 127.0 x 177.8 mm
LTR	Photo Paper Pro Letter
	Photo Paper Plus Glossy Letter
	Photo Paper Plus Semi-gloss Letter
	Glossy Photo Paper Letter
A4	Photo Paper Pro A4
	Photo Paper Plus Glossy A4
	Photo Paper Plus Semi-gloss A4
	Glossy Photo Paper A4

-  **Note**
- For the digital camera operation method and troubleshooting, refer to your digital camera manual. For print error messages, see “Cannot Print Properly from the Digital Camera” on page 81.
 - By operating the digital camera, you can make the following prints:
 - You can make a standard print from the image displayed in the single display mode or in the index display mode.
 - You can print specified numbers of images, or make an index print by editing the DPOF.
 - For the images taken with an ExifPrint-compatible digital camera, the Photo Optimizer PRO function can be used.
 - If date printing is set from the digital camera, the date when the photograph was taken is to be printed (excluding the index print).
 - Images will be scaled automatically according to the image size set on the digital camera and the size of the media set on the printer.
 - The digital camera does not support the following functions:
 - Print quality setting
 - Printer maintenance
 - Images other than Exif may not be index-printed.

Accessing the Printer Driver

The printer properties dialog box can be opened from either within an application, or directly from the Windows **Start** menu.

 **Note** This manual refers to Windows XP operation.
The operations may vary depending on your operating system.

■ Opening the Printer Properties Dialog Box from Your Application Program

 **Note** Depending on your application program, the command and menu names may differ, and there may be more steps involved in opening the printer properties dialog box. For more details, see the user's manual for your application.

- 1** In your application, select the command to print a document.
The **Print** dialog box can usually be opened by selecting **Print** from the **File** menu.
- 2** Ensure that the name of your printer is selected. Then click **Preferences (or Properties)**.
The printer properties dialog box opens.

■ Opening the Printer Properties Dialog Box Directly from the Start Menu

This method is used for maintenance operations, such as **Print Head Cleaning**, or to specify printer settings common to all application programs.

- 1** Click **Start** and select **Control Panel, Printers and Other Hardware**, and then **Printers and Faxes**.
For non-Windows XP, click **Start**, select **Settings**, and then **Printers**.
- 2** Double-click the icon of your printer.
- 3** Open the **File** menu and select **Printing Preferences (or Properties)**.

The printer properties dialog box opens.

When opening the printer properties dialog box from **Properties**, the default Window tabs (e.g., the **Ports** tab, or the **Details** tab) are displayed. These tabs are not displayed, when the printer properties dialog box is opened from **Printing Preferences** or applications. For details about these tabs, refer to the Windows documentation.

Adjusting the Print Quality for Photographs

■ Improving the Quality of Printed Images

Two important factors control the quality and output of your printed images:

Paper and Ink

Using recommended Canon paper, specialty media, and inks for printing photographs can significantly improve the quality of your printouts. See inside the back cover for a list of Canon Specialty Papers and ink tanks for this printer.

For more detailed information, refer to “Printing Media” in the *User’s Guide*.

Printer Driver Settings

The printer driver has a variety of settings that can be used to creatively enhance the colors and output of your photographs. Many of these features are covered in this chapter.

 **Note** You can also access the online help in either of the following ways depending on your operating system:

In Windows

- Press the **F1** key.
- Click **?** in the upper right corner, then click the feature you want to know more about.
- Click the **Help** button when displayed.

In Macintosh

- Click **?** in the **Page Setup** dialog box or the **Print** dialog box.

■ Adjusting Print Quality

Features that affect the appearance and quality of your printed images can be controlled with the printer driver.

Your printer automatically adjusts printer settings to improve print quality based on the media type (plain paper, Photo Paper Pro, and so on). You can also customize the **Print Quality** settings if desired.

Advanced Printing

To manually adjust Print Quality settings:

Windows

- 1** Open the printer properties dialog box.
See “Opening the Printer Properties Dialog Box from Your Application Program” on page 28.
- 2** On the **Main** tab, select **Custom** from **Print Quality**, then click **Set** to open the **Set Print Quality** dialog box.
- 3** Move the slide bar to adjust the print quality.

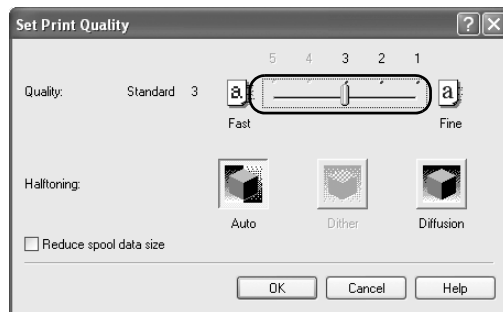

- 4** When the process is complete, click **OK**.
- 5** Click **OK** on the **Main** tab.
- 6** Click **Print** or **OK**.

Macintosh

- 1** Open the **Print** dialog box.
See “Printing with Macintosh” on page 18.
- 2** Select **Quality & Media** from the pop-up menu, and then click **Detailed Setting**.

3 Move the slide bar to adjust the print quality.

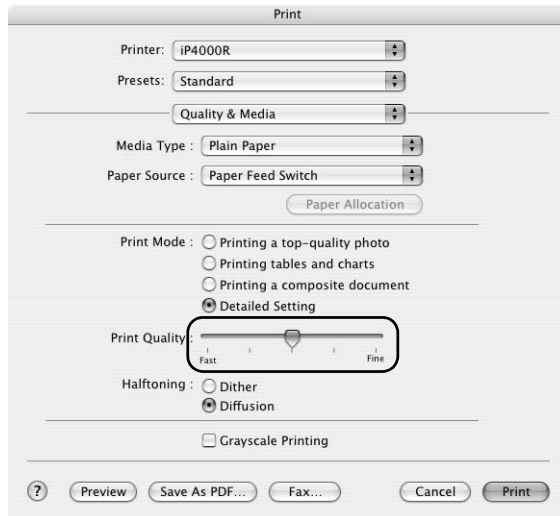

4 When the process is complete, click **Print**.

To automatically optimize the image:

Photo Optimizer PRO automatically adjusts the photographs taken with a digital camera. Use this feature to compensate for unsatisfactory color balance and over- or under-exposure before printing. **Photo Optimizer PRO** is available for Windows only.

 **Note** In Windows Me or Windows 98
If **Background Printing** has been disabled, the **Photo Optimizer PRO** function is not available.

Windows

1 Open the printer properties dialog box.

See “Opening the Printer Properties Dialog Box from Your Application Program” on page 28.

2 Click the **Effects** tab.

Advanced Printing

3 Select the **Photo Optimizer PRO** check box.

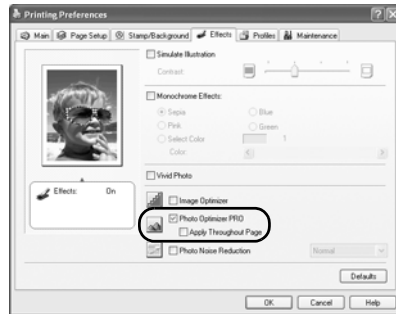

4 Click **OK**.

To use **Vivid Photo** option:

Vivid Photo intensifies background colors such as fields, trees, oceans and skies, while maintaining natural skin tones in the images.

 **Note** In **Windows Me** or **Windows 98**
If **Background Printing** has been disabled, the **Vivid Photo** function is not available.

Windows

To use **Vivid Photo**, select the **Vivid Photo** check box on the **Effects** tab.

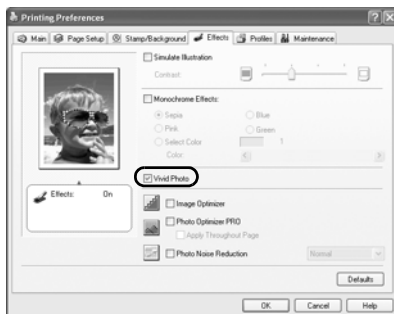

Macintosh

To use **Vivid Photo**, select the **Vivid Photo** check box under **Special Effects**.

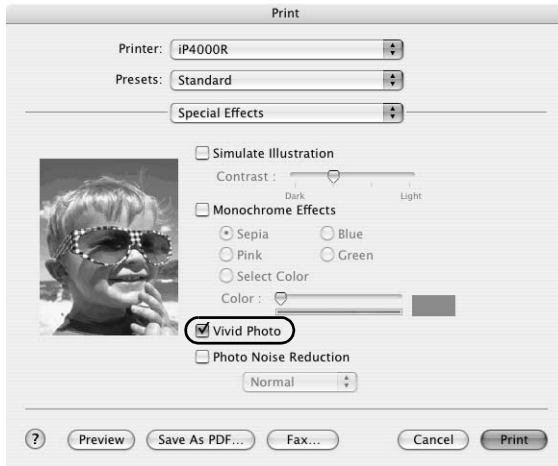

To reduce noise from images taken with a digital camera:

The **Photo Noise Reduction** function reduces noise from blue portions such as the sky, and dark portions of the images taken with your digital camera.



Note In Windows Me or Windows 98

If **Background Printing** has been disabled, the **Photo Noise Reduction** function is not available.

Windows

To use **Photo Noise Reduction**, select the **Photo Noise Reduction** check box on the **Effects** tab.

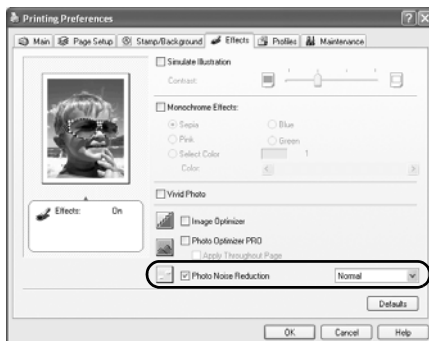

Advanced Printing

Macintosh

To use **Photo Noise Reduction**, select the **Photo Noise Reduction** check box under **Special Effects**.

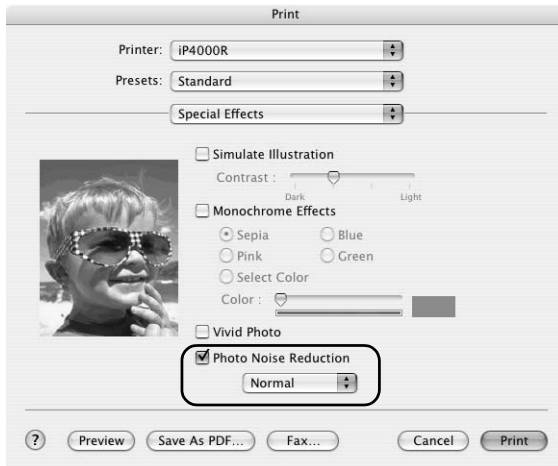

■ Saving and Recalling Printer Driver Settings

When you change printer driver settings for a specific print job, such as printing black and white photos, or printing documents with a special background, you can save and name these settings for future use on similar print jobs.

Windows

- 1 Open the printer properties dialog box.
See “Opening the Printer Properties Dialog Box from Your Application Program” on page 28.
- 2 In each tab, set all necessary items.
- 3 Click the **Profiles** tab.
- 4 Register new printer driver settings.

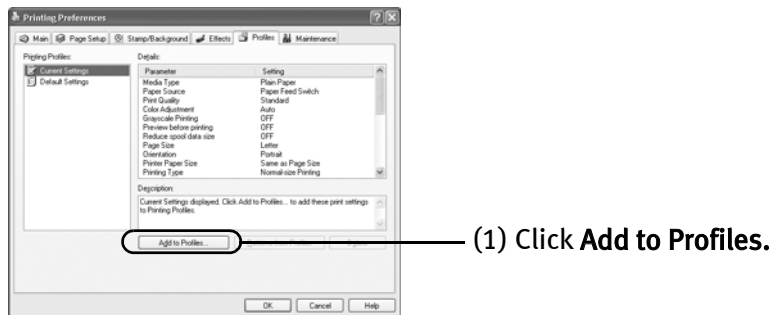

The **Add to Profiles** dialog box opens.

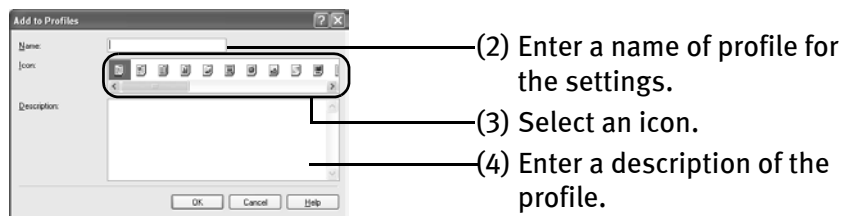

- 5 Click **OK**.
- 6 Click **OK** on the **Profiles** tab.
This registers your printer driver print settings.

-  **Note** You can retrieve or delete the print settings profile at any time.
- **Retrieving profile:**
Select the desired profile from **Printing Profiles**, and click **Retrieve** from **Profiles**.
 - **Deleting unwanted profile:**
Select the desired profile from **Printing Profiles**, and click **Delete**.
For details, click **Help** and refer to the topic of this function.

Macintosh

- 1** Open the **Print** dialog box.
See “Printing with Macintosh” on page 18.
- 2** Set all necessary items.
- 3** Register new printer driver settings.



(1) Select **Save As** from **Presets**.

The **Save Preset** dialog box opens.

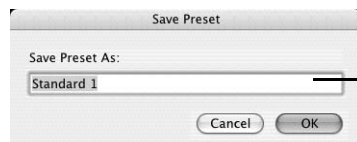

(2) Enter a name for your settings.

- 4** Click **OK**.
This registers your printer driver settings.

-  **Note** You can retrieve or change the saved driver settings at any time.
- **Retrieving the registered driver settings:**
Select the name of the driver settings to retrieve from **Presets** in the **Print** dialog box.
 - **Changing the registered drivers settings:**
Select the name of the driver settings to delete or change from **Presets** in the **Print** dialog box.

Using the Bundled Software

The *Setup Software & User's Guide CD-ROM* includes photo applications designed to edit the photographs taken by a digital camera and print them as photo-lab quality prints without standard white borders. Please use the application(s) suitable for your print purposes.

-  **Note**
- To install applications, refer to the *Setup Guide*.
 - For details about using the photo applications, refer to the *Photo Application Guide* included on the *Setup Software & User's Guide CD-ROM*.

■ Easy-PhotoPrint (Windows/Macintosh)

You can make a Borderless Print easily and quickly, just by selecting a photograph taken with a digital camera and the paper type on which to print. Also it has tools to correct red eye caused by the camera's flash or smooth and beautify the facial skin. It is compatible with ExifPrint*.

■ PhotoRecord (Windows)

You can create fun and unique photo albums with the decorative themes such as frame, background, and clip-art. You can also copy or move the decorated photos.

It is compatible with ExifPrint*.

■ Easy-WebPrint (Windows)

You can easily print out homepages displayed on Internet Explorer in full size without its right-hand side being cropped. This application is automatically added to the Internet Explorer toolbar. Internet Explorer 5.5. or later must be installed.

For more information on the applications, refer to the *Photo Application Guide*.

* ExifPrint is the worldwide standard. Under ExifPrint, the digital camera can record data tags for specific camera settings and functions such as whether the flash was on or off, if the camera was in portrait or night scene mode, etc. Canon BJ Printers support ExifPrint and use a suitable photo application to read the camera data precisely, producing optimal prints. This enables you to create prints that reproduce color more accurately.

Printing Borderless Photographs

This section describes how to print from Easy-PhotoPrint using the Borderless Printing mode. Easy-PhotoPrint is included on your *Setup Software & User's Guide CD-ROM*.

Note Media Types Suitable for Borderless Printing

- The following media are compatible with **Borderless Printing**:
 - Photo Paper Pro (Letter and 4" x 6")
 - Photo Paper Plus Glossy (Letter, 5" x 7", and 4" x 6")
 - Photo Paper Plus Double Sided (Letter and 5" x 7")
 - Photo Paper Plus Semi-gloss (Letter and 4" x 6")
 - Matte Photo Paper (Letter)
 - Glossy Photo Paper (Letter, 4" x 6", and 2.13" x 3.39")
- Printing on paper other than the above may cause improper paper feeding, may deteriorate the print quality or may produce prints in different color tones.
- Selecting the wrong media type may affect the colors or cause printing to slow down.
To ensure optimum printing results, select the correct media type that matches the paper you are loading in the printer.
- **Borderless Printing** may not assure high print quality on the edges of the print or may cause the edges of the print blurred.

Follow the steps below to produce color prints of digital camera photographs with Easy-PhotoPrint using the **Borderless Printing** function. Easy-PhotoPrint supports ExifPrint. Easy-PhotoPrint can handle only JPEG files (file name extension: .jpg and .jpeg).

You can edit images taken with a digital camera by using the **Red-Eye Correction** function and **Digital Face Smoothing** function and print them with Easy-PhotoPrint. For more information about Easy-PhotoPrint, refer to the *Photo Application Guide*.

This section provides the procedure for printing out photographs under Windows. The procedure is the same with Macintosh.

- 1** Turn on the printer.
See "Turning on the Printer" on page 2.
- 2** Load the paper on the printer.
See "Loading Paper" on page 3.

3 Ensure that the proper paper source is selected.

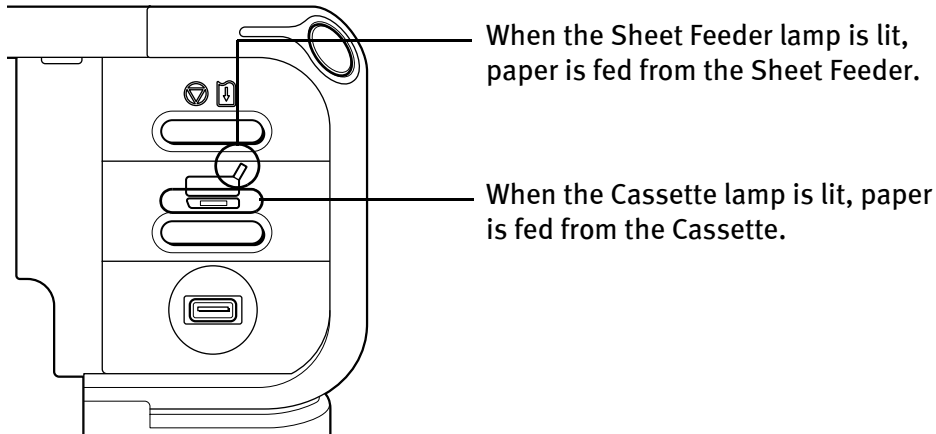

4 Start Easy-PhotoPrint.

This section describes how to print out photographs stored in the folder on the hard disk.

- (1) Store the photographs you took with your digital camera in a folder on the hard disk.
- (2) In Windows, click **Start**, select **All Programs** (or **Programs**), **Canon Utilities**, **Easy-PhotoPrint**, and **Easy-PhotoPrint** to open the Easy-PhotoPrint.
In Macintosh, double-click the hard disk icon, the **Applications** folder, the **Easy-PhotoPrint** folder, and then double-click the **Easy-PhotoPrint** icon.

5 Select photographs.

- (1) Select the folder containing the photograph you want to print.
All photographs in the selected folder are displayed.



Advanced Printing

- (2) Click the [▼] [▲] buttons on the thumbnail of the photograph you want to print to specify the number of copies.

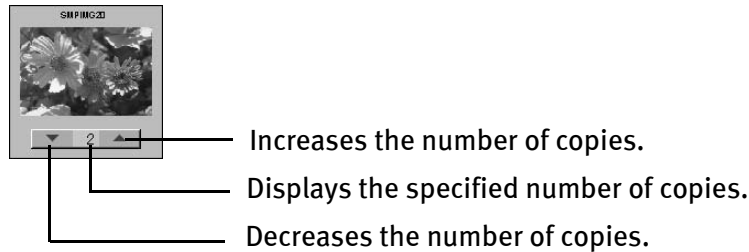

 **Note** Clicking **Correct/Enhance** corrects photographs. For example, using this feature, you can correct the red-eye caused by the camera's flash or smooth and beautify the facial skin. For more information, refer to the *Photo Application Guide*.

6 Select the paper.

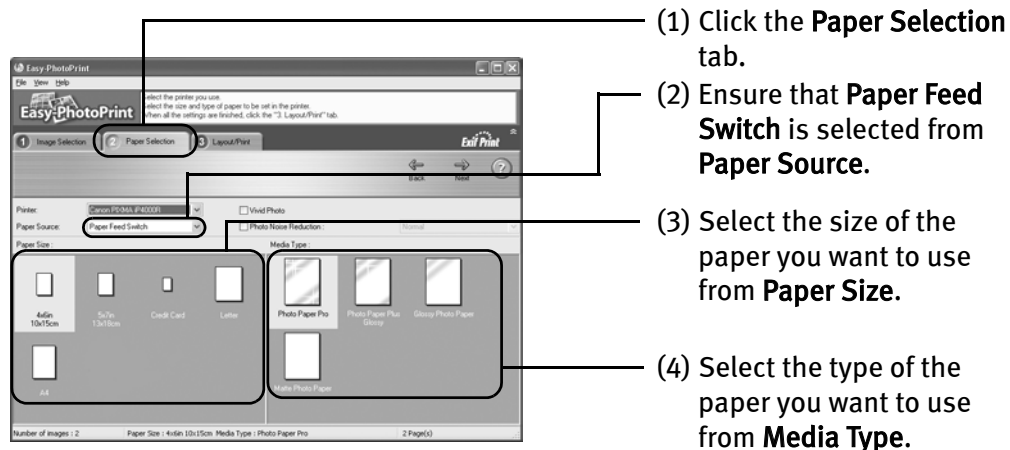

 **Note** This section only describes the steps when you have selected **Paper Feed Switch** from **Paper Source**. For information about the other settings, refer to "Changing the Paper Source" in the *User's Guide*.

7 Select the layout and print the photograph.



(1) Click the **Layout/Print** tab.

(2) Select **Borderless (full)**.

(3) In Windows, click **Print**.
In Macintosh, click **Print**.
When the confirmation message is displayed, click **OK**. And then, click **Print** in the **Print** dialog box.

Printing Maintenance

Replacing an Ink Tank

When replacing an ink tank, check the model number very carefully. The printer will not print properly if the wrong ink tank is used, or installed in the incorrect position.

With your printer, ink tanks must be installed in the order of left to right as indicated below.

- Black: BCI-6BK



- Black: BCI-3eBK



- Yellow: BCI-6Y



- Magenta: BCI-6M



- Cyan: BCI-6C



■ Knowing When to Replace Ink Tank

If an ink tank needs replacing, the **POWER** lamp will change from green to orange and flash four times, as soon as printing begins. It is important to quickly identify the empty tank using the **BJ Status Monitor** (Windows) or error messages (Macintosh) and replace it.

 **Note** Should missing characters or white streaks appear despite sufficient ink levels, refer to “When Printing Becomes Faint or Colors are Incorrect” on page 48.

Windows

The following message appears when ink is empty. Printing will resume as soon as ink tank is replaced and the Inner Cover and the Top Cover are closed.

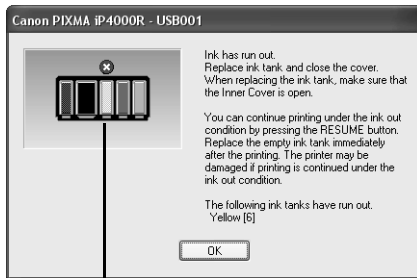

Empty ink tank

The ink tank with [X] symbol is out of ink. Replace with a new ink tank.

- Press the **RESUME/CANCEL** button to resume printing with an empty ink tank. When printing is finished, replace the ink tank immediately. If you continue printing with an empty ink tank, it may cause problems.
- Menu screens will vary to some degree, depending on your operating system.

Note When Low Ink is Detected

The **BJ Status Monitor** appears as soon as a print job starts. [!] indicates a low ink level. Obtain a replacement tank as soon as possible.



Tank with low ink level

Printing Maintenance

Macintosh

The following message is displayed when ink tank is empty. Printing will resume as soon as ink tank is replaced and the Inner Cover and the Top Cover are closed.

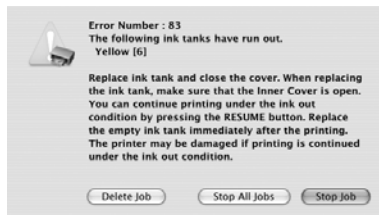

- Press the **RESUME/CANCEL** button to resume printing with the ink tank empty. When printing is finished, replace the ink tank immediately. If you continue printing with an empty ink tank, it may cause problems.
- If you click:
 - Delete Job**, the printer cancels the current printing job.
 - Stop Job**, the printer stops the current printing job.
 - Stop All Jobs**, the printer stops all printing jobs.

Note Checking the ink level

- (1) Double-click the hard disk icon where the printer driver was installed, the **Applications** folder, and then the **Utilities** folder.
 - (2) Double-click the **Printer Setup Utility** icon.
When using Mac OS X v.10.2, double-click the **Print Center** icon.
 - (3) Select the name of your printer from the **Name** list and click **Utility**.
When using Mac OS X v.10.2, select the name of your printer from the **Name** list and click **Configure**.
 - (4) Select the name of your printer from the **Product** list and click **Maintenance**.
BJ Printer Utility appears.
 - (5) Select **Ink level Information** from the pop-up menu.
- [!] indicates a low ink level. Obtain a replacement tank as soon as possible.
Click **About Ink** to show the ink tanks that are available on your printer.

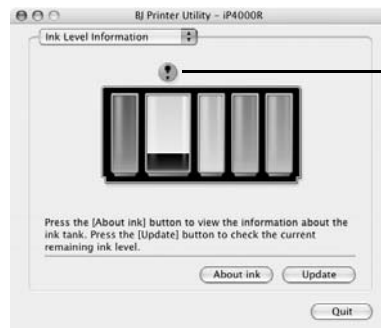

Tank with low ink level

■ Replacing Ink Tanks

When an ink tank runs out of ink, replace it using the following steps.

- 1** Ensure that the printer is on, and then push the upper center (⊙ ⊙ ⊙) of the Front Cover to open the Paper Output Tray.
- 2** Open the Top Cover, and pull down the Inner Cover forward to open. The Print Head Holder moves to the center.
- 3** Remove the empty ink tank.

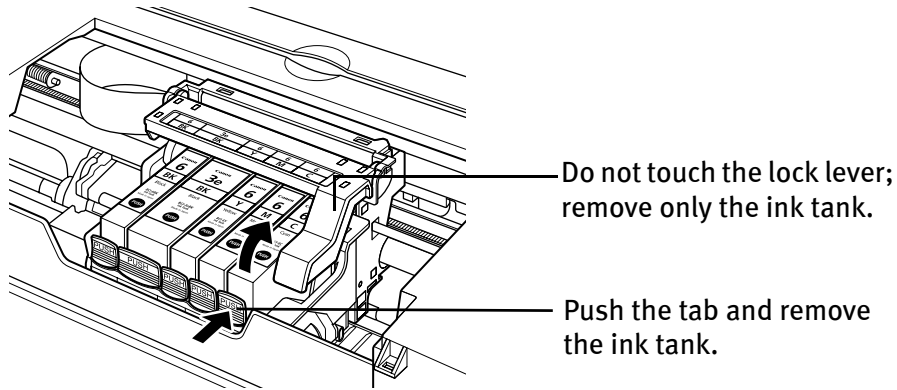

- Important**
- Handle ink tanks carefully to avoid staining clothing or the surrounding area.
 - Discard empty ink tanks according to the local laws and regulations regarding disposal of consumables.

Note Be sure to replace ink tanks one by one when replacing more than one ink tank.

4 Prepare a replacement tank.

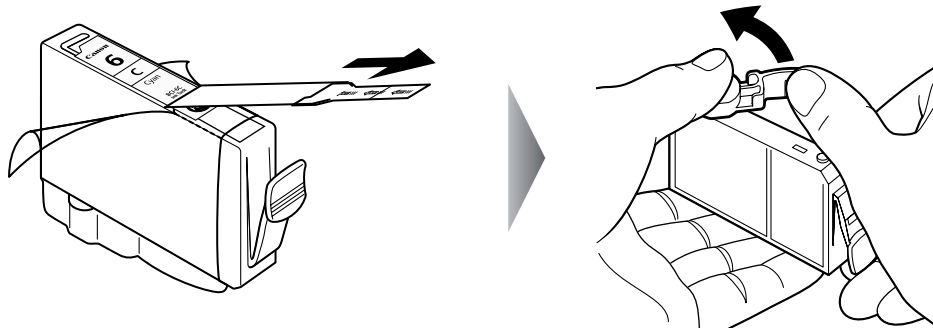

- (1) Unpack the new ink tank and pull off the orange tape. Then, remove the film.
- (2) Remove the orange protective cap from the bottom of the ink tank and discard it.

- Important**
- Be sure to remove the clear film from the ink tank in the exact order shown in step 4-(1), as failure to follow this step may cause the ink to leak and stain your clothes and hands.
 - Do not squeeze the side of ink tanks as this may cause the ink to leak out and stain your clothes and hands.
 - Do not re-attach the protective cap once you have removed it.
 - Once the protective cap is removed, do not touch the open ink port.
 - Ensure that all the orange tape has been peeled off along the perforation. If there remains a part of the orange tape, ink may not be ejected correctly.

5 Insert the ink tank.

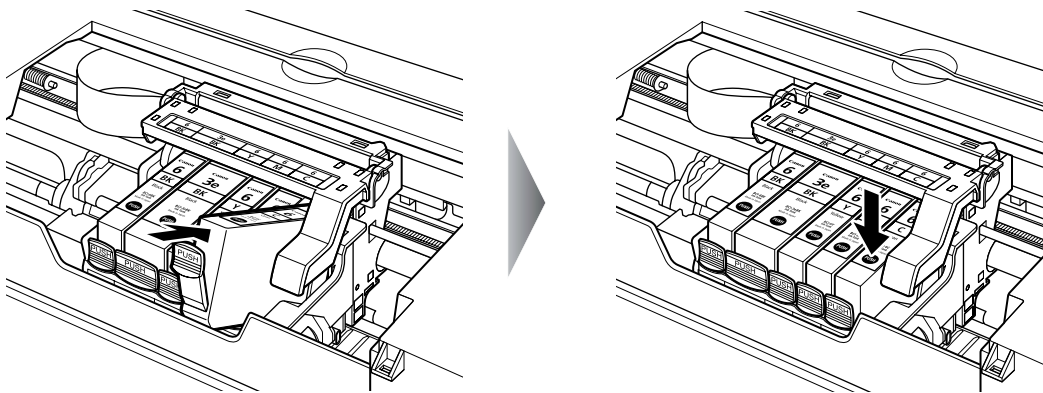

- (1) Insert the ink tank into the Print Head.
- (2) Press on the  mark on the ink tank until the ink tank snaps firmly into place.

6 Close the Inner Cover and the Top Cover.

The Print Head Holder moves to the right. The ink tank installation process is now complete.

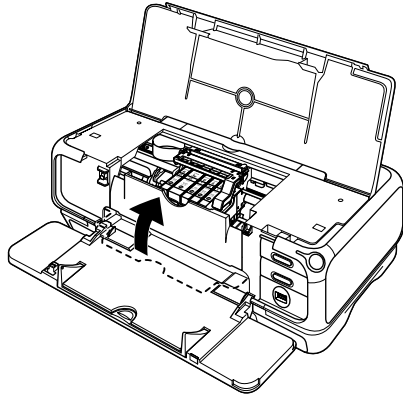

-  **Note**
- Ensure that the Inner Cover is closed. Printing will not occur if the Inner Cover is open.
 - To maintain optimal print quality, use an ink tank within six months of its first use.
 - Once an ink tank has been used, do not remove it from the printer and leave it out in the open. This will cause the ink tank to dry out and the printer may not operate properly if it is reinstalled.
 - Color ink consumption may occur even when black-and-white or grayscale printing is specified. Color ink is consumed in the head cleaning and deep cleaning, which are necessary to maintain the printer's capabilities.
 - When you start printing after replacing the ink tank, the printer executes **Print Head Cleaning** automatically. Do not perform any other operations until the **Print Head Cleaning** finishes. The **POWER** lamp flashes during cleaning.

When Printing Becomes Faint or Colors are Incorrect

When printing becomes faint or colors are incorrect, even if ink remains in the ink tanks, the Print Head nozzles are probably clogged. Follow the procedures below to clean the nozzles.

If the ruled lines are shifted after running the print head maintenance, align the Print Head.

Important Before printing the nozzle check pattern or cleaning the Print Head, check the following;

- Open the Top Cover, and make sure that the ink tank contains ink. If it is out of ink, replace it.
- Ensure that all the orange tape of the ink tank has been peeled off.
- Press on the **PUSH** mark on the ink tank and ensure that the ink tank is installed securely.
- Ensure that each ink tank is installed at the correct location.
- Increase the **Print Quality** setting in the printer driver settings. See “Print Quality is Poor or Contains Errors” on page 67.

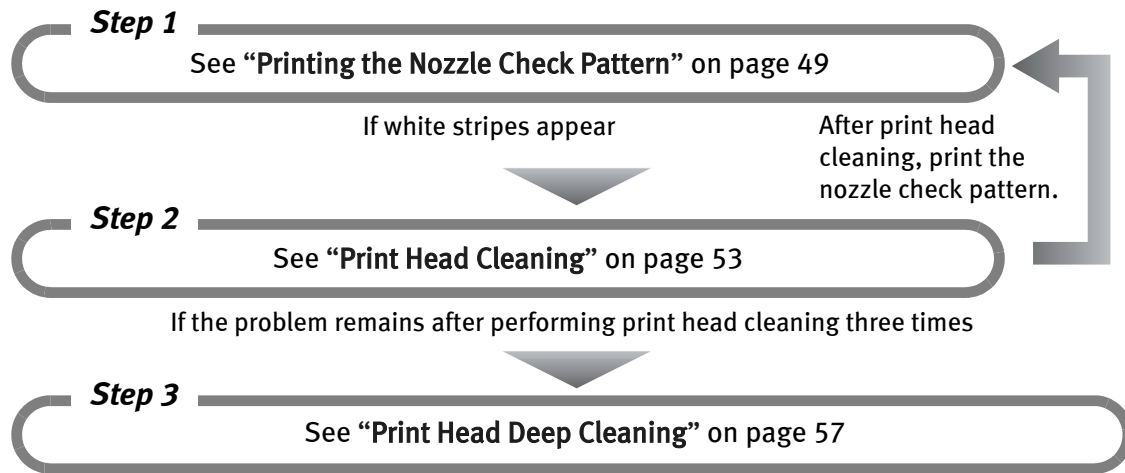

Note If **Print Head Deep Cleaning** does not resolve the problem, contact the Customer Care Center.

- If the ruled lines are shifted



Printing the Nozzle Check Pattern

Print the nozzle check pattern to determine whether the ink ejects properly from the Print Head nozzles. Use this function when printed results are blurred or the color is incorrect.

 **Note** ● Ensure that the Inner Cover is closed.

Printing the Nozzle Check Pattern Without a Computer

- Nozzle check pattern printing can also be executed from the printer itself.
 1. With the printer on, load a sheet of Letter-sized plain paper in the Sheet Feeder or Cassette.
 2. Press the Paper Feed Switch to select the paper source in which you loaded the paper.
 3. Hold down the **RESUME/CANCEL** button until the **POWER** lamp flashes twice.

■ Printing the Nozzle Check Pattern

Windows

- 1** With the printer on, load a sheet of Letter-sized plain paper in the Sheet Feeder or Cassette.
- 2** Press the Paper Feed Switch to select the paper source in which you loaded the paper.
- 3** Open the printer properties dialog box.
See “Opening the Printer Properties Dialog Box Directly from the Start Menu” on page 28.

Printing Maintenance

4 Print the Nozzle Check Pattern.

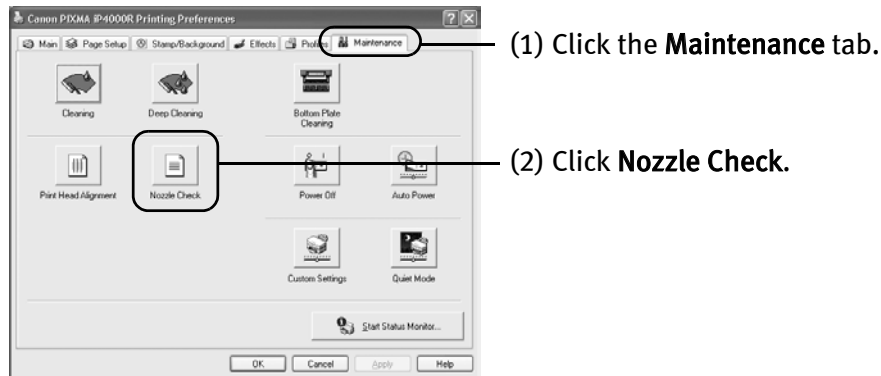

(3) Read the message and click **Print Check Pattern**.

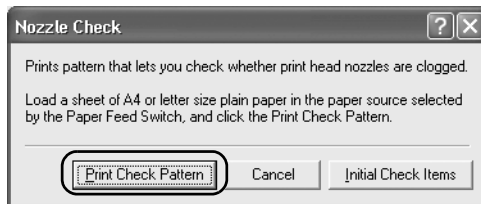

The nozzle check pattern will be printed.

 **Note** Clicking **Initial Check Items** displays the items to be checked before cleaning.

(4) When the confirmation message is displayed, click **OK**.

(5) Ensure that the pattern is printed properly.

See “**Examining the Nozzle Check Pattern**” on page 52.

(6) If you want to start **Print Head Cleaning**, click **Cleaning** on the **Pattern Check** dialog box. Otherwise, click **Exit** to finish.

Macintosh

1 With the printer on, load a sheet of Letter-sized plain paper in the Sheet Feeder or Cassette.

2 Press the Paper Feed Switch to select the paper source in which you loaded the paper.

3 Open the **BJ Printer Utility** dialog box.

- (1) Double-click the hard disk icon where the printer driver was installed, the **Applications** folder, and then the **Utilities** folder.
- (2) Double-click the **Print Setup Utility** icon.
When using Mac OS X v.10.2, double-click the **Print Center** icon.
- (3) Select the name of your printer from the **Name** list and click **Utility**.
When using Mac OS X v.10.2, select the name of your printer from the **Name** list and click **Configure**.
- (4) Select the name of your printer from the **Product** list and click **Maintenance**.

4 Print the Nozzle Check Pattern.

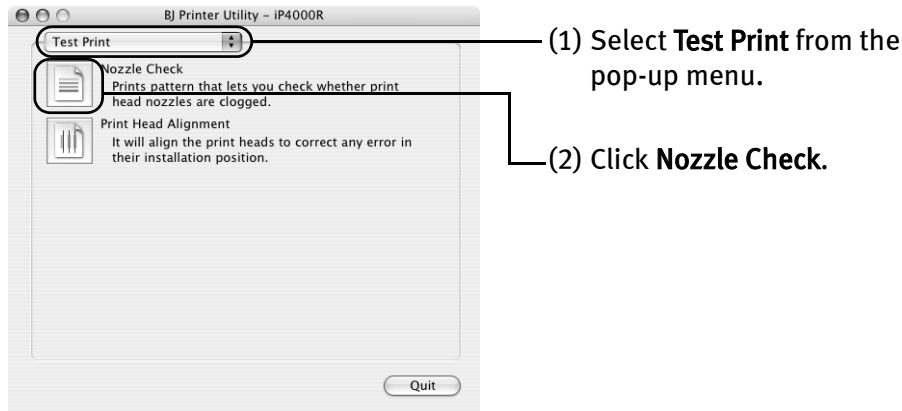

- (3) Read the message and click **Print Check Pattern**.

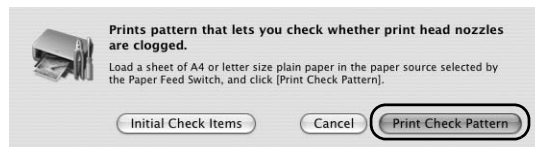

The nozzle check pattern will be printed.

Note Clicking **Initial Check Items** displays the items to be checked before cleaning.

- (4) Ensure that the pattern is printed properly.
See “**Examining the Nozzle Check Pattern**” on page 52.
- (5) If you want to start **Print Head Cleaning**, click **Cleaning** on the **Pattern Check** dialog box. Otherwise, click **Quit** to finish.

Printing Maintenance

■ Examining the Nozzle Check Pattern

The nozzle check pattern should appear as follows when ink is discharged properly. Examine the nozzle check pattern output by the printer.

 **Note** The nozzle check pattern will not be printed correctly if there is not enough ink. Replace the ink tank if the remaining amount of ink is insufficient.
See “Replacing an Ink Tank” on page 42.

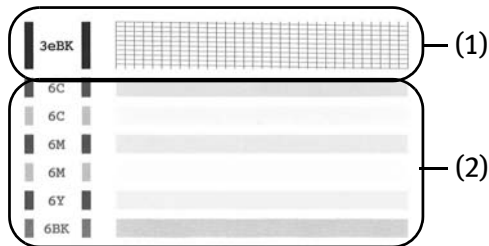

(1) If lines of this pattern are missing, the “**Black**” print head nozzle needs cleaning.

Example: When lines are missing

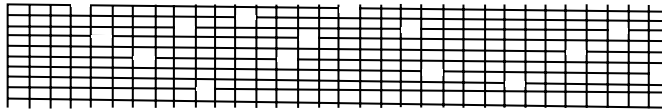

(2) If these patterns have white stripes, the “**Color**” print head nozzle needs cleaning.

Example: When white stripes appear



Click **Cleaning** in the **Pattern Check** dialog box to start **Print Head Cleaning**.
See “Print Head Cleaning” on page 53.

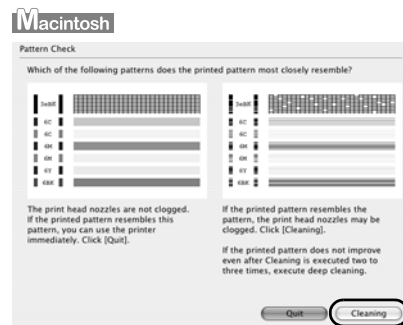
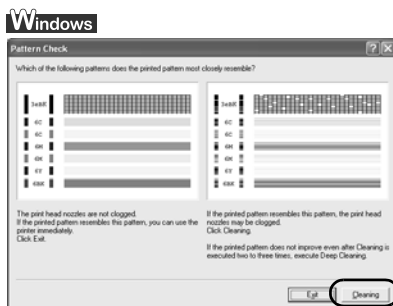

If no lines of the group (1) pattern are missing, and the group (2) patterns have no white stripes, click **Exit** or **Quit**. **Nozzle Check Pattern** finishes.

Print Head Cleaning

Clean the Print Head if missing lines or white stripes appear in the nozzle check pattern. Note that cleaning the Print Head causes waste ink to be absorbed in the waste ink absorber. Cleaning the Print Head consumes ink, so perform **Print Head Cleaning** only when necessary.

 **Note** ● Ensure that the Inner Cover is closed.

Cleaning the Print Head Without a Computer

● The Print Head can also be cleaned from the printer itself. With the printer on, hold down the **RESUME/CANCEL** button until the **POWER** lamp flashes once.

Windows

 **Note** The **Print Head Cleaning** dialog box of step 3-(3) is directly displayed when you click **Cleaning** on the **Pattern Check** dialog box. See “**Examining the Nozzle Check Pattern**” on page 52.

1 Ensure that the printer is on.

2 Open the printer properties dialog box.

See “**Opening the Printer Properties Dialog Box Directly from the Start Menu**” on page 28.

3 Start Print Head Cleaning.

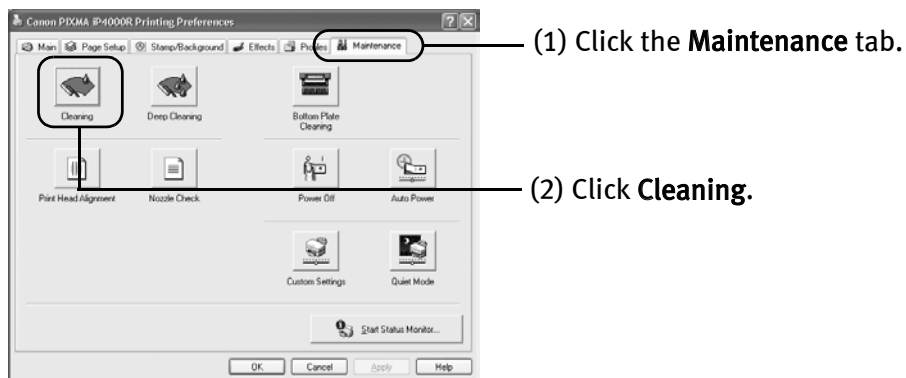

Printing Maintenance

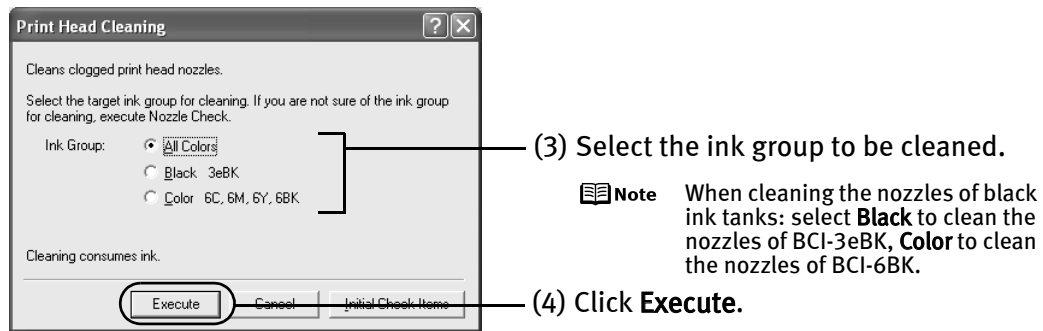

Print Head Cleaning starts when the **POWER** lamp starts blinking.

Important Do not perform any other operations until the **Print Head Cleaning** finishes. This takes about 30 to 40 seconds.

Note Clicking **Initial Check Items** displays the items to be checked before cleaning.

(5) When the confirmation message is displayed, click **OK**.

(6) Read the message and click **Print Check Pattern** to print the nozzle check pattern.
The nozzle check pattern is printed.

4 Check the Print Head condition with the printed nozzle check pattern.

See “Printing the Nozzle Check Pattern” on page 49.

- Note**
- The nozzle check pattern will not be printed correctly if there is not enough ink. Replace the ink tank if the remaining amount of ink is insufficient.
See “Replacing an Ink Tank” on page 42.
 - If the problem remains after performing **Print Head Cleaning** three times, try **Print Head Deep Cleaning**.
See “Print Head Deep Cleaning” on page 57.

Macintosh

Note The **Print Head Cleaning** dialog box of step 3-(3) is directly displayed when you click **Cleaning** on the **Pattern Check** dialog box.
See “Examining the Nozzle Check Pattern” on page 52.

1 Ensure that the printer is on.

2 Open the **BJ Printer Utility** dialog box.

- (1) Double-click the hard disk icon where the printer driver was installed, the **Applications** folder, and then the **Utilities** folder.
- (2) Double-click the **Printer Setup Utility** icon.
When using Mac OS X v.10.2, double-click the **Print Center** icon.
- (3) Select the name of your printer from the **Name** list and click **Utility**.
When using Mac OS X v.10.2, select the name of your printer from the **Name** list and click **Configure**.
- (4) Select the name of your printer from the **Product** list and click **Maintenance**.

3 Start Print Head Cleaning.

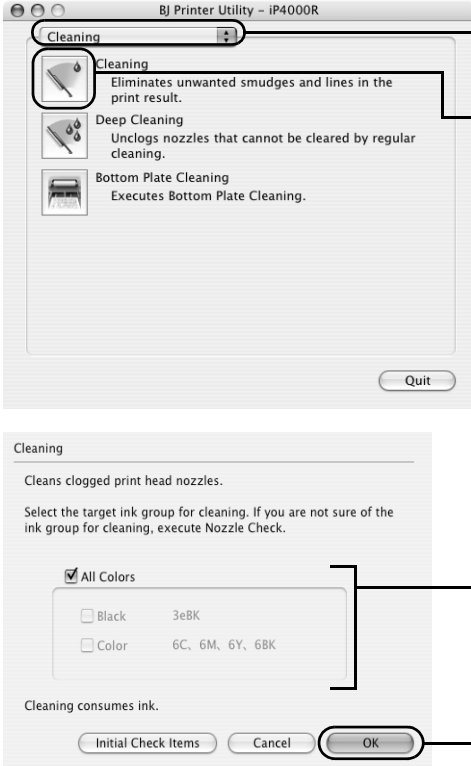

The image shows two screenshots of the BJ Printer Utility dialog box. The top screenshot shows the 'Cleaning' menu with three options: 'Cleaning', 'Deep Cleaning', and 'Bottom Plate Cleaning'. The bottom screenshot shows the 'Cleaning' dialog box with a list of ink groups: 'All Colors' (checked), 'Black 3eBK', and 'Color 6C, 6M, 6Y, 6BK'. The 'OK' button is highlighted.

(1) Ensure that **Cleaning** is selected from the pop-up menu.

(2) Click **Cleaning**.

(3) Select the ink group to be cleaned.

Note When cleaning the nozzles of black ink tanks: select **Black** to clean the nozzles of BCI-3eBK, **Color** to clean the nozzles of BCI-6BK.

(4) Click **OK**.

Printing Maintenance

Print Head Cleaning starts when the **POWER** lamp starts blinking.

 **Important** Do not perform any other operations until the **Print Head Cleaning** finishes. This takes about 30 to 40 seconds.

 **Note** Clicking **Initial Check Items** displays the items to be checked before cleaning.

(5) Read the message and click **Print Check Pattern** to print the nozzle check pattern.
The nozzle check pattern is printed.

4 Check the Print Head condition with the printed nozzle check pattern.

See “Printing the Nozzle Check Pattern” on page 49.

-  **Note**
- The nozzle check pattern will not be printed correctly if there is not enough ink. Replace the ink tank if the remaining amount of ink is insufficient.
See “Replacing an Ink Tank” on page 42.
 - If the problem remains after performing **Print Head Cleaning** three times, try **Print Head Deep Cleaning**.
See “Print Head Deep Cleaning” on page 57.

Print Head Deep Cleaning

If print quality does not improve by standard **Print Head Cleaning**, try **Print Head Deep Cleaning**, which is a more powerful process. Note that cleaning the Print Head causes waste ink to be absorbed in the waste ink absorber. **Print Head Deep Cleaning** consumes more ink than standard Print Head Cleaning, so perform this procedure only when necessary.

 **Note** Ensure that the Inner Cover is closed.

Windows

- 1 Ensure that the printer is on.
- 2 Open the printer properties dialog box.

See “Opening the Printer Properties Dialog Box Directly from the Start Menu” on page 28.

- 3 Start Print Head Deep Cleaning.

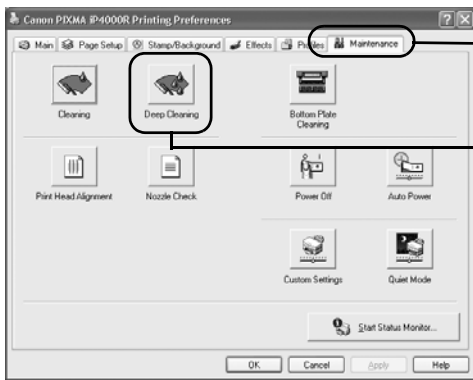

(1) Click the **Maintenance** tab.

(2) Click **Deep Cleaning**.

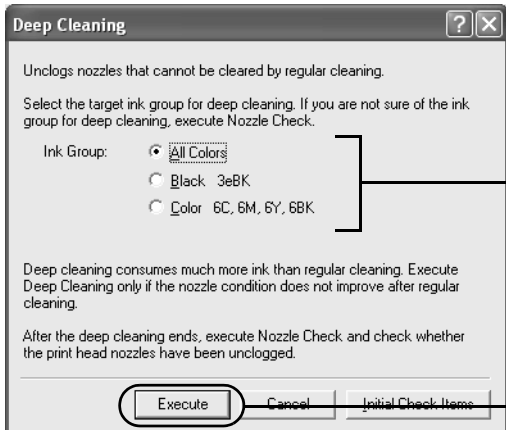



(3) Select the ink group to be deeply cleaned.

Note When cleaning the nozzles of black ink tanks: select **Black** to clean the nozzles of BCI-3eBK, **Color** to clean the nozzles of BCI-6BK.

(4) Click **Execute**.

Printing Maintenance

Print Head Deep Cleaning starts when the **POWER** lamp starts blinking.

-  **Important** Do not perform any other operation until the **Print Head Deep Cleaning** finishes. This takes about one minute.
-  **Note** Clicking **Initial Check Items** displays the items to be checked before cleaning.

4 Print the nozzle check pattern to check the Print Head condition.

See “**Printing the Nozzle Check Pattern**” on page 49.

If a particular color is not printed properly, replace the ink tank of that color. See “**Replacing an Ink Tank**” on page 42.

-  **Note**
 - If the print head nozzles are still not clean, open the Top Cover and ensure that there are sufficient ink levels in all ink tanks and turn off the printer. Be sure to perform another **Print Head Deep Cleaning** 24 hours after turning off the printer.
 - If this does not solve the problem, the Print Head may be worn out. Contact the Customer Care Center.

Macintosh

1 Ensure that the printer is on.

2 Open the **BJ Printer Utility** dialog box.

- (1) Double-click the hard disk icon where the printer driver was installed, the **Applications** folder, and then the **Utilities** folder.
- (2) Double-click the **Printer Setup Utility** icon.
When using Mac OS X v.10.2, double-click the **Print Center** icon.
- (3) Select the name of your printer from the **Name** list and click **Utility**.
When using Mac OS X v.10.2, select the name of your printer from the **Name** list and click **Configure**.
- (4) Select the name of your printer from the **Product** list and click **Maintenance**.

3 Start Print Head Deep Cleaning.

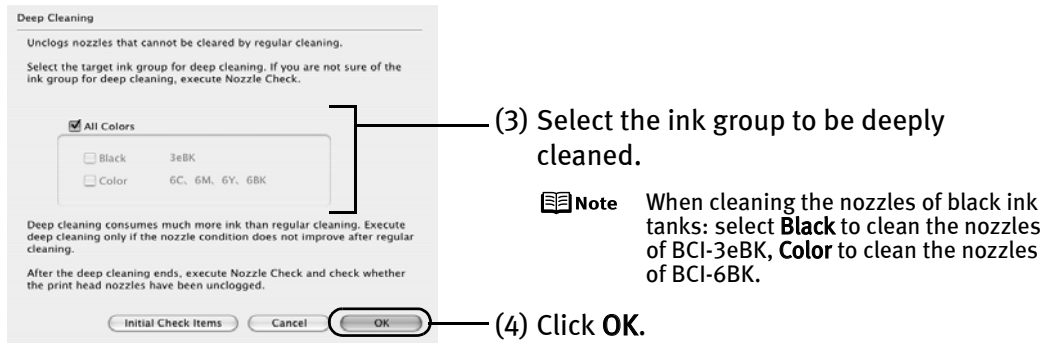
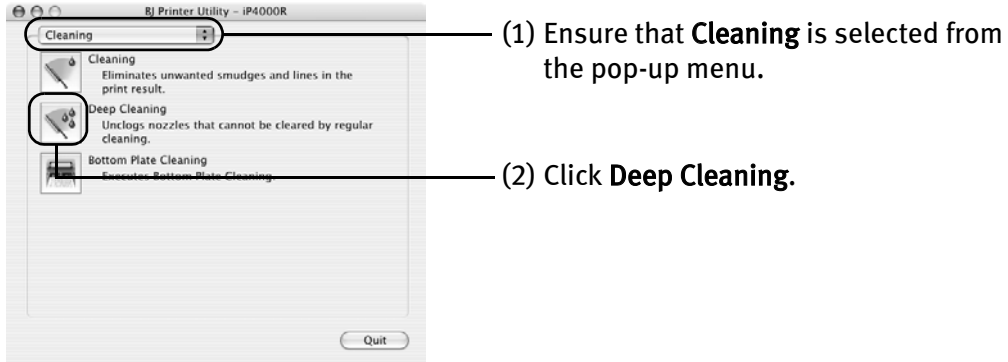

Print Head Deep Cleaning starts when the **POWER** lamp starts blinking.

Important Do not perform any other operation until the **Print Head Deep Cleaning** finishes. This takes about one minute.

Note Clicking **Initial Check Items** displays the items to be checked before cleaning.

4 Print the nozzle check pattern to check the Print Head condition.

See “Printing the Nozzle Check Pattern” on page 49.

If a particular color is not printed properly, replace the ink tank of that color. See “Replacing an Ink Tank” on page 42.

-  **Note**
- If the print head nozzles are still not clean, open the Top Cover and ensure that there are sufficient ink levels in all ink tanks and turn off the printer. Be sure to perform another **Print Head Deep Cleaning** 24 hours after turning off the printer.
 - If this does not solve the problem, the Print Head may be worn out. Contact the Customer Care Center.

Aligning the Print Head

This operation must be carried out when using the printer for the first time. Aligning the Print Head positions allows you to print without shifts in the color registration.

Print head alignment is performed either automatically or manually. This section deals with automatic Print Head alignment only.

 **Note** ● Ensure that the Inner Cover is closed.

Aligning the Print Head Without a Computer

- The Print Head can also be aligned from the printer itself.
 1. With the printer on, load a sheet of Letter-sized plain paper in the Sheet Feeder.
 2. Hold down the **RESUME/CANCEL** button until the **POWER** lamp flashes four times.

Windows

- 1** With the printer on, load a sheet of Letter-sized plain paper in the Sheet Feeder.
- 2** Open the printer properties dialog box.
See “Opening the Printer Properties Dialog Box Directly from the Start Menu” on page 28.
- 3** Print the pattern.

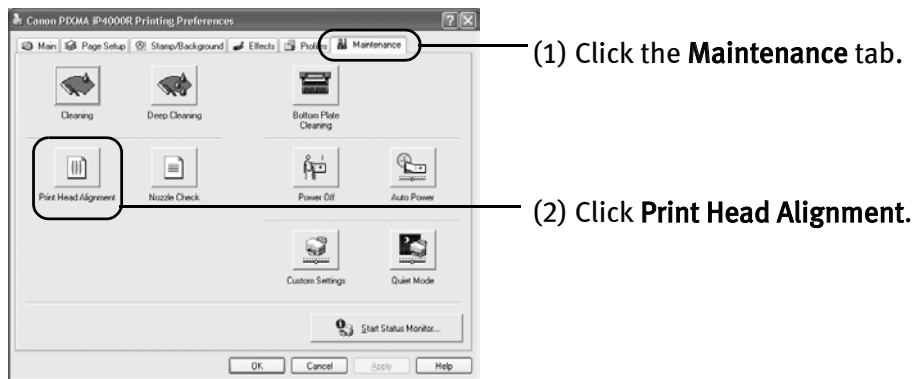

Printing Maintenance

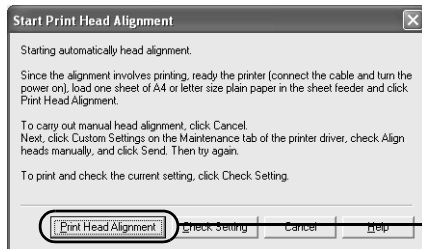

(3) Read the message and click **Print Head Alignment**.

 **Note** It takes about 80 seconds to start printing. Do not open the Top Cover while printing.

4 If a message warning you not to perform other operations is displayed, click **OK**.

5 Check the printed pattern.

If the pattern is printed as shown below, the Print Head is aligned automatically. The printer is now ready to use.

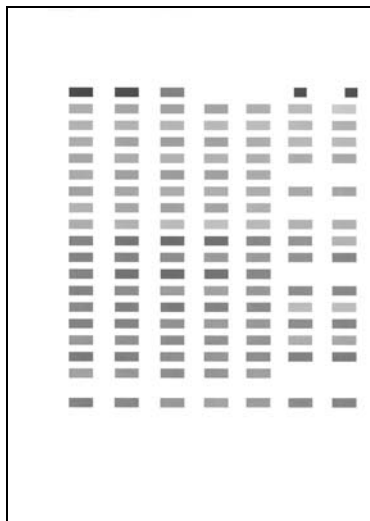

-  **Note**
- If the pattern is not printed successfully, open the Top Cover and Inner Cover, and ensure that the ink tanks are correctly installed.
 - If the pattern is still not printed successfully, refer to “Eleven flashes” in “**Handling Error Messages**” on page 75.
 - If results of Automatic Print Head Alignment are not satisfactory, refer to “Aligning the Print Head” in “Routine Maintenance” of the *User’s Guide* and align the Print Head manually.

Macintosh

- 1 With the printer on, load a sheet of Letter-sized plain paper in the Sheet Feeder.
- 2 Open the **BJ Printer Utility** dialog box.
 - (1) Double-click the hard disk icon where the printer driver was installed, the **Applications** folder, and then the **Utilities** folder.
 - (2) Double-click the **Printer Setup Utility** icon.
When using Mac OS X v.10.2, double-click the **Print Center** icon.
 - (3) Select the name of your printer from the **Name** list and click **Utility**.
When using Mac OS X v.10.2, select the name of your printer from the **Name** list and click **Configure**.
 - (4) Select the name of your printer from the **Product** list and click **Maintenance**.
- 3 Print the pattern.

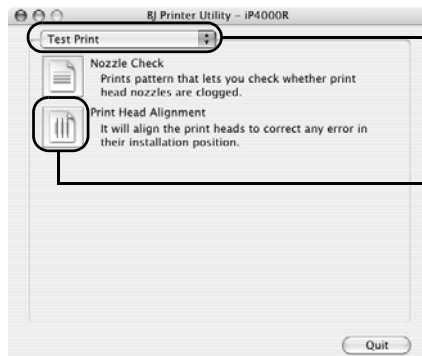

(1) Select **Test Print** from the pop-up menu.

(2) Click **Print Head Alignment**.

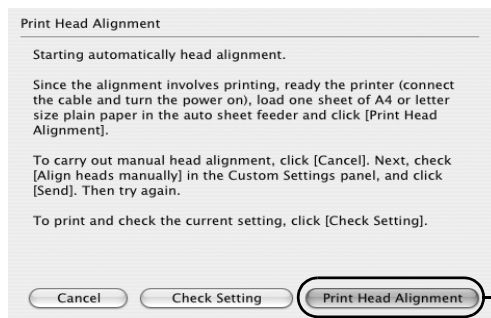



(3) Read the message and click **Print Head Alignment**.

Note It takes about 80 seconds to start printing. Do not open the Top Cover while printing.

4 Check the printed pattern.

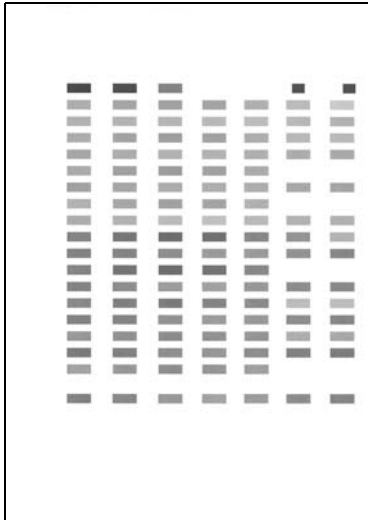
If the pattern is printed as shown below, the Print Head is aligned automatically. The printer is now ready to use.



-  **Note**
- If the pattern is not printed successfully, open the Top Cover and Inner Cover, and ensure that the ink tanks are correctly installed.
 - If the pattern is still not printed successfully, refer to “Eleven flashes” in “**Handling Error Messages**” on page 75.
 - If results of Automatic Print Head Alignment are not satisfactory, refer to “Aligning the Print Head” in “Routine Maintenance” of the *User’s Guide* and align the Print Head manually.

Troubleshooting

This section provides troubleshooting tips for the most common printing problems. Troubleshooting usually falls into one of the following categories.

- “Cannot Install the Printer Driver” on page 66
- “Print Quality is Poor or Contains Errors” on page 67
- “Troubleshooting Printer Hardware” on page 69
- “Paper Does Not Feed Properly” on page 71
- “Paper Jams” on page 72
- “Handling Error Messages” on page 75
- “An Error Message Appears on the Screen” on page 77
- “Cannot Print Properly from the Digital Camera” on page 81

Refer to the *User’s Guide* for additional information on topics not covered in this section.

Windows

When an Error Occurs

The **BJ Status Monitor** opens and displays a message when an error occurs. Take the appropriate action described in the message.

The message may vary depending on your operating system.

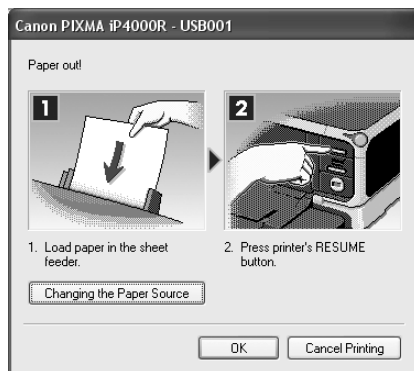

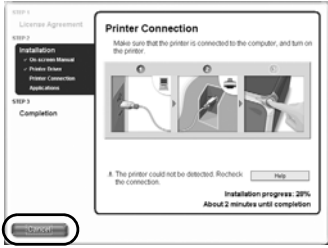

Cannot Install the Printer Driver

Problem	Possible Cause	Try This
Cannot Install the Printer Driver	Installation procedure not followed correctly	<p>Follow the <i>Setup Guide</i> packaged with your printer for proper printer driver installation.</p> <p>Windows</p> <p>If the installer was forced to be terminated due to an error, Windows may be unstable. Remove the CD-ROM from the CD-ROM drive and restart your computer. Reinstall the printer driver. If this problem persists, refer to your Windows documentation for more information.</p>
	Other applications (including anti-virus software) running in the background	<p>Other applications opened on your computer can interfere with the installation routine. Close all open software applications before reinstalling the printer driver. Refer to the <i>Setup Guide</i> for installing the printer driver.</p>
	Installation does not start automatically when the <i>Setup Software & User's Guide CD-ROM</i> is inserted into the drive	<p>Windows</p> <p>If the printer driver installation did not start automatically when you inserted the <i>Setup Software & User's Guide CD-ROM</i> into the CD-ROM drive:</p> <ol style="list-style-type: none"> 1. Click Start and select My Computer. 2. Double-click the CD-ROM icon. <p>For non-Windows XP, open the My Computer window, and then double-click the CD-ROM icon.</p> <p>Macintosh</p> <p>Double-click the CD-ROM icon on your desktop to start installation.</p>
	Installation CD-ROM is not working properly	<p>Ensure that there are no problems with the <i>Setup Software & User's Guide CD-ROM</i>.</p> <p>If there is any problem with the <i>Setup Software & User's Guide CD-ROM</i>, contact the Customer Care Center.</p> <p>Windows</p> <p>Use Windows Explorer to ensure that the CD-ROM can be read.</p> <p>Macintosh</p> <p>Ensure that the CD-ROM icon is displayed on the desktop.</p>
Unable to proceed beyond the Printer Port screen		<p>Windows</p>  <p>Reinstall the printer driver.</p> <ol style="list-style-type: none"> 1. Click Cancel on the Printer Connection screen. 2. Click Start Over on the Installation Failure screen. 3. Click Back on the screen which appears next. 4. Click Exit on the Welcome screen, then remove the CD-ROM. 5. Turn the printer and the computer off. 6. Check the cable connection. 7. Restart the computer. 8. Carefully follow the procedures described in the <i>Setup Guide</i> and reinstall the driver.

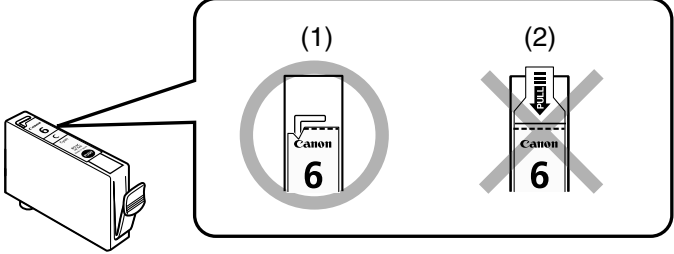
Print Quality is Poor or Contains Errors

Problem	Possible Cause	Try This
Ink does not eject properly/Printing is Blurred/Colors are Wrong/White Streaks appear	Ink tank is not seated properly/Ink tank is empty	<p>Check that the ink tanks are firmly seated in the Print Head and reseal them if necessary.</p> <p>Check that the correct ink tanks are installed and that they are in the correct order.</p> <p>Check to see if all the orange tape has been peeled off as shown in (1). If there remains a part of the orange tape as shown in (2), remove it thoroughly.</p>  <p>If ink tank is empty, replace the ink tank. See “Replacing an Ink Tank” on page 42.</p>
Print Head is misaligned		Align the Print Head. See “Aligning the Print Head” on page 61.
Print Head nozzles are clogged		Print the nozzle check pattern to check for uneven ink output. See “Printing the Nozzle Check Pattern” on page 49. See “Print Head Cleaning” on page 53.
Paper loaded wrong side up		Check the print side of the paper. Note Follow the instructions packaged with your specialty media for loading and handling.
Incorrect paper type		<p>Windows On the Main tab of the printer driver, confirm that the Media Type selected matches the paper loaded.</p> <p>Macintosh In the Print dialog box of the printer driver, select Quality & Media from the pop-up menu, and then confirm that the Media Type selected matches the paper loaded.</p>
Glossy photo paper other than the Canon specialty media is used		Select Other Photo Paper from Media Type . It may resolve the problem. Load one sheet at a time and remove each sheet as soon as it is printed.
Print Quality is not set properly		<p>Be sure to set the Print Quality setting to High in Windows, or Fine in Macintosh.</p> <p>Windows</p> <ol style="list-style-type: none"> 1. Open the printer properties dialog box. 2. On the Main tab, click High for the Print Quality setting. When you cannot choose the High setting or when the print quality does not improve, select Custom, click Set and then adjust the Quality bar for higher print quality. <p>Macintosh</p> <ol style="list-style-type: none"> 1. Open the Print dialog box. 2. Select Quality & Media from the pop-up menu and then click Detailed Setting. 3. Drag the Print Quality slide bar to the Fine end.

Troubleshooting

Problem	Possible Cause	Try This
Printed Paper Curls or Ink Blots	Paper being used is too thin	Use High Resolution Paper, Photo Paper Pro or other Canon specialty paper to print images that have high color saturation.
	Color Intensity setting is too high	Reduce the Intensity setting in the printer driver and try printing again. Windows 1. Open the printer properties dialog box. 2. On the Main tab, select Manual for Color Adjustment , and then click Set . 3. Drag the Intensity slide bar to adjust the intensity. Macintosh 1. Open the Print dialog box. 2. Select Color Options from the pop-up menu. 3. Drag the Intensity slide bar to set the intensity.
	Paper feed roller is dirty	Clean the paper feed roller. See “ Paper Does Not Feed Properly ” on page 71.
Back of Paper is Smudged	Inside of the printer is dirty	If the inside of the printer is dirty, printed paper may be smudged. Periodically clean the inside of the printer. See “ Cleaning the Inside of the Printer ” in the <i>User’s Guide</i> .
	Paper feed roller is dirty	Clean the paper feed roller. See “ Paper Does Not Feed Properly ” on page 71.
	Media is curled	If media is curled, its print side may be smudged by touching the Print Head. Hold the opposite corners of the media, and gently bend them in the opposite direction to uncurl the media.
Printed Surface is Scratched	Inappropriate paper type is used	Check to see if the paper you are printing on is too thick or curled. See “ Print Media to Avoid ” on page 3. Note that smudging may occur at the top and bottom edges of the paper when using Borderless Printing . Ensure that the paper you are using is compatible with Borderless Printing . See “ Media Types Suitable for Borderless Printing ” on page 38.
	Thick paper is used	Select the Prevent paper abrasion check box to widen the clearance between the Print Head and the loaded paper. Windows 1. Open the printer properties dialog box. 2. Click the Maintenance tab and then Custom Settings .  Important In Windows XP or Windows 2000 When not logged on as a computer administrator or Administrators, you cannot open the Custom Setting dialog box. For further information on how to log on as an administrator, refer to your Windows documentation. 3. Select the Prevent paper abrasion check box and click Send . Click OK when the confirmation message appears. Macintosh 1. Open the BJ Printer Utility dialog box. 2. Select Custom Settings from the pop-up menu. 3. Select Prevent paper abrasion . When Prevent paper abrasion is selected in the printer properties dialog box (Windows) or selected from Custom Settings in the BJ Printer Utility dialog box (Macintosh), the setting is also applied under direct printing with the digital camera.  Note Paper abrasion can be prevented by pressing the RESUME/CANCEL button on the printer. With the printer on, hold down the RESUME/CANCEL button until the POWER lamp flashes seven times. To cancel the setting, turn off the printer.

Troubleshooting Printer Hardware

Problem	Possible Cause	Try This
Printer Does Not Start or Printer Stops During Print Jobs	Print Head has overheated due to long periods of continuous printing	<p>Stop printing and turn the printer off for at least 15 minutes to allow the Print Head to cool down.</p> <p>The Print Head tends to overheat when printing continuously for long periods of time. The Print Head is designed to automatically pause at line breaks before resuming printing in order to cool down.</p> <p>▲ Caution The area around the Print Head can become extremely hot during extended print operation. Always avoid touching the Print Head and its peripheral components.</p>
	Printing high-resolution photographs and graphics	<p>Wait until the print job finishes.</p> <p>The POWER lamp flashes green while the print data is being processed. Printing photographs and high-density graphics can take time.</p>
	There may be problems with your operating system	<p>Restart your computer. It may solve the problem.</p> <p>Delete an undesired print job, if there is any. Use BJ Status Monitor in Windows or Printer Setup Utility (or Print Center) in Macintosh for the deletion.</p> <p>Windows</p> <ol style="list-style-type: none"> 1. Open the printer properties dialog box. See “Opening the Printer Properties Dialog Box Directly from the Start Menu” on page 28. 2. Click the Maintenance tab and then Start Status Monitor. 3. Click Display Print Queue. 4. Select Cancel All Documents in the Printer menu. <p>Note In Windows Me or Windows 98 Click to select an undesired document and select Purge Print Documents in the Printer menu.</p> <ol style="list-style-type: none"> 5. When the confirmation message is displayed, click Yes. The print job is deleted. <p>Note In Windows 2000, the print jobs may not be deleted.</p> <p>Macintosh</p> <ol style="list-style-type: none"> 1. Select Applications from the Go menu. 2. Double-click the Printer Setup Utility icon in the Utilities folder. When using Mac OS X v.10.2, double-click the Print Center icon. 3. Double-click the name of your printer displayed under Name in the Printer List. 4. Click to select an undesired document and click . The print job is deleted.
	Incorrect paper source is selected	<p>Ensure that Paper Feed Switch is selected from Paper Source (Windows) or the Print dialog box (Macintosh) in the printer driver. If Paper Feed Switch is selected, load paper in the paper source selected with Paper Feed Switch on the printer.</p> <p>If you select other settings, ensure that paper is loaded in the correct paper source.</p> <p>For a detailed description of the printer driver settings, refer to “Changing the Paper Source” in the <i>User's Guide</i>.</p>
Paper Output Tray is closed	Open the Paper Output Tray.	
Inner Cover is open	Close the Inner Cover and press the RESUME/CANCEL button.	

Troubleshooting

Problem	Possible Cause	Try This
Cannot Print to End of Job	Incorrect page size is selected	<p>Ensure that the page size setting matches the size of the paper loaded in the printer:</p> <ul style="list-style-type: none"> ● Check the Paper Size setting from within your application to ensure that it matches the size of the paper loaded. ● Check Paper Size on the Page Setup tab in the printer properties dialog box of the printer driver (Windows) or the Page Setup dialog box of the printer driver (Macintosh) to ensure that it matches the size of the paper loaded.
	There is not enough free space on the hard disk	Your operating system may be out of free disk space. Check the available space on your computer's hard disk.
	The size of the print data is too large	<p>Windows</p> <p>Check the size of the print data. For Windows XP and Windows 2000, if the size of the data is too large, part of it may be lost. When the spool format is EMF, follow the procedure below.</p> <ol style="list-style-type: none"> 1. Open the printer properties dialog box. 2. On the Main tab, click Print Options. 3. Select the Reduce spool data size check box, and click OK. <p> Note When Reduce spool data size is set, the print quality may be degraded.</p>
	Use reduced printing is not selected when performing automatic duplex printing	<p>In automatic duplex printing, the printable area at the top of the page is 2 mm/0.08 inches narrower than the usual area, therefore the bottom edge may not be printed. To prevent this, select Use reduced printing in the printer driver.</p> <p>Caution Print layout may be altered with the reduced printing function.</p> <p>Windows</p> <ol style="list-style-type: none"> 1. Open the printer properties dialog box. 2. Click Print Area Setup in the Page Setup tab and select Use reduced printing. <p>Macintosh</p> <ol style="list-style-type: none"> 1. In the Print dialog box, select Duplex Printing & Margin from the pop-up menu. 2. Select Automatic Duplex Printing, and select Use reduced printing in Print Area.

Paper Does Not Feed Properly

Problem	Possible Cause	Try This
Paper Does Not Feed Properly	Inappropriate paper type is used	Check to see if the paper you are printing on is too thick or curled. See “Print Media to Avoid” on page 3. Flatten paper when it is curled.
	Inner Cover is open	Close the Inner Cover and press the RESUME/CANCEL button. Ensure that the Inner Cover is completely closed, since if it is not, you cannot print because the paper will not feed properly.
	Paper Feed Roller is dirty	Follow the steps described below to clean the Paper Feed Rollers. <ol style="list-style-type: none"> 1. Ensure that the printer is on and there is no paper loaded in the printer. 2. Select the Paper Feed Roller of the Sheet Feeder or Cassette by pressing the Paper Feed Switch on the printer. 3. Hold down the RESUME/CANCEL button and release after the POWER lamp flashes three times. The Paper Feed Roller rotates as it cleans. 4. Repeat this cleaning operation twice. 5. Load three or more sheets of Letter-sized plain paper lengthways in the Sheet Feeder or Cassette selected in step 2. 6. Hold down the RESUME/CANCEL button and release after the POWER lamp flashes three times. Paper is fed and output. 7. Repeat this operation three times. If the printer still does not feed the paper properly through the printer, even after the cleaning operation, repeat the procedure.
	There are foreign objects inside the Sheet Feeder or Cassette	If a foreign object, such as a paper clip or a pencil, has fallen into the printer, turn off the printer and unplug the power cord from the power outlet before you try to remove it. If you are unable to remove it easily, contact the Customer Care Center.
	Paper is loaded incorrectly	Ensure that paper is loaded correctly. Slide the paper guides against the paper stack, and check to see if the paper is not loaded beyond the Load Limit Mark. See “Loading Paper” on page 3 and “Canon Specialty Media” on page 14.

Paper Jams

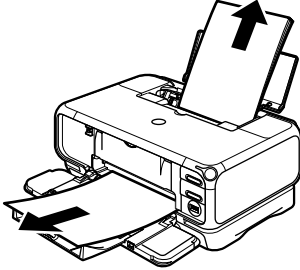
Problem	Possible Cause	Try This
Paper Jams	Paper jams in the Paper Output Slot	<p>Remove the paper according to the following procedure.</p> <ol style="list-style-type: none"> 1. Slowly pull the paper out from the Paper Output Slot.  <ul style="list-style-type: none"> • If the paper is jammed in the Sheet Feeder, slowly pull the paper out from the Sheet Feeder. • If you cannot pull the paper out, turn the printer off, and then turn it back on. The paper will be ejected automatically. <ol style="list-style-type: none"> 2. If you cannot pull the paper out in step 1, or the paper tears and a piece remains inside the printer, open the Top Cover and remove it. After removing all paper, close the Top Cover. <p>▲ Caution Be careful not to touch the components inside the printer.</p> <ol style="list-style-type: none"> 3. Reload the paper into the printer and press the RESUME/CANCEL button on the printer. <p>Note When reloading the paper into the printer, refer to “Paper Does Not Feed Properly” on page 71 to confirm that you are using the correct paper and are loading it into the printer correctly.</p> <p>If you have turned off the printer in step 1, you will need to retry printing, because this operation cancels any print jobs in progress.</p> <p>If you cannot remove the paper or the paper tears inside the printer, or if the paper jam error continues after removing the paper, contact the Customer Care Center.</p>

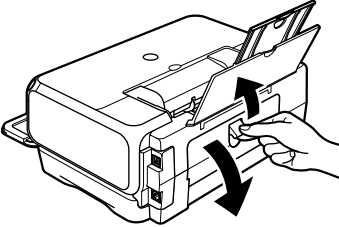
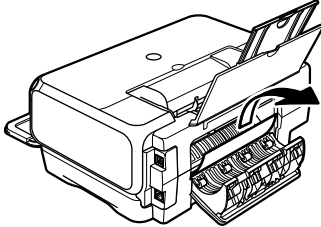
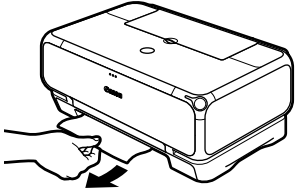
Problem	Possible Cause	Try This
Paper Jams	Paper jams inside the Transport Unit	<p>Remove the paper according to the following procedure.</p> <ol style="list-style-type: none"> 1. Open the Rear Cover.  <ol style="list-style-type: none"> 2. When you can see the jammed paper, slowly pull the paper out.  <p>▲ Caution Be careful not to touch the components inside the printer. If you cannot extract the paper, turn the printer off, and then turn it back on. The paper will be ejected automatically.</p> <ol style="list-style-type: none"> 3. Close the Rear Cover. 4. If you could not extract the paper in step 2, remove the Cassette. 5. Slowly pull the jammed paper out.  <ol style="list-style-type: none"> 6. If any paper is sticking out of the Cassette, reload the paper in the Cassette. 7. Reload the paper in the Sheet Feeder if necessary, and press the RESUME/CANCEL button on the printer. <p>Note When reloading the paper into the printer, refer to “Paper Does Not Feed Properly” on page 71 to confirm that you are using the correct paper and are loading it into the printer correctly.</p> <p>If you have turned off the printer in step 2, you will need to retry printing, because this operation cancels any print jobs in progress.</p> <p>If you cannot remove the paper or if the paper tears inside the printer, or if the paper jam error continues after removing the paper, contact the Customer Care Center.</p>

Troubleshooting

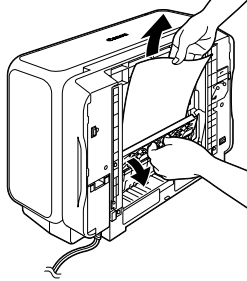
Problem	Possible Cause	Try This
Paper Jams	Paper jams inside the Duplex Transport Section	<p>Remove the paper according to the following procedure.</p> <ol style="list-style-type: none"> 1. Remove the Cassette. If the paper is loaded in the Sheet Feeder, remove the paper from the Sheet Feeder. 2. Stand the printer with the rear side down. 3. Slowly pull the jammed paper out while pulling the green cover toward you.  <p>▲ Caution Put back the printer immediately after removing the jammed paper.</p> <ol style="list-style-type: none"> 4. If any paper is sticking out of the Cassette, reload the paper in the Cassette. Reload paper in the Sheet Feeder, if necessary. 5. Insert the Cassette into the printer. 6. Press the RESUME/CANCEL button on the printer. <p>Note When reloading the paper into the printer, refer to “Paper Does Not Feed Properly” on page 71 to confirm that you are using the correct paper and are loading it into the printer correctly.</p> <p>If you cannot remove the paper or if the paper tears inside the printer, or if the paper jam error continues after removing the paper, contact the Customer Care Center.</p>

Handling Error Messages

When a printer error occurs, the POWER/ERROR lamp flashes. The number of flashes indicates the type of error that has occurred. Count the flashes and take the appropriate action to correct the error.

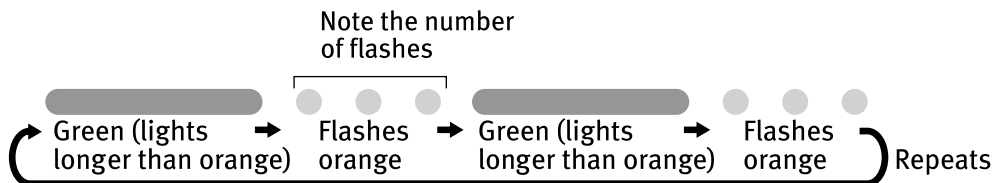



Number of Flashes	Possible Cause	Try This
Two flashes	Printer is out of paper/Paper does not feed	Reload paper in the Sheet Feeder or Cassette and press the RESUME/CANCEL button.
Three flashes	Paper jam/Paper Output Tray is closed	Clear the jammed paper, reload paper in the printer, then press the RESUME/CANCEL button. If the Paper Output Tray is closed, open it. See "Paper Jams" on page 72.
Four flashes	Empty ink tank	Press the RESUME/CANCEL button to resume printing with an empty ink tank. Replace it with a new ink tank immediately after the printing. It may damage the printer if you continue printing with an empty ink tank. See "Replacing an Ink Tank" on page 42.
Five flashes	Print Head not installed/Print Head not installed correctly/Defective Print Head	Install the Print Head. If the Print Head is already installed, remove the Print Head and check the electrical contacts for foreign matter, then reinstall. After reinstalling the Print Head, you may need to realign it. If this error still remains, the Print Head may be damaged. Contact the Customer Care Center.
Six flashes	Inner Cover is open	Close the Inner Cover and press the RESUME/CANCEL button.
Eight flashes	Waste ink absorber almost full	The printer has a built-in waste ink absorber for the ink used during Print Head Cleaning. Eight flashes indicates that the waste ink absorber is nearly full. Press the RESUME/CANCEL button to cancel the error so you can continue printing. Before the waste ink absorber becomes completely full, contact the Customer Care Center.
Nine flashes	A specified period of time has elapsed without receiving a response from the digital camera/The digital camera or digital video camcorder connected is not compatible with this printer	Disconnect the camera cable, press the RESUME/CANCEL button and reconnect the cable. If the error is still unresolved, there is a possibility that you are using a digital camera or digital video camcorder that is not supported by this printer. Use a digital cameras or digital video camcorder compatible with this printer.



Troubleshooting

Number of Flashes	Possible Cause	Try This
Ten flashes	Cannot print on both sides of the page	<p>The size of paper may not be compatible with Automatic Duplex Printing. Pressing the RESUME/CANCEL button will discharge the paper, and restart printing from the front side of the next paper. The reverse side will not be printed when an error occurs.</p> <p>For detailed information on the paper compatible with Automatic Duplex Printing, refer to “Automatically Printing on Both Sides of the Page” in the <i>User’s Guide</i>.</p>
Eleven flashes	Automatic print head alignment failed	<p>Possible causes are as follows:</p> <ul style="list-style-type: none"> ● Letter-sized paper is not loaded on the Sheet Feeder. ● Ink has run out or ink tanks are not installed correctly. See “Ink tank is not seated properly/Ink tank is empty” on page 67. ● Ink level is low ● Print Head nozzles are clogged. Press the RESUME/CANCEL button. See “Printing the Nozzle Check Pattern” on page 49 for information on how to print a nozzle check pattern. ● The Paper Output Slot has been exposed to a strong light source preventing correct Print Head alignment. Press the RESUME/CANCEL button and move the printer to a darker location. Try to align the Print Head again. <p>If the print head alignment fails again, manually align the Print Head. For a detailed description of manual alignment, refer to “Aligning the Print Head” in the <i>User’s Guide</i>.</p>
 Note	POWER lamp flashes alternately green and orange	<p>An error that requires contacting the Customer Care Center may have occurred. Disconnect the printer cable from the printer, and then turn the printer off and unplug the printer from the power supply. Plug the printer back in and turn the printer back on after leaving it for a while.</p> <p>If the problem remains, contact the Customer Care Center.</p>

An Error Message Appears on the Screen

Problem	Possible Cause	Try This
 Writing Error/ Output Error or Communication Error in USBnnn or MPUSBPRNnn	Printer is not ready	Ensure that the POWER lamp lights green. If the POWER lamp is off, turn the printer on. The POWER lamp will flash green when the printer is initializing. Wait until the POWER lamp stops flashing. When the POWER lamp is flashing orange, an error may occur in the printer. For details on how to resolve the error, refer to “ Handling Error Messages ” on page 75.
	Paper is not loaded	Load paper and press the RESUME/CANCEL button. If paper is loaded, ensure that the paper source is selected correctly. Select the paper source with the Paper Feed Switch on the printer, or select it in the printer driver.
	Paper is not loaded correctly	Remove the paper, fan the paper to ensure that sheets are not sticking together, and reload the paper correctly into the Sheet Feeder or Cassette.
	Printer port setting does not match the interface connected to the printer	Check the printer port settings. 1. Open the printer properties dialog box. See “ Opening the Printer Properties Dialog Box Directly from the Start Menu ” on page 28. 2. Click the Port tab (or the Details tab) to confirm the port settings. A USB port is selected if either USBnnn (Canon PIXMA iP4000R) or MPUSBPRNnn (Canon PIXMA iP4000R) (where n is a number) is indicated. If the port setting is not correct, change the port setting according to the interface you are using on the Port tab (or the Details tab), or reinstall the printer driver.
	Faulty connection	Ensure that the printer cable is securely connected to the computer.  Note <ul style="list-style-type: none"> ● If using a switching hub or other device, disconnect the printer and reconnect it directly to the computer and try printing again. If successful, the problem may have been with the device. ● There could also be a problem with the cable(s). Replace the cable(s) and try printing again.
	Printer driver is not installed properly	Uninstall then reinstall the printer driver. 1. Click Start , and select All Programs (or Programs) , the name of your printer, and Uninstall . 2. Follow the on-screen instructions to uninstall the driver. 3. Follow the procedures described in the <i>Setup Guide</i> and reinstall the printer driver.



Troubleshooting

Problem	Possible Cause	Try This
 Writing Error/ Output Error in CNBJNP nnnnnn	Printer is not ready	Ensure that the POWER lamp lights green. If the POWER lamp is off, turn the printer on. The POWER lamp will flash green when the printer is initializing. Wait until the POWER lamp stops flashing. When the POWER lamp is flashing orange, an error may occur in the printer. For details on how to resolve the error, refer to “ Handling Error Messages ” on page 75.
	Paper is not loaded	Load paper and press the RESUME/CANCEL button. If paper is loaded, ensure that the paper source is selected correctly. Select the paper source with the Paper Feed Switch on the printer, or select it in the printer driver.
	Printer port setting does not match the interface connected to the printer	Check the printer port settings. 1. Open the Printer Properties dialog box. See “ Opening the Printer Properties Dialog Box Directly from the Start Menu ” on page 28. 2. Click the Port tab (or the Details tab) and select CNBJNPnnnnnn (“n” represents a number) as the printer port to be used.
	The settings of both the access point and the printer are not identical.	Check the settings of the access point and modify the settings of printer as same as those of the access point. For information on the access point settings, refer to the access point manual. For information on how to set a WEP, refer to “How to set a WEP key” of “ Troubleshooting ” in the <i>Network Guide</i> .
	The network setting of the computer is not correct.	Make sure that the computer can communicate with the access point.
	The radio status is poor.	Adjust the installation positions and the antenna direction while monitoring the radio status with PIXMA Network Tool.
	The distance between printer and access point is too far.	Relocate the printer or the access point to close the distance between the printer and access point within 50 meters.
	There is an obstruction or a source of radio wave interference	Communication between different rooms or floors is generally poor. Adjust the installation locations of the devices. There may be a device such as a microwave oven that is using the same frequency bandwidth as the wireless station. Place the wireless LAN devices as far away from the radio wave interference source as possible.
	Printer setup is not completed./The printer driver is not installed.	Complete the printer setup. If the printer driver is not installed, follow the procedure described in the <i>Setup Guide</i> to install the printer driver.
	The computer is restricted to access the access point.	 Register the MAC address of the computer (AirMac ID) to access point.
The MAC address filtering is set to the printer.	 Register the MAC address of the printer to the printer. Print out the network setting information and verify the MAC address of the printer. For information on how to print network setting information, refer to “ Printing Out the Printer Settings ” of “ Changing and Confirming Network Settings ” in the <i>Network Guide</i> .	

Troubleshooting

Problem	Possible Cause	Try This
Windows Writing Error/ Output Error/ Communication Error	Printer port error	Verify the printer port status. <ol style="list-style-type: none"> Click Start, right-click My Computer and select Properties. When using versions of Windows other than Windows XP, right-click My Computer on the desktop and select Properties. Click the Hardware tab and click Device Manager. Double-click Universal Serial Bus controllers, and USB Printing Support. When using Windows Me or Windows 98, click the Device Manager tab. Double-click Universal Serial Bus controllers, and double-click the name of your printer. Check whether the General tab shows any unusual condition.
Cannot print with Automatic Duplex Printing	Size of loaded paper is incorrect	Ensure that the size of loaded paper is suitable for Automatic Duplex Printing .
	Incorrect paper size is selected	Check the Paper Size setting from within your application to ensure that it matches the size of the paper loaded. Check Paper Size on the Page Setup tab in the Printer Properties dialog box (Windows) or the Page Setup dialog box (Macintosh) to ensure that it matches the size of the paper loaded. For the paper size compatible with Automatic Duplex Printing , refer to “Automatically Printing on Both Sides of the Page” in the <i>User’s Guide</i> . Note To print on both sides of the page manually, follow the procedure below. Windows On the Page Setup tab, clear the Automatic check box. Then try printing again. Macintosh Mac OS X does not support the manual duplex printing.
Macintosh “Error No.: 300”	Printer is not ready	Ensure that the POWER lamp lights green. If the POWER lamp is off, turn the printer on. The POWER lamp will flash green when the printer is initializing. Wait until the POWER lamp stops flashing. When the POWER lamp is flashing orange, an error may occur in the printer. For details on how to resolve the error, refer to “ Handling Error Messages ” on page 75.
	Printer is not properly connected	Ensure that the printer is securely connected to the computer. Note <ul style="list-style-type: none"> ● If using a switching hub or other device, disconnect the printer and reconnect it directly to the computer and try printing again. If successful, the problem may have been with the device. ● There could also be a problem with the cable(s). Replace the cable(s) and try printing again.
	Printer you want to use is not selected on the Printer pop-up menu on the Print dialog box.	Select IP4000R on the Printer pop-up menu on the Print dialog box. If IP4000R does not appear on the Printer pop-up menu, add the printer following the procedures described in the <i>Setup Guide</i> .
Macintosh “Error No.:306”	Cannot print over the wireless LAN.	Make sure that the printer is turned on. The printer cannot communicate through the network, refer to “Troubleshooting” in the <i>Network Guide</i> .
Macintosh “Error No.: 1700”	Waste ink absorber almost full	The printer has a built-in waste ink absorber to hold the ink used during print head cleaning. Eight flashes indicates that this absorber is nearly full. Press the RESUME/CANCEL button to clear the error so you can continue printing. Before the waste ink absorber becomes completely full, contact the Customer Care Center.
Macintosh “Error No.: 1851”	Inner Cover is open when printing starts	Close the Inner Cover, then press the RESUME/CANCEL button.

Troubleshooting

Problem	Possible Cause	Try This
 "Error No.: 1856"	Inner Cover is opened while printing	Close the Inner Cover, then press the RESUME/CANCEL button. Try printing again.
 "Error No.: 2001"	A specified period of time has elapsed without receiving a response from the digital camera/The digital camera or digital video camcorder connected is not compatible with this printer	Disconnect the camera cable, press the RESUME/CANCEL button on the printer and reconnect the cable. If the error is still unresolved, there is a possibility that you are using a digital camera or digital video camcorder that is not supported by this printer. Use a digital camera or digital video camcorder compatible with this printer.
 "Error No.: 2500"	Automatic Print Head alignment failed	See "Eleven flashes" in " Handling Error Messages " on page 75.

Cannot Print Properly from the Digital Camera

The following are the possible errors that may occur when printing directly from a digital still camera or digital video camcorder*, and the countermeasures to eliminate them.

*Hereafter, the digital still camera and digital video camcorder are collectively called a digital camera or camera.

Camera Error Message	Possible Cause	Try This
Printer in use	Images are being printed from the computer	Wait until printing ends. The printer automatically starts printing the images from the camera after completing the current printing.
Printer warming up	The printer is warming up	Wait until warm-up ends. When it is ready, the printer starts printing automatically.
No paper	No paper is loaded	Load paper in either the Sheet Feeder or Cassette which you have selected with the Paper Feed Switch on the printer, and select Continue * in the display on your camera.
Paper error	The Paper Output Tray is closed	Open it to resume printing. If the Inner Cover is open, close it.
Paper jam	A paper is jammed in the printer	Select Stop in the display on your camera to stop printing. Remove the jammed paper, load new paper, and press the RESUME/CANCEL button on the printer and retry printing.
Printer cover open	The Top Cover is open	Close the Top Cover on the printer.
No print head	The Print Head is defective or not installed (The POWER lamp on the printer flashes five times.)	Install a Print Head according to the <i>Setup Guide</i> . If the Print Head has already been installed, remove it to check for any dirt or debris at its contacts. After cleaning, reinstall the Print Head. If the error still remains, the Print Head may be defective. Contact the Customer Care Center.
Waste tank (ink absorber) full	The waste ink absorber is nearly full	The printer has a built-in waste ink absorber to hold the ink used during print head cleaning. This error message indicates that the waste ink absorber is nearly full. You can continue printing for a while by selecting Continue * in the display on your camera. However, because printing is disabled once the waste ink absorber becomes completely full, you are recommended to contact the Customer Care Center as early as possible.
Ink is low	It is about time to replace the ink tank with a new one	Select Continue * in the display on your camera to resume printing.
Ink tank is empty	Replace the ink tank with a new one	Printing resumes once the Top Cover is closed after ink tank replacement. You can continue printing by selecting Continue * in the display on your camera with the ink tank empty. But, it is recommended you replace it with a new one immediately after printing. It may damage the printer if you continue printing with empty ink tanks.
Printer error	An error requiring servicing might have occurred (the POWER lamp on the printer flashes alternately orange and green).	Select Stop in the display on your camera to stop printing. Disconnect the cable between the printer and the camera, turn off the printer, and unplug the power cord of the printer from the power supply. After a while, plug the power cord of the printer back in, turn on the printer, and then reconnect the camera to the printer. If the same error occurs, contact the Customer Care Center.

* To resume printing, you can press the **RESUME/CANCEL** button on the printer instead of selecting **Continue**.

Troubleshooting

-  **Note**
- PictBridge or Canon Bubble Jet Direct compatible digital cameras can be connected to your printer for direct printing.
 - This section describes errors that are indicated on Canon-brand PictBridge- or Bubble Jet Direct-compatible cameras. The error messages and operations may vary depending on the camera you are using. For errors on non-Canon PictBridge-compatible cameras, count the number of flashes the **POWER** lamp on the printer makes and check for the cause of the error and take the appropriate action. For details, see “**Handling Error Messages**” on page 75.
 - Connecting a digital camera not compatible with PictBridge or Bubble Jet Direct makes the **POWER** lamp on your printer flash nine times. In such a case, unplug the cable connecting the camera to the printer, and press the **RESUME/CANCEL** button on the printer.
 - A communication time out occurs if printing takes a long time or if it takes too much time to send data. This may stop printing. In such a case, disconnect the cable between the printer and the camera, press the **RESUME/CANCEL** button on the printer, and reconnect the cable between the printer and the camera. Then, turn the camera on, if it does not automatically turn on. If the problem is still unresolved, select some other photo and check if it can be printed or not.
 - The print head nozzles may be clogged if printing becomes faint or colors are incorrect. See “**When Printing Becomes Faint or Colors are Incorrect**” on page 48.
 - If the paper is curled or its surface is scratched during printing, make sure that you are using the correct type of paper. If this error occurs even when you are using the correct type of paper, select **Prevent paper abrasion** on **Custom Settings** in the printer driver. See “**Print Quality is Poor or Contains Errors**” on page 67.
 - To disconnect the cable connected between the digital camera and printer, follow the procedure below.
 1. Disconnect the cable from the printer.
 2. Turn off the digital camera.
 3. Disconnect the cable from the digital camera.When disconnecting the cable, be sure to hold the connector by its sides.
 - For the errors indicated on the camera and their solution, also refer to the user’s manual of the camera. For other troubles on the digital camera, contact the manufacturer.

Appendix

User's Guide Table of Contents

Your printer's electronic *User's Guide*, located on the *Setup Software and User's Guide CD-ROM*, offers detailed information on the following topics.

How to Use This Manual

- How to Read This Manual

Safety Precautions

Printer Parts and Their Functions

- Front View
- Operation Panel
- Rear View
- Inside the Printer

Using the Sheet Feeder and the Cassette

- Loading Paper
- Changing the Paper Source

Further Printing Techniques

- Printing Photographs
- Automatically Printing on Both Sides of the Page
- Specifying Paper in the Cassette
- Printer Driver Functions (Windows)
- Printer Driver Functions (Macintosh)
- BJ Printer Utility (Macintosh)

Printing Media

- Compatible Media Types
- High Resolution Paper
- Glossy Photo Paper
- Photo Paper Pro
- Photo Paper Plus Glossy
- Photo Paper Plus Double Sided
- Photo Paper Plus Semi-gloss
- Matte Photo Paper
- Transparencies
- T-Shirt Transfers
- Envelopes

Checking the Status of the Printer

- BJ Status Monitor Functions (Windows)
- Printer Setup Utility (Macintosh)

Routine Maintenance

- Replacing an Ink Tank
- When Printing Becomes Faint or Colors are Incorrect
- Printing the Nozzle Check Pattern
- Print Head Cleaning
- Print Head Deep Cleaning
- Aligning the Print Head
- Cleaning the Inside of the Printer
- Transporting Printer

Troubleshooting

- Cannot Install Printer Driver
- Print Quality is Poor
- Printer Does Not Start or Stops During Print Jobs
- Paper Does Not Feed Properly
- Paper Jams
- The POWER Lamp Flashes Orange
- An Error Message is Displayed on the Screen
- Cannot Print Properly from the Digital Camera
- Cannot Print Properly with Automatic Duplex Printing
- Problems Relating to Windows

Appendix

- Printing Area
- Uninstalling Printer Drivers
- Uninstalling the Electronic Manual (Windows)
- Specifications

Index

Specifications

Printer

Printing resolution:	4800 x 1200 dpi. max.
Print speed *	Black printing (text pattern) Max Speed (Custom Setting 5): 25 ppm Standard: 15 ppm Color printing Max Speed (Custom Setting 5): 17 ppm Standard: 11 ppm
* Print speed may vary with the content of the document and the processing speed of the host computer.	
Print width:	203.2 mm max. (8.0 inches) (for Borderless Printing: 215.9 mm / 8.5 inches)
Resident print control mode:	Canon extended mode
Receive buffer:	42 KB
Interface:	USB Wireless LAN Interface (IEEE802.11g/IEEE802.11b) Wired LAN Interface (RJ-45)
Acoustic noise level:	Approx. 35 dB (A) (in the highest print quality mode)
Operating environment:	Temperature: 5 to 35°C (41 to 95°F) Humidity: 10 to 90%RH (no condensation)
Storage environment:	Temperature: 0 to 40°C (32 to 104°F) Humidity: 5 to 95% RH (no condensation)
Power supply:	AC 110-120 V, 50/60 Hz AC 220-240 V, 50/60 Hz
Power consumption:	Print standby: Approx. 4 W Printing: Approx. 16 W
Dimensions (with the Paper Support and Paper Output Tray retracted):	418 (W) x 286 (D) x 170 (H) mm 16.5 (W) x 11.2 (D) x 6.7 (H) inches
Weight:	6.9 kg (15.18 lb.)
Print Head:	Black (BCI-3eBK): 320 nozzles (600 dpi) Yellow (BCI-6Y), Black (BCI-6BK): 256 nozzles per color (1200 dpi) Cyan (BCI-6C), Magenta (BCI-6M): 512 nozzles per color (1200 dpi)

Printer

Ink Tanks:	Capacity (pages): Black (BCI-3eBK) approx. 740^{*1}, approx. 1500^{*2} Black (BCI-6BK) approx. 2000^{*2} Cyan (BCI-6C) approx. 550^{*2} Magenta (BCI-6M) approx. 430^{*2} Yellow (BCI-6Y) approx. 360^{*2}
	^{*1} 1500 characters per page, normal text, at standard and plain paper mode with Windows XP printer driver
	^{*2} Based on printing the ISO JIS-SCID No.5 pattern at standard and plain paper mode with Windows XP printer driver

Network

Protocol	TCP/IP
Operating Systems	Windows XP/Windows 2000/Windows Me/Windows 98 Mac OS X v.10.2.1 to 10.3.x

Wireless LAN

Supported Networks	IEEE802.11g/IEEE802.11b
Interface	IEEE802.11g/IEEE802.11b Network Interface
Transfer Standard	IEEE802.11g/IEEE802.11b
Access Mode	CSMA/CA
Transmission Method	OFDM/DS-SS
Frequency Bandwidth	2.412 GHz - 2.462 GHz
Wireless Channel	1 to 11
Network Type	Infrastructure
Communication Distance	Indoors 50m* * Effective range differs depending on the installation environment and location.
Security	Encryption by WPA-PSK (TKIP) or WEP (64/128 bits), access control by IP address and MAC address filtering, passwords
Certification	Wi-Fi, TELECOM, FCC, IC, ETSI, iDA

Wired LAN

Supported Networks	100BASE-TX/10BASE-T
Interface	Wired LAN Interface (100 BASE-TX/10 BASE-T)
Compliant Standard	IEEE802.3u (100BASE-TX)/IEEE802.3 (10BASE-T)
Transfer Speed	10 Mbps/100 Mbps (auto switchable)

Appendix

Camera Direct Print (Canon Bubble Jet Direct)

Interface	Direct Print Port (Connect a iP4000R-compatible digital camera or digital video camcorder using the USB cable supplied with the camera.)
Compatible digital cameras and digital video camcorders	iP4000R-compatible digital cameras and digital video camcorders
Compatible Paper	Card #1 (Photo Paper Pro 4" x 6"/101.6 x 152.4 mm) Card #2 (Photo Paper Plus Glossy, Photo Paper Plus Semi-gloss, or Glossy Photo Paper 4" x 6"/101.6 x 152.4 mm) Card #3 (Photo Paper Plus Glossy, or Photo Paper Plus Double Sided 5" x 7"/127.0 x 177.8 mm) LTR (Photo Paper Pro, Photo Paper Plus Glossy, Photo Paper Plus Semi-gloss, or Glossy Photo Paper Letter size) A4 (Photo Paper Pro, Photo Paper Plus Glossy, Photo Paper Plus Semi-gloss, or Glossy Photo Paper A4 size)
Layout Print	Standard: Borderless / with border, Index Print: 15-80 images (depending on the size of print media)
Print Quality	Standard
Effect	ExifPrint
DPOF Functions	Ver. 1.00 compatible (Index print, number of copies, select images, print special characters (date/image no.))

Camera Direct Print (PictBridge)

Paper size	Default (Photo Paper Plus Glossy 10 x 15 cm/4" x 6") 10 x 15 cm/4" x 6" (Photo Paper Plus Glossy, Photo Paper Pro, Photo Paper Plus Semi-gloss, Glossy Photo Paper) 13 x 18 cm/5" x 7" (Photo Paper Plus Glossy)* 5.4 x 8.6 cm/2.13" x 3.39" (Glossy Photo Paper) A4/8.5" x 11" (Photo Paper Plus Glossy A4/Letter, Photo Paper Pro A4/Letter, Photo Paper Plus Semi-gloss A4/Letter, Glossy Photo Paper A4/Letter) * If using a Canon PictBridge-compatible camera, you can select it.
Paper type	Default (Photo Paper Plus Glossy), Photo (Photo Paper Plus Glossy, Glossy Photo Paper), Fast Photo (Photo Paper Pro)
Layout	Default (Borderless), Borderless, Bordered, 2-up/4-up/9-up/16-up* * When 4" x 6" is selected from Paper size, these options may be available in Layout.
Trimming	Off (No trimming)
Image optimize	Default (On: ExifPrint), VIVID*, NR (Noise Reduction)*, VIVID+NR* * If using a Canon PictBridge-compatible camera, you can select it.
Date print	Default (Off: No printing)

BJ Printer Driver Systems Requirements

Windows

- Use a computer on which Windows XP, Windows 2000, Windows Me or Windows 98 can operate.
- USB interface*
- Wireless LAN (IEEE802.11g/IEEE802.11b standard compliance)
- Wired LAN (IEEE802.3u/IEEE802.3 standard compliance)
- Available hard-disk space for printer driver installation
Windows XP/Windows 2000: 50 MB
Windows Me/Windows 98: 15 MB

* USB operation can only be guaranteed on a PC with pre-installed Windows XP, Windows 2000, Windows Me, or Windows 98.

Macintosh

- Use a Macintosh series computer equipped with USB interface on which Mac OS X v.10.2.1 to 10.3.x can operate.
See www.canontechsupport.com for Mac OS update compatibility.
- Wireless LAN (IEEE802.11g/IEEE802.11b standard compliance)
- Wired LAN (IEEE802.3u/IEEE802.3 standard compliance)
- Available hard-disk space for printer driver installation
Mac OS X v.10.2.x or later: 100 MB
- The following functions are not supported when using Mac OS X v.10.2 or later:
 - Manual Duplex Printing
 - Photo Optimizer PRO
 - Poster Printing
 - Fit-to-Page Printing
 - Booklet Printing
 - Reverse Order Printing (supported with Mac OS X v.10.3.x)

Additional Systems Requirements for Electronic Manuals

- Pentium®, 75 MHz equivalent or higher processor (Pentium®, 133 MHz equivalent or higher processor recommended)
- 2x or higher CD-ROM drive (4x or higher recommended)
- 15 MB of available hard disk space (when installing electronic manuals)
- Windows: Microsoft® Internet Explorer 5.0 or later
- Mac OS: Microsoft® Internet Explorer 5.0 or later, Safari 1.0 or later



⚠ Safety Precautions

Please read the safety warnings and cautions provided in this manual to ensure that you use your printer safely. Do not attempt to use printer in any way not described in this manual.

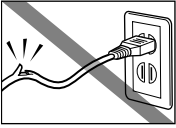
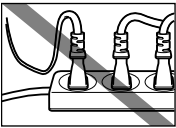
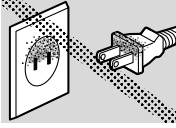
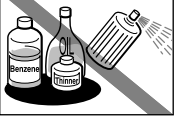
⚠ Warning You may cause an electric shock, fire or damage the printer if you ignore any of these safety precautions.

Choosing a location	Do not place the printer close to flammable solvents such as alcohol or thinners.
Power supply	Never attempt to plug in or unplug the printer from the power supply when your hands are wet.
	Always push the plug all the way into the power outlet.
	Never damage, modify, stretch or excessively bend or twist the power cord. Do not place heavy objects on the power cord. 
	Never plug the printer into a power socket that is shared with other equipment (extension lead/cord, 2- or 3-way adapter, etc.). 
	Never use the printer if the power cord is bundled or knotted.
	If you detect smoke, unusual smells or strange noises around the printer, immediately unplug the printer at the power supply and call for service. Periodically, unplug the printer and use a dry cloth to wipe off any dust or dirt collected on the plug and the power outlet. If the printer is placed at a location exposed to a lot of dust, smoke, or high humidity, the dust collected on the plug absorbs moisture and may cause insulation failure and fire. 
Cleaning the printer	Use a damp cloth to clean the printer. Never use flammable solvents such as alcohol, benzene or thinners. If flammable solvents come in contact with electrical components inside the printer, it could cause a fire or electric shock. 
	Always unplug the printer from the power outlet before cleaning the printer. If you accidentally switch the printer on while cleaning it, you could injure yourself or damage the printer.
Maintaining the printer	Do not attempt to disassemble or modify the printer. There are no user serviceable parts inside the printer. The printer contains high-voltage components. Never attempt any maintenance procedure not described in this guide.
Working around the printer	Do not use flammable sprays near the printer. This could cause a fire or electric shock if the spray comes into contact with electrical components inside the printer.

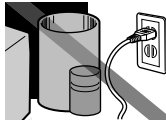
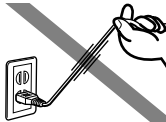
▲ Caution You may cause injury or damage the printer if you ignore any of these safety precautions.

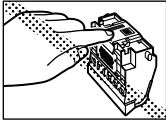
Choosing a location	Do not install the printer in a location that is unstable or subject to excessive vibration.	
	Do not install the printer in locations that are very humid or dusty, in direct sunlight, outdoors, or close to a heating source. To avoid the risk of fire or electric shocks, install the printer in a location with an ambient temperature range of 5°C to 35°C (41°F to 95°F) and humidity of 10% to 90% (condensation free).	
	Do not place the printer on a thick rug or carpet.	
	Ensure that the area around the power outlet is kept clear at all times so you can easily unplug the power cord if necessary.	
	Do not place the printer with its back attached to the wall.	
Power supply	Never remove the plug by pulling on the cord.	
	Do not use an extension lead/ cord.	
	Never use a power supply source other than the one rated for the printer in the country where you purchased the printer. AC 110-120 V, 50/60 Hz AC 220-240 V, 50/60 Hz	
Working around the printer	Never put your hands or fingers in the printer while it is printing.	
	Do not place any object on the printer.	
	Do not place metal objects (paper clips, staples, etc.) or containers of flammable solvents (alcohol, thinners, etc.) on top of the printer.	
	If any foreign object (metal or liquid) fall into the printer, unplug the power cord and call for service.	
	Do not transport or store the printer on a slant, vertically or upside-down, as the ink may leak and damage the printer.	
Print heads and ink tanks	For safety reasons store Print Heads and ink tanks out of the reach of small children. If a child ingests any ink, consult a doctor immediately.	
	Do not shake Print Heads or ink tanks. Ink may leak out and stain clothing or the surrounding area.	
	Never touch the electrical contacts on a Print Head after printing. The metal parts may be very hot and could cause burns.	
Radio wave interference	Since the microwave oven and the wireless LAN system use the same frequency bandwidth, the microwave oven can be the potential source of interference when the microwave oven is on. Placing this product close to microwave oven may result in the poor status of radio.	

Regulatory Information

Color Printer Model: K10245 (Contains FCC ID: AZDK30242)

This device complies with Part 15 of the FCC Rules. Operation is subject to the following two conditions: (1) This device may not cause harmful interference, and (2) this device must accept any interference received, including interference that may cause undesired operation.

Note: This equipment has been tested and found to comply with the limits for a Class B digital device, pursuant to Part 15 of the FCC Rules. These limits are designed to provide reasonable protection against harmful interference in a residential installation. This equipment generates, uses and can radiate radio frequency energy and, if not installed and used in accordance with the instructions, may cause harmful interference to radio communications. However, there is no guarantee that interference will not occur in a particular installation. If this equipment does cause harmful interference to radio or television reception, which can be determined by turning the equipment off and on, the user is encouraged to try to correct the interference by one or more of the following measures:

- Reorient or relocate the receiving antenna.
- Increase the separation between the equipment and receiver.
- Connect the equipment into an outlet on a circuit different from that to which the receiver is connected.
- Consult the dealer or an experienced radio/TV technician for help.

Use of a shielded cable is required to comply with Class B limits in Subpart B of Part 15 of the FCC Rules.

Do not make any changes or modifications to the equipment unless otherwise specified in the manual. If such changes or modifications should be made, you could be required to stop operation of the equipment.

FCC ID: AZDK30242

FCC WARNING

Changes or modifications not expressly approved by the party responsible for compliance could void the user's authority to operate the equipment.

This transmitter must not be co-located or operating in conjunction with any other antenna or transmitter.

FCC Radiation Exposure Statement:

This equipment complies with FCC radiation exposure limits set forth for uncontrolled equipment. This equipment should be installed and operated with minimum distance at least 20cm between the radiator and persons body (excluding extremities: hands, wrists, feet and legs) and must not be co-located or operated with any other antenna or transmitter.

Canon U.S.A., Inc.
One Canon Plaza
Lake Success, NY 11042
1-516-328-5600

Canadian Radio Interference Regulations

This digital apparatus does not exceed Class B limits for radio noise emissions from a digital apparatus as set out in the interference-causing equipment standard entitled "Digital Apparatus", ICES-003 of the Industry Canada.

Cet appareil numérique respecte les limites de bruits radio électriques applicables aux appareils numériques de Classe B prescrites dans la norme sur le matériel brouilleur: "Appareils Numériques", NMB-003 édictée par l'Industrie Canada.

CANON U.S.A., INC. LIMITED WARRANTY --- (USA Only)

The limited warranty set forth below is given by Canon U.S.A., Inc. ("Canon USA") with respect to the new or refurbished Canon-brand product ("Product") packaged with this limited warranty, when purchased and used in the United States only.

The Product is warranted against defects in materials and workmanship under normal use and service (a) for a period of one (1) year from the date of original purchase when delivered to you in new condition in its original container or (b) for 90 days from the date of original purchase for refurbished Products. Defective parts or a defective Product returned to a Canon USA repair facility or a Canon USA Authorized Service Facility ("ASF"), and proven to be defective upon inspection, will be repaired, exchanged for new or comparable rebuilt parts, or exchanged for a refurbished Product, as determined by the Canon USA repair facility or the ASF. Warranty repair or replacement shall not extend the original warranty period of the Product. A dated proof of purchase is required at the time of warranty service. A copy of your dated bill of sale will satisfy this requirement. This warranty does not cover any accessories, or any consumables, such as paper or ink cartridges, as to which there shall be no warranty or replacement.

This limited warranty shall only apply if the Product is used in conjunction with compatible computers, peripheral equipment and software. Canon USA shall have no responsibility for such items except for compatible Canon brand peripheral equipment covered by a separate warranty ("Separate Warranty"). Repairs of such Canon brand peripheral equipment shall be governed by the terms of the Separate Warranty. Non-Canon brand equipment and software that may be distributed with the Product are sold "as is" and without warranty of any kind by Canon USA, including any implied warranty regarding merchantability or fitness for a particular purpose, and all such warranties are disclaimed. The sole warranty, if any, with respect to such non-Canon brand items is given by the manufacturer or producer thereof.

This limited warranty covers all defects encountered in normal use of the Product and does not apply in the following cases:

- (a) Loss of or damage to the Product due to abuse, neglect, mishandling, improper packaging by you, alteration, accident, electrical current fluctuations, improper use, failure to follow operating or maintenance instructions, or environmental conditions, prescribed in Canon USA's user's manual or other documentation, or services performed by someone other than a Canon USA repair facility or ASF. Without limiting the foregoing, dropping the Product, scratches, and abrasions will be presumed to have resulted from misuse, abuse or failure to operate the Product as set forth in the user's manual or other documentation for the Product.
- (b) Use of parts or supplies (other than those sold by Canon USA) that cause damage to the Product or cause abnormally frequent service calls or service problems.
- (c) If the Product has had its serial number or dating defaced, altered or removed.

ANY SYSTEM SOFTWARE (WHETHER FACTORY LOADED ON THE PRODUCT OR CONTAINED ON THE SOFTWARE DISKETTES OR CD-ROM'S ENCLOSED WITH, OR ACCOMPANYING, THE PRODUCT), AND ANY UTILITY SOFTWARE, DISTRIBUTED WITH OR FOR THE PRODUCT, IS SOLD "AS IS" AND WITHOUT WARRANTY BY CANON USA. THE SOLE WARRANTY WITH RESPECT TO SUCH SOFTWARE IS CONTAINED IN THE SOFTWARE MANUFACTURER'S LICENSE AGREEMENT DISTRIBUTED THEREWITH, INCLUDING ANY LIMITATIONS AND DISCLAIMERS THEREON. PLEASE CONTACT CANON USA IMMEDIATELY IF YOU HAVE NOT RECEIVED A COPY OF THE SOFTWARE MANUFACTURER'S LICENSE AGREEMENT.

NO IMPLIED WARRANTY, INCLUDING ANY IMPLIED WARRANTY OF MERCHANTABILITY OR FITNESS FOR A PARTICULAR PURPOSE, APPLIES TO THE PRODUCT AFTER THE APPLICABLE PERIOD OF THE EXPRESS LIMITED WARRANTY STATED ABOVE, AND NO OTHER EXPRESS WARRANTY OR GUARANTY, EXCEPT AS MENTIONED ABOVE, GIVEN BY ANY PERSON OR ENTITY WITH RESPECT TO THE PRODUCT SHALL BIND CANON USA, OR ITS ASF. (SOME STATES DO NOT ALLOW LIMITATIONS ON HOW LONG AN IMPLIED WARRANTY LASTS, SO THE ABOVE LIMITATION MAY NOT APPLY TO YOU.) CANON USA SHALL NOT BE LIABLE FOR LOSS OF REVENUES OR PROFITS, INCONVENIENCE, EXPENSE FOR SUBSTITUTE EQUIPMENT OR SERVICE, STORAGE CHARGES, LOSS OR CORRUPTION OF DATA, OR ANY OTHER SPECIAL, INCIDENTAL OR CONSEQUENTIAL DAMAGES CAUSED BY THE USE, MISUSE, OR INABILITY TO USE THE PRODUCT REGARDLESS OF THE LEGAL THEORY ON WHICH THE CLAIM IS BASED, AND EVEN IF CANON USA OR ITS ASF HAS BEEN ADVISED OF THE POSSIBILITY OF SUCH DAMAGES. NOR SHALL RECOVERY OF ANY KIND AGAINST CANON USA OR ITS ASF BE GREATER IN AMOUNT THAN THE PURCHASE PRICE OF THE PRODUCT CAUSING THE ALLEGED DAMAGE. WITHOUT LIMITING THE FOREGOING, YOU ASSUME ALL RISK AND LIABILITY FOR LOSS, DAMAGE OR INJURY TO YOU AND YOUR PROPERTY AND TO OTHERS AND THEIR PROPERTY ARISING OUT OF THE POSSESSION, USE, MISUSE, OR INABILITY TO USE THE PRODUCT SOLD BY CANON USA NOT CAUSED SOLELY AND DIRECTLY BY THE NEGLIGENCE OF CANON USA, OR ITS ASF. (SOME STATES DO NOT ALLOW THE EXCLUSION OR LIMITATION OF INCIDENTAL OR CONSEQUENTIAL DAMAGES, SO THE ABOVE EXCLUSION OR LIMITATION MAY NOT APPLY TO YOU.) THIS LIMITED WARRANTY SHALL NOT EXTEND TO ANYONE OTHER THAN THE ORIGINAL PURCHASER OF THE PRODUCT OR THE PERSON FOR WHOM IT WAS PURCHASED AS A GIFT, AND STATES YOUR EXCLUSIVE REMEDY.

Appendix

Canon USA offers a full range of customer technical support* options:

- For interactive troubleshooting, e-mail technical support, the latest driver downloads and answers to frequently asked questions (www.canontechsupport.com)
- Toll-free live technical support within the limited warranty Monday-Saturday (excluding holidays) at **1-800-828-4040**
- The location of the ASF nearest you for carry-in service (**1-800-423-2366**)
- Telephone Device for the Deaf (**TDD 1-866-251-3752**)

If the problem cannot be corrected by using one of the above technical support options, repair options (i.e. Carry-In/Mail-In Service*, InstantExchange Warranty Service*), along with details and conditions of each, are available at the time of your call to the live technical support number(s) above or via the website at www.canontechsupport.com. Please note that under the InstantExchange program, a replacement product will be provided to you prior to your return of the defective product. Since the defective product becomes the property of Canon USA at the time of the exchange, the defective product must be returned in the shipping materials provided. If the defective product is not returned, as directed, you will be responsible for the value of the replacement product, for which Canon USA may invoice you.

This limited warranty gives you specific legal rights, and you may also have other rights, which vary from state to state.

* Support program specifics are subject to change without notice.

Canon U.S.A., Inc.
One Canon Plaza
Lake Success, NY 11042
USA

Canon is a registered trademark of Canon Inc.

Index

A

Accessing the Printer Driver	28
Adjusting the Print Quality for Photographs	29
Advanced Printing	22
Aligning the Print Head	61
An Error Message Appears on the Screen	77
Automatic Duplex Printing	79

B

BCI-3eBK Black	42
BCI-6BK Black	42
BCI-6C Cyan	42
BCI-6M Magenta	42
BCI-6Y Yellow	42
BJ Printer Driver Systems Requirements	87
BJ Printer Utility dialog box (Macintosh)	51
BJ Status Monitor (Windows)	65, 69
Borderless (full)	41
Borderless Printing	38, 68

C

Camera Direct Print	86
Camera Error Message	81
Canceling Print Jobs	17
Canceling Printing	21
Cannot Install the Printer Driver	66
Cannot Print Properly from the Digital Camera	81
CANON U.S.A., INC. LIMITED WARRANTY --- (USA Only) ..	91
Cleaning	53, 55

D

Deep Cleaning	57, 59
Driver	
saving setting	35
settings	16
uninstalling	77

E

Easy-PhotoPrint	37, 38, 39
Easy-WebPrint	37
Examining the Nozzle Check Pattern	52
ExifPrint	37

G

Glossy Photo Paper	14
--------------------------	----

H

Handling Error Messages	75
Help button	2
High Resolution Paper	14

L

Load Limit Mark	6, 9
Loading Paper	3
Loading Paper in the Cassette	8
Loading Paper in the Sheet Feeder	5

M

Matte Photo Paper	14
Media	
specialty	13
to avoid	3
Media Type	14, 16, 19
Media Types Suitable for Borderless Printing	38

N

Nozzle Check	50, 51
Nozzle Check Pattern	
examining	52
printing	49

O

Opening the Printer Properties Dialog Box Directly from the Start Menu	28
Opening the Printer Properties Dialog Box from Your Application Program	28

P

Page Setup (Macintosh)	19, 70
Page Setup dialog box (Macintosh)	70
Paper Does Not Feed Properly	71
Paper Feed Roller	71
Paper Feed Switch	4
Paper Jams	72, 73, 74
Paper Size	19
Paper Support Load Limit	14
Photo Noise Reduction	33
Photo Optimizer PRO	31
Photo Paper Plus Double Sided	14
Photo Paper Plus Glossy	14
Photo Paper Plus Semi-gloss	14
Photo Paper Pro	14
PhotoRecord	37
POWER button	2
POWER lamp	2, 75
Print dialog box	16, 19
Print Head Alignment	61, 63
Print Head Cleaning	53
Print Head Deep Cleaning	57
Print Head Holder	45
Print Media to Avoid	3

Index

Print Quality	17, 29, 67
Print Quality is Poor or Contains Errors	67
Printer Driver Setting for Media Type	14
Printer Properties dialog box	16, 28, 49, 68
Printing Borderless Photographs.....	38
Printing Photographs Directly from a Digital Camera	22
Printing the Nozzle Check Pattern.....	49
Printing with Macintosh	18
Printing with Windows.....	15

R

Recalling Driver Settings	35
Regulatory Information.....	90
Replacing an Ink Tank	42
RESUME/CANCEL button.....	17

S

Safety Precautions	88
Saving Driver Setting.....	35
Specialty Media	14
Specifications	84

T

Transparencies.....	14
Troubleshooting	65
Troubleshooting Printer Hardware	69
T-Shirt Transfers.....	14
Turning on the Printer.....	2

U

Uninstalling the printer driver	77
User's Guide Table of Contents.....	83
Using Specialty Media.....	13
Using the Bundled Software	37
Using the Sheet Feeder and the Cassette.....	4

V

Vivid Photo.....	32
------------------	----

W

Warranty	91
When Printing Becomes Faint or Colors are Incorrect	48

Ordering Information

For additional supplies, use the following descriptions and order numbers.

Description	Order #
Ink Tanks	
BCI-3e Black	4479A003
BCI-6 Black	4705A003
BCI-6 Cyan	4706A003
BCI-6 Magenta	4707A003
BCI-6 Yellow	4708A003
Canon Specialty Papers	
Glossy Photo Paper (8.5" x 11"/20 sheets)	1026A009
High Resolution Paper (8.5" x 11"/100 sheets)	1033A011
Matte Photo Paper (8.5" x 11"/50 sheets)	7981A004
Photo Paper Plus Glossy (4" x 6"/20 sheets)	7980A007
Photo Paper Plus Glossy (4" x 6"/50 sheets)	7980A012
Photo Paper Plus Glossy (4" x 6"/120 sheets)	7980A022
Photo Paper Plus Glossy (5" x 7"/20 sheets)	7980A019
Photo Paper Plus Glossy (8.5" x 11"/20 sheets)	7980A006
Photo Paper Plus Semi-Gloss (4" x 6"/50 sheets)	8386A010
Photo Paper Pro for Borderless Printing (4" x 6"/20 sheets)	1029A014
Photo Paper Pro for Borderless Printing (4" x 6"/75 sheets)	1029A027
Photo Paper Pro (8.5" x 11"/15 sheets)	1029A004
Photo Paper Pro (8.5" x 11"/30 sheets)	1029A028
Transparencies (8.5" x 11"/50 sheets)	1043A004

Call **1-800-OK-CANON** to locate a dealer near you, or visit the Canon eStore at www.estore.usa.canon.com.



©2004 Canon U.S.A., Inc. Canon is a registered trademark of Canon Inc. All other product and brand names are trademarks of their respective owners. As an ENERGY STAR® partner, Canon U.S.A., Inc., has determined that this product meets the ENERGY STAR® guidelines for energy efficiency.

Quick Start Guide

Canon U.S.A., Inc.

One Canon Plaza, Lake Success, NY 11042, U.S.A.

Canon Inc.

30-2, Shimomaruko 3-chome, Ohta-ku, Tokyo 146-8501, Japan

Canon Canada, Inc.

6390 Dixie Road, Mississauga, Ontario, L5T 1P7, Canada

Canon Latin America, Inc.

703 Waterford Way, Suite 400, Miami, FL 33126, U.S.A.

Canon Mexicana S. de R.L. de C.V.

Periferico Sur No. 4124 Col. Ex-Rancho de Anzaldo, C.P. 01900, Mexico, D.F.



The following ink tanks are compatible with iP4000R.

For details on ink tank replacement, refer to “Replacing an Ink Tank” in this guide.

