

EX-TREME 540



3-D ARF



CARL GOLDBERG PRODUCTS LTD.

P.O. Box 818, Oakwood, GA 30566 • 678-450-0085 • Fax: 770-532-2163 • www.carlgoldbergproducts.com

©copyright 2003 Carl Goldberg Products, Ltd.

**WARNING! THIS IS NOT A TOY!
THIS IS NOT A BEGINNERS AIRPLANE**

THIS R/C KIT AND THE MODEL YOU WILL BUILD FROM IT IS NOT A TOY! IT IS CAPABLE OF SERIOUS BODILY HARM AND PROPERTY DAMAGE. IT IS YOUR RESPONSIBILITY, AND YOURS ALONE - TO BUILD THIS KIT CORRECTLY, PROPERLY INSTALL ALL R/C COMPONENTS AND FLYING GEAR (ENGINE, TANK, RADIO, PUSHRODS, ETC. AND TO TEST THE MODEL AND FLY IT ONLY WITH EXPERIENCED, COMPETENT HELP, USING COMMON SENSE AND IN ACCORDANCE WITH ALL SAFETY STANDARDS AS SET FORTH IN THE ACADEMY OF MODEL AERONAUTICS SAFETY CODE. IT IS SUGGESTED THAT YOU JOIN THE AMA AND BECOME PROPERLY INSURED BEFORE ATTEMPTING TO FLY THIS MODEL. IF YOU ARE JUST STARTING R/C MODELING, CONSULT YOUR LOCAL HOBBY DEALER OR WRITE TO THE ACADEMY OF MODEL AERONAUTICS TO FIND AN EXPERIENCED INSTRUCTOR IN YOUR AREA.

WRITE TO: ACADEMY OF MODEL AERONAUTICS, 5151 MEMORIAL DR. MUNCIE, IN 47302

LIMITED WARRANTY

CARL GOLDBERG PRODUCTS IS PROUD OF THE CARE AND ATTENTION THAT GOES INTO THE MANUFACTURE OF PARTS FOR ITS MODEL KITS. THE COMPANY WARRANTS THAT FOR A PERIOD OF 90 DAYS, IT WILL REPLACE, AT THE BUYERS REQUEST, ANY PART OR MATERIAL SHOWN TO THE COMPANY'S SATISFACTION TO HAVE BEEN DEFECTIVE IN WORKMANSHIP OR MATERIAL AT THE TIME OF PURCHASE.

NO OTHER WARRANTY OF ANY KIND, EXPRESSED OR IMPLIED, IS MADE WITH RESPECT TO THE MERCHANDISE SOLD BY THE COMPANY. THE BUYER ACKNOWLEDGES AND UNDERSTANDS THAT HE IS PURCHASING ONLY A COMPONENT KIT FROM WHICH THE BUYER WILL HIMSELF CONSTRUCT A FINISHED FLYING MODEL AIRPLANE. THE COMPANY IS NEITHER THE MANUFACTURER OF SUCH A FLYING MODEL AIRPLANE, NOR A SELLER OF IT. THE BUYER HEREBY ASSUMES THE RISK AND ALL LIABILITY FOR PERSONAL OR PROPERTY DAMAGE OR INJURY ARISING OUT OF THE BUYERS USE OF THE COMPONENTS OR THE FINISHED FLYING MODEL AIRPLANE, WHENEVER ANY SUCH DAMAGE OR INJURY SHALL OCCUR. ANY ACTION BROUGHT FORTH AGAINST THE COMPANY, BASED ON THE BREACH OF THE CONTRACT OF SALE TO THE BUYER, OR ON ANY ALLEGED WARRANTY THERE UNDER, MUST BE BROUGHT WITHIN ONE YEAR OF THE DATE OF SUCH SALE, OR THERE AFTER BE BARRED. THIS ONE-YEAR LIMITATION IS IMPOSED BY AGREEMENT OF THE PARTIES AS PERMITTED BY THE LAWS OF THE STATE OF GEORGIA.

IMPORTANT INFORMATION

COVERING COMING LOOSE IS NOT COVERED UNDER WARRANTY. DUE TO TEMPERATURE CHANGES THE PLANE MAY DEVELOP SOME WRINKLES IN THE COVERING THAT YOU WILL NEED TO REMOVE WITH AN IRON. BE SURE TO SEAL THE EDGES DOWN FIRST SO THAT YOU DO NOT CAUSE THE COVERING TO SHRINK AND LEAVE EXPOSED AREAS OF WOOD. PLEASE INSPECT THE PLANE BEFORE BEGINNING TO ASSEMBLE TO MAKE SURE YOU ARE HAPPY WITH IT. AFTER ASSEMBLY HAS BEGUN YOU CANNOT RETURN THE KIT. IF YOU FIND A PROBLEM BEFORE BEGINNING TO ASSEMBLE THE PLANE YOU MUST CONTACT US, PLEASE DO NOT RETURN IT TO THE DEALER.

EX-TREME 540 3-D ARF
EX-TREME 540

CONGRATULATIONS ON YOUR PURCHASE OF THE LANIER EX-TREME 540 3-D ARF. THIS IS A VERY UNIQUE AIRCRAFT, WITH GREAT 3-D CAPABILITIES. EVERY EFFORT HAS BEEN MADE TO PRODUCE A LIGHTWEIGHT, STRAIGHT, EASY TO ASSEMBLE AIRCRAFT. BECAUSE OF ITS OVERSIZE CONTROL SURFACES WHICH ARE DOUBLE BEVELED TO ALLOW FOR EXTREME THROWS, GREAT CARE MUST BE TAKEN IN THE SET-UP AND FLYING OF THIS AIRPLANE. QUALITY HARDWARE COMPONENTS HAVE BEEN PROVIDED TO ALLOW FOR 3D SET-UP WHILE MAINTAINING ADEQUATE MECHANICAL ADVANTAGE TO ELIMINATE FLUTTER. IT IS YOUR RESPONSIBILITY AS AN ADVANCED PILOT TO FLY THE AIRCRAFT IN AN INTELLIGENT MANNER. THROTTLE MANAGEMENT IS A MUST!!!!!!! WE AT LANIER HAVE PUT THE EX-TREME 540 THROUGH A VERY RIGOROUS FLIGHT-TESTING SCHEDULE AND HAVE STRESSED THE AIRFRAME BEYOND ALL PRACTICAL PARAMETERS WITHOUT A SINGLE FAILURE. LANIER WILL NOT WARRANT THE EX-TREME 540 AGAINST FLUTTER DUE TO IMPROPER SET-UP OR EXCESSIVE SPEED MANEUVERS. HAVING SAID THAT, WE BELIEVE YOU WILL FIND THE EX-TREME 540 TO BE ONE OF THE MOST RESPONSIVE, IN-THE-GROVE AIRCRAFT ON THE MARKET. THE EX-TREME 540 EXCELS AT HIGH-ALPHA MANEUVERS INCLUDING HARRIERS (BOTH UPRIGHT AND INVERTED), HIGH-ALPHA ROLLS, AND HIGH-ALPHA KNIFE EDGE. TORQUE ROLLS, WATERFALLS, KNIFE EDGE LOOPS AND ELEVATORS ARE ALL WITHIN THE PERFORMANCE PARAMETERS OF THIS UNIQUE AIRCRAFT. JUST REMEMBER TO USE COMMON SENSE WHEN FLYING THIS HIGH PERFORMANCE MACHINE.

PARTS LAYOUT

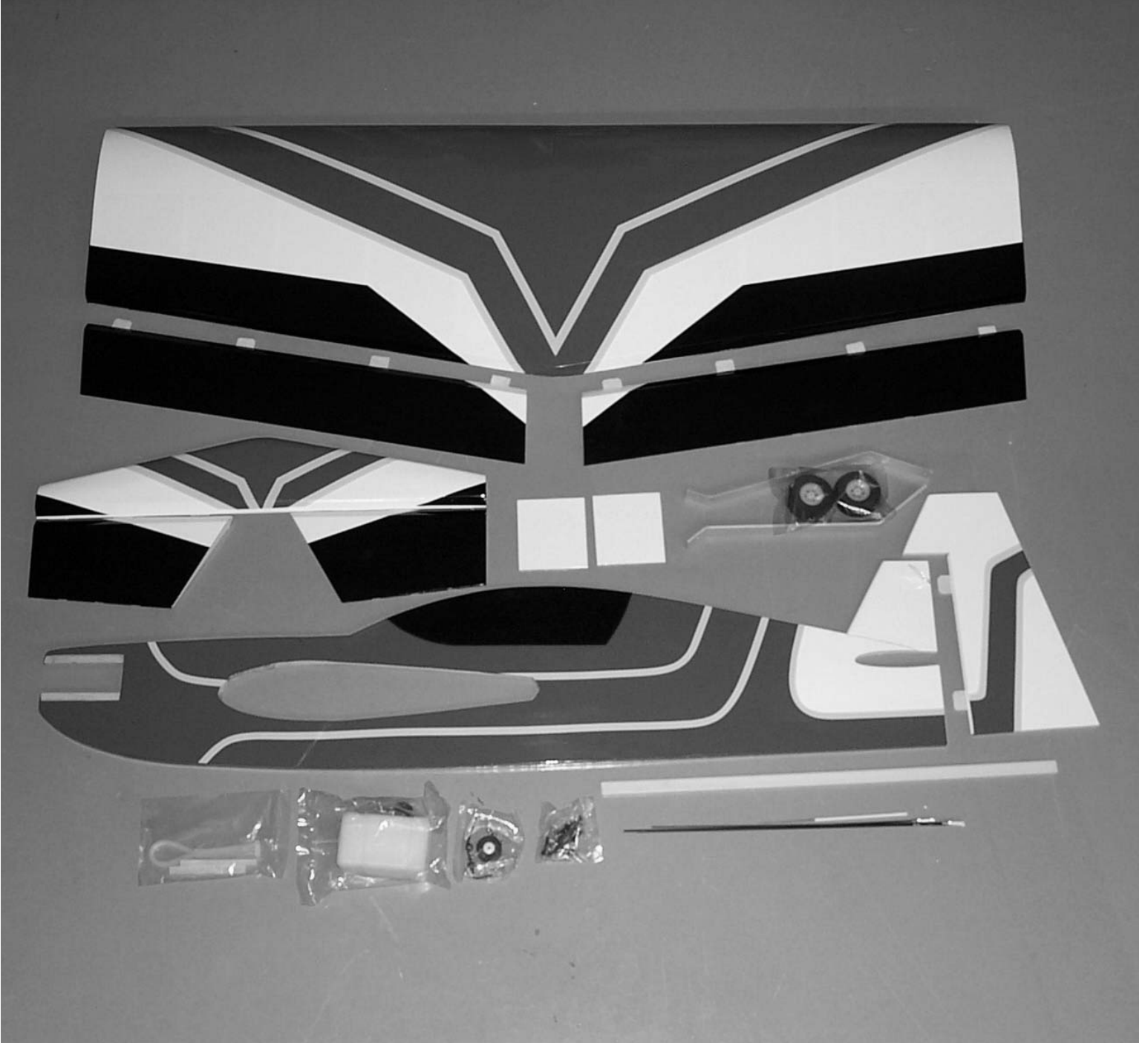

HARDWARE LIST

2.5MMX10MM SCREWS	7	3 TAIL WHEEL MOUNT 4 WIRE HOLDER
2.5MMX8MM SCREWS	8	HATCH COVERS
2MMX20MM SCREWS	8	CONTROL HORNS
3MMX30MM SCREWS	2	LANDING GEAR
3MMX20MM SCREWS	4	MOTOR MOUNT
3MM LOCK NUTS	6	2 LANDING GEAR 4 MOTOR MOUNT
3MM WASHER	12	4 LANDING GEAR 8 MOTOR MOUNT
AXLES	2	
8MM LOCK NUTS	2	AXLE MOUNT
8MM WASHER	2	AXLE MOUNT
4MM WHEEL COLLARS	4	
60MM MAIN WHEELS	2	
ALUMINUM GEAR	2	
TAIL WHEEL BRACKET	1	
2MM WHEEL COLLAR FOR TAIL WHEEL	1	
25MM TAIL WHEEL	1	
FUEL TANK WITH HARDWARE	1	
CABLE TIES	4	
2MM PUSHRODS WITH CLEVIS	4	
SILICONE CLEVIS RETAINERS	4	
1.5MMX 6" THROTTLE PUSHROD	1	
NYLON SLEEVE FOR THROTTLE ROD	1	
NYLON CONTROL HORNS	4	
CONTROL HORN PLATES	4	
ELEVATOR JOINER WIRE	1	
9/16"x19-5/8" NYLON SERVO LEAD COVER	1	
BRACKETS FOR COVER	2	
E-Z CONNECTOR BODY	1	
E-Z CONNECTOR SCREW	1	
SNAP NUT	1	
SNAP-R-KEEPERS	4	
2-56X1" SCREWS	2	ELEVATOR CONTROL HORN

BUILDING INSTRUCTIONS

BEFORE STARTING TO BUILD THIS KIT, WE URGE YOU TO READ THROUGH THESE INSTRUCTIONS. THEY CONTAIN SOME IMPORTANT BUILDING SEQUENCES AS WELL AS INSTRUCTIONS AND WARNINGS CONCERNING THE ASSEMBLY AND USE OF THE MODEL.

WE EXPECT THAT YOU HAVE SOME BUILDING EXPERIENCE TO TAKE ON THIS MODEL. HOWEVER, EVERY MINUTE DETAIL IS NOT COVERED. THIS IS NOT A BASIC TRAINER. THE INSTRUCTIONS TOGETHER WITH THE SIMPLICITY OF THIS KIT WILL ALLOW YOU TO PRODUCE A FIRST CLASS EX-TREME 330 3-D.

BUILDING SUPPLIES NEEDED

HOBBY KNIFE W/ #11 BLADE
 THIN ZAP CA
 30 MINUTE Z-POXY
 THREAD LOCK
 WIRE CUTTERS
 PLIERS
 DRILL WITH BITS: 1/8", 5/32", 1/16"
 5/64"
 PHILLIPS AND STANDARD SCREWDRIVER
 SMALL CLAMPS
 MASKING TAPE
 TAPE MEASURE
 WASHABLE MARKER
 PAPER TOWELS
 RUBBING ALCOHOL

SEE THE LIST AT THE END OF THE INSTRUCTION BOOK FOR A LIST OF ADDITIONAL R/C EQUIPMENT YOU WILL NEED TO COMPLETE THE EX-TREME 540 3-D.

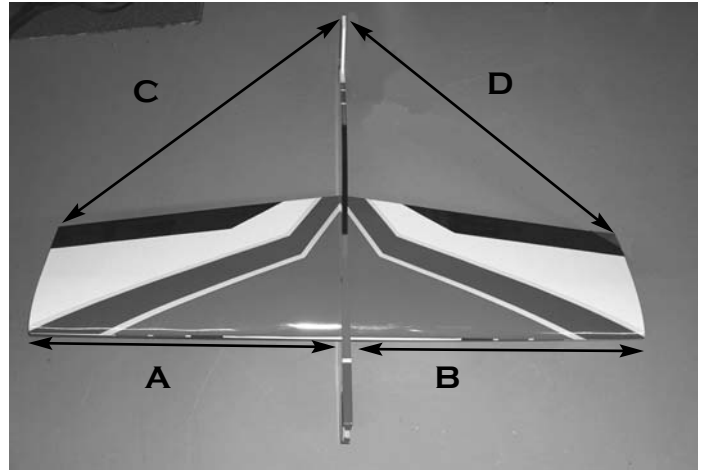

TEST FIT THE WING IN THE FUSE. MAKE ANY ADJUSTMENTS NEEDED WITH A SANDING BLOCK OR ROUND FILE. TRY TO KEEP THE FIT AS TIGHT AS POSSIBLE. USE A RULER TO MEASURE TO MAKE SURE DISTANCE A - B AND C - D ARE EQUAL. THIS IS IMPORTANT TO MAKE SURE THE PLANE TRACKS STRAIGHT AND PREDICTABLY.

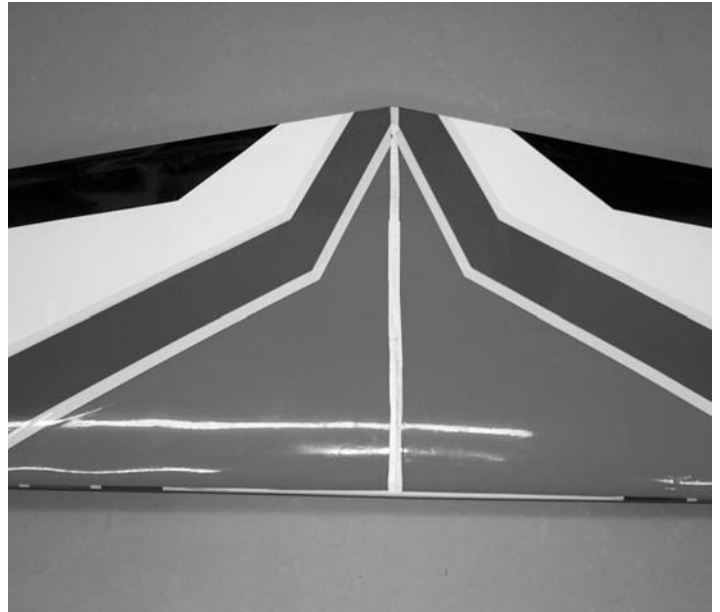

USE A WASHABLE MARKER TO MARK THE LOCATION OF THE WING IN THE FUSE ON BOTH SIDES, THEN REMOVE THE WING. REMOVE THE COVERING FROM THE WING JOINT WITH A SHARP HOBBY BLADE, BEING CAREFUL TO ONLY CUT THE COVERING AND NOT THE BALSA.

EX-TREME 540 3-D ARF

IT IS EASIER TO DO SOME OF THE WORK ON THE WING AND FUSELAGE BEFORE YOU GLUE THEM TOGETHER. LOCATE THE TEMPLATE AT THE REAR OF THE BOOK FOR LOCATING THE LANDING GEAR AND CUT IT OUT WITH SCISSORS. PLACE IT OVER THE FUSELAGE AND DRILL $1/8$ " HOLES AT THE LOCATION OF THE MOUNTING HOLES. CHECK THE ALUMINUM GEAR AND MAKE SURE IT MATCHES THE HOLES IN THE PAPER, IF NOT TRANSFER THOSE HOLES AND USE THE TEMPLATE TO GET THE RIGHT ANGLE.

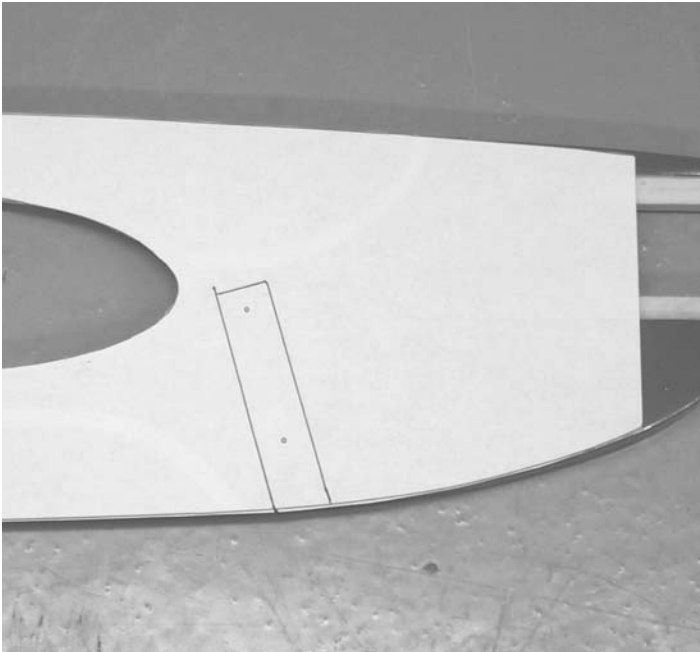

NEXT MOUNT THE AILERON SERVOS IN THE WING.

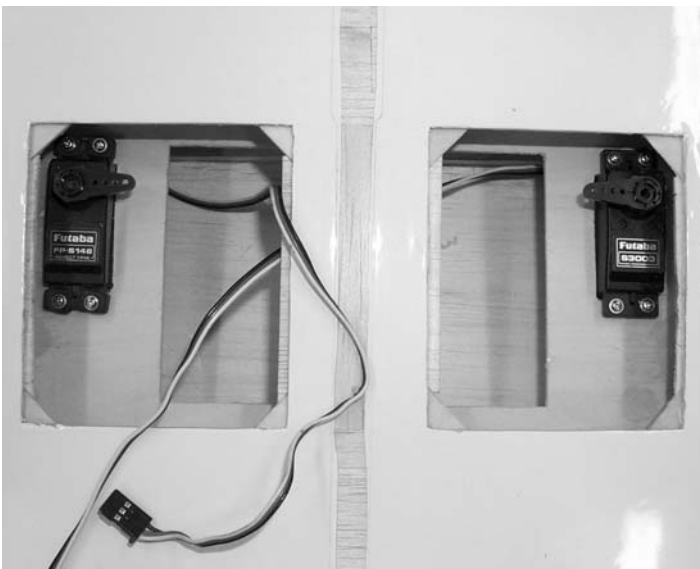

MOUNT WITH THE OUTPUT ARM FORWARD. THE FRONT SCREWS WILL BE A LITTLE HARD TO GET TO BUT CAN BE PUT IN AT A SLIGHT ANGLE. TRIM THE EXTRA LEGS OFF A 4 HOLE OUTPUT ARM AND INSTALL ON THE SERVO WITH THE OUTPUT TOWARD THE INSIDE NEXT TO THE FUSELAGE.



USE A STRAIGHT EDGE TO MARK A LINE FROM THE CENTER OF THE SERVO OUT PUT TO THE TRAILING EDGE, SQUARE TO THE SERVO.

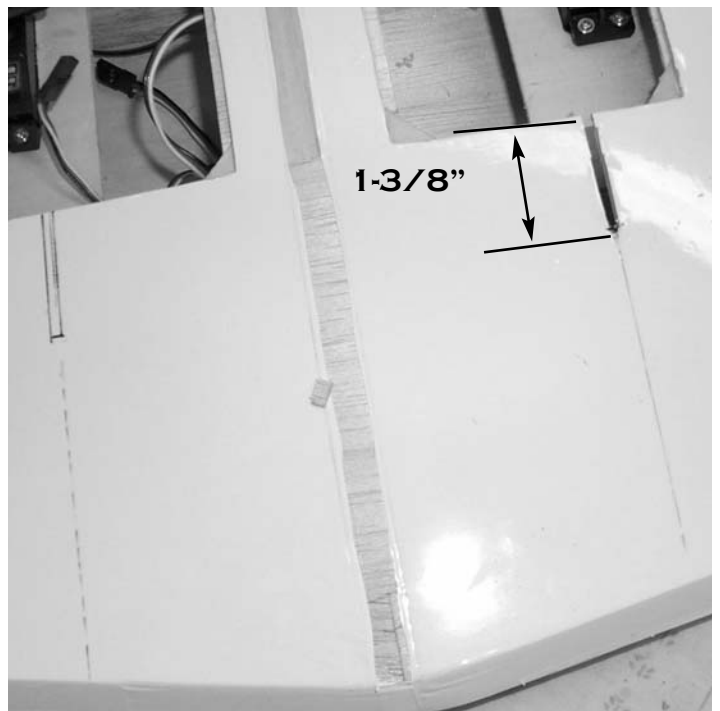

EX-TREME 540 3-D ARF

MEASURE BACK FROM THE OPENING 1-3/8" AND CUT A SLOT 1/8" WIDE CENTERED ON THE MARK YOU MADE.

WE ARE NOW READY TO MOUNT THE WING ON THE FUSELAGE.

SLIDE THE WING BACK IN THE FUSE, ALMOST TO THE WING JOINT. COAT THE BARE Balsa AT THE JOINT WITH 30 MINUTE Z POXY AND SLIDE THE WING IN THE REST OF THE WAY. USE YOUR MARKS TO REALIGN THE WING, THEN REMEASURE A TO B, AND C TO D. CLEAN UP ANY ZPOXY THAT SQUEEZED OUT WITH A PAPER TOWEL AND ALCOHOL. BLOCK THE ENTIRE ASSEMBLY ON YOUR WORKBENCH UNTIL CURED.

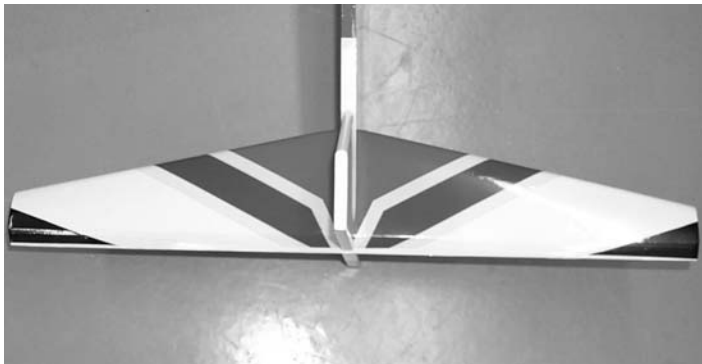
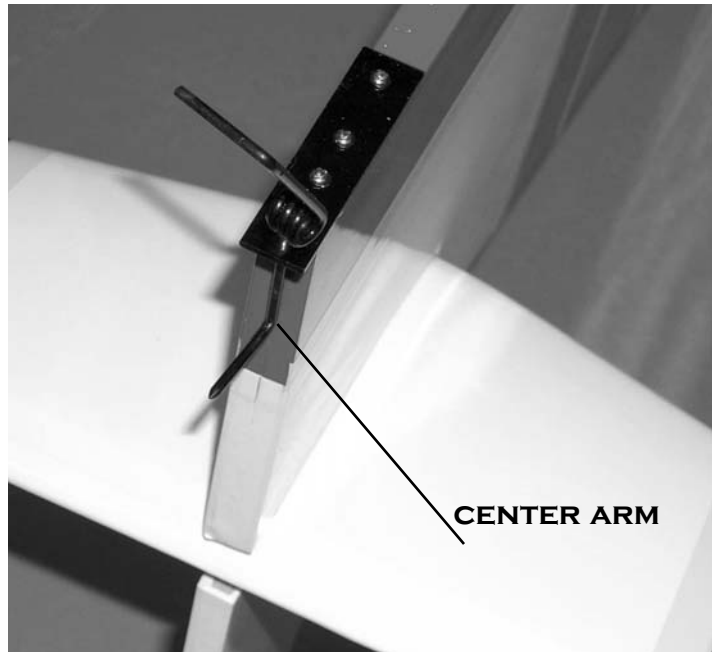

TEST FIT THE HORIZONTAL STAB IN THE REAR OF THE FUSE. CENTER IT THE SAME WAY YOU DID THE WING USING A RULER AND MAKE SURE IT SQUARE TO THE WING.

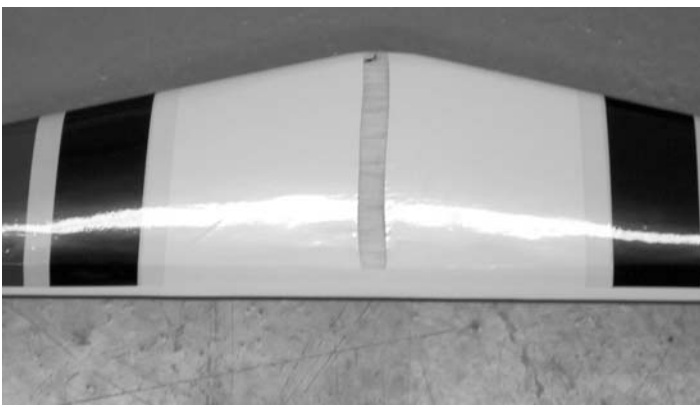

MARK THE COVERING AND REMOVE WHERE IT CONTACTS THE FUSELAGE. REPOSITION THE STAB IN THE FUSELAGE AND RECHECK ALIGNMENT. EPOXY IN PLACE WITH 30 MINUTE EPOXY.

INSTALL THE TAIL WHEEL BRACKET ON THE BOTTOM OF THE FUSELAGE USING 3 2.5MMX10MM SCREWS. DRILL A 1/16" PILOT HOLE IN THE LOCATION OF THE THREE HOLES IN THE METAL BRACKET. MAKE SURE THE TILLER ARM IS CENTERED ON THE RUDDER POST. BEFORE MOUNTING THE BRACKET, HARDEN THE HOLES IN THE FUSE BY APPLY A COUPLE OF DROPS OF THIN CA IN EACH HOLE.

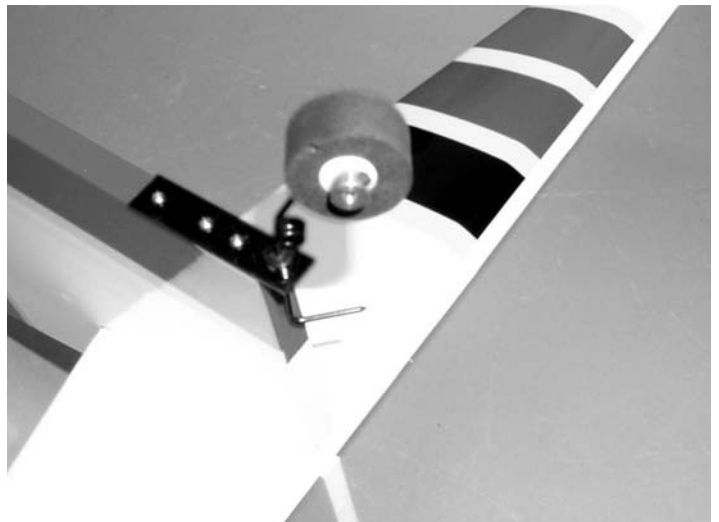

INSTALL THE TAIL WHEEL AND RETAIN WITH THE 2MM WHEEL COLLAR.

EX-TREME 540 3-D ARF

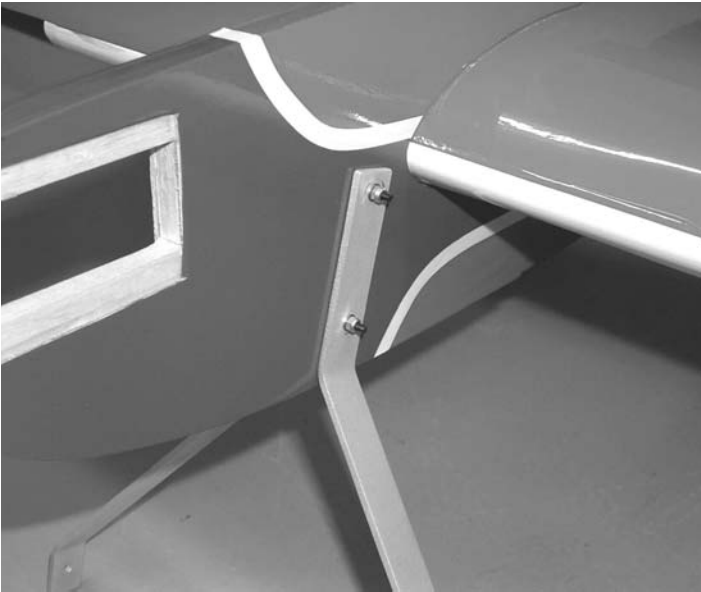

INSTALL THE GEAR ON THE FUSELAGE USING THE TWO 3MMX30MM BOLTS, FOUR 3MM FLAT WASHER, AND TWO 3MM LOCK NUTS.

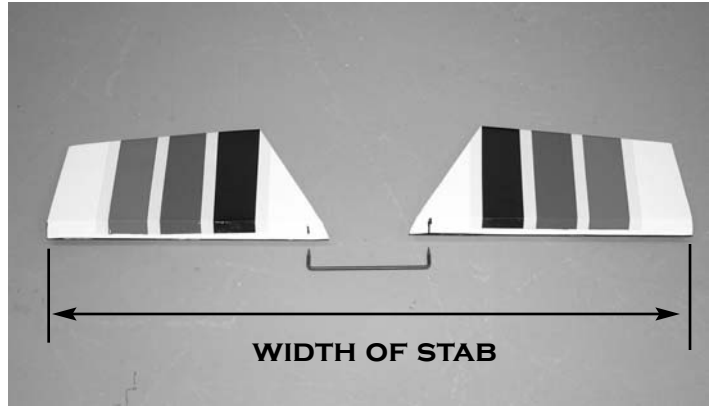

LOCATE THE ELEVATOR JOINER WIRE AND THE TWO ELEVATOR HALVES. MEASURE THE WIDTH OF THE STAB AND LAY THE ELEVATORS SPREAD TO THAT LENGTH. MARK THE LOCATION OF THE HOLES FOR THE ELEVATOR JOINER WIRE ON THE STAB.

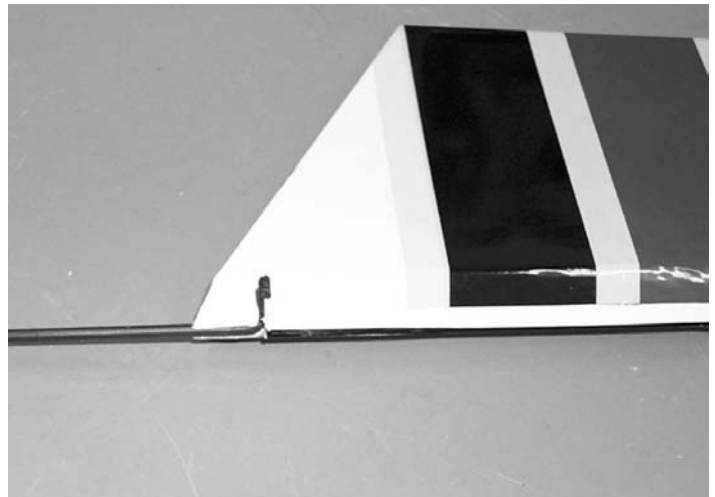

DRILL A 1/8" HOLE AT THE LOCATION OF THE MARK AND NOTCH THE LEADING EDGE OF THE STAB SO THE WIRE WILL BE FLUSH WITH THE LEADING EDGE. REPEAT FOR THE OTHER ELEVATOR HALF.



INSTALL THE AXLE IN THE ALUMINUM GEAR AND SECURE WITH A 8MM FLAT WASHER AND LOCK NUT. INSTALL ONE OF THE WHEEL COLLARS, THE MAIN WHEEL AND SECURE ON THE OUTSIDE WITH THE OTHER WHEEL COLLAR.

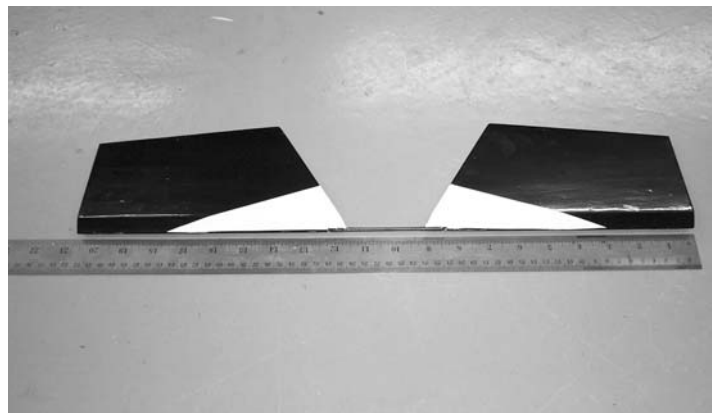

EX-TREME 540 3-D ARF

GLUE THE JOINER WIRE IN PLACE WITH EPOXY. MAKE SURE THE ELEVATORS ARE LYING ON A FLAT SURFACE SO BOTH WILL BE PARALLEL. USE A STRAIGHT EDGE TO MAKE SURE THE LEADING EDGE IS STRAIGHT AND THE TIPS ARE AT THE PROPER WIDTH.

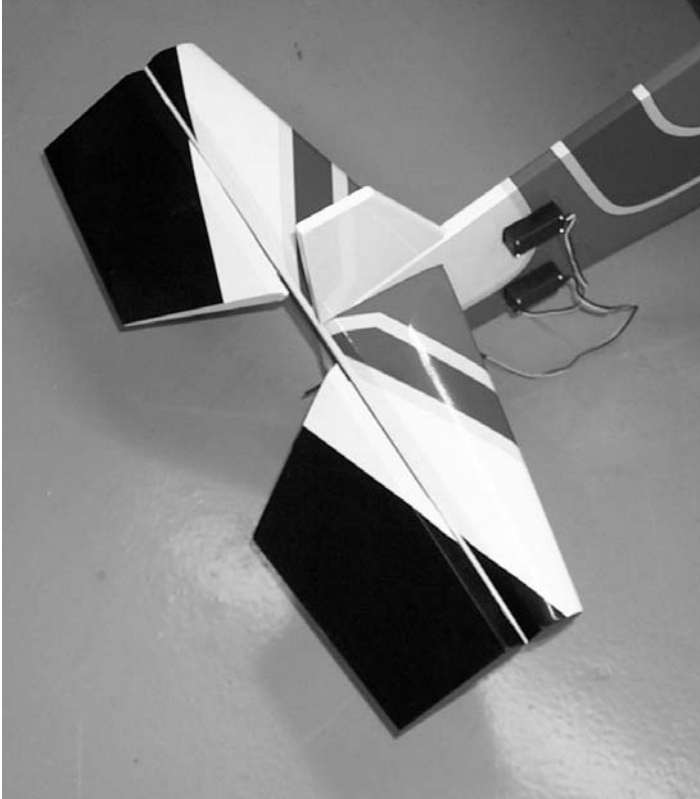

FIT THE ELEVATORS IN PLACE ON THE CA HINGES.

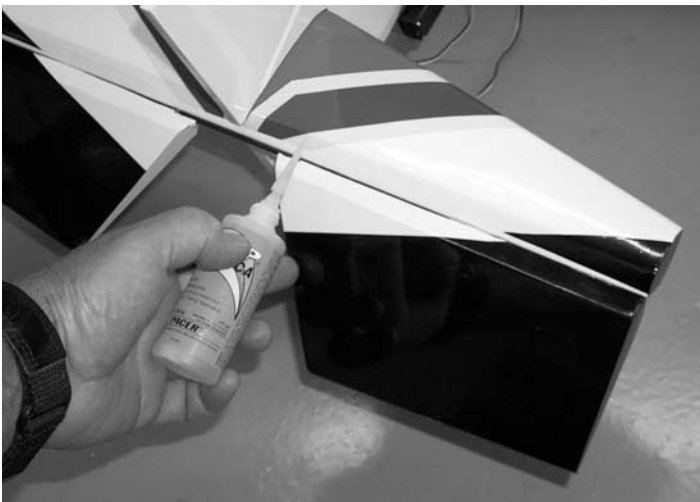

DEFLECT THE ELEVATOR TO FULL TRAVEL AND GLUE HINGES WITH TWO DROPS OF THIN CA ON EACH HINGE. TURN OVER AND REPEAT ON BOTTOM SIDE.

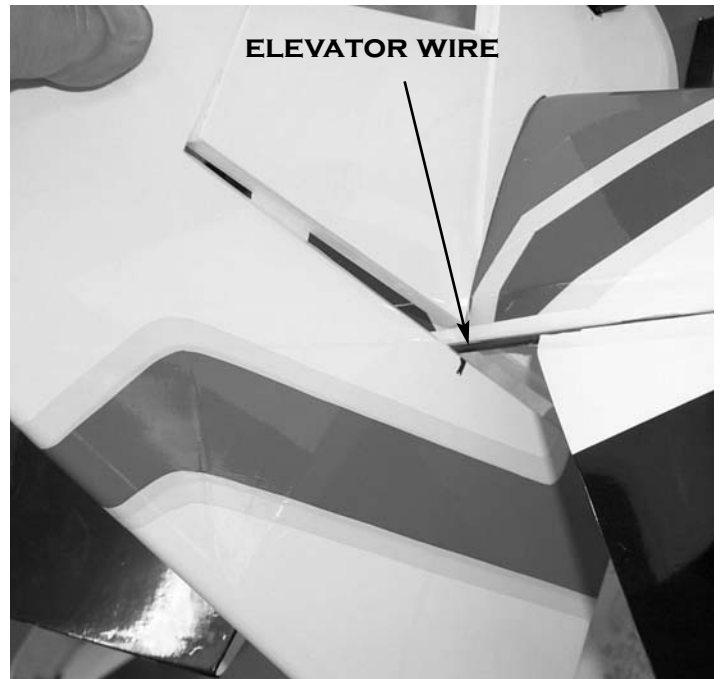

FIT THE RUDDER IN PLACE ON THE FIN AND MARK THE LOCATION OF THE ELEVATOR WIRE.



GO TO THE BOTTOM OF THE RUDDER AND MARK THE LOCATION OF THE TAIL WHEEL TILLER ARM.

EX-TREME 540 3-D ARF

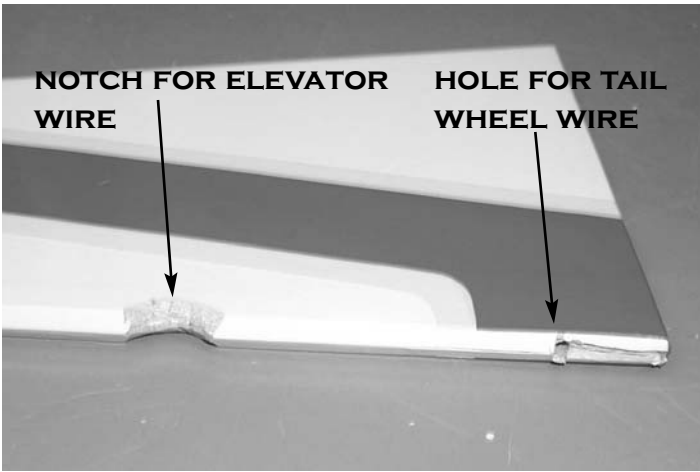

AT THE LOCATION OF THE ELEVATOR WIRE MAKE A NOTCH APPROXIMATELY $3/16$ " DEEP AND $3/8$ " WIDE TO CLEAR THE ELEVATOR WIRE. AT THE LOCATION OF THE TILLER ARM DRILL A $3/32$ " HOLE AND SLOT THE LEADING EDGE OF THE RUDDER TO ACCEPT THE TAIL WHEEL WIRE.



SLIDE A PIECE OF MASKING TAPE BETWEEN THE TAIL WHEEL WIRE AND THE FIN POST. PUT EPOXY GLUE IN THE HOLE AND SLOT ON BOTTOM OF RUDDER WHERE THE TAIL WHEEL WIRE GOES IN. INSTALL THE RUDDER ON THE CA HINGES WITH THE TAIL WHEEL WIRE IN PLACE AND PULL THE MASKING TAPE AROUND TO HOLD THE GLUE IN.

DEFLECT THE RUDDER FULLY IN ONE DIRECTION AND GLUE THE CA HINGES WITH TWO DROPS OF THIN CA EACH. DEFLECT IN THE OTHER DIRECTION AND GLUE THE HINGES ON THE OTHER SIDE. WHEN THE EPOXY HAS CURED YOU CAN REMOVE THE MASKING TAPE.



INSTALL THE AILERONS ON THE WING AND GLUE IN PLACE BY DEFLECTING THE AILERON FULLY IN ONE DIRECTION AND APPLY TWO DROPS OF THIN CA ON EACH HINGE. TURN THE WING OVER AND REPEAT ON THE OTHER SIDE.

EX-TREME 540 3-D ARF

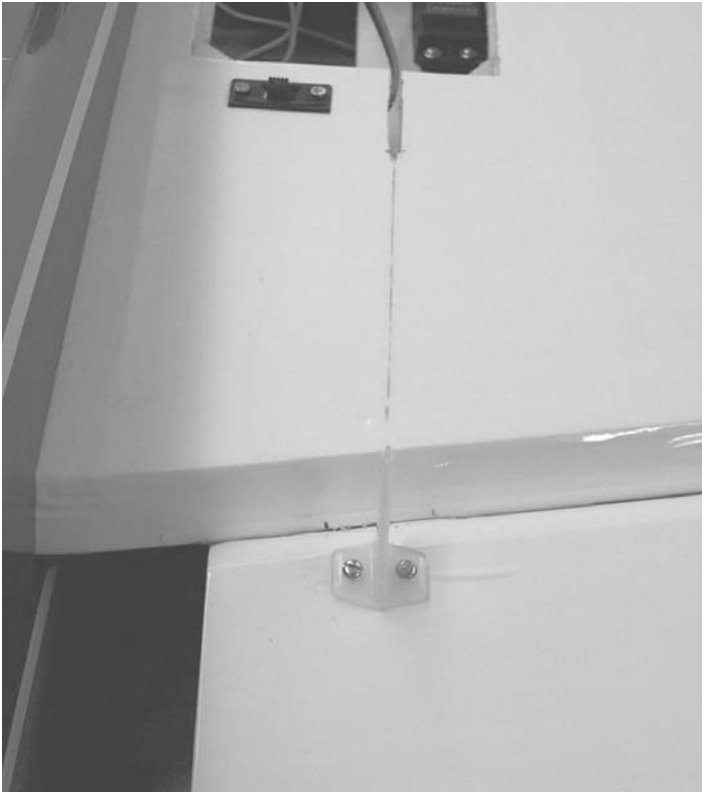

LOCATE ONE OF THE 2MM PUSHRODS WITH CLEVIS. INSTALL THE SILICONE KEEPER OVER THE CLEVIS AND ATTACH TO THE CONTROL HORN. WITH THE AILERON CENTERED AND THE AILERON SERVO CENTERED, MARK THE LOCATION OF THE BEND OVER THE OUTPUT HOLE IN THE SERVO ARM. BEND AT 90 DEGREES AND CUT OFF AT 3/8". THE SERVO ARM WILL NEED TO BE DRILLED WITH THE 5/64" DRILL. INSTALL THE PUSHROD THROUGH THE SERVO ARM AND RETAIN WITH A NYLON SNAP-R-KEEPER. REPEAT FOR THE OTHER AILERON.

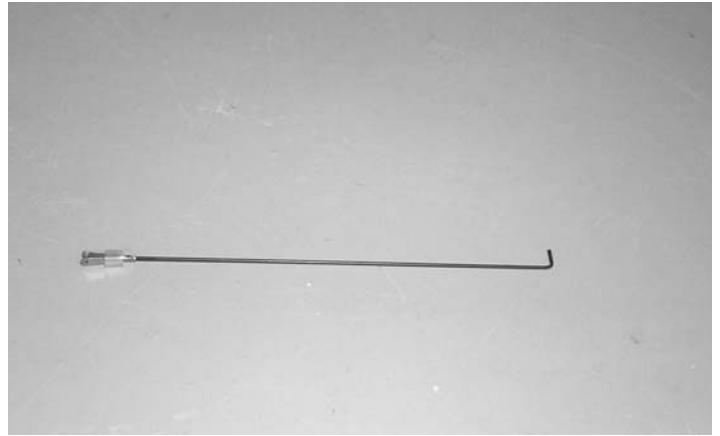

ALIGN THE AILERON CONTROL HORN USING THE LINE YOU DREW EARLIER FOR THE PUSHROD SLOT. MARK THE LOCATION OF THE HOLES AND DRILL TWO 5/64" HOLES. INSTALL THE HORN WITH TWO 2MMX20MM SCREWS AND THE NYLON PLATE ON TOP.

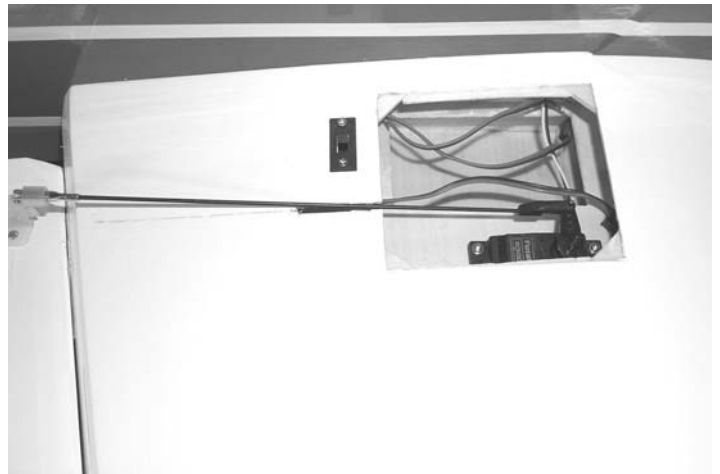

MOUNT THE SWITCH FOR THE RADIO JUST BEHIND THE RADIO COMPARTMENT OPENING ON THE LEFT SIDE OF THE PLANE.

EX-TREME 540 3-D ARF



THE BATTERY WILL MOUNT ON THE LEFT SIDE. WRAP WITH FOAM RUBBER(NOT SHOWN FOR CLARITY) AND INSERT INTO OPENING.



USING A SHARP KNIFE OR RAZOR BLADE, REMOVE THE COVERING FROM THE SERVO CUTOUT JUST AHEAD OF THE STAB ON BOTH SIDES OF THE FUSELAGE.

EXIT HOLE FOR ANTENNA

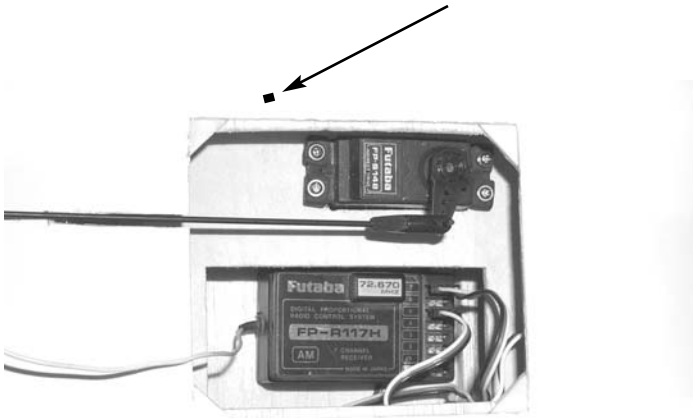

THE RECEIVER WILL MOUNT ON THE RIGHT SIDE IN THE OPENING NEXT TO THE SERVO. WRAP WITH FOAM RUBBER(NOT SHOWN). ROUTE THE ANTENNA UNDER THE PUSHROD AND EXIT FROM A HOLE CLOSE TO THE SIDE OF THE FUSELAGE. IT CAN THEN BE PULLED DOWN THE SIDE OF THE FUSELAGE AND ATTACHED TO THE TOP OF THE RUDDER.



INSTALL THE RUDDER AND ELEVATOR SERVO IN THE CUTOUTS USING THE HARDWARE SUPPLIED WITH THE RADIO. THEY WILL BE ON THE LEFT SIDE OF THE PLANE.

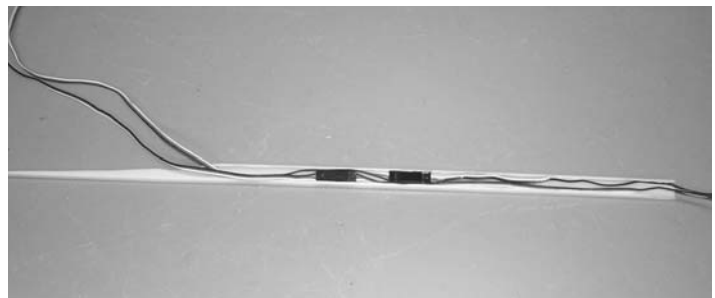

USING THE TEMPLATE PROVIDED IN THE BACK OF THE BOOKLET, CUT THE ELEVATOR, RUDDER SERVO LEAD COVER TO THE SHAPE SHOWN ON ONE END. TRANSFER THE LOCATION OF THE EXIT HOLE ON THE TEMPLATE TO THE COVER. DO NOT CUT THE LENGTH OF THE TUBE, LEAVE FULL LENGTH.

EX-TREME 540 3-D ARF

IT WILL BE NECESSARY TO CUT THE BACK SIDE OUT OF THE NYLON COVER FOR THE WIRES TO FIT IN. USING A SHARP KNIFE, CUT 1/16" INSIDE THE EDGE OF THE COVER. MAKE SURE YOU ARE CUTTING THE BACK SIDE, IT FITS ON THE RIGHT SIDE OF THE PLANE. THE WIRES CAN THEN BE FITTED INSIDE BY STAGGERING THE PLUGS.

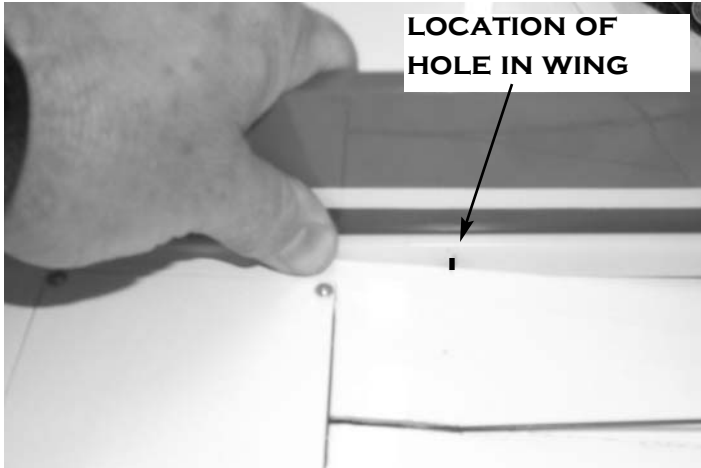

HOLD THE WIRE COVER AGAINST THE BOTTOM OF THE WING ON THE LEFT SIDE WITH THE OTHER END CENTERED BETWEEN THE SERVOS AND MARK THE LOCATION OF THE EXIT HOLE INTO THE WING.



CUT A HOLE NEXT TO FUSELAGE LARGE ENOUGH TO GET THE SERVO PLUGS THROUGH BUT NOT SO WIDE AS THE COVER WILL NOT HIDE IT.



YOU WILL NEED A 12" SERVO EXTENSION FOR BOTH RUDDER AND ELEVATOR SERVOS. FIT THE WIRES INTO THE COVER, AND LEADS INTO THE OPENING IN THE WING. SECURE THE COVER IN PLACE WITH THE TWO METAL BRACKETS AND FOUR 2.5MMX10MM SCREWS. DRILL A 1/16" PILOT HOLE AND HARDEN WITH THIN CA.



TAKE TWO FOUR HOLE CONTROL HORNS AND INSTALL ON RUDDER AND ELEVATOR SERVO. THE RUDDER SERVO ARM POINTS UP THE ELEVATOR ARM POINTS DOWN. USE A PUSHROD TO ALIGN RUDDER HORN PARALLEL TO SERVO ARM AND MOUNT ON RUDDER USING THE TWO 2MMX20MM SCREWS AND NYLON PLATE.

EX-TREME 540 3-D ARF



ALIGN THE ELEVATOR HORN ON THE INSIDE EDGE OF THE ELEVATOR AND MOUNT USING THE TWO #2X1" SCREWS AND NYLON PLATE.

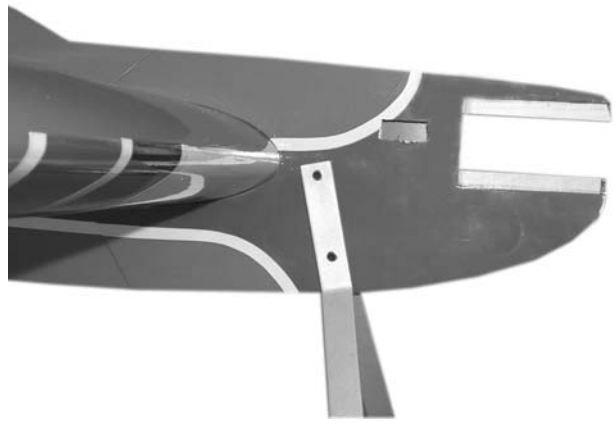

CUT THE COVERING FROM THE THROTTLE SERVO CUTOUT JUST BEHIND ENGINE MOUNT. THE OPENING IS MADE FOR A MINI SERVO. IF YOU USE A STANDARD SERVO YOU WILL NEED TO CUT THE OPENING LARGER. TRIAL FIT YOUR ENGINE. THE RIGHT THRUST IS BUILT IN. POSITION THE ENGINE SO YOU HAVE ABOUT 1/4" CLEARANCE FROM THE FRONT OF THE PROP HUB TO THE FRONT OF THE FUSELAGE. MARK THE HOLE LOCATIONS AND DRILL A 1/8" HOLE FOR THE 3MMX20MM BOLTS. MOUNT ENGINE USING THE EIGHT 3MM WASHER AND FOUR AIRCRAFT LOCK NUTS.

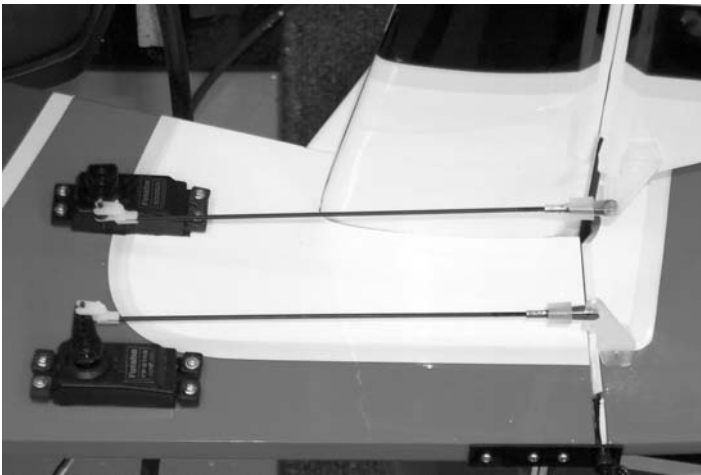

LOCATE THE TWO 2MM PUSHRODS WITH CLEVIS AND INSTALL THE SILICONE KEEPER ON CLEVIS. HOOK CLEVIS TO HORN AND MARK WHERE IT MEETS THE SERVO ARM. MAKE A 90 DEGREE BEND AND CUT AT 3/8". YOU WILL NEED TO DRILL OUT THE SERVO ARM WITH YOUR 5/64" DRILL AND INSTALL THE ROD USING THE NYLON SNAPPER-KEEPER TO RETAIN IT. DO THIS TO BOTH RUDDER AND ELEVATOR.

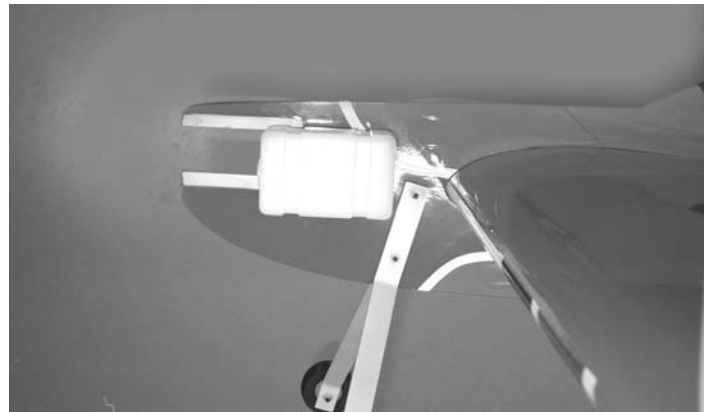

LOCATE THE FUEL TANK AND POSITION IT ON THE LEFT SIDE OF THE FUSELAGE. MARK THE LOCATION OF THE HOLES FOR THE TIE WRAPS AT THE TOP AND BOTTOM OF TANK ALIGNED WITH THE GROVES IN THE TANK. PAY ATTENTION TO THE LIGHTNING HOLES IN THE FRONT OF THE FUSELAGE UNDER THE COVERING AND MAKE SURE YOU ARE NOT OVER ONE OF THEM. DRILL A 3/16" HOLE AT THE FOUR LOCATIONS MARKED. TWO PIECES OF Balsa ARE SUPPLIED TO SPACE THE TANK OUT FROM THE FUSELAGE.

EX-TREME 540 3-D ARF

. IF YOU USE A MINI SERVO THESE WILL NOT BE USED. IF YOU USE A STANDARD SERVO YOU WILL NEED THEM TO CLEAR THE SERVO.

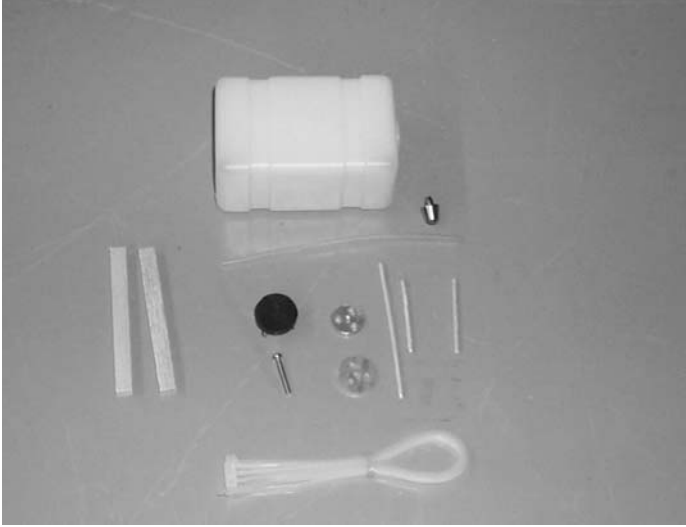

ASSEMBLE THE TANK CAP WITH THE BIG WASHER, THE RUBBER STOPPER, AND THE LITTLE WASHER IN THE REAR. FOR A TWO LINE SYSTEM WE WILL ONLY USE THE LONG PIECE OF ALUMINUM TUBE AND ONE SHORT ONE.

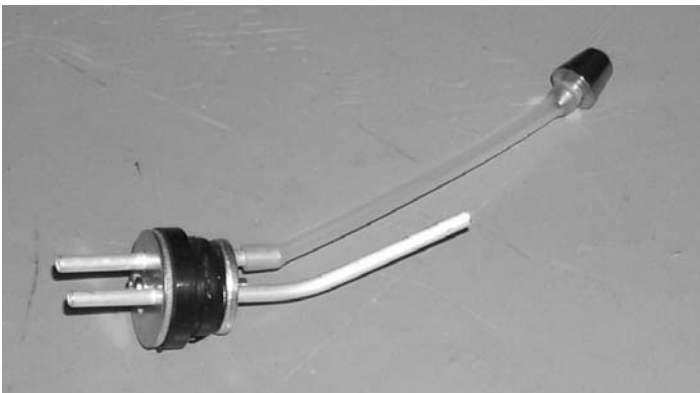

INSERT THE TUBES THROUGH THE STOPPER AND ATTACH THE SILICONE TUBING ON THE SHORT ONE. CUT THE TUBING SO THAT WHEN THE CLUNK IS ATTACHED IT WILL BE ABOUT 1/4" OFF THE BOTTOM OF THE TANK WHEN HELD VERTICALLY. LEAVE THE TUBES OUT THE FRONT OF THE CAP ABOUT 3/4" AND BEND THE LONG TUBE AT A 45 DEGREE ANGLE SO IT GOES TO THE TOP OF THE TANK WHEN INSTALLED.



INSTALL STOPPER IN TANK AND TIGHTEN THE BOLT IN THE CENTER UNTIL STOPPER IS SNUG. DON'T OVER TIGHTEN. CLUNK SHOULD MOVE FREELY AND VENT TUBE SHOULD BE TO THE TOP OF THE TANK.

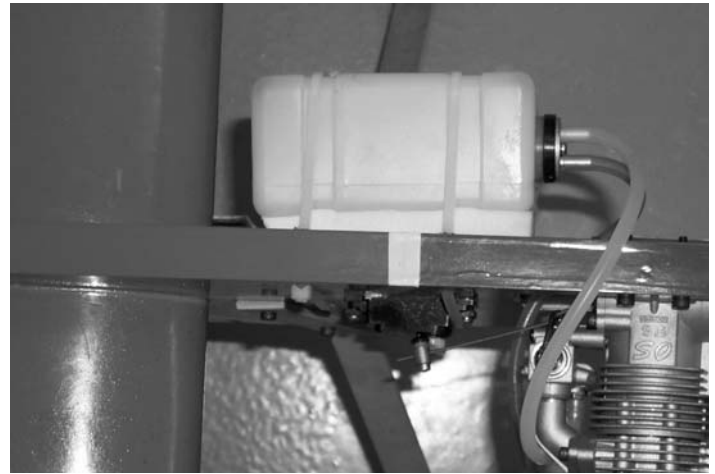

MOUNT THE TANK USING THE CABLE TIES THROUGH THE HOLES YOU DRILLED. PUT A 1/2" PIECE OF FOAM RUBBER (NOT SUPPLIED) UNDER THE TANK TO PREVENT FOAMING. DO NOT TIGHTEN THE TANK DOWN TIGHT, LET IT MOVE AROUND ON THE FOAM OR YOU WILL GET FOAMING OF THE FUEL.

EX-TREME 540 3-D ARF

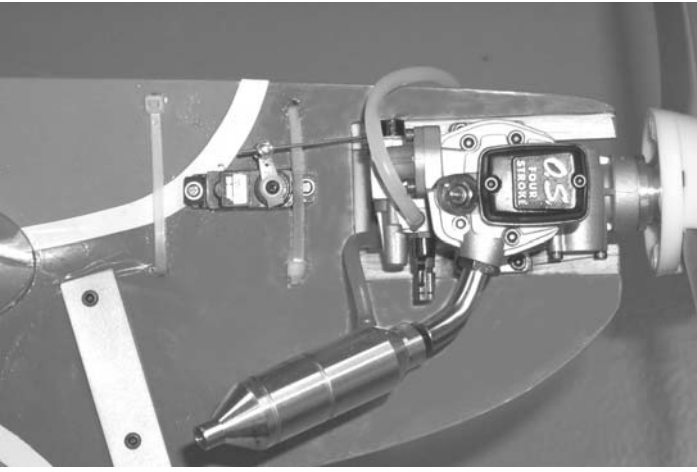

MOUNT THE THROTTLE SERVO USING THE HARDWARE SUPPLIED WITH THE RADIO. USE THE 1.5 MM X 6" PUSHROD AND BEND A Z BEND IN ONE END AND ATTACH TO THE THROTTLE ARM ON MOTOR. ATTACH THE E-Z CONNECTOR TO A THREE HOLE SERVO ARM AND ATTACH TO SERVO.

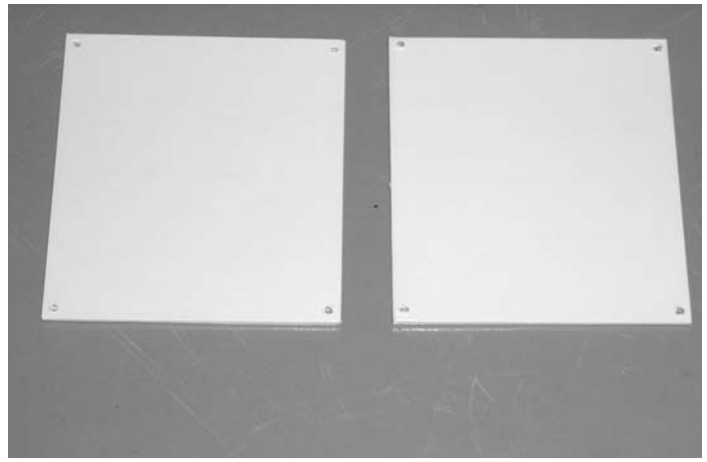

LOCATE THE TWO HATCH ACCESS DOORS. DRILL A 3/32" HOLE IN ALL FOUR CORNERS OF EACH HATCH. SPACE THE HOLES OFF EACH SIDE 3/32".

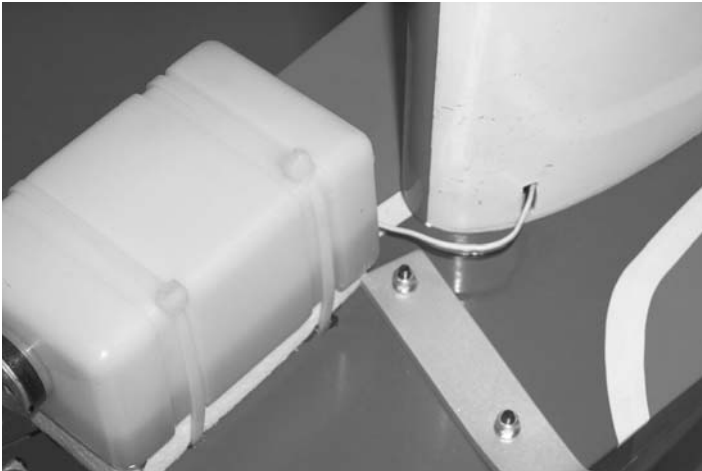
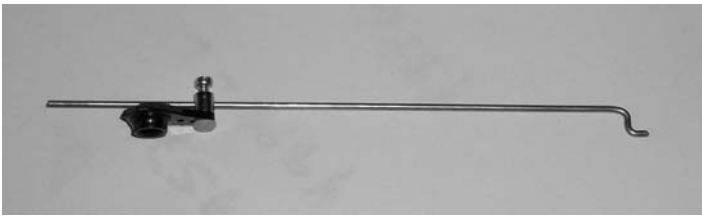

MAKE A SMALL HOLE ON THE BOTTOM OF THE WING ON THE LEFT SIDE TO PASS THE THROTTLE SERVO LEAD INTO THE WING. YOU WILL NEED AN EXTENSION TO GET TO THE RECEIVER.



AFTER ALL WIRES ARE PLUGGED INTO RECEIVER AND BATTERY PACK INSTALL THE COVERS BY DRILLING A 1/16" PILOT HOLE THROUGH THE HOLE IN THE COVER AND ATTACH USING THE FOUR 2.5MM X 8MM WASHER HEAD SCREWS.

INSTALL THE PROPER PROP FOR THE ENGINE YOU HAVE CHOSEN AND A 2-1/4" SPINNER. SET THE CONTROL THROWS TO 3/8" BOTH DIRECTIONS ON LOW RATE AND ALL YOU CAN GET ON HIGH. ON HIGH RATE USE 60 PERCENT EXPONENTIAL. BE SURE TO USE THE PROPER PLUS OR MINUS DEPENDING ON THE RADIO SYSTEM USED. THIS AIRPLANE IS VERY SENSITIVE ON HIGH RATE SO BE READY FOR IT.

EX-TREME 540 3-D ARF

THE CG SHOULD BE BETWEEN 4-3/4" AND 5-1/4" FOR FIRST FLIGHT. FOR 3-D IT CAN BE MOVED BACK AFTER YOU ARE COMFORTABLE WITH THE PLANE.

HAVE FUN!

ADDITIONAL EQUIPMENT NEEDED TO COMPLETE YOUR EX-TREME 540 3-D

MINIMUM OF 4 CHANNEL RADIO SET REQUIRED.

(4) STANDARD SERVOS (1) MINI SERVO 70OZ. SERVOS RECOMMENDED FOR HIGH HORSEPOWER ENGINES.

(3) 12" SERVO EXTENSIONS

DUBRO #222 MEDIUM FUEL TUBING

DUBRO #514 1/2" FOAM RUBBER

2-1/4 TO 2-1/2" SPINNER

.32 - .46 TWO STROKE ENGINE OR .40 TO .63 FOUR STROKE R/C ENGINE AND MUFFLER.

PROP FOR YOUR ENGINE CHOICE.

EX-TREME 540 3-D ARF

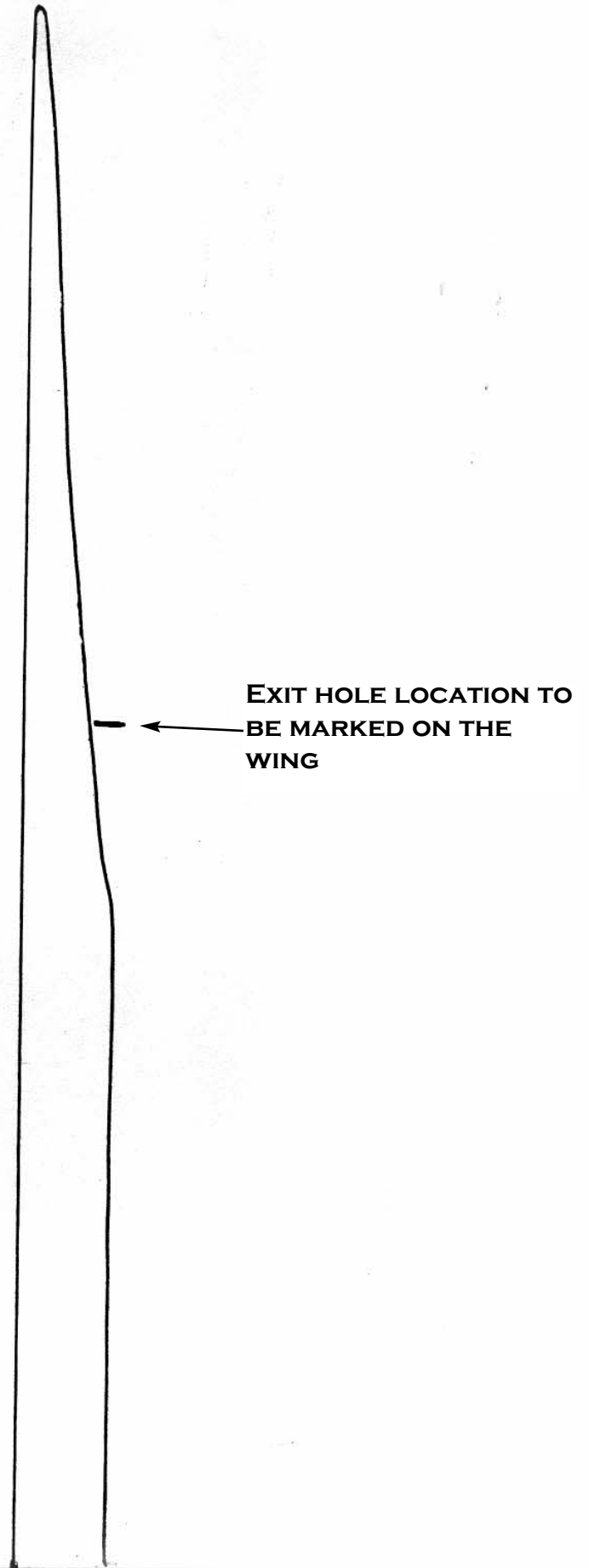

EX-TREME 540 3-D ARF

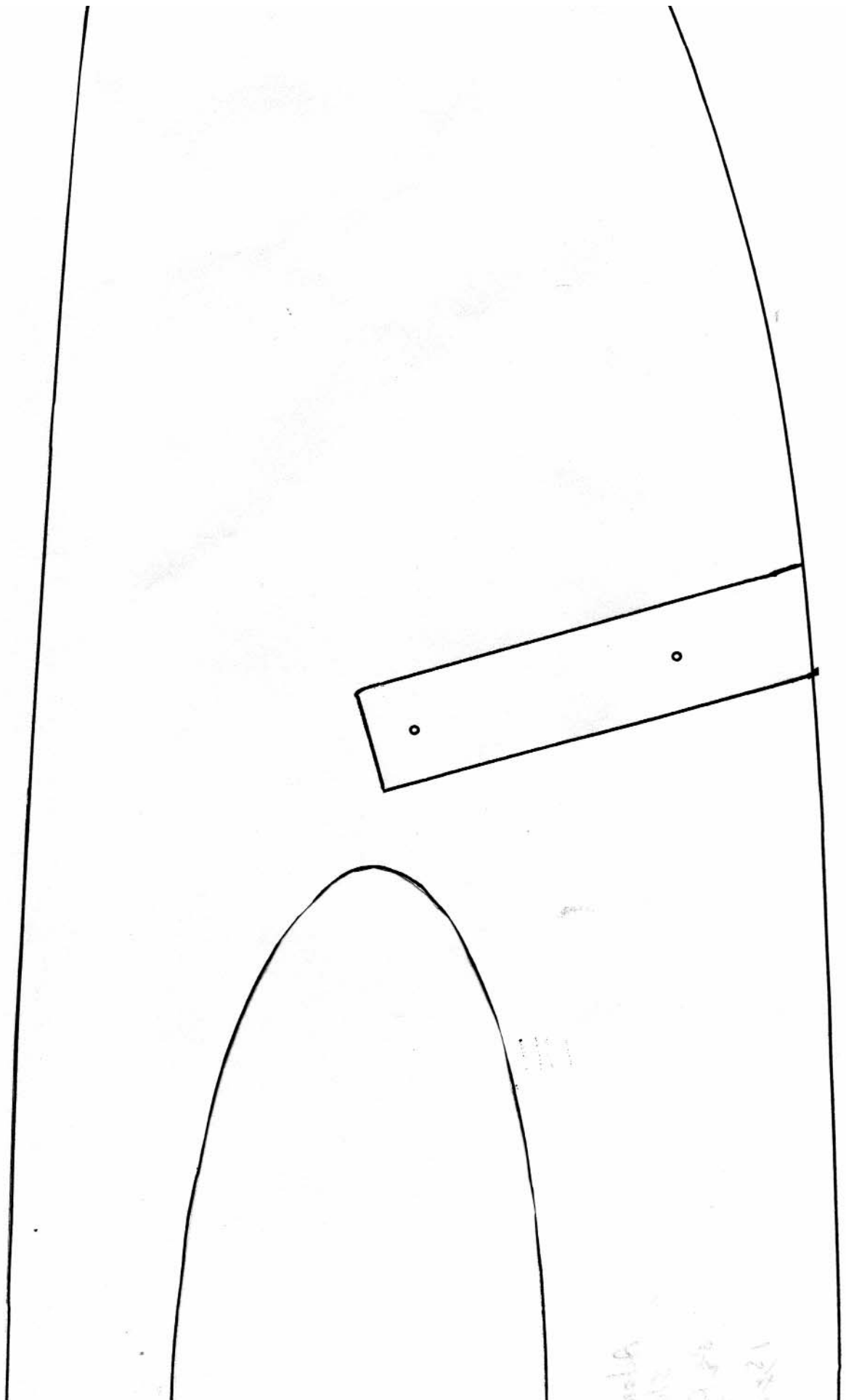

Optional Landing Gear Available

MAKE YOUR EDGE DIFFERENT FROM THE CROWD!

Our **New # 257 Profile landing gear** will fit your Extreme 540 and look great too. This landing gear also includes our **New #302 5/32" x 1-1/2" Polished Nickel Landing Gear Axle** to give you extra value.

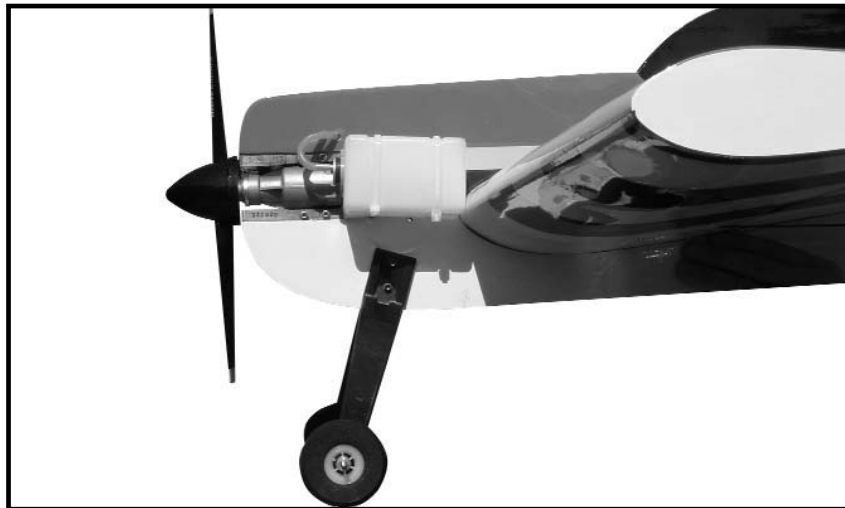

1. Mount the nylon gear in the same location as the aluminum gear.
2. Use (4) 4-40 x 1-1/2" bolts with washers and locking nuts.

Caution: Make sure that you center the gear between the lighting holes in the fuselage sides.



EX-TREME 540

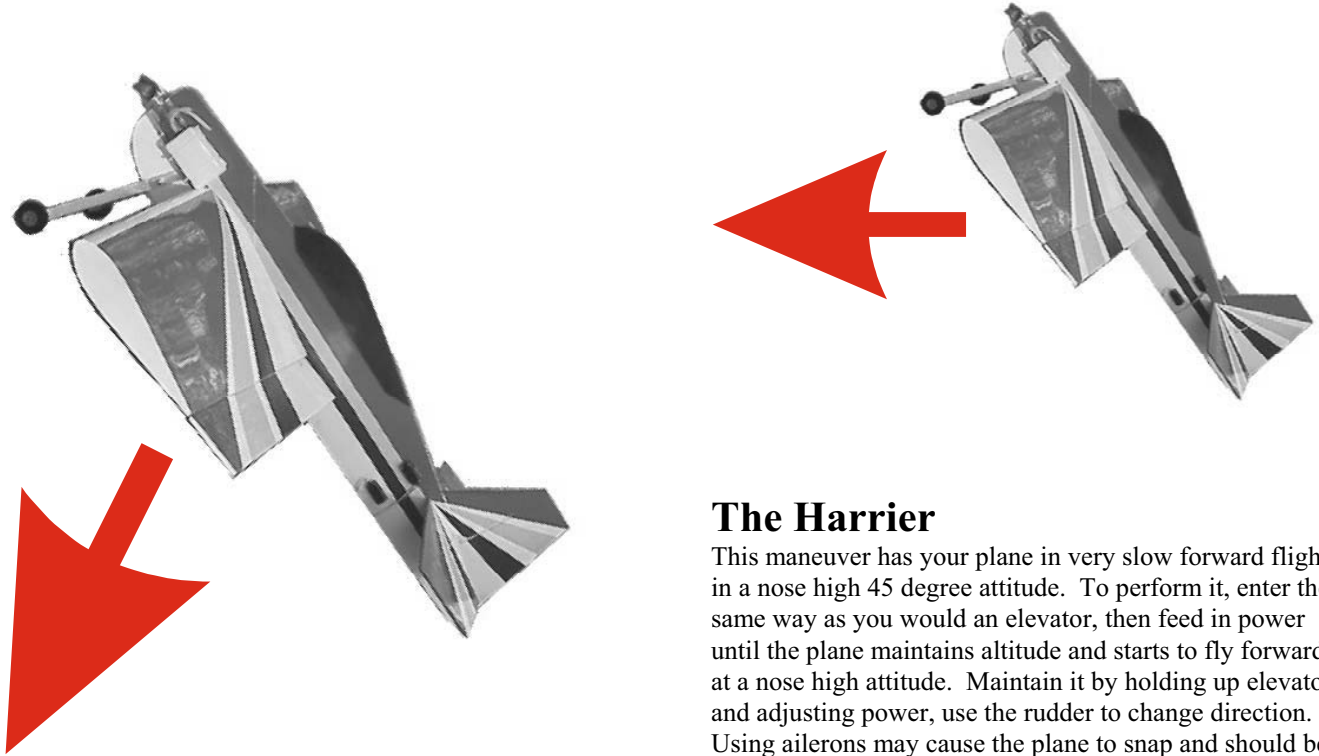

The Elevator

This maneuver has your plane drop vertically in a nose high attitude, depending on wind conditions any where from a 45 degree angle in low wind to almost backwards in higher wind conditions. To perform it, at a high altitude with high rates on, pull your throttle back and feed in the elevator until you have the full high rate applied. Use the rudder to guide the plane, and adjust attitude with minor throttle inputs. You will lose altitude quickly, to recover, apply full power and fly out level. Watch out for getting too low or applying too much rudder, it could cause the plane to snap.

The Harrier

This maneuver has your plane in very slow forward flight in a nose high 45 degree attitude. To perform it, enter the same way as you would an elevator, then feed in power until the plane maintains altitude and starts to fly forward at a nose high attitude. Maintain it by holding up elevator and adjusting power, use the rudder to change direction. Using ailerons may cause the plane to snap and should be avoided. Add power and push the nose back over to recover.

EX-TREME 540

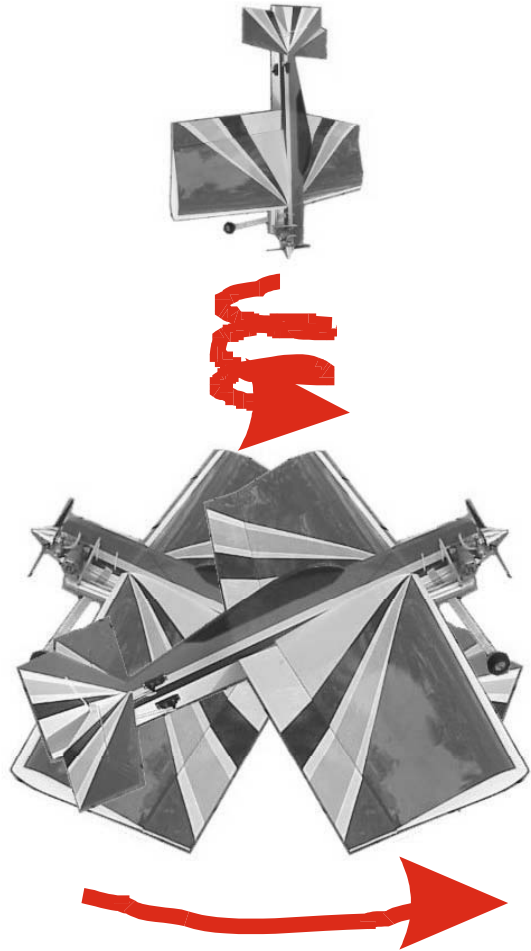

The Waterfall

This maneuver has your plane flipping around the axis of the wing, while dropping. Starting from a high altitude, go to low throttle and gradually pull the nose up to near vertical. Just when the plane is about the stall, give it full down elevator and full power. Make attitude corrections with the rudder and ailerons to keep the plane flipping on axis. Cut the throttle and hold full down elevator as the plane flips around to nose high again, add power to flip it over again. Watch your altitude as to not get too close to the ground. Neutralize the elevator and add power to recover.

The Blender

This is a violent maneuver that starts with a vertical rolling dive that stops the descent as it changes into a flat spin. Start at a good high altitude, go to low throttle and push the nose down into a straight dive. Feed in full left aileron and complete 3 rolls, then immediately move your transmitter sticks to an inverted snap position, down elevator, left aileron, right rudder, all full throw. Now feed in high throttle to flatten the spin and stop the altitude loss. Recover by neutralizing the rudder and ailerons, and holding a little down elevator. After you gain some airspeed you can roll out to upright. Use caution as this is a violent and high G maneuver that will put a great deal of stress on the airframe.