



TOSHIBA

Carrier

AIR CONDITIONER (SPLIT TYPE)

Owner's Manual



Indoor Unit

Model name:

4-way Air Discharge Cassette Type

RAV-SP180UT-UL

RAV-SP240UT-UL

RAV-SP300UT-UL

RAV-SP360UT-UL

RAV-SP420UT-UL

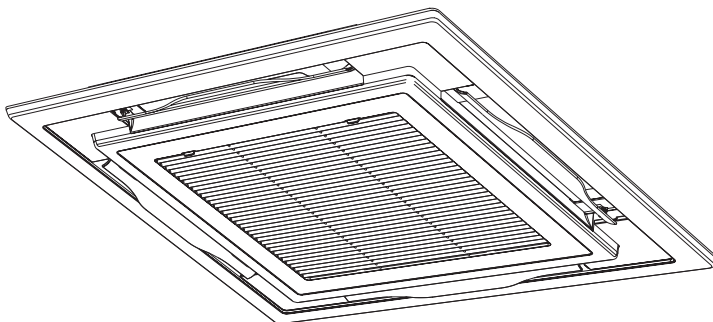

Owner's Manual
Air conditioner (Split type)

1 English

Manuel du propriétaire
Climatiseur (Type à deux éléments) 27

Français

Thank you very much for purchasing TOSHIBA/Carrier Air Conditioner.
 Please read this owner's manual carefully before using your Air Conditioner.

- Be sure to obtain the "Owner's manual" and "Installation manual" from the contractor or dealer.

Request to contractor or dealer

- Please clearly explain the contents of the Owner's manual and hand over it.

ADOPTION OF NEW REFRIGERANT

This Air Conditioner uses R410A an environmentally friendly refrigerant.

Contents

1.	PRECAUTIONS FOR SAFETY	2
2.	SYSTEM CHARACTERISTICS	4
3.	ENERGY SAVING RECOMMENDATIONS	5
4.	PART NAMES	6
5.	WIRED REMOTE CONTROL	7
6.	CORRECT USAGE	10
7.	TIMER OPERATION	12
8.	LOUVER DIRECTION	13
9.	POWER SAVING MODE	16
10.	SELF CLEANING MODE	16
11.	ADVANCED SETTINGS	17
	Swing mode	17
	Louver lock (No swing)	18
	Cancel louver lock	19
	Change power saving mode setting	19
12.	MAINTENANCE	20
13.	INFORMATION FOR INSTALLATION	22
14.	TROUBLE SHOOTING	24

1. PRECAUTIONS FOR SAFETY

⚠ WARNING

WARNINGS ABOUT INSTALLATION

- Make sure to ask the qualified installation professional in electric work to install the air conditioner.
If the air conditioner is inappropriately installed by yourself, it may cause water leak, electric shock, fire, and so on.
- Be sure to connect ground wire. (grounding work)
Incomplete grounding causes an electric shock.
Do not connect ground wires to gas pipes, water pipes, lightning rods or ground wires for telephone wires.
- If you install the indoor unit in a small room, take appropriate measures to prevent the refrigerant from exceeding the limit concentration even if it leaks.
Consult the dealer from whom you purchased the air conditioner when you implement the measures. Accumulation of highly-concentrated refrigerant may cause an oxygen deficiency accident.
- Check whether the piping work has been properly completed.
When existing pipes are used and if they are not constructed properly, the refrigerant gas may leak. Contact the installation company and confirm that the piping work has been properly completed. For details of installation of the air conditioner, refer to the Installation Manual. Use tools and piping materials for R410 only. Failure to do so or improper installation may cause a burst of pipe, resulting in injury.



WARNINGS ABOUT OPERATION

- Cleaning of the air filter and other parts of the air filter involves dangerous work in high places, so be sure to have a service person do it.
The self-cleaning function of the air conditioner causes the internal fan to run at a high speed in some modes even while the air conditioner is not working, which may cause injury.
Do not attempt it yourself.
- Avoid cooling the room too strong or exposing the human body to cool breeze for a long time as it is bad for the health.
- When you notice something abnormal with the air conditioner (smells like something scorching, poor cooling, etc.), immediately turn off the main switch and the circuit breaker, from the mains to stop the air conditioner, and contact the dealer.
If the air conditioner is continuously operated with something abnormal, it may cause machine failure, electric shock, fire, and so on.

WARNINGS ABOUT MOVEMENT AND REPAIR

- When the air conditioner cannot cool or heat a room well, contact the dealer from whom you purchased the air conditioner as refrigerant leakage is considered as the cause. In the case of repair that requires refill of refrigerant, ask service personnel about details of the repair.
The refrigerant used in the air conditioner is harmless.
Generally, the refrigerant does not leak. However, if the refrigerant leaks in a room and a heater or stove burner in the room catches fire, it may generate toxic gas.
When you ask service personnel for repairing refrigerant leakage, confirm that the leakage portion has been completely repaired.
- Do not move or repair any unit by yourself.
Since there is high voltage inside the unit, you may get electric shock when removing the cover and main unit.
- Whenever the air conditioner needs repair, make sure to ask the dealer to do it.
If it is repaired imperfectly, it may cause electric shock or fire.
- When moving the air conditioner for re-installing at another place, ask the dealer to do it. If it is imperfectly installed, it may cause electric shock or fire.

 **CAUTION****CAUTIONS ABOUT INSTALLATION (Be sure to confirm the following cautions.)**

- Use an exclusive power circuit for the air conditioner. Use the rated voltage.
- Certainly lay the drain hose for perfect draining.
Bad drainage may cause flooding in the house and getting furniture wet.
- Make sure to connect the air conditioner to an exclusive power supply of the rated voltage, otherwise the unit may break down or cause a fire.
- Do not install the unit in a place where inflammable gas may leak.
If inflammable gas accumulates around the unit, it may cause a fire.

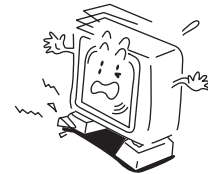
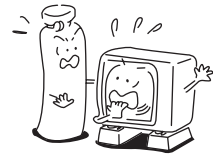
**CAUTIONS ABOUT OPERATION**

- Carefully read this manual before starting the air conditioner.
There are many important things to keep in mind for daily operation.
- Do not use this air conditioner for special purpose such as preserving food, precision instruments, art objects, breeding animals, car, vessel, etc.
- When the air conditioner is operated with a combustion appliance in the same place, be careful of ventilation to let fresh air enter the room.
Poor ventilation causes oxygen shortage.
- Do not place any combustion appliance in a place where it is directly exposed to the wind of air conditioner, otherwise it may cause imperfect combustion.
- When the air conditioner is used in a closed room, be careful of sufficient ventilation of the room.
Poor ventilation causes oxygen shortage.
- Do not touch any switches with wet fingers. You may get an electric shock.
- If the air conditioner won't be used for a long time, turn off the main switch or the circuit breaker, for safety.
- Do not put anything on the outdoor unit or step on it.
If you do, the unit may topple over or you may get injured.
- To make the air conditioner operate in its original performance, operate it within the range of the operating temperature specified in the instructions.
Otherwise it may cause a malfunction, or water leak from the unit.
- Do not expose the remote control to any liquid.

2. SYSTEM CHARACTERISTICS

Air conditioner operating conditions

For proper performance, operate the air conditioner under the following temperature conditions:

Cooling operation	Outdoor temperature	: 23 °F to 109.4 °F (-5 °C to 43 °C) *
	Room temperature	: 69.8 °F to 89.6 °F (21 °C to 32 °C) (Dry bulb temperature), : 59 °F to 75.2 °F (15 °C to 24 °C) (Wet bulb temperature)
	[CAUTION]	Room relative humidity – less than 80 %. If the air conditioner operates in excess of this figure, condensation may occur on the surface of the air conditioner.
Dry operation	Outdoor temperature	: 59 °F to 109.4 °F (15 °C to 43 °C)
	Room temperature	: 62.6 °F to 89.6 °F (17 °C to 32 °C)
Heating operation	Outdoor temperature	: -4 °F to 59 °F (-20 °C to 15 °C) (Wet bulb temperature)
	Room temperature	: 59 °F to 86 °F (15 °C to 30 °C) (Dry bulb temperature)

*: The air conditioner can be operate when outside temperature is 5°F to 23°F (-15°C to -5°C). Installing wind baffle to the outdoor unit is necessary to operate the air conditioner in that outside temperature range. For further details, refer to the installation manual of the outdoor unit.

If air conditioner is used outside of the above conditions, safety protection may work.

3 minute protection function

There is a 3-minute time delay between compressor starts.

Auto restart

The unit will stop after a power failure.

- The unit will restart automatically in the same operating mode as before the power failure when the power is restored.

Fan operation

Heating

- When there is a call for heating, the fan will not start right away. There is a delay of approximately 5 minutes to ensure that the indoor heat exchanger warmed up.
- When the room temperature reaches the set temperature, the fan will run at ultra low speed to avoid blowing cold air on the occupants in the space.

Cooling

When the room temperature reaches the set temperature, the fan will run at ultra low speed.

Defrost

When the unit is operating in the heating mode frost forms on the outdoor heat exchanger.

When this occurs, defrost is initiated automatically. During the defrost period (2 to 10 minutes) both the indoor and outdoor units stop running.

- A hissing noise might be heard when the defrost cycle is initiated.
- During the defrosting operation, the defrosted water will be drained from the bottom plate of the outdoor unit.

Heating capacity

In the heating operation, the heat is absorbed from the outside and brought into the room. This way of heating is called heat pump system. When the outside temperature is too low, it is recommended to use another heating apparatus in combination with the air conditioner.

Attention to snowfall and freeze on the outdoor unit

- In snowy areas, the air inlet and air outlet of the outdoor unit are often covered with snow or frozen up. If snow or freeze on the outdoor unit is left as it is, it may cause machine failure or poor warming.
- In cold areas, pay attention to the drain hose so that it perfectly drains water without water remaining inside for freeze prevention. If water freezes in the drain hose or inside the outdoor unit, it may cause machine failure or poor warming.

3. ENERGY SAVING RECOMMENDATIONS

Select a comfortable set point and minimize adjusting it.

- Clean the filter when ever the filter display  is illuminated on remote control.
- Keep doors and windows closed and open them only when necessary.
- Use drapes, curtains, or shades to keep direct sun light from heating the room on very hot days.
- Do not obstruct the return air grille.
- Adjust the air flow direction for even air distribution in the room.

Checks before operating

- Check whether the ground wires are properly connected.
- Check whether the air filters are installed.
- Turn on the circuit breaker the initial startup or after an extended shut down.

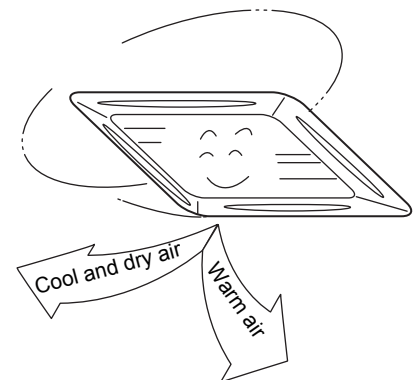
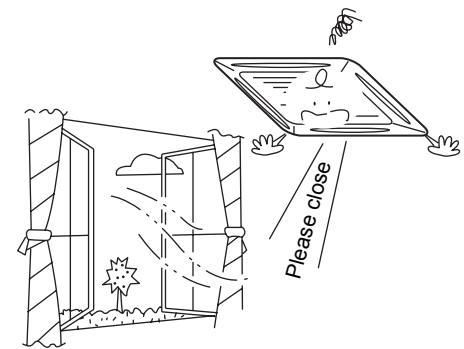
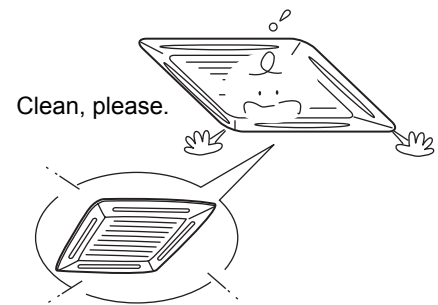

4. PART NAMES

Indoor unit

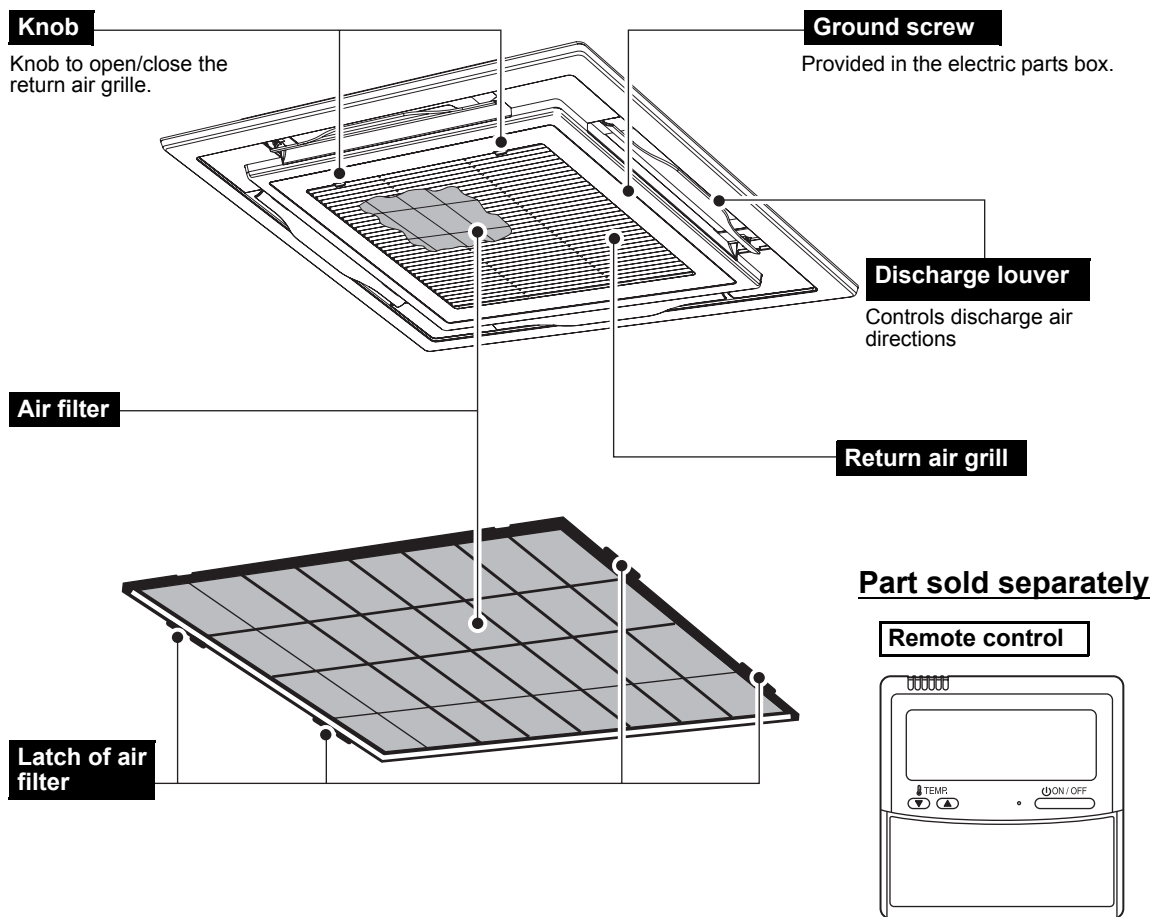

Outdoor unit

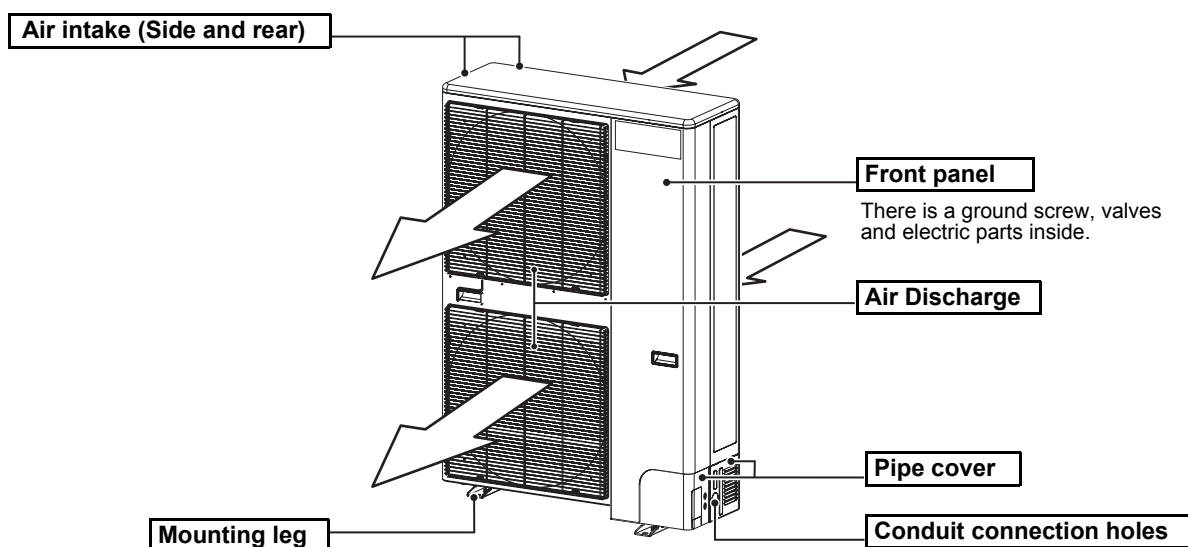

* The image of the outdoor unit in the figure is in the case Model RAV-SP420AT2-UL.

5. WIRED REMOTE CONTROL

This remote control can control the operation of up to 8 indoor units.

The remote control has two sections: The display section and the operation section.

■ Display section

In the display below all the icons are shown. When the unit is in operation, only relevant icons will be displayed.

- When the circuit breaker is turned on the first time, **SETTING** flashes on the display part of the remote control.
- While this display is flashing, the model is being automatically confirmed. Wait till **SETTING** display has disappeared to use the remote control.

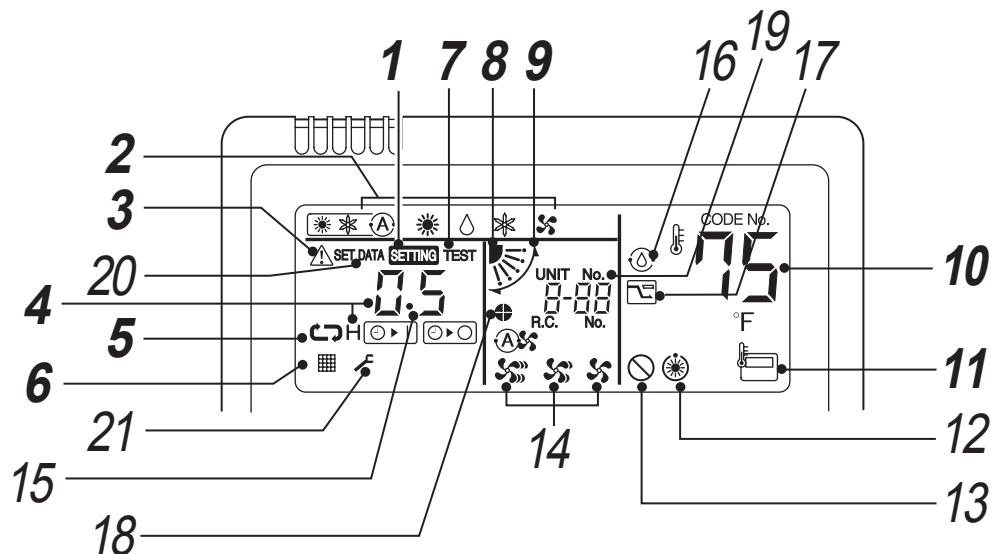
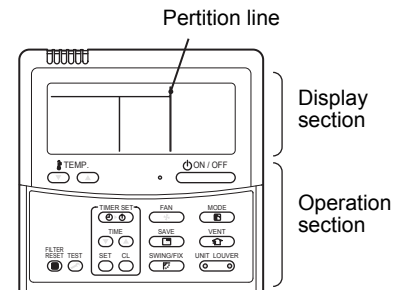

- | | |
|--|---|
| <p>1 SETTING display
Displayed during setup of the timer etc..</p> <p>2 Operation mode
The selected operation mode is displayed.</p> <p>3 Error display
Displayed while the protective device works or a error occurs.</p> <p>4 Timer display
When a malfunction occurs, an error code is displayed.</p> <p>5 Timer Mode display
Displays the timer mode.</p> <p>6 Filter display
☐, reminder to clean the air filter.</p> | <p>7 TEST run display
Displayed during a test run.</p> <p>8 Louver position display
Displays louver position.</p> <p>9 Swing display
Displayed during up/down movement of the louver.</p> <p>10 Set temperature display
The selected set temp. is displayed.</p> <p>11 Remote control sensor display
Displayed while the sensor of the remote control is used.</p> |
|--|---|

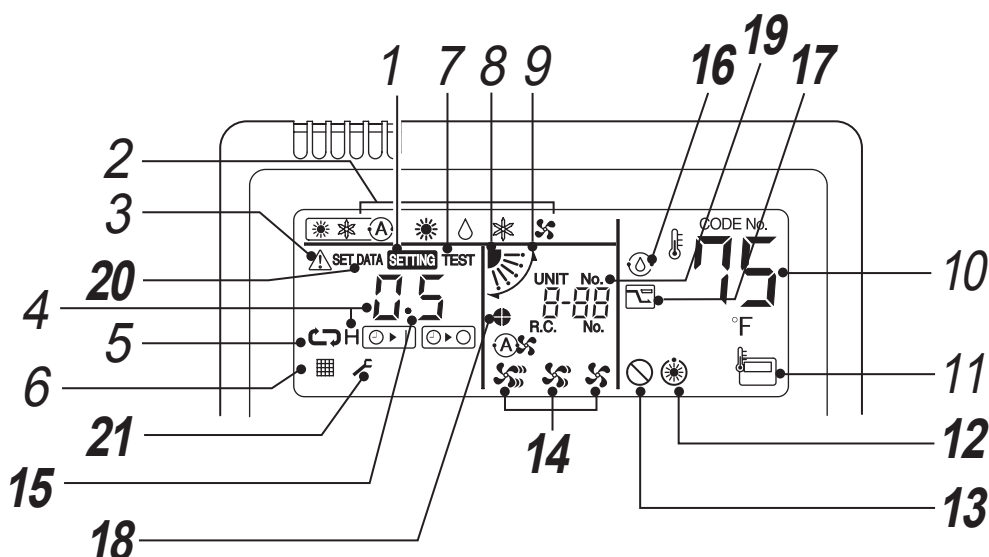

12 Pre-heat display

Displayed when the heating mode is energized or defrost cycle is initiated. While this indication is displayed, the indoor fan stops.

19 UNIT No. display

Displays the number of the indoor unit selected. Also displays error code of indoor and outdoor units

13 No function display

Displayed when the function requested is not available on that model.

20 SET DATA

Displayed during advanced setting.

14 Fan speed display

The selected fan speed mode is displayed.

21 Service display

- (AUTO) 
- (HIGH) 
- (MED.) 
- (LOW) 

15 Louver Number display.

Louvers can be controlled individually. Displays which louver is being set. (exapmle:01, 02, 03, 04)

16 Self cleaning display

Displayed during self cleaning operation to dry the indoor heat exchanger.

17 Power saving mode display

Limits compressor speed (capacity) to save energy.

18 Louver lock display









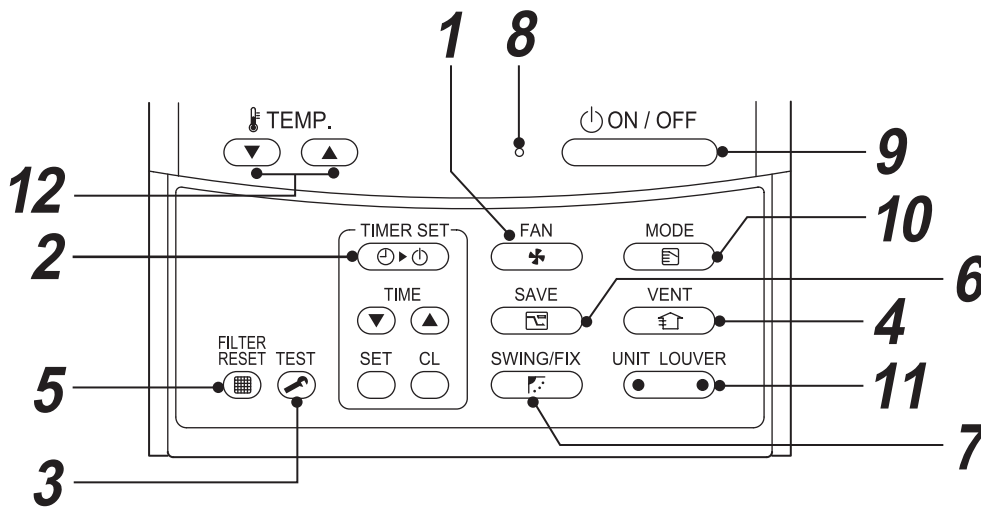







Displayed when louver is locked or there is a louver-locked unit in the group.

■ Operation section

Push each button to select a desired operation.

- The control saves commands in memory and after the initial setting, there is no need for any additional settings unless changes are desired. The air conditioner can be operated by pushing the  button.



- 1**  **button**
Selects the desired Fan speed.
- 2**  **button**
Use to setup the timer.
- 3**  **button**
Use only for service.
(During normal operation, do not use this button.)
- 4**  **button**
Use when a power ventilation kit (commercially-supplied) is connected.
- If “” is displayed on the remote control when pushing the Ventilation button, no vent kit connected.
- 5**  **button**
Resets “” display after cleaning filter.
- 6**  **button**
Use to initiate power saving mode.
- 7**  **button**
Use to select automatic swing or fixed louver position.
- 8** **Operation lamp**
Green light illuminates when unit is on.
Although it flashes when operating the protection device or an error occurs.
- 9**  **button**
When the button is pushed, the operation starts, and it stops by pushing the button again.
When the operation has stopped, the operation lamp and all the displays disappear.
- 10**  **button**
Selects desired operation mode.
- 11**  **button**
Selects a unit number (left) and louver number (right).
- UNIT :**
Selects an indoor unit when adjusting louver direction when multiple indoor units are controlled with one remote control.
- LOUVER :**
Selects a louver when setting louver lock or louver direction adjustment independently.
- 12**  **button**
Adjusts the set point.
Select the desired set point by pushing  TEMP.  or  TEMP. .

OPTION :

Remote control sensor

Usually the temperature sensor of the indoor unit senses the temperature. The temperature on the surrounding of the remote control can also be sensed. For details, contact the dealer from which you have purchased the air conditioner.

6. CORRECT USAGE

- When you use the air conditioner for the first time or when you change the setting, follow the steps below. Settings are saved in memory and are displayed anytime the unit is turned on by pushing the  button.

■ Preparation



- When the circuit breaker is turned on, the partition lines are displayed on the remote control.
- * After the circuit breaker is turned on, the remote control does not accept any commands for approx. 1 minute, this is not a failure.

REQUIREMENT

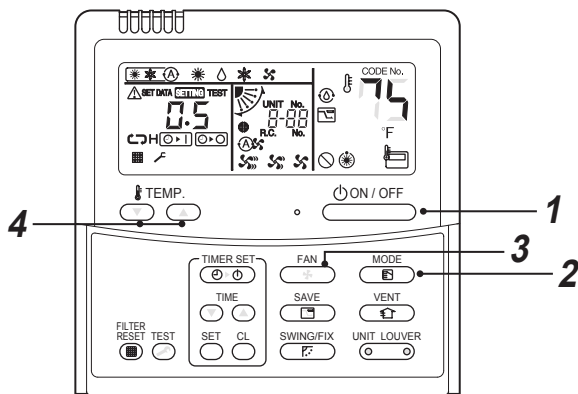
- When you re-power the air conditioner after it has not been used for a long period, turn on the circuit breaker at least 12 hours before starting the air conditioner.



Start



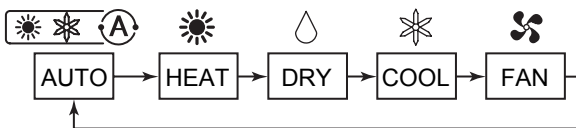

- 1 Push  button.**
The operation lamp illuminates, and the operation starts.
- 2 Select an operation mode with the “” button.**
One push of the button, and the display changes in the order shown below.

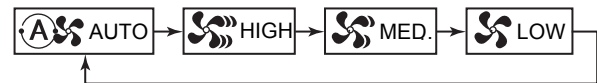

- 3 Select fan speed with “” button.**

One push of the button, and the display changes in the order shown below.



- When fan is in “ AUTO”, fan speed is adjusted based on difference between set point and room temperature.
- In heating operation, if the room temperature is not heated sufficiently with volume “ LOW” operation, select “ MED.” or “ HIGH” operation.
- The temperature sensor detects the return air temperature at the indoor unit, which differs from the room temperature depending on the installation condition. Set point is a target of room temperature. ( “AUTO” is not selectable in the FAN mode.)

- 4 Select the set point temperature by pushing the “TEMP. ” or “TEMP. ” buttons.**

Stop

- Push  button.**
The operation lamp goes off, and the operation stops. In the COOL, DRY, or AUTO (cooling) mode, the fan runs for 10 minutes (or more) for self cleaning.

NOTE**Auto Changeover**

- When in Auto Mode, the unit selects the operating mode (cooling, heating or fan only) based on the user selected set point temperature.
- If the Auto mode is uncomfortable, you can select the desired conditions manually.

Cooling

- If there is a demand for cooling, unit will start approximately 1 minute after mode is selected.

Heating

- If there is a demand for heating, unit will start approximately 3 to 5 minutes after the mode is selected.
- After the heating operation has stopped, FAN may continue to run for approx. 30 seconds.
- When the room temperature reaches the set temperature and the outdoor unit stops, the indoor unit fan runs at ultra low speed and the outdoor unit fan runs at low speed.
During defrost operation, the fan stops so that cool air is not discharged. (“❄️” Pre-heat is displayed.)

When restarting the operation after stop

- When attempting to restart the unit immediately after it was stopped, the unit can not start for approx. 3 minutes this is to protect the compressor.

7. TIMER OPERATION

- Three timer modes are available: (Setting of up to 168 hours is enabled.)
 OFF timer : The unit stops when the set time is reached.
 Repeat OFF timer : The unit stops daily when the set time is reached.
 ON timer : The unit starts when the set time is reached.

■ Timer operation

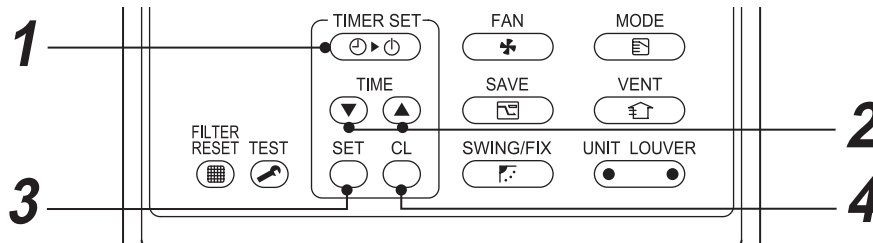

Set

1 Push **TIMER SET** button.

The timer mode changes with every push of the button.

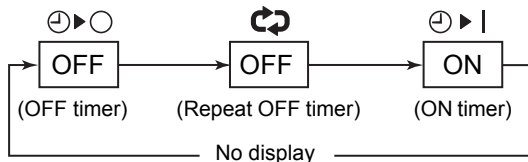

- **SETTING** and timer display flashes.

2 Push **TIME** to select "set time".

- With every push of **▲** button, the set time increases by 0.5 hr (30 minutes).
 When setting a time more than 24 hours for timer operation, timer can be set in increments of 1 hr.
 The maximum set time is 168hr (7 days).
 The remote control displays the set time with time (between 0.5 and 23.5 hours) (*1) or number of days and time (24 hours or more) (*2) as shown below.
- With every push of **▼** button, the set time decreases by 0.5 hr (30 minutes) (0.5 - 23.5 hours) or 1 hr (24 - 168 hours).

Example of remote control display

- In the case of 23.5 hours (*1)



- In the case of 34 hours (*2)

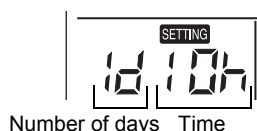

- 1d** shows 1 day (24 hours).
- 10h** shows 10 hours. (Total 34 hours)

3 Push **SET** button.

- **SETTING** display disappears and timer time display goes on, and **▶|** or **▶○** display flashes.
 (When ON timer is activated, timer time, ON timer **▶|** are displayed and other displays disappear.)

4 Cancel of timer operation

Push **CL** button.
 Timer display disappears.

NOTE

- When the operation stops after the timer reached the preset time, the Repeat OFF timer resumes the operation by pushing **ON/OFF** button and stops the operation after the time of the timer has reached the set time.
- When you push **SWING/FIX** while the OFF timer function of the air conditioner is active, the indication of the timer function disappears and then appears again after about 5 seconds.
 This is due to normal processing of the remote control.

8. LOUVER DIRECTION

For best cooling and heating performance, adjust the louvers appropriately. In cooling the louvers should be directed so that the air discharge is horizontal. In heating they should be directed to discharge towards the floor to prevent layers of hot air forming close to the ceiling.

CAUTION

Direct the louvers horizontally in cooling.

If the louvers are pointed downward in cooling, condensation may form on the louvers and then drop to the floor.

NOTE

If the louvers are horizontal when in heating, the room temperature may be uneven with hot air near the ceiling.

For cooling

Direct the louvers horizontally.

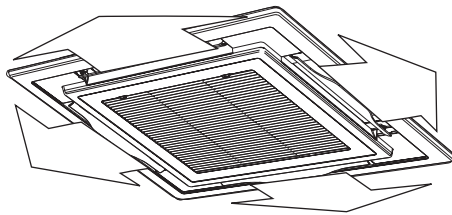

For heating

Direct the louvers downward.

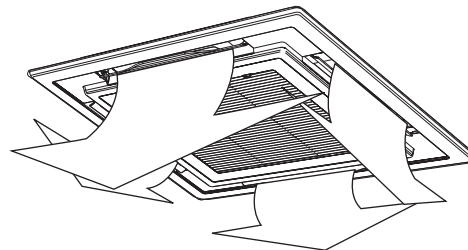

- When the air conditioner is off, the louvers are directed horizontally automatically.
- In the heating mode, at startup (the first 3 to 5 minutes), during defrost, and after the heating demand is satisfied (compressor turns off but fan runs at ultra low speed), the louvers are directed horizontally. If the swing or air direction is set during these periods, the remote control will display the selected option but the louvers will still be directed horizontally until the unit gets out of the three modes listed above, at which time the louvers are directed to the set position.

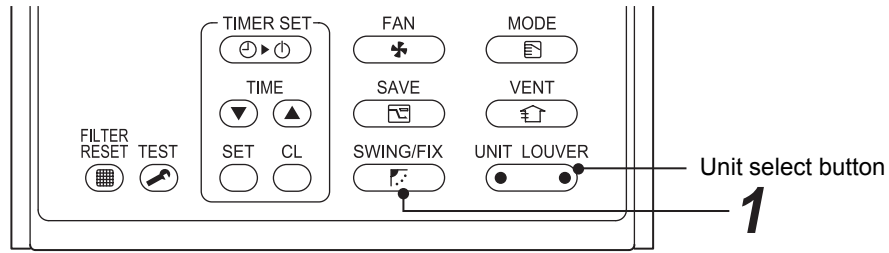

Set louver direction

1 Push during operation. The louver direction changes with every push of the button.

In HEAT operation

Direct the louver downward.

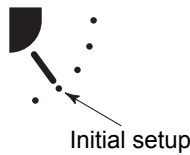

In COOL/DRY operation

Direct the louver horizontally.

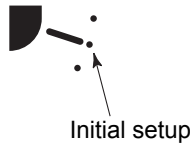

In FAN operation

Select a desired louver direction.

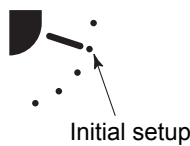

Start swing operation

1 Push , set the louver direction to the lowest position, and then push again. SWING is displayed and the louvers swing automatically.

Display during swinging

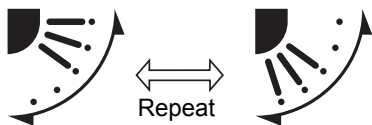

Stop swing operation

- 1** Push at a desired position while the louver is swinging.
- When is pushed after that, the louver direction can be set again from the highest position.
 - In COOL/DRY mode, the louver does not stop as it directs downward. If stopping the louver as it directs downward during swing operation, it stops after moving to the third position from the highest position.

Display when stopping the swing



Unit select

- When multiple indoor units are controlled with one remote control, louver position can be set for all indoor units or each indoor unit individually.
- To set louver direction for a particular unit, push button to display an indoor unit number in the control group. Then set the louver direction of the displayed indoor unit by following the steps outlined above.
- When no indoor unit number is displayed, all indoor units in the control group can be controlled simultaneously.
- Each time you push (left side of the button), the display changes as follows:

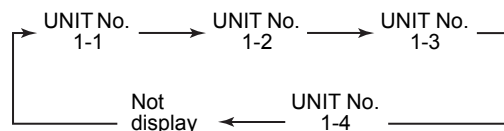

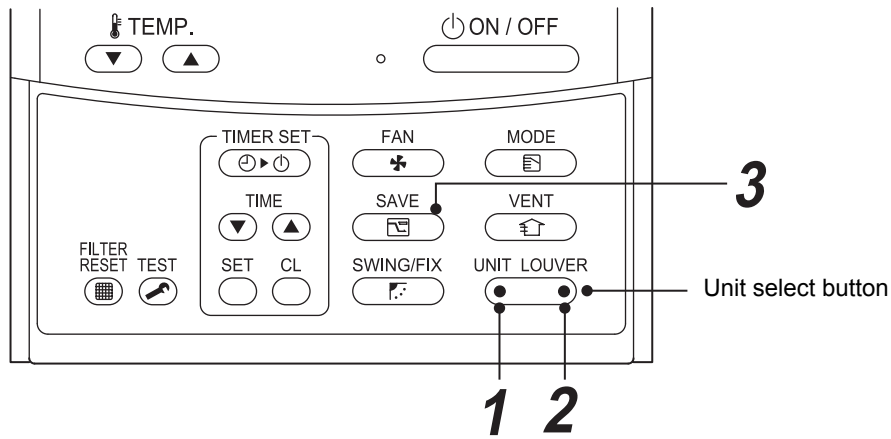

■ Set louver direction individually

1 Select an indoor unit to be set by pushing **UNIT LOUVER** (left side of the button) during operation.

- The indoor unit number changes each time you push the button.

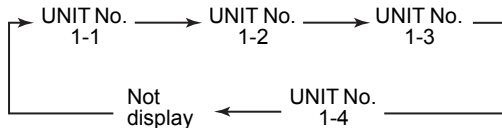

* When no unit number is displayed, all indoor units are selected.

2 Select a louver you want to adjust by pushing **UNIT LOUVER** (right side of the button).

- Each time you push the button, the display on the remote control changes as follows:



* When no louver number is displayed, all four louvers are selected.

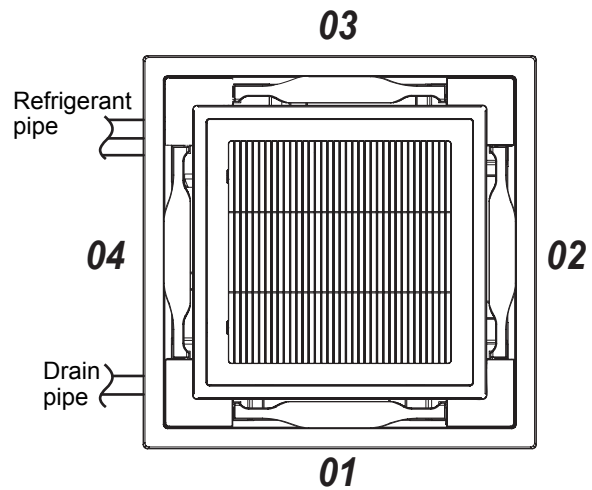
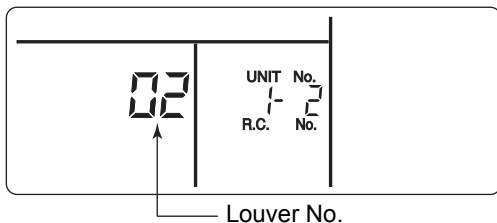

3 Determine louver direction of the selected louver by pushing **SWING/FIX**.

- Each time you push the button, the display changes as follows:

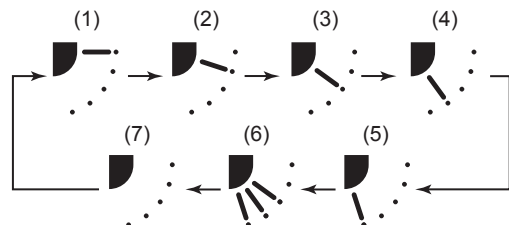

* During COOL (DRY) mode, (4) and (5) are not displayed.

9. POWER SAVING MODE

- The power saving mode saves energy by limiting the maximum current which will effect heating or cooling capacity that the unit can generate.

Push  button during operation.

- The air conditioner enters power saving mode.
-  appears on the display.

Power saving mode will stay in effect until it is cancelled.

To cancel the power saving mode, push  button again.

-  disappears.

NOTE

- Power saving mode consumes less energy, but may not heat/cool the room as much as normal mode. (The maximum current is limited to approximately 75% (factory default) of the normal mode.)
- This Value can be adjusted between 50% to 99% as outlined in Advanced settings.
- To adjust the power-save settings, see “Change power saving mode setting” in 11 ADVANCED SETTINGS.
- Even when operation start/stop, operation mode change, or power reset is performed during the power saving mode, the power saving mode is retained until the next operation.

10. SELF CLEANING MODE

This function is provided to dry the inside of the indoor unit by running the FAN mode after the compressor is stopped when the unit was running the COOL/DRY/AUTO (cooling) mode.

- The self cleaning time is a function of how long the unit ran in the cool or dry modes as shown below.

Cooling/dry/AUTO (cooling) operation time	self cleaning time
Less than 10 minutes	No self cleaning operation
10 minutes to less than 1 hour	1 hour
More than 1 hour	2 hours

- “” is displayed on the remote control during self cleaning operation.

To stop self cleaning, push  button twice in succession.

CAUTION

- The fan continues to run even after  button is pushed to stop operation in some modes. This is normal because the self cleaning mode is in progress.
- The louvers open slightly and are directed horizontally during self cleaning, and they close when the self cleaning is completed.
- The operation lamp (LED) does not light during the self cleaning mode.
- The self cleaning mode cannot clean the room or remove the already existing mold and dust inside the indoor unit.
- To cancel the self cleaning function, consult the dealer.

11. ADVANCED SETTINGS

■ Swing mode

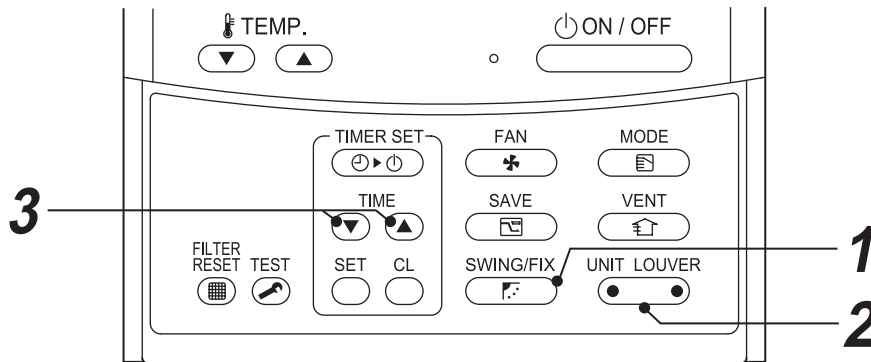

1 Push for at least four seconds when the air conditioner is not working.

- , symbol, and numbers flash.

2 Push (left side of the button) to select an indoor unit to be set.

- Each time you push the button, the unit numbers change as follows:

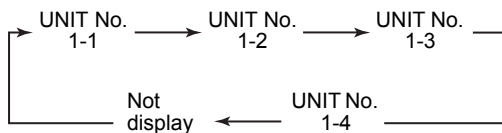

The fan of the selected unit runs and the louvers start swinging.

3 Push TIME buttons to select a swing type.

Three types of swings are available:

- **Standard swing**
The four louvers swing in the same direction.
- **Dual swing**
Louvers **01** and **03** are directed and swing in one direction, and/then louvers **02** and **04** are directed and swing in the opposite direction. (When louver **01** is directed downward, louver **02** is directed horizontally.)
- **Cycle swing**
The four louvers swing independently at respective timings.

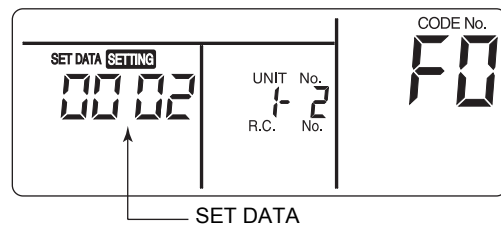
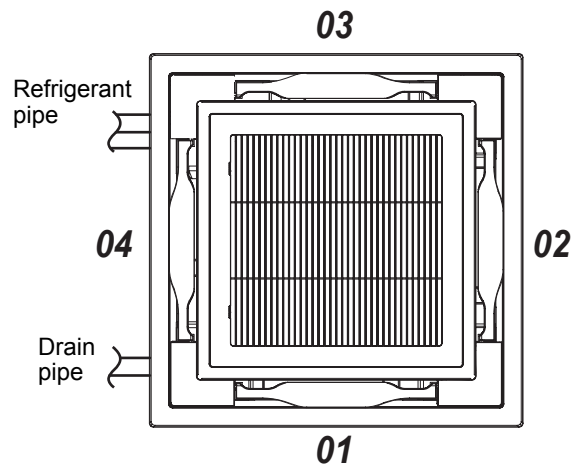

SET DATA	Swing of louvers
0001	Standard swing (Factory default)
0002	Dual swing
0003	Cycle swing

CAUTION

- Do not set the SET DATA to "0000". (This setting may cause a failure of the louvers.)

4 Push button.

5 Push button to complete the setting.

■ Louver lock (No swing)

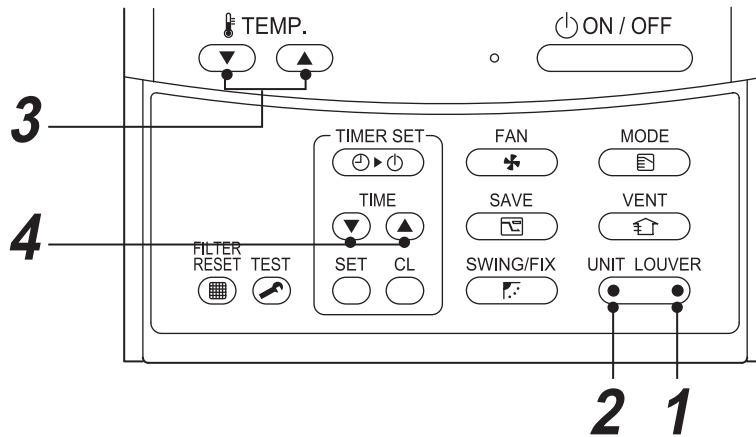

1 Push **UNIT LOUVER** (right side of the button) for at least four seconds when the air conditioner is not working.

- **SETTING** and numbers flash.

2 Push **UNIT LOUVER** (left side of the button) to select an indoor unit to be set.

- Each time you push the button, unit numbers change as follows:
The fan of the selected unit runs and the louvers start swinging.

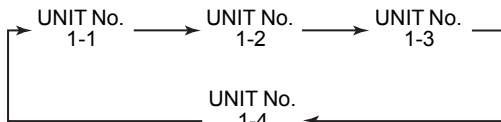

3 Push **TEMP.** buttons to display the number of a louver you want to lock on the temperature display.

- The selected louver starts swinging.



4 Push **TIME** buttons to select the louver direction of the louver you do not want to swing.

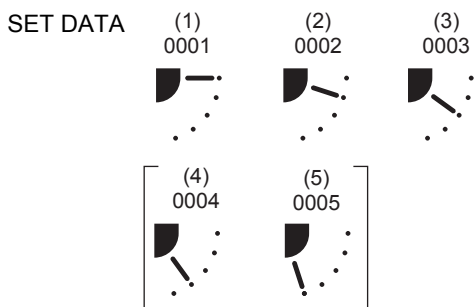

⚠ CAUTION

- If (4) or (5) is selected, condensation may drop from the unit during operation in cooling mode.

5 Push **SET** button to lock the louver.

- When the setting has been determined, lights up.
(To continue louver lock settings for other indoor units, repeat from step 2. To continue louver lock settings for other louvers on the same indoor unit, repeat from step 3.)

6 Push **TEST** button to complete the setting.

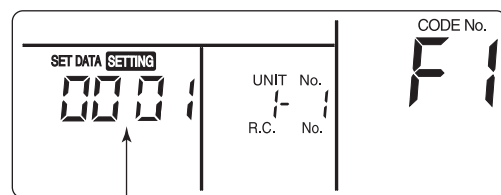

0001-0005
(Louver lock position code)

- A louver number is displayed as **F1**, **F2** on the remote control (SET DATA), showing that louver **01**, **02** shown in the figure on the previous page is selected.

NOTE

Even when louvers are locked, they move temporarily in the following cases:

- When the air conditioner is stopped
- At the beginning of heating operation
- During defrosting operation
- When the room temperature has reached the set temperature

■ Cancel louver lock

Set the louver direction to "0000" in step 4 of the louver lock setup procedure.



- When the setting is cancelled, goes out.
Perform the same operations as steps 1, 2, 3, 5, and 6 above.

■ Change power saving mode setting

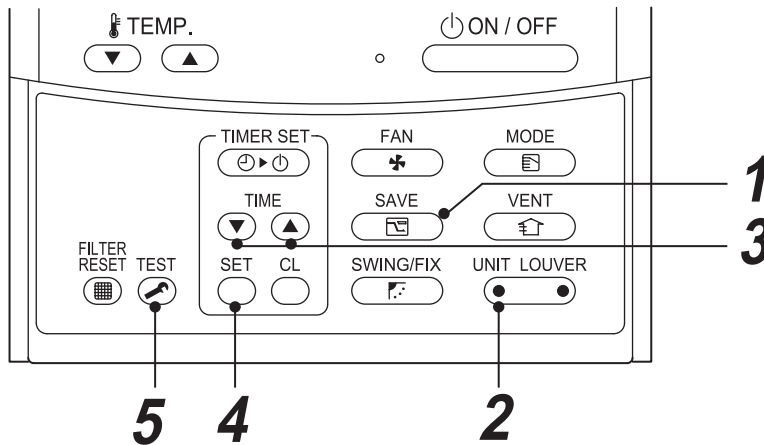

1 Push button for at least four seconds when the air conditioner is not working.

- and numbers flash.

2 Push (left side of button) to select an indoor unit to be set.

- Each time you push the button, unit numbers change as follows:



The fan of the selected unit runs and the louvers start swinging.

3 Push TIME buttons to adjust the power-save setting.

- Each push of the button changes the power level by 1% within the range from 100% to 50%.
- * The factory default is 75%.

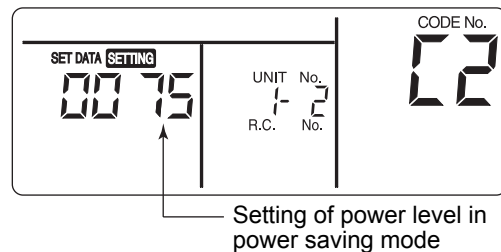

4 Push button.

5 Push button to complete the setting.

12. MAINTENANCE

⚠ WARNING

Cleaning the air filter and other parts of the air filter involves dangerous work in high places, so be sure to have a service person to do it.

Do not attempt to do it by yourself.

To avoid the possibility of electric shock, always turn off power to the system before performing any cleaning or maintenance to the system. Turn off the outdoor disconnect switch located near outdoor unit.

Operating the system with dirty filters may damage the indoor unit and could cause reduced cooling performance.

Periodic Maintenance - periodic maintenance is recommended to ensure proper operation of the unit. Recommended maintenance intervals may vary depending on the installation environment, e.g. dusty zones, etc. Refer to table below.

Periodic Maintenance

INDOOR UNIT	EVERY MONTH	EVERY 4 MONTHS	EVERY YEAR
Clean Air Filter*1	1		
Clean Drain Pan		1	
Clean indoor heat exchanger*2			1
Clean fan*2			1
Change Remote Control Batteries			1
OUTDOOR UNIT	EVERY MONTH	EVERY 4 MONTHS	EVERY YEAR
Clean Outdoor heat exchanger from Outside		1	
Clean Outdoor heat exchanger from Inside*2			1
Blow Air Over Electric Parts*2			1
Check Electric Connection Tightening*2			1
Clean Fan Wheel*2			1
Check Fan Tightening*2			1
Clean Drain Pans*2			1

*1: Increase frequency in dusty zones.

*2: Maintenance to be carried out by qualified service personal.

REQUIREMENT

Be sure to clean the heat exchanger with pressurized water.

If a commercially available detergent (strong alkaline or acid) cleaning agent is used, the surface treatment of the heat exchanger will be marred, which may degrade the self cleaning performance.

For further details, contact the dealer.

Replacing antibacterial glass

Request your dealer to replace the antibacterial glass every 10000 hours of cooling operation.

Part code	43179152
-----------	----------

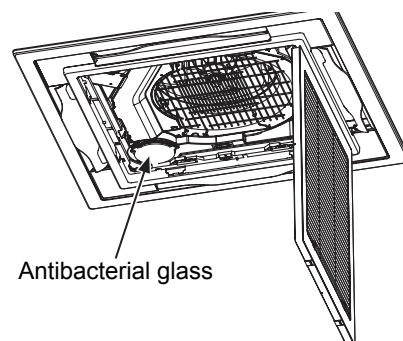

Cleaning the air filter

The fan is running for self cleaning maintenance after running the cooling or dry mode. Terminate the self cleaning mode forcibly when maintaining the air conditioner.

- If  is displayed on the remote control, clean the air filter.
1. Open the return air grille by sliding the latches. Let the grille drop while holding it.

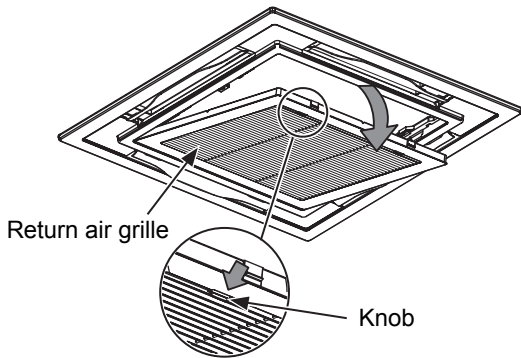

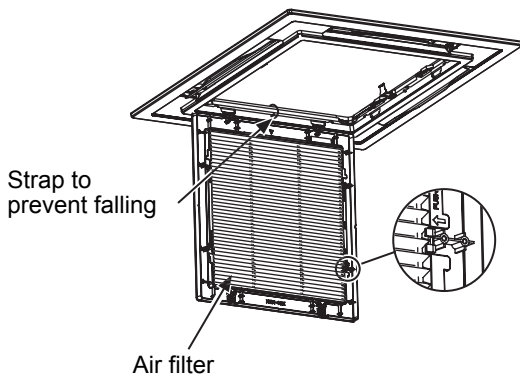

2. Remove the air filter from grille.

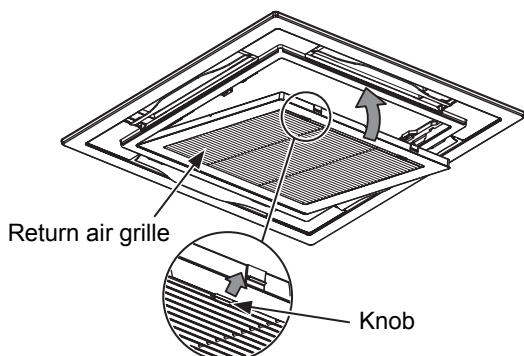

3. Vacuum the filter and rinse it with water.
4. Dry the filter.
5. Wipe the inside of the return air grille with water or mild detergent and then dry it.
6. Reinstall the filter.
7. Close the grille and secure it to the frame by the latches.



8. Push  button to reset filter timer.
 - “FILTER ” disappears.

CAUTION

- Do not start the air conditioner while leaving the panel and air filter removed.

Cleaning Unit Grille and Frame

To clean the grille and the frame, wipe the outside with a soft, dry cloth. If necessary, a mild liquid detergent can be applied and wiped off with a dry cloth.

Cleaning The Louvers

1. Remove the discharge louver by holding it at both ends and pulling downwards towards the center.

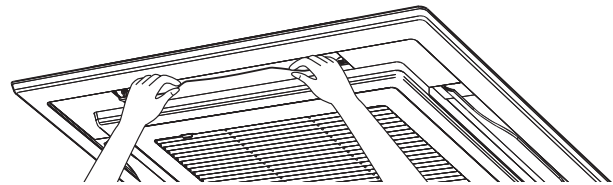

2. Clean the louvers with water or mild detergent.
3. Mount the discharge louver by inserting one end and bending it outwards to allow the other end to be inserted.

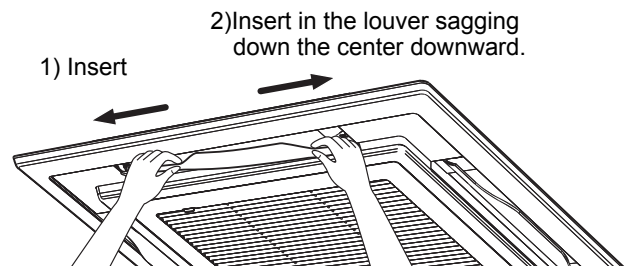

NOTE

When installing the louvers, make sure the side with marking faces upwards.

Preparing for long Shut Down Period

1. Clean the filters and reposition them in unit.
2. Operate the unit in fan mode for 3 or 4 hours to dry all internal parts.
3. Turn the unit off and disconnect the main power supply.
4. Before unit is turned on again, make sure the circuit breaker has been turned on for at least 12 hours.

13. INFORMATION FOR INSTALLATION

Installation place

CAUTION

- **Check that the air conditioner is not installed in a place subject to combustible gas leak.**
Accumulation of combustible gas around the unit may cause a fire.
- Drain the dehumidified water from the indoor unit and outdoor unit to a well-drained place.
- Do not put any obstacle near the air inlets and air outlet of the outdoor unit. Doing so may hinder the radiation, which may reduce the performance or activate the protective device.

Electrical wiring

WARNING

- Be sure to connect ground wire. (grounding work)
Incomplete grounding cause an electric shock.
Do not connect ground wires to gas pipes, water pipes, lightning rods or ground wires for telephone wires.

CAUTION

- **Make sure that a circuit breaker is connected.**
Using the air conditioner without circuit breaker may cause electric shock.
- **Use circuit breaker with appropriate capacity.**
Be sure to use the rated voltage and an exclusive circuit for power supply of the air conditioner.

Do not install the air conditioner in the following places

- Do not install the air conditioner in any place within 3'3" (1 m) from a TV, stereo, or radio set. If the unit is installed in such place, noise transmitted from the air conditioner affects the operation of these appliances.
- Do not install the air conditioner near a high frequency appliance (sewing machine or massage machine for business use, etc.), otherwise the air conditioner may malfunction.
- Do not install the air conditioner in a humid or oily place, or in a place where steam, soot, or corrosive gas is generated.
- Do not install the air conditioner in a salty place such as seaside area.
- Do not install the air conditioner in a place where a great deal of machine oil is used.
- Do not install the air conditioner in a place where it is usually exposed to strong wind such as in seaside area.
- Do not install the air conditioner in a place where sulfurous gas generated such as in a spa.
- Do not install the air conditioner in a vessel or mobile crane.
- Do not install the air conditioner in an acidic or alkaline atmosphere (in a hot-spring area or near a chemicals factory, or in a place subject to combustion emissions). Corrosion may be generated on the aluminium fin and copper pipe of the heat exchanger.
- Do not install the air conditioner near an obstacle (air vent, lighting equipment, etc.) that disturbs discharge air. (Turbulent airflow may reduce the performance or disable devices.)
- Do not use the air conditioner for special purposes such as preserving food, precision instruments, or art objects, or where breeding animals or growing plants are kept. (This may degrade the quality of preserved materials.)
- Do not install the air conditioner over an object that must not get wet. (Condensation may drop from the indoor unit at a humidity of 80% or more or when the drain port is clogged.)
- Do not install the air conditioner in a place where an organic solvent is used.
- Do not install the air conditioner near a door or window subject to humid outside air. Condensation may form on the air conditioner.
- Do not install the air conditioner in a place where special spray is used frequently.

Be careful with noise or vibrations

- Do not install the air conditioner in a place where noise by outdoor unit or hot air from its air outlet annoys your neighbors.
- Install the air conditioner on a solid and stable foundation so that it prevents transmission of resonating, operation noise and vibration.
- If one indoor unit is operating, some sound may be audible from other indoor units that are not operating.

 **WARNING****Re-Installation**

Ask the dealer or an installation professional to re-install the air conditioner to a new place or move it to another place and to observe the following items.

If the air conditioner is inappropriately installed by yourself, it may cause electric shock or fire.

Maintenance

- This product incorporates a drain pump.
If it is used in a place full of dust or oil mist, the pump will be clogged and proper drainage is disabled.
Clean the drain pump periodically. For how to clean the drain pump, contact the dealer.

 **CAUTION**

Be sure to clean the heat exchanger with pressurized water.

If a commercially detergent (strong alkaline or acid cleaning agent) is used, the surface treatment of the heat exchanger will be marred, which may degrade the self cleaning performance.

For details, contact the dealer.

14. TROUBLE SHOOTING

⚠ CAUTION

If any of the following conditions occur, turn off the circuit breaker and immediately contact the dealer:

- The operation lamps flash at short intervals (5 Hz) even though you have tried turning off the power supply and turning on again after 2 or 3 minutes.
- Switch operation does not work properly.
- The main power fuse often blows out, or the circuit breaker is often activated.
- A foreign matter or water fall inside the air conditioner.
- When the air conditioner does not operate even after the cause of the protective device activation has been removed. (The operation lamp and  on the remote control are flashing.)
- Any other unusual conditions are observed.

Before you ask for servicing or repairs, check the following points.

▼ Recheck

Inoperative

- The circuit breaker is turned off.
- The circuit breaker is activated to cut off power supply.
- The main power fuse has blown out.
- The louvers are not directed correctly.

Does not cool well or heat well

- The air inlet and/or outlet of the outdoor unit is blocked.
- Doors or windows are opened.
- The fan speed is set to low.
- The air conditioner is set in the DRY mode in cooling.
- The set temperature is too high (In cooling) or low (In heating).

▼ These are not malfunction.

Indoor unit or outdoor unit makes a strange noise.

- When the temperature suddenly changes, the indoor or outdoor unit occasionally makes a strange noise because of expansion/ contraction of parts or change of refrigerant flow.
- Air leaking sound is heard occasionally.
It is generated by the solenoid valve when it is actuated.
- A clattering sound is heard when the power is turned on.
It is generated by the outdoor unit during preparation for operation.

The room air is smelly or a bad odor comes from the air conditioner.

- Smells impregnated in the walls, carpets, furniture, clothing, or furs, come out.

Outdoor unit is frosted in heating operation.

Water drains from outdoor unit.

- The outdoor unit is sometimes frosted in heating operation.
In that case, the unit automatically performs defrosting (for 2 - 10 minutes) for increasing the heating efficiency.
- In defrosting operation, both the indoor and outdoor units stop air flow.
- Hiss sound is heard when flow of the refrigerant is changed for defrosting.
- Resultant water of automatic defrosting in heating operation drains from outdoor unit.

The fan does not stop when the operation is stopped.

- The fan runs in the self cleaning mode to dry the heat exchanger.

Air flow changes though the FAN button is not set to the AUTO mode.

- When the temperature of blown air drops in heating operation, the air conditioner automatically changes or stops air flow from the indoor unit not to make persons in the room feel chilly.
- Air flow from the indoor unit is occasionally changed in the cooling operation.



A white mist of chilled air or water is generated from the outdoor unit.

- When the indoor unit in cooling operation or the outdoor unit in defrosting operation occasionally steams.

Protective device

- The protective device stops operation when the air conditioner is overloaded.
- When the protective device is activated, the current operation stops and the operation lamp and  on the remote control flash.

When the protective device is activated

- When the protective device has been activated and stopped operation, turn off the circuit breaker immediately, and ask the installer to find the cause.

If the air conditioner is operated without fixing the problem, the air conditioner may malfunction.

- Check whether the air filters are installed.

If the air filters are not installed, the air coil may be clogged with dust, which may result in water leakage.

Cooling

- When the air inlet and/or outlet of the outdoor unit are blocked
- When the air outlet of the outdoor unit is continuously exposed to strong wind

Heating

- When the air filters are clogged with too much dust or dirt
- When the suction port and/or discharge port of the indoor unit are blocked

Do not turn off the circuit breaker

Do not turn off the circuit breaker during a test run of the air conditioner. Use the ON/OFF button on the air conditioner instead to control the power.

Contact a qualified dealer or contractor if the system is not operating properly or any of the following occurs:

- On board safety control stops the system. When this happens the operation lamp and on the remote control are flashing.
- When a diagnostic code is displayed on the wired remote control.
Make a note of the error code and inform the dealer or contractor.

TOSHIBA CARRIER CORPORATION

EH99933501