

VERSA•TOUCH ♦ INSTALLATION

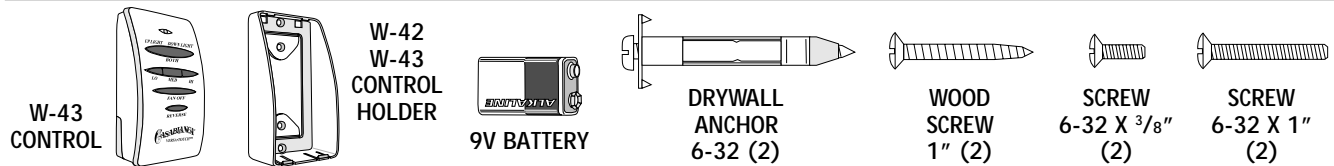

VERSA•TOUCH ♦ CONTROL HOLDER INSTALLATION

CAUTION! DO NOT USE WITH WALL DIMMER.

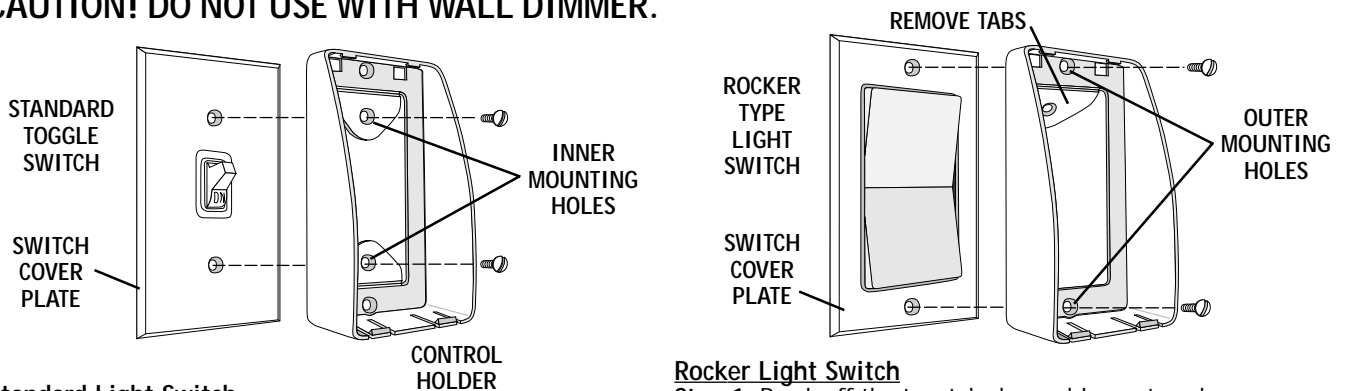

Standard Light Switch

- Step 1. Remove the two screws holding the switch cover plate. Do not remove the cover plate.
- Step 2. Orient the control holder as shown and line up the two inner mounting holes with those on the switch.
- Step 3. Install and tighten screws by *hand* only.

Rocker Light Switch

- Step 1. Break off the two tabs by pushing outward.
- Step 2. Remove the two screws holding the switch cover plate. Do not remove the cover plate.
- Step 3. Orient the control holder as shown and line up the two outer mounting holes with those on the switch.
- Step 4. Install and tighten screws by *hand* only.

VERSA•TOUCH ♦ HOLDER INSTALLATION / STORAGE

Wall Installation

- Step 1. Locate a 2x4 wall stud in a convenient location.
- Step 2. Orient the control holder as shown over the 2x4 stud.
- Step 3. Use the 1" wood screws in either the inner or outer mounting holes. Install and tighten screws by *hand* only.

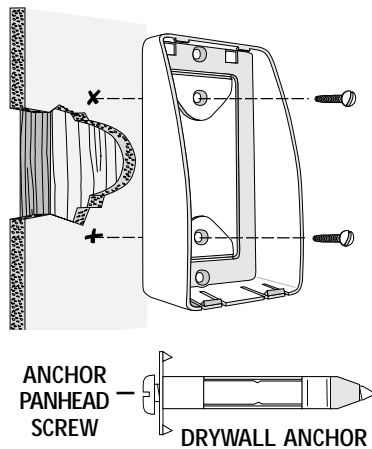

Note: The wall anchors and 6-32 x 1" screws may be used in situations where mounting to a stud is not possible. Use the inner mounting holes. After securing the anchor, discard the anchor's pointed screws and use the 6-32 decor ovalhead screws supplied.

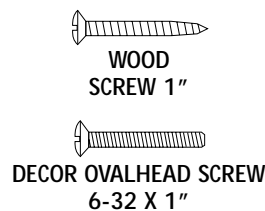

Control Storage

Angle control in top first until the unit can be gently pushed back and snapped into place.

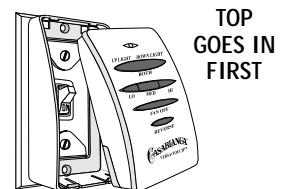

Removing Control

Gently Pull the lower edge of the control out from the holder.

VERSA•TOUCH ♦ BATTERY INSTALLATION

Remove Battery Door

Turn control on its front. Twist a coin to unsnap the door A. Lift door away from control B and remove C.

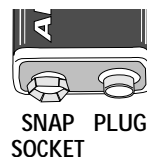
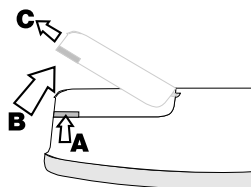

Install Battery

Press battery into control aligned as shown. Observe proper polarity. Replace the battery door.

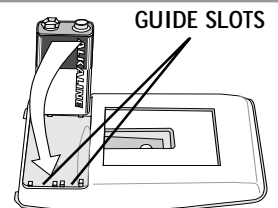

Changes or modifications not expressly approved in writing by Casablanca Fan Co. may void the user's authority to operate this equipment.

This device complies with RSS-210 of Industry Canada. Operation is subject to the following two conditions: (1) this device may not cause interference, and (2) this device must accept any interference, including interference that may cause undesired operation of the device.

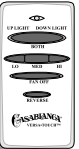

VERSA•TOUCH OPERATION

Fan Control

To start the fan. Press the selected speed button to run the fan at the desired speed.

LO=Low speed MED=Medium speed HI=High speed

To turn off the fan. Press the **FAN OFF** button.

Airflow Direction

To reverse the airflow press the **REVERSE** button. Reverse operates at any speed whether fan is on or off. The fan returns to its set speed after reversing.

Light Control

Turn the light on or off independently from the fan by pressing the **UP LIGHT, DOWN LIGHT, OR BOTH** button. (This is a rocker switch. Press the left side for the Up Light, right side for the Down Light, and the middle for both.) Keep pressing the button in excess of 0.7 seconds, it becomes a dimmer. The light varies from 'bright' to 'dim' over approximately 8 seconds. This sequence will reverse the light when it reaches the brightest or dimmest level if you continue to hold the **LIGHT** button. Release the button when the desired level is reached.

Auto Resume

Quick (pressing less than 0.7 seconds) on/off operation of the **LIGHT** button maintains the desired brightness level set previously.

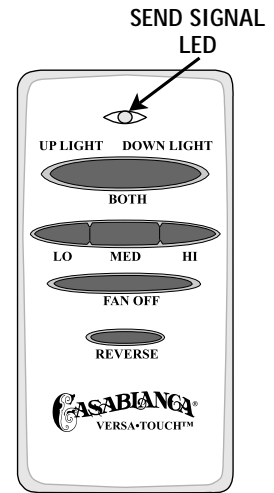

VERSA•TOUCH ♦ CHANGING FREQUENCY SETTING

Note: All fans leave the factory set to '00000'.

You will only have to change the dip switch settings in the remote if you are using more than one fan in the same area and want to control them separately.

Step 1. At the circuit breaker or fuse box, turn the power off for the fan you want to change.

Step 2. Open the battery door of the Versa•Touch control and remove the batteries.

Step 3. Change the dip switch settings, assuring that they are different from the previously installed Versa•Touch fan.

Step 4. Re-install the batteries and the battery door on the control.

Step 5. At the circuit breaker or fuse box, turn the power back on for the fan whose frequency you are changing.

Step 6. Within 20 seconds of restoring power, push the Hi, Med, and Lo buttons (in that order).

Note: You may want to label your controls to assure you do not mix them up.

WARNING: Do not turn the power off at the circuit breaker, then back on, for the previously installed Versa•Touch fan(s), as you may inadvertently change the frequency settings for it as well.

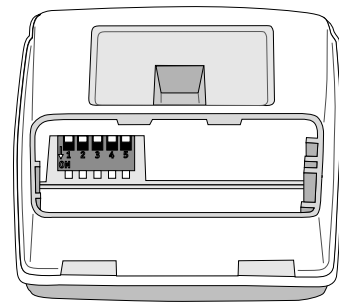

VERSA•TOUCH CONTROL (BACK)

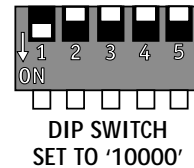

DIP SWITCH SET TO '00000'

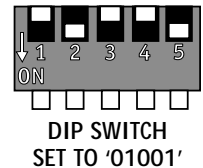

DIP SWITCH SET TO '01001'

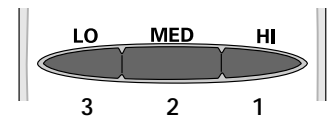

WITHIN 20 SECONDS OF TURNING THE FAN ON, PRESS IN THIS ORDER TO SET NEW FREQUENCY:

1. HI
2. MED
3. LO

VERSA•TOUCH ♦ IF FAN DOES NOT WORK

If the fan is not functioning after installation:

Step 1. Check to make sure that batteries are installed correctly in the control.

Step 2. Turn the power off to the fan (from the circuit breaker) for at least 5 seconds.

Step 3. Turn the power back on (at the circuit breaker) and push the Hi, Med, and Low buttons—in that order—within 20 seconds.

Step 4. The fan should now function properly.

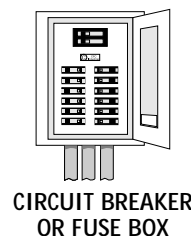

CIRCUIT BREAKER OR FUSE BOX

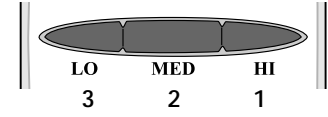

PRESS IN THIS ORDER TO SET NEW FREQUENCY:

1. HI
2. MED
3. LO



TROUBLESHOOTING		
PROBLEM	VERSA•TOUCH	POSSIBLE REMEDIES

Before Requesting Service: Please follow this troubleshooting guide before contacting your dealer for assistance.

- | | |
|--|---|
| FAN WILL NOT START | <ul style="list-style-type: none"> • Check main circuit fuses, circuit breakers, or wall switch position. Check all wire connections, making sure the power is turned off during this inspection. • Pin connectors are not making good contact. Check the connections in the switch housing and under the top cover. • Battery weak - install fresh battery. • Fan receiver defective - replace. • Check the frequency setting: Turn power off, at the circuit breaker, only for the fan not functioning for at least 5 seconds; turn the power back on; within 20 seconds press the Hi, Med, and Lo buttons (in that order) to set the frequency of the fan to the control. See Page 9. |
| FAN WOBBLER OR SHAKES EXCESSIVELY | <ul style="list-style-type: none"> • Be sure canopy pin is properly set into the slot on the ball. • Check that bladeholders have not been bent during installation and blades are balanced. • Hanger bracket and/or ceiling outlet are loosely attached: Make sure that the hanger bracket is tightly attached to the ceiling outlet box. Make sure that the downrod assembly is secured firmly • Downrod is loosely attached to downrod base: Make sure that all screws are securely tightened |
| FAN NOISY DURING OPERATION | <ul style="list-style-type: none"> • Check and tighten light fixture retaining screws, glass shade screws and/or the light bulb(s). • Tighten canopy screws and mounting plate assembly. Check that the wire nuts inside the canopy and switch housing are not touching the metal parts or have fallen off the wire splices. Tighten as necessary. • Tighten blade holders to flywheel (or direct drive motor) and blade to bladeholder screws. • Make sure all screws in the motor housing are snug, but not overly tight. Defective bulb: Replace bulb. |
| DOES NOT RUN ON LOW SPEED | <ul style="list-style-type: none"> • If new, "break-in" may be required - run at higher speed for several days. |
| BATTERY LIFE SEEMS SHORT | <ul style="list-style-type: none"> • Not using Alkaline batteries: Replace with Alkaline batteries. |

- **LIGHT O.K., NO FAN:** Pin connectors are not making good contact, check 9 pin connector under top cover.
- **FAN O.K., NO LIGHT:** Defective receiver; Replace receiver. Defective motor; Replace motor. Broken socket; Replace socket. Defective receiver; Replace Receiver.
- **FAN AND LIGHT ON FULL, NO CONTROL:** Defective receiver; Replace Receiver.
- **MISSING ONE SPEED:** Defective receiver; Replace Receiver.
- **FAN DOESN'T CHANGE SPEED, LIGHT O.K.:** Replace receiver.
- **FAN O.K., LIGHT NOT DIM:** Defective receiver; Replace Receiver.
- **NO REVERSE:** Defective receiver; Replace Receiver.
- **FAN OPERATES ONLY WHEN TRANSMITTER IS CLOSED:** Check antenna wire is not touching metal plate.
- **FAN STARTS WORKING BY ITSELF:** Frequency interference; Change frequency as described on Page 9.

For questions or to locate the nearest Casablanca Authorized Service Center call toll free: 1-888-227-2178 or visit us on the web at: www.CasablancaFanCo.com

1. This device complies with Part 15 of the FCC Rules. Operation is subject to the following two conditions: (1) this device may not cause harmful interference, and (2) this device must accept any interference received, including interference that may cause undesired operation.

2. This equipment has been tested and found to comply with the limits for a Class B digital device, pursuant to Part 15 of the FCC Rules. These limits are designed to provide reasonable protection against harmful interference in a residential installation. This equipment generates, uses and can radiate radio frequency energy and, if not installed and used in accordance with the instructions, may cause harmful interference to radio communications. However, there is no guarantee that interference will not occur in a particular installation. If this equipment does cause harmful interference to radio or television reception, which can be determined by turning the equipment off and on, the user is encouraged to try to correct the interference by one or more of the following measures: Reorient or relocate the receiving antenna, increase the separation between the equipment and receiver, connect the equipment into an outlet on a circuit different from that to which the receiver is connected, consult the dealer or an experienced radio/TV technician for help. Note: Any changes or modifications to the transmitter or receiver not expressly approved by Casablanca Fan Company may void one's authority to operate this remote control.