

CASIO^E

Handheld Terminal **DT-X7** Series

User's Guide

Be sure to read "Safety Precautions" inside this guide before trying to use your Handheld Terminal. After reading this guide, keep it in a safe place for future reference.

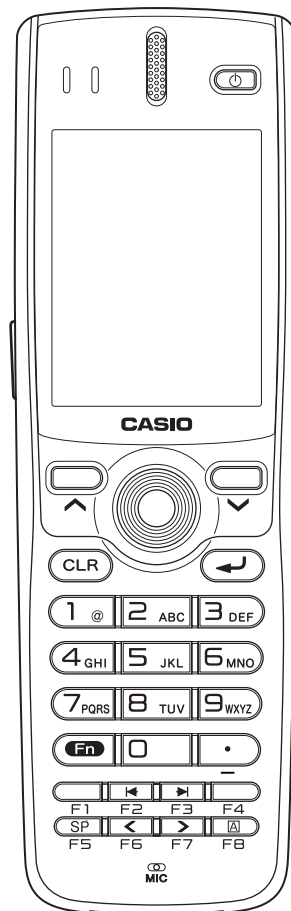

PN430049-001

-
- This Product is equipped with the Brycen BL-RAPPORE Stack and My Wirefree Network Bluetooth User Interface Application, the use of which is governed by a license granted by Brycen Co., Ltd.



- BLUETOOTH is a registered trademark owned by Bluetooth SIG, Inc. and licensed to CASIO COMPUTER CO., LTD.
- Microsoft and Windows are either registered trademarks or trademarks of Microsoft Corporation in the United States and/or other countries.

Information in this document is subject to change without advance notice. CASIO Computer Co., Ltd. makes no representations or warranties with respect to the contents or use of this manual and specifically disclaims any express or implied warranties of merchantability or fitness for any particular purpose.

Safety Precautions

Congratulations upon your selection of this CASIO product. Be sure to read the following Safety Precautions before trying to use it for the first time.



Markings and Symbols

The following are the meanings of the markings and symbols used in these Safety Precautions.

 **Danger** This symbol indicates information that, if ignored or applied incorrectly, creates the danger of death or serious personal injury.

 **Warning** This symbol indicates information that, if ignored or applied incorrectly, creates the possibility of death or serious personal injury.

 **Caution** This symbol indicates information that, if ignored or applied incorrectly, creates the possibility of personal injury or property damage.

-  • A diagonal line indicates something you should not do. The symbol shown here indicates you should not try to take the unit apart.
-  • A black circle indicates something you should do. The symbol shown here indicates you should unplug the unit from the wall outlet.

Precautions During Use

Warning

Disassembly and Modification

-  • Never try to disassemble or modify the Handheld Terminal and its options in any way. High voltage inside creates the danger of electric shock.

Abnormal Conditions

-  • Should the Handheld Terminal and its options become hot or start to emit smoke or a strange odor, immediately turn off the power, and contact your original vendor or an authorized CASIO service provider. Continued use creates the danger of fire and electric shock.

 **Warning**

Foreign Objects

-  • Should any foreign matter get into the Handheld Terminal and its options, immediately turn off the power and contact your original vendor or an authorized CASIO service provider. Continued use creates the danger of fire and electric shock.

Dropping and Damage

-  • Should you drop the Handheld Terminal and its options and damage them, immediately turn off the power and contact your original vendor or an authorized CASIO service provider. Continued use creates the danger of fire and electric shock.

Moisture

-  • Though the Handheld Terminal is water splash-resistant, its optional peripherals are not. Keep loose metal objects and containers filled with liquids away from your Handheld Terminal and the optional peripherals. Also, never connect or disconnect peripherals to the Handheld Terminal while they are wet. Water getting into the Handheld Terminal or its peripherals creates the danger of fire and electric shock.

Laser Light

-  • This product scans bar codes using laser light. Never look directly into the laser light or shine the laser light into the eyes.

LED Light

-  • This product scans bar codes using LED light. Never look directly into the LED light or shine the LED light into the eyes.

 **Warning**

**Interference with the Operation of Other Equipment
(Using Wireless Data Communication)**

-  • Keep your Handheld Terminal at least 22 centimeters (8¹¹/₁₆") away from anyone wearing a pacemaker. Radio waves emitted by the Handheld Terminal can affect the operation of a pacemaker.
- In order to protect someone wearing a pacemaker from the risk of unintentional interference, turn off the Handheld Terminal before boarding a crowded train or entering any other crowded area.

 **Caution**

Foreign Objects

-  • Take care to ensure that metals or combustible objects are not inserted into the openings of the Handheld Terminal and its options. Such the objects inside of the Handheld Terminal create the danger of fire and electric shock.

Location

-  • Do not locate the Handheld Terminal and its options on a surface that is unstable or uneven. Doing so creates the danger of the Handheld Terminal falling, which can cause personal injury.
- Do not locate the Handheld Terminal and its options in an area subject to large amounts of humidity or dust. Doing so creates the danger of fire and electric shock.
- Do not leave the Handheld Terminal and its options for a long period in a car parked in direct sunlight.

Heavy Objects



-  • Never place heavy objects on top of the Handheld Terminal and its options. Doing so creates the danger of loss of balance and the objects falling, which can cause personal injury.

LCD Screen



-  • Never apply strong pressure to the screen or subject it to strong impact. Doing so can crack the screen or LCD panel glass, which can cause the danger of personal injury.
- Should the LCD panel glass break, never touch the liquid inside. Doing so can cause skin inflammation.
 - Should liquid from the LCD panel accidentally get into your mouth, immediately wash your mouth with water and then consult a physician.
 - Should liquid from the LCD panel accidentally get into your eyes or onto your skin, immediately rinse for at least 15 minutes with clean tap water and then consult a physician.

Optional Lithium-ion Battery Pack



Danger

-  • Never allow the battery pack to become wet. Water can create the danger of battery pack heat emission, explosion, and fire.
- Never use or leave the battery pack next to open flame, near a stove, or any other area exposed to high heat. Doing so creates the danger of battery pack heat emission, explosion, and fire.
- Never use the battery pack with any device other than the Handheld Terminal. Doing so can create the danger of battery pack heat emission, explosion, and fire.
- Note that the battery pack's positive (+) and negative (-) polarities must be oriented correctly when it is loaded into battery charger or the Handheld Terminal. Connecting the battery pack with its polarities reversed creates the danger of battery pack fluid leakage, heat emission, explosion, and fire.
- Never dispose of the battery pack by incinerating it or otherwise expose it to heat. Doing so creates the danger of battery pack heat emission, explosion, and fire.
- Never allow the positive (+) and negative (-) terminals of the battery pack to become connected (shorted) by metal. Doing so creates the danger of battery pack heat emission, explosion, and fire.
- Never transport or store the battery pack together with a necklace, hair pins or other metal objects. Doing so can short battery pack terminals, creating the danger of battery pack heat emission, explosion, and fire. Be sure to place the battery pack in its case whenever transporting or storing it.
- Never throw the battery pack or otherwise subject it to strong impact. Doing so creates the danger of battery pack heat emission, explosion, and fire.
- Never pierce the battery pack with nails, hit it with a hammer, or step on it. Doing so can create the danger of battery pack heat emission, explosion, and fire.
- Never try to take apart the battery pack or modify it in any way. Doing so creates the danger of battery pack heat emission, explosion, and fire.
-  • Use only the specified battery charger to charge the battery pack. Use of other type of battery charger creates the danger of battery pack heat emission, explosion, and fire.

 **Warning**



-  • Never place the battery pack in a microwave oven or any other high-voltage device. Doing so creates the danger of battery pack heat emission, explosion, and fire.
- Should the battery pack emit a strange odor or heat, change color or shape, or exhibit any other abnormal behavior, immediately stop using it. Continued use creates the danger of battery pack heat emission, explosion, and fire.
-  • If the amount of time period the battery pack can serve becomes considerably short, stop using it. It may indicate the possibility of a malfunction in the battery pack. Continued charging the battery pack creates the danger of heat emission, explosion, and fire.
- If the battery pack does not achieve full charge after the normal charging time has passed, stop charging it. Continued charging creates the danger of battery pack heat emission, explosion, and fire.
- Should the battery pack start to leak or emit a strange odor, immediately move it away from any nearby flame. Leaking battery fluid is combustible, and exposure to flame creates the danger of explosion and fire.
- Should fluid from the battery pack accidentally get into your eyes, do not rub them. Immediately rinse your eyes with clean tap water and then consult a physician immediately.

 **Caution**



-  • Never use or leave the battery pack in an area exposed to direct sunlight, in a car parked in direct sunlight, or any other very hot area. Doing so creates the danger of heat emission and fire, as well as deterioration of battery pack performance and shortening of its service life.
- Do not use the battery pack in areas where static electricity is being generated. Doing so creates the danger of battery pack heat emission, explosion, and fire.
-  • Danger of explosion if the battery pack is incorrectly replaced.
- Replace only with same or equivalent type recommended by CASIO. Dispose of used batteries according to the local regulation.
- Should fluid from the battery pack accidentally get onto clothing or your skin, immediately rinse it off with clean tap water. Prolonged contact with battery pack fluid can cause skin irritation.
- Keep the battery pack out of the reach of small children. Do not let small children remove the battery pack from battery charger or the Handheld Terminal while it is powered on.

AC Power Supply

Warning

-  Do not use the Handheld Terminal at a voltage other than the specified voltage. Also, do not connect the Handheld Terminal to a multi-plug power strip. Doing so creates the danger of fire and electric shock.
- Avoid conditions that can cause damage or breaks in the power cord. Do not place heavy objects on the power cord and keep it away from sources of heat. Any of these conditions can damage the power cord, creating the danger of fire and electric shock.
- Never modify, sharply bend, twist, or pull on the power cord. Doing so creates the danger of fire and electric shock.
- Power cable (especially on the plug)
Never use a detergent to clean AC adaptor, especially on the plug and the jack.
-  When using the battery chargers and the cradles, be sure to use the respective AC adaptors (sold separately). Use of other AC adaptor model creates the danger of fire and electric shock.
- Should the power cord become severely damaged (to the point that wires are exposed or broken), contact an authorized CASIO service provider about repair or replacement. Use of a damaged electrical cord creates the danger of fire and electric shock.

Caution

-  Keep the power cord away from stoves and other sources of extreme heat. Heat can melt the covering of the power cord and create the danger of fire and electric shock.
-  Never pull on the power cord when unplugging it. Doing so can damage the cord and create the danger of fire and electric shock. (Always hold the plug when unplugging it from the wall outlet.)
- Never touch the plug while your hands are wet. Doing so can create the danger of electric shock.
-  Be sure to unplug the power cord from the wall outlet before moving the battery chargers and the cradles. Failure to do so can result in damage to the power cord caused by pulling it, which creates the danger of fire and electric shock.
- Be sure to unplug the power cord from the wall outlet before cleaning the battery chargers and the cradles.
- Be sure to unplug the power cord after use.
- Unplug the power cord from the wall outlet whenever leaving the battery chargers and the cradles unattended for a long period.

AC Adaptor

Caution



- The housing of the AC adaptor can become warm during normal use.



- Take normal precautions against electric shock.



- At least once a year, unplug the AC adaptor from the wall outlet and clean any dust that builds up between the prongs of the plug. Dust built up between the prongs can lead to the danger of fire.

Backup Copies of All Important Data

Caution



- Note that CASIO Computer Co., Ltd. shall not be held liable to you or any third party for any damages or loss caused by deletion or corruption of data due to use of the Handheld Terminal, malfunction or repair of the Handheld Terminal or its peripherals, or due to the batteries going dead.
- The Handheld Terminal employs electronic memory to store data, which means that memory contents can be corrupted or deleted if power is interrupted due to the batteries going dead or incorrect battery replacement procedures. Data cannot be recovered once it is lost or corrupted. Be sure to make backup copies of all important data. One way to do this is to use the separately sold cradles to transfer data to a computer.

Operating Precautions

Your Handheld terminal and its options are precision. Improper operation or rough handling can cause problems with data storage and other problems. Note and observe the following precautions to ensure proper operation.

- **Do not continue operating the Handheld Terminal when battery power is low.**
Doing so can cause data to be lost. When the battery goes low, charge it as soon as possible.
- **Do not leave dead battery pack in the Handheld Terminal for a long period.**
Dead battery pack can leak, leading to malfunction and damage to the Handheld Terminal.
- **Use the Handheld Terminal and its options only within the specified temperature range.**
Use outside of the specified temperature range creates the risk of malfunction.
- **Avoid using the Handheld Terminal and its options in areas subject to the following conditions.**
The following conditions create the risk of damage to the Handheld Terminal.
 - Large amounts of static electricity
 - Extreme heat or extreme cold
 - High humidity
 - Sudden temperature extremes
 - Large amounts of dust
- **Never use thinner, benzene, cosmetic cleaning fluids, or other volatile agents to clean the Handheld Terminal.**
To clean the Handheld Terminal, wipe it with a dry cloth, or a cloth moistened in a weak solution of water and a mild neutral detergent. Wring all excess moisture from the cloth before wiping.
- **Although the Handheld Terminal meets the IP54 level of the International Standard IEC529, pay your attention to the following when using it in the rain.**
 - After a large amount of rain or water falls on the Handheld Terminal, wipe off it immediately.
 - Do not use it in the rain for a long period of time.
 - Make sure the battery cover and connect cover are closed securely before using it.
 - Do not press on the screen or keys with excessive force when using it in the rain.

Important

- The contents of this guide are subject to change without notice.
- Note that CASIO COMPUTER CO., LTD. shall not be held liable to you or any third parties for any losses or damages arising from the use of this guide.
- This guide does not include any information about programming and download procedures. See the applicable separate documentation for information about the procedures.

After Service

- Should this product ever malfunction, contact your original retailer providing information about the product name, the date you purchased it, and details about the problem.



This mark applies in EU countries only.

Regulatory Information

GUIDELINES LAID DOWN BY FCC RULES FOR USE OF THIS UNIT IN THE U.S.A. (not applicable to other areas).

NOTICE

This equipment has been tested and found to comply with the limits for a Class B digital device, pursuant to Part 15 of the FCC Rules. These limits are designed to provide reasonable protection against harmful interference in a residential installation. This equipment generates, uses and can radiate radio frequency energy and, if not installed and used in accordance with the instructions, may cause harmful interference to radio communications. However, there is no guarantee that interference will not occur in a particular installation. If this equipment does cause harmful interference to radio or television reception, which can be determined by turning the equipment off and on, the user is encouraged to try to correct the interference by one or more of the following measures:

- Reorient or relocate the receiving antenna.
- Increase the separation between the equipment and receiver.
- Connect the equipment into an outlet on a circuit different from that to which the receiver is connected.
- Consult the dealer or an experienced radio/TV technician for help.

FCC WARNING

Changes or modifications not expressly approved by the party responsible for compliance could void the user's authority to operate the equipment.
Proper connectors must be used for connection to host computer and/or peripherals in order to meet FCC emission limits.

Caution Exposure to radio frequency radiation (below is for portable device)

To comply with FCC RF exposure compliance requirements, this device must not be co-located or operating in conjunction with any other antenna or transmitter.

Declaration of Conformity

Model Number: HA-F60IO, HA-F62IO
Trade Name: CASIO
Responsible party: Casio America, Inc. Industrial Handheld Division
Address: 2700 Augustine Drive Suite 155, Santa Clara, California 95054
Telephone number: 408-737-6300



This device complies with Part 15 of the FCC Rules. Operation is subject to the following two conditions:
(1) This device may not cause harmful interference, and (2) this device must accept any interference received, including interference that may cause undesired operation.

For Customers in Canada

These Class B digital apparatuses comply with Canadian ICES-003.
Cet appareil numérique de la classes B est conforme à la norme NMB-003 du Canada.

These devices comply with RSS 210 of Industry Canada (IC).

Operation is subject to the following two conditions:

- (1) These devices may not cause interference, and
- (2) These devices must accept any interference, including interference that may cause undesired operation of this device.

Standard	Issue date
EN 300 328	v1.7.1: 2006.10

and therefore comply with the essential requirements and provisions of the **Directive 1999/5/EC** of the European Parliament and of the council of March 9, 1999 on Radio equipment and Telecommunications Terminal Equipment and the mutual recognition of their conformity and with the provisions of Annex III (Conformity Assessment procedure referred to in article 10).

The technical documentation as required by the Conformity Assessment procedure is kept at the following address:

Company	CASIO Europe GmbH
Address, City	Bornbarch 10, 22848 Norderstedt
Country	Germany
Phone number	+49(0)40-528-65-0
Fax number	+49(0)40-528-65-424

Products are for distribution within
all member states of the EU.

CE 0984 

France limited to 2446.5-2483.5 Mhz Indoor use.

Belgium limited to 2400-2483.5 Mhz Indoor, 2460-2483.5 Mhz Outdoor use.

The information described above dates from January 2003 and may be subjected to future changes.

CE	Manufacturer: CASIO COMPUTER CO., LTD. 6-2, Hon-machi 1-chome, Shibuya-ku, Tokyo 151-8543, Japan
	Representative within the European Union: CASIO EUROPE GmbH Bornbarch 10, 22848 Norderstedt, Germany

The CASIO DT-X7M10E, DT-X7M10R, and DT-X7M10U models are designed, tested and found to meet the relevant regulatory standards described below.

DT-X7M10E, DT-X7M10R

Regulatory standards:

IEC 60825-1

IEC 60529, IP54 level

Europe standards:

EN 60950-1

EN 60825-1

EN 300 328

EN 301 489-17

China standards:

GB 4943

GB 9254

GB 17625.1

信無部 [2002] 353

Taiwan standards:

CNS 14336

CNS 13438

台湾電波法 LP 0002

Australia and New Zealand standards:

AS/NZS CISPR22

DT-X7M10U

Regulatory Information

IEC 60529, IP54 level

IEC 60825-1

USA standards:

FCC Part 15B

FCC Part 15C

UL 60950-1

Canada standards:

RSS-GEN, RSS-210

cUL 60950-1

Contents

Safety Precautions	E-1
Operating Precautions	E-8
Important	E-9
Checking in the Box	E-16
Handheld Terminal System Configuration	E-17
General Guide	E-20
Loading and Removing the Battery Pack.....	E-23
Loading	E-24
Removing	E-25
Attaching the Hand Strap	E-27
Setup.....	E-28
Using the mouse emulator function	E-28
Adjusting Display Brightness	E-30
Display Auto Dimmer	E-30
Using the Laser Scanner (DT-X7M10E/DT-X7M10R)	E-31
Attaching the contact scanning guide	E-31
Warning Label.....	E-32
Bar Code Scanning Position	E-32
Adjusting the Laser Light Emission Width	E-33
Using the Linear Imager (DT-X7M10U)	E-35
Performing Communications	E-36
IR Communication	E-36
Bluetooth® Communication	E-37
Resetting the Handheld Terminal.....	E-38
Performing a Full Reset (Initialization)	E-39

DT-X7 Specifications	E-40
Using the USB Cradle (HA-F60IO).....	E-43
General Guide	E-43
Connecting the USB Cradle Power Supply	E-45
Specifications	E-47
Using the Ethernet Cradle (HA-F62IO).....	E-48
General Guide	E-48
Connecting the Ethernet Cradle Power Supply.....	E-50
Specifications	E-52
Using the Cradle-type Battery Charger (HA-F30CHG).....	E-53
General Guide	E-53
Connecting the AC Adaptor for Cradle-type Battery Charger	E-54
Specifications	E-56
Using the Cradle-type Dual Battery Charger (HA-F36DCHG)	E-57
General Guide	E-57
Charging Battery Pack	E-59
Connecting Multiple Cradle-type Dual Battery Chargers.....	E-60
Specifications	E-61
Using the Dual Battery Charger (HA-F32DCHG).....	E-63
General Guide	E-64
Charging Battery Pack	E-65
Connecting Multiple Dual Battery Chargers.....	E-66
Specifications	E-67
Using Rechargeable Battery Pack.....	E-68
Battery Pack Specifications.....	E-68
Large-capacity Battery Pack Specifications.....	E-68
Attaching the Hand Belt (HA-F95HB).....	E-69
Attaching the Hand Belt.....	E-69
Using the Dry-cell Battery Case (HA-F22BC).....	E-71
Alkaline Battery Handling Precautions.....	E-71
Loading	E-73
Removing.....	E-74
Specifications	E-74

Checking in the Box

Please check the contents of the box before using the Handheld Terminal for the first time.

Open the box and make sure that all the items shown here are included.

Handheld Terminal



Large-capacity Battery Pack Cover

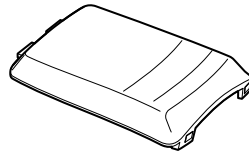

Contact Scanning Guide*

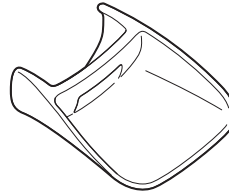

Hand Strap

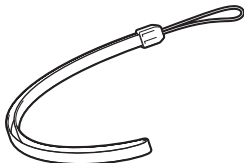

User's Guide (this manual)

* the accessory does not accompany with DT-X7M10U model.

Handheld Terminal System Configuration

DT-X7 Series



DT-X7M10E
DT-X7M10R
DT-X7M10U

Options

USB Cradle
HA-F60IO

Ethernet Cradle
HA-F62IO

Cradle-type Battery Charger
HA-F30CHG

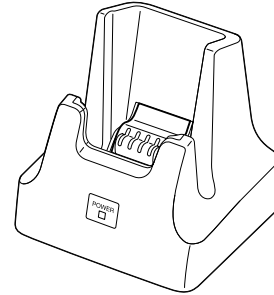

The illustration shows the
USB Cradle(HA-F60IO).

Cradle-type Dual Battery Charger
HA-F36DCHG

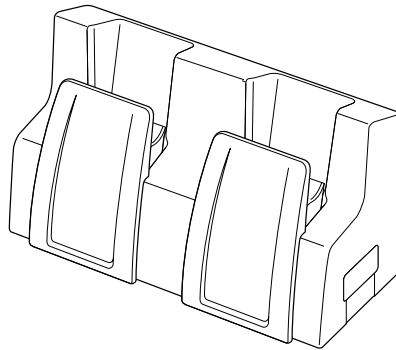

Options

Battery Pack

HA-F20BAT
(Battery Pack)

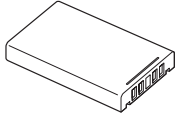

HA-F21LBAT
(Large-capacity Battery Pack)

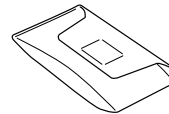
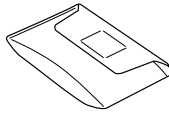
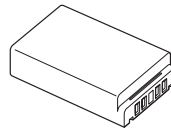

Dual Battery Charger

HA-F32DCHG

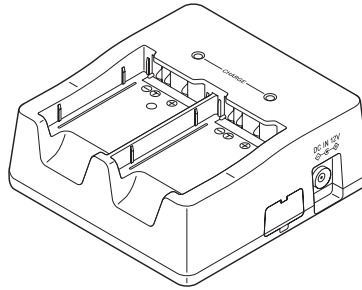

**AC Adaptor for USB Cradle/Ethernet Cradle/
Dual Battery Charger**

AD-S42120BE

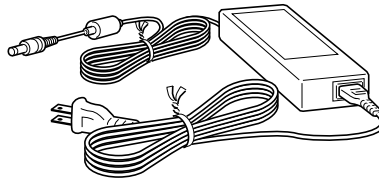

Options

AC Adaptor for Cradle-type Battery Charger

AD-S15050BE

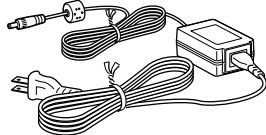

AC Adaptor for Cradle-type Dual Battery Charger

AD-S60160BE
AD-S60160BU

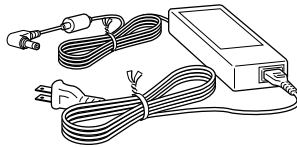

Cable

DT-380USB

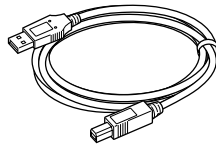

Dry-cell Battery Case

HA-F22BC

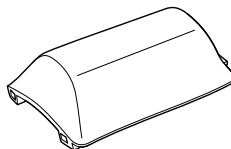
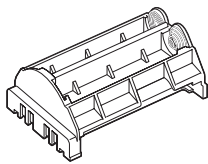

Hand Belt

HA-F95HB

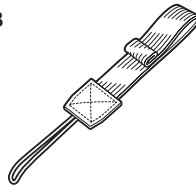

General Guide

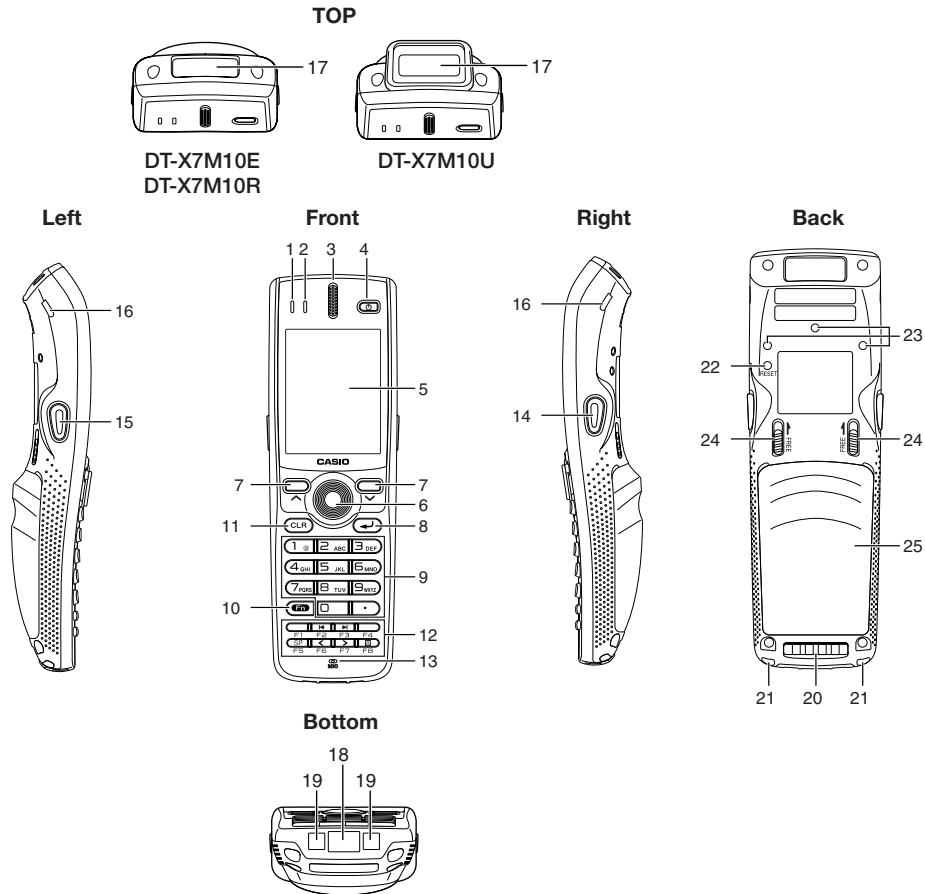

1	Indicator 1	Orange: Charging Green: Charging complete Red: Battery pack error or the surrounding temperature is out of the charging temperature range.
2	Indicator 2	Flashes in blue when operating via Bluetooth or in orange when operating via WLAN. Lights in green when reading a bar code successfully.
3	Speaker	Alarms and voice messages are output here.
4	Power Key	Turns the power on and off.
5	Screen	Displays text and operating instructions.
6	Trigger Center Key	Used to perform bar code reading. Can be assigned an arbitrary function.

7	Cursor Keys	Perform the same functions as the up and down arrow keys on a PC keyboard.
8	Enter Key	Press when finishing entering numerical values or when moving to the next step.
9	Numeric Keys	Used to enter numeric values and decimal points.
10	Fn Key	Used to make various settings in combination with the function keys or numeric keys or when starting a pre-registered application.
11	CLR Key	Used to clear one letter to the left of the cursor.
12	Function Keys	<p>Various functions other than bar code reading can be assigned to these keys.</p> <p>The default key assignments are as follows.</p> <p>F1: Similar function as the Alt key on a PC keyboard.</p> <p>F2: Similar function as the Shift+Tab keys combination on a PC keyboard. Used to move the cursor among entry or selection items.</p> <p>F3: Similar function as the Tab key on a PC keyboard. Used to move the cursor among entry or selection items.</p> <p>F4: Not assigned.</p> <p>F5: Enter a space.</p> <p>F6: Similar function as the cursor left key on a PC keyboard.</p> <p>F7: Similar function as the cursor right key on a PC keyboard.</p> <p>F8: Select text entry mode.</p> <p>(The mode changes in order of Numeric → Alphabet [upper case] → Alphabet [lower case])</p>
13	Microphone	Used to input a sound including voice.
14	Trigger R Key	Used to perform bar code reading.
15	Trigger L Key	Used to perform bar code reading.
16	Contact Scanning Guide Attachment Holes	Used to mount the contact scanning guide attachment. (DT-X7M10E/DT-X7M10R)
17	Barcode Reader Port	Laser light or LED light is emitted from this window that reads barcodes.
18	IR Port	Used for communication with another Handheld Terminal.
19	Power Contacts	Used to receive power provided by the USB Cradle or Ethernet Cradle.
20	Data Communication Terminal	Used for data communications.

21	Strap Holes	Used to attach the hand strap. Also used for the hand belt.
22	Reset Switch	Used to reset the Handheld Terminal.
23	Hand Belt Holes	Used to attach the hand belt.
24	Battery Pack Cover Lock Switch	Used to lock the battery cover and to release.
25	Battery Pack Cover	Used to cover the battery compartment that holds the battery pack inside.

Loading and Removing the Battery Pack

Your Handheld Terminal uses two types of battery: a battery pack and a memory backup battery.

The battery pack is used to power normal operations and to store data, while the memory backup battery provides the power required to maintain memory contents when the battery pack power is unable to supply power for some reason.

The operating power is supplied by a battery pack. You can choose between a battery pack (HA-F20BAT) and a large-capacity battery pack (HA-F21LBAT).

The backup battery is installed inside of the Handheld Terminal.

This guide uses the following terms to refer to the batteries.

Battery Pack: Rechargeable battery pack (HA-F20BAT or HA-F21LBAT) for normal operations and data storage

Backup Battery: Built-in battery for memory backup

When the battery pack power goes low, immediately charge it or replace it with a charged battery pack.

You can use the Dual Battery Charger, the Cradle-type Battery Charger, the Cradle-type Dual Battery Charger, the USB Cradle, or Ethernet Cradle to charge a battery pack. See the sections of this guide that cover the Dual Battery Charger, the Cradle-type Battery Charger, the Cradle-type Dual Battery Charger, the USB Cradle, and the Ethernet Cradle for information about how to use them for charging.

Important!

Always keep backup copies of all important data!

- **The battery pack powers normal operation and also provides power required to maintain memory contents, while the backup battery provides backup power to maintain memory contents. Because of this, you should not remove the battery pack if the backup battery is dead. Removing the battery pack while the backup battery is dead causes data in the memory to be corrupted or lost. Note that once data is lost it cannot be recovered. Always keep separate backup copies of all important data.**
- **The charge of a battery pack when you purchase it may be depleted due to testing at the factory or natural discharge during shipment and storage. Be sure to charge the battery pack before you use it.**
- **The life of a battery pack is limited, and charging a battery pack causes it to gradually lose its ability to maintain the charge. If your battery pack seems to require charging very frequently, it probably means it is time to purchase a new one.**
- **If a battery pack is used past the end of its service life, it may swell up in size. In such a case, replace the battery pack with a new one.**
- **When the battery pack is attached, it takes 30 minutes for the backup battery to obtain enough charge for maintaining memory (RAM) contents for 10 minutes. It takes two days for the backup battery to achieve a full charge.**

Loading

1. Turn over the Handheld Terminal.
2. Slide the left and right battery pack lock switches simultaneously in the direction indicated by the arrows and then remove the battery pack cover.

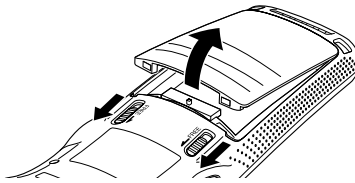

3. Load a battery pack (HA-F20BAT) or large-capacity battery pack (HA-F21LBAT). Take care that the battery pack is oriented correctly when you load it. In addition, load the battery back while making sure that the end of the battery pack removal tape is protruding above the battery pack.

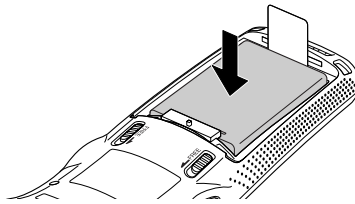

4. Put back the battery pack cover as shown in the illustration. When loading a large-capacity battery pack, use the large-capacity battery pack cover instead of the battery pack cover.

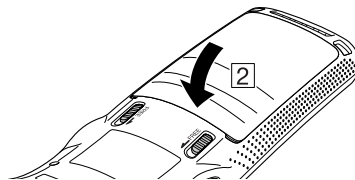
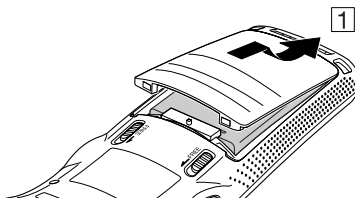

Removing

1. Make sure that the Handheld Terminal is turned off.
If the power is on, press the power key to turn it off.
2. Turn over the Handheld Terminal.
3. Slide the left and right battery pack lock switches simultaneously in the direction indicated by the arrows and then remove the battery pack cover.

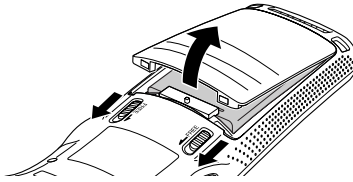

4. Remove the battery pack by pulling up the removal tape as shown in the illustration.

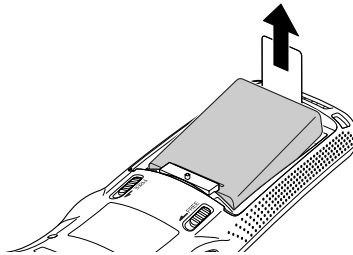

Loading the large-capacity battery pack into the Handheld Terminal

After loading the large-capacity battery pack, you need to use the special large-capacity battery pack cover in place of the standard battery pack cover.

“Loading and Removing” of the large-capacity battery pack cover are the same as those for the standard battery pack cover.

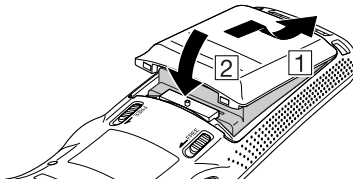

Important!

- When removing the battery pack, make sure you do not leave the Handheld Terminal without a battery pack for more than about 10 minutes. Doing so can cause data in the memory to be deleted.
- When removing the battery pack, be sure you carefully follow the proper procedure as explained in this guide.
- Never try to use other type of battery than the ones that are specified for this product.
- When removing the battery pack, pull the removal tape straight up and remove the battery pack. Removing with excessive force can damage the battery pack.
- Before starting to use the DT-X7, verify that the battery pack cover is properly closed.

Attaching the Hand Strap

The hand strap can be used to prevent the Handheld Terminal from dropping when carrying it around. Since there are two strap holes where the hand strap can be attached, use the hole that affords the greatest ease of use. Attach the hand strap according to the procedure described below.

To attach the hand strap

1. Pass the thin cord of the hand strap through the hand strap hole on the back of the Handheld Terminal.

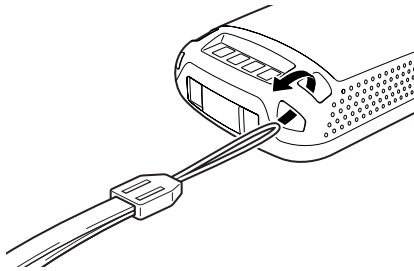

2. Pass the other end of the strap (the part you put around your hand) through the loop formed by the thin cord.

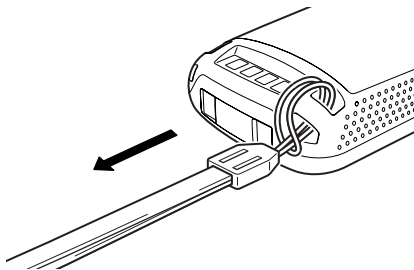
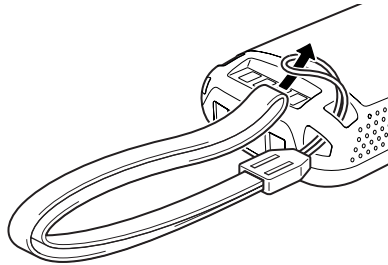

Important!

Do not swing the Handheld Terminal around holding the hand strap.

Setup

Using the mouse emulator function

The mouse emulator function lets you make settings and adjustments by using a mouse cursor.

To use this function, activate it as follows.

■ Activating the mouse emulator function

- While no mouse cursor is shown on the screen, press the “Fn” key followed by the “4” key. The mouse cursor appears, and the mouse emulator function is now active.
- * To turn off the function, press the same key sequence again, i.e. “Fn” key → “4” key.
- * Each push of this key sequence toggles the function between on and off.

■ Using the mouse cursor

Activate the mouse emulator function as described above.

Mouse cursor movement

- Press the numeric key for the direction in which you want to move the mouse cursor.

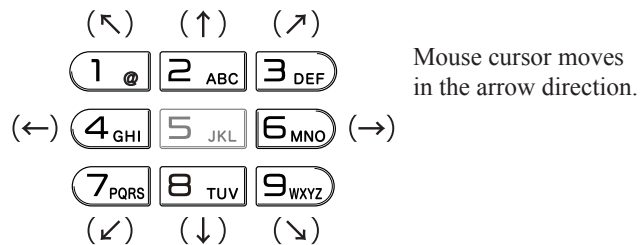

- * Holding down a key moves the mouse cursor continuously.

Left click

This serves for selecting a file, making a menu selection, or a similar action.

- Move the mouse cursor to the position where you want to click, and press the “5” key.

Right click (calling up a menu)

- Move the mouse cursor to the position where you want to click, and press the Trigger R key.

Left double click

Performing this action while the mouse cursor is on an icon starts an application, opens a file, etc.

- Move the mouse cursor to the position where you want to double click, and press the “5” key twice.
- * The double click timing follows the double tap setting of Windows CE. The setting can be changed by accessing the “Mouse” icon in the Control Panel.

Dragging

This action allows you to move an application icon on the screen or a file or folder in File Explorer.

- Move the mouse cursor to the position where you want to start dragging, and press the “5” key. Then move the mouse cursor by holding down the “5” key and pressing another numeric key for the direction in which you want to move. The selected item will be dragged along with the cursor. When you release the “5” key, the item is dropped at the current location.

Adjusting Display Brightness

You can use the following procedures to adjust display brightness to make it easier to read under different lighting conditions.

- Press the “Fn” key and then press the “5” key or “6” key after confirming that “F” is displayed in the lower right corner of the screen. Pressing the “5” key adjusts brightness for a darker display, while pressing the “6” key adjusts brightness for a lighter display.
- * In order to continue to make adjustments, press the “5” key or “6” key after again first pressing the “Fn” key.

Display Auto Dimmer

The display auto dimmer automatically lowers display brightness if you do not perform any operation for a specific period of time. This helps the battery power to be conserved.

You can use the following procedure to specify a period of time that should be allowed to elapse until when the auto dimming is initiated.

1. Use the “◀”/“▶” keys to move the focus to the [Start] icon and press the Enter key. Then select **Set** → **Control Panel** with the Enter key to bring up the Control Panel.

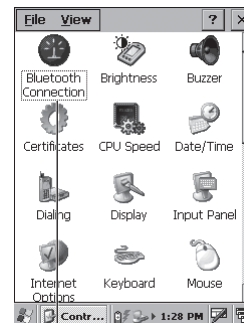

Focus

2. Move the focus to the “Brightness” icon and press the Enter key. Then use the “◀”/“▶” keys to move the focus to the tabs and use the “<”/“>” keys to select the [Backlight] tab. Adjust the displayed items.

* The mouse emulator function can also be used to make the adjustment.

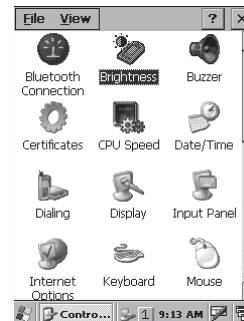

Using the Laser Scanner (DT-X7M10E/DT-X7M10R)

1. After turning on the power, position the laser scanner close to a bar code and then press the trigger key.

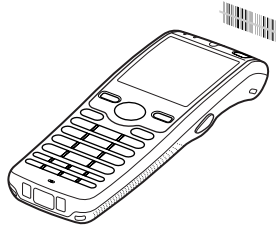

2. The laser emits light and scans the bar code. If scanning is completed normally, Indicator 2 displays a green light and a buzzer sounds.

Important!

- If you are unable to scan a bar code, try changing the angle at which the scanner is held or distance from the scanner to the bar code, and then try scanning again.
- This Handheld Terminal is capable of scanning bar codes at a distance of about 40-400 mm ($1\frac{9}{16}$ "- $15\frac{3}{4}$ "). Furthermore, the distance at which scanning is possible may vary according to the bar code symbology.

Attaching the contact scanning guide

The supplied contact scanning guide can be attached to the DT-X7 to facilitate positioning during scanning.

1. Attach the guide as shown.

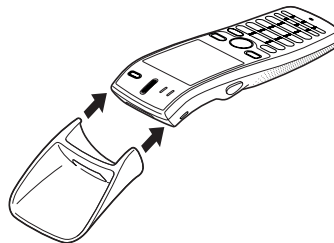

2. After attaching the guide, bring the tip of the guide into contact with the bar code to scan.

Warning Label

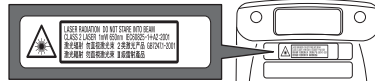

- This label is a warning and caution label for Class 2 laser products that comply with IEC60825-1:1993+A1:1997+A2:2001.
- Although Class 2 laser light is only emitted momentarily, never look directly into the beam light.
- The laser light emitted by this laser scanner has a maximum output of less than 1 mW and a wavelength of 650 nm.
- Use of controls or adjustments or performance of procedures other than those specified herein may result in hazardous radiation exposure.

Bar Code Scanning Position

Position the laser scanner close to the bar code when scanning small bar codes.
Position the laser scanner at a distance from the bar code so that the bars enter the light when scanning large bar codes.

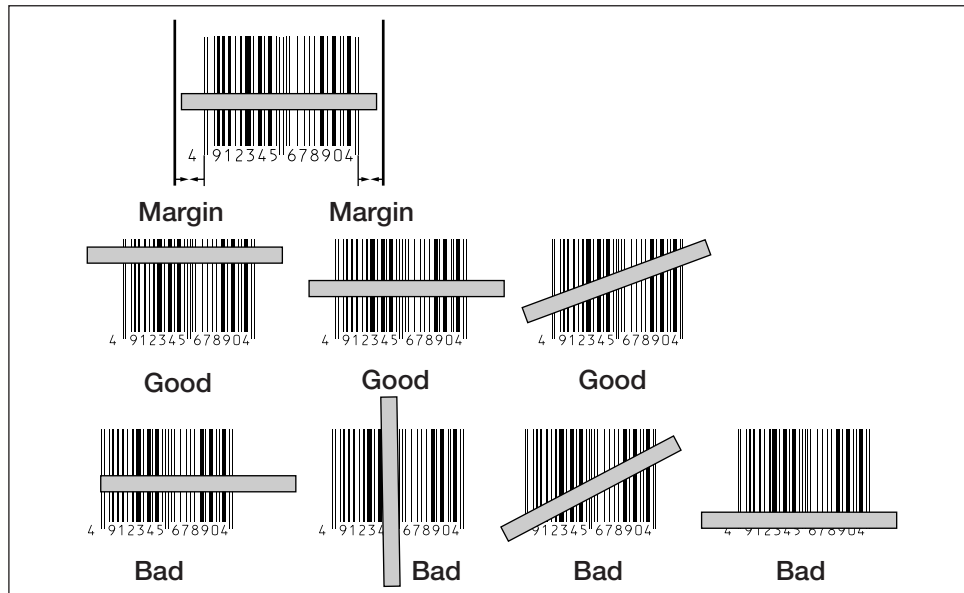

Warning!

- Never look directly into the laser light.



- This product scans using laser light. Never look directly into the laser light or shine the laser light into the eyes.

Adjusting the Laser Light Emission Width

The emission width of the laser light emitted by the Handheld Terminal can be adjusted. Adjust the emission width when it has been changed.

* The mouse emulator function can also be used to make the adjustment.

1. Use the “◀”/“▶” keys to move the focus to the [Start] icon and press the Enter key. Then select **Set → Control Panel** with the Enter key to bring up the Control Panel.

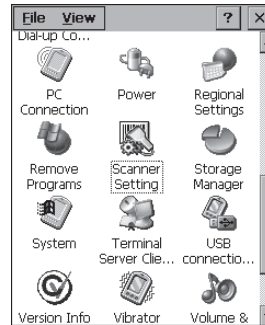

2. Move the focus to the [Scanner Setting] icon and press the Enter key. The display appears as shown at right.

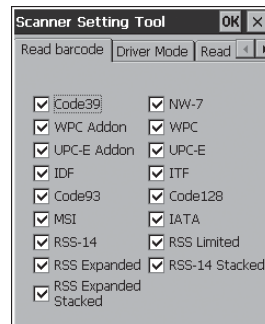

3. Use the “◀”/“▶” keys to move the focus to the tabs and use the “<”/“>” keys to select the [Others] tab.

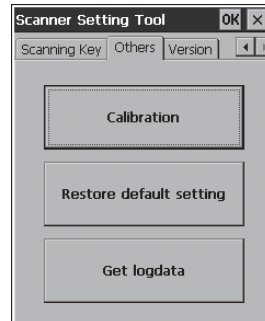

-
4. Use the “◀”/“▶” keys to move the focus to [Calibration] and press the Enter key. The message appears as shown at right.

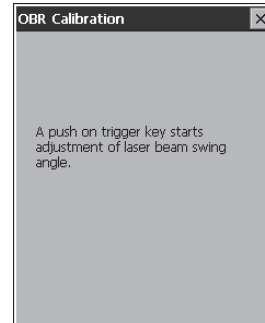

5. Press the Trigger Key to emit laser light, and align the light with the barcode for adjusting emission width.
- Align the laser light with the narrow bars on both sides.
 - The display appears as shown at right when adjustment is completed.
 - Repeat the setting if “Setting failed” message appears.

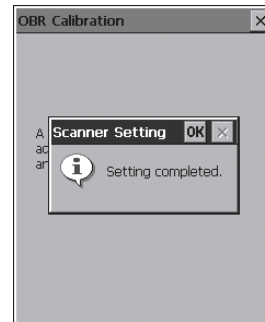

Emission Width Adjustment Bar code

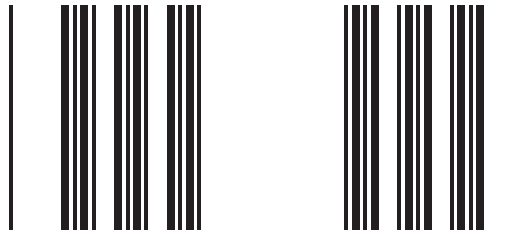

Using the Linear Imager (DT-X7M10U)

1. After turning on the power, position the reader port close to a bar code and then press the Trigger key.

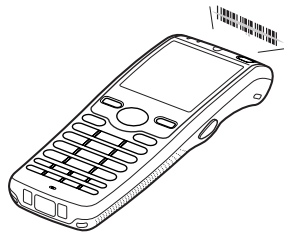

2. The LED emits light and scans the bar code. When scanning is completed normally, Indicator 2 displays a green light and a buzzer sounds.

Important!

- If you are unable to scan a bar code, try changing the angle at which the Handheld Terminal is held or distance between the reader port and the bar code, and then try scanning again.
- This Handheld Terminal is capable of scanning bar codes at a distance of about 60-300 mm ($2^{6/16}$ "- $11^{13/16}$ ""). Furthermore, the distance at which scanning is possible may vary according to the bar code symbology.

Warning!

■ Never look directly into the LED light.

-  • This product scans using LED light. Never look directly into the LED light or shine the LED light into the eyes.

About the Class 1 LED Label

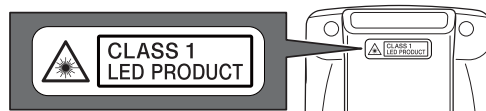

- This label identifies the Handheld Terminal as a Class 1 LED product under IEC60825-1 (ed.1.2)

Performing Communications

IR Communication

IR communication can be used to transfer data between two Handheld Terminals. When performing IR communication, orient the IR ports of both Handheld Terminals so they are pointing directly at each other. The ports can be in direct contact with each other, or they can be separated by up to 30cm (11¹³/₁₆") (up to 20cm (7⁷/₈") for communication between units).

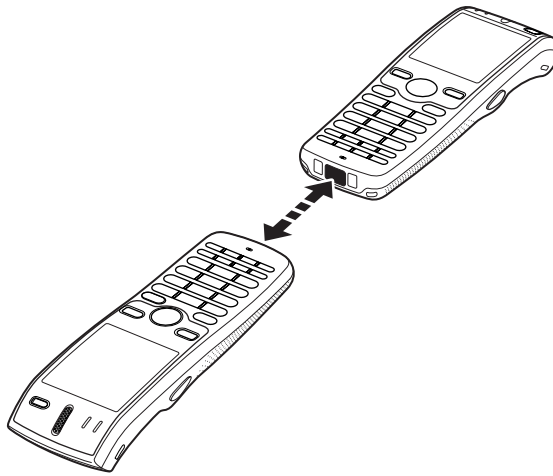

Important!

- A high-sensitivity communication element is used during IR communication.
- In order to ensure successful communication, avoid using cellular phones or other devices that emit radio wave in the area where you are performing IR communication.
- If you need to use such a device, move away from the communicating Handheld Terminals. In case of a cellular phone, keep it at least 30cm (11¹³/₁₆") away.

Bluetooth® Communication

Bluetooth® interface can also be used to transfer data between two Handheld Terminals. With Bluetooth® the two Handheld Terminals should be located within about three meters (9'10³/₈"") (DT-X7M10E/DT-X7M10R) or 100 meters (328'1"") (DT-X7M10U) from each other, as long as there is nothing blocking the path between them.

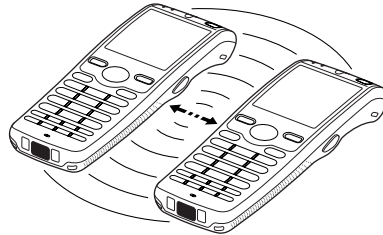

Important!

Observe the following precautions to help ensure that Bluetooth communication is successful.

- Make sure two Handheld Terminals face each other within three meters (9'10³/₈"") (DT-X7M10E/DT-X7M10R) or 100 meters (328'1"") (DT-X7M10U). Surroundings (obstacles) between the Handheld Terminals may cause a shorter distance.
- Make sure there is at least two meters (6'7"") between the Handheld Terminal and other equipment (electrical appliances, audio-visual equipment, OA equipment, and digital cordless telephones, facsimile machines, etc.). (Take special care with microwave ovens. Allow at least three meters (9'10³/₈"") between the Handheld Terminals in wireless operation and a microwave oven.) When approaching such a device when its power is turned on, proper communication may prove impossible while this may also cause interference with TV and radio reception (images produced by certain UHF and broadcast satellite channels may become blurry).
- Normal communication may not be possible in an area near a broadcast transmitter or wireless transmitter. If this happens, move to a different location. Normal communication may not be possible in areas exposed to strong radio waves.
- RF Wireless LAN Interference

Because Bluetooth® and RF wireless LAN use the same frequency band (2.4GHz), radio interference can occur if there is a wireless LAN device nearby. This can result in lower communication speeds, or even make it impossible to establish a connection. If this happens, try the following countermeasures.

- Move at least 10 meters (32'10³/₄"") away from the wireless LAN device.
- If you cannot keep the distance at least 10 meters (32'10³/₄"") or more between the Handheld Terminal and a wireless LAN device, turn off the power of either the Handheld terminal or the wireless LAN device.
- Although the Handheld Terminal enables wireless LAN and Bluetooth® communication to be used simultaneously as a result of being equipped with Bluetooth® Ver.2.0, communication may not be possible depending on the surrounding radio wave environment.

Resetting the Handheld Terminal

Resetting the Handheld Terminal is the same as restarting a computer. Performing a reset causes all unsaved inputs and edits to be lost, but data that is already stored in the memory as well as all settings should be unaffected.

Use reset to restore normal operation whenever the Handheld Terminal operates abnormally due to misoperation or some other reason.

Use a mechanical pencil (with the lead retracted) or similar to press the reset switch on the back of the DT-X7.

This starts the reset operation.

* Do not use a toothpick or pencil or other object whose tip may break off when pressing the reset switch. Otherwise there is a risk of damage.



If reset does not find a memory problem

The Handheld Terminal restarts, and normal operation is restored.

If reset finds a memory problem

A message like the one shown below appears on the display when the reset operation discovers a memory problem.

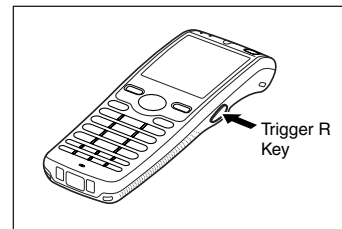
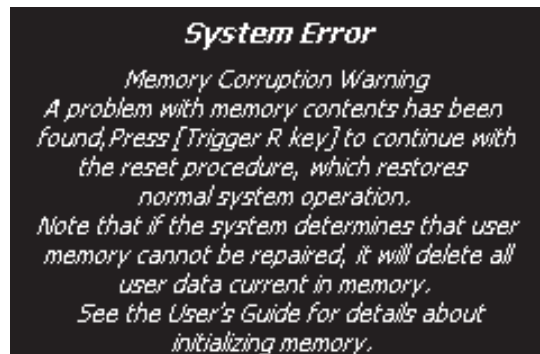

When this message appears, press the Trigger key to continue with the reset operation.

Note, however, that reset may not be successful depending on the condition of the memory. In this case, perform the full reset operation described on the next page.

Performing a Full Reset (Initialization)

Performing a full reset initializes memory. This means that all data stored in the memory (RAM) is deleted and all the settings are returned to their initial factory settings.

Perform a full reset whenever any one of the following conditions exists.

- When you want to delete all memory contents and return the settings to their initial factory settings.
- When you are no longer able to use the Handheld Terminal because you forgot your password.
- When the Handheld Terminal does not operate normally due to a memory problem.
- When the message “A problem with memory contents has been found. ...” appears.

To perform a full reset

Important!

Performing a full reset deletes all data currently stored in the memory (RAM). If possible, backup data of the Handheld Terminal to a computer, Flash Memory, a memory card, or some other medium before performing a full reset.

1. Hold down the power key and the CLR key while pushing down the reset switch for about 1 second with the tip of a mechanical pencil or similar until the message shown below appears on the display.

- To cancel the full reset operation, press the Trigger L key.

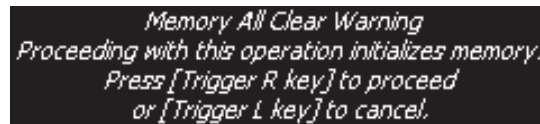

*Memory All Clear Warning
Proceeding with this operation initializes memory.
Press [Trigger R key] to proceed
or [Trigger L key] to cancel.*

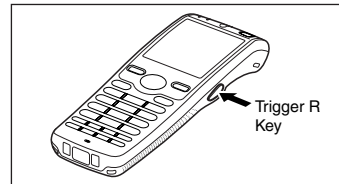

2. Press the Trigger R key. This causes the message shown below to appear.

- To cancel the full reset operation, press the Trigger L key.

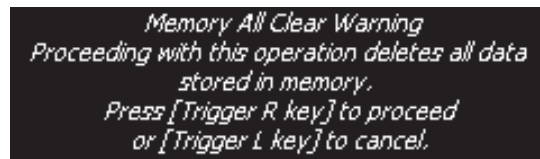

*Memory All Clear Warning
Proceeding with this operation deletes all data
stored in memory.
Press [Trigger R key] to proceed
or [Trigger L key] to cancel.*

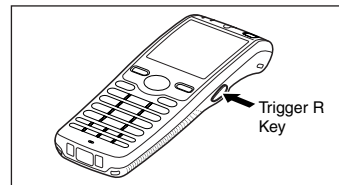

3. Press the Trigger R key again.

- Full reset is performed, all data in the memory (RAM) are erased and the start-up screen is displayed.

DT-X7 Specifications

Model:	DT-X7M10E, DT-X7M10R, DT-X7M10U
CPU:	Marvell® PXA270 416MHz
Memory:	64MB RAM, 64MB Flash ROM (user defined: 30MB)
OS:	Microsoft® Windows® CE5.0 operating system, English Version
Display:	2.4-inch, 320 × 240-dot transreflective TFT color LCD
Laser Scanner (DT-X7M10E, DT-X7M10R):	
Readable symbologies:	UPC-A, UPC-E, EAN8 (JAN8), EAN13 (JAN13), Codabar (NW-7), Code39, Interleaved 2 of 5 (ITF), MSI, Industrial 2 of 5, Code93, Code128 (EAN128), IATA, RSS-14, RSS Limited, RSS Expanded, RSS-14 Stacked, RSS Expanded Stacked* * RSS was renamed as GS1 DataBar in February 2007.
Scanning distance:	Within approximately 40-400 mm (1 ⁹ / ₁₆ "-15 ³ / ₄ "
Linear Imager (DT-X7M10U):	
Readable symbologies:	UPC-A, UPC-E, EAN8 (JAN8), EAN13 (JAN13), Codabar (NW-7), Code39, Interleaved 2 of 5 (ITF), MSI, Industrial 2 of 5, Code93, Code128 (EAN128), IATA, RSS-14, RSS Limited, RSS Expanded, RSS-14 Stacked, RSS Expanded Stacked * RSS was renamed as GS1 DataBar in February 2007.
Scanning distance:	Within approximately 60-300 mm (2 ⁹ / ₁₆ "-11 ¹³ / ₁₆ "
IR Port:	
Interface:	IrDA Ver. 1.3 Standard
Synchronization:	Asynchronous, frame synchronization
Transfer Rate:	Up to 4Mbps (max.)
Bluetooth® (DT-X7M10E, DT-X7M10R):	
Protocol:	Bluetooth® Specification Ver.2.0
Range:	Approximately 3 m (9'10 ³ / ₈ "") (depends on radio wave conditions and environment)
Output:	4dBm max. (PowerClass2)
Bluetooth® (DT-X7M10U):	
Protocol:	Bluetooth® Specification Ver.2.0
Range:	Approximately 100 m (328'1"") (depends on radio wave conditions and environment)
Output:	12dBm max. (PowerClass1)
Wireless Communication:	
Standards:	Complies with IEEE 802.11b Complies with IEEE 802.11g
Diffusion Modulation:	DS: 802.11b DS/OFDM: 802.11g
Frequency:	802.11b/g: 2.400-2.4835 GHz
Transmission Rate:	802.11b: Max. 11 Mbps 802.11g: Max. 54 Mbps
Communication Range:	50 m indoors, 150 m outdoors (varies according to usage environment and transmission rate)
Power Requirements:	
Power Source:	HA-F20BAT Battery Pack HA-F21LBAT Large-capacity Battery Pack
Memory Backup:	Rechargeable Lithium Battery (Built-in)
Consumption Current:	DC 1.3A (DT-X7M10E) DC 1.6A (DT-X7M10R) DC 1.4A (DT-X7M10U)

Battery Life:

Battery pack:

DT-X7M10E/DT-X7M10R

Approximately 15 hours (HA-F20BAT)*

Approximately 26 hours (HA-F21LBAT)*

DT-X7M10U

Approximately 15 hours (HA-F20BAT)*

Approximately 26 hours (HA-F21LBAT)*

Approximately 10 hours (HA-F20BAT)**

Approximately 17 hours (HA-F21LBAT)**

* under the conditions that CPU speed is set to the auto power save mode, backlight is set to off, and the ratio of cyclic operation of “Standby, Key input, and Scanning” is set at 20:1:1.

** under the conditions that CPU speed is set to the auto power save mode, backlight is set to off, and the ratio of cyclic operation of “Standby, Key input, Scanning, and WLAN” is set at 20:1:1:1.

Memory backup: 10 minutes for protection of data in memory
3 days for backup of built-in clock

Operating Temperature: -10°C to 50°C (14°F to 122°F)

Operating Humidity: 10% to 80% RH (non-condensation)

Dust and Water Splash Proof:

IEC60529, IP54 Standard

Dimensions:

Refer to “Dimensional Drawing” on the next page.

Weight:

DT-X7M10E, DT-X7M10R:

Approximately 145g (5.1oz) (when standard battery pack is installed)

DT-X7M10U:

Approximately 155g (5.5oz) (when standard battery pack is installed)

Vibrator Function:

Available according to software setting.

Dimensional Drawing

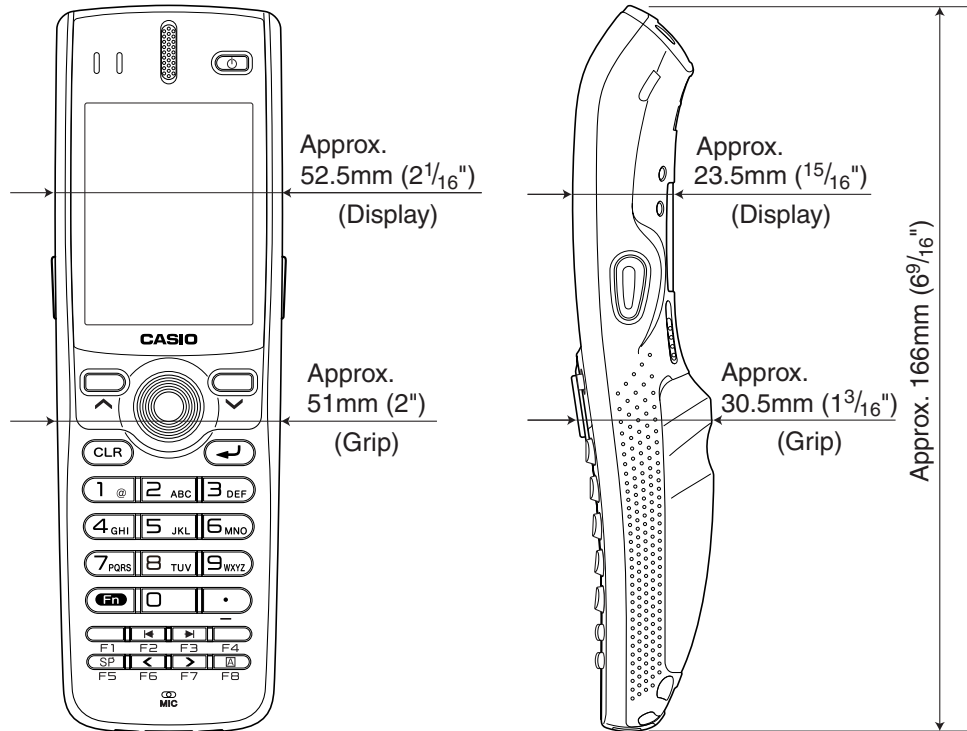

Using the USB Cradle (HA-F60IO)

The optionally available USB Cradle (HA-F60IO) makes it possible to transfer system data and file data between the Handheld Terminal and a PC over a USB connection (download or upload). You can also use the USB Cradle to charge the battery pack installed in the Handheld Terminal.

General Guide

Top

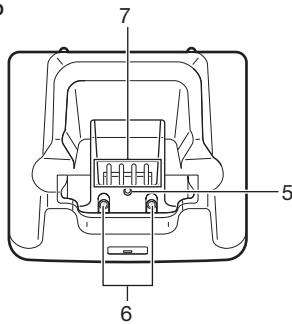

Front

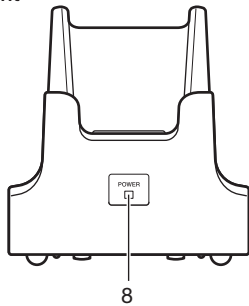

Left

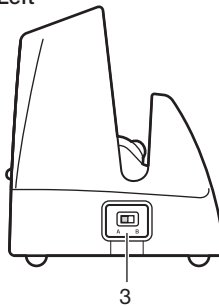

Back

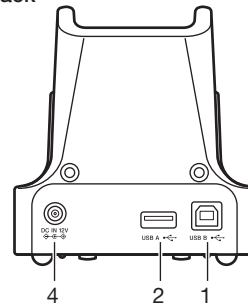

1	USB Client Port	This port is used to transfer system data and file data (download, upload) by connecting the Cradle to a PC using a USB cable (DT-380USB). A dedicated driver must be installed in the PC before connecting the Cradle to the PC.
2	USB Host Port	This port is used to connect a corresponding USB peripheral device.
3	Selector Switch	This switch is used to switch between the USB host port and USB client port.
4	AC Adaptor Jack	Connect the AC adaptor here.
5	Terminal Detect Switch	This switch detects when the DT-X7 is seated correctly on the Cradle.
6	Power Contacts	Power is supplied to the DT-X7 via these contacts.
7	Data Communication Terminal	Used for USB communications.
8	Power LED	This LED indicates the power status and the mounting status of the DT-X7. Off: DT-X7 is not installed. Or, the AC adaptor is not connected. Green: Power on, DT-X7 mounted correctly.

Connecting the USB Cradle Power Supply

Use the separately sold AC adaptor (AD-S42120BE) for the power supply of the USB Cradle. Always make sure to connect the AC adaptor to the USB Cradle before performing communication with the Handheld Terminal. Power to the Handheld Terminal is supplied from the USB Cradle.

1. Plug the AC adaptor into the AC adaptor jack on the back of the USB Cradle.

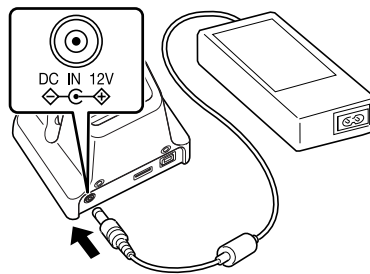

2. After connecting the power cable to the AC adaptor, plug the other end of it into an electrical outlet.

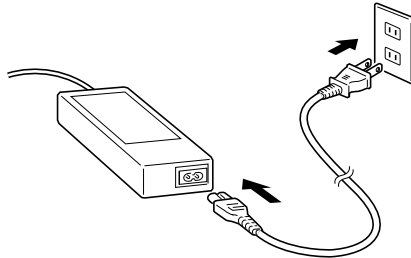

3. Use the selector switch on the left side of the USB Cradle to select the port to be used. Set the switch to the “B” position when using the unit as a USB client, or set it to the “A” position when using the unit as a USB host.

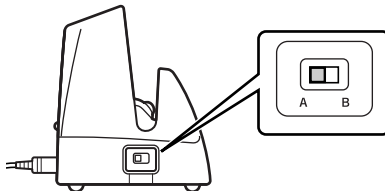

-
4. Connect the USB cable (DT-380USB) to the USB client port on the back of the USB Cradle, and then connect it to the PC. The USB host port is used when connecting the cradle with other USB peripheral device.

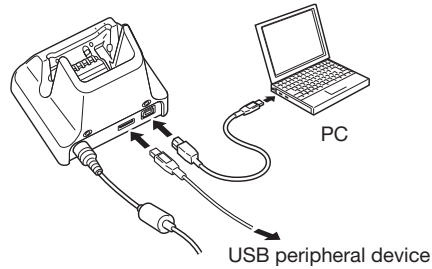

5. Align the contacts on the bottom of the DT-X7 with the power contacts of the USB Cradle when inserting the unit. The power LED on the front of the USB Cradle will light green if the Handheld terminal has been properly mounted.

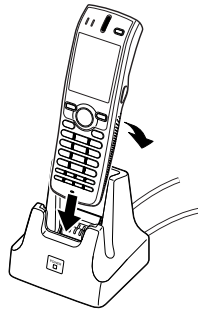

Status of Indicator 1 on DT-X7:

- Orange: Charging
Red: Standby due to battery pack error or outside charging temperature range
(charging begins when the temperature is within the charging temperature range)
Green: Charging complete

Important!

- Always make sure to first remove the Handheld Terminal from the USB Cradle when switching the selector switch.
- Allowing the power contacts become wet can cause an electric shock or fire. In addition, if the contacts become soiled, contact may be impaired resulting in poor charging. For reasons of safety and maintaining charging battery pack(s) in optimum condition, clean the power contacts by wiping with a dry cloth or cotton swab after disconnecting the AC adaptor.
- Never short out the power contacts of the USB Cradle. This can damage the USB Cradle.

-
- **Do not subject the Handheld Terminal and USB Cradle to vibration or impact during communication. This can cause communication to be interrupted.**
 - **When inserting the DT-X7, make sure that it is seated properly and that the power LED at the front of the USB Cradle is lit in green. Charging and communication will not proceed properly if the Handheld Terminal is not mounted properly.**
 - **A USB client and USB host cannot be used concurrently.**
 - **Always cap ports that are not being used. Using the USB Cradle while the ports are uncapped can cause damage.**

Specifications

- 1. USB**
 Protocol: USB Ver1.1 Standard
 Transfer Rate: 12Mbps (max.)
- 2. Charging**
 Charging Method: Constant current/voltage
 Charge Period: Approximately 3 hours (battery pack)
 Approximately 5.5 hours (large-capacity battery pack)
- 3. Power Supply**
 Power Source: AC adaptor (AD-S42120BE)
 Consumption Current: 12V DC approximately 1.3A
 Output to Handheld Terminal: 5V DC 1.6A (max.)
 USB Host Output: 5V DC 0.5A (max.)
- 4. AC Adaptor**
 Model: AD-S42120B
 Input: 100V to 240V AC 50/60Hz 1.2A
 Output: 12V DC 3.5A
- 5. Dimensions and Weight**
 Dimensions: Approximately 93(W) × 83(D) × 101(H) mm
 (3¹¹/₁₆"W × 3¹/₄"D × 4"H)
 Weight: Approximately 270g (9.5oz)
- 6. Operating Environment**
 Temperature: 0°C to 40°C (32°F to 104°F)
 Humidity: 30% to 80% RH (non-condensation)

The AD-S42120 series comes available in the following models depending on area or region where you are in.

Model no. of AC Adaptor	Area/Region	Compliance
AD-S42120BE	All except China	Compliant with CE, UL, FCC, and Energy Efficiency Standards.
AD-S42120BE-CN	China only	Compliant with Energy Efficiency Standards and CCC.

Using the Ethernet Cradle (HA-F62IO)

The optionally available Ethernet Cradle (HA-F62IO) makes it possible to transfer system data and file data between the Handheld Terminal and a PC via a USB or LAN connection (download or upload). You can also use the Ethernet Cradle to charge the battery pack installed in the Handheld Terminal.

General Guide

Top

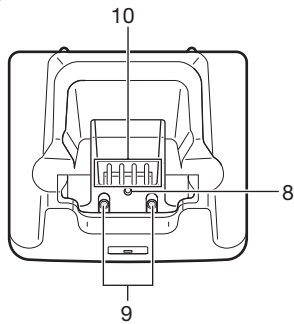

Front

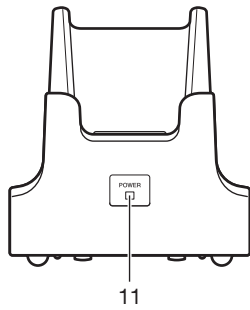

Left

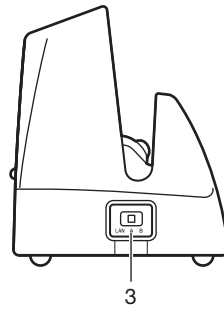

Back

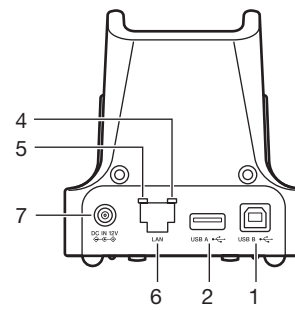

1	USB Client Port	This port is used to transfer system data and file data (download, upload) by connecting the Ethernet Cradle to a PC using a USB cable (DT-380USB). A dedicated driver must be installed in the PC before connecting the Ethernet Cradle to the PC.
2	USB Host Port	This port is used to connect a corresponding USB peripheral device.
3	Selector Switch	This switch is used to switch between a USB connection and a LAN connection.
4	LAN Connection Status LED	This LED shows the status of the LAN connection. Off: LAN cable not connected correctly. Lit green: LAN cable connected correctly.
5	LAN Communication Status LED	This LED shows the LAN operation status. Off: No communication. Blinking green: Communication in progress.
6	LAN Port	This port is used for connecting the cradle to a PC or hub via a LAN cable so that system data and file data can be transferred (uploaded or downloaded). Special driver software must be installed in the DT-X7.
7	AC Adaptor Jack	Connect the AC adaptor here.
8	Terminal Detect Switch	This switch detects when the DT-X7 is seated correctly on the Ethernet Cradle.
9	Power Contacts	Power is supplied to the DT-X7 via these contacts.
10	Communication Terminal	Used for communications.
11	Power LED	This LED indicates the power status and the mounting status of the DT-X7. Off: DT-X7 is not installed. Or, the AC adaptor is not connected. Green: Power on, DT-X7 mounted correctly.

Connecting the Ethernet Cradle Power Supply

Use the separately sold AC adaptor (AD-S42120BE) for the power supply of the Ethernet Cradle. Always make sure to connect the AC adaptor to the Ethernet Cradle before performing communication with the Handheld Terminal. Power to the Handheld Terminal is supplied from the Ethernet Cradle.

1. Plug the AC adaptor into the AC adaptor jack on the back of the Ethernet Cradle.

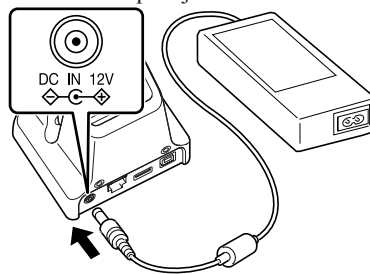

2. After connecting the power cable to the AC adaptor, plug the other end of it into an electrical outlet.

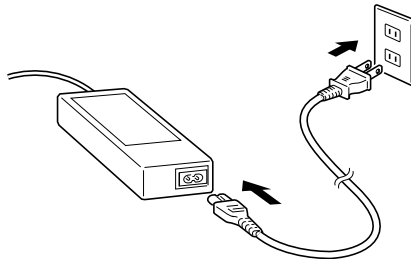

3. Use the selector switch on the left side of the Ethernet Cradle to select the port to be used. Set the switch to the “LAN” position when using the LAN port on the cradle. Set the switch to the “B” position when using the unit as a USB client, or set it to the “A” position when using the unit as a USB host.

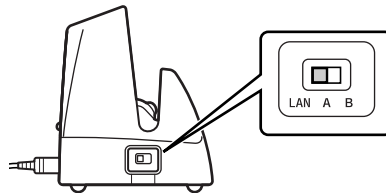

4. Before using the cradle ports, remove the caps from the ports.

When using a LAN, connect one end of the LAN cable to the LAN port and the other end to the PC or hub.

When using a USB connection, connect one end of the USB cable (DT-380USB) to the USB port and the other end to the PC.

The USB host port is used for connecting the cradle with other USB peripheral device.

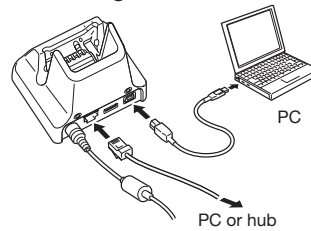

5. Align the contacts on the bottom of the DT-X7 with the power contacts of the Ethernet Cradle when inserting the unit.

The power LED on the front of the Ethernet Cradle will light green if the Handheld Terminal has been properly mounted.

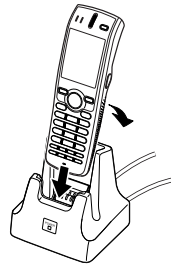

Status of Indicator 1 on DT-X7:

Orange: Charging

Red: Standby due to battery pack error or outside charging temperature range
(charging begins when the temperature is within the charging temperature range)

Green: Charging complete

Important!

- Always make sure to first remove the Handheld Terminal from the Ethernet Cradle when switching the selector switch.
- Allowing the power contacts become wet can cause an electric shock or fire. In addition, if the contacts become soiled, contact may be impaired resulting in poor charging. For reasons of safety and maintaining charging battery pack(s) in optimum condition, clean the power contacts by wiping with a dry cloth or cotton swab after disconnecting the AC adaptor.
- Never short out the power contacts of the Ethernet Cradle. This can damage the Ethernet Cradle.
- Do not subject the Handheld Terminal and Ethernet Cradle to vibration or impact during communication. This can cause communication to be interrupted.

-
- **When inserting the DT-X7, make sure that it is seated properly and that the power LED at the front of the Ethernet Cradle is lit in green. Charging and communication will not proceed properly if the Handheld Terminal is not mounted properly.**
 - **A LAN, USB client and USB host cannot be used concurrently.**
 - **Always cap ports that are not being used. Using the Ethernet Cradle while the ports are uncapped can cause damage.**

Specifications

1. LAN Specifications

Communications protocol: IEEE 802.3
Media type: 10base-T/100base-TX auto-switched

2. USB

Protocol: USB Ver1.1 Standard
Transfer Rate: 12Mbps (max.)

3. Charging

Charging Method: Constant current/voltage
Charge Period: Approximately 3 hours (battery pack)
Approximately 5.5 hours (large-capacity battery pack)

4. Power Supply

Power Source: AC adaptor (AD-S42120BE)
Consumption Current: 12V DC approximately 1.5A
Output to Handheld Terminal: 5V DC 1.6A (max.)
USB Host Output: 5V DC 0.5A (max.)

5. AC Adaptor

Model: AD-S42120B
Input: 100V to 240V AC 50/60Hz 1.2A
Output: 12V DC 3.5A

6. Dimensions and Weight

Dimensions: Approximately 93(W) × 83(D) × 101(H) mm
(3¹¹/₁₆"W × 3¹/₄"D × 4"H)

Weight: Approximately 280g (9.9oz)

7. Operating Environment

Temperature: 0°C to 40°C (32°F to 104°F)
Humidity: 30% to 80% RH (non-condensation)

*See page 47.

Using the Cradle-type Battery Charger (HA-F30CHG)

The optionally available Cradle-type Battery Charger (HA-F30CHG) lets you charge the Handheld Terminal's battery simply by placing the Handheld Terminal onto the charger.

General Guide

Top

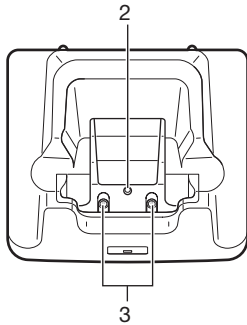

Front

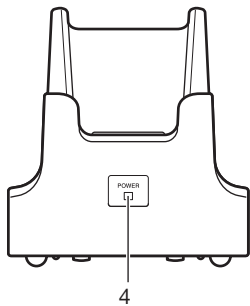

Left

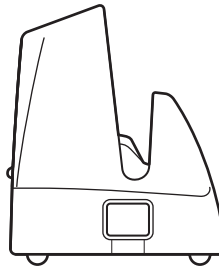

Back

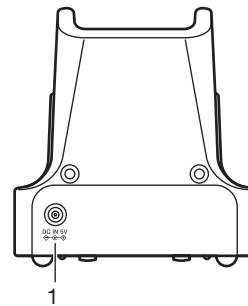

1	AC Adaptor Jack	Connect the AC adaptor here.
2	Terminal Detect Switch	This switch detects when the DT-X7 is mounted correctly on the charger.
3	Power Contacts	Power is supplied to the DT-X7 via these contacts.
4	Power LED	This LED indicates the power status and the mounting status of the Handheld Terminal. Off: DT-X7 is not installed Green: Power on, DT-X7 mounted correctly

Connecting the AC Adaptor for Cradle-type Battery Charger

Use the separately sold AC adaptor (AD-S15050BE) for the power supply of the Cradle-type Battery Charger.

1. Plug the AC adaptor into the AC adaptor jack on the back of the charger.

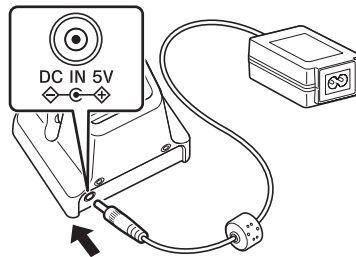

2. Next, plug the AC adaptor into a wall outlet.

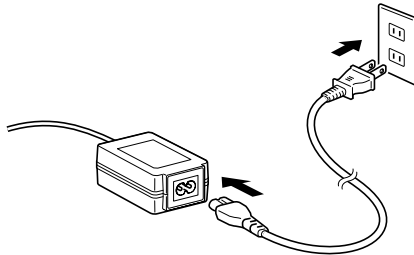

3. Align the contacts on the bottom of the DT-X7 with the power contacts of the Cradle-type Battery Charger when inserting the unit.
The power LED on the front of the charger will light green if the Handheld Terminal has been properly mounted.

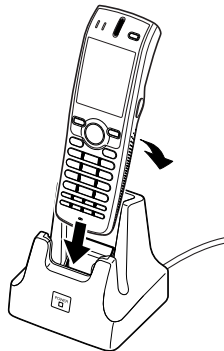

Status of Indicator 1 on DT-X7:

Orange: Charging

Red: Standby due to battery pack error or outside charging temperature range
(charging begins when the temperature is within the charging temperature range)

Green: Charging complete

Important!

- **Never short out the power contacts of the Cradle-type Battery Charger. This can damage the Cradle-type Battery Charger.**
- **Allowing the power contacts become wet can cause an electric shock or fire. In addition, if the contacts become soiled, contact may be impaired resulting in poor charging. For reasons of safety and maintaining charging battery pack(s) in optimum condition, clean the power contacts by wiping with a dry cloth or cotton swab after disconnecting the AC adaptor.**
- **When inserting the DT-X7, make sure that it is seated properly and that the power LED at the front of the Cradle-type Battery Charger is lit in green. Charging and communication will not proceed properly if the Handheld Terminal is not mounted properly.**

Specifications

1. Charging Specifications

Charging Method: Constant current/voltage
Charge Period: Approximately 3 hours (battery pack)
Approximately 5.5 hours (large-capacity battery pack)

2. Power Supply

Power Source: AC adaptor (AD-S15050BE)
Consumption Current: 5V DC 1.6A
Output to Handheld Terminal: 5V DC 1.6A (max.)

3. AC Adaptor

Model: AD-S15050B
Input: 100V to 240V AC 50/60Hz 0.4A
Output: 5V DC 3.0A

4. Dimensions and Weight

Dimensions: Approximately 93(W) × 83(D) × 101(H) mm
(3¹¹/₁₆"W × 3¹/₄"D × 4"H)
Weight: Approximately 230g (8.1oz)

5. Operating Environment

Temperature: 0°C to 40°C (32°F to 104°F)
Humidity: 30% to 80% RH (non-condensation)

The AD-S15050 series comes available in the following models depending on area or region where you are in.

Model no. of AC Adaptor	Area/Region	Compliance
AD-S15050BE	All except China	Compliant with CE, UL, FCC, and Energy Efficiency Standards.
AD-S15050BE-CN	China only	Compliant with Energy Efficiency Standards and CCC.

Using the Cradle-type Dual Battery Charger (HA-F36DCHG)

The optionally available Cradle-type Dual Battery Charger (HA-F36DCHG) can be used to simultaneously charge two battery packs.

General Guide

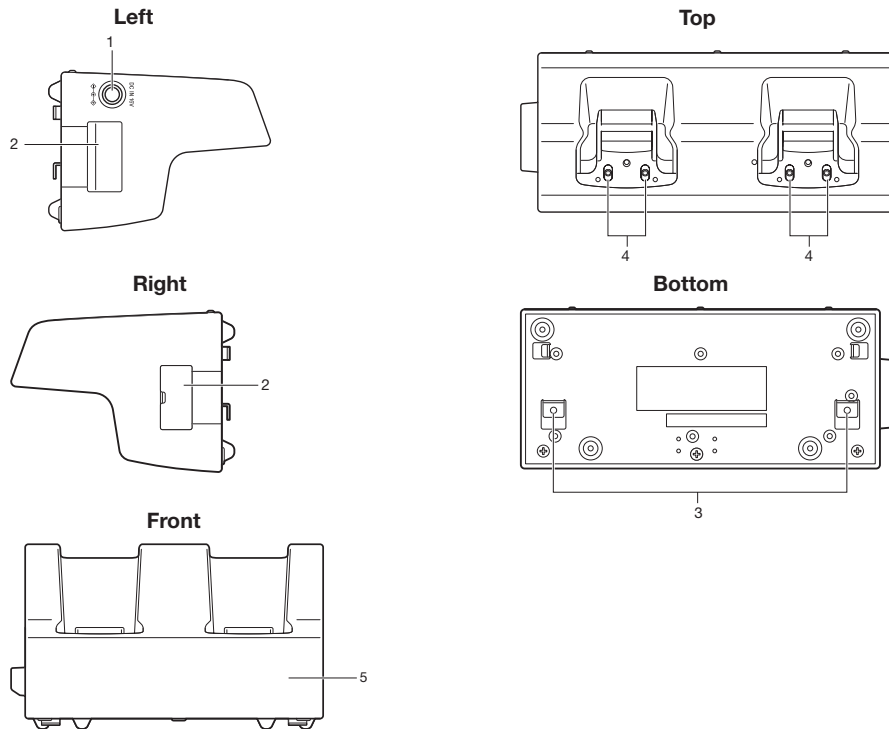

1	AC Adaptor Jack	This is used to supply power by connecting the AC adaptor (sold separately).
2	Cradle-type Dual Battery Charger Connection Port	Use this port to connect multiple Cradle-type Dual Battery Chargers to each other.
3	Connection Bracket Attachment Holes	The connection bracket attaches here when you connect multiple Cradle-type Dual Battery Chargers to each other.
4	Power Contacts	Power is supplied to the Handheld Terminal via these contacts.
5	Holding plate attaching part	The holding plates which prevent the DT-X7 from falling down are to be attached on this part.

Bundled Items

Used when linking two or more Cradle-type Dual Battery Chargers.

- Connection bracket (for rear)
- Connection bracket (for side)
- Connection screws (for rear and side), 2 each
- Holding plate x 2

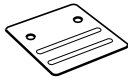
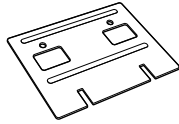

Attaching the holding plates

1. Peel off the cover of the adhesive patch on the rear of the holding plate.



2. Attach the holding plate to the front of the Cradle-type Dual Battery Charger, aligning it on the cutout.

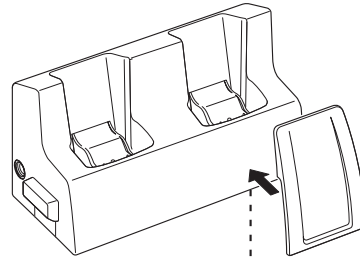

3. Attach the other holding plate in the same way.

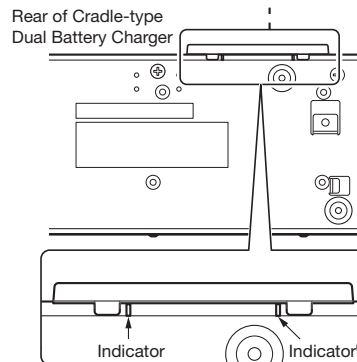
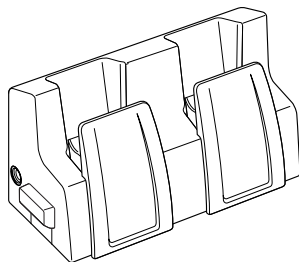

Attach the plate to the rear of the Cradle-type Dual Battery Charger, aligning the plate to the indicators as shown above.

Charging Battery Pack

Use the separately sold AC adaptor (AD-S60160BE/AD-S60160BU) for the power supply of the Cradle-type Dual Battery Charger.

1. Plug the cord from the AC adaptor into the AC adaptor jack of the Cradle-type Dual Battery Charger.
2. Plug the AC cord into a wall outlet.

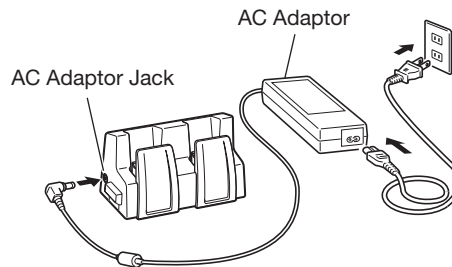

3. Align the contacts on the bottom of the DT-X7 with the power contacts of the Cradle-type Dual Battery Charger when inserting the unit.
 - Check the charging status with Indicator 1 on the DT-X7.

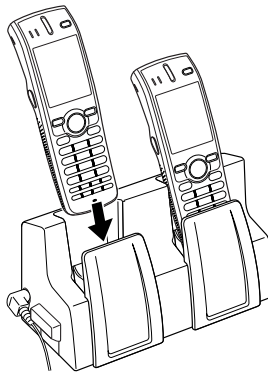

Status of Indicator 1 on DT-X7

Orange: Charging

Red: Battery pack problem, or stand by due to the surrounding temperature being beyond the specified temperature range (charging resumes when the temperature reaches the range.)

Green: Charging complete

Connecting Multiple Cradle-type Dual Battery Chargers

You can connect up to three Cradle-type Dual Battery Chargers. Doing so makes it possible to supply power to all the Cradle-type Dual Battery Chargers using one dedicated AC adaptor.

1. As shown in the illustrations below, remove the connector covers of the Cradle-type Dual Battery Chargers you want to connect to each other.

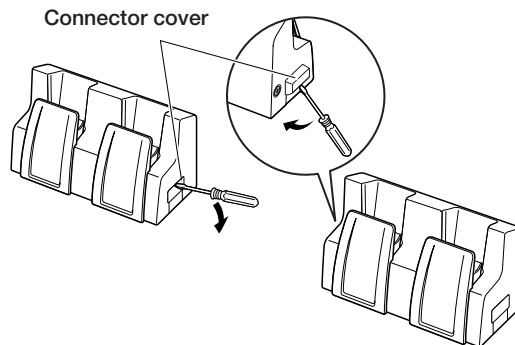

2. Connect the two Cradle-type Dual Battery Chargers as shown below.

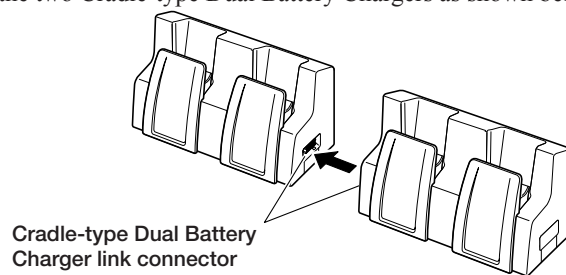

3. Attach the rear and side connection brackets with the connection screws.

You can repeat the above steps to connect up to 3 Cradle-type Dual Battery Chargers.

* Attach the connection brackets so that the front side faces outwards. (The front side has protruding ribs.)

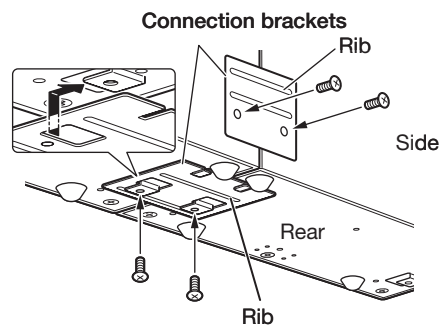

Specifications

1. Charging Specification

Charging Method: Constant current/voltage
 Charge Period: Approx. 3 hours (1 standard battery pack)
 Approx. 5.5 hours (1 large-capacity battery pack)

2. Power Supply

Power Source: AC adaptor (AD-S60160BE/AD-S60160BU)
 Consumption Current: 1.25A, 16V DC (1 unit)
 3.7A, 16V DC (3 units)
 Output to Handheld Terminal: 5V DC 1.6A (max.)

3. AC Adaptor

Model: AD-S60160B/AD-S60160BU
 Input: 100V to 240V AC 50/60 Hz 1.5A
 Output: 16V DC 3.0A

4. Dimensions and Weight

Dimensions: Approximately 189(W) × 80(D) × 110(H) mm
 (7⁷/₁₆"W × 3¹/₈"D × 4⁵/₁₆"H)
 Weight: Approximately 500g (17.6oz)

5. Operating Environment

Temperature: Approximately 0°C to 40°C (32°F to 104°F)
 Humidity: 30% to 80% RH (non-condensation)

The AD-S60160 series comes available in the following models depending on area or region where you are in.

Model no. of AC Adaptor	Area/Region	Compliance
AD-S60160BE	European only	Compliant with CE and Energy Efficiency Standards.
AD-S60160BE-CN	China only	Compliant with Energy Efficiency Standards and CCC.
AD-S60160BU	US only	Compliant with UL, FCC, and Energy Efficiency Standards.

Important!

- Never short out the power contacts of the Cradle-type Dual Battery Charger. This can damage the Cradle-type Dual Battery Charger.
- Allowing the power contacts become wet can cause an electric shock or fire. In addition, if the contacts become soiled, contact may be impaired resulting in poor charging. For reasons of safety and maintaining charging battery pack(s) in optimum condition, clean the power contacts by wiping with a dry cloth or cotton swab after disconnecting the AC adaptor.
- When placing DT-X7 with the Hand Belt (HA-F95HB) attached in the charger, loosen the belt beforehand to ensure that it does not become an obstruction. Check the Indicator 1 on the DT-X7 to ensure that the DT-X7 is securely positioned in the charger. The indicator will light up in orange for correct positioning.
- Each unit of the charger comes with one piece each of the side and bottom brackets. After you join two chargers together using these two brackets, one side bracket and one bottom bracket will be left over. Keep these as spare for use in future.
- Before linking multiple Cradle-type Dual Battery Chargers, be sure to disconnect the AC adaptor.
- Turn off the power on DT-X7 before placing it in the charger.

Using the Dual Battery Charger (HA-F32DCHG)

The optionally available Dual Battery Charger (HA-F32DCHG) can be used to simultaneously charge two battery packs.

General Guide

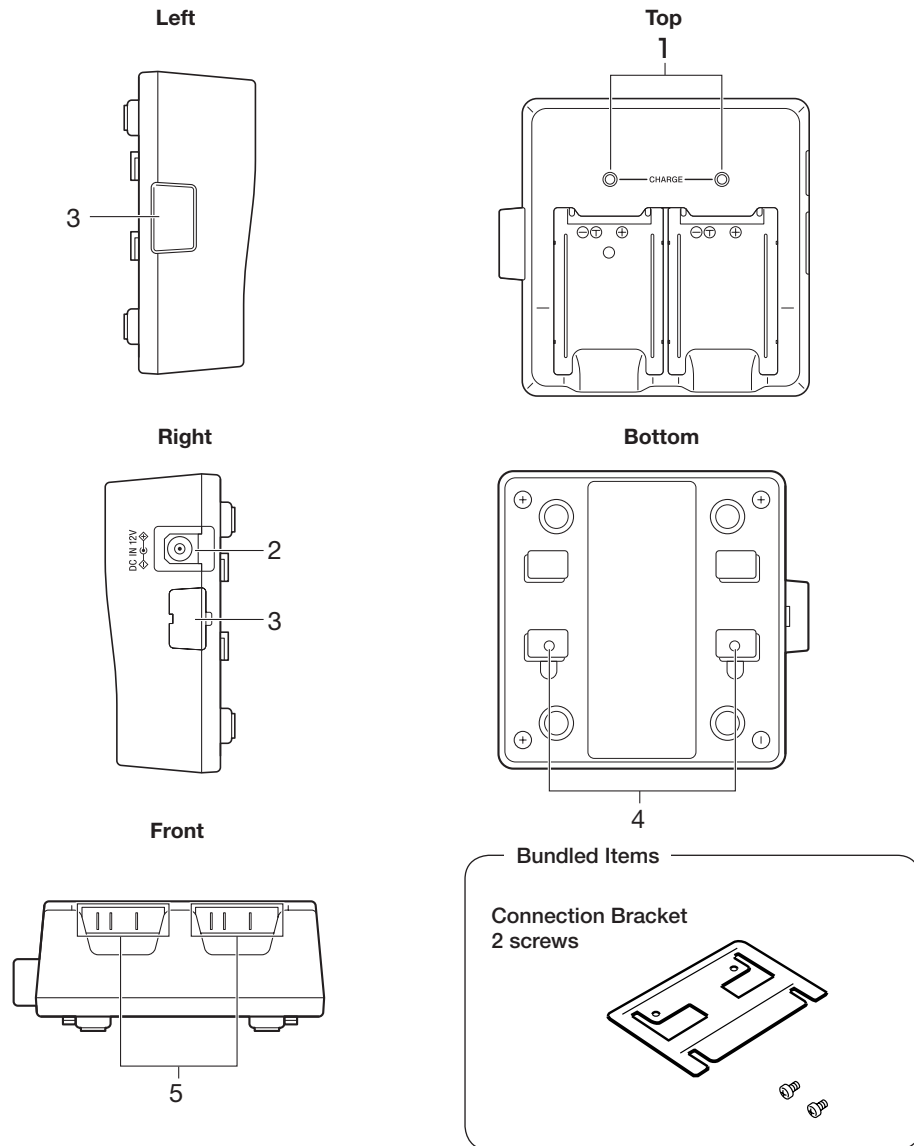

1	Charge Indicator LED	This LED indicates the charge status of the battery pack(s). Off: Not charging Red: Charging Red Flashing: Battery pack problem Green Flashing: Standby Green: Charging complete
2	AC Adaptor Jack	This is used to supply power by connecting the AC adaptor (sold separately).
3	Dual Battery Charger Connection Port	Use this port to connect multiple Dual Battery Chargers to each other.
4	Connection Bracket Attachment Holes	The connection bracket attaches here when you connect multiple Dual Battery Chargers to each other.
5	Power Contacts	Power is supplied to the Handheld Terminal via these contacts.

Important!

- **Allowing the power contacts become wet can cause an electric shock or fire. In addition, if the contacts become soiled, contact may be impaired resulting in poor charging. For reasons of safety and maintaining charging battery pack(s) in optimum condition, clean the power contacts by wiping with a dry cloth or cotton swab after disconnecting the AC adaptor.**
- **Although the battery may become warm during charging, this is normal and does not indicate a malfunction.**
- **Do not place objects such as a cover over the Dual Battery Charger while charging.**
- **Do not remove the battery pack or disconnect the AC adaptor during charging.**
- **Repeated “Mounting and Removing” of battery pack in excess of times may cause the quality deterioration of the battery pack.**
- **Each Dual Battery Charger comes with one connection bracket. Since only one connection bracket is required when you connect two Dual Battery Chargers, you will always have one left over. Simply keep the other connection bracket on hand as an extra, in case you ever need it.**

Charging Battery Pack

Use the separately sold AC adaptor (AD-S42120BE) for the power supply of the Dual Battery Charger.

1. Plug the cord from the AC adaptor into the AC adaptor jack of the Dual Battery Charger.
2. Plug the AC cord into a wall outlet.

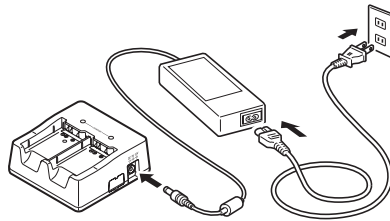

3. Taking care that the battery pack is oriented correctly, insert it into the Dual Battery Charger.

This causes the Charge Indicator LED to light in red, indicating that charging has started.

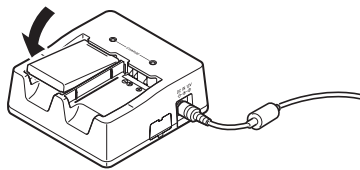

Status of Charge Indicator LED

Off:	Not charging
Red:	Charging
Red Flashing:	Battery pack problem
Green:	Charging complete
Green Flashing:	Standby due to the surrounding temperature being beyond the specified temperature range (Approximately 0°- 40°C) (charging resumes when the temperature reaches the range.)

Connecting Multiple Dual Battery Chargers

You can connect up to three Dual Battery Chargers. Doing so makes it possible to supply power to all the Dual Battery Chargers using one dedicated AC adaptor.

1. As shown in the illustrations below, remove the connector covers of the Dual Battery Chargers you want to connect to each other.

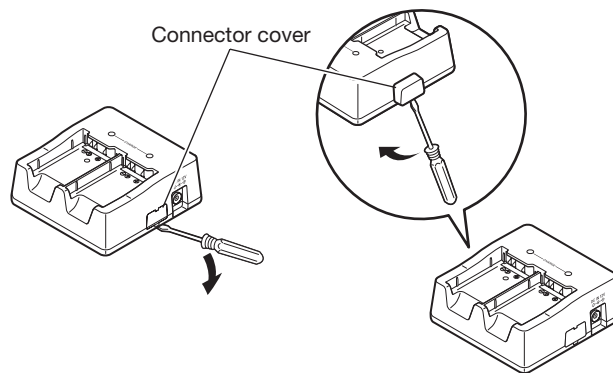

2. Connect the two Dual Battery Chargers as shown below.

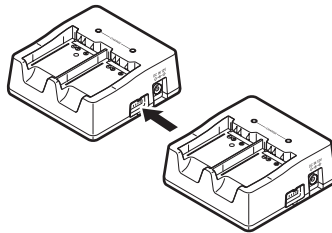

3. Turn over the connected Dual Battery Chargers and attach a connection bracket, securing it in place with screws.

You can repeat the above steps to connect up to 3 Dual Battery Chargers.

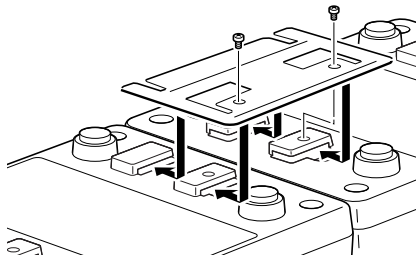

Specifications

1. Charging Specification

Charging Method:	Constant current/voltage
Charge Period:	Approx. 3 hours (1 standard battery pack, normal temperature) Approx. 5.5 hours (1 large-capacity battery pack, normal temperature) When charging two battery packs: Approx. 5.5 hours (2 standard battery packs, normal temperature) Approx. 10 hours (2 large-capacity battery packs, normal temperature)

2. Power Supply

Power Source:	AC adaptor (AD-S42120BE)
Consumption Current:	12V DC 3.5A
Output:	4.2V DC 1.1A (max.)

3. AC Adaptor

Model:	AD-S42120B
Input:	100V to 240V AC 50/60Hz 1.2A
Output:	12V DC 3.5A

4. Dimensions and Weight

Dimensions:	Approximately 108(W) × 104(D) × 45(H) mm (4 ¹ / ₄ "W × 4 ¹ / ₈ "D × 1 ³ / ₄ "H)
Weight:	Approximately 152g (5.4oz)

5. Operating Environment

Temperature:	Approximately 0°C to 40°C (32°F to 104°F)
Humidity:	30% to 80% RH (non-condensation)

*See page 47

Using Rechargeable Battery Pack

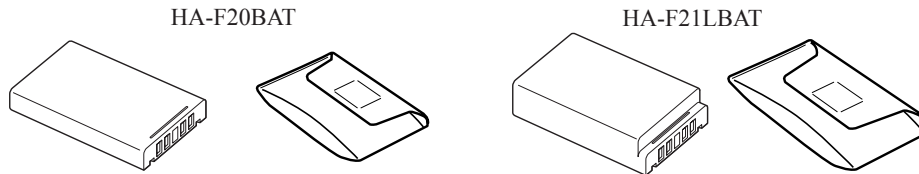

Your Handheld Terminal supports use of two battery pack types, one at a time, of different capacity.

You can select the one that best suits your needs in terms of operating time, the type of options you need to use, etc.

When using the large-capacity battery pack, you need to use the special large-capacity battery pack cover that comes with the battery pack (HA-F21LBAT).

Important!

- Store a battery pack in its special soft case whenever you are not using it.
- If the battery pack has been left over unused for a long period of time, the capacity remained decreases due to spontaneous discharge or chemical decomposition by the battery pack itself. If the battery pack fails to hold its operating duration after it has been fully charged, replace it with a new one. The battery pack may reach the end of its service life.

Battery Pack Specifications

Model:	HA-F20BAT
Rated Capacity:	1100mAh
Rated Voltage:	3.7V
Dimensions:	Approximately 36(W) × 55(D) × 9(H) mm (1 ⁷ / ₁₆ "W × 2 ³ / ₁₆ "D × ³ / ₈ "H)
Weight:	Approximately 28g (1oz)
Bundled Item:	Soft case

Large-capacity Battery Pack Specifications

Model:	HA-F21LBAT
Rated Capacity:	1880mAh
Rated Voltage:	3.7V
Dimensions:	Approximately 36(W) × 55(D) × 14(H) mm (1 ⁷ / ₁₆ "W × 2 ³ / ₁₆ "D × ⁹ / ₁₆ "H)
Weight:	Approximately 46g (1.6oz)
Bundled Item:	Soft case

Warning Label (on top side of battery pack)

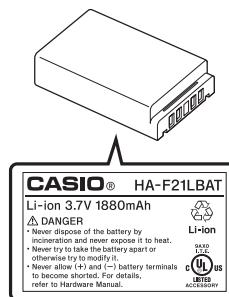
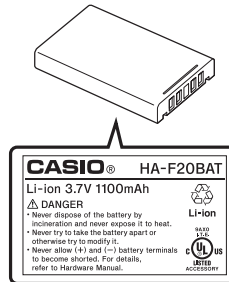

Attaching the Hand Belt (HA-F95HB)

To use the Hand Belt (HA-F95HB), attach it to the DT-X7 as follows.

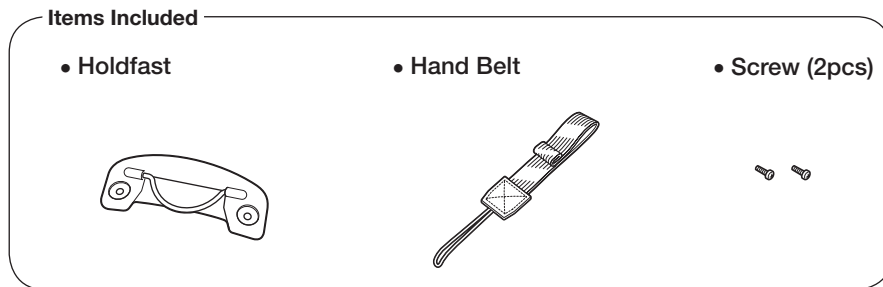

Attaching the Hand Belt

Attach the Hand Belt as described below.

1. Turn the DT-X7 over.
2. Attach the holdfast to the back of the DT-X7 and secure it using the screws supplied.

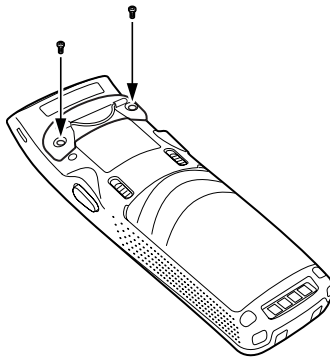

-
3. Thread the looped cord on the end of the Hand Belt through one of the strap holes at the bottom of the DT-X7. (You can use either hole.)

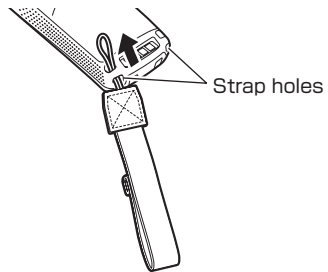

4. Feed the belt through the wire loop on the mount, fold it back and secure it with the Velcro fastener.

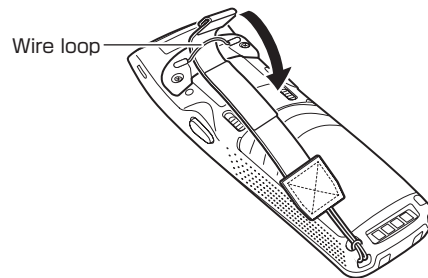







Important!





- When inserting the DT-X7 with the Hand Belt attached into the USB Cradle, etc., check the Power LED on the cradle and the indicator on the DT-X7 to ensure that the DT-X7 is inserted securely.
The DT-X7 must be inserted correctly to charge and communicate successfully.

Using the Dry-cell Battery Case (HA-F22BC)

Alkaline Battery Handling Precautions

 Danger	
	<ul style="list-style-type: none">• Since there is the risk of blindness and other serious disorders when alkaline battery fluid enters the eyes, seek medical treatment immediately after adequately flushing the eyes with a large amount of tap water or other clean water without rubbing.
 Warning	
	<ul style="list-style-type: none">• Do not dispose of batteries in open flames or allow them to be heated, disassembled or modified. This results in the risk of damaging insulation and safety valves or causes the batteries to leak fluid, overheat or rupture.
	<ul style="list-style-type: none">• Do not reverse the (+) and (–) poles of the batteries. This results in the risk of abnormal reactions during charging or short-circuiting, or causes the batteries to leak fluid, overheating or rupture.• Store batteries in a location out of the reach of small children. In the case a battery should happen to be swallowed, seek medical treatment immediately.• In the case of having ingested alkaline battery fluid, gargle immediately and seek medical treatment.• Since there is the risk of injury to the skin in the case alkaline battery fluid has come in contact with the skin or clothing, immediately rinse off with a large amount of tap water or other clean water.
	<ul style="list-style-type: none">• Do not allow the (+) and (–) poles of alkaline batteries to come in contact with wires or other metal objects, and do not carry or store them together with metal necklaces, hair pins and so on. This results in the risk of the batteries short-circuiting resulting in the flow of excess current and causing the batteries to leak fluid, overheat or rupture.• Do not use a new battery with an old battery that has already been used or use different types of batteries. Differences in properties results in the risk of the batteries leaking fluid, overheating or rupturing.• These batteries are not designed to be recharged. Recharging results in the risk of damage to insulation and internal structure causing the batteries to leak fluid, overheat or rupture.
	<ul style="list-style-type: none">• Do not remove or damage the battery outer label. This results in the risk of the batteries short-circuiting, leaking fluid, overheating or rupturing.• Do not subject the batteries to strong impacts resulting from dropping or throwing. This results in the risk of the batteries leaking fluid, overheating or rupturing.• Do not allow the batteries to be deformed or damaged. This results in the risk of damage to the insulation and safety valve causing the batteries to leak fluid, overheat or rupture.

 **Caution**

-  • Promptly remove worn out batteries from the Handheld Terminal. Allowing worn out batteries to remain installed in the Handheld Terminal for a long period of time results in the risk of the generation of gas from the batteries causing the batteries to leak fluid, overheat or rupture.
- Remove the batteries from the Handheld Terminal when not using for a long period of time. Failure to do so results in the risk of the generation of gas from the batteries causing the batteries to leak fluid and damage the Handheld Terminal.
-  • Do not attempt to solder the batteries directly. This results in the risk of heat damaging the insulation and safety valve causing the batteries to leak fluid, overheat or rupture.
- Do not use or place the batteries in a location subject to high temperatures such as locations of intense direct sunlight or in an automobile on a hot day. This results in the risk of the batteries leaking fluid, overheating or rupturing.
-  • Insulate the ends of the batteries by covering with tape and so on when storing or disposing. Allowing the batteries to contact other batteries or metal objects results in the risk of the batteries leaking fluid, overheating or rupturing.
-  • Do not allow the batteries to become wet. This results in the risk of the batteries overheating.
-  • Avoid storing batteries in locations subject to direct sunlight, high temperature or high humidity. This results in the risk of the batteries leaking fluid. In addition, there is also the risk of reduced battery performance and shorter battery life.
- Although these batteries may be disposed of in the same manner as ordinary non-burnable garbage, please dispose of them in the proper manner in accordance with the rules and regulations of your local community when applicable.

A Dry-cell Battery Case (HA-F22BC) is available as option, for use with dry-cell batteries installed in it in the event of a power failure or natural disaster.

* The Dry-cell Battery Case can power the DT-X7 for about 5 hours of continuous operation (with four fresh IEC R03 size AAA alkaline batteries inserted).

For normal use, the separately available rechargeable battery pack should be used.

Bundled Item

- Dry-cell Battery Case Cover

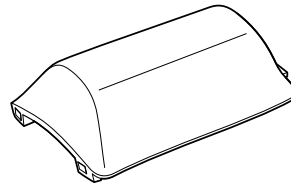

Loading

Proceed as follows to use the Dry-cell Battery Case.

1. Insert Dry-cell size AAA alkaline batteries x 4pcs into the Dry-cell Battery Case as shown in the illustration.

- Make sure that each battery polarity is correct, as shown in the illustration.

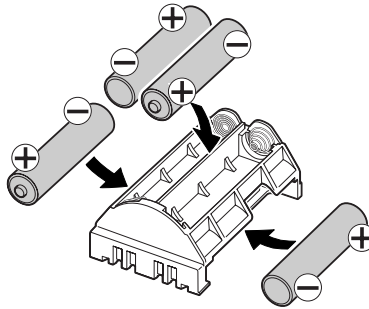

2. Load the Dry-cell Battery Case into the DT-X7.

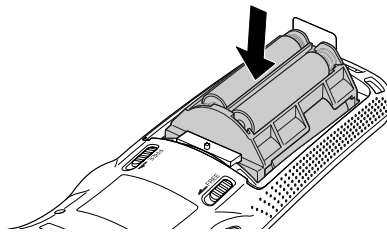

3. Attach the Dry-cell Battery Case Cover to the DT-X7.

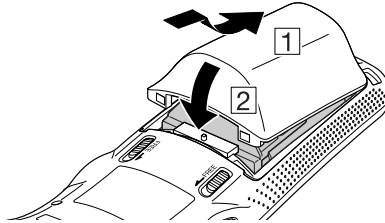

Removing

1. Remove the Dry-cell Battery Case Cover from the DT-X7, as shown in the illustration.

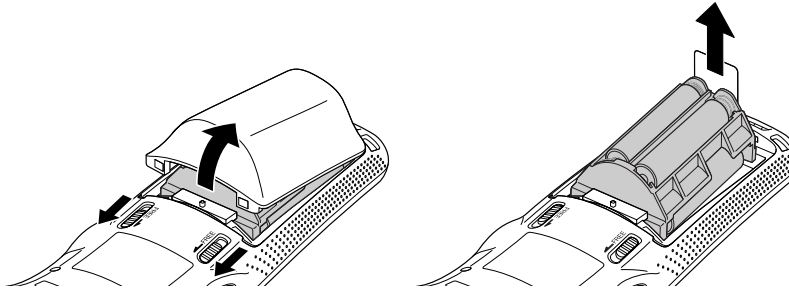

Specifications

Power Source:	Dry-cell size AAA alkaline batteries x 4pcs
Output:	4.7V DC
Battery Life:	Approximately 5 hours*
Dimensions:	Approximately 37(W) × 56(D) × 23(H) mm (1 ⁷ / ₁₆ "W × 2 ³ / ₁₆ "D × 7 ⁷ / ₈ "H)
Weight:	Approximately 15g (0.5oz) (not including dry-cell batteries)

* under the conditions that backlight's brightness is set to 5th grade and the ratio of cyclic operation of "Standby, Key input, and Scanning" is set at 10:1:1.

Important!

- When dry-cell alkaline batteries are used, the following must be noted:
WLAN communication, vibrator, and charging batteries are not operable
Other functional limitations are as follows.
 - CPU speed is set at 104 MHz
 - Backlight's brightness is reduced to 50%

