



CASIO^E

Handheld Printer Terminal **IT-3000** Series

User's Guide

Be sure to read "Safety Precautions" inside this guide before trying to use your Handheld Printer Terminal. After reading this guide, keep it in a safe place for future reference.

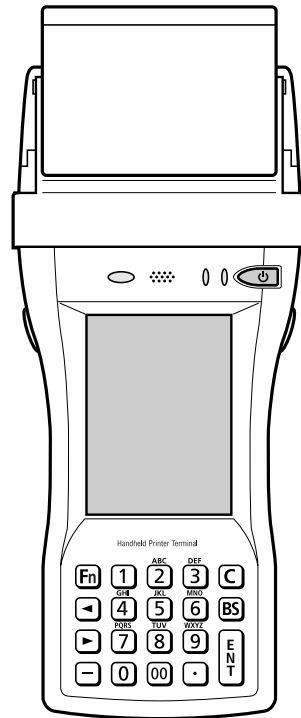

PN410385-001



- This Product is equipped with the Brycen B-RAPPORE Stack and My Wirefree Network Bluetooth User Interface Application, the use of which is governed by a license granted by Brycen Co., Ltd.



- **Bluetooth™**
- BLUETOOTH is a trademark owned by Bluetooth SIG, Inc. and licensed to CASIO COMPUTER CO., LTD.
- Microsoft and Windows are either registered trademarks or trademarks of Microsoft Corporation in the United States and/or other countries.
- Datalight is a registered trademark of Datalight, Inc.
- FlashFX™ is a trademark of Datalight, Inc.
Copyright 1993-2000 Datalight, Inc., All Rights Reserved.
U.S. Patent Office 5,860,082
- Other company names and product names used in this guide are trademarks or registered trademarks of their respective owners.





Safety Precautions

Congratulations upon your selection of this CASIO product. Be sure to read the following Safety Precautions before trying to use it for the first time.

Markings and Symbols

The following are the meanings of the markings and symbols used in these Safety Precautions.

 **Danger** This symbol indicates information that, if ignored or applied incorrectly, creates the danger of death or serious personal injury.

 **Warning** This symbol indicates information that, if ignored or applied incorrectly, creates the possibility of death or serious personal injury.

 **Caution** This symbol indicates information that, if ignored or applied incorrectly, creates the possibility of personal injury or property damage.



• A diagonal line indicates something you should not do. The symbol shown here indicates you should not try to take the unit apart.



• A black circle indicates something you should do. The symbol shown here indicates you should unplug the unit from the wall outlet.

Precautions During Use

Warning

Disassembly and Modification



• Never try to disassemble or modify the Handheld Printer Terminal and its options in any way. High voltage inside creates the danger of electric shock.

Abnormal Conditions



• Should the Handheld Printer Terminal and its options become hot or start to emit smoke or a strange odor, immediately turn off the power, and contact your original vendor or an authorized CASIO service provider. Continued use creates the danger of fire and electric shock.



Safety Precautions

Warning

Foreign Objects

-  Should any foreign matter get into the Handheld Printer Terminal and its options, immediately turn off the power and contact your original vendor or an authorized CASIO service provider. Continued use creates the danger of fire and electric shock.

Dropping and Damage

-  Should you drop the Handheld Printer Terminal and its options and damage them, immediately turn off the power and contact your original vendor or an authorized CASIO service provider. Continued use creates the danger of fire and electric shock.

Moisture

-  Though your Handheld Printer Terminal is water splash-resistant, its Bridge Satellite Cradle and other optional peripherals are not. Keep loose metal objects and containers filled with liquids away from your Handheld Printer Terminal and the optional peripherals.

Also, never connect or disconnect peripherals to the Handheld Printer Terminal while they are wet. Water getting into the Handheld Printer Terminal or its peripherals creates the danger of fire and electric shock.



Operation of Wireless Data Communication Function

Warning

Interference with the Operation of Other Equipment (Using Wireless Data Communication Function)

-  • Please follow the instructions provided by health care facilities when using your Handheld Printer Terminal in hospitals or other locations where medical equipment is in use. In particular, either switch off the wireless data communication function of the Handheld Printer Terminal or turn off the power in locations such as operating rooms, intensive care units, coronary artery disease monitoring units and other locations where use of the Handheld Printer Terminal is prohibited by the health care facility. Radio waves emitted by the Handheld Printer Terminal can affect the operation of medical equipment.
- Keep your Handheld Printer Terminal at least 22 centimeters (8⁵/₈") away from anyone wearing a pacemaker. Radio waves emitted by the Handheld Printer Terminal can affect the operation of a pacemaker.
- In order to protect someone wearing a pacemaker from the risk of unintentional interference, turn off the Handheld Printer Terminal before boarding a crowded train or entering any other crowded area.
- The use of wireless communication devices and electronic devices is prohibited by airlines depending on the flight status of the aircraft. Switch off the wireless data communication function of the Handheld Printer Terminal while onboard an aircraft. Use of the Handheld Printer Terminal can affect electronic devices used by the aircraft potentially causing a malfunction or accident.

Caution

Interference with the Operation of Other Equipment (Using Wireless Data Communication Function)

-  The Handheld Terminal contains a built-in wireless communication device of a low-power data communication system. The frequency band that is used is also used by microwave ovens and other industrial, scientific and medical devices, as well as other wireless stations of the same type, local wireless stations for identifying moving objects requiring licensing used on factory production lines and so forth, specified low-power wireless stations not requiring licensing, and amateur wireless stations (to be referred to as "other wireless stations").
- Confirm that other wireless stations are not in use nearby before using the Handheld Printer Terminal.
- In the case radio wave interference has been generated between the Handheld Printer Terminal and other wireless stations, either promptly change the location where the Handheld Printer Terminal is used or discontinue operation of the equipment causing the interference.
- If other problems should occur as a result of the generation of radio wave interference, please contact the location indicated in the section on product consultations.

2.4 FH 1

This wireless transmitter uses the 2.4 GHz band. It employs the FH-SS modulation system and has an interfering range of 10 m.

E-3





Safety Precautions

Caution

Foreign Objects



- Take care to ensure that metals or combustible objects are not inserted into the openings of the Handheld Printer Terminal and its options. Such objects inside of the Handheld Printer Terminal and its options create the danger of fire and electric shock.

Location



- Do not locate the Handheld Printer Terminal and its options on a surface that is unstable or uneven. Doing so creates the danger of the Handheld Printer Terminal falling, which can cause personal injury.
- Do not locate the Handheld Printer Terminal and its options in an area subject to large amounts of humidity or dust. Doing so creates the danger of fire and electric shock.
- Do not leave the Handheld Printer Terminal and its options for a long period in a car parked in direct sunlight.

Heavy Objects



- Never place heavy objects on top of the Handheld Printer Terminal and its options. Doing so creates the danger of loss of balance and the objects falling, which can cause personal injury.

LCD Screen



- Never apply strong pressure to the screen or subject it to strong impact. Doing so can crack the screen or LCD panel glass, which can cause the danger of personal injury.
- Should the LCD panel glass break, never touch the liquid inside. Doing so can cause skin inflammation.
 - Should liquid from the LCD panel accidentally get into your mouth, immediately wash your mouth with water and then consult a physician.
 - Should liquid from the LCD panel accidentally get into your eyes or onto your skin, immediately rinse for at least 15 minutes with clean tap water and then consult a physician.

Do Not Touch Internal Components



- Never touch any high-voltage components. This can cause an electric shock.

Printer





- Do not touch the areas around the printer motor or head since they can become very hot. Doing so can cause burns.
- Touching any of the gears while they are turning with unprotected hands can cause personal injury. Be careful not to come in contact with turning gears.
- Contact with the blade installed in the paper outlet can cause personal injury. Be careful not to touch the blade.

E-4



Lithium-ion Battery Pack

Danger



-  • Never allow the battery pack to become wet. Water can create the danger of battery pack heat emission, explosion, and fire.
- Never use or leave the battery pack next to open flame, near a stove, or any other area exposed to high heat. Doing so creates the danger of battery pack heat emission, explosion, and fire.
- Never use the battery pack with any device other than the Handheld Printer Terminal. Doing so can create the danger of battery pack heat emission, explosion, and fire.
- Note that the battery pack's positive (+) and negative (-) polarities must be oriented correctly when it is loaded into battery charger or the Handheld Printer Terminal. Connecting the battery pack with its polarities reversed creates the danger of battery pack fluid leakage, heat emission, explosion, and fire.
- Never dispose of the battery pack by incinerating it or otherwise expose it to heat. Doing so creates the danger of battery pack heat emission, explosion, and fire.
- Never allow the positive (+) and negative (-) terminals of the battery pack to become connected (shorted) by metal. Doing so creates the danger of battery pack heat emission, explosion, and fire.
- Never transport or store the battery pack together with a necklace, hair pins or other metal objects. Doing so can short battery pack terminals, creating the danger of battery pack heat emission, explosion, and fire. Be sure to place the battery pack in its case whenever transporting or storing it.
- Never throw the battery pack or otherwise subject it to strong impact. Doing so creates the danger of battery pack heat emission, explosion, and fire.
- Never pierce the battery pack with nails, hit it with a hammer, or step on it. Doing so can create the danger of battery pack heat emission, explosion, and fire.
- Never try to take apart the battery pack or modify it in any way. Doing so creates the danger of battery pack heat emission, explosion, and fire.
-  • Use only the specified battery charger to charge the battery pack. Use of other type of battery charger creates the danger of battery pack heat emission, explosion, and fire.

E-5





Safety Precautions

Warning

-  • Never place the battery pack in a microwave oven or any other high-voltage device. Doing so creates the danger of battery pack heat emission, explosion, and fire.
- Should the battery pack emit a strange odor or heat, change color or shape, or exhibit any other abnormal behavior, immediately stop using it. Continued use creates the danger of battery pack heat emission, explosion, and fire.
-  • If the battery pack does not achieve full charge after the normal charging time has passed, stop charging it. Continued charging creates the danger of battery pack heat emission, explosion, and fire.
- Should the battery pack start to leak or emit a strange odor, immediately move it away from any nearby flame. Leaking battery fluid is combustible, and exposure to flame creates the danger of explosion and fire.
- Should fluid from the battery pack accidentally get into your eyes, do not rub them. Immediately rinse your eyes with clean tap water and then consult a physician immediately.



Caution

-  • Never use or leave the battery pack in an area exposed to direct sunlight, in a car parked in direct sunlight, or any other very hot area. Doing so creates the danger of heat emission and fire, as well as deterioration of battery pack performance and shortening of its service life.
- Do not use the battery pack in areas where static electricity is being generated. Doing so creates the danger of battery pack heat emission, explosion, and fire.
-  • Danger of explosion if the battery pack is incorrectly replaced.
Replace only with same or equivalent type recommended by CASIO.
Dispose of used batteries according to the CASIO instruction.
- Should fluid from the battery pack accidentally get onto clothing or your skin, immediately rinse it off with clean tap water. Prolonged contact with battery pack fluid can cause skin irritation.
- Keep the battery pack out of the reach of small children. Do not let small children remove the battery pack from battery charger or the Handheld Printer Terminal.





AC Power Supply

Warning

-  Do not use the Handheld Printer Terminal at a voltage other than the specified voltage. Also, do not connect the Handheld Printer Terminal to a multi-plug power strip. Doing so creates the danger of fire and electric shock.
- Avoid conditions that can cause damage or breaks in the power cord. Do not place heavy objects on the power cord and keep it away from sources of heat. Any of these conditions can damage the power cord, creating the danger of fire and electric shock.
- Never modify, sharply bend, twist, or pull on the power cord. Doing so creates the danger of fire and electric shock.
-  When using the battery charger and Bridge Satellite Cradle, be sure to use the respective AC adaptors. Use of other AC adaptor model creates the danger of fire and electric shock.
- Should the power cord become severely damaged (to the point that wires are exposed or broken), contact your original vendor or an authorized CASIO service provider about repair or replacement. Use of a damaged electrical cord creates the danger of fire and electric shock.

Caution

-  Keep the power cord away from stoves and other sources of extreme heat. Heat can melt the covering of the power cord and create the danger of fire and electric shock.
-  Never pull on the power cord when unplugging it. Doing so can damage the cord and create the danger of fire and electric shock. (Always hold the plug when unplugging it from the wall outlet.)
- Never touch the plug while your hands are wet. Doing so can create the danger of electric shock.
-  Be sure to unplug the power cord from the wall outlet before moving. Failure to do so can result in damage to the power cord caused by pulling on it, which creates the danger of fire and electric shock.
- Be sure to unplug the power cord from the wall outlet before cleaning the battery charger and Bridge Satellite Cradle.
- Be sure to turn the power off and unplug the power cord after use.
- For safety reasons, unplug the power cord from the wall outlet when not using for a long period of time.



E-7



Safety Precautions

AC Adaptor

Caution

-  • The housing of the AC adaptor can become warm during normal use.
-  • Take normal precautions against electric shock.
-  • At least once a year, unplug the AC adaptor from the wall outlet and clean any dust that builds up between the prongs of the plug.
Dust built up between the prongs can lead to the danger of fire.

Backup Copies of All Important Data

Caution

-  • Note that CASIO Computer Co., Ltd. shall not be held liable to you or any third party for any damages or loss caused by deletion or corruption of data due to use of the Handheld Printer Terminal, malfunction or repair of the Handheld Printer Terminal or its peripherals, or due to the batteries going dead.
- The Handheld Printer Terminal employs electronic memory to store data, which means that memory contents can be corrupted or deleted if power is interrupted due to the batteries going dead or incorrect battery replacement procedures. Data cannot be recovered once it is lost or corrupted. Be sure to make backup copies of all important data.



Operating Precautions

Your Handheld Printer Terminal and its options are precision digital instruments. Improper operation or rough handling can cause problems with data storage and other problems. Note and observe the following precautions to ensure proper operation.

- **Do not continue operating the Handheld Printer Terminal when battery power is low.**

Doing so can cause data to be lost. When the battery goes low, charge it as soon as possible.

- **Do not leave dead batteries in the Handheld Printer Terminal for a long period.**

Dead batteries can leak, leading to malfunction and damage to the Handheld Printer Terminal.

- **Use the Handheld Printer Terminal and its options only within the specified temperature range.**

Use outside of the specified temperature range creates the risk of malfunction.

- **Avoid using the Handheld Printer Terminal and its options in areas subject to the following conditions.**

The following conditions create the risk of damage to the Handheld Printer Terminal.

- Large amounts of static electricity
- Extreme heat or extreme cold
- High humidity
- Sudden temperature extremes
- Large amounts of dust

- **Use only the special stylus that comes with the Handheld Printer Terminal to operate its touch screen and reset button.**

- **Do not use any tool other than the special stylus to operate the touch screen. Other tools can scratch the touch screen and lead to malfunction.**

- **Never use thinner, benzene, cosmetic cleaning fluids, or other volatile agents to clean the Handheld Printer Terminal.**

To clean the Handheld Printer Terminal, wipe it with a dry cloth, or a cloth moistened in a weak solution of water and a mild neutral detergent. Wring all excess moisture from the cloth before wiping.



■ Important

- The contents of this guide are subject to change without notice.
- Note that CASIO COMPUTER CO., LTD. shall not be held liable to you or any third parties for any losses or damages arising from the use of this guide.
- Although the utmost care has been taken in preparing this manual, please contact the manufacturer if you should happen to notice any inconsistencies or errors.
- This guide does not include any information about programming and download procedures. See the applicable separate documentation for information about the procedures.

Warranty and After Service

- Should this product ever malfunction, contact your original retailer providing information about the product name, the date you purchased it, and details about the problem.





GUIDELINES LAID DOWN BY FCC RULES FOR USE OF THIS UNIT IN THE U.S.A. (not applicable to other areas).

NOTICE

This equipment has been tested and found to comply with the limits for a Class B digital device, pursuant to Part 15 of the FCC Rules. These limits are designed to provide reasonable protection against harmful interference in a residential installation. This equipment generates, uses and can radiate radio frequency energy and, if not installed and used in accordance with the instructions, may cause harmful interference to radio communications. However, there is no guarantee that interference will not occur in a particular installation. If this equipment does cause harmful interference to radio or television reception, which can be determined by turning the equipment off and on, the user is encouraged to try to correct the interference by one or more of the following measures:

- Reorient or relocate the receiving antenna.
- Increase the separation between the equipment and receiver.
- Connect the equipment into an outlet on a circuit different from that to which the receiver is connected.
- Consult the dealer or an experienced radio/TV technician for help.

FCC WARNING

Changes or modifications not expressly approved by the party responsible for compliance could void the user's authority to operate the equipment.
Proper connectors must be used for connection to host computer and/or peripherals in order to meet FCC emission limits.

Peripherals and Cables

Battery Pack (DT-9723LI)
AC Adaptor (AD-S42120A, DT-9020ADP-U)
Barcode Reader (DT-9650BCR, DT-9657BCR)
Cables (DT-882RSC, DT-883RSC, DT887AXA, DT888RSC, DT-380USB, HA-B80AX)

Declaration of Conformity

Model Numbers: IT-3000M53E, IT-3000M54E, HA-B611O, HA-B30CHG
Trade Name: CASIO
Responsible party: CASIO, INC.
Address: 570 Mt. Pleasant Avenue, Dover, New Jersey 07801
Telephone number: 973-361-5400

This device complies with Part 15 of the FCC Rules. Operation is subject to the following two conditions:
(1) This device may not cause harmful interference, and (2) this device must accept any interference received, including interference that may cause undesired operation.

We, the undersigned.

Company	CASIO Europe GmbH
Address, City	Bornbarch 10, D-22848 Norderstedt
Country	Germany
Phone number	+49(0)40-528-65-0
Fax number	+49(0)40-528-65-424





Important

certify and declare under our sole responsibility that the following equipments:

Product description / Intended use	
EU/EFTA member states intended for use	EU: Austria, Belgium, Denmark, Finland, France, Germany, Greece, Ireland, Italy, Luxembourg, The Netherlands, Portugal, Spain, Sweden, United Kingdom EFTA: Switzerland, Iceland, Lichtenstein, Norway
Member states with restrictive use	NONE
Manufacturer	CASIO COMPUTER CO., LTD.
Brand	CASIO
Type	IT-3000M53E, IT-3000M54E

are tested and found to conform with the essential requirements for protection of health and the safety of the user and any other persons and Electromagnetic Compatibility, as included in following standards:

Standard	Issue date
EN60950	1992
A1,	1993
A2,	1993
A3,	1995
A4,	1997
A11,	1997
EN301 489-1,	2001-09
EN301 489-17	2000

and are tested and found to conform with the essential radio test suites so that they effectively use the frequency spectrum allocated to terrestrial/space radio communication and orbital resources so to as to avoid harmful interference, as included in following standards:

Standard	Issue date
EN300-328-1	2000-07
EN300-328-2	2001-12

and therefore comply with the essential requirements and provisions of the **Directive 1999/5/EC** of the European Parliament and of the council of March 9, 1999 on Radio equipment and Telecommunications Terminal Equipment and the mutual recognition of their conformity and with the provisions of Annex III (Conformity Assessment procedure referred to in article 10).

The technical documentation as required by the Conformity Assessment procedure is kept at the following address:

Company	CASIO Europe GmbH
Address, City	Bornbarch 10, D-22848 Norderstedt
Country	Germany
Phone number	+49(0)40-528-65-0
Fax number	+49(0)40-528-65-424

Products are for distribution within all member states of the EU.



France limited to 2446.5-2483.5 Mhz Indoor use.

Belgium limited to 2400-2483.5 Mhz Indoor, 2460-2483.5 Mhz Outdoor use.

The Netherlands limited to 2400-2483.5 Mhz Indoor use with no license, 2451-2471.0 Mhz Outdoor use with license.

The information described above dates from January 2004 and may be subjected to future changes.

E-12





Contents

Safety Precautions	E-1
Operating Precautions	E-9
Important	E-10
Warranty and After Service	E-10
Before Getting Started	E-15
Handheld Printer Terminal System Configuration	E-18
Options	E-18
General Guide	E-22
IT-3000M53E	E-22
IT-3000M54E	E-22
Key Functions	E-25
Replacing the Battery	E-26
Replacing the Battery Pack	E-26
Attaching the Hand Strap	E-29
Attaching the Neck Strap	E-30
Attaching the Stylus Holder	E-31
Configuring Handheld Printer Terminal Settings	E-33
Calibrating Touch Screen Alignment	E-33
Adjusting Display Contrast	E-34
Adjusting Display Brightness	E-34
Display Auto Dimmer	E-34
Using the Printer	E-35
When Using Roll Paper	E-35
When Using Single Sheet Paper	E-38
Precautions When Using Printer	E-42
Magnetic Card Reader (IT-3000M54E only)	E-44
Performing Data Communication	E-45
IR Data Communication	E-45
PC Communication	E-45
Bluetooth™ Communication	E-46
Resetting the Handheld Printer Terminal	E-47
Performing a Full Reset (Initialization)	E-48
IT-3000 Specifications	E-49
Using the Bridge Satellite Cradle (HA-B61IO)	E-51
General Guide	E-51
Connecting the AC Adaptor and Connecting to Computer	E-53
Configuring DIP Switch Settings	E-55
Connecting Multiple Bridge Satellite Cradles (HA-B61IO)	E-56
Bridge Satellite Cradle (HA-B61IO) Specifications	E-57





Contents

Using the Cradle-type Battery Charger (HA-B30CHG)	E-58
General Guide	E-58
Connecting the AC Adaptor for Cradle-type Battery Charger	E-60
Cradle-type Battery Charger (HA-B30CHG) Specifications	E-61
Using the AC Adaptor (DT-9020ADP)	E-62
AC Adaptor (DT-9020ADP) Specifications	E-62
Using PC Cards	E-63
Attachment of PC Card Removal Tape	E-63
Inserting a PC Card	E-63
Using SD Memory Cards	E-66
Inserting an SD Memory Card	E-66
Removing an SD Memory Card	E-67
Handling Bar-Code Reader	E-68
Connecting the bar-code reader	E-68
Using a bar-code reader	E-69
Bar Code Reader Specifications	E-72
Attaching the Screen Protect Cover	E-73
Attaching the Splash Protect Cover (IT-3000 only)	E-74
Using the Battery Pack	E-76
Battery Pack Specifications	E-76



Before Getting Started

Be sure to perform the following steps before trying to use the Handheld Printer Terminal for the first time.

1. When unpacking, make sure that everything is included.

Open the box and make sure that all the items shown here are included.

Handheld Printer Terminal



Stylus



Neck strap and stylus holder

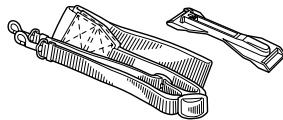

Hand strap

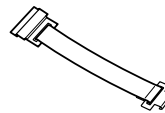

Battery pack

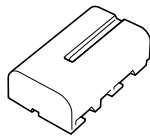

Roll paper

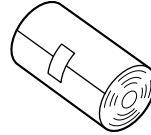

PC card fixers

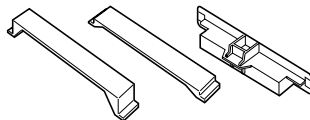

Paper adjuster



PC Card Remover (2 pcs)

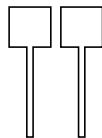

User's Guide (this manual)

2. Charge the battery pack.

Charge the battery pack (DT-9723LI). Use the Cradle-type Battery Charger or Bridge Satellite Cradle to charge the battery pack. When charging with the Cradle-type Battery Charger, first install the battery pack in the Handheld Printer Terminal.

For information using these options for charging, see pages 60, and 53.



Before Getting Started

3. Load the battery pack into the Handheld Printer Terminal.

- ① Slide the battery pack lock switch on the side of the Handheld Printer Terminal to the “FREE” position.

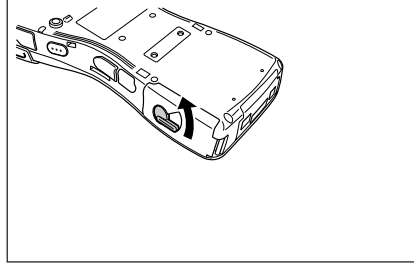

- ② Open the battery pack cover.

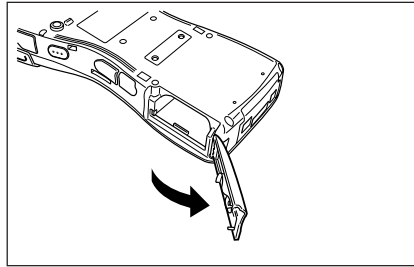

- ③ Install the battery pack (DT-9723LI). Make sure the battery pack is aligned correctly when you install it.

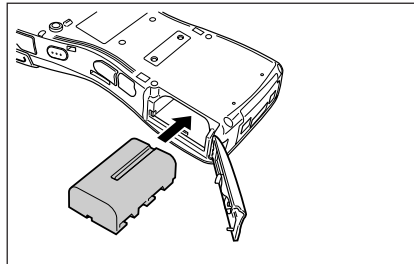

- ④ Return the battery pack cover to its original position as shown in the illustration, and then slide the battery pack lock switch to the “LOCK” position.

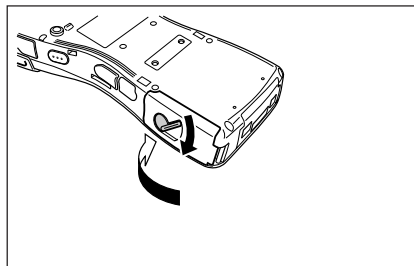



4. Hold down the power key for about one second to turn on the power. Start up the application you want to run.

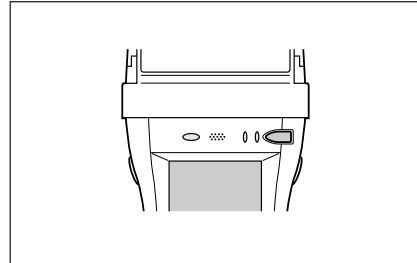



Handheld Printer Terminal System Configuration

IT-3000 Series

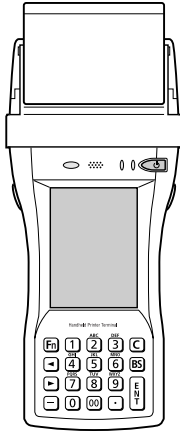

Laser Scanner models

Options

Bridge Satellite Cradle

HA-B61IO

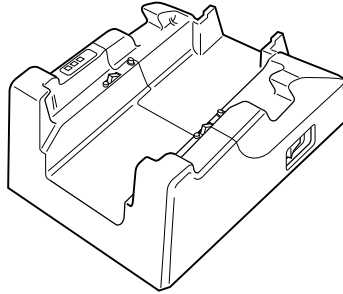

Cradle-type Battery Charger

HA-B30CHG

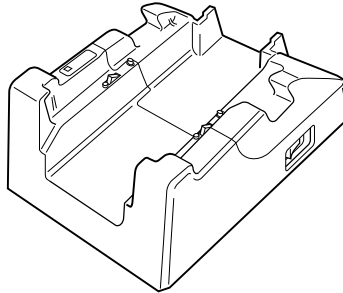

Bridge Satellite Cradle/Required AC Adaptor

AD-S42120A

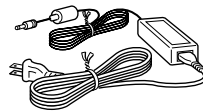



Battery Pack

DT-B9723LI

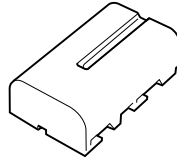

Paper Holder

HA-B93PH

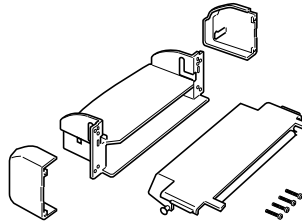

Splash Protect Cover (for IT-3000M33)

HA-B92PCV

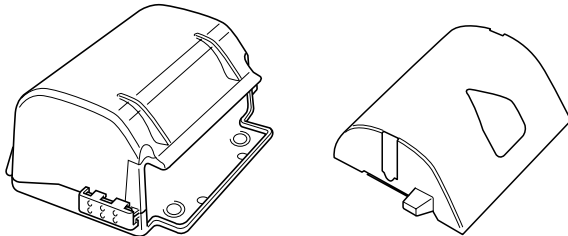

Screen Protect Cover

HA-B90DCV

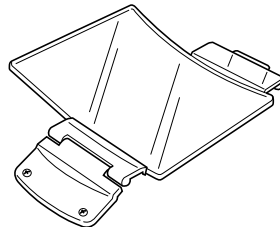

E-19



Handheld Priter Terminal System Configuration

Battery Charger

DT-9020ADP-G
DT-9020ADP-U

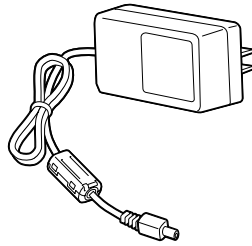

Barcode Reader

DT-9650BCR

DT9656BCR

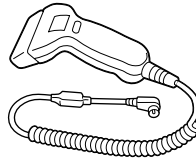
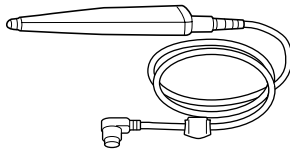



Cables

DT-882RSC	RS-232C Cross Cable for Connecting Bridge Satellite Cradle and PC
DT-883RSC	RS-232C Cross Cable for Connecting Bridge Satellite Cradle and PC
DT-887AXA	Dsub 9-Pin (Female) RS-232C Cross Cable for Bridge Satellite Cradle
DT-888RSC	RS-422 Modular Cable for Connecting Bridge Satellite Cradle
DT-380USB	USB Cable for Connecting Bridge Satellite Cradle and PC

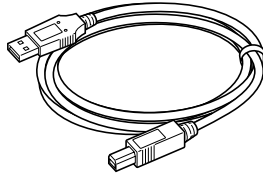

HA-B80AX	RS-232 Cross Cable for Connecting Handheld Printer Terminal and PC
----------	--

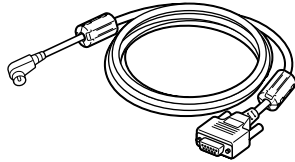



General Guide

IT-3000M53E

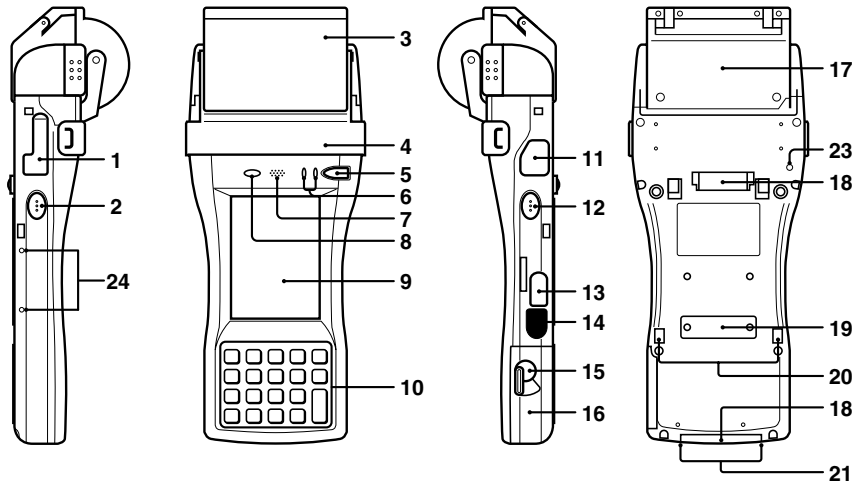

IT-3000M54E

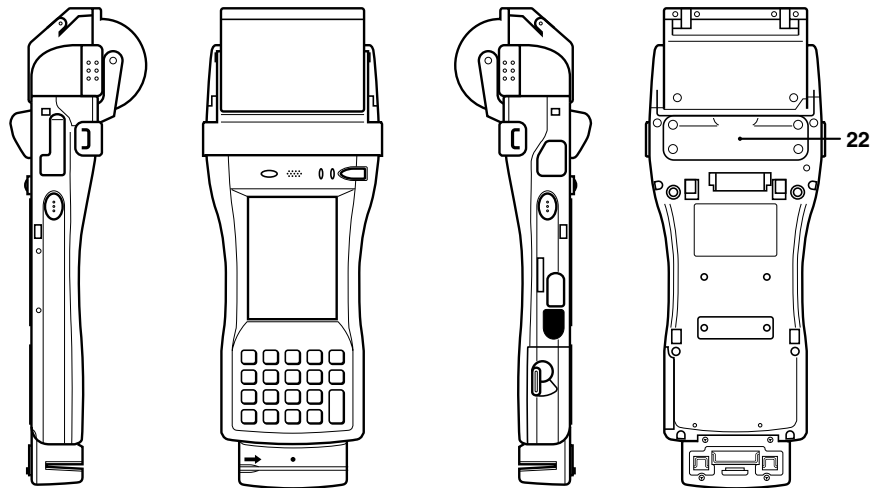

E-22



1	SD Memory Card Slot	Slot for inserting SD memory card.
2	Programmable Key (L)	This key can be assigned any function available.
3	Roll Paper Holder	Roll paper is placed on this holder. Use the optional Paper Holder when using single sheet paper.
4	Paper Outlet and Paper Outlet Cover	Printed roll paper is torn off here. The outlet is provided with a splash protect cover. Open the cover when printing. The paper outlet is revealed when the cover is opened.
5	Power Key	Press this key to turn the power on or off.
6	Indicator 1 (Left Side)	This indicator is green when charging is completed and red during charging.
	Indicator 2 (Right Side)	This indicator flashes or lights according to the settings of the application software.
7	Speaker	Generates audio and buzzer tones.
8	Brightness Sensor	This sensor detects the surrounding level of illumination. The display backlight and key backlight can be controlled according to programmed settings. Be careful not to inadvertently block this sensor.
9	LCD Panel/Touch Screen	Displays text, operations, indicators and so forth. In addition, operations can be performed and text can be input using the stylus provided.
10	Stroke Keys	There are a total of 19 keys including function keys and numeric keys. Refer to "Key Functions" on p. 25 for further details (illumination function provided).
11	RS-232C Interface Connector	For connection of a barcode reader and so forth. Connect by opening the connector cover.
12	Programmable Key (R)	This key can be assigned any function available
13	Charging Jack	A battery charger is connected to this jack when charging the lithium ion battery pack. Open the jack cover to connect the battery charger.
14	IR Port	This is used for IR data communication with another Handheld Printer Terminal or with the Bridge Satellite Cradle.
15	Battery Pack Cover Lock Switch	Rotate this switch when opening and closing the battery pack cover.

E-23



General Guide

16	Battery Pack Cover	Houses the battery pack inside.
17	PC Card Slot	For connection of a separately sold PC card. Remove the cover to install a PC card.
18	Hand Strap Bar	Connect the hand strap here.
19	14-pin Serial Interface Connector	Provided for future use.
20	Power Contacts	Contact points for supplying power from the Bridge Satellite Cradle and Cradle-type Battery Charger.
21	Neck Strap Bar	Connect the neck strap here.
22	Magnetic Card Reader (IT-3000M54E only)	Magnetic cards are read by passing through this location.
23	Reset Switch	Press to reset the Handheld Printer Terminal. Be careful not to press by mistake.
24	Screen Protect Cover Mounting	Remove the screws when attaching the Screen Protect Cover.



Key Functions

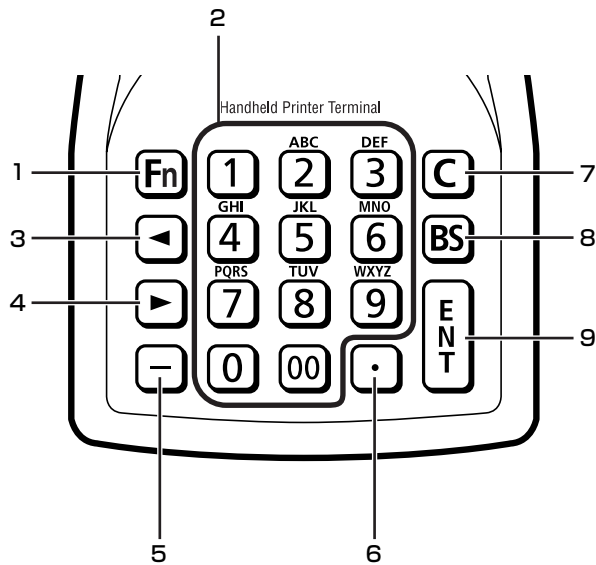

1	F ⁿ Key	This key is used to switch the character input mode or make various settings in combination with other keys, or start up a pre-registered application.
2	Numeric Keys	These keys are used to input numbers and letters.
3	◀ (Cursor Key)	Moves the cursor to the left.
4	▶ (Cursor Key)	Moves the cursor to the right. This is also used to feed paper when pressed after pressing the Fn key when printing paper is installed.
5	-	This key is press when inputting a hyphen or bar.
6	.	This key is pressed when inputting a period.
7	C	This key is pressed when canceling an operation.
8	BS	This key is pressed when deleting the character to the left of the cursor.
9	ENT	This key is pressed when entering an input.

* Illumination function available.

E-25





■ Replacing the Battery

Your Handheld Printer Terminal uses two types of battery: a battery pack and a memory backup battery.

A battery pack (DT-9723LI) is used for the main battery. A backup battery is housed inside the Handheld Printer Terminal.

This guide uses the following terms to refer to the batteries.

Battery Pack: Rechargeable battery pack for normal operations and data storage

Backup Battery: Built-in battery for memory backup

When the battery pack power goes low, immediately charge it or replace it with a charged battery pack.

You can use the Cradle-type Battery Charger, or the Bridge Satellite Cradle to charge a battery pack. See the sections of this guide that cover the Cradle-type Battery Charger, and the Bridge Satellite Cradle for information about how to use them for charging.

Replacing the Battery Pack

Important!

Always keep backup copies of all important data!

- The main battery powers normal operation and also provides power required to maintain memory contents, while the backup battery provides backup power to maintain memory contents. Because of this, you should not remove the main battery while the backup battery is dead. Removing the battery pack while the backup battery is dead causes data in the memory to be corrupted or lost. Note that once data is lost it cannot be recovered. Always keep separate backup copies of all important data.
- The charge of a battery pack when you purchase it may be depleted due to testing at the factory or natural discharge during shipment and storage. Be sure to charge the battery pack before you use it.
- The life of a battery pack is limited, and charging a battery pack causes it to gradually lose its ability to maintain the charge. If your battery pack seems to require charging very frequently, it probably means it is time to purchase a new one.
- A fully charged backup battery can maintain memory (RAM) contents for about 10 minutes, even when the main battery is removed.
- The backup battery achieves a full charge in about four days when the battery pack is loaded.



To replace the battery pack

1. Make sure that the Handheld Printer Terminal is turned off.
If the power is on, press the power key to turn it off.

2. Slide the battery cover lock switch on the side of the Handheld Printer Terminal to the "FREE" position.

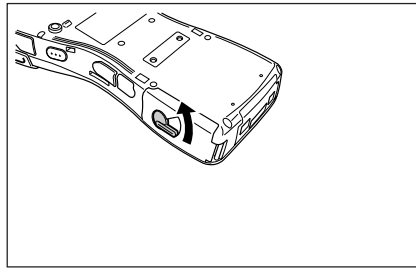

3. Open the battery pack cover.

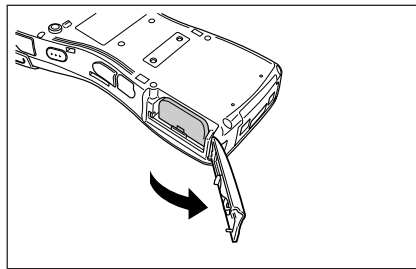

4. Remove the battery pack.

- ① Press the battery pack eject button.

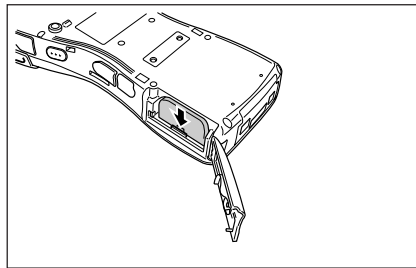

- ② Pull out the battery pack after it has been ejected.

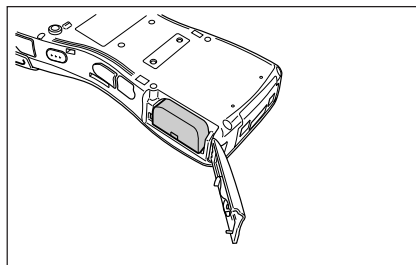

E-27



Replacing the Battery

5. Taking care to ensure it is oriented correctly, load a new battery pack into the Handheld Printer Terminal.

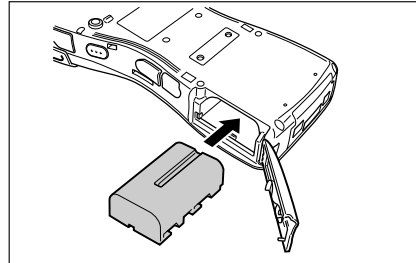

6. Return the battery pack cover to its original position as shown in the illustration, and then slide the battery pack lock switch to the "LOCK" position.

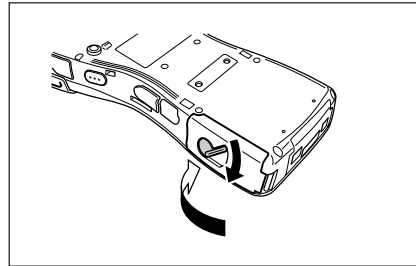

Important!

- **When replacing the battery pack, make sure you do not leave the Handheld Printer Terminal without a battery pack for more than about 10 minutes. Doing so can cause data in the memory to be deleted.**
- **Never try to use other type of battery than the one that is specified for this product.**



■ Attaching the Hand Strap —

A flexible hand strap can be attached to the Handheld Printer Terminal.

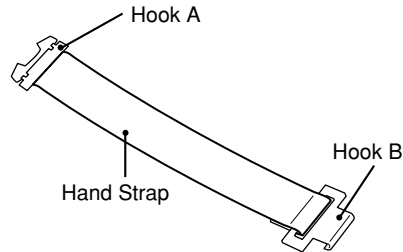

Attach the hand strap following procedure described below.

1. Attach Hook B of the hand strap to the hand strap bar located on the bottom of the Handheld Printer Terminal.

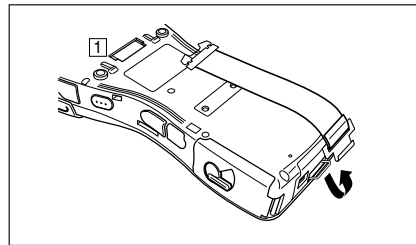

2. Pull on the hand strap in the direction shown in the illustration, and then fasten Hook A onto tab (1) on the back of the Handheld Printer Terminal.

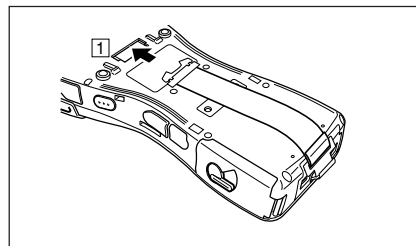

3. Fasten the wire of Hook A by inserting into the indentation in the Handheld Printer Terminal.

- Pull up on the center of the wire when unfastening.

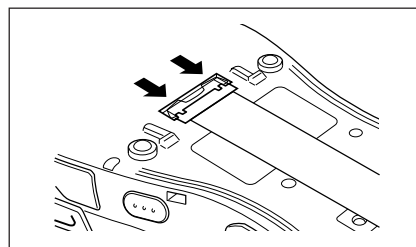



■ Attaching the Neck Strap

A neck strap can be attached to the Handheld Printer Terminal to keep it from being dropped while being carried. The stylus holder provided can also be attached.

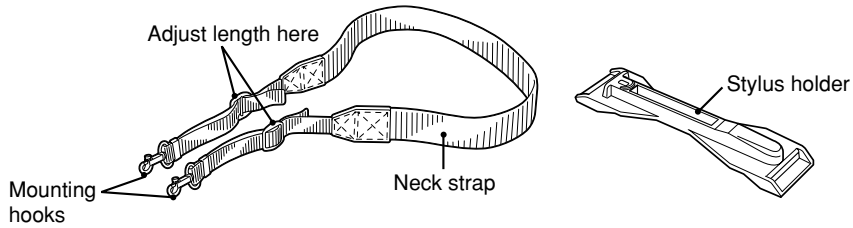

Attach the neck strap following the procedure described below.

Attachment Procedure

Pull out the neck strap mounting bars on the bottom of the Handheld Printer Terminal using the stylus (pen), pull back the levers of the neck strap mounting hooks and insert the hooks onto the mounting bars.

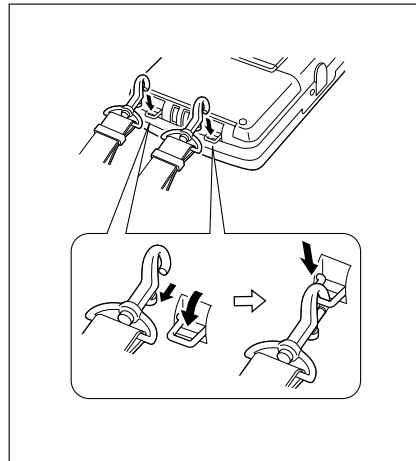

Removal Procedure

Pull back the levers of the neck strap mounting hooks to release them from the mounting bars. After removing the mounting hooks, push down the neck strap mounting bars on the Handheld Printer Terminal.

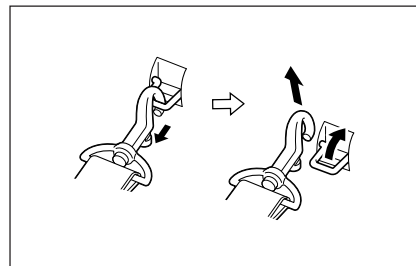



Attaching the Stylus Holder

The stylus holder provided can be attached to the neck strap as necessary. When attaching the stylus holder, first remove the neck strap from the Handheld Printer Terminal. In addition, remove the stylus from the stylus holder.

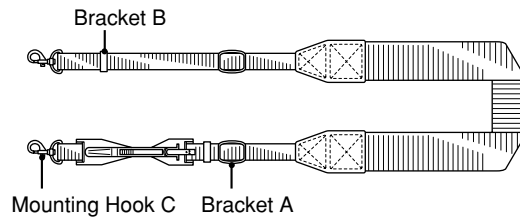

Attach the stylus holder following the procedure described below.

1. Remove the end of the strap from Bracket A and Bracket B.

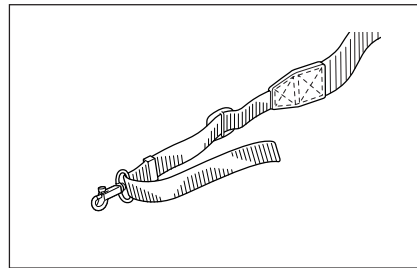

2. Remove Mounting Hook C.

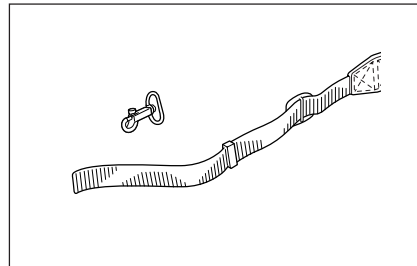

3. Pass the stylus holder through the strap as shown in the illustration.

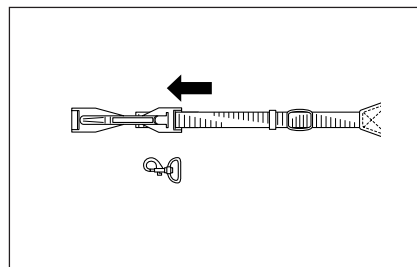

E-31



Attaching the Neck Strap

4. Fold back the strap after passing through Bracket C, and then fasten in the same way it was originally fastened with Bracket A and Bracket B.

- Do not pass the strap through the stylus holder when folding it back.

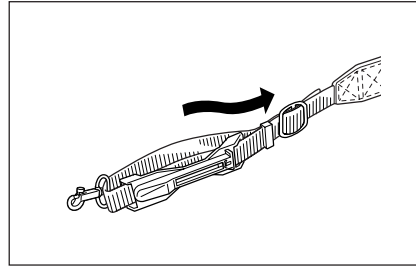

- Place the stylus in the stylus holder after first re-attaching the neck strap to the Handheld Printer Terminal.

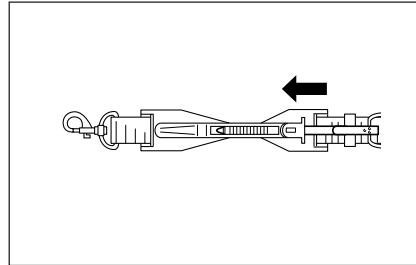

Important!

- Do not swing the Handheld Printer Terminal with the neck strap.



■ Configuring Handheld Printer Terminal Settings —

Calibrating Touch Screen Alignment

Whenever you feel that touch screen response is poor or that the operations being executed do not match the location you are tapping on the touch screen, perform either of the following operations to calibrate the alignment of the touch screen.

- Press the “Fn” key and then press the “4” key after confirming that “F” is displayed in the lower right corner of the screen.
- * The following screen can also be displayed by consecutively tapping “Stylus” on the control panel.

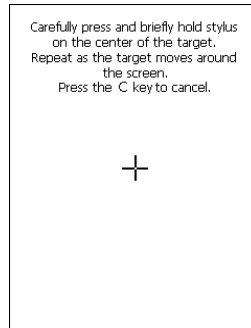

- Press the stylus against the center of the target mark (+ mark) as indicated on the screen. The screen shown below appears after you press stylus against the target at five different locations.

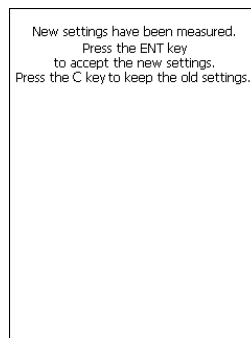

- Press the Execute key or tap anywhere on the touch screen.





Configuring Handheld Printer Terminal Settings

Adjusting Display Contrast

Perform the following steps to adjust display contrast to make display colors more vivid and easier to see.

- Press the “Fn” key and then press the “2” key or “3” key after confirming that “F” is displayed in the lower right corner of the screen. Pressing the “2” key adjusts for more contrast, while pressing the “3” key adjusts for less contrast.
- * In order to continue to make adjustments, press the “2” key or “3” key after again first pressing the “Fn” key.
- * Contrast settings can also be made by consecutively tapping “Brightness” on the control panel.

Adjusting Display Brightness

You can use the following procedure to adjust screen brightness to make it easier to read under different lighting conditions.

- Press the “Fn” key and then press the “5” key or “6” key after confirming that “F” is displayed in the lower right corner of the screen. Pressing the “5” key adjusts brightness for a darker display, while pressing the “6” key adjusts brightness for a brighter display.
- * In order to continue to make adjustments, press the “5” key or “6” key after again first pressing the “Fn” key.
- * Brightness settings can also be made by consecutively tapping “Brightness” on the control panel.

Important!

- **If you use your Handheld Printer Terminal in a location where it is hot, it automatically dims the screen to protect against damage.**

Display Auto Dimmer

The display auto dimmer automatically lowers display brightness if you do not perform any operation for a specific amount of time. This helps to conserve battery power. You can use the following procedure to specify the amount of time should be allowed to pass before auto dimming is performed.

- Select “Control Panel” on the “Settings” menu after tapping the “Start” button in the lower left corner of the screen. Next, consecutively tap the “Brightness” icon and then tap “Backlight” to set the displayed parameters.



Using the Printer

The printer of the IT-3000 can print on roll paper (80 mm or 58 mm wide) and 80 mm wide single sheet paper. When printing on single sheet paper, use the paper holder sold separately.

When Using Roll Paper

Installing the Roll Paper

1. Check that the power is off. If the power is on, always make sure to turn it off by pressing the power key.

2. Press the ridged (0000) portions (1) of the paper outlet cover while spreading apart the locks on the left and right sides (2) to disengage them as shown in the illustration followed by opening the paper outlet cover (3).

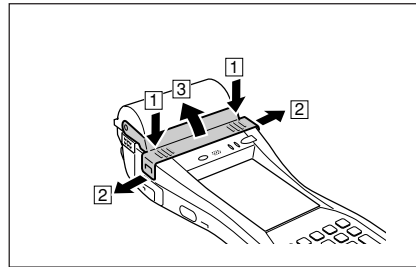

3. Slide the lock switches on the left and right sides of the roll paper holder as shown in the illustration to align at the FREE position (1), and then push up the ridged (0000) portion (2) to open.

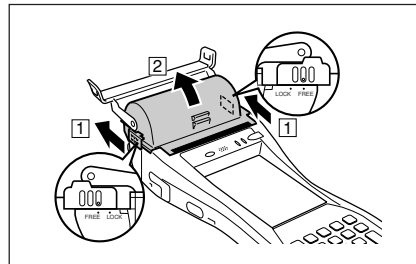

4. Peel off the seal from the roll paper and install as shown in the illustration.

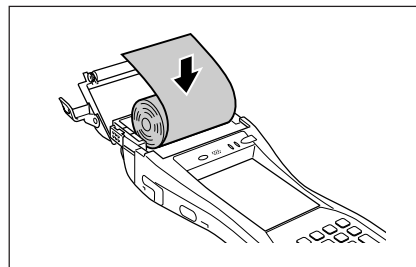



Using the Printer

5. Close the roll paper holder, slide the lock switches on the left and right sides as shown in the illustration to align at the “LOCK” position to lock the roll paper holder in position, and then tear off the protruding roll paper.

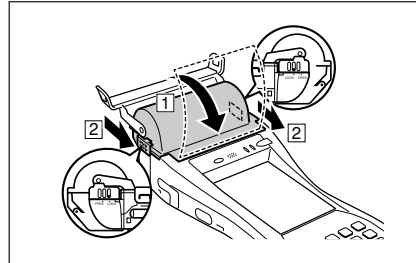

6. Close the paper outlet cover as necessary.
- Open the paper outlet cover when printing.
 - Close the paper outlet cover when using outdoors in the rain and so forth.

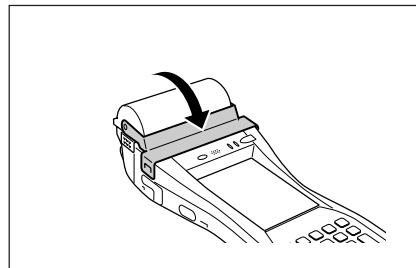

Important!

- **Always print with the roll paper properly installed. Printing without properly installing roll paper can damage the printer.**
- **If the roll paper should happen to become jammed in the printer, open the roll paper holder by following the procedure described in steps 1 and 2 of the procedure for “Installing the Roll Paper”, and then remove the jammed paper. Be careful not to touch the printer at this time since it may have become hot during the course of printing.**
- **The printer is not protected against splashing water when the paper outlet cover is closed with roll paper present in the outlet.**
- **Remove the paper outlet cover when not in use and store it in a safe location.**
- **If the end of the roll paper has become curled making it difficult to install the paper, first flatten out the paper by bending it back in the opposite direction before installing.**



Attaching the 58 mm Paper Width Adjuster

Attach the 58 mm Paper Width Adjuster inside the roll paper holder when using 58 mm wide roll paper. Refer to the procedure described in “Installing the Roll Paper” for information on opening and closing the roll paper holder.

1. Press the attachments of the 58 mm Paper Width Adjuster from the left and right sides as shown in the illustration.

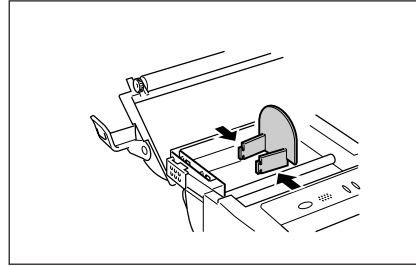

2. Insert the attachment of the 58 mm Paper Width Adjuster into the mounting holes inside the left side of the roll paper holder to lock in position.

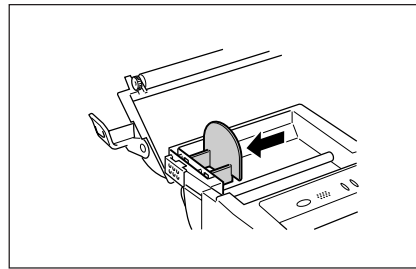

Important!

- Always make sure to attach the 58 mm Paper Width Adjuster when using 58 mm wide roll paper. Failure to attach the 58 mm Paper Width Adjuster may cause the paper to jam or the printer to malfunction.
- 58 mm wide roll paper can only be used when the installed application is for use with 58 mm wide paper only.



When Using Single Sheet Paper

Attaching the Paper Holder

Attach the separately sold Paper Holder when printing on single sheet paper. The Paper Holder is composed of four parts and four screws.

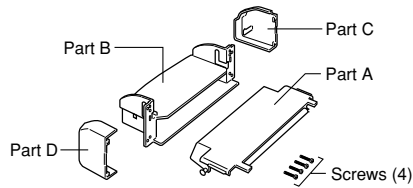

1. Check that the power is off. If the power is on, always make sure to turn it off by pressing the power key.

2. Press the ridged (0000) portions (1) of the paper outlet cover while spreading apart the left and right locks (2) to disengage as shown in the illustration, and then open the paper outlet cover (3).

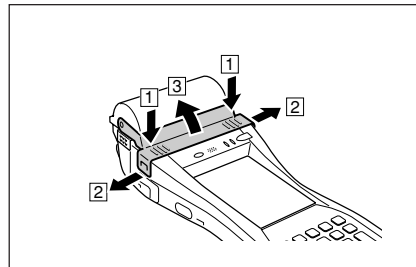

3. Slide the lock switches on the left and right sides of the roll paper holder (1), and then push up on the ridged (000) portion (2) to open.

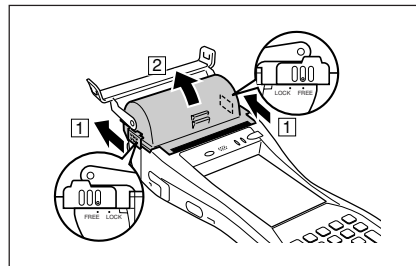

4. Turn over the Handheld Printer Terminal.





5. Loosen the two screws shown in the illustration (the screws cannot be removed).

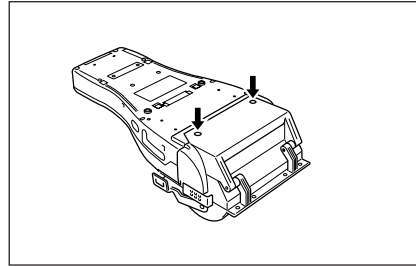

6. Open the cover (PC card slot cover) as shown in the illustration.

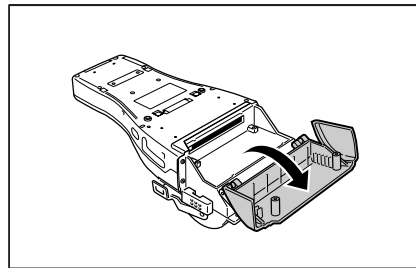

7. Loosen and remove the four screws shown in the illustration. Store the removed screws in a safe place so that they do not become lost.

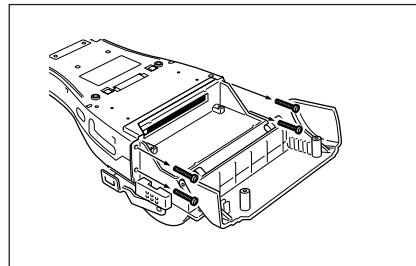

8. Turn the Handheld Printer Terminal back over.

9. Remove the entire roll paper holder.

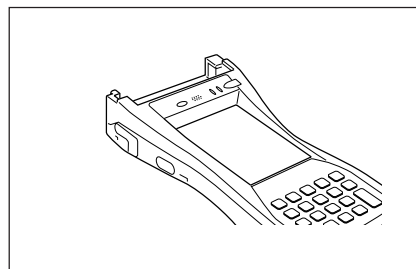



Using the Printer

10. Fasten Part A of the Paper Holder to the Handheld Printer Terminal.

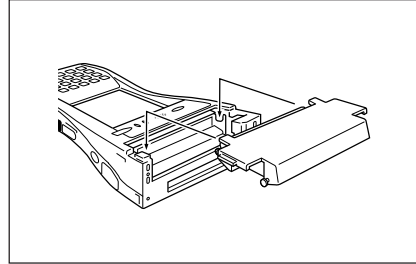

11. Insert the projections on both sides of Part A with the grooves of Part B and fasten to the Handheld Printer Terminal with the four screws.

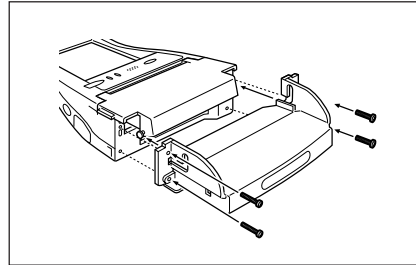

12. Press on Part C and Part D to the left and right sides.

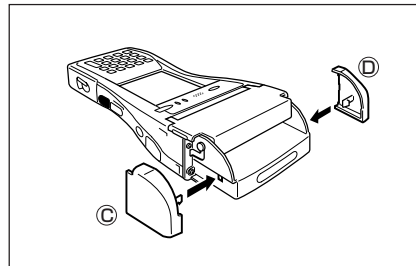



Installing Single Sheet Paper

Enable the Auto Loading function by selecting Start, Settings, Control Panel and then “Printer Control” of Printer Settings in that order before installing the single sheet paper.

1. Insert the single sheet paper all the way into the printer until it stops with the side to be printed facing downward. The paper will be fed into the printer automatically and be positioned at the printing position.

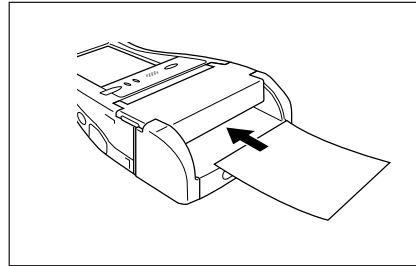

- If the single sheet paper becomes jammed, open the top cover of the Paper Holder (Part A) and remove the jammed paper.

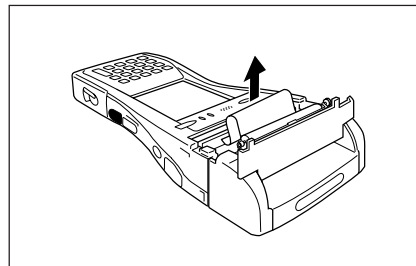

Important!

- Always make sure to install single sheet paper in the printer before printing. Printing without installing paper can cause the printer to malfunction.
- Do not touch the printer since it can become very hot.



Precautions When Using Printer

Precautions Regarding Printing Accuracy

1. During high-duty printing such as when printing horizontal lines or when printing when the battery level is low, the printing speed may slow down and a level difference of one dot or more may occur to prevent excess current consumption.
2. Line changing errors may occur if the printing interval in line units is about 1 second or more. In the case of previously printed single sheet paper, either use a larger frame or set the printer to print continuously to prevent line changing errors.
3. Since printing may be paused if the battery pack voltage decreases, alignment errors or double-printed characters may occur when printing is later resumed.
4. Printing may be illegible immediately after the roll paper cover has been opened and paper has been installed. This can be prevented by using the program to feed the paper before starting printing.
5. The printer will not print unless the paper is installed properly. Always make sure to properly install the paper before starting printing.
6. Only use the recommended printer paper. Use of paper other than the recommended printer paper can reduce printing quality, shorten printer service life or have other detrimental effects that have the risk of impairing printer characteristics.
7. Observe the following when storing printer paper.
 - Do not store paper in locations subject to high temperature and high humidity since spontaneous coloring of the paper occurs at temperatures of 60°C and above.
 - Store paper in a cool location while avoiding excessive exposure to direct sunlight.
 - Please note that plastic films containing plasticizers, ester-based erasers, tape and glue can cause discoloration, while contact with organic solvents, diazo copy paper or scratching with the fingernail, etc. can cause the paper to become colored.



Other Precautions

1. The working temperature range in the case of 2P-size and label printing is 5-35°C.
2. Once the colored end mark of the paper appears, promptly replace with new paper.
3. **Recommended paper:** Use paper specified by the manufacturer for printing.
4. Paper scraps may accumulate and printing quality may decrease when the printer has been used for a long period of time. The thermal head must be cleaned when this happens. Contact your nearest Casio Techno Service Station to have cleaning performed.
5. Printing quality may decrease when the working temperature becomes excessively low.
6. When printing at width of 58 mm, you cannot return to printing at 80 mm.
7. Install printer paper in the printer when not using for a long period of time to prevent damage to printer components.

Important!

- Do not touch the thermal head during or immediately after printing.





Magnetic Card Reader (IT-3000M54E only)

Only use cards that are compatible with JIS II/ISO standards. The procedure for reading cards is described below.

1. Insert the card all the way into the reader as shown in the illustration, and steadily pass the card through the reader in the direction of the arrow.

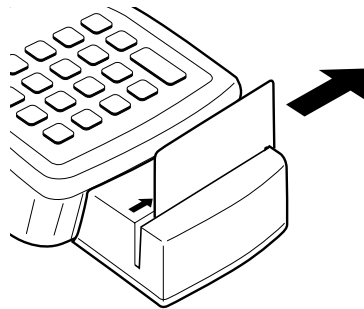

Precautions During Use

- Cards may not be able to be read if they are passed through the reader too rapidly.
- A reading error may occur if the speed at which the card is passed through the reader changes suddenly.
- Do not allow magnets to come in close proximity to the reader since magnets can cause difficulty in reading the data. In addition, do not stack magnetic cards on top of each other.
- Cards that have been excessively misshaped or bent may not be able to be read.
- Soiling of the magnetic strip may make it difficult to read the card. If a card has become soiled, wipe with a clean, soft cloth.
- Regularly clean the magnetic card reader by passing a cleaning card through the reader to prevent excessive friction with cards. When using in a location where there are low levels of dust, clean once a week and about once every 500 passes through the card reader.



■ Performing Data Communication —

IR Data Communication

IR data communication can be used to transfer data between two Handheld Printer Terminals.

When performing IR data communication, orient the IR ports of both Handheld Printer Terminals so they are pointing directly at each other.

Data communication is possible within a distance of 0 (in direct contact) to 1 m (max. 20 cm at 4 Mbps).

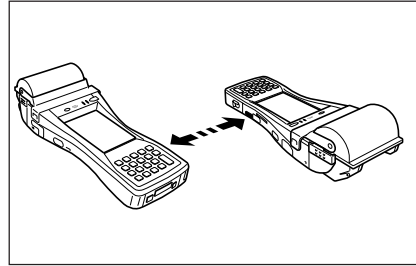

Important!

- A high-sensitivity communication element is used during IR data communication.
- In order to ensure successful communication, avoid using cellular phones or other devices that emit radio wave in the area where you are performing IR data communication.
- If you need to use such a device, move away from the communicating Handheld Printer Terminals. In case of a cellular phone, keep it at least 30cm (11 $\frac{3}{8}$ ") away.

PC Communication

You also transfer data directly between the Handheld Printer Terminal and your computer. With the power turned off, open the connector cover (1) and connect the RS-232C interface connector on the right side of the Handheld Printer Terminal (2) with your computer using the RS-232C Cross Cable (HA-B80AX).

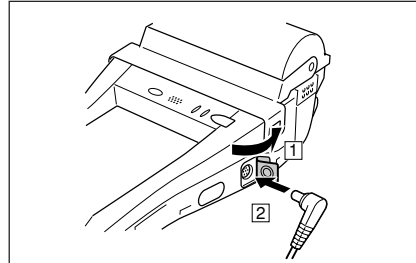



Performing Data Communication

Bluetooth™ Communication

Bluetooth™ protocol can also be used to transfer data between two Handheld Printer Terminals.

The two Handheld Printer Terminals should be no more than five meters apart (as long as there is nothing blocking the path between).

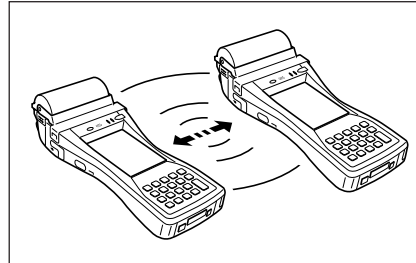

Important!

Observe the following precautions to help ensure that data communication is successful.

- **Make sure the Bluetooth™ devices are located within five meters (9'10³/₈") of each other. Surroundings (obstacles) may require a shorter distance between the two devices.**
- **Make sure there is at least two meters (6' 7") between this device and other devices (electrical appliances, audio-visual equipment, OA equipment, and digital cordless telephones, facsimile machines, etc.). (Take special care with microwave ovens. Allow at least three meters (9' 10³/₈") between communicating devices and a microwave oven.) When approaching such a device when its power is turned on, proper data communication may prove impossible while this may also cause interference with TV and radio reception (images produced by certain UHF and broadcast satellite channels may become blurry).**
- **Normal data communication may not be possible in an area near a broadcast transmitter or wireless transmitter. If this happens, move to a different location. Normal data communication may not be possible in areas exposed to strong radio waves.**
- **Wireless LAN Interference**

Because Bluetooth™ and Wireless LAN use the same frequency band (2.4GHz), radio interference can occur if there is a Wireless LAN device nearby. This can result in lower data communication speeds, or even make it impossible to establish a connection. If this happens, try the following countermeasures.

- **Move at least 10 meters (32'10³/₄") away from the Wireless LAN device.**
- **If you cannot keep the distance at least 10 meters (32'10³/₄") or more between the Handheld Printer Terminal and a Wireless LAN device, turn off the power of either the Handheld Printer Terminal or the Wireless LAN device.**





Resetting the Handheld Printer Terminal

Resetting the Handheld Printer Terminal is the same as restarting a computer. Performing a reset causes all unsaved inputs and edits to be lost, but data that is already stored in the memory as well as all settings should be unaffected. Use reset to restore normal operation whenever the Handheld Printer Terminal operates abnormally due to misoperation or some other reason.

Use the stylus to press the reset switch on the back of the Handheld Printer Terminal. This starts the reset operation.

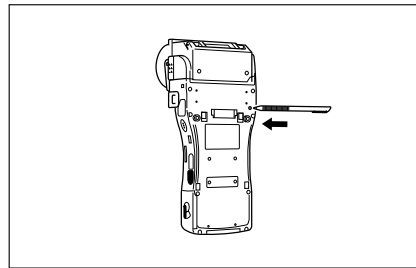

If reset does not find a memory problem

The Handheld Printer Terminal restarts, and normal operation is restored.

If reset finds a memory problem

A message like the one shown below appears on the display when the reset operation discovers a memory problem.

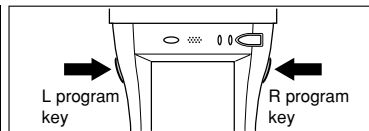
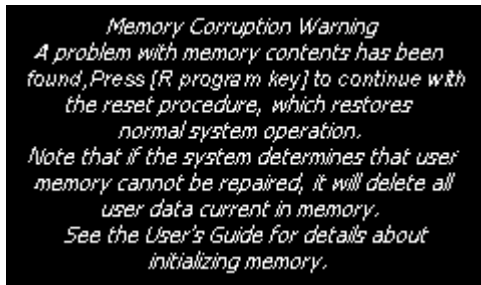

When this message appears, press the R Program key to continue with the reset operation. Note, however, that reset may not be successful depending on the condition of the memory. In this case, perform the full reset operation described on the next page.





Resetting the Handheld Printer Terminal

Performing a Full Reset (Initialization)

Performing a full reset initializes memory. This means that all data stored in the memory (RAM) is deleted and all the settings are returned to their initial factory defaults.

Perform a full reset whenever any one of the following conditions exists.

- When you want to delete all memory contents and return the settings to their initial factory defaults.
- When you are no longer able to use the Handheld Printer Terminal because you forgot your password.
- When the Handheld Printer Terminal does not operate normally due to a memory problem.
- When the message “A problem with memory contents has been found. ...” appears.

To perform a full reset

Important!

Performing a full reset deletes all data currently stored in the memory (RAM). If possible, backup data of the Handheld Printer Terminal to a computer, Flash Memory, a memory card, or some other medium before performing a full reset.

1. While the Handheld Printer Terminal is turned on, hold down the power key and push down the reset button for about one second, until the message shown below appears on the display.

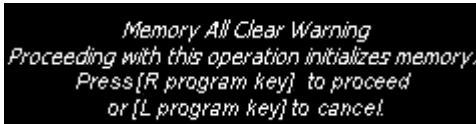

*Memory All Clear Warning
Proceeding with this operation initializes memory.
Press [R program key] to proceed
or [L program key] to cancel.*



- To cancel the full reset operation, press the L program key instead of the R program key.
2. Press the R Program key. This causes the message shown below to appear.

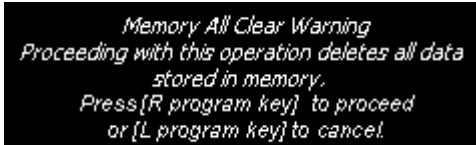

*Memory All Clear Warning
Proceeding with this operation deletes all data
stored in memory.
Press [R program key] to proceed
or [L program key] to cancel.*



- To cancel the full reset operation, press the L Program key instead of the R Program key.
3. Press the R Program key again.
- Full reset is performed, all data in the memory (RAM) are erased and the start-up screen is displayed.



IT-3000 Specifications

1. Terminal Specifications

Model: IT-3000M53E, IT-3000M54E
 CPU: Intel® PXA255 Application Processor (400 MHz max.)
 Memory: 32MB RAM, 64MB ROM (user defined: 30MB)
 OS: Microsoft® Windows® CE NET operating system (English Version)
 Display: 3.5-inch, 240 × 320 dots, 2-Way TFT Color LCD

2. IR Communication Specifications

Interface: Complies with IrDA Ver. 1.1
 Synchronization: Start/stop synchronous, frame synchronization
 Transfer Rate: Up to 4 Mbps (max.)

3. Serial Interface Specifications

Interface: 8-pin
 Synchronization: Start/stop synchronous
 Transfer rate: 300 bps to 115.2 Kbps
 Interface: 14-pin
 Synchronization: Start/stop synchronous
 Transfer Rate: 300 bps to 115.2 Kbps
 * Wake on compatible

4. Bluetooth Communication Specifications

Protocol: Bluetooth Specification Ver. 1.1
 Range: Approximately 5 m (depends on radio wave conditions and environment)
 Output: 3 dBm max. (PowerClass2)
 * Wake on function

5. Printer Specifications

Type: Drop-in thermal line dot printer
 Effective Printing Width: 72 mm (80mm wide paper)/48 mm (58 mm wide paper)
 Printing Speed: 28 lines/second
 Printable Characters: ANK, Kanji (JIS Level 1/Level 2), barcodes (JAN/UPC-E/ NW-7/Code-39/ITF/Code-128), OCR-B, 128 non-standard characters
 Character Fonts: Kanji 12dot 48/32 columns, 16dot 36/24 columns, 24dot 24/16 columns (columns shown for 80 mm wide paper and 58 mm wide paper, respectively)
 Character Size: Unrestricted character size
 Generating Method: Black/white inversion, mixed character font printing

6. Card Slot Specifications

PC Card Slot: PC Card Type I/Type II (3.3 V/5.0 V specifications)
 * Wake on compatible
 SD Memory Card Slot: SD Memory Card

7. Magnetic Card Reader (IT-3000M54E)



IT-3000 Specifications

8. Power Requirements

Main Power Supply:	Lithium ion battery pack
Backup Power Supply:	Lithium battery (internal)
Battery Life:	Main battery - Approx. 12.6 hours*, Approx. 15 hours** * Backlight off, JEITA Mode D ** Backlight off, JELTA Mode A
Backup battery:	Data retention RAM) - 10 minutes (without main battery) Clock - 2 weeks (without main battery)
Power Consumption:	DC 4.5 A/7.4-10 V

9. Operating Environment

Operating Temperature:	-20 to 50°C (5-35°C when printing 2P-size or labels)
Operating Humidity:	10-80% RH (no condensation)

10. Dimensions and Weight

External Dimensions:	Approx. 80 (display W) × 199.5 (D) × 28 (display H) mm (not including paper holder projections) (IT-3000M53E)
Weight:	Approx. 530 g (not including paper holder) (IT-5300M53E) Approx. 580 g (not including paper holder) (IT-5300M54E)

11. Other

Drop Durability:	1.2 m
Dust and Water Resistance:	Complies with IEC60529 IP54
Clock Function:	Year, month, date, day, hour, minute; fully automated calendar





Using the Bridge Satellite Cradle (HA-B61IO)

The optionally available Bridge Satellite Cradle (HA-B61IO) makes it possible to transfer system data and file data between the Handheld Printer Terminal and a computer over an RS-232C connection or USB connection. You can also use the Bridge Satellite Cradle to charge the battery pack installed on the Handheld Printer Terminal.

General Guide

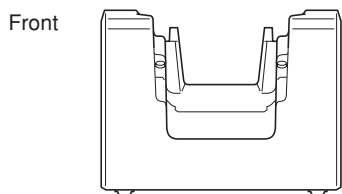
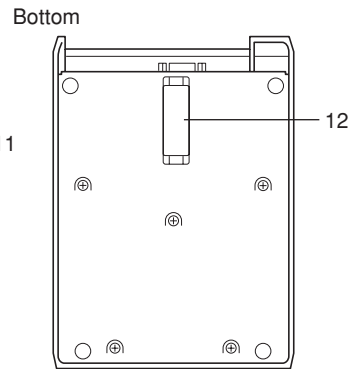
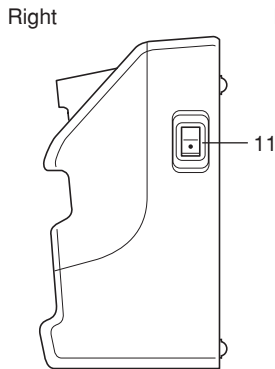
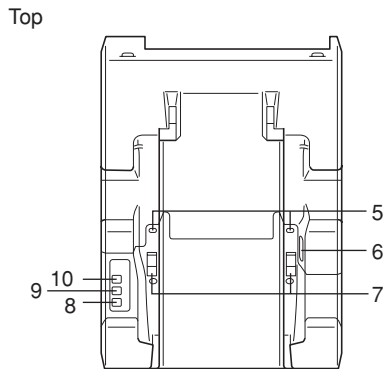
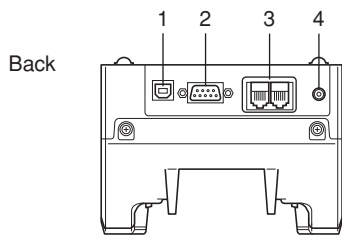



Using the Bridge Satellite Cradle (HA-B61IO)

1	USB Port	This port accepts connection of a USB cable for connection to a computer for transfer of system data and file data. Use of the USB port requires installation of a special driver on the PC.
2	RS-232C Port	This port accepts connection of an RS-232C cable for connection to a computer for transfer of system data and file data. Use of the RS-232C port requires installation of a special driver on the PC.
3	RS-422 Port	This port is used when connecting to another Bridge Satellite Cradle.
4	AC Adaptor Jack	Connect the AC adaptor here.
5	Terminal Detect Switch	This switch detects when the Handheld Printer Terminal is not seated correctly on the Bridge Satellite Cradle.
6	IR Port	This port transfers data with the Handheld Printer Terminal IR port non-contact data communication.
7	Power Contacts	Power is supplied to the Handheld Printer Terminal via these contacts.
8	Power Indicator Lamp	This lamp indicates the Power Status and the mounting status of the Handheld Printer Terminal. Off: Power off Green: Power on, Handheld Printer Terminal mounted correctly Red: Power on, Handheld Printer Terminal not mounted
9	Communication Indicator Lamp	This lamp shows when the Handheld Printer Terminal is performing data communication. Off: No data communication being performed Green flashing: Data communication in progress Red: Problem with a connection between two Bridge Satellite Cradles
10	System Status Indicator Lamp	This lamp indicates whether the system is operating normally. Regardless of whether or not a Handheld Printer Terminal is mounted this lamp indicates the system status and whether or not a communication operation with the system can be performed. Off: System is not operating. Green: System is operating.
11	Power Switch	Turns the power on and off.
12	DIP Switches	Use these switches to configure the Bridge Satellite Cradle as required.



Connecting the AC Adaptor and Connecting to Computer

Use the AC adaptor available as option for the Bridge Satellite Cradle to supply the power to it. Always make sure that the power is being supplied to the Bridge Satellite Cradle by the AC adaptor before performing any type of data communication operation with the Handheld Printer Terminal. The Handheld Printer Terminal draws the power via the Bridge Satellite Cradle during data communication.

1. After making sure that the Bridge Satellite Cradle power switch is turned off, plug the AC adaptor into the AC adaptor jack on the back.
2. Next, plug the AC adaptor into a power outlet.

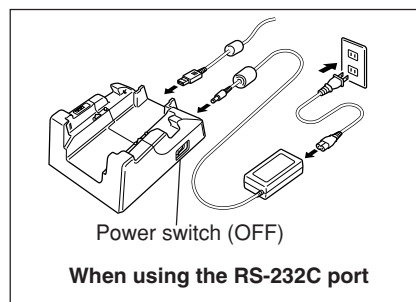

3. After making sure that the Bridge Satellite Cradle and your computer are both turned off, connect the RS-232C interface or USB interface (after removing the respective cap) on the back of the Bridge Satellite Cradle to your computer with an RS-232C Cable (DT-887AXA/882RSC/883RSC) or USB Cable (DT-380USB).

Attach the cap when not using an RS-232C Cable (DT-887AXA/882RSC/883RSC) or USB Cable (DT-380USB).

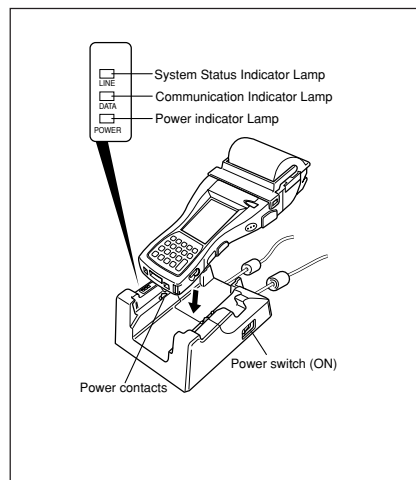



Using the Bridge Satellite Cradle (HA-B61IO)

4. Turn on the power. This causes the Bridge Satellite Cradle power indicator lamp to light in red.
 5. Place so that the infrared communication unit on the right side of the Handheld Printer Terminal is pressed firmly against the infrared communication unit of the Bridge Satellite Cradle.
- If the system is operating normally and data communication is enabled, the system status indicator lamp lights in green.
 - The communication indicator lamp flashes in green when data communication starts.

When charging is initiated, indicator 1 on the IT-3000 lights up in red. When charging has been completed, indicator 1 on the IT-3000 changes color from red to green.

* The charging LED may light even if the battery pack is not installed. Make sure that the battery pack is installed when charging.

Important!

- **A high-sensitivity communication element is used during IR data communication.**

In order to ensure successful communication, avoid using cellular phones or other devices that emit radio wave in the area where you are performing IR data communication.

If you need to use such a device, move away from the communicating Handheld Printer Terminals. In case of a cellular phone, keep it at least 30cm (11 $\frac{7}{8}$ ") away.

- **Take care to avoid allowing the Bridge Satellite Cradle power contacts to become connected to each other, which creates a short.**

Shorting the power contacts can damage the Bridge Satellite Cradle.

- **If you print while charging, the battery will wear down since the amount of power discharged is greater than the amount of power supplied. Consequently, you may not be able to print if the battery power is excessively low.**



Configuring DIP Switch Settings

Dismounting the bottom cover of the Bridge Satellite Cradle exposes the DIP switches. You can change the ON/OFF settings of the DIP switches to set the configuration. Please, set after first switching OFF the power.

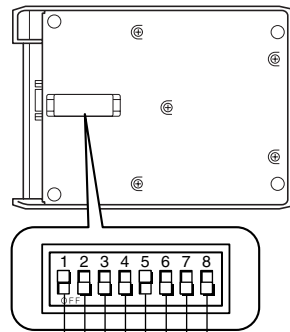

Not used (Always off)

Not used (Always off)

Host Computer Interface

Setting	6
RS-232C	OFF
USB	ON *

Daisy Chain

Setting	5
Intermediate Unit	OFF
Daisy Chain Disabled/Termination	ON *

Connection Type

Setting	3	4
Host Computer	OFF	OFF *
Daisy Chain	ON	OFF

Bridge Satellite Cradle Data Rate

Setting	1	2
115,200bps	ON	OFF *

*Initial factory default setting

Important!

Note that other DIP settings are used for testing and inspection purposes. Because of this, you should never use any DIP settings other than those described above.





Using the Bridge Satellite Cradle (HA-B61IO)

Connecting Multiple Bridge Satellite Cradles (HA-B61IO)

Connect “C-OUT” of the Bridge Satellite Cradle connected to the host computer to “C-IN” of the next Bridge Satellite Cradle you want to connect.

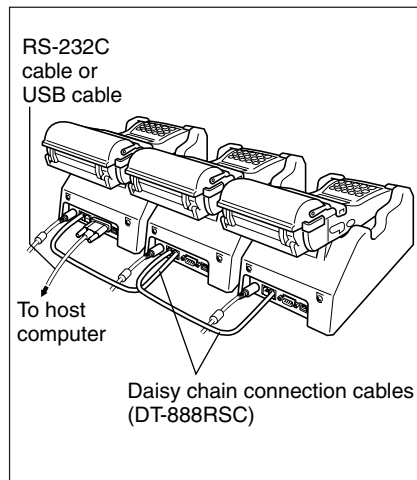

Important!

You can use optional daisy chain connection cables (DT-888RSC) to link up to eight Bridge Satellite Cradles.



Bridge Satellite Cradle (HA-B6110) Specifications

1. IR Data Communication

Interface:	IR interface
Protocol:	IrDA Ver. 1.1 Standard
Synchronization:	Start/stop synchronous, frame synchronization
Transfer Rate:	9,600/115,200bps/4Mbps (4Mbps is possible during a USB connection with the host computer only.)

2. USB

Protocol:	USB Ver1.1 Standard
Transfer Rate:	12Mbps (max.)

3. RS-232C

Protocol:	Full duplex
Synchronization:	Start/stop synchronous
Transfer Rate:	115,200bps

4. RS-422

Protocol:	Full duplex
Synchronization:	Start/stop synchronous
Transfer Rate:	115,200bps

5. Charging

Charging System:	Fixed-voltage (with current limiter)
Charge Time:	Approximately 8.0 hours (standard battery pack)

6. Power Supply

Power Requirement:	AC adaptor (AD-S42120A)
Power Consumption:	DC12V approximately 2,200mA
Output Handheld Printer Terminal:	DC10V 1,800mA (max.) * The printer of the Handheld Printer Terminal cannot be operated with this power supply alone.

7. AC Adaptor

Model:	AD-S42120A
Input:	100V to 240V AC 50/60Hz
Output:	12V DC 3,500mA

8. Dimensions and Weight

Dimensions:	Approximately 130(W) × 206(D) × 104(H) mm (5 $\frac{1}{8}$ "W × 8 $\frac{1}{8}$ "D × 4 $\frac{1}{8}$ "H)
Weight:	Desktop: Approximately 490g (17.3oz)

9. Operating Environment

Temperature:	0°C to 40°C (32°F to 104°F)
Humidity:	30% to 80% RH (non-condensation)



Using the Cradle-type Battery Charger (HA-B30CHG)

The optionally available Cradle-type Battery Charger (HA-B30CHG) lets you charge the Handheld Printer Terminal's battery simply by placing the Handheld Printer Terminal onto the charger.

General Guide

Back

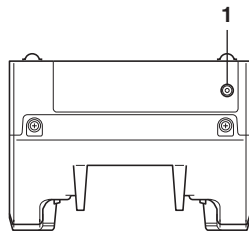

Top

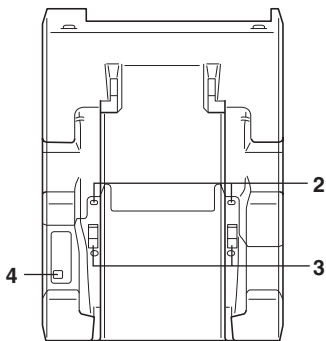

Right

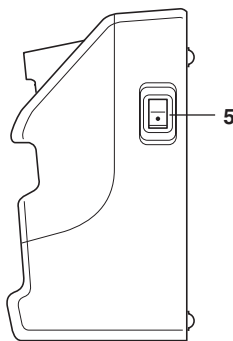

Bottom

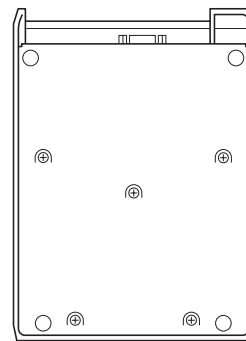

Front

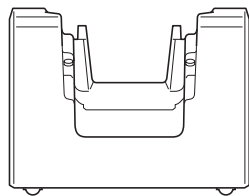



1	AC Adaptor Jack	Connect the AC adaptor here.
2	Terminal Detect Switch	This switch detects when the Handheld Printer Terminal is not seated correctly on the Cradle.
3	Power Contacts	Power is supplied to the Handheld Printer Terminal via these contacts.
4	Power Indicator Lamp	This lamp indicates the power status and the mounting status of the Handheld Printer Terminal. Off: Power off Red: Power on, Handheld Printer Terminal not mounted Green: Power on, Handheld Printer Terminal mounted correctly
5	Power Switch	Turns the power on and off.

E-59



Using the Cradle-type Battery Charger (HA-B30CHG)

Connecting the AC Adaptor for Cradle-type Battery Charger

Use the special AC adaptor for the Cradle-type Battery Charger to connect to a wall outlet.

1. After making sure that the Cradle-type Battery Charger power switch is turned off, plug the AC adaptor into the AC adaptor jack on the back of the charger.

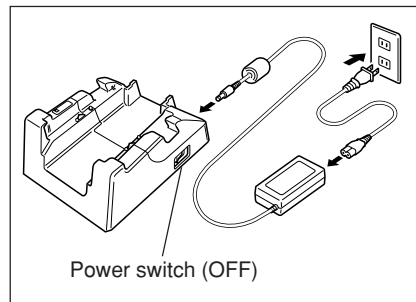

2. Next, plug the AC adaptor into a power outlet.
3. Turn on the power. This causes the Cradle-type Battery Charger power indicator lamp to light in red.

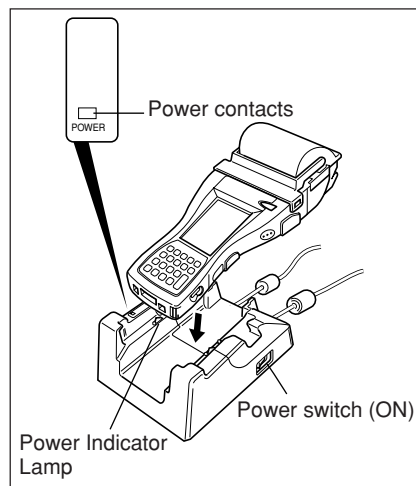

4. Making sure that their power contacts come into contact with each other, place the Handheld Printer Terminal onto the Cradle-type Battery Charger. This causes the Cradle-type Battery Charger power indicator lamp to light in green.

When charging is initiated, indicator 1 on the IT-3000 lights up in red. When charging has been completed, indicator 1 on the IT-3000 changes color from red to green.

* The charging LED may light even if the battery pack is not installed. Make sure that the battery pack is installed when charging.

Important !

- Take care to avoid allowing the Cradle-type Battery Charger power contacts to become connected to each other, which creates a short. Shorting the power contacts can damage the Cradle-type Battery Charger.
- If you print while charging, the battery will wear down since the amount of power discharged is greater than the amount of power supplied. Consequently, you may not be able to print if the battery power is excessively low.

E-60





Cradle-type Battery Charger (HA-B30CHG) Specifications

1. Charging

Charging System: Fixed-voltage (with current limiter)
Charge Time: Approximately 8.0 hours (standard battery pack)

2. Power Supply

Power Requirement: AC adaptor (AD-S42120A)
Power Consumption: 12V DC, approximately 2,100mA
Output Handheld Printer Terminal: 10V DC 1,800mA (max.)

3. AC Adaptor

Model: AD-S42120A
Input: 100V to 240V AC 50/60Hz
Output: 12V DC 3,500mA

4. Dimensions and Weight

Dimensions: Desktop: Approximately 130(W) X 206(D) X 104(H) mm
(5¹/₈"W x 8¹/₈"D x 4¹/₈"H)
Wall Mount: Approximately 110(W) x 148(D) x 153(H) mm
(4⁵/₁₆"W x 5¹³/₁₆"D x 6"H)

Weight: Desktop: Approximately 630g (22.2oz)

5. Operating Environment

Temperature: 0°C to 40°C (32°F to 104°F)
Humidity: 30% to 80% RH (non-condensation)





■ Using the AC Adaptor (DT-9020ADP) —

1. Turn off the power of the Handheld Printer Terminal by pressing the power key.
2. Plug the AC Adaptor into a wall outlet, open the jack cover ([1]), and then insert the plug of the AC Adaptor into the charging jack ([2]).

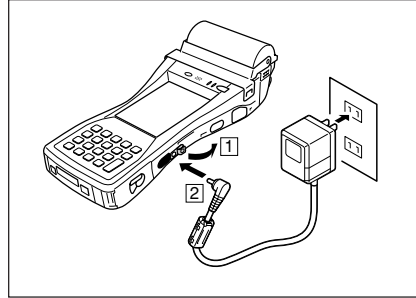

3. Charging begins and Indicator 1 on the Handheld Printer Terminal lights red. Charging is completed when Indicator 1 changes to green. (Charging time is about 8 hours with the power off.)

* The charging LED may light even if the battery pack is not installed. Make sure that the battery pack is installed when charging.

Important!

- Securely install the battery pack.
- Charge in a location free of vibrations.
- The AC Adaptor is to be exclusively with the battery pack.
- Turn off the power of the Handheld Printer Terminal when connecting the AC Adapter.

AC Adaptor (DT-9020ADP) Specifications

1. Charging Specifications

Charging Method: Constant-voltage, constant-current charging (internal charging circuit)

Charging Time: Approximately 8 hours (with the power off)

2. Dimensions and Weight

External Dimensions: Approx. 77 × 53 × 42 mm

Weight: Approx. 400 g



Using PC Cards

The Handheld Printer Terminal is compatible with PC cards. Insert a PC card according to the procedure described below.

Attachment of PC Card Removal Tape

There are some PC cards that may be difficult to remove from the PC card slot once they have been inserted. In the case of such PC cards, attach the PC card removal tape provided before inserting the PC card.

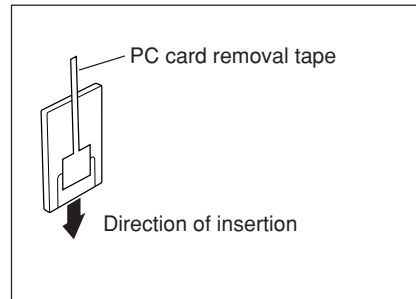

Important!

When inserting a CF card and so forth using the PC Card Adapter, always make sure to attach the PC card removal tape to the PC Card Adapter. If the PC card removal tape is mistakenly attached to the CF card and so forth, only the CF card will come out when the PC Card Adapter is attempted to be removed, preventing the PC Card Adapter from being able to be removed.

Inserting a PC Card

1. Check that the power is off. If the power is on, always make sure to turn it off by pressing the power key.
2. Turn over the Handheld Printer Terminal.
3. Loosen the two screws shown in the illustration (the screws cannot be removed).

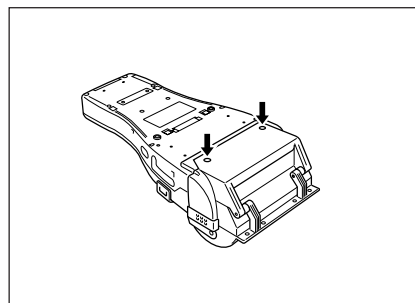



Using PC Cards

4. Open the cover (PC card slot cover) as shown in the illustration.

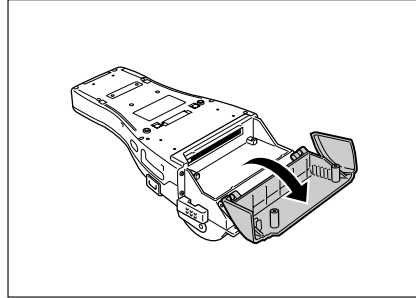

5. Insert a PC card having PC card removal tape attached. Insert the PC card all the way in with the top of the card facing towards the top of the Handheld Printer Terminal. Fold up the end of the PC card removal tape so that it does not get in the way when closing the cover.

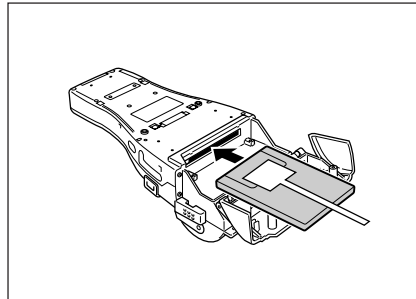

6. Attach the PC Card Holder to lock the end of the PC card and prevent it from coming out due to impacts and so forth. Decide on the type of PC Card Holder (three types are available) and the orientation and attachment position of the holder according to the location of the end of the PC card.

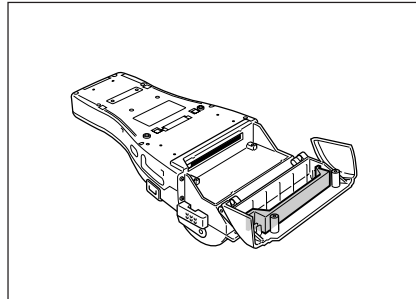

7. Close the cover (PC card slot cover) and fasten with the two screws.

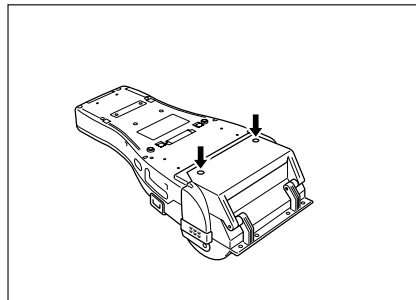



Removing a PC Card

Press the eject button on the left side of PC card slot with the stylus shown by the arrow, and pull out the PC card while holding onto the end of the PC card removal tape.

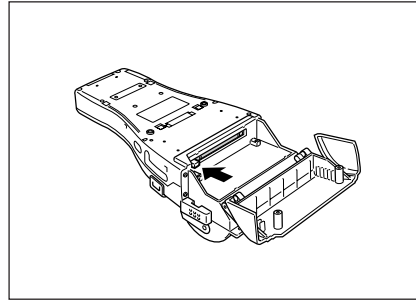

When the Paper Holder is Attached

1. Check that the power is off. If the power is on, always make sure to turn it off by pressing the power key.
2. Remove parts C, D and B of the Paper Holder by following the reverse procedure of the procedure described in steps 12 and 11 in, "Attaching the Paper Holder".
3. Insert a PC card having the PC card removal tape attached to it. Insert the PC card so that the top of the card is facing towards the top of the Handheld Printer Terminal. Furthermore, the PC Card Holder cannot be used when using the Paper Holder.
4. Attach the Paper Holder by following the procedure described in steps 12 and 11 in, "Attaching the Paper Holder".



Using SD Memory Cards

The Handheld Printer Terminal is compatible with SD memory cards. Insert (replace) an SD memory card according to the procedure described below.

Inserting an SD Memory Card

1. Check that the power is off. If the power is on, always make sure to turn it off by pressing the power key.
2. Open the cover of the SD memory card slot (1) and insert an SD memory card all the way in until the top of the SD memory card faces the top of the Handheld Printer Terminal (2).

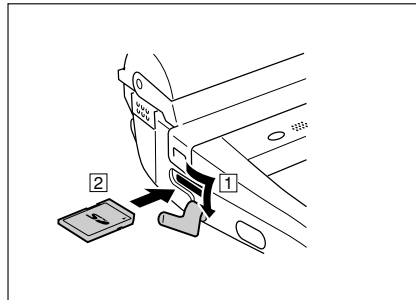

3. Close the cover of the SD memory card slot.





Removing an SD Memory Card

1. Check that the power is off. If the power is on, always make sure to turn it off by pressing the power key.
2. Open the cover of the SD memory card slot and press on the SD memory card (1). The SD memory card is pushed out (2).

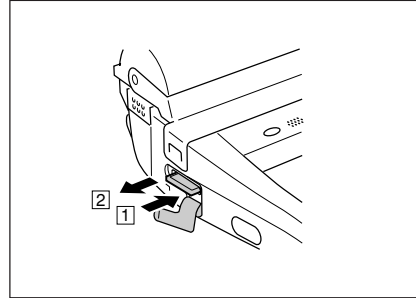

3. Pull out the SD memory card and close the cover of the SD memory card slot.





■ Handling Bar-Code Reader

Connect the bar-code reader to the Handheld Printer Terminal's bar-code reader connector.

There are two models of bar-code reader: pen scanner DT-9650BCR, touch scanner DT-9656BCR.

Connecting the bar-code reader

1. Turn the power on the Handheld Printer Terminal off. Open the cover of the bar-code reader connector. (1)
2. Insert the plug of the bar-code reader into connector as shown in the illustration. (2)

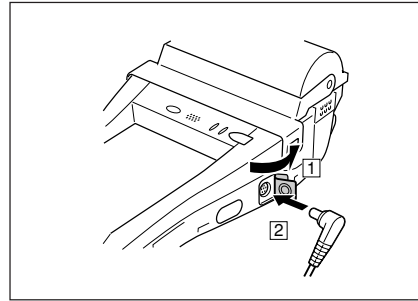

Detaching bar-code reader

Turn the power on the Handheld Printer Terminal off. Unplug the bar-code reader.



Using a bar-code reader

<Pen scanner>

1. Bar code scanning angle

(at read resolution : 0.19 mm, (PCS value 0.85))



How to hold the scanner

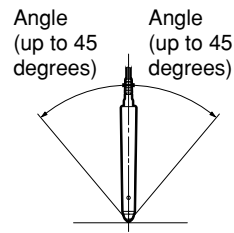

Effective angle

2. Bar code scanning position

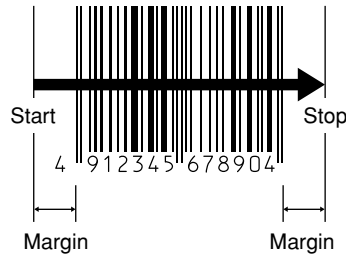

Correct



Correct



Correct

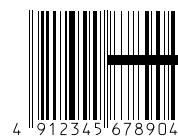

Wrong



Wrong



Wrong

E-69



Handling Bar-Code Reader

<Touch scanner>

1. Bar-code touching angle

(at read resolution 0.33mm, PCS value 0.45)

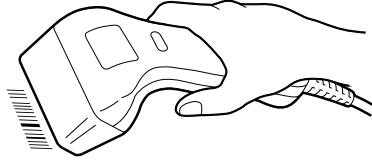

How to hold the scanner

non-contact distance (h)

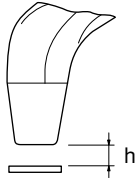

$h=0\sim 20\text{mm}$

$\alpha=0$

$\beta=0$

$R=\infty$

Angle between the bar-code and forward/
backward inclined reading window (α)

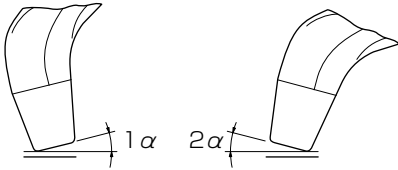

$1\alpha=0\sim 10^\circ$ (front part is inclined forward)

$2\alpha=0\sim 30^\circ$ (back part is inclined backward)

$h=0$

$\beta=0$

$R=\infty$

The angle of inclination to the right/left (β)

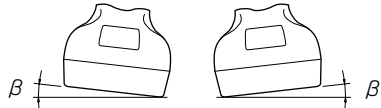

$\beta=0\sim 10^\circ$

$h=0$

$\alpha=0$

$R=\infty$

Curve (R)

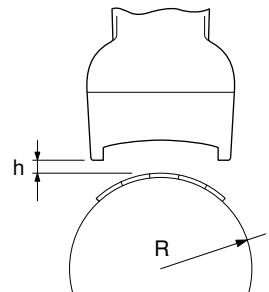

$R=25\text{ mm and above}$

(at read resolution 0.33, PCS value 0.45)

$h=5\text{ mm}$

$\alpha=0$

$\beta=0$

* h, α, β, R are commonly defined.

Position of bar-code must be in the center
of the reading window.

E-70



2 Bar-code touching angle



Correct



Correct

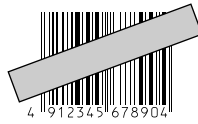

Correct



Wrong

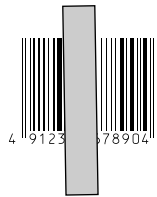

Wrong



Wrong



Wrong

E-71



Handling Bar-Code Reader

Bar Code Reader Specifications

DT-9650BCR Pen Scanner

Readable Codes:	WPC (JAN, EAN, UPC), NW-7, CODE-11/39/93/128, ITF, INDUSTRIAL20F5
Cable Length:	Approximately 100cm
Read Resolution:	0.125 mm min. (PCS value 0.85 min.)
Read Angle:	90 to 45 degrees
Scan Speed:	75 to 760 mm/second
Operating Temperature/Humidity:	-10 to 50°C (14 to 122°F)/15 to 90% RH
Dimensions:	Approximately 147 (W) × 20.6 (D) × 12.5 (H) mm (5 13/16 × 13/16 × 1/2 inch)
Weight:	Approximately 85 g (3.0 oz)(including cable)

DT-9656BCR Touch Scanner

Readable Codes:	WPC (JAN, EAN, UPC), NW-7, CODE-39/93/128, ITF, DTF, MSI/Plessey, IATA
Cable Length:	Approximately 60 cm (extended)
Read resolution:	0.127 mm min. (PCS value 0.9 min.)
Non-contact Distance:	0 to 20 mm
Read Angle:	Forward: 10 degrees Back: 30 degrees Left/Right: ±10 degrees Rotating: ±10 degrees Curved: R=25 mm min. (with resolution of 0.33 mm)
Read Width:	60 mm
Operating Temperature/Humidity:	0 to 40°C (14 to 104°F)/20 to 80% RH
Dimensions:	Approximately 161 (W) × 64.4 (D) × 59 (H) mm (6 5/16 × 2 9/16 × 2 inch)
Weight:	Approximately 250 g (8.8 oz)(including cable)



■ Attaching the Screen Protect Cover –

Attaching the Screen Protect Cover to the IT-3000 prevents the screen from being cracked or damaged when carrying.

1. Remove the two screws on the right side of the Handheld Printer Terminal. Store the screws in a safe place after they have been removed.

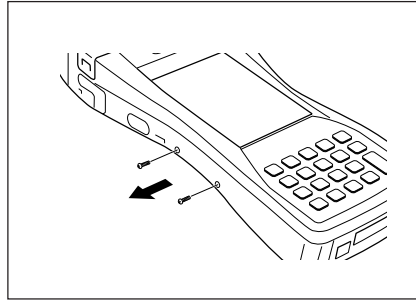

2. Fasten the Screen Protect Cover with the two screws provided with the Screen Protect Cover.

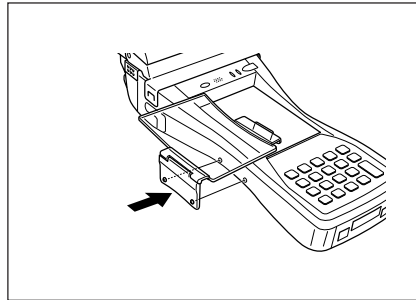

3. Close the Screen Protect Cover and fasten by pressing on the cover hook.

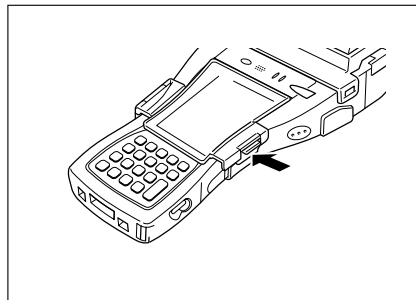

Press up on the cover hook when opening the cover.

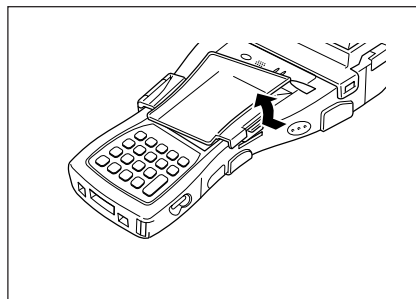

E-73



■ Attaching the Splash Protect Cover (IT-3000M53E only)

Attaching the Splash Protect Cover to the IT-3000 lets you use it even during inclement weather.

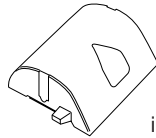
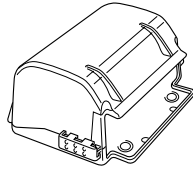

inner cover

Attach the Splash Protect Cover by following the procedure described below.

1. Press the ridged () portions (**[1]**) of the paper outlet cover while spreading apart the locks on the left and right sides (**[2]**) to disengage them as shown in the illustration followed by opening the paper outlet cover (**[3]**).

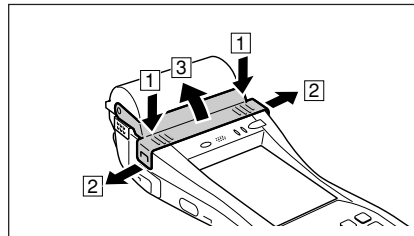

2. Slide the lock switches on the left and right sides of the roll paper holder as shown in the illustration to align at the FREE position (**[1]**), and then push up the ridged () portion (**[2]**) to open.

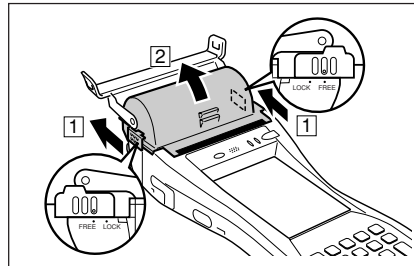

3. Spread apart the bearing supports of the paper outlet cover towards the left and right directions and remove.

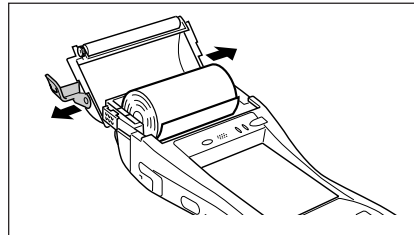

4. Attach the cover as shown in the illustration. First, insert a tab on one side of the roll paper holder into one of the slits of the inner cover (**[1]**). Next, push down on the opposite side of the inner cover, and insert the tab on that side of the roll paper holder into the slit on that side (**[2]**).

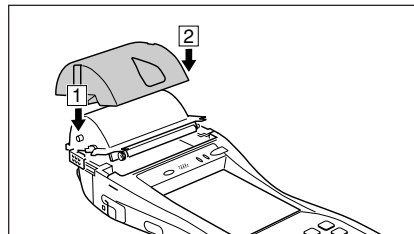

E-74





5. Close the roll paper holder, slide the lock switches on the left and right sides as shown in the illustration to align at the “LOCK” position to lock the roll paper holder in position, and then tear off the protruding roll paper.

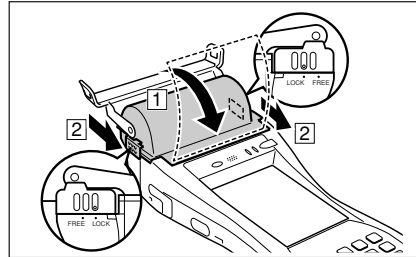

6. Slide the lock switches (1) on the left and right sides of the Splash Protect Cover as shown in the illustration and open the cover (2).

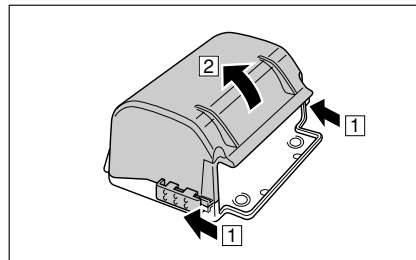

7. Attach the Splash Protect Cover as shown in the illustration.

- Check that the transparent film of the inner cover is at the position shown in the illustration (1).
- Check that the tabs on the inside of the Splash Protect Cover (located on the left and right sides) have entered the indentations on the left and right sides of the Handheld Printer Terminal (2).

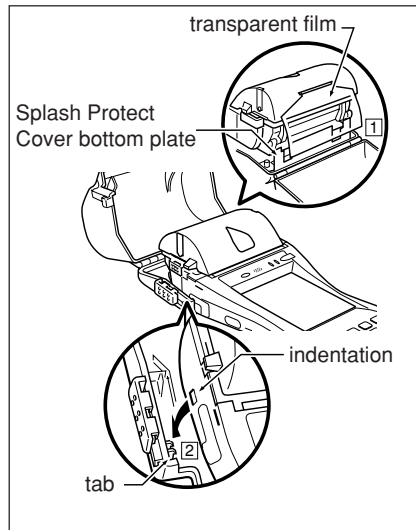

8. Close the Splash Protect Cover (1), and fasten with the lock switches (2) on the left and right sides.

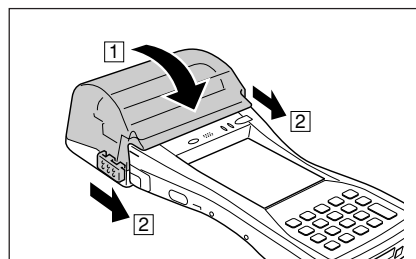

E-75



■ Using the Battery Pack —

Important!

- Make sure to attach the contact cover provided when removing the Battery Pack from the Handheld Printer Terminal and storing.

Battery Pack Specifications

Model:	DT-9723LI
Nominal Capacity:	2200 mAh
Nominal Voltage:	7.4 V
External Dimensions:	39 (W) × 71 (D) × 21 (H) mm
Weight:	Approximately 95 g
Accessories:	Contact cover





Memo



E-77





CASIO®

CASIO COMPUTER CO., LTD.

6-2, Hon-machi 1-chome
Shibuya-ku, Tokyo 151-8543, Japan

Printed on recycled paper.

PN410385-001
MO0404-A Printed in Japan