

Handheld Terminal

手持终端

Portatif Terminal

IT-800

CASIO®

Series
系列
Serisi

User's Guide

用户说明书

Kullanım Kılavuzu

Be sure to read "Safety Precautions" inside this guide before trying to use your Handheld Terminal. After reading this guide, keep it in a safe place for future reference.

For product detail, refer also to http://world.casio.com/system/pa/UsersGuide/sup85_e.html

在使用手持终端之前，请务必阅读本说明书中的“安全注意事项”。阅读完毕之后，请将本说明书妥善保存，以备今后参考。

有关产品的详细信息，请另外参阅：
http://world.casio.com/system/pa/UsersGuide/sup85_e.html

Portatif Terminali kullanmadan önce kılavuzun içindeki "Güvenlik Önlemlerini" okuyunuz.

Kılavuzu okuduktan sonra ileride başvurmak için güvenli bir yere kaldırınız.

Ürün detayları için ayrıca şuraya başvurun

http://world.casio.com/system/pa/UsersGuide/sup85_e.html

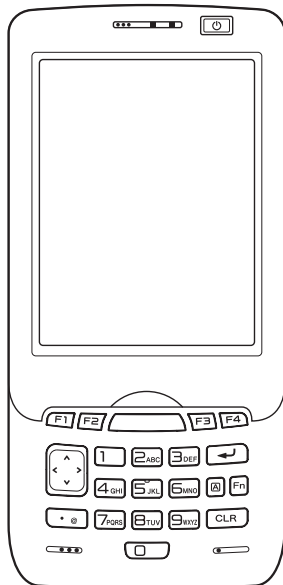

English

中国语

Türkçe

Bluetooth®

- BLUETOOTH is a registered trademark owned by Bluetooth SIG, Inc. and licensed to CASIO COMPUTER CO., LTD.
- Microsoft and Windows are either registered trademarks or trademarks of Microsoft Corporation in the United States and/or other countries.

Information in this document is subject to change without advance notice. CASIO Computer Co., Ltd. makes no representations or warranties with respect to the contents or use of this manual and specifically disclaims any express or implied warranties of merchantability or fitness for any particular purpose.

Bluetooth®

- BLUETOOTH是注册商标，为Bluetooth SIG, Inc.所拥有，并授权卡西欧计算机株式会社使用该商标。
- Microsoft和Windows是微软公司在美国和/或其他国家的注册商标或商标。

未经事先通知，可更改本文信息。卡西欧计算机有限公司对本手册内容或本手册的使用不做任何声明或保证，并且对于任何特定目的的适销性或适用性的明示或默示的保证不予承诺。

Bluetooth®

- BLUETOOTH, Bluetooth SIG, Inc. şirketinin sahip olduğu ve lisansı CASIO COMPUTER CO., LTD'ye verilen tescilli bir ticari markadır.
- Microsoft ve Windows ABD'de ve/veya başka ülkelerde bulunan Microsoft Corporation'ın tescilli ticari ya da ticari markalarıdır.

Bu belgedeki bilgiler önceden bildirilmeksizin değiştirilebilir. CASIO Computer Co., Ltd. bu kılavuzun içeriği veya kullanımıyla ilgili hiçbir sorumluluk kabul etmez ya da garanti vermez ve ticari değer veya belirli bir amaca uygunluk konusundaki açık ya da zımnî her türlü garantiyi reddeder.

Contents

Safety Precautions	E-2
Operating Precautions	E-7
Important	E-7
Regulatory Information	E-8
Handheld Terminal System Configuration	E-10
General Guide	E-12
Loading and Removing the Battery Pack.....	E-14
Charging the Battery Pack	E-17
Handling the Hand Belt.....	E-19
Attaching the Neck Strap.....	E-20
Configuring Handheld Terminal Settings	E-21
Adjusting the Laser Light Emission Width	E-22
Handling microSD Cards	E-24
Handling SIM Cards.....	E-26
Handling SD Memory Cards	E-28
Resetting the Handheld Terminal.....	E-29
Warning Label	E-31
USB Cradle (HA-H60IO), Ethernet Cradle (HA-H62IO)	E-32
Cradle-type Battery Charger (HA-H30CHG).....	E-33
Car Mounted-type Battery Charger (HA-H35CHG).....	E-33
Dual Battery Charger (HA-D32DCHG)	E-34

Safety Precautions

Congratulations upon your selection of this CASIO product. Be sure to read the following Safety Precautions before trying to use it for the first time.

Your neglect or avoidance of the warning and caution statements in the subsequent pages causes the danger of fire, electric shock, malfunction and damage on the goods as well as personal injury.



Markings and Symbols

The following are the meanings of the markings and symbols used in these Safety Precautions.

 **Danger** This symbol indicates information that, if ignored or applied incorrectly, creates the danger of death or serious personal injury.

 **Warning** This symbol indicates information that, if ignored or applied incorrectly, creates the possibility of death or serious personal injury.

 **Caution** This symbol indicates information that, if ignored or applied incorrectly, creates the possibility of personal injury or property damage.

-  • A diagonal line indicates something you should not do. The symbol shown here indicates you should not try to take the unit apart.
-  • A black circle indicates something you should do. The symbol shown here indicates you should unplug the unit from the wall outlet.

Warning

Disassembly and Modification

-  • Never try to disassemble or modify the Handheld Terminal and its options including battery pack and battery in any way.

Abnormal Conditions

-  • Should the Handheld Terminal and/or its options including battery pack and battery become hot or start to emit smoke or a strange odor, immediately turn off the power and contact your dealer or distributor whom you purchased the product from, or an authorized CASIO service provider.

Warning

Dust and Moisture

-  • Though the Handheld Terminal is dust and water splash resistant, its options including the battery pack are not. Keep loose metal objects and containers filled with liquid away from your Handheld Terminal and the options. Also, never handle the Handheld Terminal and the options while your hands are wet.

Laser Light

-  • The laser scanner models (model dependant) with the integrated laser scanning module scan bar codes using laser light. Never look directly into the laser light or shine the laser light into the eyes.

Warning

Interference with the Operation of Other Equipment (Using Wireless Data Communication)

-  • Keep your Handheld Terminal at least 22 centimeters (8¹¹/₁₆") away from anyone wearing a pacemaker. Radio waves emitted by the Handheld Terminal can affect the operation of a pacemaker.
- Before the use in aircraft, be sure to consult with cabin crew for interference the Handheld Terminal emits.
- Before the use in medical facility, be sure to consult with the facility management or the manufacture of a specific medical equipment that the Handheld Terminal may interfere with.
- Do not use the Handheld Terminal nearby gas pump or chemical tank or any other places flammable or explosive.

Caution

Foreign Objects

-  • Take care to ensure that metals or combustible objects are not inserted into the openings of the Handheld Terminal or its options, and not to allow moisture to get inside of them.

Location



-  • Install the cradle properly on a flat and stable surface so that it cannot fall down onto floor.

LCD Screen

-  • Never apply strong pressure to the screen or subject it to strong impact. Doing so can crack the LCD Screen.

Warning

Avoiding Traffic Accidents



-  • Never use your Car Mounted-type Battery Charger while operating a motor vehicle. Park your vehicle in a safe place before performing any operation.
-  • Never locate the Car Mounted-type Battery Charger where it might interfere with proper operation of the vehicle.
-  • Locate connecting cables as instructed by the manual, avoiding locations that can interfere with driving operations.

Car Battery Power

-  • Should the Car Power Cable become damaged, replace it immediately with a new Car Power Cable when using the Car Mounted-type Battery Charger.



Caution

Installing in Vehicle



-  • To save your vehicle's battery from running down, be sure that the Car Power Cable should be unplugged from the cigarette lighter socket when you do not use the Car Mounted-type Battery Charger and that the use of the battery charger should be avoid while the vehicle's engine is turned off.
-  • Do not handle the Car Power Cable with wet hands.
-  • Install the Car Mounted-type Battery Charger at location in a vehicle where strong vibration, unstable, excessive of humidity and dust, and under direct sunlight can be avoid. Also, avoid the area where the air bag inflates or any other area where your safe driving is blocked.
- Do not leave the Handheld Terminal in vehicle for a long period of time.

Optional Lithium-ion Battery Pack

Danger

-  • Never use the Handheld Terminal and its option including the battery pack and battery next to open flame, near a stove, or any other area exposed to high heat, or leave them for a long period of time in a vehicle parked in direct sunlight.
- Never use the battery pack with any device other than the Handheld Terminal.
- Never dispose of the battery pack by incinerating it or otherwise expose it to heat.
- Never transport or store the battery pack together with metal objects that may result in shorting positive (+) and negative (-) terminals of the battery pack. Be sure to place the battery pack in its case whenever transporting or storing it.
- Never throw the battery pack or otherwise subject it to strong impact.
- Never pierce the battery pack with nails, hit it with a hammer, or step on it.
-  • Use only the specified battery charger to charge the battery pack.

Warning



-  • Never place the battery pack in a microwave oven or any other high-voltage device.
-  • If the amount of time period the battery pack can serve becomes considerably short even after it has been fully charged for the specified time period, stop using it.
- Should the battery pack start to leak or emit a strange odor, immediately move it away from any flame nearby. Leaking battery fluid is combustible.
- Should fluid from the battery pack accidentally get into your eyes or on the skin, do not rub it. Immediately rinse it off with clean tap water and then consult a physician.

Caution





-  • Replace only with the same type of battery pack recommended by CASIO. Dispose of used battery packs according to the local regulation.
- Keep the battery pack out of the reach of small children.

Power Supply / AC Adaptor

Warning

-  Do not use the Handheld Terminal at a voltage other than the specified voltage. Also, do not connect the Handheld Terminal to a multi-plug power strip.
- Never modify, sharply bend, twist, or pull on the power cord.
- Never use a detergent to clean AC adaptor and its power cable, especially on the plug and the jack.
-  When using the battery chargers and the cradles, be sure to use the respective AC adaptors.

Caution

-  Never pull on the power cord when unplugging it. Always hold the plug when unplugging it from the wall outlet.
- Never touch the plug while your hands are wet.
-  Be sure to unplug the power cord from the wall outlet before cleaning the battery chargers and the cradles.
- Unplug the power cord from the wall outlet whenever leaving the battery chargers and the cradles unattended for a long period.
-  The housing of the AC adaptor can become warm during normal use.
-  At least once a year, unplug the AC adaptor from the wall outlet and clean any dust that builds up between the prongs of the plug. Dust built up between the prongs can lead to the danger of fire.

Backup of All Important Data

Caution

-  Note that CASIO Computer Co., Ltd. shall not be held liable to you or any third party for any damages or loss caused by deletion or corruption of data due to use of the Handheld Terminal, malfunction or repair of the Handheld Terminal or its peripherals, or due to the batteries going dead.
- The Handheld Terminal employs electronic memory to store data, which means that memory contents can be corrupted or deleted if power is interrupted due to the batteries going dead or incorrect battery replacement procedures. Data cannot be recovered once it is lost or corrupted. Be sure to make backup of all important data. One way to do this is to use the separately sold cradles to transfer data to a computer.

Operating Precautions

Your Handheld Terminal and its options are precision. Improper operation or rough handling can cause problems with data storage and other problems. Note and observe the following precautions to ensure proper operation.

- **Do not leave dead battery pack in the Handheld Terminal for a long period.**

Dead battery pack can leak, leading to malfunction and damage to the Handheld Terminal.

- **Stop or avoid using the Handheld Terminal and its options in areas and conditions subject to the following.**

- Large amounts of static electricity
- Extreme heat or cold or humidity
- Sudden temperature change
- Large amount of dust
- After large amount of rain or water falls on the Handheld Terminal
- Pressing the screen or keys with excessive force when using in the rain

- **Dead Pixels**

The LCD panel employed in this product uses high precision and substantial number of components which commonly cause a small number of the pixels not to light or to remain lit all the time. This is due to the characteristics of LCD panel yield in accuracy over 99.99% and permissible.

Important

- This guide does not include any information about programming and download procedures. See the applicable separate documentation for information about the procedures.

After Service

- Should this product ever malfunction, contact your original retailer providing information about the product name, the date you purchased it, and details about the problem.



This mark applies to EU countries and Turkey only.

Regulatory Information

The USA and Canada

GUIDELINES LAID DOWN BY FCC RULES FOR USE OF THIS UNIT IN THE U.S.A. (not applicable to other areas).

NOTICE

This equipment has been tested and found to comply with the limits for a Class B digital device, pursuant to Part 15 of the FCC Rules. These limits are designed to provide reasonable protection against harmful interference in a residential installation. This equipment generates, uses and can radiate radio frequency energy and, if not installed and used in accordance with the instructions, may cause harmful interference to radio communications. However, there is no guarantee that interference will not occur in a particular installation. If this equipment does cause harmful interference to radio or television reception, which can be determined by turning the equipment off and on, the user is encouraged to try to correct the interference by one or more of the following measures:

- Reorient or relocate the receiving antenna.
- Increase the separation between the equipment and receiver.
- Connect the equipment into an outlet on a circuit different from that to which the receiver is connected.
- Consult the dealer or an experienced radio/TV technician for help.

FCC WARNING

Changes or modifications not expressly approved by the party responsible for compliance could void the user's authority to operate the equipment.

Proper connectors must be used for connection to host computer and/or peripherals in order to meet FCC emission limits.

Caution Exposure to radio frequency radiation (below is for portable device)

To comply with FCC RF exposure compliance requirements, this device must not be co-located or operating in conjunction with any other antenna or transmitter.

Declaration of Conformity

Model Number: HA-H60IO, HA-H62IO
Trade Name: CASIO
Responsible party: Industrial Handheld Division
Casio America, Inc.
Address: 570 Mt. Pleasant Avenue, Dover, New Jersey 07801, USA
Telephone number: 973-361-5400



This device complies with Part 15 of the FCC Rules. Operation is subject to the following two conditions:
(1) This device may not cause harmful interference, and (2) this device must accept any interference received, including interference that may cause undesired operation.

For Users in Canada

These Class B digital apparatuses comply with Canadian ICES-003.

Cet appareil numérique de la classes B est conforme à la norme NMB-003 du Canada.

These devices comply with RSS 210 of Industry Canada (IC).

Operation is subject to the following two conditions:

- (1) These devices may not cause interference, and
- (2) These devices must accept any interference, including interference that may cause undesired operation of this device.

L' utilisation de ce dispositif est autorisée seulement aux conditions suivantes :

(1) il ne doit pas produire de brouillage et

(2) l' utilisateur du dispositif doit être prêt à accepter tout brouillage radioélectrique reçu, même si ce brouillage est susceptible de compromettre le fonctionnement du dispositif.

Exposure to radio frequency radiation

The installer of this radio equipment must ensure that the antenna is located or pointed such that it does not emit RF field in excess of Health Canada limits for the general population; consult Safety Code 6, obtainable from Health Canada's website at http://www.hc-sc.gc.ca/ewh-semt/pubs/radiation/99ehd-dhm237/index_e.html

Europe

Products are for distribution within all member states of the EU.

CE 0984 

France limited to 2446.5-2483.5 MHz Indoor use.

Belgium limited to 2400-2483.5 MHz Indoor, 2460-2483.5 MHz Outdoor use.

Optional models HA-H60IO, HA-H62IO, HA-H30CHG, HA-H35CHG, HA-D32DCHG, HA-D20BAT and HA-D21LBAT are in conformity with the Council Directive 2004/108/EC.

CE

Manufacturer:

CASIO COMPUTER CO., LTD.

6-2, Hon-machi 1-chome, Shibuya-ku, Tokyo 151-8543, Japan

Representative within the European Union:

CASIO EUROPE GmbH

Casio-Platz 1, 22848 Norderstedt, Germany

Declaration of compliance with other relevant standards can be referred to at

http://world.casio.com/system/pa/UsersGuide/sup85_e.html.

Handheld Terminal System Configuration

IT-800 Series



The hand belt is attached on the back of the terminal. Set the hand belt in proper length by adjusting the hook-loop fastener prior to using the terminal.

Bundled Items

Please check the items in the box before using the Handheld Terminal for the first time.

Handheld Terminal

Stylus



The stylus can be attached to the hand belt.

Neck Strap

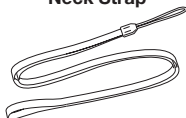

Large-capacity Battery Pack Cover



User's Guide (this manual)

Options

USB Cradle

HA-H60IO

The illustration shows the USB Cradle (HA-H60IO).

Ethernet Cradle

HA-H62IO

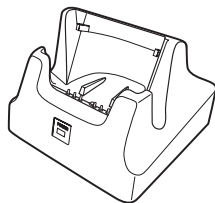

Cradle-type Battery Charger

HA-H30CHG

Car Mounted-type Battery Charger

HA-H35CHG

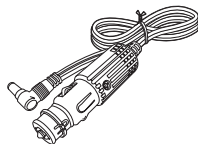
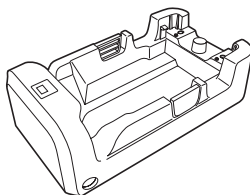

The car power cable accompanies to HA-H35CHG.

For the latest options list, refer to the ON-LINE manual available at http://world.casio.com/system/pa/UsersGuide/sup85_e.html

Options

Battery Pack

HA-D20BAT
(Battery Pack)

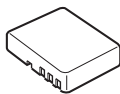

HA-D21LBAT
(Large-capacity Battery Pack)

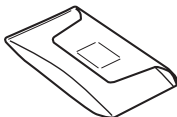
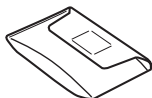
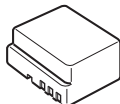

Dual Battery Charger

HA-D32DCHG

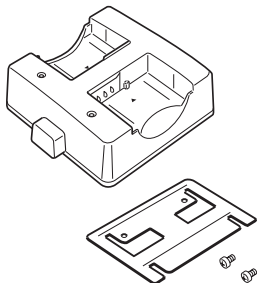

**AC Adaptor for USB Cradle/
Ethernet Cradle/
Dual Battery Charger**
AD-S42120B-N

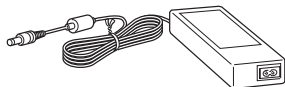

**AC Adaptor for IT-800/
Cradle-type Battery Charger**
AD-S15050B-N



Power Cord for Europe	AC-CORD-EU
Power Cord for North America	AC-CORD-US
Power Cord for Taiwan	AC-CORD-TW
Power Cord for Korea	AC-CORD-KR
Power Cord for Australia	AC-CORD-AU

Cable DT-380USB



Screen Protect Sheet
HA-C90PS5B



General Guide

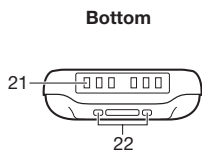
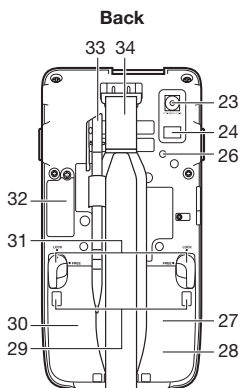
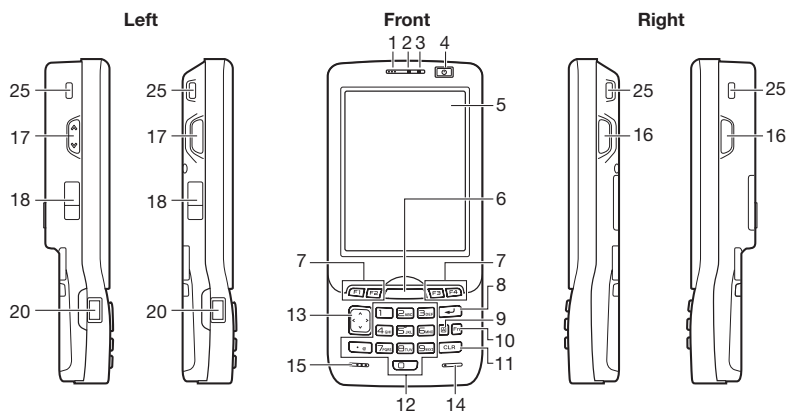
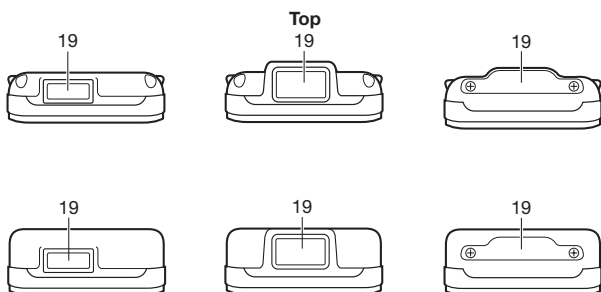

IT-800E:

Include Bluetooth only

IT-800G:

Include Bluetooth and WAN Module
 These models are available in the USA
 and Canada only.

1	Receiver	12	Numeric Keys	23	Camera Lens (Camera models)
2	Indicator 1	13	Cursor Key	24	LED (Camera models)
3	Indicator 2	14	Microphone	25	Car Mounted-type Battery Charger Mount Holes
4	Power Key	15	Speaker	26	Reset Switch
5	Screen*	16	R Trigger Key	27	microSD Card Slot (for IT-800R-15/RC-15/RGC-15/ R-35/RC-35/RGC-35/EC-05/GC-05)
			R Enter Key (for IT-800R-05/EC-05/ RGC-05/GC-05)		
6	Center Trigger Key	17	L Trigger Key	28	Battery Pack Cover
	Center Key (for IT-800R-05/EC-05/ RGC-05/GC-05)		Up/Down Key (for IT-800R-05/EC-05/ RGC-05/GC-05)		
7	Function Keys	18	DC Jack	29	Cradle Mount Holes
8	Enter Key	19	Barcode Reader	30	SIM Card Slot (for IT-800RGC-05/RGC-15/ RGC-35/GC-05/GC-35)
			SD Card Slot (for IT-800R-05/EC-05/ RGC-05/GC-05)	31	Battery Pack Cover Lock Switches
9	Mode Key	20	IR Port	32	Expansion Port
10	Fn Key	21	Power/Signal Terminals	33	Stylus
11	CLR Key	22	Strap Holes	34	Hand Belt

*Antenna of the NFC is laid underneath of the screen frame for communication with NFC card.

Loading and Removing the Battery Pack

Your Handheld Terminal uses two types of battery: a battery pack and a memory backup battery.

The battery pack is used to power normal operations and to store data, while the memory backup battery provides the power required to maintain memory contents when the battery pack power is unable to supply power for some reason.

You can choose either battery pack (HA-D20BAT) or large-capacity battery pack (HA-D21LBAT) for operating power.

The backup battery is installed inside of the Handheld Terminal.

This guide uses the following terms to refer to the batteries.

Battery Pack: Rechargeable battery pack (HA-D20BAT or HA-D21LBAT) for normal operations and data storage

Backup Battery: Built-in battery for memory backup

When the battery pack power goes low, immediately charge it or replace it with a charged battery pack.

You can use the Dual Battery Charger, the Cradle-type Battery Charger, the USB Cradle, the Ethernet Cradle, the Car Mounted-type Battery Charger, or the AC adaptor to charge a battery pack installed in the terminal. See the sections of this guide that cover the Dual Battery Charger, the Cradle-type Battery Charger, the USB Cradle, the Ethernet Cradle, the Car Mounted-type Battery Charger, and the AC adaptor for information about how to use them for charging.

Important!

Always keep backup of all important data!

- **The battery pack powers normal operation and also provides power required to maintain memory contents, while the backup battery provides backup power to maintain memory contents. Because of this, you should not remove the battery pack if the backup battery is dead. Removing the battery pack while the backup battery is dead causes data in the memory to be corrupted or lost. Note that once data is lost it cannot be recovered. Always keep backup of all important data.**
- **The charge of a battery pack when you purchase it may be depleted due to testing at the factory or natural discharge during shipment and storage. Be sure to charge the battery pack before you use it.**
- **The life of a battery pack is limited, and charging a battery pack causes it to gradually lose its ability to maintain the charge. If your battery pack seems to require charging very frequently, it probably means it is time to purchase a new one.**
- **If a battery pack is used past the end of its service life, it may swell up in size. In such a case, replace the battery pack with a new one.**
- **When the battery pack is attached, it takes 30 minutes for the backup battery to obtain enough charge for maintaining memory (RAM) contents for 10 minutes. It takes four days for the backup battery to achieve a full charge.**

Loading

1. Turn the terminal upside down and loosen the hand belt.

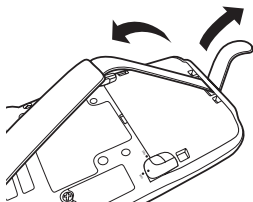

2. Slide the left and right lock switches for the battery pack cover to the “FREE” position, and then remove the battery pack cover.

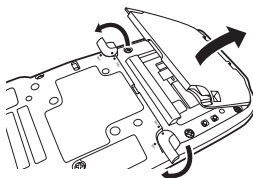

3. Load a battery pack (HA-D20BAT) or large-capacity battery pack (HA-D21LBAT). Take care that the battery pack is oriented correctly when you load it. In addition, load the battery pack while making sure that the end of the battery pack removal tape is protruding above the battery pack.

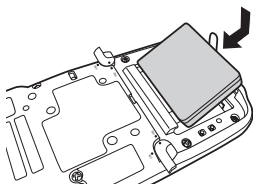

4. Put back the battery pack cover in the compartment as instructed by the arrows, ① and ② in the illustration and then return the battery pack cover lock switches to the “LOCK” position (③).

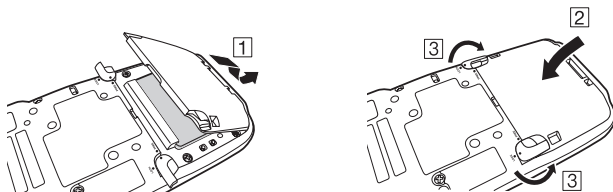

Removing

1. Make sure that the Handheld Terminal is turned off.
If the power is on, press the power key to turn it off.
2. Turn the terminal upside down and loosen the hand belt.
3. Refer to “Loading” on the previous page and remove the battery pack cover.
4. Remove the battery pack by pulling up the removal tape as shown in the illustration.

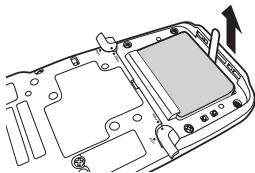

Loading the large-capacity battery pack into the Handheld Terminal

After loading the large-capacity battery pack, you need to use the special large-capacity battery pack cover in place of the standard battery pack cover.

“Loading and Removing” of the large-capacity battery pack cover is the same as those for the standard battery pack cover.

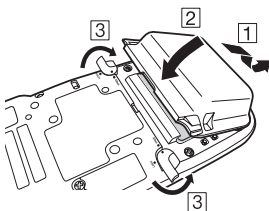

Important!

- When removing the battery pack, make sure you do not leave the Handheld Terminal without a battery pack for more than about 10 minutes. Doing so can cause data in the memory to be deleted.
- When removing the battery pack, be sure you carefully follow the proper procedure as explained in this guide.
- Never try to use other type of battery than the ones that are specified for this product.
- When removing the battery pack, pull the removal tape straight up and remove the battery pack. Removing with excessive force can damage the battery pack.
- Before starting to use the Handheld Terminal, ensure that the battery pack cover is properly closed. If not, the power is not turned on or is turned off abruptly while it is in use.

Charging the Battery Pack

Battery pack installed in the terminal can be charged using either cradle, battery charger or AC adaptor (AD-S15050B). Battery charge condition can be monitored with Indicator 1 on the terminal. Multiple battery packs can also be charged simultaneously using Dual Battery Charger.

USB Cradle/Ethernet Cradle/Cradle-type Battery Charger

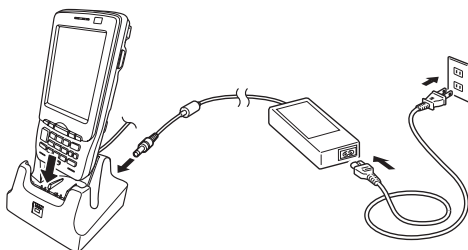

Status of Indicator 1 on IT-800:

Orange: Charging

Red: Standby due to battery pack error or the surrounding temperature is out of the charging temperature range
(charging begins when the temperature is within the charging temperature range)

Green: Charging complete

Car Mounted-type Battery Charger

Before the use of the Car Mounted-type Battery Charger for WWAN models, remove a small plate (see the figure below) on the charger.

For other models, you do not need to remove the plate. Proceed the step below.

Plug in the Car Power Cable accompanied in the box to the Car Mounted-type Battery Charger as illustrated below and the other end to the cigarette lighter socket in vehicle. The power LED on the front of the Car Mounted-type Battery Charger will light green if the Handheld Terminal has been properly mounted.

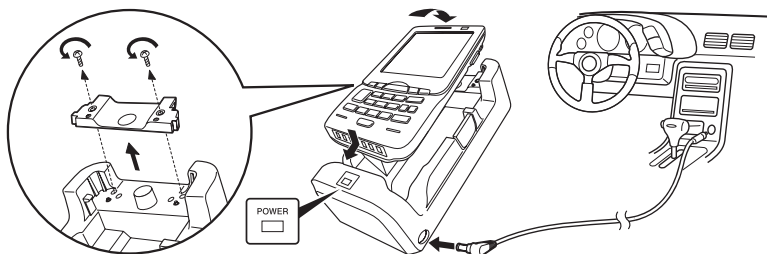

Status of Indicator 1 on IT-800:

Refer to "USB Cradle/Ethernet Cradle/Cradle-type Battery Charger" above.

Dual Battery Charger

Taking care that the battery pack is oriented correctly, insert it into the Dual Battery Charger.

This causes the Charge Indicator LED to light in red, indicating that charging has started.

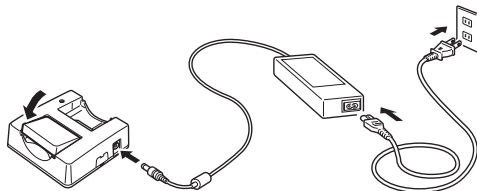

You can connect up to three Dual Battery Chargers.

Status of Charge Indicator LED

Off: Not charging

Red: Charging

Red Flashing: Battery pack problem

Green: Charging complete

Green Flashing: Standby due to the surrounding temperature being beyond the specified temperature range (Approximately 0°- 40°C) (charging resumes when the temperature reaches the range.)

AC Adaptor

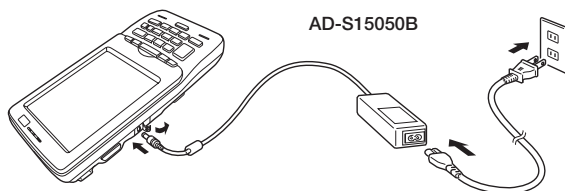

Status of Indicator 1 on IT-800:

Refer to “USB Cradle/Ethernet Cradle/Cradle-type Battery Charger” on the previous page.

Handling the Hand Belt

The hand belt is attached to the terminal. Remove it if it is not necessary.

To remove the hand belt

1. As shown in the figure, pull out the metal part of the hook while pressing down the protrude part.

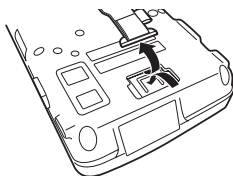

2. Loosen the hook-loop fastener and then pull out the belt through the hand belt hook as shown in the figure.

To attach the hand belt

1. Thread one end of the hand belt through the hand belt hook. Then fold it back and set the belt in proper length by adjusting the hook-loop fastener.

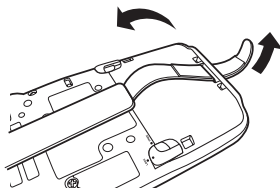

2. As shown in the figure, align the metal part of the hand belt hook in line with the installation position on the terminal and then snap it into the ditch. Make sure that the metal part is firmly seated.

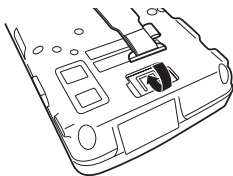

Attaching the Neck Strap

The neck strap can be used to prevent the Handheld Terminal from dropping when carrying it around. Since there are two strap holes where the neck strap can be attached, use the hole that affords the ease of use. Attach the neck strap according to the procedure described below.

To attach the neck strap

1. Pass the thin cord of the neck strap through the strap hole on the back of the Handheld Terminal.

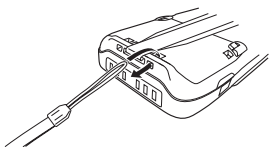

2. Pass the other end of the strap (the part you put around your neck) through the loop formed by the thin cord.

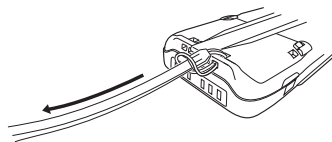
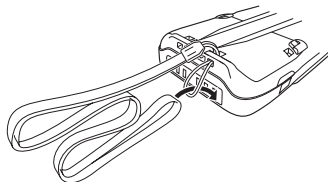

Important!

Do not swing the Handheld Terminal around holding the neck strap.

Configuring Handheld Terminal Settings

Calibrating Touch Screen Alignment

Whenever the response of the touch screen is poor, or the operations being executed do not match with the location you are tapping on the touch screen, please recalibrate the alignment of the touch screen using the following method.

- Press the “Fn” key and then press the “4” key after confirming that “F” is displayed in the lower right corner of the screen. The following screen is displayed.
- * You can also display this screen by navigating as follows:
Start → Settings → System → Screen → Align Screen

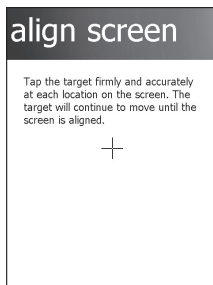

- Press the stylus against the center of the target mark (+ mark) as indicated on the screen.

After the calibration is complete, the terminal resumes a screen automatically according to the method carried out to initiate the calibration.

If you start the calibration by pressing "Fn" and "4" keys, the terminal resumes Start screen, or General tab screen of Settings mode which is the screen one before align screen of Settings mode if you initiate by navigating to the icons.

Adjusting the Laser Light Emission Width

The emission width of the laser light emitted by the Handheld Terminal (model dependant) can be adjusted. Adjust the emission width when it is improper.

1. Tap the menus in the following sequence:

Start → Settings → System

The Control Panel appears as shown in the screen.

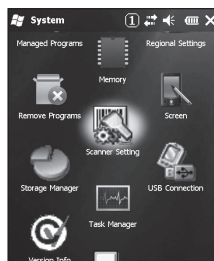

2. Tap the [Scanner Setting] icon. The Setting screen appears as shown in the screen.

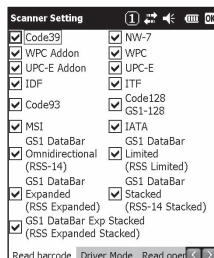

3. Tap the [Others] tab in the Scanner Setting screen.

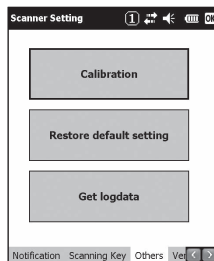

4. Tap the [Calibration] button. The display appears as shown at right.

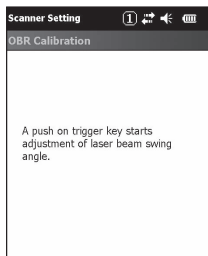

5. Press the Trigger Key to emit laser light, and align the light with the barcode for adjusting emission width.

- Align the laser light with the narrow bars on both sides.
- The message appears as shown at right when adjustment is completed.
- Repeat the setting if "Setting failed" message appears.

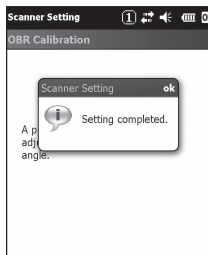

Emission Width Adjustment Bar code

Handling microSD Cards

The Handheld Terminal supports microSD card.

The employment of microSD card is dependent on model. See page 13 for the models with microSD card integrated.

Since the microSD card slot is located inside the battery pack compartment, first remove the battery pack when installing or removing a microSD card.

Refer to pages 14 to 16 for information on “Loading and Removing the Battery Pack”.

Install (or replace) a microSD card according to the procedure described below.

Installing

1. Make sure that the power on the terminal has been switched off. If the power is still on, press the power key to switch off the power.
2. Remove the battery pack.
3. Insert microSD card with the description side face up.
 - Make sure that the card is pushed into the slot until the small plastic spring plate is rebounded so that the plate can firmly lock the card in the slot.
 - Avoid inserting the card diagonally.

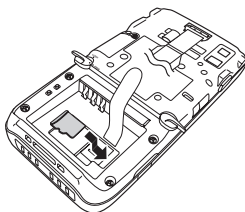

4. Load the battery pack.

Removing

1. Make sure that the power on the terminal has been switched off. If the power is still on, press the power key to switch off the power.
2. Remove the battery pack.
3. As shown in the figure, pull out the card while pressing down the small plastic spring plate.

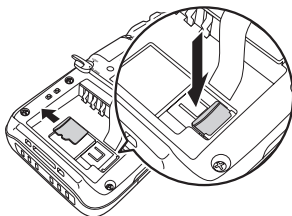

4. Load the battery pack.

Important!

- A microSD card must be inserted with the top and bottom properly aligned and in the proper direction. Attempt in inserting it with an excessive force in incorrect orientation can risk damage to the connectors and slot.
- The battery pack will not be able to be properly installed if the microSD card is not properly installed. Reinstall the microSD card properly if this happens.
- Since data recorded in the Handheld Terminal may be lost if the battery pack is removed for more than 10 minutes, complete the installation (or removing) of microSD card within 10 minutes.
- Never turn off the power or remove a microSD card from the slot while the card is being accessed. Doing so can damage the microSD card or data in the card.
- Do not drop the card or lose it.

Handling SIM Cards

The Handheld Terminal supports SIM card.

The employment of SIM card is dependent on model. See page 13 for the models with SIM card integrated.

Since the SIM card slot is located inside the battery pack compartment, first remove the battery pack when installing or removing a SIM card.

Refer to pages 14 to 16 for information on “Loading and Removing the Battery Pack”.

Install (or replace) a SIM card according to the procedure described below.

Installing

1. Make sure that the power on the terminal has been switched off. If the power is still on, press the power key to switch off the power.
2. Remove the battery pack.
3. Put your finger's nail into the slit of the plastic holder, and then lift it up. See the figure below.

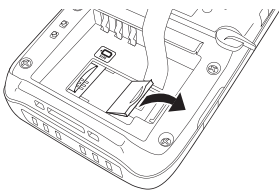

4. Load SIM card by sliding into the SIM card slot.

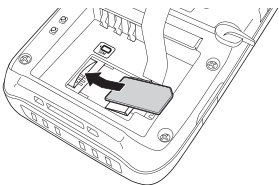

5. Make sure that the card has been inserted firmly and then put back the plastic holder to its home position until you hear a click sound.

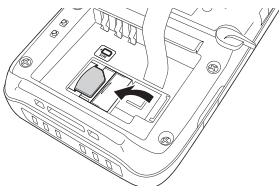

6. Load the battery pack.

Removing

1. Make sure that the power on the terminal has been switched off. If the power is still on, press the power key to switch off the power.
2. Remove the battery pack.
3. Put your finger's nail into the slit of the plastic holder, and then lift it up. See the figure below.

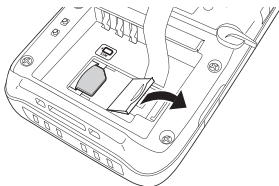

4. Pull the SIM card out of the slot by sliding it to the direction shown by the arrow. See the figure below.

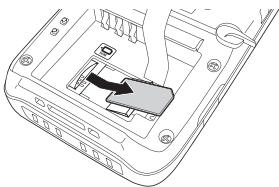

5. Put back the plastic holder to its home position until you hear a click sound.
6. Load the battery pack.

Important!

- A SIM card must be inserted with the top and bottom properly aligned and in the proper direction. Attempt in inserting it with an excessive force in incorrect orientation can risk damage to the connectors and slot.
- The battery pack will not be able to be properly installed if the SIM card is not properly installed. Reinstall the SIM card properly if this happens.
- Since data recorded in the Handheld Terminal may be lost if the battery pack is removed for more than 10 minutes, complete the installation (or removing) of SIM card within 10 minutes.

Handling SD Memory Cards

SD memory card can be installed in the SD Memory Card slot on the Handheld Terminal.

The employment of SD memory card is dependent on model. See page 13 for the models with SD memory card integrated.

Install (or remove) an SD memory card according to the procedure described below.

Installing

1. Open the cover of the SD memory card slot (1) and insert an SD memory card all the way in until the top of the SD memory card aligns with the entrance of the slot of the Handheld Terminal (2).

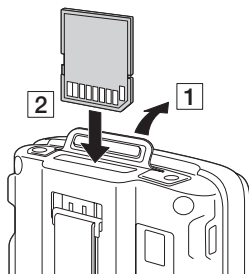

2. Close the cover of the SD memory card slot.

Important!

- An SD memory card must be inserted with the top and bottom properly aligned and in the proper direction. Attempt in inserting it with an excessive force in incorrect orientation can risk damage to the connectors and slot.
- Never turn off the power or remove an SD memory card from the slot while the card is being accessed. Doing so can damage the SD memory card or data in the card.
- Do not drop the card or lose it.

Removing

1. Open the cover of the SD memory card slot and press on the SD memory card (1). The SD memory card is pushed out (2).

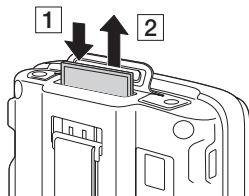

2. Pull out the SD memory card and close the cover of the SD memory card slot.

Resetting the Handheld Terminal

Resetting the terminal is the same as restarting a PC. Performing a reset causes all unsaved RAM data that are in mid-course of inputting and editing to be lost, but data and settings that are already stored in the FlashROM should be unaffected. Perform a reset to restore normal operation whenever the Handheld Terminal operates abnormally due to misoperation or some other reason.

Use a stylus to press the reset switch on the back of the IT-800.

This starts the reset operation.

- * Do not use a toothpick or pencil or other sharp object whose tip may break off the reset switch.

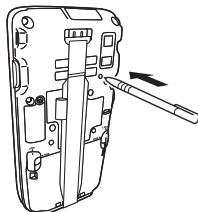

Performing a Full Reset (Initialization)

Performing a full reset deletes all data and resets various settings to their defaults.

*Data stored in the Flashdisk folder remain unaffected.

Perform a full reset whenever any one of the following conditions exists.

- When you want to delete installed programs and settings, and resume the terminal to the initial condition.
- When you are no longer able to use the Handheld Terminal because you forgot your password.
- When the Handheld Terminal does not operate normally due to a memory problem.

To perform a full reset

Important!

Performing a full reset resets all data to their defaults except stored in the Flashdisk folder. If possible, backup data of the terminal to a PC or to the Flashdisk folder. The reset procedure and display message appeared on performing the reset is according to the model you operate.

1. Hold down Fn key and CLR key while pushing down the reset switch for about 3 seconds with the tip of a stylus until the message shown below appears on the display.
 - To cancel the full reset operation, press L Trigger key on the scan engine integrated models or Up key on the non-scan engine integrated models.

Message appeared on the scan engine integrated models.

*Full Reset Warning
The following operation
initializes the Root Disk.
Press the [R Trigger key] to proceed
or the [L Trigger key] to cancel.*

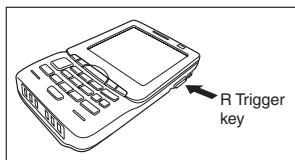

Message appeared on the non-scan engine integrated models.

*Full Reset Warning
The following operation
initializes the Root Disk.
Press the [R-Enter key]
on the right side to proceed
or the [Up key] on the left side to cancel.*

2. Press R Trigger key on the scan engine integrated models or R Enter key on the non-scan engine integrated models. This causes the message shown below to appear.
 - To cancel the full reset operation, press L Trigger key on the scan engine integrated models or Up key on the non-scan engine integrated models.

Message appeared on the scan engine integrated models.

*Full Reset Warning
The following operation deletes all data
stored in the Root Disk.
Press the [R Trigger key] to proceed
or the [L Trigger key] to cancel.*

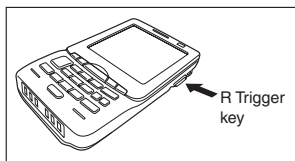

Message appeared on the non-scan engine integrated models.

*Full Reset Warning
The following operation deletes all data
stored in the Root Disk.
Press the [R-Enter key]
on the right side to proceed
or the [Up key] on the left side to cancel.*

3. Press R Trigger key or R Enter key again to perform the full reset.
 - The full reset starts and all data in the memory are erased, and the start-up screen appears.
Data stored in the Flashdisk folder remain unaffected.

Warning Label

Warning!

■ Never look directly into the laser light.

-  • These products scan using laser light. Never look directly into the laser light or shine the laser light into the eyes.

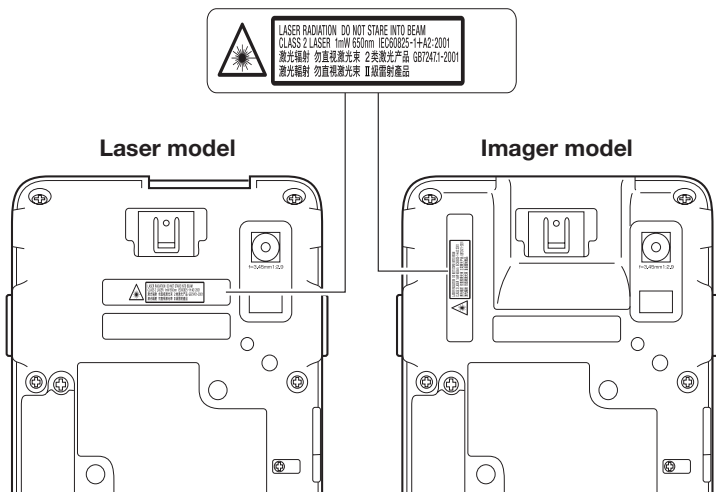

- This label is a warning and caution label for Class 2 laser products that comply with IEC60825-1:1993+A1:1997+A2:2001.
- Although Class 2 laser light is only emitted momentarily, never look directly into the beam light.
- The laser light emitted by this laser scanner has a maximum output of less than 1 mW and a wavelength of 650 nm.
- Use of controls or adjustments or performance of procedures other than those specified herein may result in hazardous radiation exposure.

USB Cradle (HA-H60IO), Ethernet Cradle (HA-H62IO)

General Guide

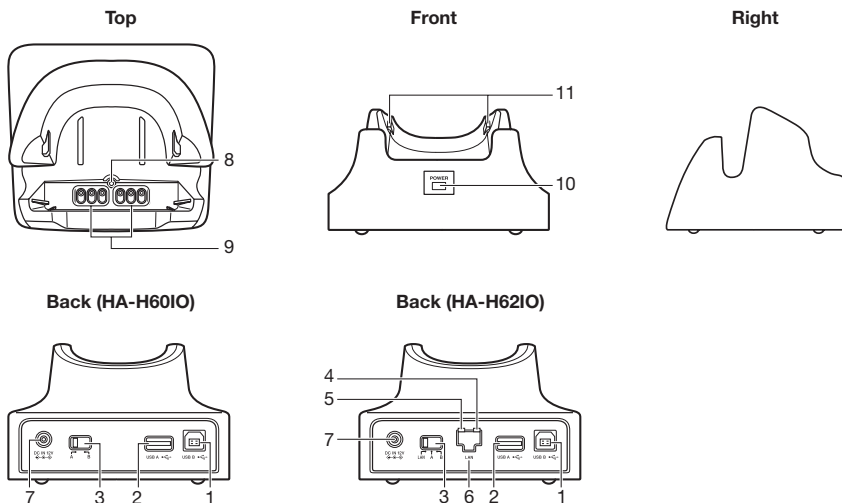

1	USB Client Port	5	LAN Communication Status LED	9	Power/Signal Terminals
2	USB Host Port	6	LAN Port	10	Power Indicator LED
3	Selector Switch	7	AC Adaptor Jack	11	Mount Hooks
4	LAN Connection Status LED	8	Terminal Detect Switch		

Cradle-type Battery Charger (HA-H30CHG)

General Guide

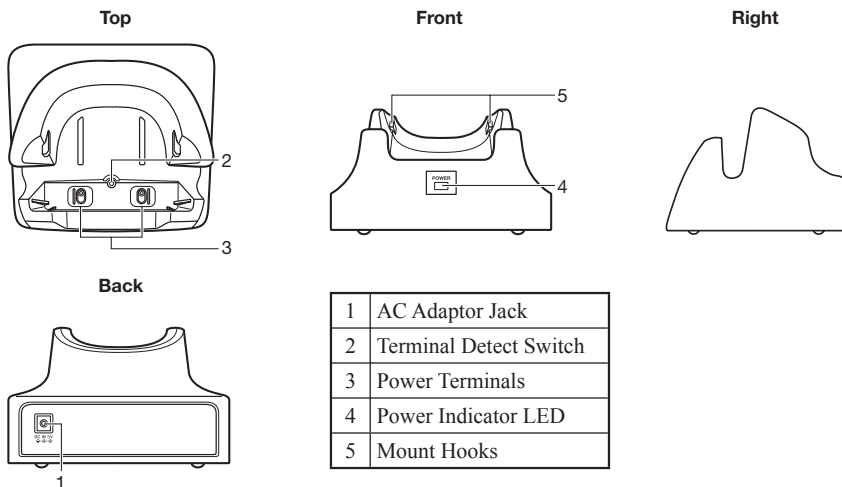

Car Mounted-type Battery Charger (HA-H35CHG)

General Guide

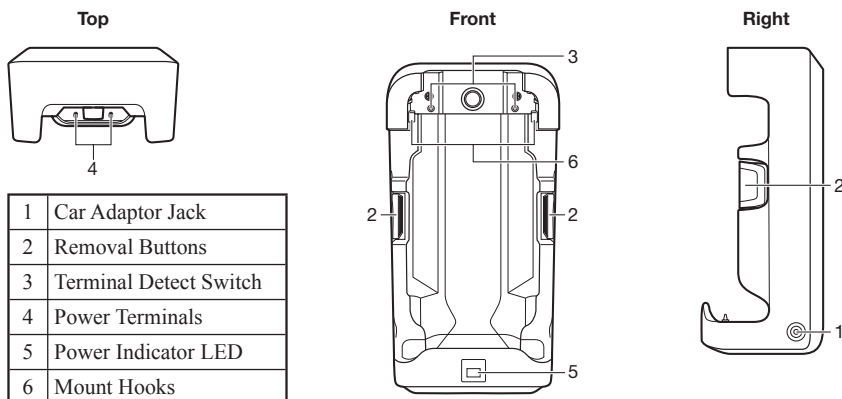

Before the use of this charger for battery pack installed in WWAN models, see the battery charge instruction on page E-17.

Dual Battery Charger (HA-D32DCHG)

General Guide

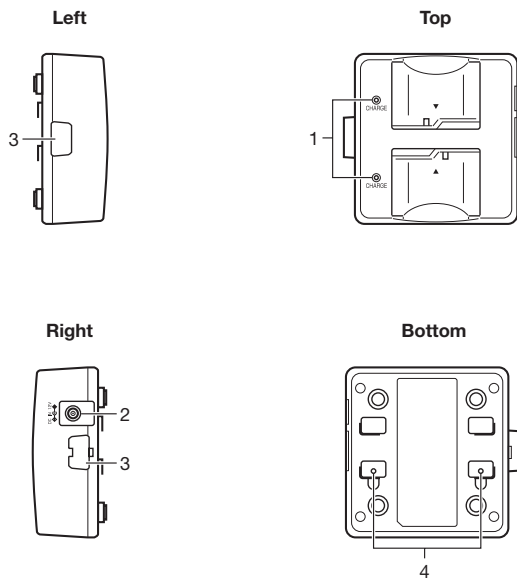

1	Charge Indicator LED
2	AC Adaptor Jack
3	Dual Battery Charger Connection Port
4	Connection Bracket Attachment Holes

Connecting Multiple Dual Battery Chargers

1. As shown in the illustrations below, remove the connector covers of the Dual Battery Chargers you want to connect to each other.

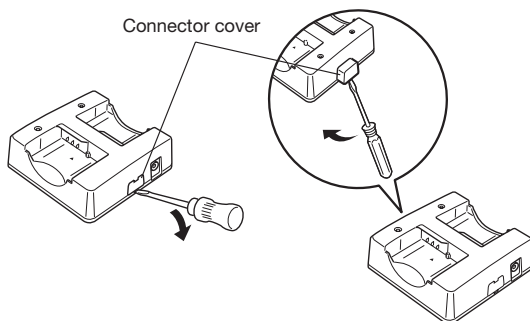

2. Connect the two Dual Battery Chargers as shown below.

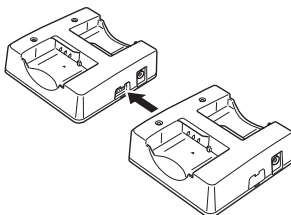

3. Turn over the connected Dual Battery Chargers and attach a connection bracket, securing it in place with screws.

You can repeat the above steps to connect up to 3 Dual Battery Chargers.

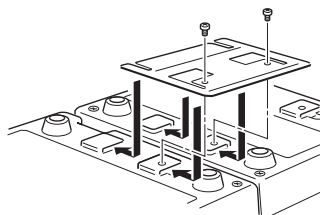

CASIO®

CASIO COMPUTER CO., LTD.

6-2, Hon-machi 1-chome
Shibuya-ku, Tokyo 151-8543, Japan



PN410438-001

Printed on recycled paper.

MO0910-001001A

PN410438-001
Printed in Japan