

CASIO®

Handheld Terminal **IT-G500** Series

User's Guide

Be sure to read "Safety Precautions" inside this guide before trying to use your Handheld Terminal.

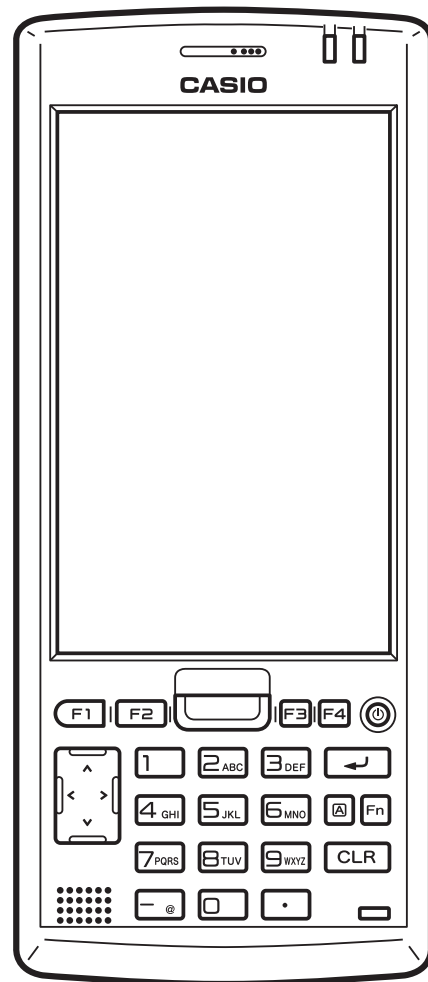

 **Bluetooth**[®]

- BLUETOOTH is a registered trademark owned by Bluetooth SIG, Inc. and licensed to CASIO COMPUTER CO., LTD.
- Microsoft and Windows are either registered trademarks or trademarks of Microsoft Corporation in the United States and/or other countries.
- “FeliCa” is a contactless IC card technology developed by SONY Corporation and a registered trademark of SONY Corporation.

Information in this document is subject to change without advance notice. CASIO Computer Co., Ltd. makes no representations or warranties with respect to the contents or use of this manual and specifically disclaims any express or implied warranties of merchantability or fitness for any particular purpose.

Contents

Safety Precautions	E-3
Operating Precautions	E-8
Regulatory Information	E-9
About the Waterproofing/Dustproofing	E-12
Important	E-13
After Service	E-13
Accessories and Options	E-14
General Guide	E-15
Loading and Removing the Battery Pack	E-18
Loading	E-19
Removing	E-19
Charging the Battery Pack	E-21
USB Cradle/Ethernet Cradle/Cradle-type Battery Charger	E-21
Dual Battery Charger	E-21
Handling the Hand Belt	E-22
To remove the hand belt.....	E-22
To attach the hand belt	E-22
Handling the Stylus	E-23
Placing the stylus in the holder	E-23
Connecting the Stylus String	E-24
Attaching the Neck Strap	E-26
To attach the neck strap.....	E-26
Configuring Handheld Terminal Settings	E-27
Calibrating Touch Screen Alignment	E-27
Adjusting Display Brightness	E-28
Display Auto Dimmer	E-28
Using the Laser Scanner (Laser Models)	E-29
Using the C-MOS Imager (Imager Models)	E-30
Adjusting the Laser Light Emission Width	E-31
Handling the NFC	E-33

Performing Communications	E-34
Bluetooth® Communication	E-34
GSM/W-CDMA Communication	E-35
GPS	E-35
Handling microSD Cards	E-36
Installing.....	E-36
Removing.....	E-36
Handling microSIM Cards.....	E-37
Installing.....	E-37
Removing.....	E-38
Using the microSD Hard Cover (IT-G500-GC21E only).....	E-39
Attaching the microSD Hard Cover to the Handheld Terminal.....	E-39
Resetting the Handheld Terminal.....	E-40
Performing a Full Reset (Initialization)	E-40
Warning Label	E-42
IT-G500 Specifications	E-43
Using the USB Cradle (HA-P60IO), Ethernet Cradle (HA-P62IO), Cradle-type Battery Charger (HA-P30CHG).....	E-52
General Guide	E-52
Connecting the Cradle Power Supply	E-54
Ethernet Cradle Specifications (HA-P62IO).....	E-56
USB Cradle Specifications (HA-P60IO).....	E-57
Cradle-type Battery Charger Specifications (HA-P30CHG)	E-58
Using the Dual Battery Charger (HA-D32DCHG)	E-59
General Guide	E-59
Charging a Battery Pack.....	E-61
Connecting Multiple Dual Battery Chargers.....	E-62
Specifications	E-63
Using the microUSB.....	E-64
Connecting to a Computer	E-64
Using Rechargeable Battery Packs.....	E-65
Battery Pack Specifications.....	E-65
Large-capacity Battery Pack Specifications.....	E-65
Using the Protector (HA-P91BP5, HA-P92BP5)	E-66
Fitting the protector onto the Handheld Terminal.....	E-66
Removing the protector from the Handheld Terminal	E-66

Safety Precautions

Congratulations upon your selection of this CASIO product. Be sure to read the following Safety Precautions before trying to use it for the first time.

Your neglect or avoidance of the warning and caution statements in the subsequent pages causes the danger of fire, electric shock, malfunction and damage on the goods as well as personal injury.

Markings and Symbols

The following are the meanings of the markings and symbols used in these Safety Precautions.

 Danger	This symbol indicates information that, if ignored or applied incorrectly, creates the danger of death or serious personal injury.
---	--

 Warning	This symbol indicates information that, if ignored or applied incorrectly, creates the possibility of death or serious personal injury.
---	---

 Caution	This symbol indicates information that, if ignored or applied incorrectly, creates the possibility of personal injury or property damage.
--	---



- A diagonal line indicates something you should not do. The symbol shown here indicates you should not try to take the unit apart.



- A black circle indicates something you should do. The symbol shown here indicates you should unplug the unit from the wall outlet.

Warning

Disassembly and Modification



- Never try to disassemble or modify the Handheld Terminal and its options including battery pack and battery in any way.

Abnormal Conditions



- Should the Handheld Terminal and/or its options including battery pack and battery become hot or start to emit smoke or a strange odor, immediately turn off the power and contact your dealer or distributor whom you purchased the product from, or an authorized CASIO service provider.

Warning

Dust and Moisture



- Though the Handheld Terminal is dust and waterproof resistant, its options including the battery pack are not. Keep loose metal objects and containers filled with liquid away from your Handheld Terminal and the options. Also, never handle the Handheld Terminal and the options while your hands are wet.

Laser Light



- The laser scanner models (model dependant) with the integrated laser scanning module scan bar codes using laser light. Never look directly into the laser light or shine the laser light into the eyes.
- Le terminal de l'imprimante portable émet une lumière laser.
Ne regardez jamais directement la lumière laser ni ne dirigez la lumière laser dans les yeux de quelqu'un.

Warning

Interference with the Operation of Other Equipment (Using Wireless Data Communication)



- Keep your Handheld Terminal well away from anyone wearing a pacemaker. Radio waves emitted by the Handheld Terminal can affect the operation of a pacemaker.
- Before the use in aircraft, be sure to consult with cabin crew for interference the Handheld Terminal emits.
- Before the use in medical facility, be sure to consult with the facility management or the manufacture of a specific medical equipment that the Handheld Terminal may interfere with.
- Do not use the Handheld Terminal nearby gas pump or chemical tank or any other places flammable or explosive.

Caution

Foreign Objects

-  • Take care to ensure that metals or combustible objects are not inserted into the openings of the Handheld Terminal or its options, and not to allow moisture to get inside of them.

Location

-  • Install the cradle properly on a flat and stable surface so that it cannot fall down onto floor.

LCD Screen



-  • Never apply strong pressure to the screen or subject it to strong impact. Doing so can crack the LCD Screen.

Low Temperature Burn



-  • Avoid prolonged contact with the skin while the Handheld Terminal is switched on. Some areas on the back of the Handheld Terminal may become hot during use and could cause low-temperature burns.

Optional Lithium-ion Battery Pack

Danger

-  • Never use the Handheld Terminal and its option including the battery pack and battery next to open flame, near a stove, or any other area exposed to high heat, or leave them for a long period of time in a vehicle parked in direct sunlight.
- Never use the battery pack with any device other than the Handheld Terminal.
- Never dispose of the battery pack by incinerating it or otherwise expose it to heat.
- Never transport or store the battery pack together with metal objects that may result in shorting positive (+) and negative (–) terminals of the battery pack. Be sure to place the battery pack in its case whenever transporting or storing it.
- Never throw the battery pack or otherwise subject it to strong impact.
- Never pierce the battery pack with nails, hit it with a hammer, or step on it.
-  • Use only the specified battery charger to charge the battery pack.

Warning



-  • Never place the battery pack in a microwave oven or any other high-voltage device.
-  • If the amount of time period the battery pack can serve becomes considerably short even after it has been fully charged for the specified time period, stop using it.
- Should the battery pack start to leak or emit a strange odor, immediately move it away from any flame nearby. Leaking battery fluid is combustible.
- Should fluid from the battery pack accidentally get into your eyes or on the skin, do not rub it. Immediately rinse it off with clean tap water and then consult a physician.

Caution







-  • Replace only with the same type of battery pack recommended by CASIO. Dispose of used battery packs according to the local regulation.
- Keep the battery pack out of the reach of small children.
- Risk of explosion if battery is replaced by an incorrect type. Dispose of used batteries according to the instructions.

Power Supply / AC Adaptor

Warning

-  • Do not use the Handheld Terminal at a voltage other than the specified voltage. Also, do not connect the Handheld Terminal to a multi-plug power strip.
- Never modify, sharply bend, twist, or pull on the power cord.
- Never use a detergent to clean AC adaptor and its power cable, especially on the plug and the jack.
- Do not use an AC adaptor with a bent connector.
- Do not twist or wrench the connector.
-  • When using the battery chargers and the cradles, be sure to use the respective AC adaptors.

Caution

-  • Never pull on the power cord when unplugging it. Always hold the plug when unplugging it from the wall outlet.
-  • Never touch the plug while your hands are wet.
-  • Be sure to unplug the power cord from the wall outlet before cleaning the battery chargers and the cradles.
-  • Unplug the power cord from the wall outlet whenever leaving the battery chargers and the cradles unattended for a long period.
-  • The housing of the AC adaptor can become warm during normal use.
-  • At least once a year, unplug the AC adaptor from the wall outlet and clean any dust that builds up between the prongs of the plug. Dust built up between the prongs can lead to the danger of fire.
-  • Check that the connector is properly oriented and then push it straight in (do not insert upside down).
- Do not allow fluids or foreign objects to get into the AC adaptor.
- Choose a location where the power cord is readily accessible and can be easily plugged in and unplugged.
- When using the AC adaptor, always use a power outlet with the specified power supply and voltage, and ensure that the power plug is inserted into the socket fully and securely.

Backup of All Important Data

Caution

-  • Note that CASIO Computer Co., Ltd. shall not be held liable to you or any third party for any damages or loss caused by deletion or corruption of data due to use of the Handheld Terminal, malfunction or repair of the Handheld Terminal or its peripherals, or due to the batteries going dead.
- The Handheld Terminal employs electronic memory to store data, which means that memory contents can be corrupted or deleted if power is interrupted due to the batteries going dead or incorrect battery replacement procedures. Data cannot be recovered once it is lost or corrupted. Be sure to make backup of all important data. One way to do this is to use the separately sold cradles to transfer data to a computer.

Operating Precautions

Your Handheld Terminal and its options are precision. Improper operation or rough handling can cause problems with data storage and other problems. Note and observe the following precautions to ensure proper operation.

- **Do not continue using the battery once it is exhausted.**

Doing so could result in data loss or corruption. When the battery is exhausted, replace it immediately.

- **Stop or avoid using the Handheld Terminal and its options in areas and conditions subject to the following.**

- Large amounts of static electricity
- Extreme heat or cold or humidity
- Sudden temperature change
- Large amount of dust
- After large amount of rain or water falls on the Handheld Terminal
- Pressing the screen or keys with excessive force when using in the rain

- **Do not use volatile chemical substances such as thinners, benzene or toiletries to clean the Handheld Terminal.**

When the Handheld Terminal is dirty, wipe it clean with a soft, dry cloth. Rubbing with excessive force could scratch the display.

- **The power-supply terminals and Data Communication terminals should be cleaned from time to time using an implement such as a dry cotton bud.**

Soiling on the terminals may cause connection defects.

- **Take care when using chemicals.**

Applying thinners, gasoline, kerosene, solvents or oils, or substances such as cleaners, adhesives, paints, medications or toiletries that contain those materials, to the plastic case or cover may cause discoloration or other damage.

- **Dead Pixels**

The LCD panel employed in this product uses high precision and substantial number of components which commonly cause a small number of the pixels not to light or to remain lit all the time. This is due to the characteristics of LCD panel yield in accuracy over 99.99% and permissible.

- **802.11a/n Restrictions**

- This product is for indoor use only when using channels 36, 40, 44, 48, 52, 56, 60, or 64 (5150-5350 MHz).
- To ensure compliance with local regulations, be sure to select the country in which the access point is installed.

- **Lithium-ion Battery Pack**

Each lithium-ion battery pack has its life. The life span heavily depends on how the battery pack is charged or stored which may cause deterioration of the battery pack to shorten the life span if it is handled improperly. Note the tips below to make the battery pack last long.

- Be sure to charge the battery pack before using it if the battery pack is used for the first time or if it has not been used for a long period of time. When charging the battery pack, continue charging until the charge LED lights green (fully charged).
- If the battery pack is repeatedly charged, the life span becomes short. To avoid the repetition of charging the battery pack, be sure that the remaining capacity is low before you start charging.
- Be sure to charge the battery pack in recommended temperature range. The temperature range is dependant on device you use to charge including battery chargers and tablets. Refer to the respective user guides. Charging the battery pack in a temperature outside of the recommended range causes deterioration.
- When used at low temperatures, the battery pack has a reduced capacity and will supply power for shorter time. The life span of the battery pack is also shortened.
- Charging the battery pack while the battery pack itself is freeze including inside causes deterioration. Be sure to resume an ordinary room temperature on the battery pack and then leave it unattended for approximately one hour before charging.
- After charging the battery pack, if the performance of the battery pack does not show any recovery, it is a sign of ending the life. Replace it with a new battery pack.
- Avoid the battery pack with a full of the capacity to store for a long period of time. If you need to store it for a long period, be sure that the remaining capacity is 30 to 50 percent and to store in a moderate low temperature. This can reduce deterioration.
- The battery pack gradually deteriorates over time. In particular, storing (or using) the fully charged battery pack at high temperatures tends to accelerate battery pack deterioration.

- **Weld Lines**

There are seam-like markings in some locations on the Handheld Terminal. These are referred to as “weld lines” in the plastic forming process and are not cracks or scratches. Weld lines do not interfere in any way with the operation of the Handheld Terminal.

Regulatory Information

Europe

IT-G500

CE 0984 ⚠

Options of IT-G500

CE

Manufacturer:

CASIO COMPUTER CO., LTD.

6-2, Hon-machi 1-chome, Shibuya-ku, Tokyo 151-8543, Japan

Responsible within the European Union:

Casio Europe GmbH

Casio-Platz 1, 22848 Norderstedt, Germany

www.casio-europe.com

- Please keep all information for future reference.
- The declaration of conformity may be consulted at <http://doc.casio.com/>
- Products are for distribution within all member states of the EU.
- Options of IT-G500 are HA-P60IO, HA-P62IO, HA-P30CHG, HA-D32DCHG, HA-D20BAT-A and HA-D21LBAT-A.

The USA and Canada

GUIDELINES LAID DOWN BY FCC RULES FOR USE OF THIS UNIT IN THE U.S.A. (not applicable to other areas).

NOTICE

This equipment has been tested and found to comply with the limits for a Class B digital device, pursuant to Part 15 of the FCC Rules. These limits are designed to provide reasonable protection against harmful interference in a residential installation. This equipment generates, uses and can radiate radio frequency energy and, if not installed and used in accordance with the instructions, may cause harmful interference to radio communications. However, there is no guarantee that interference will not occur in a particular installation. If this equipment does cause harmful interference to radio or television reception, which can be determined by turning the equipment off and on, the user is encouraged to try to correct the interference by one or more of the following measures:

- Reorient or relocate the receiving antenna.
- Increase the separation between the equipment and receiver.
- Connect the equipment into an outlet on a circuit different from that to which the receiver is connected.
- Consult the dealer or an experienced radio/TV technician for help.

FCC WARNING

Changes or modifications not expressly approved by the party responsible for compliance could void the user's authority to operate the equipment.

Proper connectors must be used for connection to host computer and/or peripherals in order to meet FCC emission limits.

Caution Exposure to radio frequency radiation

To comply with FCC/IC RF exposure compliance requirements, this device must not be co-located or operating in conjunction with any other antenna or transmitter except in accordance with the FCC multi-transmitter product procedures or as described in the filing.

Declaration of Conformity

Model Number: IT-G500-C21E-US, HA-P60IO, HA-P62IO

Trade Name: CASIO

Responsible party: Industrial Handheld Division
Casio America, Inc.

Address: 570 Mt. Pleasant Avenue, Dover, New Jersey 07801, USA

Telephone number: 973-361-5400

This device complies with Part 15 of the FCC Rules. Operation is subject to the following two conditions: (1) This device may not cause harmful interference, and (2) this device must accept any interference received, including interference that may cause undesired operation.



- **IT-G500-C21E-US**

This model is available in the USA and Canada only.

For Users in Canada

These Class B digital apparatuses comply with Canadian ICES-3(B)/NMB-3(B).

Cet appareil numérisé de la classe B est conforme à la norme ICES-3(B)/NMB-3(B) du Canada.

This device complies with Industry Canada's licence-exempt RSSs.

Operation is subject to the following two conditions:

- (1) These devices may not cause interference, and
- (2) These devices must accept any interference, including interference that may cause undesired operation of this device.

Le présent appareil est conforme aux CNR d'Industrie Canada applicables aux appareils radio exempts de licence.

L'exploitation est autorisée aux deux conditions suivantes :

- (1) l'appareil ne doit pas produire de brouillage;
- (2) l'utilisateur de l'appareil doit accepter tout brouillage radioélectrique subi, même si le brouillage est susceptible d'en compromettre le fonctionnement.

- Users should also be advised that 5150-5350 MHz band is restricted to indoor operation only. High-power radars are allocated as primary users (i.e. priority users) of the bands 5250-5350 MHz and 5650-5850 MHz and that these radars could cause interference and/or damage to LE-LAN devices.

- Les utilisateurs devraient aussi être avisés que
La bande 5150-5350 MHz est restreinte à une utilisation à l'intérieur seulement. De plus, les utilisateurs de radars de haute puissance sont désignés utilisateurs principaux (c.-à-d., qu'ils ont la priorité) pour les bandes 5 250-5 350 MHz et 5 650-5 850 MHz et que ces radars pourraient causer du brouillage et/ou des dommages aux dispositifs LAN-EL.

Under Industry Canada regulations, this radio transmitter may only operate using an antenna of a type and maximum (or lesser) gain approved for the transmitter by Industry Canada. To reduce potential radio interference to other users, the antenna type and its gain should be so chosen that the equivalent isotropically radiated power (e.i.r.p.) is not more than that necessary for successful communication.

Conformément à la réglementation d'Industrie Canada, le présent émetteur radio peut fonctionner avec une antenne d'un type et d'un gain maximal (ou inférieur) approuvé pour l'émetteur par Industrie Canada. Dans le but de réduire les risques de brouillage radioélectrique à l'intention des autres utilisateurs, il faut choisir le type d'antenne et son gain de sorte que la puissance isotrope rayonnée équivalente (p.i.r.e.) ne dépasse pas l'intensité nécessaire à l'établissement d'une communication satisfaisante.

The available scientific evidence does not show that any health problems are associated with using low power wireless devices. There is no proof, however, that these low power wireless devices are absolutely safe. Low power Wireless devices emit low levels of radio frequency energy (RF) in the microwave range while being used. Whereas high levels of RF can produce health effects (by heating tissue), exposure of low-level RF that does not produce heating effects causes no known adverse health effects. Many studies of low-level RF exposures have not found any biological effects. Some studies have suggested that some biological effects might occur, but such findings have not been confirmed by additional research.

IT-G500-C21E-US has been tested and found to comply with FCC/IC radiation exposure limits set forth for an uncontrolled environment and meets the FCC radio frequency (RF) Exposure Guidelines and RSS-102 of the IC radio frequency (RF) Exposure rules.

Les connaissances scientifiques dont nous disposons n'ont mis en évidence aucun problème de santé associé à l'usage des appareils sans fil à faible puissance. Nous ne sommes cependant pas en mesure de prouver que ces appareils sans fil à faible puissance sont entièrement sans danger. Les appareils sans fil à faible puissance émettent une énergie fréquence radioélectrique (RF) très faible dans le spectre des micro-ondes lorsqu'ils sont utilisés. Alors qu'une dose élevée de RF peut avoir des effets sur la santé (en chauffant les tissus), l'exposition à de faibles RF qui ne produisent pas de chaleur n'a pas de mauvais effets connus sur la santé. De nombreuses études ont été menées sur les expositions aux RF faibles et n'ont découvert aucun effet biologique. Certaines études ont suggéré qu'il pouvait y avoir certains effets biologiques, mais ces résultats n'ont pas été confirmés par des recherches supplémentaires.

IT-G500-C21E-US a été testé et jugé conforme aux limites d'exposition aux rayonnements énoncées pour un environnement non contrôlé et respecte les règles les radioélectriques (RF) de la FCC lignes directrices d'exposition et d'exposition aux fréquences radioélectriques (RF) CNR-102 de l'IC.

About the Waterproofing/Dustproofing

The IT-G500 Series models are waterproof and dustproof.

- Waterproofing: Performance complies with the IPX7 level set out in the IEC standards (waterproof for 30 minutes at a depth of 1 meter in still tap water at normal temperature).
- Dustproofing: Performance complies with the IP6X level set out in the IEC standards.

IP (International Protection) is the standard for splash- and dust-proofing for electrical products set out in the International Electrotechnical Commission (IEC) standard 60529.

Important!

The water- and dust-proofing performance of this product is based on CASIO testing procedures. Note also that this performance applies to the product at the time of shipment (delivery to the customer) and is not guaranteed inclusive of the environment in which the product is used. The warranty does not apply to any situation where the product is immersed during use, and as with any other electrical product, great care should be taken when using this product in the rain or similar situation.

• Precautions When Using this Product

- Check that there is no dust, sand or other foreign matter on the battery pack cover, microSD card slot cover or microUSB port/earphone-microphone jack cover, or on the respective contact surfaces. If any soiling is found, wipe it off with a clean, soft, dry cloth. Even very small amounts of soiling trapped on the contact surfaces (a single hair or grain of sand, etc.) can cause water to leak into the device.
- Check that the waterproof seals on the battery pack cover and microSD card slot cover are free from cracks and other damage.
- Close the battery pack cover lock switch firmly until the switch is in the locked position.
- Avoid opening and closing the battery pack cover or microSD card slot cover in locations near water or exposed to sea breezes, and do not open or close them with wet hands.
- Do not drop this product or leave it in locations exposed to temperatures outside the specified range. Doing so could impair its water- or dust-proofing.

• Other Precautions

- The accessories for this product (battery pack, etc.) and optional products are not water- or dust-proof.
- Subjecting this product to a severe impact could render it no longer water- or dust-proof.
- If any water leaks into the product as a result of carelessness or inattention during product handling, CASIO cannot be held liable for compensation for any damage to internal components (battery, recording media, etc.) or for the costs of recorded content or the recording thereof.
- CASIO COMPUTER CO., LTD. accepts no other liability whatsoever for any accident that occurs due to water leakage.

Important

- This guide does not include any information about programming and download procedures. See the applicable separate documentation for information about the procedures.

After Service

- Should this product ever malfunction, contact your original retailer providing information about the product name, the date you purchased it, and details about the problem.

Accessories and Options

Handheld Terminal IT-G500 Series

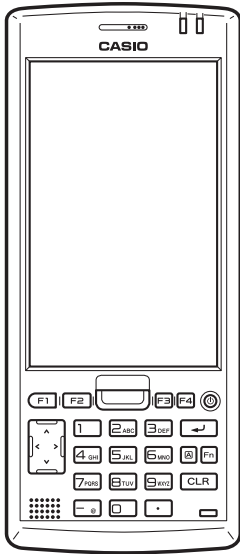

Accessories

Please check the items in the box before using the Handheld Terminal for the first time.

- Neck Strap
- Hand belt (installed in the Handheld Terminal)
- Stylus
- Stylus String
- Large-capacity Battery Pack Cover
- User's Guide
- microSD Hard Cover (IT-G500-GC21E only)
- Y-type screw (IT-G500-GC21E only)

Options

- USB Cradle HA-P60IO
- Ethernet Cradle HA-P62IO
- Cradle-type Battery Charger HA-P30CHG
- Dual Battery Charger HA-D32DCHG
- microUSB Cable (Handheld terminal-computer connection) HA-N81USBC
- USB Cable (Cradle-computer connection) DT-380USB-A
- AC Adaptor for Ethernet Cradle/Dual Battery Charger AD-S42120C
- AC Adaptor for USB Cradle/Cradle-type Battery Charger AD-S15050B

- Battery Pack HA-D20BAT-A
- Large-capacity Battery Pack HA-D21LBAT-A
- Flat battery cover (for battery pack (HA-D20BAT-A)) HA-P22FBC
- Screen Protect Sheet HA-P90PS5

- Power Cord AC-CORD

- Protector (for IT-G500-C16E/GC16E/15E/G15E/10C-CN) HA-P91BP5
- Protector (for IT-G500-C26E/GC26E/25E/GC21E/C21E/C21E-US/C21C-CN) HA-P92BP5
- Car Adaptor HA-P37CAC

General Guide

Handheld Terminal (IT-G500)

Top

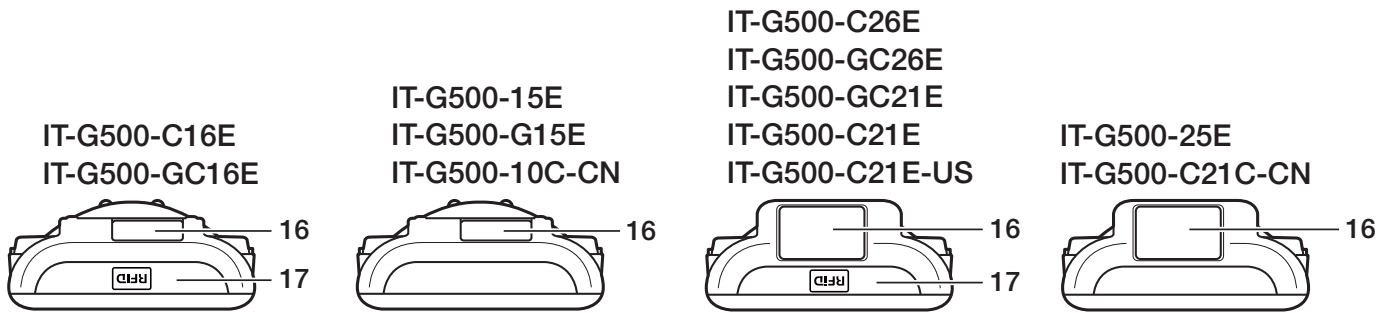

Left*

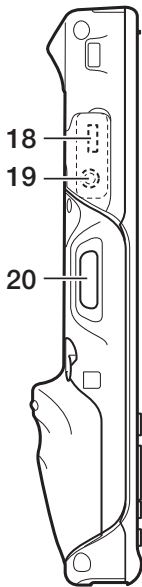

Front

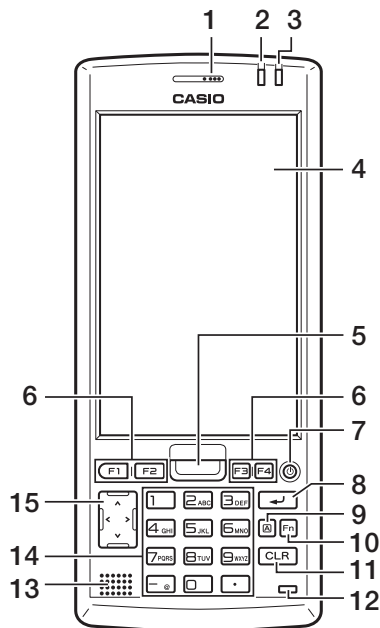

Right*

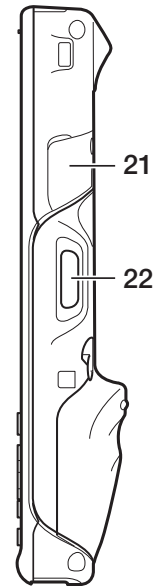

Battery Compartment

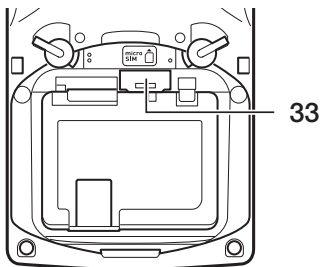

Back

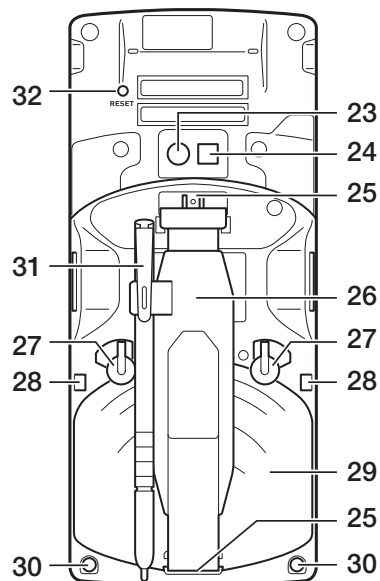

Bottom

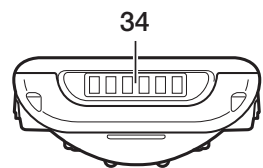

*The illustration shows the IT-G500-C16E.

1	Receiver*1	Outputs voice sound.
2	Indicator 1	Orange: Charging Green: Charging complete Red: Battery pack error or the surrounding temperature is out of the charging temperature range.
3	Indicator 2	Flashes blue when operating via Bluetooth or orange when operating via W-LAN, GPS or W-WAN. Lights red when there is a bar code scanning error and lights green when a bar code scans successfully. Lights red when the alarm function is activated.
4	Screen	The screen displays texts, operations, indicators and so forth. In addition, operations can be performed and data can be input on the screen using stylus.
5	Center Trigger Key	Used to perform bar code reading. Can be assigned an arbitrary function.
6	Function Keys	Used when starting a pre-registered application.
7	Power Key	Turns the power on and off.
8	Enter Key	Press when finishing entering numerical values or when moving to the next step.
9	Mode Key	The key switches the character input mode, either characters in lowercase letter or characters in uppercase letter.
10	Fn Key	Used to make various settings in combination with the function keys or numeric keys or when starting a pre-registered application.
11	CLR Key	Used to clear one letter to the left of the cursor.
12	Microphone*1	Used for audio input (including voice).
13	Speaker	Generates audio and buzzer tones.
14	Numeric Keys	Used to enter numeric values and decimal points.
15	Cursor Key	Perform the same functions as the up and down arrow keys on a PC keyboard.
16	Barcode Reader	Laser light or LED light is emitted from this window that reads bar codes.
17	NFC Reader *2	Holding a contactless IC card up to this reader allows data to be read from and written to the card.
18	microUSB Port	For connecting to microUSB cable (HA-N81USBC).
19	Headset Jack	Used to connect an earphone-microphone headset.
20	L Trigger Key	Used to perform bar code reading.
21	microSD Card Slot	microSD card slot.
22	R Trigger Key	Used to perform bar code reading.
23	Camera Lens *2	Takes photos.

24	LED *2	Used for taking photos.
25	Hand Belt Mount	Used to attach the hand belt.
26	Hand Belt	It is used to hold the terminal or to carry it.
27	Battery Pack Cover Lock Switches	Used to lock the battery cover and to release.
28	Cradle Mount Holes	These holes hold the terminal seating in the optional cradle or in the cradle-type battery charger.
29	Battery Pack Cover	Used to cover the battery compartment that holds the battery pack inside.
30	Strap Holes	Used to attach neck strap and hand belt.
31	Stylus	It is used to operate the terminal or to input data.
32	Reset Switch	Used to reset the Handheld Terminal.
33	microSIM Card Slot (for IT-G500-GC26E/GC16E/G15E/GC21E)	microSIM card slot. Remove the battery pack to load and unload microSIM card.
34	Power Supply/Data Communication Terminals	Used for USB communication or to supply power to the terminal and to charge the battery pack via either Cradle or Cradle-type Battery Charger.

*1. Excluding the IT-G500-15E/25E/C21C-CN/10C-CN.

*2. Excluding the IT-G500-15E/25E/G15E/10C-CN.

Loading and Removing the Battery Pack

Your Handheld Terminal uses two types of battery: a battery pack and a memory backup battery.

The battery pack is used to power normal operations and to store data, while the memory backup battery provides the power required to maintain memory contents when the battery pack power is unable to supply power for some reason.

You can choose either battery pack (HA-D20BAT-A) or large-capacity battery pack (HA-D21LBAT-A) for operating power.

The backup battery is installed inside of the Handheld Terminal.

This guide uses the following terms to refer to the batteries.

Battery Pack: Rechargeable battery pack (HA-D20BAT-A or HA-D21LBAT-A) for normal operations and data storage

Backup Battery: Built-in battery for memory backup

When the battery pack power goes low, immediately charge it or replace it with a charged battery pack.

You can use the Dual Battery Charger, the Cradle-type Battery Charger, the USB Cradle, or the Ethernet Cradle to charge a battery pack installed in the terminal. See the relevant sections in this guide for the respective options about how to use.

Important!

Always keep backup of all important data!

- **The battery pack powers normal operation and also provides power required to maintain memory contents, while the backup battery provides backup power to maintain memory contents. Because of this, you should not remove the battery pack if the backup battery is dead. Removing the battery pack while the backup battery is dead causes data in the memory to be corrupted or lost. Note that once data is lost it cannot be recovered. Always keep backup of all important data.**
- **The charge of a battery pack when you purchase it may be depleted due to testing at the factory or natural discharge during shipment and storage. Be sure to charge the battery pack before you use it.**
- **The life of a battery pack is limited, and charging a battery pack causes it to gradually lose its ability to maintain the charge. If your battery pack seems to require charging very frequently, it probably means it is time to purchase a new one.**
- **If a battery pack is used past the end of its service life, it may swell up in size. In such a case, replace the battery pack with a new one.**
- **If the backup battery is fully charged, it will maintain the contents of the terminal's memory (RAM) for approximately 4 minutes when the main battery pack is removed.**
- **It takes 4 days with the main battery pack installed in the terminal for the backup battery to be charged fully.**

Loading

1. Turn the Handheld Terminal over.

Tip!

You can load and remove the battery pack with the hand belt still attached.

2. Turn the battery pack cover lock switches to the “FREE” position and remove the battery cover.
3. Load the battery pack. Note the battery polarity (+/-). Take care also to load the battery pack so that the removal tape extends above the battery.

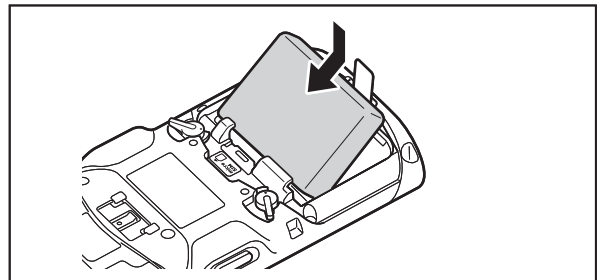
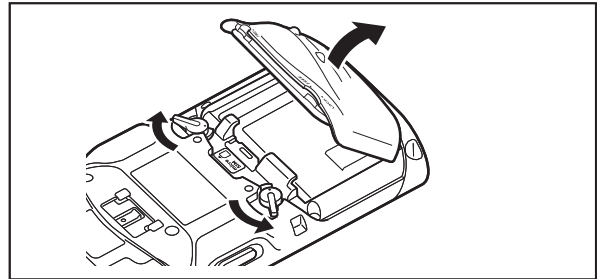

4. Fit the bottom edge of the battery pack cover into the groove in the Handheld Terminal. (1)
5. Return the battery pack cover to its original position as shown in the illustration. (2)

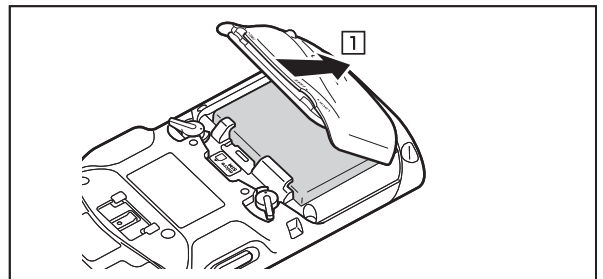

Move the lock switches for the battery pack cover back to the “LOCK” position. (3)

When loading the high-capacity battery pack, be sure to use the high-capacity battery pack cover.

This precaution also applies when using the optional flat battery cover.

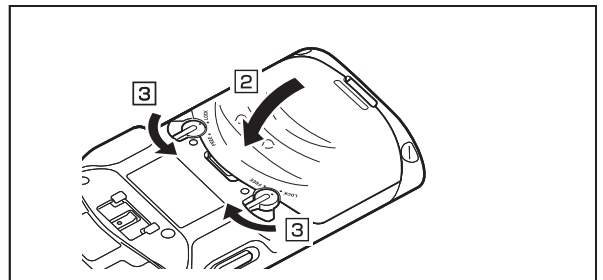

Removing

1. Make sure that the Handheld Terminal is turned off.
If the power is on, press the power key to turn it off.
2. Turn the battery pack cover lock switches on the back of the Handheld Terminal to the “FREE” position and remove the battery pack cover.

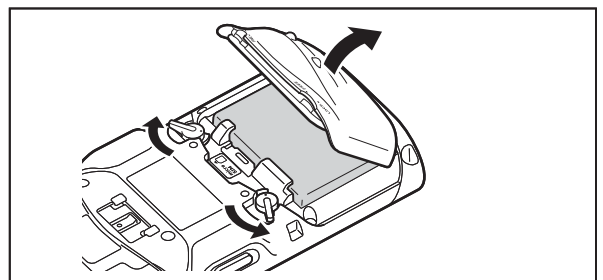

-
3. Remove the battery pack by pulling up the removal tape as shown in the illustration.

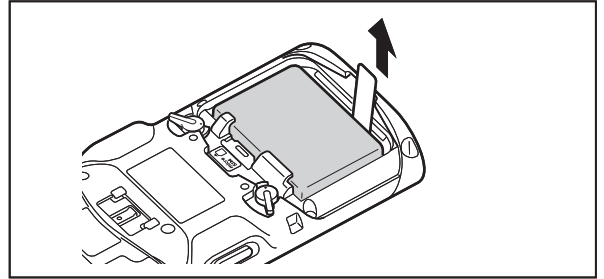

Important!

- **When removing the battery pack, make sure you do not leave the Handheld Terminal without a battery pack for more than about 4 minutes. Doing so can cause data in the memory to be deleted.**
- **When removing the battery pack, be sure you carefully follow the proper procedure as explained in this guide.**
- **Never try to use other type of battery than the ones that are specified for this product.**
- **When removing the battery pack, pull the removal tape straight up and remove the battery pack. Removing with excessive force can damage the battery pack.**
- **If you try to attach the battery pack cover starting with the top edge, you will not be able to securely close the cover.**

Charging the Battery Pack

Battery pack installed in the terminal can be charged using either cradle or battery charger. Battery charge condition can be monitored with Indicator 1 on the terminal. Multiple battery packs can also be charged simultaneously using Dual Battery Charger.

USB Cradle/Ethernet Cradle/Cradle-type Battery Charger

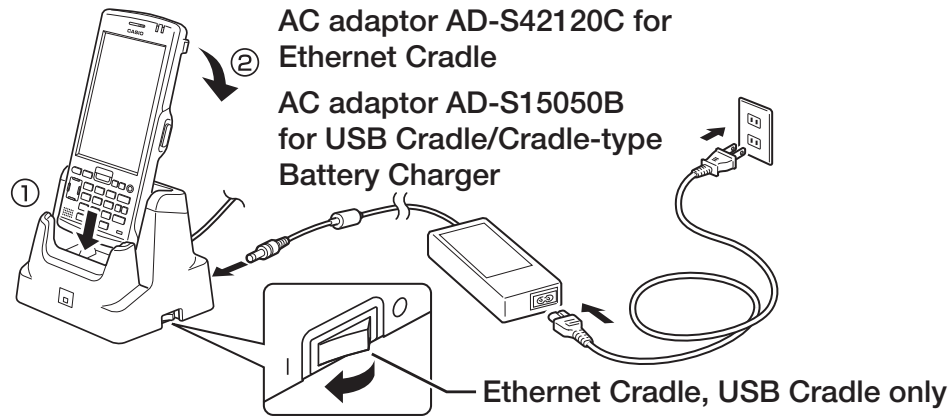

Status of Indicator 1 on IT-G500:

Orange: Charging

Red: Standby due to battery pack error or the surrounding temperature is out of the charging temperature range
(charging begins when the temperature is within the charging temperature range)

Green: Charging complete

Important!

- Take care not to trap objects such as the neck strap in the cradle.
- The data communication terminal should be cleaned from time to time using an implement such as a dry cotton bud.
Soiling or dust buildup could cause connection problems.

Dual Battery Charger

Taking care that the battery pack is oriented correctly, insert it into the Dual Battery Charger. This causes the Charge Indicator LED to light in red, indicating that charging has started.

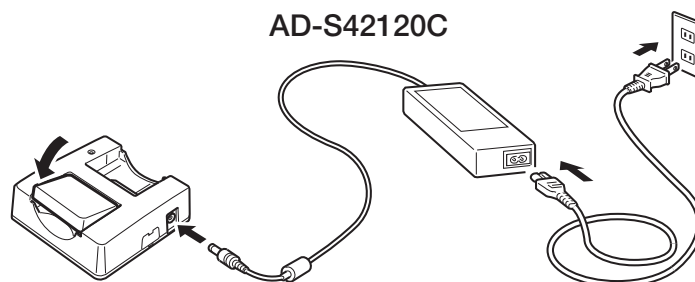

You can connect up to three Dual Battery Chargers.

Status of Charge Indicator LED

Off: Not charging

Red: Charging

Red Flashing: Battery pack problem

Green: Charging complete

Green Flashing: Standby due to the surrounding temperature being beyond the specified temperature range (Approximately 0°- 40°C) (charging resumes when the temperature reaches the range.)

Handling the Hand Belt

The hand belt is attached to the Handheld Terminal. Remove the hand belt when it is not needed.

To remove the hand belt

1. As shown in the illustration, hold down the raised section on the Handheld Terminal as you pull off the hand belt buckle.
2. Peel off the hook and loop fastener and pull the hand belt back through the slot at the bottom of the battery pack cover.

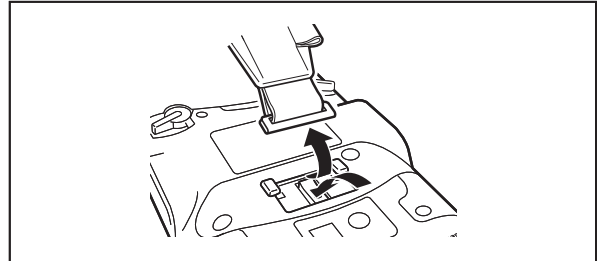

To attach the hand belt

1. Feed the end of the hand belt through the slot at the bottom of the battery pack cover, fold it back and secure it at a suitable length using the hook and loop fastener.
2. As shown in the illustration, align the hand belt buckle with the attachment position on the Handheld Terminal and press the buckle into place.

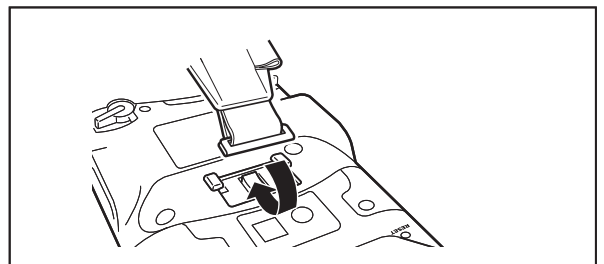
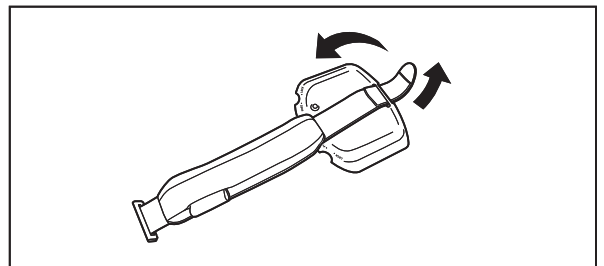

Check that the buckle is fitted securely.

Tip!

Holding the Handheld Terminal as shown in the figure will make it easier to use.

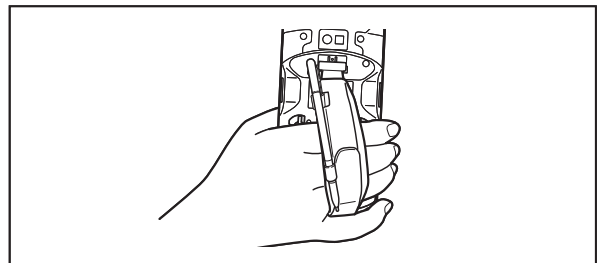

Handling the Stylus

When you are not using the stylus, place it in the stylus holder as described below.

Placing the stylus in the holder

1. As shown in the illustration, place the stylus in the holder with the tip downwards.

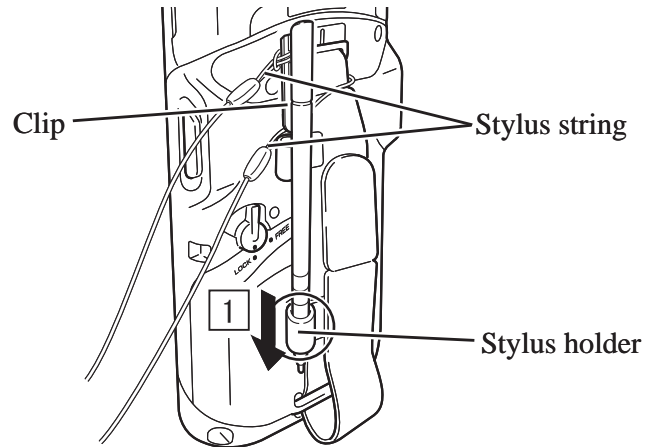

2. Slip the stylus clip into the upper holder as shown in the illustration.

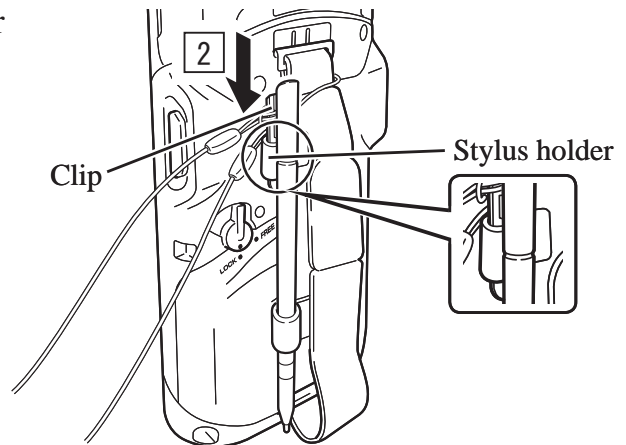

Important!

- **Failing to place the stylus in the stylus holder correctly could result in unforeseen injury due to the tip not being secured.**
It could also result in the IT-G500 not being correctly installed in devices such as the cradle and prevent successful communication or charging.
- **When you are not using the stylus, always place it in the stylus holder.**

Connecting the Stylus String

The string can be connected to stylus and hand belt to prevent loss of stylus or misplacing. Follow the instruction below to connect it to stylus and hand belt.

1. Thread one end of the string through the slit on stylus as shown in the illustration.

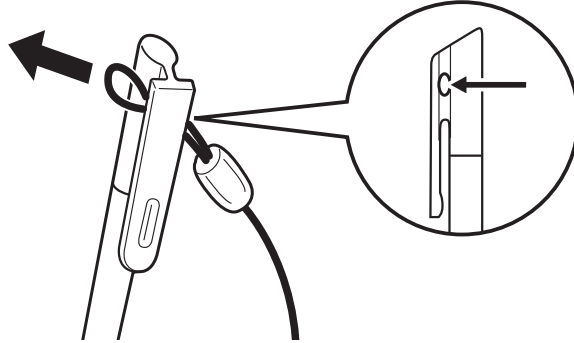

2. Thread the other end of the string through the loop as shown in the illustration, and then pull the other end to tighten.

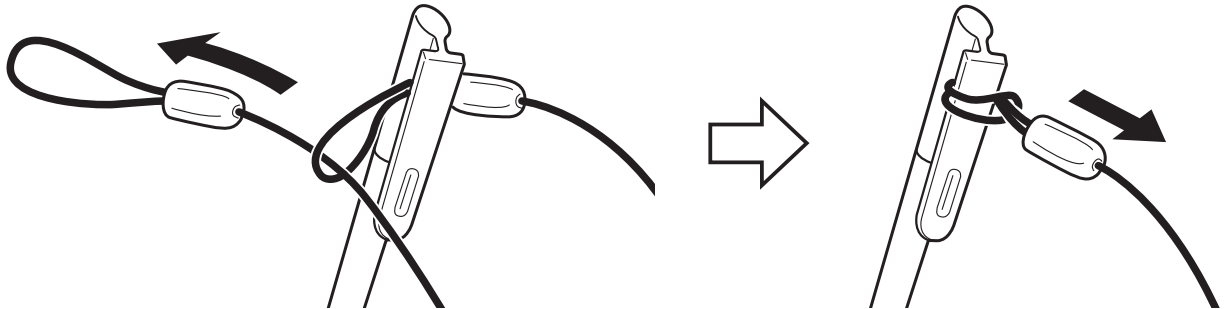

3. Unhook one end of the hand belt from IT-G-500 if it is attached, and then thread the hand belt through the loop of the string as shown in the illustration.

For unhooking the hand belt from the terminal, refer to “To remove the hand belt” on page 22.

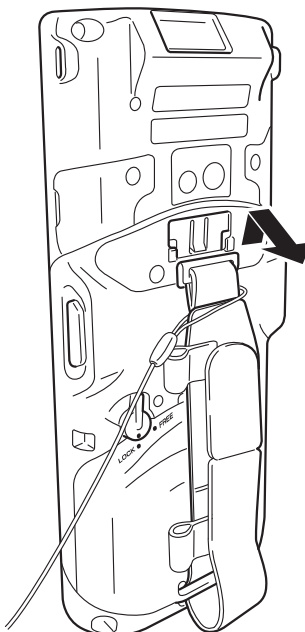

4. Hook the end of the hand belt to the terminal. Refer to “To attach the hand belt” on page 22.

5. Slip the stylus pen tip through the lower holder (1) and then slide the stylus clip through the upper holder (2).

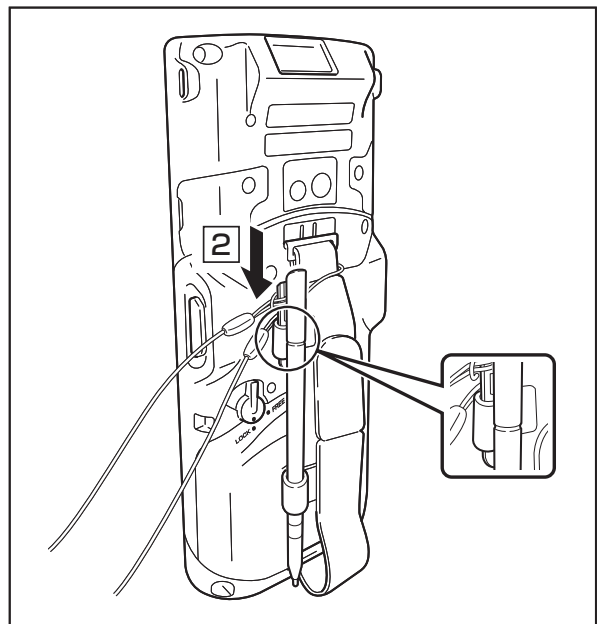
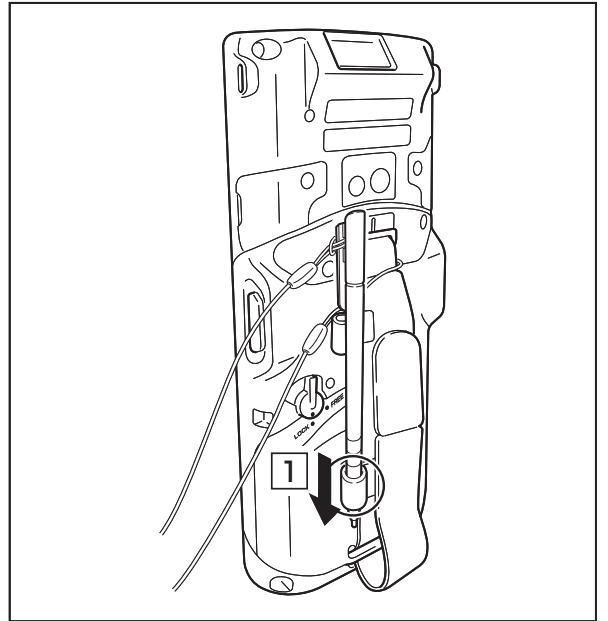

Attaching the Neck Strap

The neck strap can be used to prevent the Handheld Terminal from fall when carrying it around. Since there are two strap holes where the neck strap can be attached, use the hole that affords the ease of use. Attach the neck strap according to the procedure described below.

To attach the neck strap

1. Pass the thin cord of the neck strap through the strap hole on the back of the Handheld Terminal.

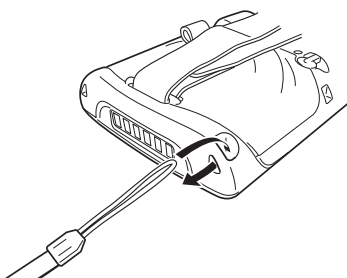

2. Pass the other end of the strap (the part you put around your neck) through the loop formed by the thin cord.

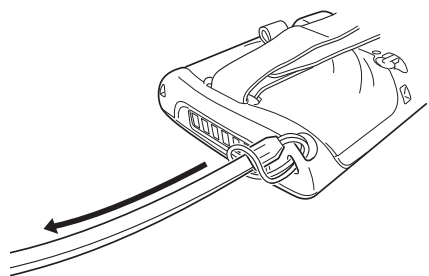
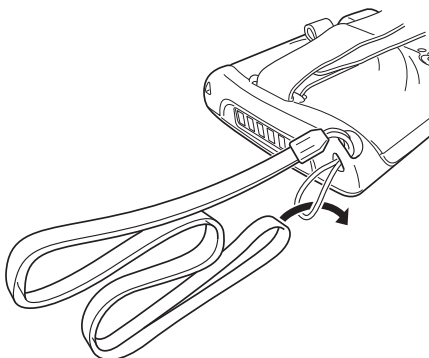

Important!

Do not swing the Handheld Terminal around holding the neck strap.

Configuring Handheld Terminal Settings

Calibrating Touch Screen Alignment

Whenever the response of the touch screen is poor, or operation being executed does not match with the location you are tapping on the touch screen, please recalibrate the alignment of the touch screen using the following method.

- Press the “Fn” key and then press the “4” key after confirming that “F” is displayed in the lower right corner of the screen. The following screen is displayed.

* You can also display this screen by navigating as follows:

WEC7: Start → Settings → Control Panel → Stylus → Calibration → Recalibrate

WEH6.5: Start → Settings → System → Screen → Align Screen

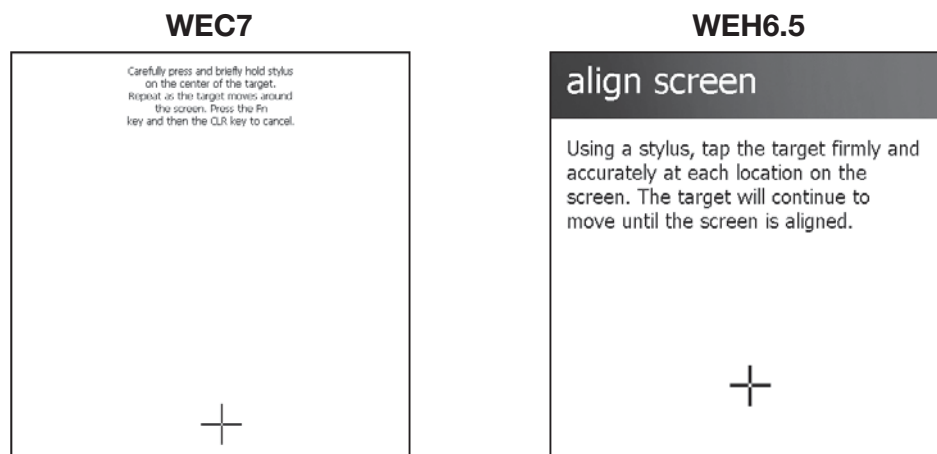

- Press the stylus against the center of the target mark (+ mark) as indicated on the screen.

WEC7:

Press the stylus against the target mark on the screen 5 times to display the next screen. Then press the Enter key or tap anywhere on the screen.



WEH6.5:

After the calibration is complete, the terminal resumes a screen automatically according to the method carried out to initiate the calibration.

If you start the calibration by pressing "Fn" and "4" keys, the terminal resumes Start screen, or General tab screen of Settings mode which is the screen one before align screen of Settings mode if you initiate by navigating to the icons.

Adjusting Display Brightness

You can use the following procedures to adjust display brightness to make it easier to read under different lighting conditions.

- Press the “Fn” key and then press the “5” key or “6” key after confirming that “F” is displayed in the lower right corner of the screen. Pressing the “5” key adjusts brightness for a darker display, while pressing the “6” key adjusts brightness for a lighter display.
- * In order to continue to make adjustments, press the “5” key or “6” key again after first pressing the “Fn” key.
- * Brightness settings can also be made by navigating to the menus and tab in order of Start → Settings → System → Backlight.

Display Auto Dimmer

The display auto dimmer automatically lowers display brightness if you do not perform any operation for a specific period of time. This helps the battery power to be conserved.

You can use the following procedure to specify a period of time that should be allowed to elapse until when the auto dimming is initiated.

- Navigate to the menus and tab in order of Start → Settings → System → Backlight.

Using the Laser Scanner (Laser Models)

1. After turning on the power, position the laser scanner close to a bar code and then press the trigger key.



2. The laser emits light and scans the bar code. If scanning is completed normally, Indicator 2 displays a green light.

Important!

- **If you are unable to scan a bar code, try changing the angle at which the scanner is held or distance from the scanner to the bar code, and then try scanning again.**
- **This Handheld Terminal is capable of scanning bar codes at a distance of about 46-550 mm. Furthermore, the distance at which scanning is possible may vary according to the bar code symbology.**

Using the C-MOS Imager (Imager Models)

1. Turn on the Handheld Terminal, position its C-MOS Imager reader port near the bar code or 2D code, and then press the trigger key.



2. The Handheld Terminal reads the code by emitting laser and red lights. Indicator 2 (read operation indicator lamp) lights in green when the reading is successful.

Bar code and stacked 2D code Reading Guide

When you press the trigger key, LEDs in the Handheld Terminal emit laser and red lights. Align the laser frame with the center of the bar code or 2D code you are trying to read. Take particular care aligning the light when there are other bar codes nearby.

When reading a bar code in large size, adjust the position of the Handheld Terminal so that the entire code is enclosed within the laser frame. For small size, move the Handheld Terminal closer to it.

Important!

- **If you have problem not properly reading a code, change the angle and/or the distance between the code and the Handheld Terminal and try reading it again.**
- **A bar code can be read from a distance of 50mm to 400mm, and a stacked 2D code can be read from a distance of 65mm to 260mm and matrix 2D code can be read from a distance of 55mm to 195mm. The actual reading distance depends on the symbology and the resolution.**
- **Note that a special reader application is required to read bar codes and 2D codes.**
- **Fingerprints, dust, dirt, or stain on the C-MOS Imager reader port can cause abnormal reading. Should the reader port become dirty, wipe it clean with a soft and dry cloth.**

Adjusting the Laser Light Emission Width

The emission width of the laser light emitted by the Handheld Terminal (model dependant) can be adjusted. Adjust the emission width when it is improper.

1. Navigate to the menus in the following sequence:

Start → Settings → System

The Control Panel appears as shown in the screen.

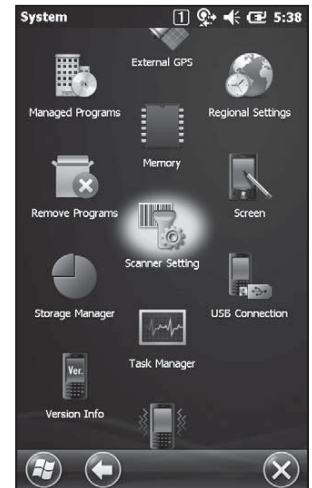

2. Tap the [Scanner Setting] icon. The Setting screen appears as shown in the screen.

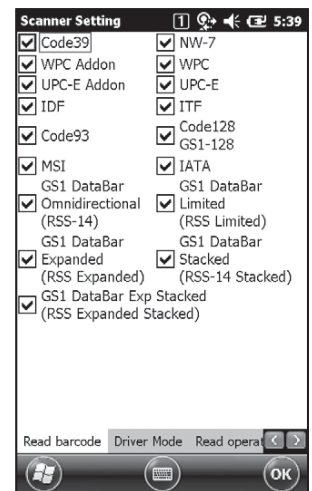

3. Tap the [Others] tab in the Scanner Setting screen.

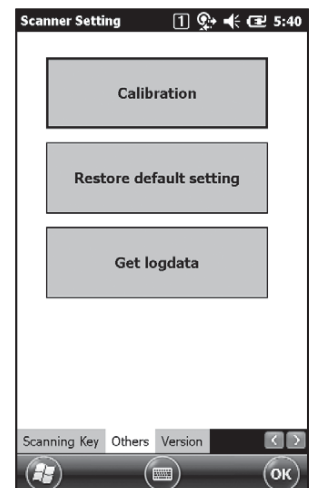

4. Tap the [Calibration] button. The display appears as shown at right.

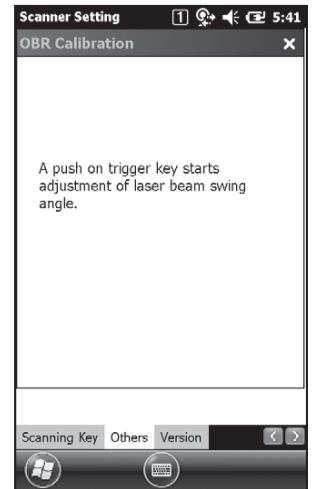

5. Press the trigger key to emit laser light, and align the light with the barcode for adjusting emission width.

- Align the laser light with the narrow bars on both sides.
- The message appears as shown at right when adjustment is completed.
- Repeat the setting if "Setting failed" message appears.

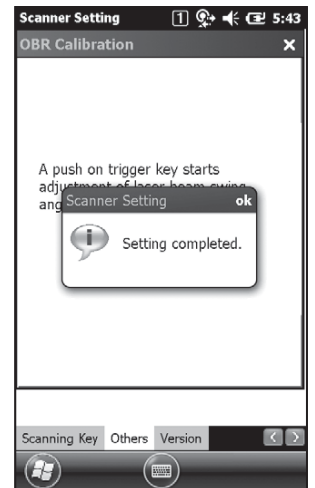

Emission Width Adjustment Bar code

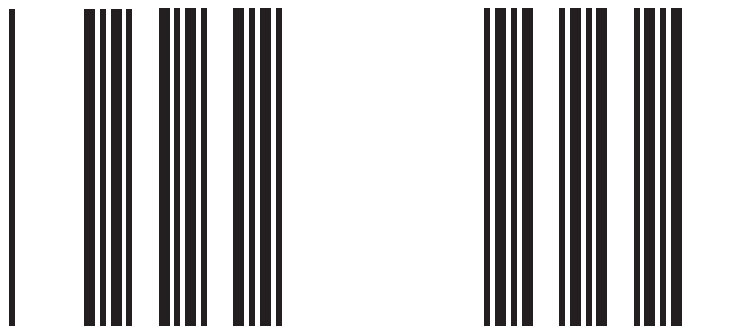

Handling the NFC

The NFC is a technology of contactless IC card for short range communication that enables writing data to card and reading data from the card by applying the card close to the NFC Reader on IT-G500.

The integrated NFC can read a contactless IC card used typically for employment identification, etc.

1. Hold the card flat against the NFC reader () on the top of the Handheld Terminal.

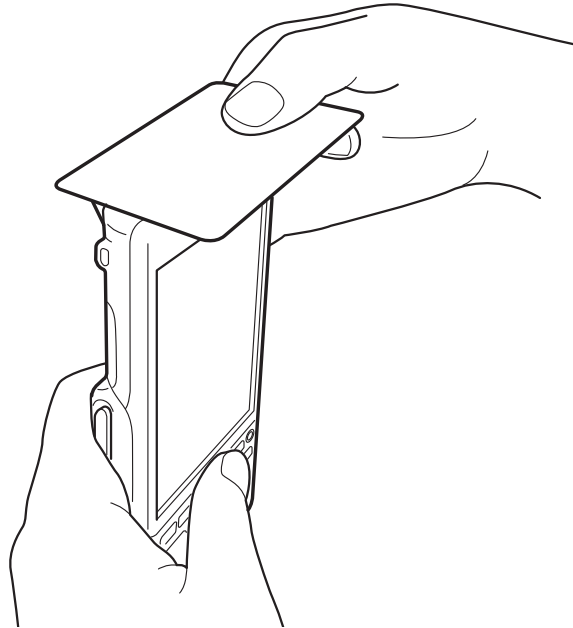

Important!

- If reading a card is difficult, slightly change the position by moving it either close to the NFC Reader or far away, or to the right or to the left.
- Do not apply card while it is overridden by other card. The NFC may not read it correctly.
- A metal object near by the NFC Reader may cause the NFC not to read card correctly. Take the card out of a wallet if the wallet is with metal object before applying it to the NFC Reader.
- Apply card in parallel with the NFC Reader to touch the NFC Reader with the card.
- Frequency band used by the NFC is 13.56 MHz. Secure a sufficient space between IT-G500 and other reader/writer located in the vicinity. Make sure also that a radio station employs the same frequency band does not locate near by prior to using IT-G500.

Performing Communications

Bluetooth® Communication

Bluetooth® interface can also be used to transfer data between two Handheld Terminals. With Bluetooth® the two Handheld Terminals should be located within about five meters from each other, as long as there is nothing blocking the path between them.

Important!

Observe the following precautions to help ensure that Bluetooth communication is successful.

- **Make sure two Handheld Terminals face each other within five meters. Surroundings (obstacles) between the Handheld Terminals may cause a shorter distance.**
- **Make sure there is at least two meters between the Handheld Terminal and other equipment (electrical appliances, audio-visual equipment, OA equipment, and digital cordless telephones, facsimile machines, etc.). Take special care with microwave ovens. Allow at least three meters between the Handheld Terminals in wireless operation and a microwave oven. When operating the terminal in Bluetooth nearby these devices and electrical appliances with their powers being turned on, communication may be interrupted or radio receptions may be interfered.**
- **Normal communication may not be possible in an area near a broadcast transmitter or wireless transmitter. If this happens, move the Handheld Terminal to a different location. Normal communication may not be possible in areas exposed to strong radio waves.**
- **Interference by WLAN**
Because Bluetooth® and WLAN use the same frequency band (2.4GHz), radio interference can occur if there is a WLAN device nearby. This can result in lower communication speed, or even make it impossible to establish a connection. If this happens, try the following countermeasures.
 - Move at least 10 meters away from the WLAN device.
 - If you cannot keep the distance at least 10 meters or more between the Handheld Terminal and a WLAN device, turn off the power of either the Handheld Terminal or the WLAN device.
 - Although the Handheld Terminal enables WLAN and Bluetooth® communication to be used simultaneously as a result of being equipped with Bluetooth® Ver.2.0/2.1, communication may not be possible depending on the surrounding radio wave environment.

GSM/W-CDMA Communication

To use the GSM/W-CDMA functions, you must receive service from a wireless service provider. Available GSM/W-CDMA functions may be dependent on the service provider to which you connect. Please consult your service provider for details about network service.

GPS

When you use the Handheld Terminal for the first time or after an extended period of no use, it may take a long time before the Handheld Terminal determines its positioning. In such a case, operate the GPS mode where there are no obstacles in the surroundings and wait for at least 15 minutes or longer.

The GPS module integrated in the Handheld Terminal uses signals emitted by the satellites operated by the government of the United States. The accuracy of positioning information you obtain on the Handheld Terminal may be affected by the condition of these satellites.

The GPS module may not be able to receive the signals in locations such as inside a building or in a tunnel. If you are installing the device in your car, determine the installation location after making sure that it can receive the signals.

Handling microSD Cards

This Handheld Terminal supports microSD cards.
Use the procedure below to install a microSD card.

Installing

1. Open the microSD card slot cover (1) and push the card all the way into the slot, ensuring that the front of the microSD card is facing the front of the Handheld Terminal (2).
2. Close the microSD card slot cover.

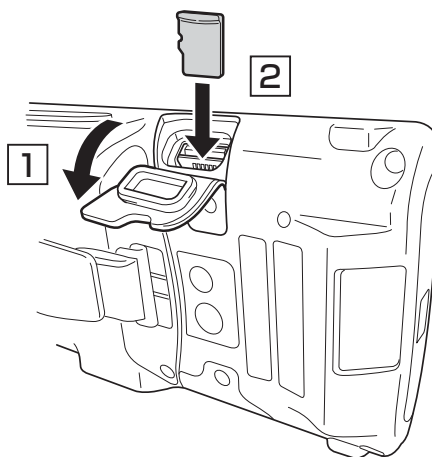

Removing

1. Open the microSD card slot cover.
2. Pull the microSD card out and close the microSD card slot cover.

Important!

- A microSD card must be inserted with the top and bottom properly aligned and in the proper direction. Attempt in inserting it with an excessive force in incorrect orientation can risk damage to the connectors and slot.
- Never turn off the power or remove a microSD card from the slot while the card is being accessed. Doing so can damage the microSD card or data in the card.
- Do not drop the card or lose it.

Handling microSIM Cards

The Handheld Terminal supports microSIM card.

The employment of microSIM card slot is dependent on model. See page 17 for the models with microSIM card slot integrated.

The microSIM card slot is located in the side of the battery pack compartment, so you must remove the battery pack when installing or removing a microSIM card.

Refer to pages 18 to 20 for information on “Loading and Removing the Battery Pack”. Install (or remove) a microSIM card according to the procedure described below.

Installing

1. Make sure that the power on the terminal has been switched off. If the power is still on, press the power key to switch off the power.
2. Remove the battery pack.
3. Pull the plastic holder outwards and then upwards to open it, as shown in the figure.

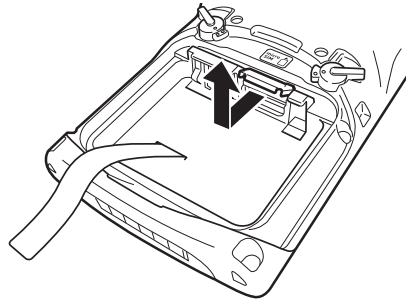

4. Push the microSIM card gently into the entrance to the card slot, as shown in the figure.

When doing this, take care not to insert the microSIM card between the card slot and the plastic holder by mistake.

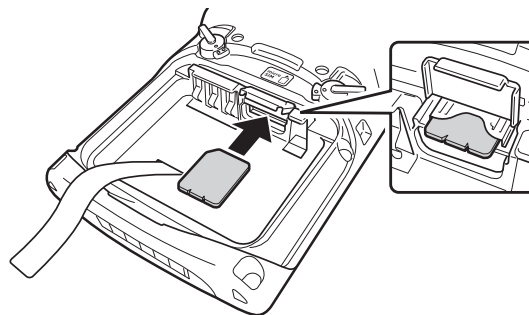

5. Close the plastic holder and push it into place, as shown in the figure.

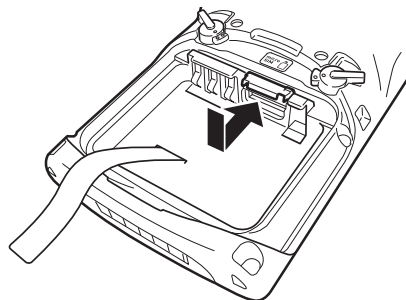

6. Load the battery pack.

Removing

1. Make sure that the power on the terminal has been switched off. If the power is still on, press the power key to switch off.
2. Remove the battery pack.
3. Pull the plastic holder outwards and then upwards to open it, as shown in the figure.

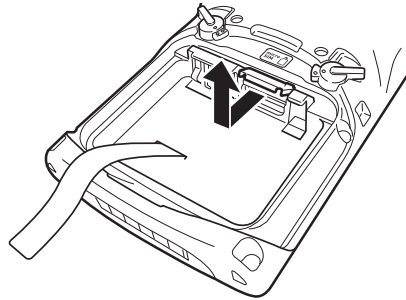

4. Pull out the microSIM card, as shown in the figure.

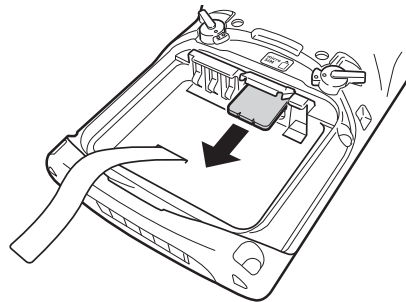

5. Close the plastic holder and push it into place.
6. Load the battery pack.

Important!

- When installing a microSIM card, check the orientation of the card and ensure that you install it correctly. Using excessive force when installing or removing a microSIM card could damage the card.
- Touching the contacts when installing a microSIM card could result in damage to the card due to soiling or an electrostatic charge.
- The battery pack will not be able to be properly installed if the microSIM card is not properly installed. Reinstall the microSIM card properly if this happens.
- Since data recorded in the Handheld Terminal may be lost if the battery pack is removed for more than 4 minutes, complete the installation (or removing) of microSIM card within 4 minutes.

Using the microSD Hard Cover (IT-G500-GC21E only)

Use the procedure below to attach the “microSD Hard Cover”.

Attaching the microSD Hard Cover to the Handheld Terminal

1. Loosen the screw for the microSD card cover supplied with the Handheld Terminal and remove the cover.
2. Attach the microSD Hard Cover by sliding it onto the Handheld Terminal.

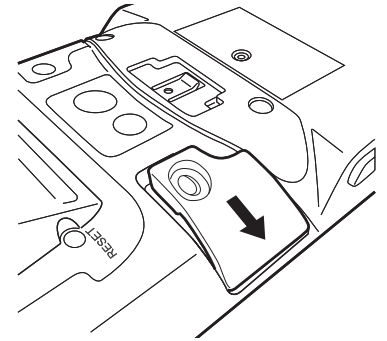

3. Use your finger to push the cover in so that it fits tightly against the waterproof seals, checking that it sits flush with the Handheld Terminal body.

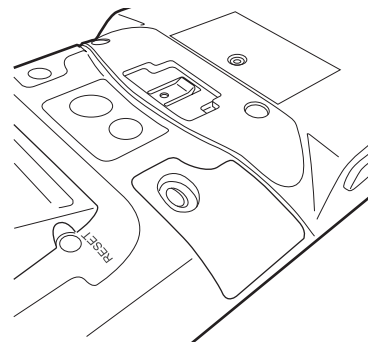
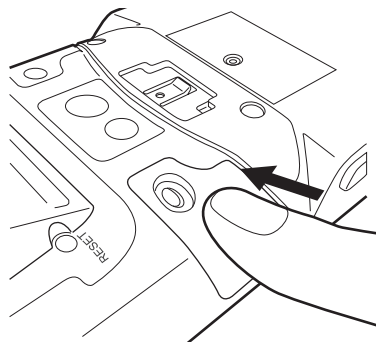

4. Fix the microSD Hard Cover in place using the screw provided.

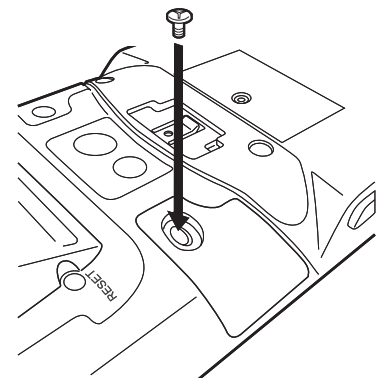

Important!

- **Failing to attach the microSD Hard Cover correctly could result in water leakage.**
- **When attaching the microSD Hard Cover, check that the waterproof seals are free from any cracking, splitting or other damage.**

Resetting the Handheld Terminal

Resetting the terminal is the same as resetting a PC. Performing a reset causes all unsaved RAM data to be lost that are in mid-course of inputting and editing, but data and settings that are already stored in the FlashROM should be unaffected. Perform a reset to restore normal operation whenever the Handheld Terminal operates abnormally due to misoperation or some other reason.

Use a stylus to press the reset switch on the back of the IT-G500.

This starts the reset operation.

* Do not use a toothpick or pencil or other sharp object whose tip may break off the reset switch.

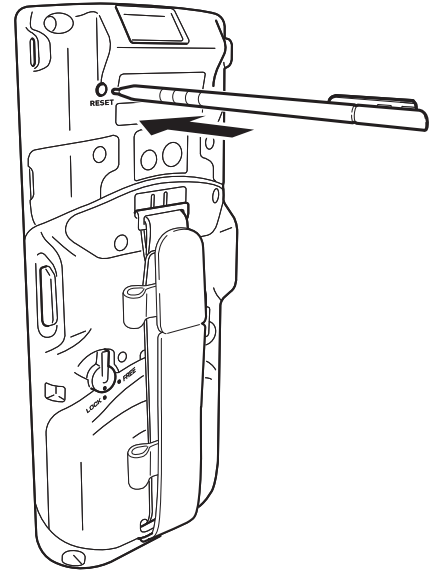

Performing a Full Reset (Initialization)

Performing a full reset deletes all data and resets various settings to their defaults.

*Data stored in the Flashdisk folder remain unaffected.

Perform a full reset whenever any one of the following conditions exists.

- When you want to delete installed programs and settings, and resume the terminal to the initial condition.
- When you are no longer able to use the Handheld Terminal because you forgot your password.
- When the Handheld Terminal does not operate normally due to a memory problem.

Important!

Performing a full reset resets all data to their defaults except stored in the Flashdisk folder. If possible, backup data of the terminal to a PC or to the Flashdisk folder. The reset procedure and display message appeared on performing the reset is according to the model you operate.

1. Hold down Fn key and CLR key while pushing down the reset switch for about 3 seconds with the tip of a stylus until the message shown below appears on the display.
 - To cancel the full reset operation, press L Trigger key on the scan engine integrated models or L Enter key on the non-scan engine integrated models.

Message appeared on the scan engine integrated models.

*Full Reset Warning
The following operation
initializes the Root Disk.
Press the [R Trigger key] to proceed
or the [L Trigger key] to cancel.*

Message appeared on the non-scan engine integrated models.

*Full Reset Warning
The following operation
initializes the Root Disk.
Press the [R Trigger key] to proceed
or the [L Trigger key] to cancel.*

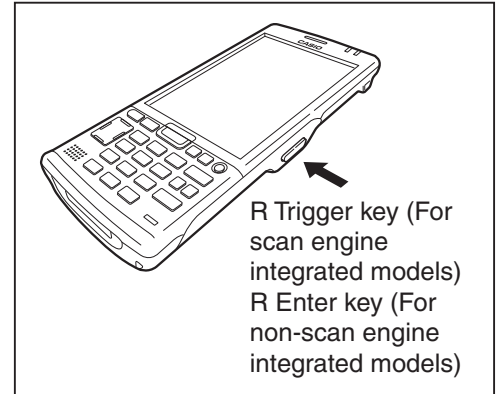

2. Press R Trigger key on the scan engine integrated models or R Enter key on the non-scan engine integrated models. This causes the message shown below to appear.
 - To cancel the full reset operation, press L Trigger key on the scan engine integrated models or L Enter key on the non-scan engine integrated models.

Message appeared on the scan engine integrated models.

*Full Reset Warning
The following operation deletes all data
stored in the Root Disk.
Press the [R Trigger key] to proceed
or the [L Trigger key] to cancel.*

Message appeared on the non-scan engine integrated models.

*Full Reset Warning
The following operation deletes all data
stored in the Root Disk.
Press the [R Trigger key] to proceed
or the [L Trigger key] to cancel.*

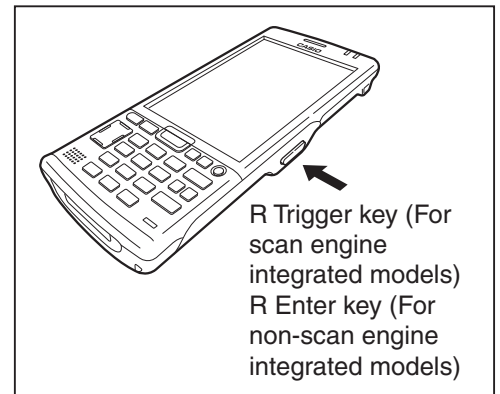

3. Press R Trigger key or R Enter key again to perform the full reset.
 - The full reset starts and all data in the memory are erased, and the start-up screen appears.
Data stored in the Flashdisk folder remain unaffected.

Warning Label

Warning!

■ Never look directly into the laser light.

-  • These products scan using laser light. Never look directly into the laser light or shine the laser light into the eyes.



- This label is a warning and caution label for Class 2 laser products that comply with IEC60825-1:2007.
- Although Class 2 laser light is only emitted momentarily, never look directly into the beam light.
- The laser light emitted by this laser scanner has a maximum output of less than 1 mW and a wavelength of 650 nm.
- Use of controls or adjustments or performance of procedures other than those specified herein may result in hazardous radiation exposure.

IT-G500 Specifications

	C16E	C26E	15E	25E
CPU	ARM Cortex-A9 1.5GHz			
OS	Windows Embedded Handheld 6.5 Classic			
Memory	RAM:512MB FROM:4GB (user area : Approximately 3GB)			
Display	4.3inches 480 (horizontal) × 800 (vertical) WVGA			
Scanner*1	Laser	Imager	Laser	Imager
Camera	Approx. 5,000,000 pixels		-	
Microphone	Voice sound input		-	
Receiver	For Public line and VoIP		-	
WLAN*2	IEEE 802.11a/b/g/n			
Bluetooth*3	Specification Ver.2.0 + EDR			
W-CDMA*4	-			
GSM*5	-			
GPS*6	-			
NFC*7	Supported Cards : ISO1443 TypeA, ISO1443 TypeB, ISO15693, Felica		-	
micro SD	Compatible with SDHC Memory Card			
micro USB	micro USB A-B connector			
micro SIM	-			
Headset Jack	CTIA standard			
Power Requirements	Power Source : HA-D20BAT-A HA-D21LBAT-A			
Memory Backup	Rechargeable Lithium Battery (Built-in)			
Consumption Current	DC2.6A		DC1.6A	DC2.0A
Battery Life	HA-D20BAT-A : Approx 11 hours HA-D21LBAT-A : Approx 20 hours *8			
Operating Temperature	-20°C~50°C			
Operating Humidity	10%~90% RH			
Drop Durability	1.5m			
Dust and Water Splash Proof	IP67 level			
Dimensions	Approximately 74(W) × 175(D) × 22(H)mm (The height does not include the protruding parts)			
Weight	Approximately 250g	Approximately 245g	Approximately 250g	Approximately 245g
Vibrator	Available according to software setting.			

	G15E	GC16E	GC26E	GC21E
CPU	ARM Cortex-A9 1.5GHz			
OS	Windows Embedded Handheld 6.5 Professional			Windows Embedded Compact 7
Memory	RAM:512MB FROM:4GB (user area : Approximately 3GB)			RAM:1GB FROM:4GB (user area: Approximately 3GB)
Display	4.3inches 480 (horizontal) × 800 (vertical) WVGA			
Scanner*1	Laser		Imager	
Camera	–	Approx. 5,000,000 pixels		
Microphone	–	Voice sound input		
Receiver	For Public line and VoIP			
WLAN*2	IEEE 802.11a/b/g/n			
Bluetooth*3	Specification Ver.2.0 + EDR			Specification Ver.2.1 + EDR
W-CDMA*4	UMTS/W-CDMA:3GPP release99 HSDPA:3GPP release5			
GSM*5	3GPP release99			
GPS*6	12 channels and receiver, L1 1575.42 MHz, C/A code			
NFC*7	Supported Cards : ISO14443 TypeA, ISO14443 TypeB, ISO15693, Felica			
micro SD	Compatible with SDHC Memory Card			
micro USB	micro USB A-B connector			
micro SIM	Support for ISO 7816 IC Card standard 3V,1.8V SIM cards			
Headset Jack	CTIA standard			
Power Requirements	Power Source : HA-D20BAT-A HA-D21LBAT-A			
Memory Backup	Rechargeable Lithium Battery (Built-in)			
Consumption Current	DC2.0A	DC3.0A		
Battery Life	HA-D20BAT-A : Approx 11 hours HA-D21LBAT-A : Approx 20 hours *8			
	W-WAN Waiting HA-D20BAT-A : Approx 115 hours HA-D21LBAT-A : Approx 230 hours W-WAN continuous communication HA-D20BAT-A : Approx 150 minutes HA-D21LBAT-A : Approx 300 minutes			
Operating Temperature	–20°C~50°C			
Operating Humidity	10% ~ 90%RH			
Drop Durability	1.5m			
Dust and Water Splash Proof	IP67 level			
Dimensions	Approximately 74(W) × 175(D) × 22(H)mm (The height does not include the protruding parts)			
Weight	Approximately 270g			
Vibrator	Available according to software setting.			

	10C-CN	C21E	C21E-US	C21C-CN
CPU	ARM Cortex-A9 1.5GHz			
OS	Windows Embedded Compact 7			
Memory	RAM:1GB FROM:4GB (user area : Approximately 3GB)			
Display	4.3inches 480 (horizontal) × 800 (vertical) WVGA			
Scanner*1	Laser	Imager	Imager	Imager
Camera	–	Approx. 5,000,000 pixels		
Microphone	–	Voice sound input		–
Receiver	–	For Public line and VoIP		–
WLAN*2	IEEE 802.11a/b/g/n			
Bluetooth*3	Specification Ver.2.1 + EDR			
W-CDMA*4	–			
GSM*5	–			
GPS*6	–			
NFC*7	–	Supported Cards : ISO1443 TypeA, ISO1443 TypeB, ISO15693, Felica		–
micro SD	Compatible with SDHC Memory Card			
micro USB	micro USB A-B connector			
micro SIM	–	Support for ISO 7816 IC Card standard 3V,1.8V SIM cards		–
Headset Jack	CTIA standard			
Power Requirements	Power Source : HA-D20BAT-A HA-D21LBAT-A			
Memory Backup	Rechargeable Lithium Battery (Built-in)			
Consumption Current	DC1.6A	DC2.6A		
Battery Life	HA-D20BAT : Approx 11 hours HA-D21LBAT : Approx 20 hours *8			
Operating Temperature	–20°C~50°C			
Operating Humidity	10% ~ 90%RH			
Drop Durability	1.5m			
Dust and Water Splash Proof	IP67 level			
Dimensions	Approximately 74(W) × 175(D) × 22(H)mm (The height does not include the protruding parts)			
Weight	Approximately 250g	Approximately 245g		
Vibrator	Available according to software setting.			

*1

Scanner Specifications

	Item	Specification	Remark
Laser Scanner	Laser emit angle	Redirected downward at 25 degree	
	Wave Length	645nm to 664nm	
	Optical Output	< 1mW	
	No. of scanning	100 ± 20 per second	
	Resolution	0.127mm (minimum) or grater	
	PCS	0.45 (minimum) or grater	
	Readable distance	Approximately 46mm to 550mm	
	Readable width	Max. 418mm	- at 550mm depth
	Daylight for scanning	50,000 Lux or less	
	Readable bar code symbologies	UPC-A/UPC-E/EAN8 (JAN8)/EAN13 (JAN13)/Codabar (NW-7)/Code39 Interleaved2of5 (ITF)/MSI/ Industrial2of5/Code93/ Code128 (EAN128)/IATA/GS1 DataBarOmnidirectional (RSS-14)/GS1 DataBarLimited (RSS Limited)/GS1 DataBar Expanded (RSS Expanded)/ GS1 DataBar Stacked (RSS-14 Stacked)/GS1 DataBar Expanded Stacked (RSS Expanded Stacked)/GS1 DataBar Truncated)	
C-MOS Imager	Method	CMOS Imager, 832 × 640, monochrome	
	Aimer method	Laser 650nm, <1 mW	
	Laser emit angle	Redirected downward at 25 degree	
	Resolution	1D : 0.127mm Stacked 2D : 0.168mm Matrix 2D : 0.191mm	
	PCS	0.45 (minimum) or greater	
	Readable distance	1D : Approximately 50mm to 400mm Stacked 2D : Approximately 50mm to 230mm Matrix 2D : Approximately 70mm to 300mm	
	Readable width	Max. 43mm (at 50mm depth) Max. 276mm (at 400mm depth)	
	Focal distance	5.0 inches	
	Daylight for scanning	50,000 Lux or less	

Item		Specification	Remark
C-MOS Imager	Readable 1D symbologies	UPC-A/UPC-E/EAN8 (JAN8)/EAN13 (JAN13)/Codabar (NW-7)/Code39 Interleaved2of5 (ITF)/MSI/ISBT/ Code93/Code128 (GS1-128(EAN128)/ GS1 DataBarOmnidirectional (RSS-14)/GS1 DataBarLimited (RSS Limited)/GS1 DataBar Expanded (RSS Expanded)/Code32/GS1 DataBar Truncated(RSS-14 Truncated	
	Readable Stacked 2D symbologies	PDF417/Micro PDF/Composite/ Codablock F/GS1 DataBar Stacked Omnidirectional (RSS-14 Stacked Omnidirectional)/GS1 DataBar Expanded Stacked (RSS Expanded Stacked)/GS1 DataBar Stacked (RSS-14 Stacked)	
	Readable Matrix 2D symbologies	Aztec,DataMatrix,Maxicode,QR Code,Micro QR,	

*2

WLAN Specifications

Item		Specification	Remark
WLAN	Standard	IEEE 802.11a/b/g/n	
	Radio type	Spread Spectrum	
	Modulation type	802.11a/g/n: OFDM (OrthogonalFrequencyDivision Multiplexing) 802.11b: DSSS (Direct Sequence Spread Spectrum) BPSK,QPSK,CCK,16QAM,64QAM	
	Emission Designation	802.11a/g/n D1D, G1D 802.11b : G1D	

Item	Specification	Remark
WLAN	Frequency <Center frequency> IEEE802.11a/n W52:36/40/44/48ch (5.18 to 5.24GHz) W53:52/56/60/64ch (5.26 to 5.32GHz) W56:100/104/108/112/116/120/124/ 128/132/136/140ch (5.50 to 5.70GHz) W58:149/153/157/161/165ch (5.75 to 5.83GHz) IEEE802.11b/g/n 1 to 13ch (2.412 to 2.472GHz) <Frequency range> IEEE802.11a/n 5.15 to 5.35GHz (W52,W53) 5.47 to 5.725GHz (W56) 5.735 to 5.835GHz (W58) IEEE802.11b 2.400 to 2.497GHz IEEE802.11g/n 2.400 to 2.4835GHz	
Baud rate	802.11a/g : 54Mbps (maximum) 802.11b : 11Mbps (maximum) 802.11n : 65Mbps (maximum)	
Communication range	802.11b/g/n : 50m (indoor), 150m (outdoor) (11n is 2.4GHz range) 802.11a/n : 30m (indoor),150m (outdoor) (11n is 5GHz range)	Vary depending on the environment condition
Number of channel	802.11a/n : W52:4,W53:4,W56 : 11 (11n is 5GHz range),W58:5 802.11b/g/n : 13 (11n is 2.4GHz range)	
Channel spacing	802.11a/n : 20MHz (11n is 5GHz range) 802.11b/g/n : 5MHz (11n is 2.4GHz range)	
Channel band width	802.11a/b/g/n : 20MHz	
Other feature	Roaming among Access-Points	
Security	WEP (64/128bit), WPA, WPA2	
WPA encrypted method	TKIP, AES	
Authorize method	PSK, EAP-TLS, PEAP-MSCHAP-V2	

*3

Bluetooth Specifications

Item		Specification	Remark
Bluetooth	Radio type	Spread Spectrum	
	Modulation	Frequency Hopping Spread Spectrum ("FHSS")	
	Modulation type	GFSK(1Mbps), $\Pi/4$ -dqpsk (2Mbps), 8-DPSK (3Mbps)	
	Emission Designation	F1D, G1D	
	Frequency range	2.4000 to 2.4835GHz	
	Communication range	Approx. 5m	Vary depending on the environment conditions
	Number of channels	79	
	Channel spacing	1MHz	
	Channel band width	1MHz	
	Output power	Max. 4dBm (PowerClass2)	

*4,5

W-CDMA/GSM Specifications

Item		Specification	Remark
W-CDMA	Standard	UMTS/W-CDMA : 3GPP release99 HSDPA : 3GPP release5	
	Communication features	Voice, Packet data	IT-G500-GC21E: Packet data only
	Data transfer	Downlink : 14.4Mbps Uplink : 5.76Mbps	
	Modulation type	UMTS/HSDPA/HSUPA	
	Frequency range	<ul style="list-style-type: none"> •Band I Uplink : 1920 to 1980MHz Downlink : 2110 to 2170MHz •Band VIII Uplink : 880 to 915MHz Downlink : 925 to 960MHz 	
	No. of channels	Band I : 277 Band VIII : 152	
	Channel spacing	200kHz	
Channel band width	3.84MHz		
GSM	Standard	3GPP release99	
	Communication features	Voice, Packet data	IT-G500-GC21E: Packet data only
	Data transfer	Downlink : 236.8kbps Uplink : 236.8kbps	
	Modulation type	GSM/GPRS/EDGE	
	Frequency range	<ul style="list-style-type: none"> •GSM850 Uplink : 824 to 849MHz Downlink : 869 to 894MHz •EGSM900 Uplink : 880 to 915MHz Downlink : 925 to 960MHz •DCS1800 Uplink : 1710 to 1785MHz Downlink : 1805 to 1880MHz •PCS1900 Uplink : 1850 to 1910MHz Downlink : 1930 to 1990MHz 	
	Number of channel	GSM850 : 124 EGSM900 : 174 DCS1800 : 374 PCS1900 : 299	
	Channel spacing	200kHz	
	Channel band width	200kHz	

*6

GPS Specifications

Item		Specification	Remark
GPS	General specification	12 channels and receiver, L1 1575.42 MHz, C/A code	
	Positioning system	Standalone-GPS (S-GPS)	
	Protocol	NMEA-0183	
	Sensitivity	Acquisition sensitivity : -145 dBm Tracking sensitivity : -155 dBm	

*7

NFC Specifications

Item		Specification	Remark
NFC	Carrier frequency	13.56MHz±7kHz	
	Antenna	Magnetic loop antenna	
	Field work	Magnetic field strength output 1.5A/m over	Compatible with ISO10373-6
	Bit rate	ISO14443 Type A : 106kbps ISO14443 Type B : 106kbps Felica : 212kbps, 424kbps ISO15693 : 1.65kbps	
	Modulation	ASK	
	Modulation rate	10%, 100% modulation	
	Read range	ISO14443 Type A/B, Felica : 0mm (Contact with case)	
		ISO15693 : 0mm (Contact with case) to 60mm (max)*	*Reference value because different with tag antenna design
	Read area	20mm × 20mm	Dependent on smart card

*8

Above time periods are based on the ratio of cyclic operation of “Standby: Calculation: Scanning: WLAN” at 20:1:1:1, and under the conditions;

Using the USB Cradle (HA-P60IO), Ethernet Cradle (HA-P62IO), Cradle-type Battery Charger (HA-P30CHG)

The optionally available Cradle makes it possible to transmit system data and file data between the Handheld Terminal and a PC via a USB or LAN connection (download or upload). You can also use the Cradle to charge the battery pack installed in the Handheld Terminal.

General Guide

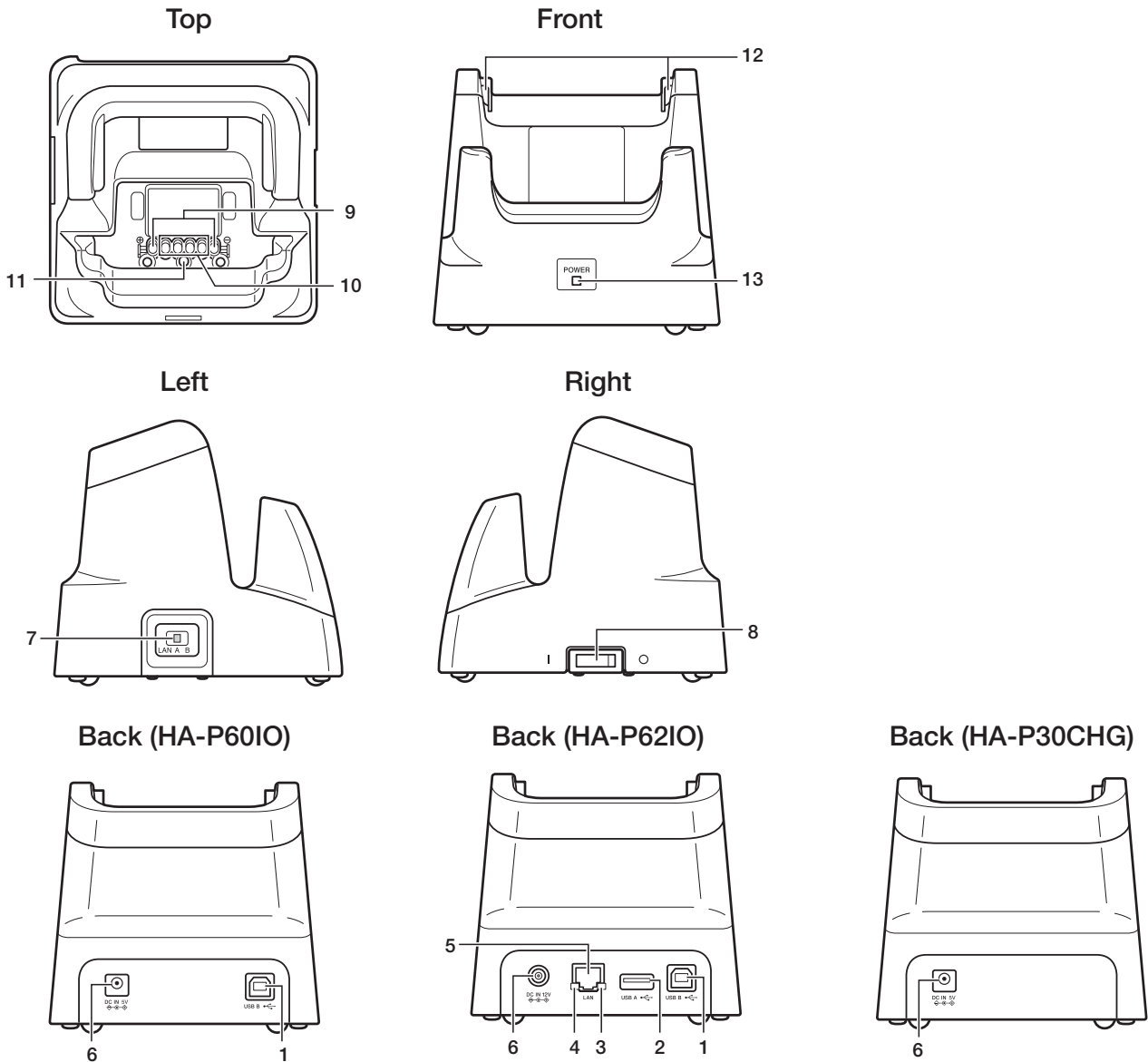

1	USB Client Port	This port is used to transmit data and files (download, upload) by connecting the cradle to a PC using a USB cable (DT-380USB-A). The dedicated driver must be installed in the PC before connecting the cradle to the PC.
2	USB Host Port	This port is used to connect a corresponding USB peripheral device.
3	LAN Connection Status LED	This LED shows the status of the LAN connection. Off: LAN cable not connected correctly. Lit green: LAN cable connected correctly.
4	LAN Communication Status LED	This LED shows the LAN operation status. Off: No communication. Blinking green: Communication in progress.
5	LAN Port	This port is used for connecting the cradle to a PC or hub via a LAN cable so that data and files can be transmitted (uploaded or downloaded). The special driver software must be installed in the IT-G500.
6	AC Adaptor Jack	Connect the AC adaptor here.
7	Selector Switch (Ethernet Cradle only)	This switch is used to switch between a USB connection and a LAN connection.
8	Power Switch (Ethernet Cradle, USB Cradle only)	Turns the power on and off.
9	Power Contacts	Power is supplied to the IT-G500 via these contacts.
10	Data Communication Terminal (Ethernet Cradle, USB Cradle only)	Used for data communications.
11	Terminal Detect Switch	This switch detects when the IT-G500 is seated correctly on the cradle.
12	Mount Hooks	Use these hooks to lock the IT-G500 into the cradle.
13	Power Indicator LED	This LED indicates the power status and the mounting status of the IT-G500. Off: Power off Green: Power on, IT-G500 mounted correctly Red: Power on, IT-G500 not mounted

Connecting the Cradle Power Supply

Use the dedicated AC adapter (sold separately) as the power supply for the USB cradle, Ethernet cradle and cradle-type battery charger.

Power for the IT-G500 is supplied from the connected devices. The Ethernet cradle is used as an example in this description.

1. Plug the AC adaptor into the AC adaptor jack on the back of the Ethernet Cradle.

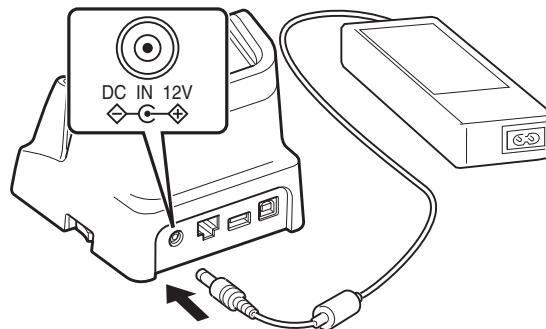

2. After connecting the power cable to the AC adaptor, plug the other end of it into an electrical outlet.

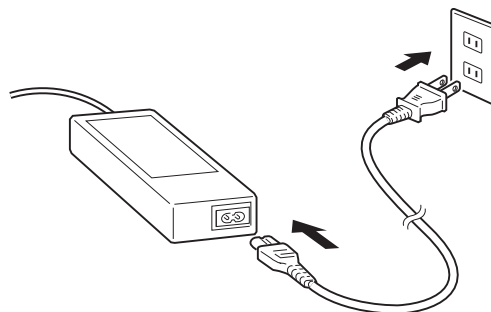

3. Use the selector switch on the left side of the Ethernet Cradle to select the port to be used. Set the switch to the "LAN" position when using the LAN port on the cradle. Set the switch to the "B" position when using the unit as a USB client, or set it to the "A" position when using the unit as a USB host.

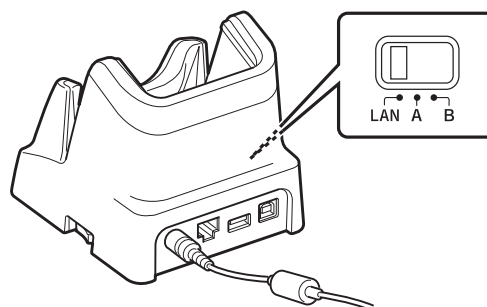

-
4. Before using the cradle ports, remove the caps from the ports.

When using a LAN, connect one end of the LAN cable to the LAN port and the other end to the PC or hub.

When using a USB connection, connect one end of the USB cable (DT-380USB-A) to the USB port and the other end to the PC.

The USB host port is used for connecting the cradle with other USB peripheral device.

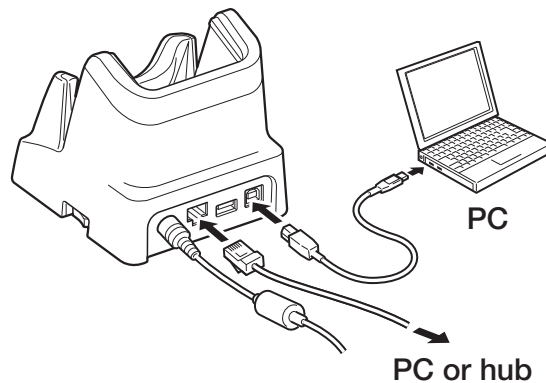

5. Turn on the power switch on the right side of the Ethernet Cradle. The power LED on the front of the Ethernet Cradle lights red.

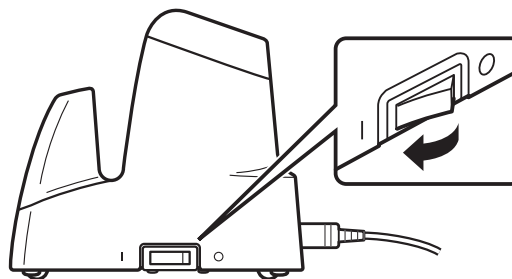

6. Align the contacts on the bottom of the IT-G500 with the power contacts of the Ethernet Cradle when inserting the unit.

The power LED on the front of the Ethernet Cradle will light green if the Handheld Terminal has been properly mounted.

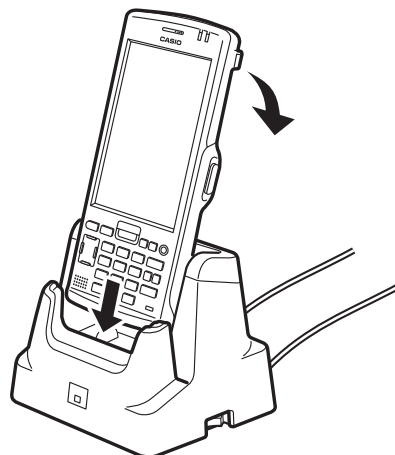

Important!

- Always make sure to first remove the IT-G500 from the Cradle when switching the selector switch.
- Water or other liquids on the data communication or power supply terminals can lead to an electric shock or fire. Note also that soiling on the terminals will impair the connection, leading to reduced power supply and communication functionality. As a safety precaution, disconnect the AC adapter before wiping the data communication and power supply terminals clean with a dry cloth or cotton bud.
- Never short out the power contacts of the Cradle. This can damage the Cradle.
- Note that subjecting the Cradle or cradle-type battery charger to impacts or strong vibration could dislodge the Handheld Terminal. Also avoid any vibration or impacts during communication with a LAN, USB client or USB host, as this can cause communication to be interrupted.
- When loading the IT-G500, fit it securely in place and check that the green power indicator LED on the front of the Cradle is lit. The IT-G500 must be inserted correctly to draw power and communicate successfully.
- Always cap ports that are not being used. Using the Cradle while the ports are uncapped can cause damage.
- Do not pick up the IT-G500 while it is mounted in the Cradle. Doing so may result in the Cradle being accidentally dropped, causing injury or damage.
- If the Cradle will not be used for an extended period, set the power switch to OFF.
- Place the Cradle or cradle-type battery charger on a flat, level surface and take care when placing the IT-G500 in or removing it from the cradle.
- The microUSB port on the Handheld Terminal cannot be used while the terminal is set in the Cradle.

Ethernet Cradle Specifications (HA-P62IO)

1. LAN Specifications

Communications protocol: IEEE 802.3
Media type: 10base-T/100base-TX auto-switched

2. USB

Protocol: USB Ver2.0 Full speed
Transmission Rate: 12Mbps (max.)

3. Charging

Charging Method: Constant current/voltage (the charging circuit is built in IT-G500)

Charge Period: Approximately 4 hours (battery pack)
Approximately 7 hours (large-capacity battery pack)

4. Power Supply

Power Source: AC adaptor (AD-S42120C)
Consumption Current: 12V DC approximately 3.0A
Output to Handheld Terminal: 5V DC 3.0A (max.)
USB Host Output: 5V DC 0.5A (max.)

5. AC Adaptor

Model: AD-S42120C
Input: 100V to 240V AC 50/60Hz 1.2A
Output: 12V DC 3.5A

6. Dimensions and Weight

Dimensions: Approximately 110(W) × 111(D) × 103(H) mm
Weight: Approximately 325g

7. Operating Environment

Temperature: 0°C to 40°C (32°F to 104°F)
Humidity: 10% to 90% RH (non-condensation)

USB Cradle Specifications (HA-P60IO)

1. USB

Protocol: USB Ver2.0 Full speed
Transfer Rate: 12Mbps (max.)

2. Charging

Charging Method: Constant current/voltage
Charge Period: Approximately 4 hours (battery pack)
Approximately 7 hours (large-capacity battery pack)

3. Power Supply

Power Source: AC adaptor (AD-S15050B)
Consumption Current: 12V DC approximately 3.0A
Output to Handheld Terminal: 5V DC 3.0A (max.)
USB Host Output: 5V DC 3.0A (max.)

4. AC Adaptor

Model: AD-S15050B
Input: 100V to 240V AC 50/60Hz 1.2A
Output: 12V DC 3.5A

5. Dimensions and Weight

Dimensions: Approximately 110(W) × 111(D) × 103(H) mm
Weight: Approximately 305g

6. Operating Environment

Temperature: 0°C to 40°C (32°F to 104°F)
Humidity: 10% to 90% RH (non-condensation)

Cradle-type Battery Charger Specifications (HA-P30CHG)

1. Charging Specifications

Charging Method:	Constant current/voltage (the charging circuit is built in IT-G500)
Charge Period:	Approximately 4 hours (battery pack) Approximately 7 hours (large-capacity battery pack)

2. Power Supply

Power Source:	AC adaptor (AD-S15050B)
Consumption Current:	5V DC 3.0A
Output to Handheld Terminal:	5V DC 3.0A (max.)

3. AC Adaptor

Model:	AD-S15050B
Input:	100V to 240V AC 50/60Hz 0.4A
Output:	5V DC 3.0A

4. Dimensions and Weight

Dimensions:	Approximately 110(W) × 111(D) × 103(H) mm
Weight:	Approximately 285g

5. Operating Environment

Temperature:	0°C to 40°C (32°F to 104°F)
Humidity:	10% to 90% RH (non-condensation)

Using the Dual Battery Charger (HA-D32DCHG)

The optionally available dual battery charger (HA-D32DCHG) can be used to simultaneously charge two battery packs.

General Guide

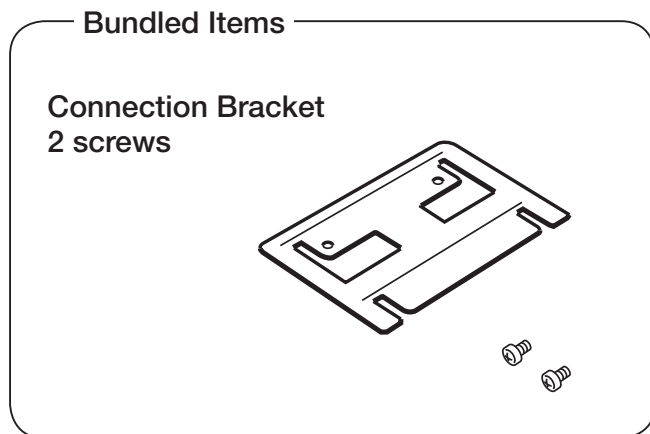
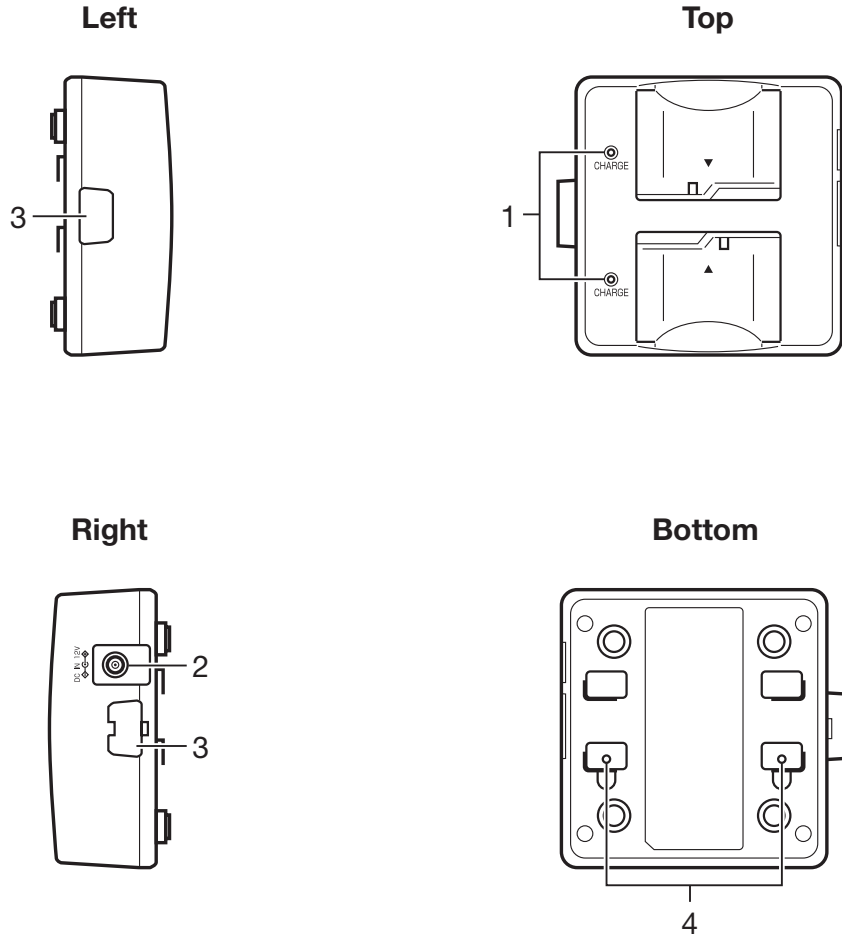

1	Charge Indicator Lamp	This lamp indicates the charge status of the battery pack(s). Off: Not charging Red: Charging Red Flashing: Battery pack problem Green Flashing: Standby Green: Charging complete
2	AC Adaptor Jack	This is used to supply power by connecting the AC adaptor (sold separately).
3	Dual Battery Charger Connection Port	Use this port to connect multiple Dual Battery Chargers to each other.
4	Connection Bracket Attachment Holes	The connection bracket attaches here when you connect multiple Dual Battery Chargers to each other.

Important!

- **Allowing the power contacts become wet can cause an electric shock or fire. In addition, if the contacts become soiled, contact may be impaired resulting in poor charging. For reasons of safety and maintaining charging battery pack(s) in optimum condition, clean the power contacts by wiping with a dry cloth or cotton swab after disconnecting the AC adaptor.**
- **Although the battery may become warm during charging, this is normal and does not indicate a malfunction.**
- **Do not place objects such as a cover over the battery charger while charging.**
- **Do not remove the battery pack or disconnect the AC adaptor during charging.**
- **Repeated “Mounting and Removing” of battery pack in excess of times may cause the quality deterioration of the battery pack.**
- **Each Dual Battery Charger comes with one connection bracket.**
- **Since only one connection bracket is required when you connect two Dual Battery Chargers, you will always have one left over.**
- **Simply keep the other connection bracket on hand as an extra, in case you ever need it.**

Charging a Battery Pack

Use the optionally available AC adaptor (AD-S42120C) for the power supply of the Dual Battery Charger.

1. Plug the cord from the AC adaptor into the AC adaptor jack of the Dual Battery Charger.
2. Plug one end of power cord into the AC adaptor and the other end to a wall outlet.

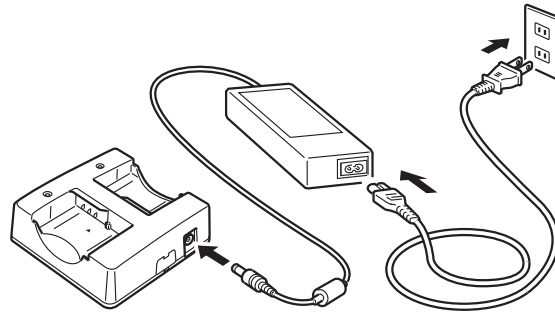

3. Taking care that the battery pack is oriented correctly, insert it into the Dual Battery Charger.

This causes the Charge Indicator Lamp to light in red, indicating that charging has started.

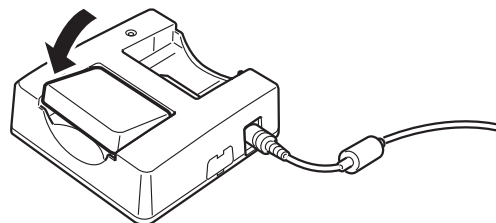

Charge Indicator Lamp

Off:	Not charging
Red:	Charging
Red Flashing:	Battery pack problem
Green:	Charging complete
Green Flashing:	Standby due to the surrounding temperature being beyond the specified temperature range (Approximately 0°- 40°C) (charging resumes when the temperature reaches the range.)

Connecting Multiple Dual Battery Chargers

You can connect up to three Dual Battery Chargers. Doing so makes it possible to supply power to all the Dual Battery Chargers using one dedicated AC adaptor.

1. As shown in the illustrations below, remove the connector covers of the Dual Battery Chargers you want to connect to each other.

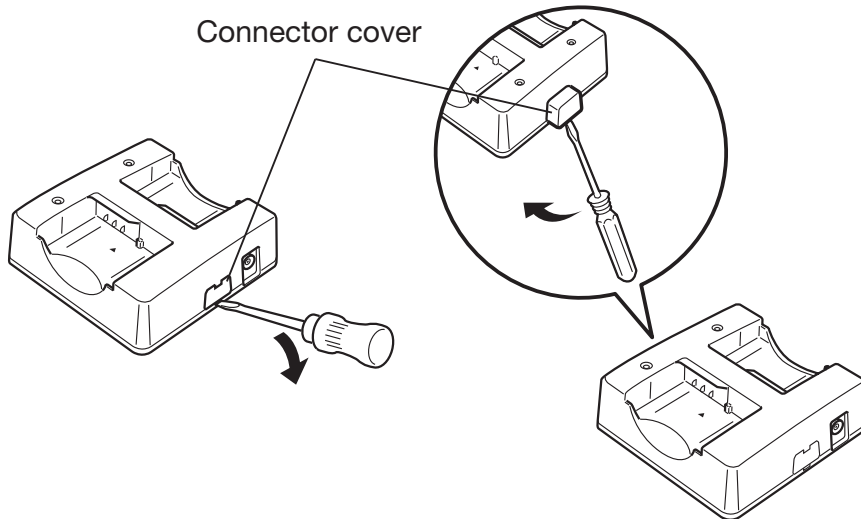

2. Connect the two Dual Battery Chargers as shown below.

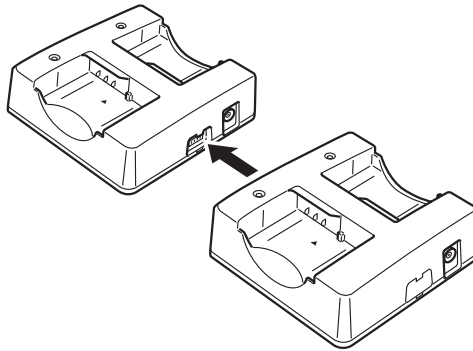

3. Turn over the connected Dual Battery Chargers and attach a connection bracket, securing it in place with screws.

You can repeat the above steps to connect up to 3 Dual Battery Chargers.

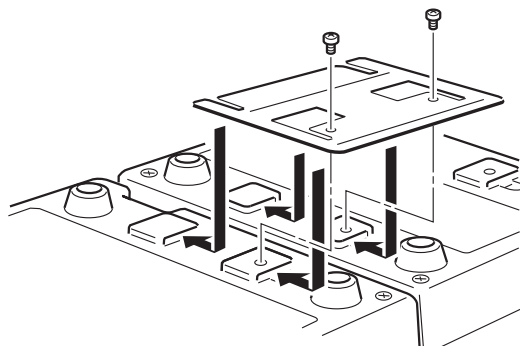

Specifications

- 1. Model:**
HA-D32DCHG
- 2. Charging:**
Charging Method: Constant voltage (with current limiter)
(when one Handheld Terminal has been mounted)
Charge Period: Approx. 2 hours (1 standard battery pack, normal temperature)
Approx. 4 hours (1 large-capacity battery pack, normal temperature)
When charging two battery packs:
Approx. 3.5 hours (2 standard battery packs, normal temperature)
Approx. 7 hours (2 large-capacity battery packs, normal temperature)
- 3. Power Supply:**
Power Source: AD-S42120C
Consumption Current: Approximately 450mA
- 4. AC Adaptor:**
Model: AD-S42120C
Input: 100V to 240V AC 50/60Hz 1.2A
Output: 12V DC 3.5A
Consumption Current: Approximately 450mA
- 5. Operating Environment:**
Temperature: Approximately 0°C to 40°C (32°F to 104°F)
Humidity: 30% to 80% RH (non-condensation)
- 6. Dimensions and Weight:**
Dimensions: Approximately 110(W) × 104(D) × 46(H) mm
Weight: Approximately 195g

Using the microUSB

Connecting to a Computer

You can use the mini-USB cable (HA-N81USBC) to connect the Handheld Terminal to a computer for USB data communication. This also allows you to charge the battery pack installed in the IT-G500 using power supplied from the computer.

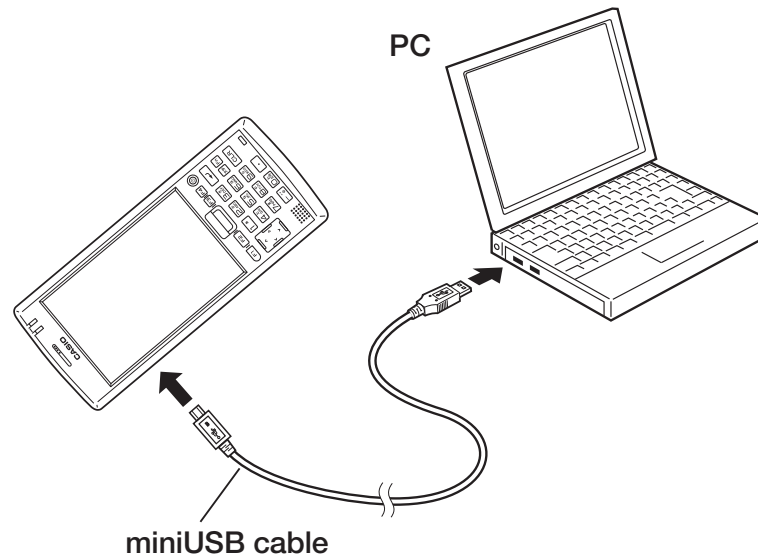

Important!

The micro USB port on the Handheld Terminal cannot be used while the terminal is set in a cradle.

- Always ensure that the cap is fitted onto any unused port. Using the Handheld Terminal with a port uncovered could cause a malfunction.
- The power supplied via the USB cable is limited to 500 mA, so in some situations the battery pack may not be charged and the level of charge may fall when the Handheld Terminal is switched on, depending on how the terminal is used.

Using Rechargeable Battery Packs

HA-D20BAT-A

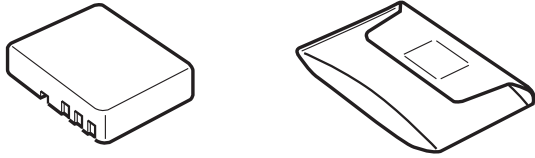

HA-D21LBAT-A

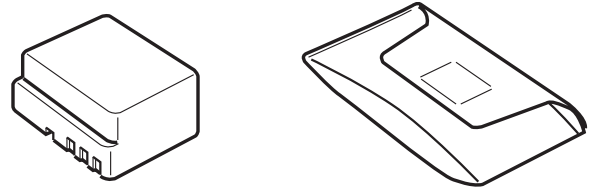

Your Handheld Terminal supports use of two battery pack types, one at a time, of different capacity.

You can select the one that best suits your needs in terms of operating time, the type of options you need to use, etc.

When using the large-capacity battery pack, you need to use the special large-capacity battery pack cover that comes with the terminal.

Important!

- Store a battery pack in its special soft case whenever you are not using it.
- If the battery pack has been left over unused for a long period of time, the capacity remained decreases due to spontaneous discharge or chemical decomposition by the battery pack itself. If the battery pack fails to hold its operating duration after it has been fully charged, replace it with a new one. The battery pack may reach the end of its service life.

Battery Pack Specifications

Model:	HA-D20BAT-A
Rated Capacity:	1850mAh (6.84 Wh)
Rated Voltage:	3.7V
Dimensions:	Approximately 52.5(W) × 40(D) × 13.5(H) mm
Weight:	Approximately 46g
Bundled Item:	Soft case

Large-capacity Battery Pack Specifications

Model:	HA-D21LBAT-A
Rated Capacity:	3700mAh
Rated Voltage:	3.7V
Dimensions:	Approximately 52.5(W) × 40(D) × 25(H) mm
Weight:	Approximately 86g
Bundled Item:	Soft case

Using the Protector (HA-P91BP5, HA-P92BP5)

Use the procedure below when fitting or removing the optional protector (HA-P91BP5 or HA-P92BP5) on the Handheld Terminal.

Fitting the protector onto the Handheld Terminal

1. When fitting the protector, turn it to the side as shown in the illustration.

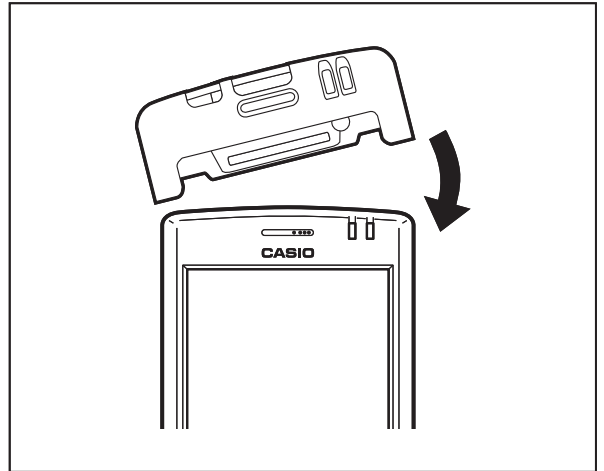

Removing the protector from the Handheld Terminal

1. To remove the protector, turn it to the side as shown in the illustration.

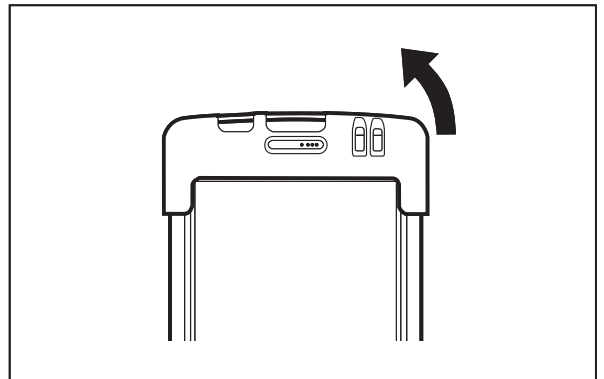

Important!

- Failing to follow the above procedure when fitting or removing the protector on the Handheld Terminal could result in deformation of the protector.
- Repeated fitting and removing will cause protector deformation. Leave the protector in place as much as possible.
- Applying thinners, gasoline, kerosene, solvents or oils, or substances such as cleaners, adhesives, paints, medications or toiletries that contain those materials, to the protector may cause discoloration, deformation or other damage.

CASIO®

CASIO COMPUTER CO., LTD.

6-2, Hon-machi 1-chome
Shibuya-ku, Tokyo 151-8543, Japan