

Statement according to Part 15.105

This equipment has been tested and found to comply with the limits for a Class B digital device, pursuant to Part 15 of the FCC Rules. These limits are designed to provide reasonable protection against harmful interference in a residential installation. This equipment generates, uses and can radiate radio frequency energy and, if not installed and used in accordance with the instructions, may cause harmful interference to radio communications. However, there is no guarantee that interference will not occur in a particular installation. If this equipment does cause harmful interference to radio or television reception, which can be determined by turning the equipment off and on, the user is encouraged to try to correct the interference by one or more of the following measures:

- Reorient or relocate the receiving antenna.
- Increase the separation between the equipment and receiver.
- Connect the equipment into an outlet on a circuit different from that to which the receiver is connected.
- Consult the dealer or an experienced radio/TV technician for help.

1

Statement according to Part 15.19

This device complies with Part 15 of the FCC Rules. Operation is subject to the following two conditions:

- (1) this device may not cause harmful interference, and
- (2) this device must accept any interference received, including interference that may cause undesired operation.

Statement according to Part 15.21

Changes or modifications made to this equipment not expressly approved by CASIO COMPUTER CO., LTD. may void the FCC authorization to operate this equipment.

Caution: Exposure to Radio Frequency Radiation.

To comply with FCC RF exposure compliance requirements, this device must not be co-located or operating in conjunction with any other antenna or transmitter.

2

IC statements

This device complies with Industry Canada licence-exempt RSS standard(s). Operation is subject to the following two conditions: (1) this device may not cause interference, and (2) this device must accept any interference, including interference that may cause undesired operation of the device.

Le présent appareil est conforme aux CNR d'Industrie Canada applicables aux appareils radio exempts de licence. L'exploitation est autorisée aux deux conditions suivantes : (1) l'appareil ne doit pas produire de brouillage, et (2) l'utilisateur de l'appareil doit accepter tout brouillage radioélectrique subi, même si le brouillage est susceptible d'en compromettre le fonctionnement.

Caution: Exposure to Radio Frequency Radiation.

To comply with IC RF exposure compliance requirements, this device must not be co-located or operating in conjunction with any other antenna or transmitter.

3

EU declaration of Conformity

http://ec.europa.eu/enterprise/sectors/rf/e/documents/interpretation/index_en.htm#h2-23

English	Hereby, CASIO COMPUTER CO., LTD , declares that this Bluetooth watch is in compliance with the essential requirements and other relevant provisions of Directive 1999/5/EC.
French	Par la présente CASIO COMPUTER CO., LTD déclare que l'appareil Bluetooth watch est conforme aux exigences essentielles et aux autres dispositions pertinentes de la directive 1999/5/CE Par la présente, CASIO COMPUTER CO., LTD déclare que ce Bluetooth watch est conforme aux exigences essentielles et aux autres dispositions de la directive 1999/5/CE qui lui sont applicables
Spanish	Por medio de la presente CASIO COMPUTER CO., LTD declara que el Bluetooth watch cumple con los requisitos esenciales y cualesquiera otras disposiciones aplicables o exigibles de la Directiva 1999/5/CE.

4

German	Hiermit erklärt CASIO COMPUTER CO., LTD , dass sich dieser/ diese/dieses Bluetooth watch in Übereinstimmung mit den grundlegenden Anforderungen und den anderen relevanten Vorschriften der Richtlinie 1999/5/EG befindet*. (BMWl) Hiermit erklärt CASIO COMPUTER CO., LTD die Übereinstimmung des Gerätes Bluetooth watch mit den grundlegenden Anforderungen und den anderen relevanten Festlegungen der Richtlinie 1999/5/EG. (Wien)
Italian	Con la presente CASIO COMPUTER CO., LTD dichiara che questo Bluetooth watch è conforme ai requisiti essenziali ed alle altre disposizioni pertinenti stabilite dalla direttiva 1999/5/CE.
Portuguese	CASIO COMPUTER CO., LTD declara que este Bluetooth watch está conforme com os requisitos essenciais e outras disposições da Directiva 1999/5/CE.

5

Greek	ΜΕ ΤΗΝ ΠΑΡΟΥΣΑ CASIO COMPUTER CO., LTD ΔΗΛΩΝΕΙ ΟΤΙ Bluetooth watch ΣΥΜΜΟΡΦΩΝΕΤΑΙ ΠΡΟΣ ΤΙΣ ΟΥΣΙΩΔΕΙΣ ΑΠΑΙΤΗΣΕΙΣ ΚΑΙ ΤΙΣ ΛΟΙΠΕΣ ΣΧΕΤΙΚΕΣ ΔΙΑΤΑΞΕΙΣ ΤΗΣ ΟΔΗΓΙΑΣ 1999/5/ΕΚ
Dutch	Hierbij verklaart CASIO COMPUTER CO., LTD dat het toestel Bluetooth watch in overeenstemming is met de essentiële eisen en de andere relevante bepalingen van richtlijn 1999/5/EG Bij deze verklaart CASIO COMPUTER CO., LTD dat deze Bluetooth watch voldoet aan de essentiële eisen en aan de overige relevante bepalingen van Richtlijn 1999/5/EC.
Danish	Undertegnede CASIO COMPUTER CO., LTD erklærer herved, at følgende udstyr Bluetooth watch overholder de væsentlige krav og øvrige relevante krav i direktiv 1999/5/EF

6

Finnish	CASIO COMPUTER CO., LTD vakuuttaa täten että Bluetooth watch tyypinen laite on direktiivin 1999/5/EY oleellisten vaatimusten ja sitä koskevien direktiivin muiden ehtojen mukainen.
Swedish	Härmed intygar CASIO COMPUTER CO., LTD att denna Bluetooth watch står i överensstämmelse med de väsentliga egenskapskrav och övriga relevanta bestämmelser som framgår av direktiv 1999/5/EG.

The copy of the Declaration of Conformity can be found on <http://world.casio.com/ce/BLE/>



7

8

Other countries and regions where the product complies with or has received under approval under radio laws

Korea, Republic of



MSIP-CRM-CAI-W005

한국에서의 사용에 대해서는 전자파 적합의 인증 또는 등록을 받고 있습니다.

전파 간섭에 관한 주의

해당 무선 설비 기기는 운용 중 전파혼신 가능성이 있으므로 인명안전과 관련된 서비스는 할 수 없음.

- 제품명/형식명 : 특정소출력 무선기기(무선데이터통신시스템용 무선기기) / EQB-500
- 신청자명 : CASIO COMPUTER CO., LTD.
- 제조자명 : CASIO COMPUTER CO., LTD.
- 원산국 : 중국
- 제조년월일 : 시계 뒷면 덮개의 일련번호* 참조

* 일련번호

X X X X X X X X X X X X X (11자리)

① ②

①서기 아래 2자리

②생산월일(1월 1일부터 적산)

9

10

Singapore

Australia, New Zealand

Complies with
IDA Standards
DB104881



Israel

שם היצרן: קסיו מחשבים תאגיד בע"מ
שם הדגם: QW-5419
ארץ ייצור: סין
שם היבואן: טו אנד אי מרקטינג בע"מ
כתובת היבואן: קיבוץ גלילות 34, תל-אביב 6655018

11

12

13

14

15

MA1407-A

Mode changes as follows each time you press the button.

- Press and hold the A button for approximately 2 seconds, to switch to the calendar mode.

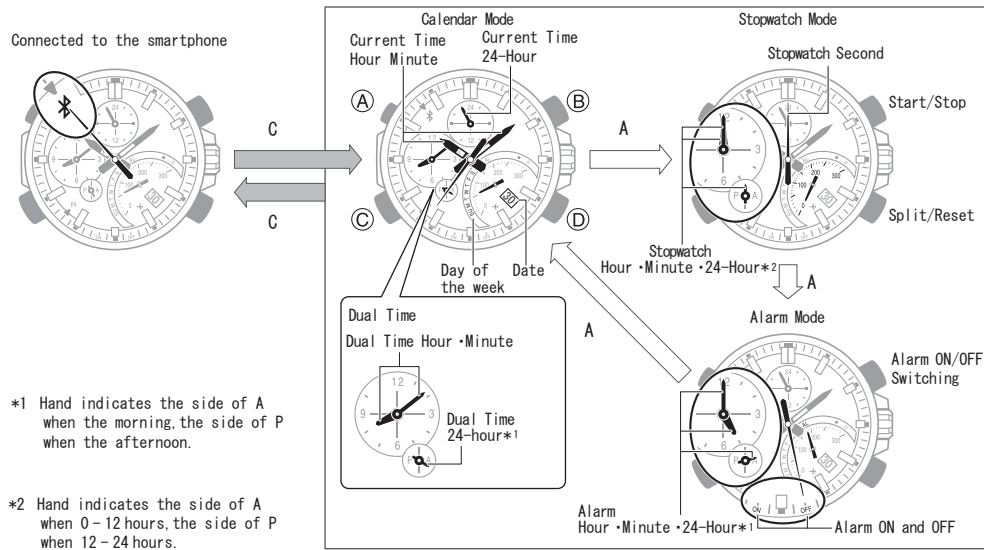

◆ Using the Crown (Before using the crown, please loosen by turning the crown to the left.)

Pulling to the first stop
(Correction of Dual Time, Alarm)

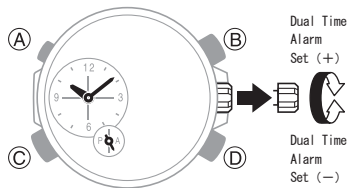

Pulling to the second stop
(Correction of the Current Time)

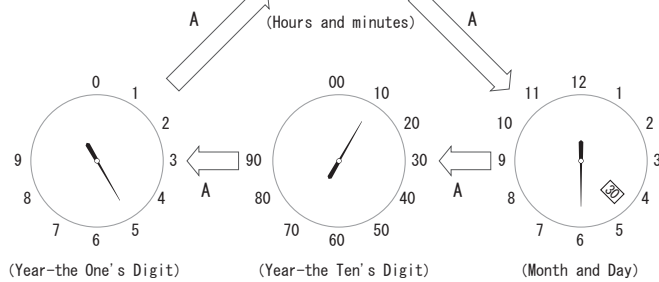
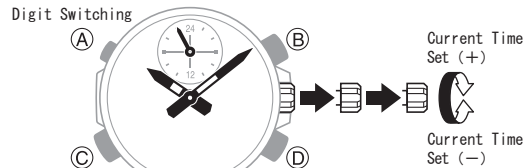

◆ For Display of the Dial

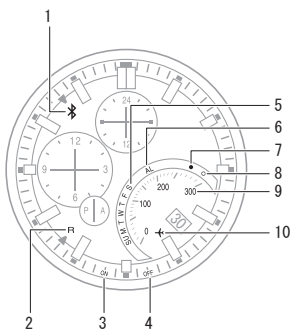

- 1: Bluetooth: In Connection
- 2: Bluetooth: Waiting for Connection
- 3: ON: Alarm On
- 4: OFF: Alarm Off
- 5: SU/M/T/W/T/F/S: Day of the Week
- 6: AL: Alarm Mode
- 7: ●: Received E-mails
- 8: ○: Not Received E-mails
- 9: 0...100...200...300: Speed
- 10: ✈: Airplane Mode

Statement according to Part 15.105

This equipment has been tested and found to comply with the limits for a Class B digital device, pursuant to Part 15 of the FCC Rules. These limits are designed to provide reasonable protection against harmful interference in a residential installation. This equipment generates, uses and can radiate radio frequency energy and, if not installed and used in accordance with the instructions, may cause harmful interference to radio communications. However, there is no guarantee that interference will not occur in a particular installation. If this equipment does cause harmful interference to radio or television reception, which can be determined by turning the equipment off and on, the user is encouraged to try to correct the interference by one or more of the following measures:

- ? Reorient or relocate the receiving antenna.
- ? Increase the separation between the equipment and receiver.
- ? Connect the equipment into an outlet on a circuit different from that to which the receiver is connected.
- ? Consult the dealer or an experienced radio/TV technician for help.

1

Statement according to Part 15.19

This device complies with Part 15 of the FCC Rules.

Operation is subject to the following two conditions:

- (1) this device may not cause harmful interference, and
- (2) this device must accept any interference received, including interference that may cause undesired operation.

Statement according to Part 15.21

Changes or modifications made to this equipment not expressly approved by CASIO COMPUTER CO., LTD. may void the FCC authorization to operate this equipment.

Caution: Exposure to Radio Frequency Radiation.

To comply with FCC RF exposure compliance requirements, this device must not be co-located or operating in conjunction with any other antenna or transmitter.

2

IC statements

This device complies with Industry Canada licence-exempt RSS standard(s). Operation is subject to the following two conditions: (1) this device may not cause interference, and (2) this device must accept any interference, including interference that may cause undesired operation of the device.

Le présent appareil est conforme aux CNR d'Industrie Canada applicables aux appareils radio exempts de licence. L'exploitation est autorisée aux deux conditions suivantes : (1) l'appareil ne doit pas produire de brouillage, et (2) l'utilisateur de l'appareil doit accepter tout brouillage radioélectrique subi, même si le brouillage est susceptible d'en compromettre le fonctionnement.

Caution: Exposure to Radio Frequency Radiation.

To comply with IC RF exposure compliance requirements, this device must not be co-located or operating in conjunction with any other antenna or transmitter.

3

EU declaration of Conformity

http://ec.europa.eu/enterprise/sectors/rtte/documents/interpretation/index_en.htm#2-23

English	Hereby, CASIO COMPUTER CO., LTD, declares that this Bluetooth watch is in compliance with the essential requirements and other relevant provisions of Directive 1999/5/EC.
French	Par la présente CASIO COMPUTER CO., LTD déclare que l'appareil Bluetooth watch est conforme aux exigences essentielles et aux autres dispositions pertinentes de la directive 1999/5/CE Par la présente, CASIO COMPUTER CO., LTD déclare que ce Bluetooth watch est conforme aux exigences essentielles et aux autres dispositions de la directive 1999/5/CE qui lui sont applicables
Spanish	Por medio de la presente CASIO COMPUTER CO., LTD declara que el Bluetooth watch cumple con los requisitos esenciales y cualesquiera otras disposiciones aplicables o exigibles de la Directiva 1999/5/CE

4

German	Hiermit erklärt CASIO COMPUTER CO., LTD, dass sich dieser/diese/dieses Bluetooth watch in Übereinstimmung mit den grundlegenden Anforderungen und den anderen relevanten Vorschriften der Richtlinie 1999/5/EG befindet". (BMW i) Hiermit erklärt CASIO COMPUTER CO., LTD die Übereinstimmung des Gerätes Bluetooth watch mit den grundlegenden Anforderungen und den anderen relevanten Festlegungen der Richtlinie 1999/5/EG. (Wien)
Italian	Con la presente CASIO COMPUTER CO., LTD dichiara che questo Bluetooth watch è conforme ai requisiti essenziali ed alle altre disposizioni pertinenti stabilite dalla direttiva 1999/5/CE.
Portuguese	CASIO COMPUTER CO., LTD declara que este Bluetooth watch está conforme com os requisitos essenciais e outras disposições da Directiva 1999/5/CE.

5

Greek	ΜΕ ΤΗΝ ΠΑΡΟΥΣΑ CASIO COMPUTER CO., LTD ΔΗΛΩΝΕΙ ΟΤΙ Bluetooth watch ΣΥΜΜΟΡΦΩΝΕΤΑΙ ΠΡΟΣ ΤΙΣ ΟΥΣ ΙΩΑΕΙΣ ΑΠΑΙΤΗΣΕΙΣ ΚΑΙ ΤΙΣ ΛΟΙΠΕΣ ΣΧΕΤΙΚΕΣ ΔΙΑΤΑΞΕΙΣ ΤΗΣ ΟΔΗΓΙΑΣ 1999/5/ΕΚ
Dutch	Hierbij verklaart CASIO COMPUTER CO., LTD dat het toestel Bluetooth watch in overeenstemming is met de essentiële eisen en de andere relevante bepalingen van richtlijn 1999/5/EG Bij deze verklaart CASIO COMPUTER CO., LTD dat deze Bluetooth watch voldoet aan de essentiële eisen en aan de overige relevante bepalingen van Richtlijn 1999/5/EC.
Danish	Undertegnede CASIO COMPUTER CO., LTD erklærer herved, at følgende udstyr Bluetooth watch overholder de væsentlige krav og øvrige relevante krav i direktiv 1999/5/EF

6

Finnish	CASIO COMPUTER CO., LTD vakuuttaa täten että Bluetooth watch tyypinen laite on direktiivin 1999/5/EY oleellisten vaatimusten ja sitä koskevien direktiivin muiden ehtojen mukainen.
Swedish	Härmed intygar CASIO COMPUTER CO., LTD att denna Bluetooth watch står i överensstämmelse med de väsentliga egenskapskrav och övriga relevanta bestämmelser som framgår av direktiv 1999/5/EG.

The copy of the Declaration of Conformity can be found on <http://world.casio.com/ce/BLE/>

CE 1731

7

8

Mode changes as follows each time you press the button.

- Press and hold the A button for approximately 2 seconds, to switch to the calendar mode.

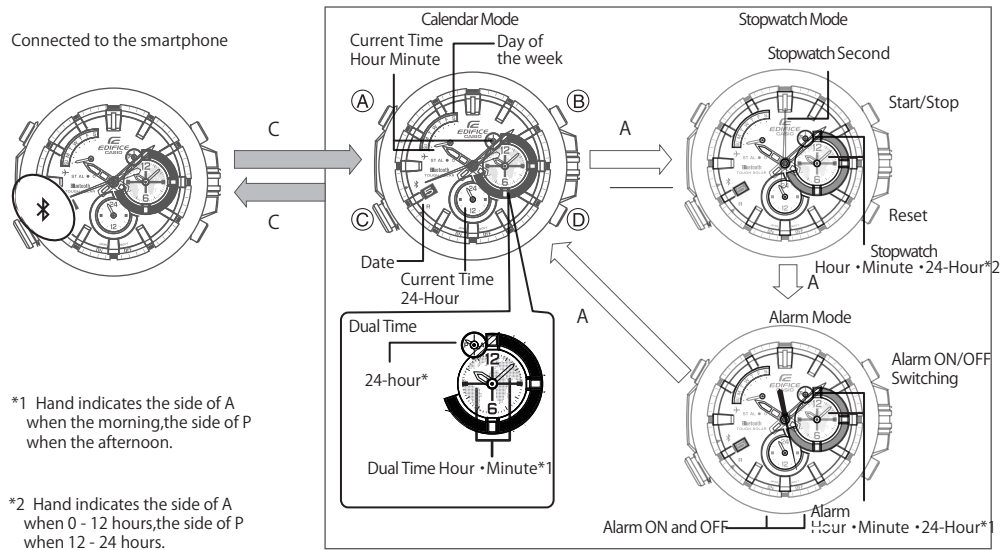

◆ Using the Crown (Before using the crown, please loosen by turning the crown to the left.)

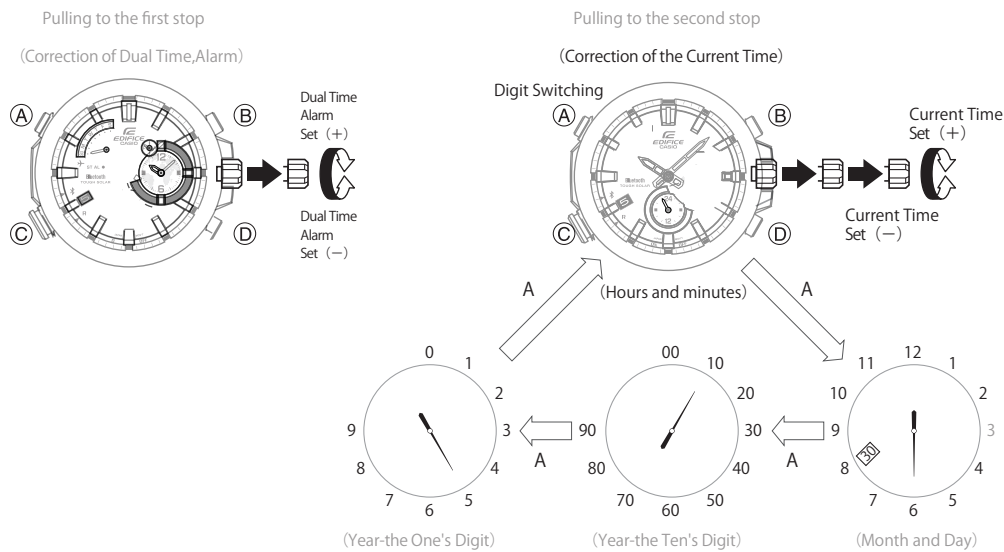

◆ For Display of the Dial

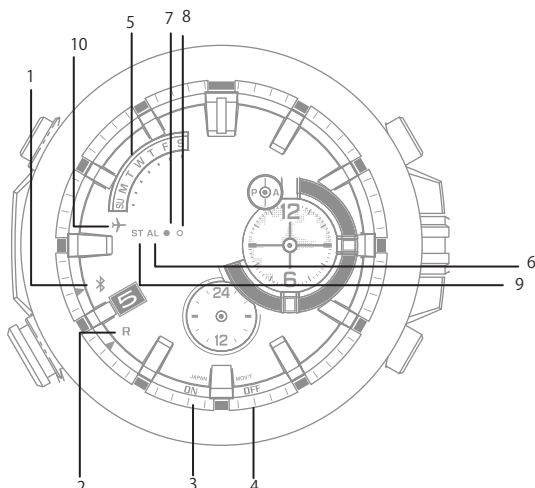

1. Bluetooth: In Connection
2. R: Bluetooth: Waiting for Connection
3. ON: Alarm On
4. OFF: Alarm Off
5. SU/M/T/W/T/F/S: Day of the Week
6. AL: Alarm Mode
7. ●: Received E-mails
8. ○: Not Recived E-mails
9. ST: Stopwatch Mode
10. ✈: Airplane Mode