

Interactive Pointer YA-P10

取扱説明書

本書は、お読みになった後も大切に保管してください。

日本語

User's Guide

Be sure to keep all user documentation handy for future reference.

English

Bedienungsanleitung

Bitte bewahren Sie die gesamte Benutzerdokumentation für späteres Nachschlagen auf.

Deutsch

Mode d'emploi

Conservez la documentation à portée de main pour toute référence future.

Français

Guía del usuario

Asegúrese de tener a mano toda la documentación del usuario para futuras consultas.

Español

Guida dell'utilizzatore

Conservare l'intera documentazione dell'utente a portata di mano per riferimenti futuri.

Italiano

Instruktionshäfte

Förvara all användardokumentation nära till hands för framtida referens.

Svenska

用戶說明書

請務必將所有用戶文件妥善保管以便日後需要時查閱。

中文（繁）

사용설명서

만약을 대비하여 사용설명서 등은 소중히 보관해 주십시오.

한국어

Kullanım Kılavuzu

Gelecekte ihtiyaç duyabileceğiniz için bütün kullanım dokümantasyonunu özenle saklayınız.

Türkçe

ИНСТРУКЦИЯ ПО ЭКСПЛУАТАЦИИ

Обязательно храните всю пользовательскую документацию под рукой, чтобы пользоваться ею для справки в будущем.

Русский

Guia do Usuário

Certifique-se de guardar toda a documentação do usuário à mão para futuras referências.

Português

Contents

Safety Precautions	E-3
Operating Precautions.	E-7
Unpacking	E-8
Using the CD-ROM	E-9
General Guide	E-10
Setup	E-11
Using the Pointer.	E-15
Indicators.	E-18
Troubleshooting	E-19
Disposing of a Pointer	E-21
Specifications	E-23



- The term “pointer” in this manual refers the YA-P10 interactive pointer.

- The contents of this User’s Guide are subject to change without notice.
- Copying of this manual, either in part or its entirety, is forbidden. You are allowed to use this manual for your own personal use. Any other use is forbidden without the permission of CASIO COMPUTER CO., LTD.
- CASIO COMPUTER CO., LTD. shall not be held liable for any lost profits or claims from third parties arising out of the use of this product or this manual.
- CASIO COMPUTER CO., LTD. shall not be held liable for any loss or lost profits due to loss of data caused by malfunction or maintenance of this product, or any other reason.

Safety Precautions

About safety symbols

Various symbols are used in this User's Guide and on the product itself to ensure safe use, and to protect you and others against the risk of injury and against material damage. The meaning of each of the symbols is explained below.

 Warning	This symbol indicates information that, if ignored or applied incorrectly, could possibly create the risk of death or serious personal injury.
 Caution	This symbol indicates information that, if ignored or applied incorrectly, could possibly create the risk of personal injury or material damage.

Icon Examples



A triangle indicates a situation against which you need to exercise caution. The example shown here indicates you should take precaution against electric shock.



A circle with a line through it indicates information about an action that you should not perform. The specific action is indicated by the figure inside the circle. The example shown here means disassembly is prohibited.



A black circle indicates information about an action that you must perform. The specific action is indicated by the figure inside the circle. The example shown here indicates you must unplug the power cord from the power outlet.

Warning

- **Avoid water and other liquids.**



Never allow the pointer to become wet. Water and other liquids create the risk of fire and electric shock.

- **Do not disassemble or modify the pointer in any way.**



Never try to take the pointer apart or modify it in any way. Doing so creates the risk of electric shock, burn injury, personal injury, or operational malfunction. Disassembling or modifying the pointer can void its warranty or make it ineligible for servicing. Request all servicing and repair from your original retailer or the contact specified for repair.

- **Do not dispose of the pointer by burning it.**



Never try to dispose of the pointer by burning it. Doing so can cause an explosion, which creates the risk of fire and personal injury.

- **Do not use or leave the pointer in any of the following locations.**

Doing so creates the risk of fire and electric shock.

- Areas subject to large amounts of moisture or dust
- In a kitchen or other areas exposed to oil smoke
- Near a heater, on a heated carpet, or in an area exposed to direct sunlight
- Other areas subjected to temperature extremes

- **Never leave the pointer in a bathroom or anywhere else there is the chance that it will become wet.**

- **Immediately stop using the pointer whenever any one of the following conditions exists.**

Failure to do so creates the risk of fire, electric shock, or overheating of batteries, and explosion.

- When the pointer is damaged due to dropping
- When the pointer is emitting smoke or strange odor, when the pointer does not operate normally even when used as instructed by the user's guide, or any other time malfunction of the pointer is suspected

In any of the above cases request servicing and repair from your original retailer or the contact specified for repair.

- **Avoid dropping the pointer or otherwise subjecting it to impact or shock.**

Failure to do so creates the risk of fire, electric shock, or overheating of batteries, and explosion.

- **Use only the special cable that comes with the pointer when charging it.**

Failure to do so creates the risk of fire, electric shock, or overheating of batteries, and explosion.

- **Radio waves emitted by the pointer**



Never use this product inside of an aircraft or medical facility, or in any other location where use of such devices is prohibited. Radio waves can have an effect on the operation of electronic equipment and medical equipment, and cause accidents.



Do not use this product in the vicinity of high-precision electronic instruments or electronic devices that handle weak radio signals. Radio waves can have an effect on the operation of such equipment, and cause accidents.

- If you are using a pace maker or any other electronic medical device, be sure to consult your physician or device manufacturer before using this product.



Caution

- **Be sure to follow all applicable local laws and regulations when disposing of the pointer.**

Operating Precautions

- Never use or store the pointer in the following locations. Doing so creates the risk of malfunction of and damage to the pointer.
 - Locations prone to electrostatic charge
 - Locations subjected to temperature extremes
 - Locations where there is extreme moisture
 - Locations subjected to sudden temperature changes
 - Locations where there is a lot of dust
 - Locations where there is the danger of getting wet
- Do not use the pointer in environments subjected to temperature extremes. The pointer is designed for use within the temperatures of 5°C to 35°C (41°F to 95°F). Use outside of this temperature range creates the risk of malfunction of and damage to the pointer.
- When cleaning the pointer, wipe it with a soft, dry cloth. Any other type of cleaning method creates the risk of malfunction or breaking of the pointer.
- Use in Other Countries
This product has been certified as complying with the wireless regulations in the country of purchase. Be sure to use it only in the country where you purchased it. Use of this product in another country may be illegal.

Unpacking

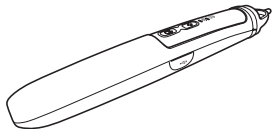

Pointer

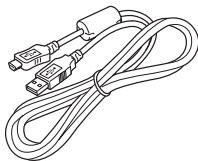

USB Cable
(Type A to Type Mini B)
(For pointer charging)

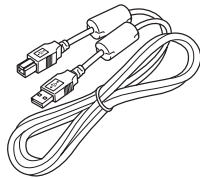

USB Cable
(Type A to Type B)

- Strap
- CD-ROM
- User's Guide (This Manual)
- Warranty

Using the CD-ROM

The CD-ROM that comes with the pointer contains a Presentation Draw application that provides various projector presentation tools, and a PDF file version of its User's Guide. Your computer will need to have Adobe® Reader® installed in order for you to view the PDF User's Guide.

The PDF User's Guide also includes information about the minimum computer system requirements for Presentation Draw, and the procedure for installing it. Be sure to read the User's Guide before installation.

To view the contents of a User's Guide (PDF)

1. Place the CD-ROM that comes with the pointer into your computer's CD-ROM drive.
2. Perform either of the following operations.
 - If the CD-ROM menu screen appears:
 - ① On the menu screen, click the [Open Folder] button to the right of "User's Guide".
 - ② When the User's Guide folder opens, open the folder that corresponds to the language you want to use.
 - If the CD-ROM menu screen does not appear:
 - ① On your computer, navigate to the CD-ROM and then open it.
 - ② Open the User's Guide folder and then open the folder that corresponds to the language you want to use.
3. Double-click the User's Guide file.

General Guide

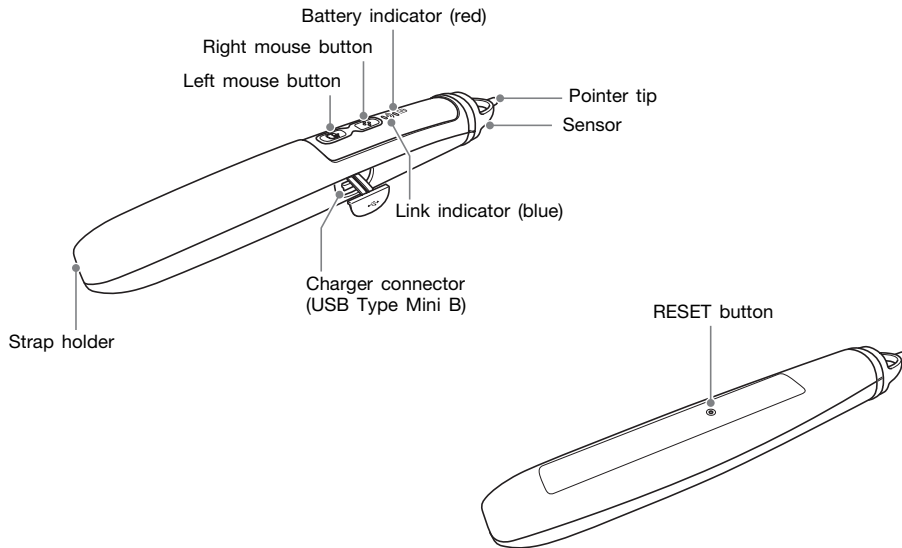

Setup

Charging the Pointer

Use the supplied USB cable (Type A to Type Mini B) to connect the pointer to your computer as shown nearby.

- The battery indicator is lit (red) while charging is in progress and goes out after charging is complete.
- Charging takes about 2.5 hours.

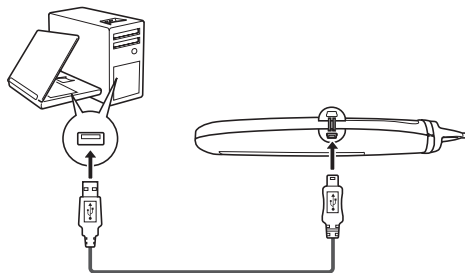

A to Mini B



Warning

If charging is not complete within the prescribed amount of time, disconnect the cable from the pointer and stop charging. Failure to do so creates the risk of battery overheating, fire, and explosion.



Caution

Fluid leaking from a battery that gets onto your skin or clothing can cause skin irritation. If this happens, immediately rinse the area with clean water.

Important!

- Connecting the pointer to a computer for charging, make sure that the computer is connected to an AC power source to ensure a stable power supply.
- If your computer does not supply power via its USB port when turned off, leave your computer turned on while charging the pointer.
- The pointer cannot be used while it is being charged.

Installing the Software that Comes with the Pointer on a Computer

See the Presentation Draw User's Guide on the CD-ROM that comes with the pointer.

Connecting a Computer to the Projector

In order to use the pointer as a computer pointing device, there must be a USB connection between the computer and the projector. To project the computer screen contents with the projector, you also need to connect the analog RGB output terminal of the computer to the projector's COMPUTER IN terminal. Connect as shown in the illustration below.

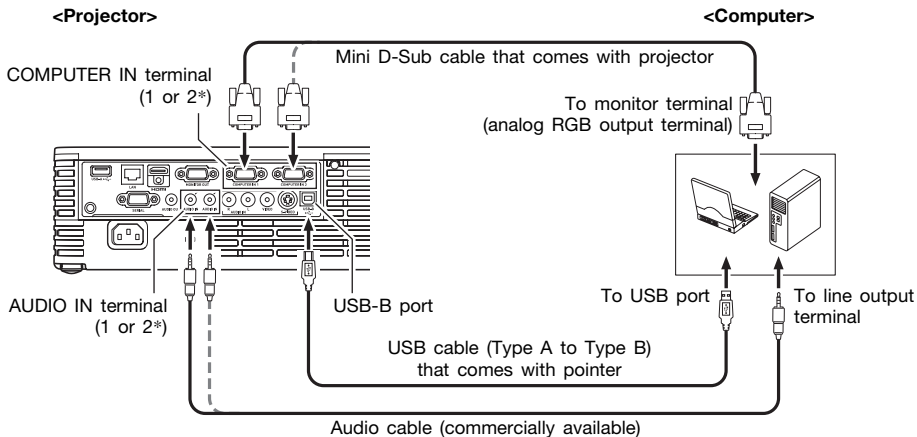

* Some models have only one COMPUTER IN and one AUDIO IN terminal.

Important!

- After connection is complete, be sure to change the projector's "Option Settings 2→Interactive Pointer" setting to "On". For more information, see the User's Guide on the CD-ROM that comes with the projector.
- Be sure to make the RGB output of the computer connected to the projector the primary monitor. The pointer will not operate properly if it is the secondary monitor. For information about configuring monitor settings, see the user documentation that came with your computer, computer help, etc.

Using the Pointer

Holding the Pointer

Hold the pointer securely as shown in the illustrations below.

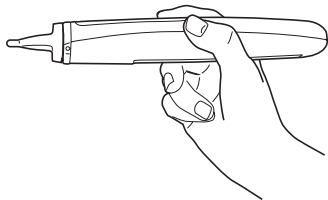

or

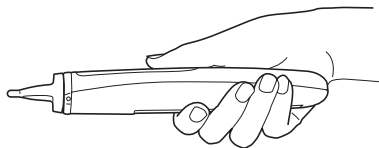

To start a pointer operation

1. Press the pointer left mouse button or right mouse button.
 - This turns on the pointer and causes the link indicator to start flashing.
2. Holding the pointer securely, point the pointer tip at the projected image.
 - The link indicator will go from flashing to lit when a link between the pointer and projector is established.
 - Pointer operations (page E-17) are enabled at this time.



NOTE

- After establishing a connection between the pointer and the projector, the link indicator will go out if you move the pointer tip so it is not pointed at the projected image. You can reestablish the connection by pointing the pointer tip at the projected image within about one minute after the link indicator goes out.
- If you do not perform any operation for a few minutes after the link indicator goes out, the pointer will turn off automatically.

Pointer Operations

The following pointer operations are supported on the projected image of a computer's RGB output.

Left-click : Use the pointer tip to point at the location where you want to click (it is not necessary to touch the screen with the pointer tip), and then press the left mouse button. Or you could lightly touch the pointer tip to the location where you want to click.

Right-click : Use the pointer tip to point at the location where you want to click (it is not necessary to touch the screen with the pointer tip), and then press the right mouse button.

















Drag : Point the pointer tip at the location from which you want to start dragging (it is not necessary to touch the screen with the pointer tip). Next, hold down the left mouse button as you drag the pointer tip. When you reach the end of the drag, release the left mouse button. You also could lightly touch the tip of the pointer at the drag start point and drag on the screen, keeping it lightly against the screen the whole way. When you reach the end of the drag, remove the pointer tip from the screen.



Important!

- When using the pointer, take care to ensure that the pointer tip is not within any shadow cast onto the projected image. The pointer will not function properly while its tip is within a shadow.

Indicators

The following shows the pointer status as indicated by the indicators.

Indicator		Pointer Status
		
		Turned off
		Searching for projector
		Linked with projector and standing by for interactive pointer operation. Or in use as interactive pointer.
 	 	Powering down*
		Battery is charging or battery power is low (approximately 20% of full charge).
		Very low battery power (approximately 10 % of full charge)

 : Battery indicator (red)  : Link indicator (blue)

 : Lit  : Flashing  : Unlit

* The pointer will turn off automatically and both indicators will go out if no pointer operation is performed for a few minutes or if a few minutes elapse after the link between the pointer and projector is broken. A few seconds immediately before this happens, the link indicator will flash and then both indicators will light.

Troubleshooting

Check the following items whenever you experience any problem while using the pointer.

Problem	Possible cause and recommended action
Pointer does not function at all or only functions intermittently.	<ul style="list-style-type: none">● If the pointer's battery indicator is flashing or light, it means that the pointer battery level is low. Charge the pointer. See "Charging the Pointer" (page E-11).● There may be a problem with the USB connection between the computer and projector. Check the connection. See "Connecting a Computer to the Projector" (page E-13).● "Off" may be selected for the projector's "Option Settings 2 → Interactive Pointer" setting. Change the setting to "On". For more information, see the User's Guide on the CD-ROM that comes with the projector.● Lighting in the location where you are projecting may be too bright. Take measures to reduce the brightness of the lighting.● The pointer tip may be within a shadow cast onto the projected image. Operate the pointer taking care to keep the tip out of shadows.● Another mouse operation may be being performed on the computer at the same time you are performing a pointer operation. Do not allow any mouse operations to be performed on the computer during pointer operations.

Problem	Possible cause and recommended action
<p>Pointer does not function at all or only functions intermittently.</p>	<ul style="list-style-type: none"> ● The projector may be in the 3D input mode. Switch the projector to the normal input mode. For more information, see the User's Guide on the CD-ROM that comes with the projector. ● The projector may be projecting an image from an input source that is not from the USB connected computer. Select the USB connected computer as the input source and try projecting again. ● Pointer operation may be unstable for some reason. Press the RESET button (page E-10).
<p>The location on the projected image that is selected is different from the location I click.</p>	<ul style="list-style-type: none"> ● Hold the pointer securely as close as possible to the screen when performing click operations. ● The pointer tip may be within a shadow cast onto the projected image. Operate the pointer taking care to keep the tip out of shadows.

Disposing of a Pointer

When disposing of a pointer, use the procedure below to remove its built-in rechargeable lithium-ion battery and take the battery in for recycling.

● **Handling rechargeable batteries (Please recycle!)**

Be sure to recycle no longer needed batteries to help conserve precious resources. Contact your original dealer or authorized CASIO service center for information about recycling.

● **Precautions when handling old rechargeable batteries**

- Insulate the connectors with tape, etc.
- Do not remove the covering.
- Never try to take batteries apart.

Removing the rechargeable lithium-ion battery

1. Remove the back label.
2. Use a Phillips head (+) screwdriver to remove the two screws.
3. Remove the front case (the side with the buttons and indicators).
 - If the front case is difficult to remove, insert a flat blade (-) screwdriver into the gap of the case and then open it.
4. Disconnect the rechargeable lithium-ion battery connector and then remove the battery.
5. Do not dispose of the battery. Be sure to take it in for recycling.
 - Contact your original dealer or authorized CASIO service center for information about recycling.
6. After removing the lithium-ion battery, be sure to dispose of the pointer in accordance with the laws, rules, and regulations in your geographic area.

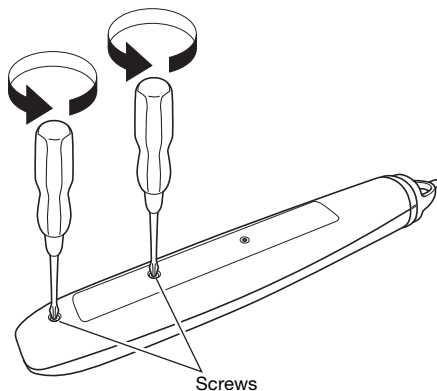

Specifications

Operating Frequency	2.4GHz ISM band
Power Requirements	Lithium-ion battery Normal voltage/capacitance: 3.7V DC, 800mAh
Battery Operation Time	Approximately 30 to 35 hours (on a full charge)
Environment	Operating temperature: 5 to 35°C (41 to 95°F) Operating humidity: 20 to 80% (non-condensation)
Rated Power	5V DC Approximately 2W
Dimensions	Approximately 210mm/8.3" (long), 28.5mm/1.1" (diameter)
Weight	Approximately 75g/2.6oz

- The above "Battery Operation Time" is a general reference value that indicates the time from the start of operation with a new, fully charged battery. This time is not guaranteed. Also note that repeated charging can cause a battery to gradually lose its ability to retain a charge.
- Use under low temperatures also can shorten the battery operation time.
- Specifications are subject to change without notice.

The U.S.A. and Canada

GUIDELINES LAID DOWN BY FCC RULES FOR USE OF THIS UNIT IN THE U.S.A. (not applicable to other areas).

NOTICE

This equipment has been tested and found to comply with the limits for a Class B digital device, pursuant to Part 15 of the FCC Rules. These limits are designed to provide reasonable protection against harmful interference in a residential installation. This equipment generates, uses and can radiate radio frequency energy and, if not installed and used in accordance with the instructions, may cause harmful interference to radio communications. However, there is no guarantee that interference will not occur in a particular installation. If this equipment does cause harmful interference to radio or television reception, which can be determined by turning the equipment off and on, the user is encouraged to try to correct the interference by one or more of the following measures:

- Reorient or relocate the receiving antenna.
- Increase the separation between the equipment and receiver.
- Connect the equipment into an outlet on a circuit different from that to which the receiver is connected.
- Consult the dealer or an experienced radio/TV technician for help.

FCC WARNING

Changes or modifications not expressly approved by the party responsible for compliance could void the user's authority to operate the equipment. Proper connectors must be used for connection to host computer and/or peripherals in order to meet FCC emission limits.

Caution Exposure to radio frequency radiation (below is for portable device)

To comply with FCC RF exposure compliance requirements, this device must not be co-located or operating in conjunction with any other antenna or transmitter.

Declaration of Conformity

Model Number: YA-P10
Trade Name: CASIO
Responsible party: Casio America, Inc.
Address: 570 Mt. Pleasant Avenue, Dover, New Jersey 07801, USA
Telephone number: 973-361-5400



This device complies with Part 15 of the FCC Rules. Operation is subject to the following two conditions:

(1) This device may not cause harmful interference, and (2) this device must accept any interference received, including interference that may cause undesired operation.

For Users in Canada

These Class B digital apparatuses comply with Canadian ICES-003.
Cet appareil numéroté de la classes B est conforme à la norme NMB-003 du Canada.

These devices comply with RSS 210 of Industry Canada (IC).

Operation is subject to the following two conditions:

- (1) These devices may not cause interference, and
- (2) These devices must accept any interference, including interference that may cause undesired operation of this device.

L'utilisation de ce dispositif est autorisée seulement aux conditions suivantes:

- (1) il ne doit pas produire de brouillage et
- (2) l'utilisateur du dispositif doit être prêt à accepter tout brouillage radioélectrique reçu, même si ce brouillage est susceptible de compromettre le fonctionnement du dispositif.

Exposure to radio frequency radiation

The installer of this radio equipment must ensure that the antenna is located or pointed such that it does not emit RF field in excess of Health Canada limits for the general population; consult Safety Code 6, obtainable from Health Canada's website at <http://www.hc-sc.gc.ca/ewh-semt/pubs/radiation/index-eng.php>

Europe

Certify and declare under our sole responsibility that the following equipments:

Product description / Intended use	
EU/EFTA member states intended for use	EU: Austria, Belgium, Bulgaria, Cyprus, Czech Republic, Denmark, Estonia, Finland, France, Germany, Greece, Hungary, Ireland, Italy, Latvia, Lithuania, Luxembourg, Malta, The Netherlands, Poland, Portugal, Romania, Slovakia, Slovenia, Spain, Sweden, United Kingdom EFTA: Switzerland, Iceland, Liechtenstein, Norway
Member states with restrictive use	France, Belgium
Manufacturer	CASIO COMPUTER CO., LTD.
Brand	CASIO
Type	YA-P10

DECLARATION OF CONFORMITY

We, the under signed, CASIO Europe GmbH, hereby declare that the following equipments:

Product: Wireless Pen Mouse
Model: YA-P10
Brand: CASIO

are in conformity with all the provisions of the following EC directive with meeting the related test standards:

Council Directive: 1999/5/EC (R&TTE Directive):

Standards for all models:

EN 60950-1: 2006+A11:2009
EN 62311: 2008
EN 301 489-1 v1.8.1 (2008-04)
EN 301 489-3 v1.4.1 (2002-08)
EN 300 440-1 v1.6.1 (2010-08)
EN 300 440-2 v1.4.1 (2010-08)

Hereunder, that this declaration is based on the above standards have been complied fully, constructing into a Technical File.

Products are for distribution within all member states of the EU.

France limited to 2446.5-2483.5 MHz Indoor use.

Belgium limited to 2400-2483.5 MHz Indoor, 2460-2483.5 MHz Outdoor use.



The information described above dates from June 2011 and may be subjected to future changes.

B

EEE Yönetmeliğine Uygundur



**Batterij niet weggoaien,
maar inlevern als KCA**



Manufacturer:

CASIO COMPUTER CO.,LTD.

6-2, Hon-machi 1-chome, Shibuya-ku, Tokyo 151-8543, Japan

Responsible within the European Union:

CASIO EUROPE GmbH

Casio-Platz 1, 22848 Norderstedt, Germany

이 기기는 가정용(B 급) 전자파적합기기로서 주로
가정에서 사용하는 것을 목적으로 하며,
모든지역에서 사용할 수 있습니다.

CASIO®

カシオ計算機株式会社

〒151-8543 東京都渋谷区本町1-6-2
CASIO COMPUTER CO.,LTD.
6-2, Hon-machi 1-chome
Shibuya-ku, Tokyo 151-8543, Japan

P9K39-4800-00

Printed in China
Imprimé en Chine
MA1105-B