

ES

# CTK-481 CTK-491

USER'S GUIDE  
GUÍA DEL USUARIO



# CASIO®

CTK481/491-ES-1

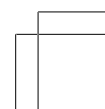
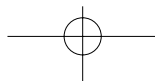
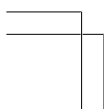

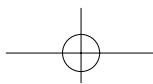

**GUIDELINES LAID DOWN BY FCC RULES FOR USE OF THE UNIT IN THE U.S.A. (not applicable to other areas).**

### NOTICE

This equipment has been tested and found to comply with the limits for a Class B digital device, pursuant to Part 15 of the FCC Rules. These limits are designed to provide reasonable protection against harmful interference in a residential installation. This equipment generates, uses and can radiate radio frequency energy and, if not installed and used in accordance with the instructions, may cause harmful interference to radio communications. However, there is no guarantee that interference will not occur in a particular installation. If this equipment does cause harmful interference to radio or television reception, which can be determined by turning the equipment off and on, the user is encouraged to try to correct the interference by one or more of the following measures:

- Reorient or relocate the receiving antenna.
- Increase the separation between the equipment and receiver.
- Connect the equipment into an outlet on a circuit different from that to which the receiver is connected.
- Consult the dealer or an experienced radio/TV technician for help.

### FCC WARNING

Changes or modifications not expressly approved by the party responsible for compliance could void the user's authority to operate the equipment.

### **Important!**

Please note the following important information before using this product.

- Before using the optional AD-5 Adaptor to power the unit, be sure to check the AC Adaptor for any damage first. Carefully check the power cord for breakage, cuts, exposed wire and other serious damage. Never let children use an AC adaptor that is seriously damaged.
- Never attempt to recharge batteries.
- Do not use rechargeable batteries.
- Never mix old batteries with new ones.
- Use recommended batteries or equivalent types.
- Always make sure that positive (+) and negative (-) poles are facing correctly as indicated near the battery compartment.
- Replace batteries as soon as possible after any sign they are getting weak.
- Do not short-circuit the battery terminals.
- The product is not intended for children under 3 years.
- Use only CASIO AD-5 adaptor.
- The AC adaptor is not a toy.
- Be sure to disconnect the AC adaptor before cleaning the product.



CASIO ELECTRONICS CO., LTD.  
Unit 6, 1000  
North Circular Road  
London NW2 7JD, U.K.

This mark is valid in the EU countries only.  
Please keep all information for future reference.

625A-E-002A

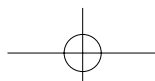

# Safety Precautions

Congratulations on your selection of the CASIO electronic musical instrument.

- Before using the instrument, be sure to carefully read through the instructions contained in this manual.
- Please keep all information for future reference.

## Symbols

Various symbols are used in this user's guide and on the product itself to ensure that the product is used safely and correctly, and to prevent injury to the user and other persons as well as damage to property. Those symbols along with their meanings are shown below.

### DANGER

This symbol indicates information that, if ignored or applied incorrectly, creates the danger of death or serious personal injury.

### WARNING

This indication stipulates matters that have the risk of causing death or serious injury if the product is operated incorrectly while ignoring this indication.

### CAUTION

This indication stipulates matters that have the risk of causing injury as well as matters for which there is the likelihood of occurrence of physical damage only if the product is operated incorrectly while ignoring this indication.

## Symbol Examples



This triangle symbol ( $\triangle$ ) means that the user should be careful. (The example at left indicates electrical shock caution.)



This circle with a line through it ( $\odot$ ) means that the indicated action must not be performed. Indications within or nearby this symbol are specifically prohibited. (The example at left indicates that disassembly is prohibited.)



The black dot ( $\bullet$ ) means that the indicated action must be performed. Indications within this symbol are actions that are specifically instructed to be performed. (The example at left indicates that the power plug must be unplugged from the electrical socket.)

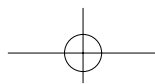

## **⚠ DANGER**

### **Alkaline Batteries**

Perform the following steps immediately if fluid leaking from alkaline batteries ever gets into your eyes.



1. Do not rub your eyes! Rinse them with water.
2. Contact your physician immediately.

Leaving alkaline battery fluid in your eyes can lead to loss of sight.

## **⚠ WARNING**

### **Smoke, Strange Odor, Overheating**

Continued use of the product while it is emitting smoke, a strange odor, or heat creates the risk of fire and electric shock. Take the following steps immediately.

1. Turn off power.
2. If you are using the AC adaptor for power, unplug it from the wall outlet.
3. Contact your original retailer or an authorized CASIO Service Provider.

### **AC Adaptor**

Misuse of the AC adaptor creates the risk of fire and electric shock. Always make sure you observe the following precautions.

- Be sure to use only the AC adaptor that is specified for this product.
- Use only a power source whose voltage is within the rating marked on the AC adaptor.
- Do not overload electrical outlets and extension cords.



### **AC Adaptor**

Misuse of the AC adaptor's electric cord can damage or break it, creating the risk of fire and electric shock. Always make sure you observe the following precautions.

- Never place heavy objects on the cord or subject it to heat.
- Never try to modify the cord or subject it to excessive bending.
- Never twist or stretch the cord.
- Should the electric cord or plug become damaged, contact your original retailer or authorized CASIO Service Provider.



### **AC Adaptor**

Never touch the AC adaptor while your hands are wet.

Doing so creates the risk of electric shock.



### **Batteries**

Misuse of batteries can cause them to leak, resulting in damage to nearby objects, or to explode, creating the risk of fire and personal injury. Always make sure you observe the following precautions.

- Never try to take batteries apart or allow them to become shorted.
- Never expose batteries to heat or dispose of them by incineration.
- Never mix old batteries with new ones.
- Never mix batteries of different types.
- Do not charge the batteries.
- Make sure the positive (+) and negative (-) ends of the batteries are facing correctly.



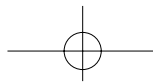

**Do not incinerate the product.**

Never throw the product into fire. Doing so can cause it to explode, creating the risk of fire and personal injury.



**Water and Foreign Matter**

Water, other liquids, and foreign matter (such as pieces of metal) getting into the product create the risk of fire and electric shock. Take the following steps immediately.



1. Turn off power.
2. If you are using the AC adaptor for power, unplug it from the wall outlet.
3. Contact your original retailer or an authorized CASIO Service Provider.

**Disassembly and Modification**

Never try to take this product apart or modify it in any way. Doing so creates the risk of electric shock, burn injury, or other personal injury. Leave all internal inspection, adjustment, and maintenance up to your original retailer or authorized CASIO Service Provider.



**Dropping and Impact**

Continued use of this product after it has been damaged by dropping or subjecting it to strong impact creates the risk of fire and electric shock. Take the following steps immediately.

1. Turn off power.
2. If you are using the AC adaptor for power, unplug it from the wall outlet.
3. Contact your original retailer or an authorized CASIO Service Provider.



**Plastic Bags**

Never place the plastic bag the product comes in over your head or in your mouth. Doing so creates the risk of suffocation.



Particular care concerning this precaution is required where small children are present.

**Keep off of the product and stand.\***

Climbing onto the product or stand can cause it to tip over or become damaged. Particular care concerning this precaution is required where small children are present.



**Location**

Avoid locating the product on an unstable stand, on an uneven surface, or any other unstable location. An unstable location can cause the product to fall over, creating the risk of personal injury.



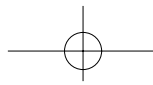

## CAUTION

### AC Adaptor

Misuse of the AC adaptor creates the risk of fire and electric shock. Always make sure you observe the following precautions.

- Do not locate the electric cord near a stove or other sources of heat.
- Never pull on the cord when unplugging from the electrical outlet. Always grasp the AC adaptor when unplugging.



### AC Adaptor

Misuse of the AC adaptor creates the risk of fire and electric shock. Always make sure you observe the following precautions.

- Insert the AC adaptor into the wall outlet as far as it will go.
- Unplug the AC adaptor from the wall outlet during lightning storms or before leaving on a trip or other long-term absence.
- At least once a year, unplug the AC adaptor from the wall outlet and wipe away any dust that is built up in the area around the prongs of the plug.



### Relocating the Product

Before relocating the product, always unplug the AC adaptor from the wall outlet and disconnect all other cables and connecting cords. Leaving cords connected creates the risk of damage to the cords, fire, and electric shock.



### Cleaning

Before cleaning the product, always unplug the AC adaptor from the wall outlet first. Leaving the AC adaptor plugged in creates the risk of damage to the AC adaptor, fire, and electric shock.



### Batteries

Misuse of batteries can cause them to leak resulting in damage to nearby objects, or to explode, creating the risk of fire and personal injury. Always make sure you observe the following precautions.

- Use only batteries that are specified for use with this product.
- Remove batteries from the product if you do not plan to use it for a long time.



### Connectors

Connect only the specified devices and equipment to the product's connectors. Connection of a non-specified device or equipment creates the risk of fire and electric shock.



### Location

Avoid the following locations for this product. Such locations create the risk of fire and electric shock.

- Areas subject to high humidity or large amounts of dust.
- In food preparation areas or other areas subject to oil smoke.
- Near air conditioning equipment, on a heated carpet, in areas exposed to direct sunlight, inside of a vehicle parked in the sun, or any other area that subjects the product to high temperatures.



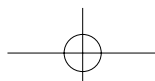

### Display Screen

- Never push on the display screen's LCD panel or subject it to strong impact. Doing so can cause the LCD panel's glass to crack, creating the risk of personal injury.
- Should the LCD panel ever crack or break, never touch the liquid inside of the panel. LCD panel liquid can cause skin irritation.
- Should LCD panel liquid ever get inside your mouth, immediately wash out your mouth with water and contact your physician.
- Should LCD panel liquid ever get into your eyes or onto your skin, rinse with clear water for at least 15 minutes, and then contact a physician.



### Sound Volume

Do not listen to music at very loud volumes for long periods. Particular care concerning this precaution is required when using headphones. High volume settings can damage your hearing.



### Heavy Objects

Never place heavy object on top of the product. Doing so can make the product top heavy, causing the product to tip over or the object to fall from it, creating the risk of personal injury.



### Correct Stand\* Assembly

An incorrectly assembled stand can tip over, causing the product to fall and creating the risk of personal injury. Make sure you assemble the stand correctly, following the assembly instructions that come with it. Make sure you mount the product on the stand correctly.



\* Stand is available as an option.

### IMPORTANT!

When using batteries, be sure to replace them or shift to one of the alternate power sources whenever you notice any of the following symptoms.

- Dim power indicator
- Instrument does not turn on
- Display that is flickering, dim, or difficult to read
- Abnormally low speaker/headphone volume
- Distortion of sound output
- Occasional interruption of sound when playing at high volume
- Sudden power failure when playing at high volume
- Flickering or dimming of the display when playing at high volume
- Continued sound output even after you release a key
- A tone that is totally different from the one that is selected
- Abnormal rhythm pattern and Song Bank play
- Loss of power, sound distortion, or low volume when playing from a connected computer or MIDI device

<CTK-491 only>

- Distortion of microphone input
- Dim power supply indicator when a microphone is used
- Sudden power failure when using the microphone



## ***Introduction***

Congratulations upon your selection of this CASIO musical instrument. This keyboard provides you with the following features and functions.

### **□ 100 tones**

- Choose from among orchestral sounds, synthesized sounds, and more.

### **□ 100 rhythms**

- 100 versatile rhythms help to add plenty of life to all your keyboard performances.

### **□ Auto Accompaniment**

- Simply play a chord and the corresponding rhythm, bass and chord parts play automatically.

### **□ 100-tune Song Bank**

- A wide selection of favorites including “ODE TO JOY” and “JINGLE BELLS” is yours for your listening enjoyment or play along fun. A simple operation cuts out the melody part or accompaniment part of the tune, allowing you to play along on the keyboard.



### **□ Musical Information System**

- A big LCD screen graphically shows you fingerings, keyboard keys to be pressed, and notes, making keyboard play more informative and enjoyable than ever before.

### **□ MIDI compatibility**

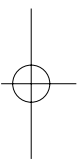
- Connecting to another MIDI device lets you sound notes on both this keyboard and the connected device by playing on this keyboard. You can even playback commercially available pre-recorded MIDI data.
- 



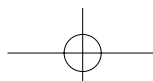

# Contents

<b>Safety Precautions .....</b>	<b>E-1</b>	Synchro Starting Accompaniment with Rhythm Play .....	E-21
<b>Introduction .....</b>	<b>E-6</b>	Adjusting the Accompaniment Volume ....	E-21
<b>Contents .....</b>	<b>E-7</b>	<b>Using the Song Bank .....</b>	<b>E-22</b>
<b>General Guide .....</b>	<b>E-8</b>	Playing Back a Song Bank Tune .....	E-22
Rear Panel .....	E-9	Song Bank Mode Display .....	E-23
Using the Display .....	E-10	Adjusting the Tempo of a Song Bank Tune ...	E-23
<b>Song Bank</b>		Changing the Tone of a Song Bank Tune's Melody .....	E-24
<b>Quick Reference .....</b>	<b>E-11</b>	Playing Along with a Song Bank Tune .....	E-24
Playing Back a Song Bank Tune .....	E-11	Applause Sound .....	E-25
<b>Power Supply .....</b>	<b>E-13</b>	Playing Back All Song Bank Tunes in Succession .....	E-25
Using batteries .....	E-13	<b>Using the Chord Book .....</b>	<b>E-26</b>
Using the AC Adaptor .....	E-14	Looking Up a Chord .....	E-27
Auto Power Off .....	E-14	Using the Chord Book .....	E-27
Settings .....	E-14	<b>Keyboard Settings .....</b>	<b>E-29</b>
<b>Connections .....</b>	<b>E-15</b>	Transposing the Keyboard .....	E-29
Phones/Output Terminal .....	E-15	Tuning the Keyboard .....	E-30
Sustain jack Terminal .....	E-15	<b>MIDI .....</b>	<b>E-31</b>
Accessories and Options .....	E-15	What is MIDI? .....	E-31
<b>Basic Operations .....</b>	<b>E-16</b>	General MIDI .....	E-31
Playing the Keyboard .....	E-16	Changing MIDI Settings .....	E-32
Selecting a Tone .....	E-16	<b>Troubleshooting .....</b>	<b>E-34</b>
Using the Microphone Jack (CTK-491 only) .....	E-17	<b>Specifications .....</b>	<b>E-36</b>
<b>Auto Accompaniment .....</b>	<b>E-18</b>	<b>Care of your keyboard .....</b>	<b>E-37</b>
Selecting a Rhythm .....	E-18	<b>Appendix .....</b>	<b>A-1</b>
Playing a Rhythm .....	E-18	Tone List .....	A-1
Adjusting the Tempo .....	E-19	Note Table .....	A-2
Using Auto Accompaniment .....	E-19	Fingered Chord Chart .....	A-4
Using a Fill-in Pattern .....	E-21	Percussion Instrument List .....	A-5
		<b>MIDI Implementation Chart</b>	<b>E-7</b>

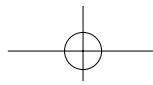

# General Guide

• Key, button, and other names are indicated in the text of this manual using bold type.

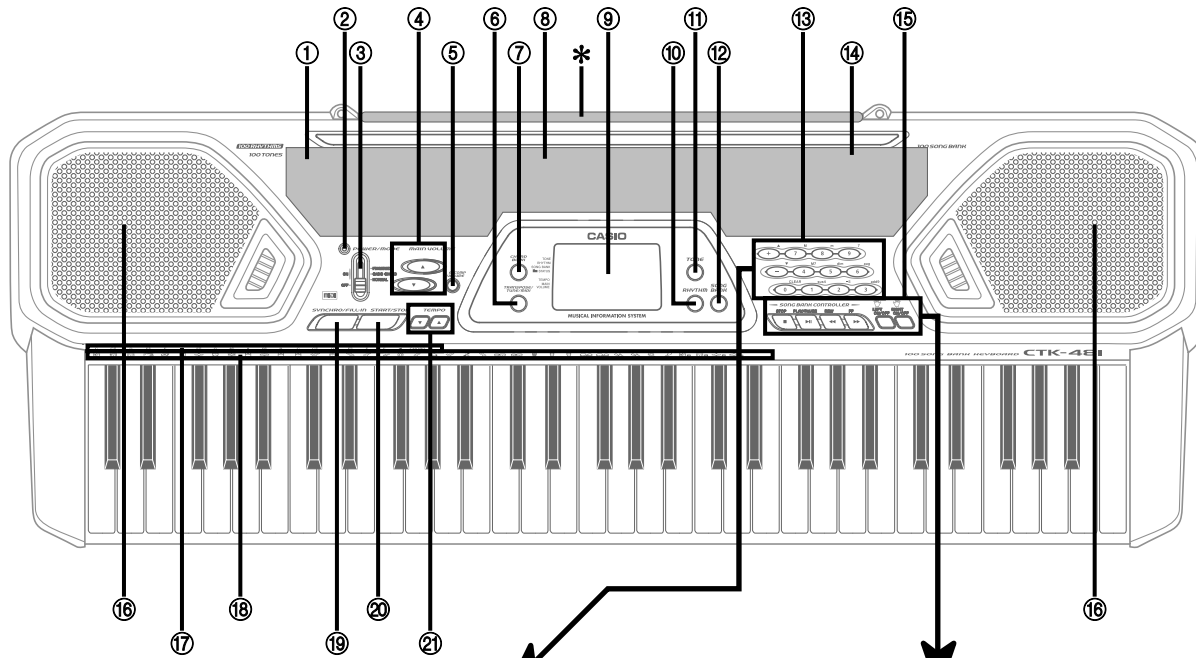

**13**

**[+]/[-] buttons**

- Negative values can be changed only by using [+] and [-] to increase and decrease the displayed value.

**Number buttons/  
Chord specification buttons**

- For input of numbers to change displayed settings.
- For input of chord specification data when using the Chord Book.

**15 SONG BANK CONTROLLER**

**RIGHT ON/OFF button (MELODY)**

**LEFT ON/OFF button (ACCOMP)**

**FF button**

**REW button**

**PLAY/PAUSE button**

**STOP button**

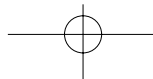

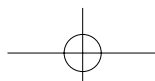

**NOTE**

- Illustrations in this User's Guide shows the CTK-481.

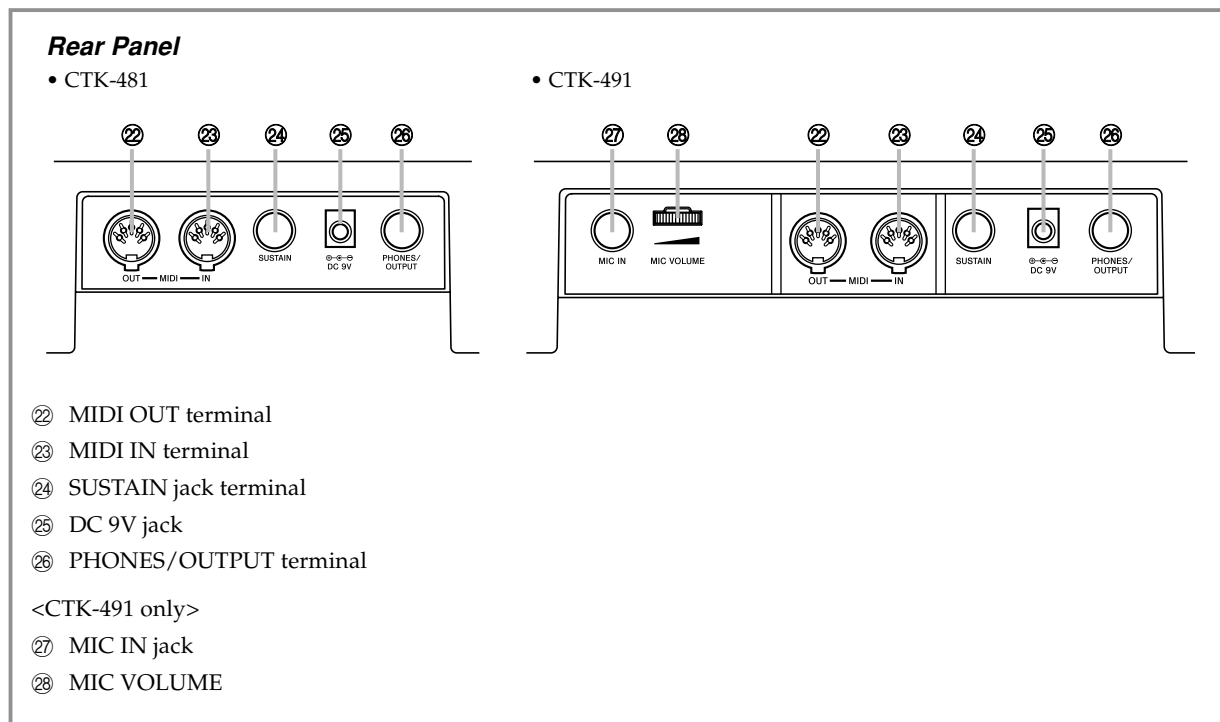

- ① Rhythm list
- ② Power indicator
- ③ POWER/MODE switch
- ④ MAIN VOLUME buttons
- ⑤ ACCOMP VOLUME button
- ⑥ TRANSPOSE/TUNE/MIDI button
- ⑦ CHORD BOOK button
- ⑧ Tone list
- ⑨ Display
- ⑩ RHYTHM button
- ⑪ TONE button
- ⑫ SONG BANK button
- ⑬ Number buttons (Chord specification buttons)
- ⑭ Song bank list
- ⑮ SONG BANK CONTROLLER  
(PLAY/PAUSE, STOP, REW, FF, LEFT ON/OFF, RIGHT ON/OFF)
- ⑯ Speaker
- ⑰ Chord name
- ⑱ Percussion instrument list
- ⑲ SYNCHRO/FILL-IN button
- ⑳ START/STOP button
- ㉑ TEMPO buttons

**\*Attachment of the Score Stand**

Insert both ends of the music stand provided with the keyboard into the two holes on the top surface.

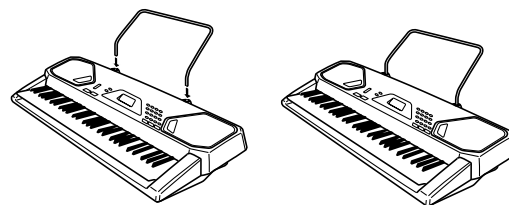

## Using the Display

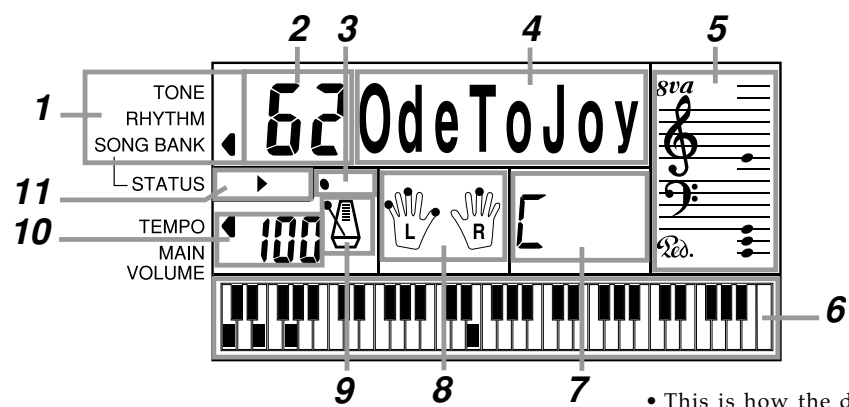

• This is how the display appears while the Song Bank is in use.

- 1 An indicator appears next to the type of setting you are currently performing (TONE, RHYTHM, SONG BANK).
- 2 Tone number, rhythm number, song number, keyboard settings value
- 3 Rhythm, auto-accompaniment, Song Bank tune beats
- 4 Tone name, rhythm name, song name, mode name, keyboard settings name
- 5 Musical staff representation of notes and chords you play on the keyboard. A pedal indicator ( $\text{ped.}$ ) appears when the keyboard's pedal is depressed. An octave indicator (*sva*) appears when you play notes in the range from C<sup>#</sup>6 to C7 to indicate that their actual notation is one octave higher than that shown on display.
- 6 Uses a graphic keyboard to show notes and chords played on the keyboard or played during Song Bank tune playback
- 7 Auto-accompaniment, Song Bank, chord book chord names
- 8 Dots indicate fingerings during Song Bank playback. "L" and "R" indicate left-hand and right-hand parts.
- 9 Rhythm, auto-accompaniment, Song Bank tune tempo
- 10 Rhythm, auto-accompaniment, Song Bank tune tempo; volume setting
- 11 Song Bank controller indicators

### NOTE

- Display examples shown in this User's Guide are intended for illustrative purposes only. The actual text and values that appear on the display may differ from the examples shown in this User's Guide.

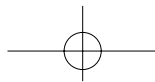

# Song Bank Quick Reference

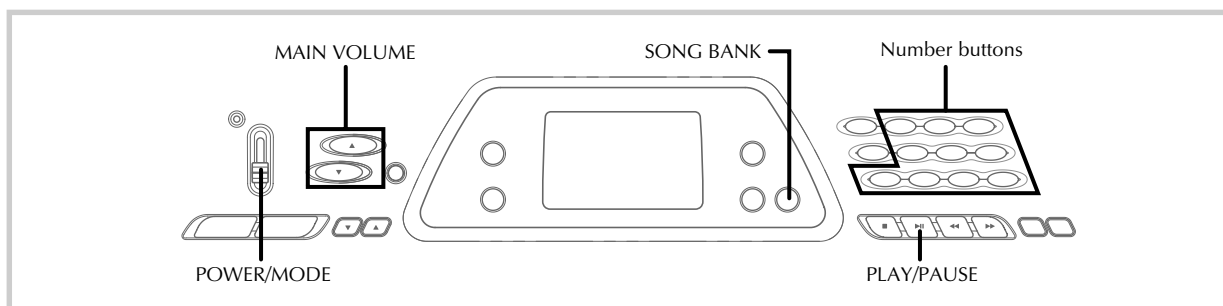

A selection of 100 Song Bank tunes comes built-in for your listening pleasure or play along fun. A simple operation cuts out the melody part or accompaniment part of the tune, allowing you to play along on the keyboard. See "Using the Song Bank" on page E-22 for details on playing along with Song Bank tunes.

## Playing Back a Song Bank Tune

### To play back a Song Bank tune

1. Set the **POWER/MODE** switch to NORMAL.
2. Use the **MAIN VOLUME** buttons to lower the keyboard volume to a relatively low level.

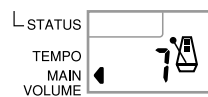

3. Press the **SONG BANK** button to enter the Song Bank Mode.

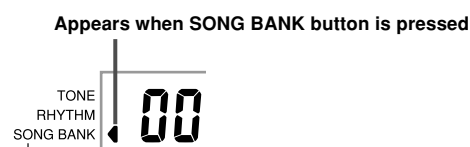

4. Use the Song Bank list to find the tune you want to play back, and then use the **number buttons** to input the tune's two-digit number.

*Example:* To select "62 ODE TO JOY", input 6 and then 2.

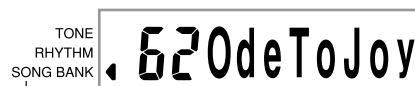

5. Press the **PLAY/PAUSE** button to start play of the tune.
  - The tune plays in an endless loop, re-starting after it reaches the end.
  - The display shows the keyboard keys (on the graphic keyboard), fingerings (with the fingering indicators), musical notes (on the staff), and chord names.

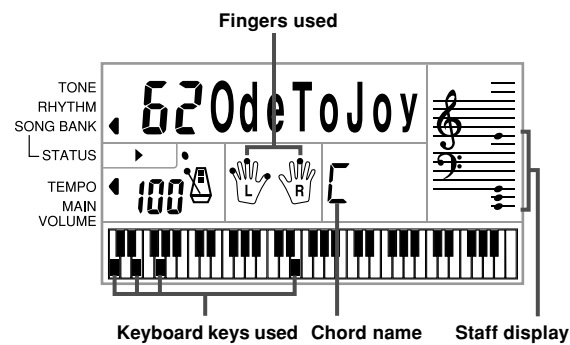

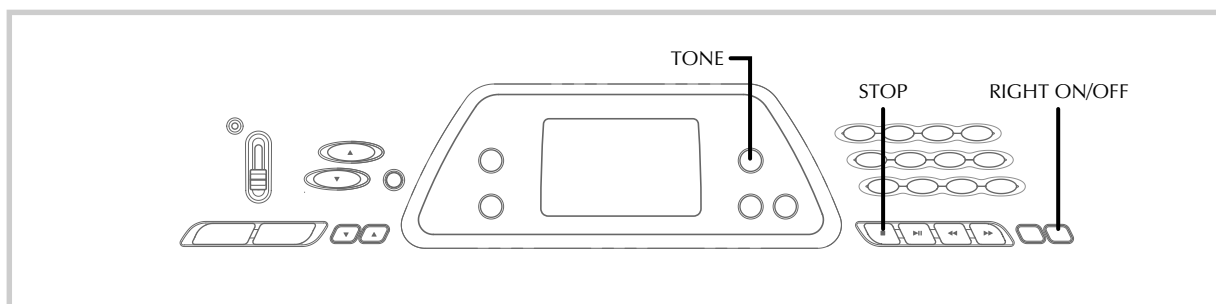
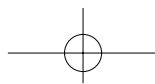

6. Press the **RIGHT ON/OFF button** to turn off the right-hand melody part and try playing along on the keyboard.

- The display's graphic keyboard and fingering indicators show you the melody notes to play.

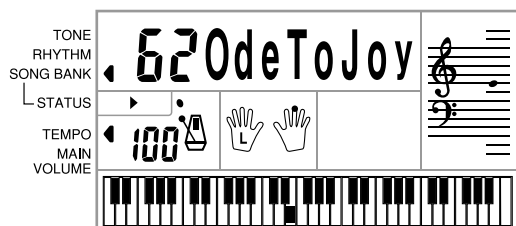

7. Press the **RIGHT ON/OFF button** again to turn the melody part back on.

- You can also turn the accompaniment part on and off by pressing the **LEFT ON/OFF button**.

8. Press the **STOP button** to stop playback of the Song Bank tune.

9. Press the **TONE button** to exit the Song Bank Mode and return to the tone and rhythm selection screen.



**NOTE**

- You can also perform the following operations during play of a Song Bank tune.
  - Pause: Press the **PLAY/PAUSE button**.
  - Fast Forward: Press the **FF (fast forward) button**.
  - Rewind: Press the **REW (rewind) button**.

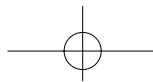

# Power Supply

This keyboard can be powered by current from a standard household wall outlet (using the specified AC adaptor) or by batteries. Always make sure you turn the keyboard off whenever you are not using it.

## Using batteries

Always make sure you turn off the keyboard before loading or replacing batteries.

### To load batteries

1. Remove the battery compartment cover.

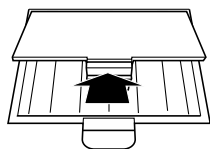

2. Load 6 AA-size batteries into the battery compartment.

- Make sure that the positive (+) and negative (-) ends are facing correctly.

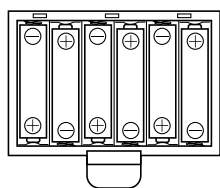

3. Insert the tabs on the battery compartment cover into the holes provided and close the cover.

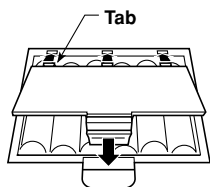

The keyboard may not function correctly if you load or replace batteries with power turned on. If this happens, turning the keyboard off and then back on again should return functions back to normal.

## Important Battery Information

- The following shows the approximate battery life.
    - Alkaline batteries ..... 4 hours\***
    - Manganese batteries ..... 2 hours\***
  - \* The above value is standard battery life at normal temperature, with the keyboard volume at medium setting. Temperature extremes or playing at very loud volume settings can shorten battery life.
  - Any of the following symptoms indicate low battery power. Replace batteries as soon as possible whenever any of the following occurs.
    - Dim power indicator
    - Instrument does not turn on
    - Display that is flickering, dim, or difficult to read
    - Abnormally low speaker/headphone volume
    - Distortion of sound output
    - Occasional interruption of sound when playing at high volume
    - Sudden power failure when playing at high volume
    - Flickering or dimming of the display when playing at high volume
    - Continued sound output even after you release a key
    - A tone that is totally different from the one that is selected
    - Abnormal rhythm pattern and Song Bank play
    - Loss of power, sound distortion, or low volume when playing from a connected computer or MIDI device
- <CTK-491 only>
- Distortion of microphone input
  - Dim power supply indicator when a microphone is used
  - Sudden power failure when using the microphone

### ⚠ WARNING

Misuse of batteries can cause them to leak, resulting in damage to nearby objects, or to explode, creating the risk of fire and personal injury. Always make sure you observe the following precautions.

- Never try to take batteries apart or allow them to become shorted.
- Never expose batteries to heat or dispose of them by incineration.
- Never mix old batteries with new ones.
- Never mix batteries of different types.
- Do not charge the batteries.
- Make sure the positive (+) and negative (-) ends of the batteries are facing correctly.

### ⚠ CAUTION

Misuse of batteries can cause them to leak resulting in damage to nearby objects, or to explode, creating the risk of fire and personal injury. Always make sure you observe the following precautions.

- Use only batteries that are specified for use with this product.
- Remove batteries from the product if you do not plan to use it for a long time.

## Using the AC Adaptor

Make sure that you use only the AC adaptor specified for this keyboard.

**Specified AC Adaptor: AD-5**

[Rear Panel]

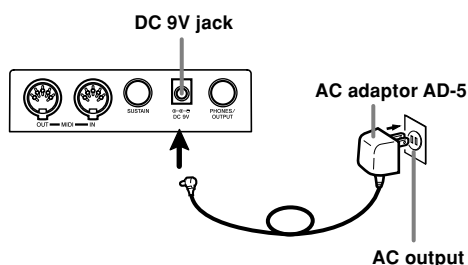

Also note the following important warnings and precautions when using the AC adaptor.

### **⚠ WARNING**

Misuse of the AC adaptor creates the risk of fire and electric shock. Always make sure you observe the following precautions.

- Be sure to use only the AC adaptor that is specified for this product.
- Use only a power source whose voltage is within the rating marked on the AC adaptor. **!**
- Do not overload electrical outlets and extension cords. **⊘**
- Never place heavy objects on the cord or subject it to heat. **⊘**
- Never try to modify the cord or subject it to excessive bending.
- Never twist or stretch the cord.
- Should the electric cord or plug become damaged, contact your original retailer or authorized CASIO Service Provider. **!**
- Never touch the AC adaptor while your hands are wet. Doing so creates the risk of electric shock. **⊘**

### **⚠ CAUTION**

Misuse of the AC adaptor creates the risk of fire and electric shock. Always make sure you observe the following precautions.

- Do not locate the electric cord near a stove or other sources of heat. **⊘**
- Never pull on the cord when unplugging from the electrical outlet. Always grasp the AC adaptor when unplugging.
- Insert the AC adaptor into the wall outlet as far as it will go. **!**
- Unplug the AC adaptor from the wall outlet during lightning storms or before leaving on a trip or other long-term absence.
- At least once a year, unplug the AC adaptor from the wall outlet and wipe away any dust that is built up in the area around the prongs of the plug.

## IMPORTANT!

- Make sure that the keyboard is turned off before connecting or disconnecting the AC adaptor.
- Using the AC adaptor for a long time can cause it to become warm to touch. This is normal and does not indicate malfunction.

## Auto Power Off

When you are using battery power, keyboard power turns off automatically whenever you leave it on without performing any operation for about 6 minutes. When this happens, use the POWER/MODE switch to turn power back on.

### **NOTE**

- Auto Power Off is disabled (it does not function) when you are using the AC adaptor to power the keyboard.

## To disable Auto Power Off

Hold down the TONE button while turning on the keyboard to disable Auto Power Off.

### **NOTE**

- When Auto Power Off is disabled, the keyboard does not turn off automatically no matter how long it is left with no operation being performed.
- Auto Power Off is automatically enabled whenever you turn on keyboard power.

## Settings

All keyboard settings are returned to their initial defaults whenever keyboard power is turned back on after being turned off by operation of the POWER/MODE switch or Auto Power Off.



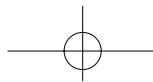

# Connections

## Phones/Output Terminal

Before connecting phones or other external equipment, be sure to first turn down the volume settings of the keyboard and the connected equipment. You can then adjust volume to the desired level after connections are complete.

[Rear Panel]

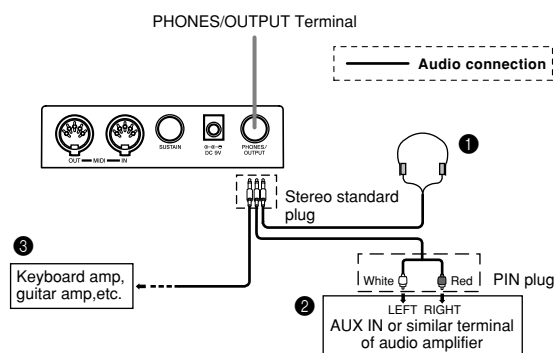

### Connecting Phones (Figure 1)

Connecting phones cuts off output from the keyboard's built-in speakers, so you can play even late at night without disturbing anyone.

### Audio Equipment (Figure 2)

Connect the keyboard to a audio equipment using a commercially available connecting cord with a standard plug on one end and two PIN plugs on the other end. Note that the standard plug you connect to the keyboard must be a stereo plug, otherwise you will be able to output only one of stereo channels. In this configuration, you normally set the input selector of the audio equipment to the terminal (usually marked AUX IN or something similar) where the cord from the keyboard is connected. See the user documentation that comes with your audio equipment for full details.

### Musical Instrument Amplifier (Figure 3)

Use a commercially available connecting cord\* to connect the keyboard to a musical instrument amplifier.

\* Be sure to use a connecting cord that has a stereo standard plug on the end you connect to the keyboard, and a connector that provides dual channel (left and right) input to the amplifier to which you are connecting. The wrong type of connector at either end can cause one of the stereo channels to be lost.

When connected to a musical instrument amplifier, set the volume of the keyboard to a relatively low level and make output volume adjustments using the amplifier's controls.

### [Connection Example]

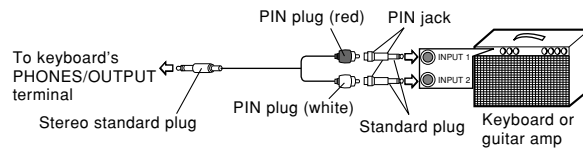

### NOTE

- You can also connect the keyboard's MIDI terminal to a computer or sequencer. See "MIDI" on page E-31 for details.

## Sustain jack Terminal

You can connect an optional sustain pedal (SP-2, SP-10, or SP-20) to the SUSTAIN jack terminal to enable the capabilities described below.

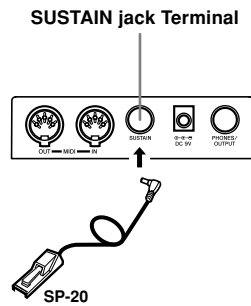

### Sustain Pedal

- With piano tones, depressing the pedal causes notes to linger, much like a piano's damper pedal.
- With organ tones, depressing the pedal causes notes to continue to sound until the pedal is released.

## Accessories and Options

Use only the accessories and options specified for this keyboard. Use of non-authorized items creates the danger of fire, electrical shock, and personal injury.

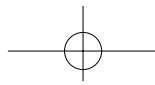

# Basic Operations

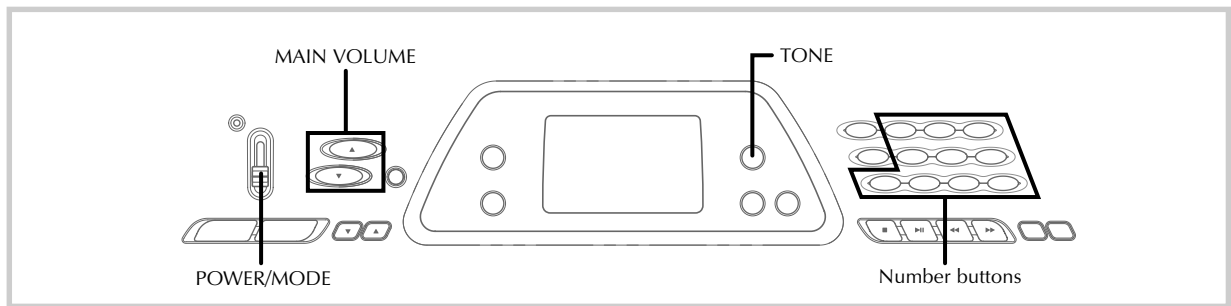

This section provides information on performing basic keyboard operations.

## Playing the Keyboard

### To play the keyboard

1. Set the **POWER/MODE** switch to NORMAL.
2. Use the **MAIN VOLUME** buttons to lower the keyboard volume.
  - It's always a good idea to set the keyboard volume at a relatively low level before playing.
  - Pressing [▲] or [▼] causes the current volume setting to appear on the display. Press [▲] or [▼] again to change the setting.
3. Play something on the keyboard.

## Selecting a Tone

This keyboard comes with 100 built-in tones. Use the following procedure to select the tone you want to use.

### To select a tone

1. Find the tone you want to use in the keyboard's tone list and note its tone number.
2. Press the **TONE** button.



3. Use the **number buttons** to input the two digit tone number for the tone you want to select.

*Example:* To select "26 WOOD BASS", input 2 and then 6.



- Now notes played on the keyboard will be played using an acoustical wood bass sound.

### NOTE

- Always input both digits for the tone number, including a leading zero (if any). If you input one digit and stop, the display will automatically clear your input after a few seconds.
- You can also increment the displayed tone number by pressing [+] and decrement it by pressing [-].
- The names of tone numbers 60 through 89 are not marked on the keyboard console. See the "Tone List" (page A-1) for details.
- Sound effect tones such as 77 VEHICLE sound best when you keep a keyboard key depressed.

## Combination tones

The following describes the two types of combination tones that are available.

### Layered Tones (Tone Numbers: 80 through 89)

*Example:* 80 STR PIANO

This tone layers a strings tone with a piano tone so they both sound when a keyboard key is pressed.

### Split Tones (Tone Numbers: 90 through 96)

*Example:* 90 BASS/PIANO

This tone splits the keyboard so one range is assigned a bass tone and another range is assigned a piano tone.

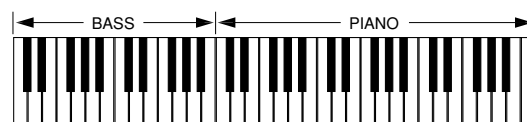

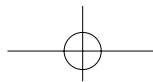

### Percussion sounds

Example: 99 PERCUSSION

This tone assigns various percussion sounds to the keyboard. See the "Percussion Instrument List" on page A-5 for full details.

### Sound Effect Tones

With sound effect tones 77 through 79, the type of sound produced depends on the octave where the key you press is located. When 78 PHONE is selected available sound types are PUSH TONE 1, PUSH TONE 2, RING 1, RING 2, and BUSY SIGNAL.

### Polyphony

The term polyphony refers to the maximum number of notes you can play at the same time. The keyboard has 12-note polyphony, which includes the notes you play as well as the rhythms and auto-accompaniment patterns that are played by the keyboard. This means that when a rhythm or auto-accompaniment pattern is being played by the keyboard, the number of notes (polyphony) available for keyboard play is reduced. Also note that some of the tones offer only 6-note polyphony.

#### NOTE

- When rhythm or auto accompaniment is playing, the number of sounds simultaneously played is reduced.

### Digital Sampling

A number of the tones that are available with this keyboard have been recorded and processed using a technique called digital sampling. To ensure a high level of tonal quality, samples are taken in the low, mid, and high ranges and then combined to provide you with sounds that are amazingly close to the originals. You may notice very slight differences in volume or sound quality for some tones when you play them at different positions on the keyboard. This is an unavoidable result of multiple sampling, and it is not a sign of malfunction.

### Using the Microphone Jack (CTK-491 only)

Connecting a commercially available microphone to the MIC IN jack makes it possible to sing along with the keyboard's built-in tunes or with output from a MIDI device. When connecting a microphone, be sure to first adjust the MIC VOLUME to a relatively low setting, and then adjust to the level you want after connecting.

1. When connecting a microphone, we recommend that you set the **MIC VOLUME** to a very low level.

2. Turn on the microphone's ON/OFF switch.
3. Use the **MIC VOLUME** to adjust microphone volume to the level you want.

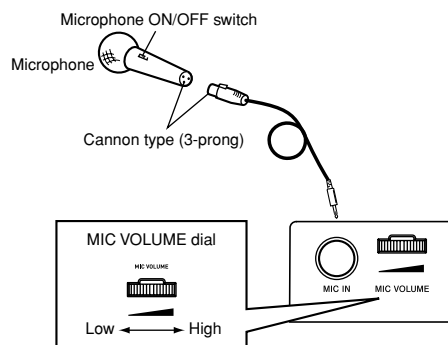

#### IMPORTANT!

- Be sure to use the microphone's ON/OFF switch to turn off the microphone and to disconnect the microphone from the keyboard whenever you are not using it.

### Required Microphone Specifications

- Microphone Type : Metal shielded (microphone body)
- Microphone and Cord Connector : Cannon type (3-prong)
- Keyboard Jack Connector : Standard plug (monaural)

#### IMPORTANT!

- Connection to the MIDI terminal of an external device can cause static in the microphone signal. Use of a Cannon type microphone with a metal-shielded body helps to prevent static.
- Be sure to disconnect the microphone from the keyboard whenever you are not using it.

### Howling (Feedback Noise)

Any of the following conditions can cause howling (feedback noise).

- Covering the head of the microphone with your hand
- Positioning the microphone too near to a speaker

Should howling occur, try grasping the microphone further away from the head, and move away from any nearby speaker.

### Static Noise

Fluorescent lighting can cause static noise in the microphone signal. When this happens, move away from the lighting you suspect may be causing the static.

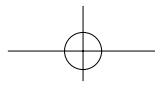

# Auto Accompaniment

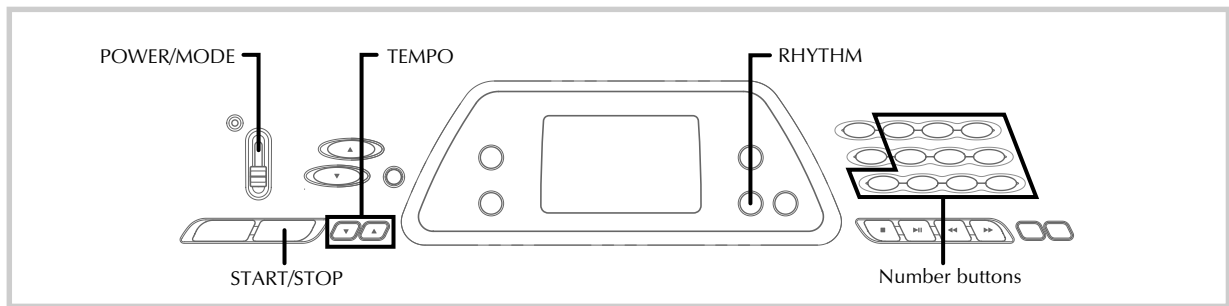

This keyboard automatically plays bass and chord parts in accordance with the chords you finger. The bass and chord parts are played using sounds and tones that are automatically selected to select the rhythm you are using. All of this means that you get full, realistic accompaniments for the melody notes you play with your right hand, creating the mood of an one-person ensemble.

## Selecting a Rhythm

This keyboard provides you with 100 exciting rhythms that you can select using the following procedure.

### To select a rhythm

1. Find the rhythm you want to use in the keyboard's rhythm list and note its rhythm number.
2. Press the **RHYTHM** button.

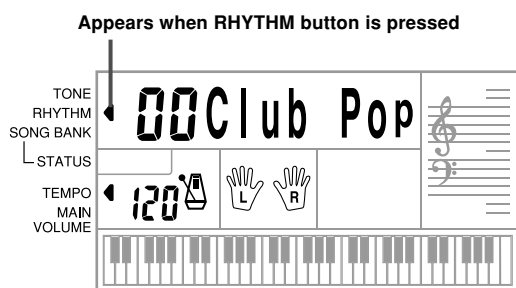

3. Use the **number buttons** to input the two digit rhythm number for the rhythm you want to select.

*Example:* To select "64 WALTZ", input 6 and then 4.

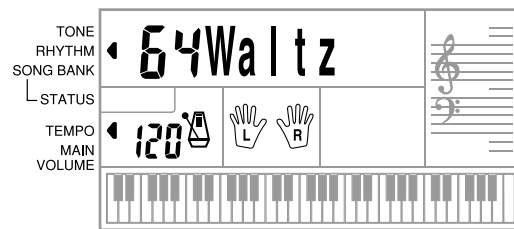

### NOTE

- "00 CLUB POP" is the initial default rhythm setting whenever you turn on keyboard power.
- You can also increment the displayed rhythm number by pressing [+] and decrement it by pressing [-].

## Playing a Rhythm

Use the following procedure to start and stop rhythm play.

### To play a rhythm

1. Set the **POWER/MODE** switch to **NORMAL**.
2. Press the **START/STOP** button to start play of the currently selected rhythm.
3. To stop rhythm play, press the **START/STOP** button again.

### NOTE

- All of the keyboard keys are melody keys while the **POWER/MODE** switch is set to **NORMAL**.

## Adjusting the Tempo

You can adjust the tempo of rhythm play within a range of 20 to 255 beats per minute. The tempo setting is applied to Auto Accompaniment chord play, and song bank operations.

### To adjust the tempo

Use the **TEMPO buttons** (▲/▼) to adjust the tempo.

▲ : Increases the tempo value.

▼ : Decreases the tempo value.

*Example:* Hold down the ▼ button until the tempo value 110 is on the display.

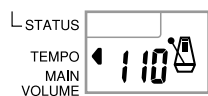

#### NOTE

- Pressing both TEMPO buttons (▲ and ▼) at the same time resets the tempo to the default value of the currently selected rhythm.

### About the Graphic Metronome

The graphic metronome appears on the display along with the tempo value and beat of a rhythm or built-in tune. The graphic metronome helps you keep in time as you play along with a rhythm or built-in tune.

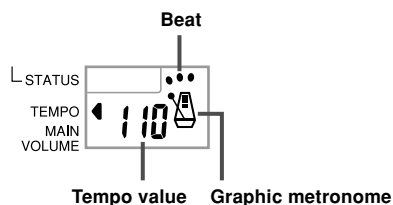

### Using Auto Accompaniment

The following procedure describes how to use the keyboard's Auto Accompaniment feature. Before starting, you should first select the rhythm you want to use and set the tempo of the rhythm to the value you want.

#### To use Auto Accompaniment

- Set the **POWER/MODE switch** to CASIO CHORD or FINGERED.

- Press the **START/STOP button** to start play of the currently selected rhythm.

- Play a chord.

- The actual procedure you should use to play a chord depends on the current POWER/MODE switch position. Refer to the following pages for details on chord play.

CASIO CHORD ..... This page

FINGERED ..... Page E-20

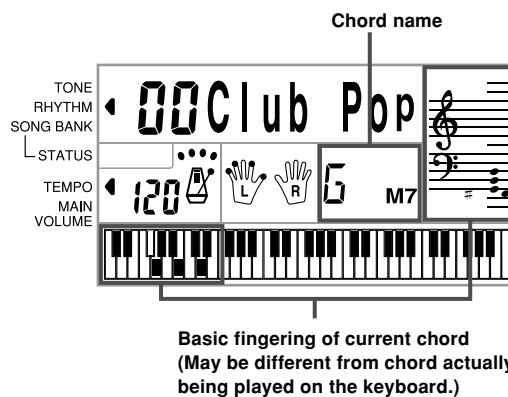

Basic fingering of current chord  
(May be different from chord actually being played on the keyboard.)

- To stop Auto Accompaniment play, press the **START/STOP button** again.

### CASIO CHORD

This method of chord play makes it possible for anyone to easily play chords, regardless of previous musical knowledge and experience. The following describes the CASIO CHORD "Accompaniment keyboard" and "Melody keyboard", and tells you how to play CASIO CHORDs.

#### CASIO CHORD Accompaniment Keyboard and Melody Keyboard

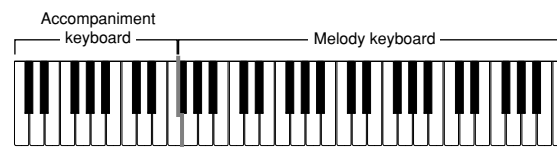

#### NOTE

- The accompaniment keyboard can be used for playing chords only. No sound will be produced if you try playing single melody notes on the accompaniment keyboard.

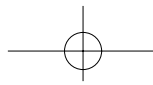

### Chord Types

CASIO CHORD accompaniment lets you play four types of chords with minimal fingering.

Chord Types	Example
<p><b>Major chords</b> Major chord names are marked above the keys of the accompaniment keyboard. Note that the chord produced when you press an accompaniment keyboard does not change octave, regardless of which key you use to play it.</p>	<p>C Major (C)</p>
<p><b>Minor chords (m)</b> To play a minor chord, keep the major chord key depressed and press any other accompaniment keyboard key located to the right of the major chord key.</p>	<p>C minor (Cm)</p>
<p><b>Seventh chords (7)</b> To play a seventh chord, keep the major chord key depressed and press any other two accompaniment keyboard keys located to the right of the major chord key.</p>	<p>C seventh (C7)</p>
<p><b>Minor seventh chords (m7)</b> To play a minor seventh chord, keep the major chord key depressed and press any other three accompaniment keyboard keys located to the right of the major chord key.</p>	<p>C minor seventh (Cm7)</p>

#### NOTE

- It makes no difference whether you press black or white keys to the right of a major chord key when playing minor and seventh chords.

### FINGERED

FINGERED provides you with a total of 15 different chord types. The following describes the FINGERED "Accompaniment keyboard" and "Melody keyboard", and tells you how to play a C-root chord using FINGERED.

#### FINGERED Accompaniment Keyboard and Melody Keyboard

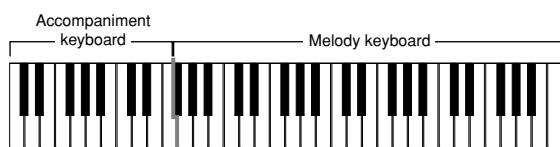

#### NOTE

- The accompaniment keyboard can be used for playing chords only. No sound will be produced if you try playing single melody notes on the accompaniment keyboard.

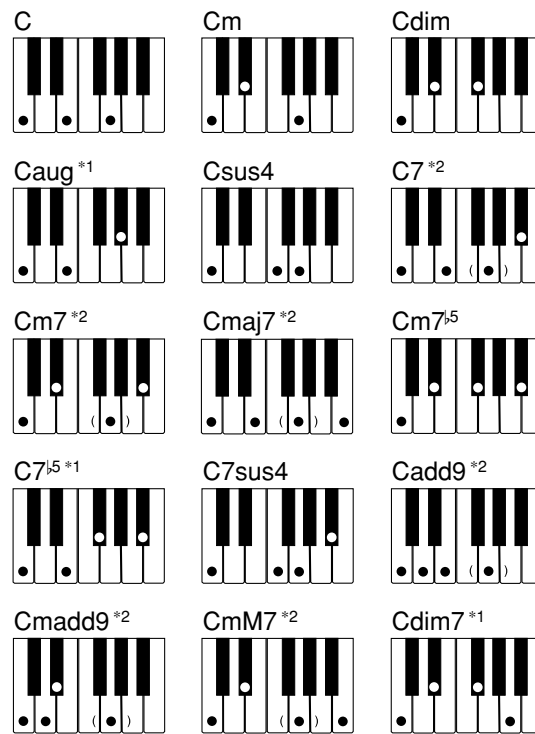

See the "Fingered Chord Chart" on page A-4 for details on playing chords with other roots.

- \*1: Inverted fingerings cannot be used. The lowest note is the root.
- \*2: The same chord can be played without pressing the 5th G.

#### NOTE

- Except for the chords specified in note\*1 above, inverted fingerings (i.e. playing E-G-C or G-C-E instead of C-E-G) will produce the same chords as the standard fingering.
- Except for the exception specified in note\*2 above, all of the keys that make up a chord must be pressed. Failure to press even a single key will not play the desired FINGERED chord.

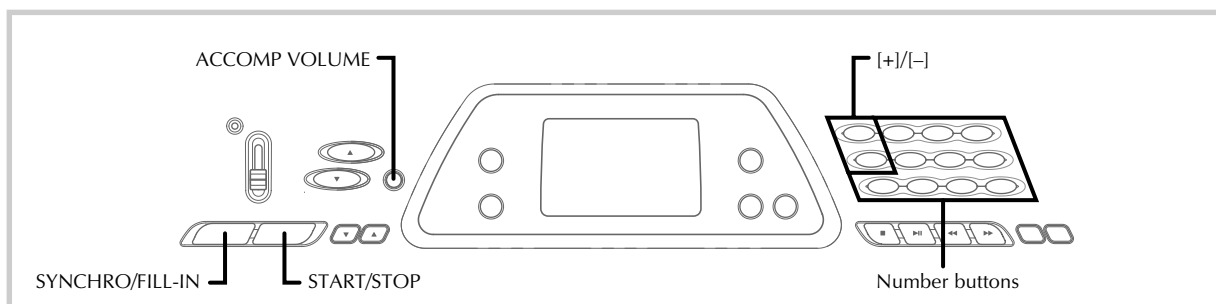
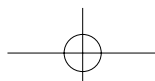

### Using a Fill-in Pattern

Fill-in patterns let you momentarily change the rhythm pattern to add some interesting variation to your performances.

The following procedure describes how to use the Fill-in feature.

#### To insert a fill-in

1. Press the **START/STOP** button to start rhythm play.
2. Press the **SYNCHRO/FILL-IN** button to insert a fill-in pattern for the rhythm you are using.

### Synchro Starting Accompaniment with Rhythm Play

You can set up the keyboard to start rhythm play at the same time you play the accompaniment on the keyboard.

The following procedure describes how to use synchro start. Before starting, you should first select the rhythm you want to use, set the tempo, and use the POWER/MODE switch to select the chord play method you want to use (CASIO CHORD, FINGERED).

#### To use synchro start

1. Press the **SYNCHRO/FILL-IN** button to put the keyboard into synchro start standby.



2. Play a chord on the accompaniment keyboard and the rhythm pattern starts to play automatically.

#### NOTE

- If the POWER/MODE switch is set to NORMAL, only the rhythm plays (without a chord) when you play on the accompaniment keyboard.
- To cancel synchro start standby, press the SYNCHRO/FILL-IN button one more time.

### Adjusting the Accompaniment Volume

You can adjust the volume of the accompaniment parts as a value in the range of 0 (minimum) to 9.

1. Press the **ACCOMP VOLUME** button.

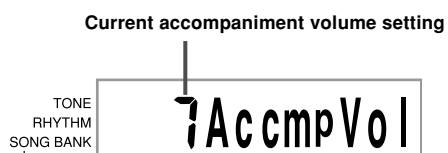

2. Use the **number buttons** or the **[+]/[-]** buttons to change the current volume setting value.

Example: 5



#### NOTE

- The current accompaniment volume value that appears in Step 1 automatically clears from the display if you do not input anything within about five seconds.
- Pressing [+ ] and [- ] buttons at the same time automatically sets an accompaniment volume of 7.

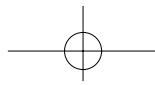

# Using the Song Bank

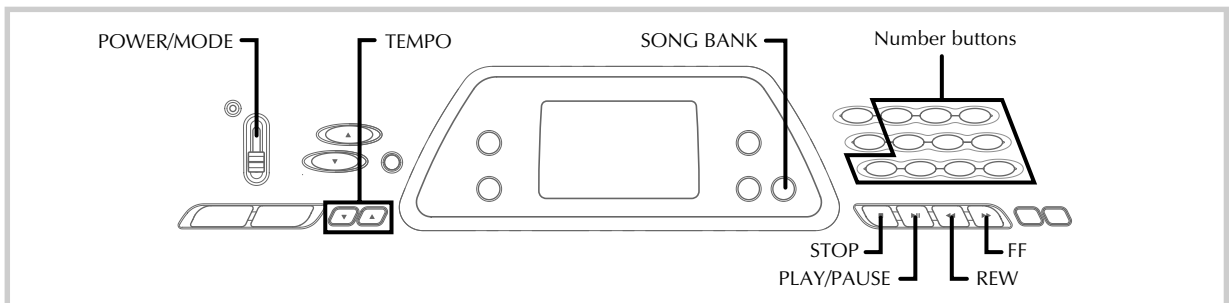

A selection of 100 Song Bank tunes comes built-in for your listening enjoyment or play along fun. You can turn off the left-hand or right-hand part to practice with the remaining part, and the display even shows you what keys to press and which fingers you should use.

## Playing Back a Song Bank Tune

### To play back a Song Bank tune

1. Set the **POWER/MODE switch** to **NORMAL**, **FINGERED**, or **CASIO CHORD**.
2. Adjust the main volume and accomp volume.
3. Press the **SONG BANK button** to enter the Song Bank Mode.

Appears when **SONG BANK** button is pressed



4. Use the Song Bank list to find the tune you want to play back, and then use the **number buttons** to input the tune's two-digit number.

Example: To select "49 ALOHA OE", input 4 and then 9.

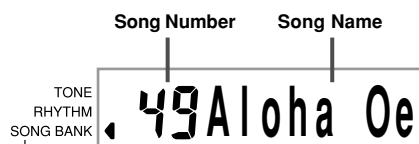

### NOTE

- "00 A WHOLE NEW WORLD (ALADDIN'S THEME)" is the initial default Song Bank tune setting whenever you turn on keyboard power.
- You can also increment the displayed tune number by pressing [+] and decrement is by pressing [-].
- Before advancing to the next step, which actually starts playback, you can adjust the tempo (page E-19), select a tone (page E-16) for the melody part, or turn off the left-hand or right-hand part (page E-24).

5. Press the **PLAY/PAUSE button** to start play of the tune.

Appears when **PLAY/PAUSE** button is pressed

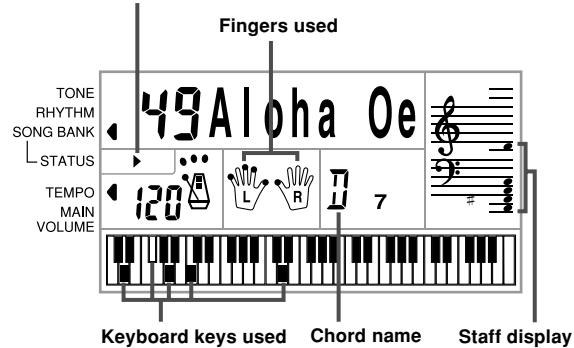

6. Press the **STOP button** to stop playback of the Song Bank tune.



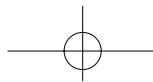

### To pause Song Bank tune play

1. While a Song Bank tune is playing, press the **PLAY/PAUSE** button to pause it.

The indicator "II" appears while a tune play is paused.

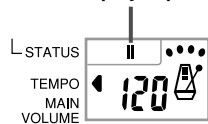

2. To resume play, press **PLAY/PAUSE** again.

### To fast reverse during playback

1. While playback is in progress, hold down the **REW** button.

The indicator "◀◀" appears while a fast reverse operation is in progress.

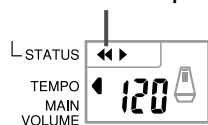

- Beeps sound during fast reverse to give you an idea of where you are located in the tune.  
1 beep: indicates a change to another measure.  
2 beeps: indicates the beginning of the tune.

2. To resume normal playback, release the **REW** button.

### To fast forward during playback

1. While playback is in progress, hold down the **FF** button.

The indicator "▶▶" appears while a fast forward operation is in progress.

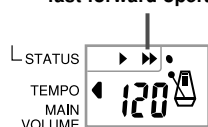

- Beeps sound during fast forward to give you an idea of where you are located in the tune.  
1 beep: indicates a change to another measure.  
3 beeps: indicates the ending of the tune.

2. To resume normal playback, release the **FF** button.

#### NOTE

- Each time you select a new Song Bank tune, the tone, tempo, and rhythm that is programmed for the tune are automatically selected. You can change a tune's tone and tempo during playback, but you cannot change the rhythm.
- You can also adjust the accompaniment volume (page E-21) for tunes 00 through 79.

### Song Bank Mode Display

In the Song Bank Mode, the display shows a variety of information about the tune being played.

[Playback Display]

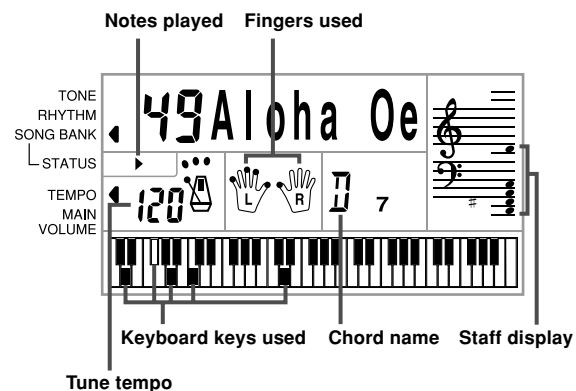

#### NOTE

- Chord names are not displayed for Songs 80 through 99.

### Adjusting the Tempo of a Song Bank Tune

#### To change the tempo of a Song Bank tune

The tempo can be set within a range of 20 to 255 beats per minute. The tempo setting can be adjusted while the tune is stopped, playing back, or paused.

Use the **TEMPO** buttons [▲/▼] to adjust the tempo.

- ▲: each press increases the value
- ▼: each press decreases the value

#### NOTE

- Pressing both the [▲] and [▼] TEMPO buttons at the same time returns the tempo setting to the preset value for the currently selected tune.
- Song Bank tunes 80 through 99 are arranged so their tempos change part way through the tunes. If you use the above procedure to change the tempo setting while one of these tunes is playing, however, the tempo you set is used for the entire tune without any change part way through.

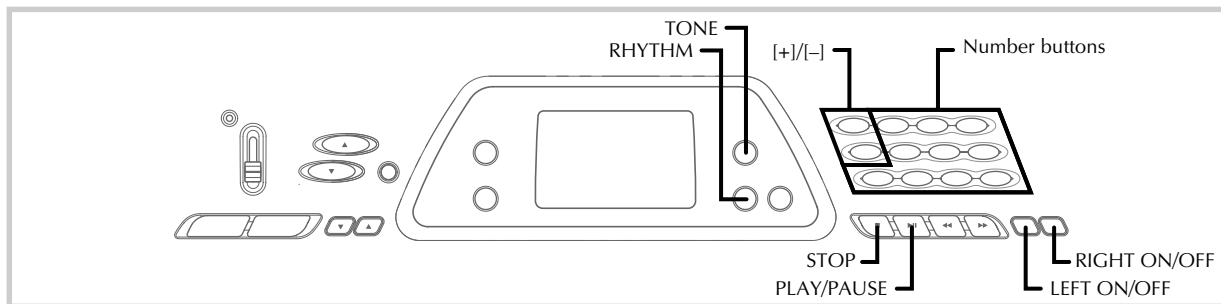
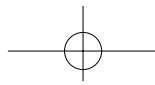

### Changing the Tone of a Song Bank Tune's Melody

You can select any one of the keyboard's 100 tones to be used to play the melody part of a Song Bank tune. The tone setting can be changed while the tune is stopped or playing back.

1. While a song is playing back, press the **TONE button**.



2. Find the tone you want in the Tone List, and then use the **number buttons** or the **[+]** and **[-]** buttons to specify the tone number.

Example: To select "30 VIOLIN", input 3 and then 0.



#### NOTE

- Pressing both the **[+]** and **[-]** buttons at the same time selects "00 PIANO 1".
- With two-hand tunes (80 to 99), you can select tones for both the left hand part and right hand part.
- To return a Song Bank tune to its original settings, simply select that tune again.

### Playing Along with a Song Bank Tune

Each Song Bank tune has a left-hand (accompaniment) part and a right-hand (melody) part. You can turn off the left-hand part or right-hand part of a Song Bank tune and play along with the remaining part on the keyboard.

Tune Numbers	00 to 79	80 to 99
Accompaniment Type	Auto-accompaniment	Piano Solo
Left-hand Part	Auto-accompaniment (percussion, bass, chords)	Left-hand notes
Right-hand Part	Melody	Right-hand notes

#### To play along with a Song Bank tune

1. Perform steps 1 through 4 under "To play back a Song Bank tune" on page E-22 to select the song you want to play along with.
2. Press the **RIGHT ON/OFF** or **LEFT ON/OFF button** for the part you want to turn off.
  - Press the **RIGHT ON/OFF** button to turn off the right hand (melody) part, or the **LEFT ON/OFF** button to turn off the left hand (accompaniment) part.
  - The on/off status of each part is indicated by letters (L and R) that appear inside the hand graphics on the display. A part is turned on when its letter is displayed, and turned off when its letter is not displayed.



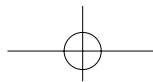

- Press the **PLAY/PAUSE** button to start play of the Song Bank Tune.
  - Only the part (melody or accompaniment) that is turned on is played, so you can play the other part on the keyboard.



- The keys you should press are indicated on the display's graphic keyboard.
- You can press the **RIGHT ON/OFF** and **LEFT ON/OFF** buttons to turn parts on and off while playback is in progress.

- To end playback, press the **STOP** button.

#### **Auto-accompaniment Tunes (Tune Numbers 00 to 79)**

During playback of these tunes in the Song Bank Mode, the chord specification method for the left hand is always **FIN-GERED** for these tunes, regardless of the **POWER/MODE** switch setting.

#### **Two-hand Tunes (Tune Numbers 80 to 99)**

During playback of these tunes in the Song Bank Mode, the entire keyboard functions as a melody, regardless of the **POWER/MODE** switch setting.

#### **NOTE**

- With two-hand tunes (80 to 99), you cannot turn off both the left-hand and right-hand parts at the same time. Turning off a part causes the other part to turn on automatically.
- The selected Song Bank tune continues to repeat until you stop playback by pressing the **STOP** button.
- The accompaniment volume setting (page E-21) affects auto-accompaniment tunes (00 to 79) only.
- Chord names are not displayed during playback of two-hand tunes (80 to 99).
- Turning off both the left-hand and right-hand parts of the auto-accompaniment tunes (00 to 79) results in obligato accompaniment being played.

### **Applause Sound**

Whenever you turn off the left hand or right hand part of a Song Bank tune and play it back, an applause sound is produced when the tune reaches the end.

#### **To turn off the applause sound**

Press the **STOP** button and the **LEFT ON/OFF** or **RIGHT ON/OFF** button at the same time.



- Pressing the **STOP** button and the **LEFT ON/OFF** or **RIGHT ON/OFF** button at the same time again turns the applause sound back on.

### **Playing Back All Song Bank Tunes in Succession**

- Use the **TONE** or **RHYTHM** button to change to any mode other than the Song Bank Mode.
  - Make sure a dot is not on the display next to the **SONG BANK** indicator.

Indicator turns off.



- Press the **PLAY/PAUSE** button to start playback of the Song Bank tunes starting from tune 00.
- To stop Song Bank tune playback, press the **STOP** button.
  - Pausing playback automatically cancels consecutive playback of all Song Bank tunes. Re-starting playback causes repeat playback of the current tune only.

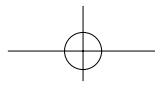

# Using the Chord Book

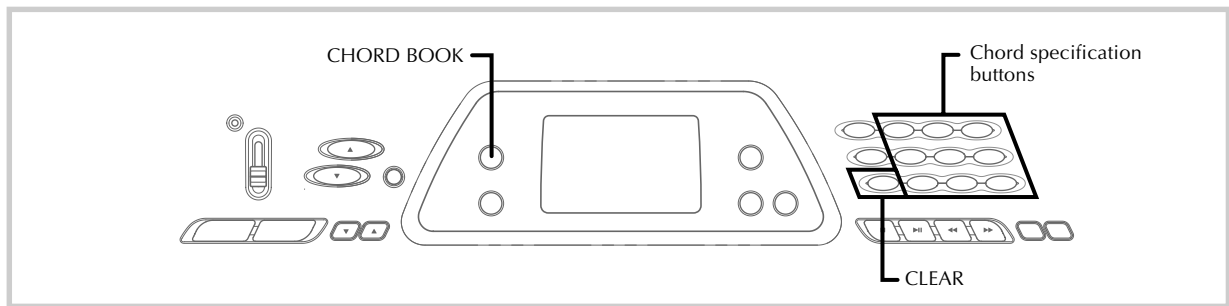

The Chord Book feature of this keyboard makes it possible for you to look up information about chords quickly and easily. Simply input the name of the chord and the keyboard keys you should press, the fingers you should use, and the notes that make up the chord appear on the display along with the chord name.

## What is a chord?

A chord is made up of a root note, upon which is stacked a number of other notes. A variety of different chords can be created by changing the notes stacked onto a root.

<Example: C chord>

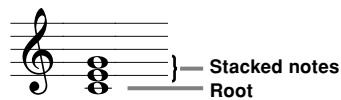

## Chord Names

Chords are named using upper-case letters from A through G, which indicate the root note of the chord. If the root note is a sharp or flat, the chord itself is sharp or flat. A chord name may also be followed by a degree number or other symbols that indicate certain characteristics about the chord.

<Examples>

<b>C</b> Root	<b>F#</b> Root	<b>Bb</b> Root	<b>Am</b> Root	<b>C# dim</b> Root
<b>G7</b> — Degree Root	<b>FM7</b> Root Degree	<b>Esus4</b> Root		

<Note Names>

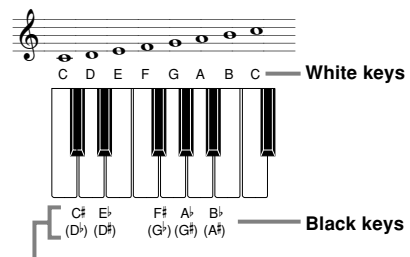

Sharps and flats can be referred to using either of the names shown here. The names in the upper row of this illustration are used by this keyboard, because they are the names that are most commonly used in musical notation.

## Inverted Forms

There are a number of different ways to play the same chord. A form that is different from the basic form but still produces the same chord is called an "inverted form."

<Example: C chord>

All of the following are C chords.

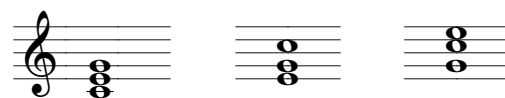

## Looking Up a Chord Using the Chord Book

1. Press the **CHORD BOOK** button to enter the Chord Book mode.

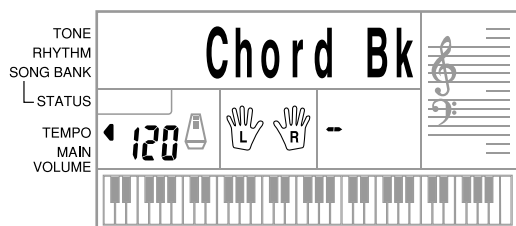

2. Press the **CLEAR** button.
  - This step is necessary to clear any previously input chord name.
3. If the chord name you plan to input is a non-major chord, use the **chord specification buttons** to specify the chord type.
  - Chord types are indicated by the small letters above the chord specifications buttons.
  - Non-major chords include minor, seventh, sustained, etc. chords.
  - See page E-28 for details on the chord specification buttons.
  - Skip step 3 if you want to input a major chord name.

<Example: F#m7-5>

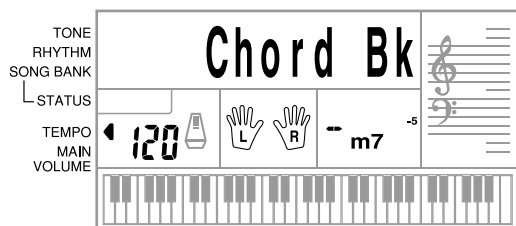
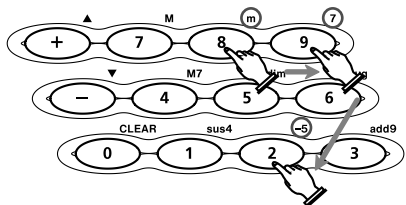

4. Press the accompaniment keyboard key that corresponds to the root note of the chord.
  - A dash appears in place of the chord name if the chord cannot be recognized by the keyboard.
  - To specify F#, for example, press the F# key.
  - The key you press is indicated on the graphic keyboard and the corresponding chord sounds.

<Example: F#m7-5>

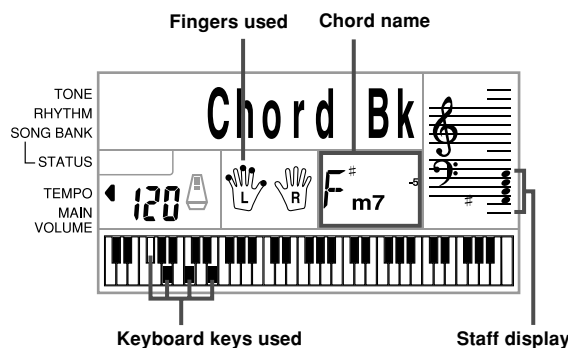
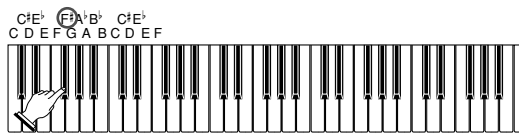

5. Check to make sure that the chord name on the display is the one you want. If it isn't, repeat the above from step 2.
6. If the chord is correct, you can see its fingering on the graphic keyboard. Try playing the chord on the keyboard.

<Example>

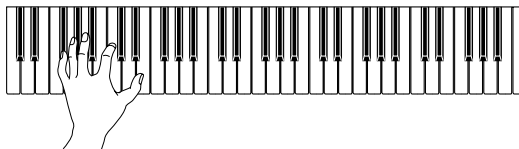

### NOTE

- The fingering that appears on the display is one standard fingering. You can also use other fingerings to match the size of your hands or to make it easier to progress from or to neighboring chords.
- You can also use the [+] and [-] buttons to change the displayed chord name.
- The tone used to sound chords you play on the accompaniment keyboard while using the Chord Book is the same tone used by the accompaniment part of the rhythm that was selected before you entered the Chord Book mode. Depending on the rhythm that was selected, some of the notes that make up a chord may be omitted when you play the chord on the accompaniment keyboard in the Chord Book Mode. This is due to the internal chord conversion function, arrangements, and polyphony limitations. Because of this, you should always play the chords indicated on the display on the melody keyboard (the range that does not have chord names printed above the keys).

## Chord Name Modifier Keys

Chord Type	Symbol and Name	Reference	Modifier Key
major	C (C major)		_____
minor	Cm (C minor)		
aug	Caug (C augmented)	C+5	
sus 4	Csus4 (C sustained fourth)		
dim	Cdim (C diminished)	C°	
7th	C7 (C seventh)		
M7	CM7 (C major seventh)	Cmaj7 CA7	
minor 7	Cm7 (C minor seventh)		
minor M7	CmM7 (C minor Major seventh)		
minor7-5	Cm7-5 (C minor seventh flat five)	C°	

Chord Type	Symbol and Name	Reference	Modifier Key
7sus 4	C7sus4 (C seventh sus fourth)		
add 9	Cadd9 (C add ninth)		
m add 9	Cm add9 (C minor add ninth)		
7th-5	C7-5 (C seventh flat five)	C7,5	
dim7	Cdim7 (C diminished seventh)		

### NOTE

- Since the chord fingerings that appear on the display are selected to allow chord play within the accompaniment keyboard, inverted chord forms (page E-26) are often suggested. Inverted chord forms are useful to help you learn how to play chord variations that make it possible to move from one chord to another with minimal hand movement. These forms come in handy when using FINGERED Auto Accompaniment play.
- While a chord name is on the display, you can press keys on the accompaniment keyboard to find out the fingerings of the same chord with a different root.
- You can also scroll through chord names using the [+] and [-] buttons.
- Chord fingerings that appear on the display are formed using only the keys within the range of the accompaniment keyboard (leftmost 18 keys). Chords that cannot be formed using the keys within this range are not displayed.

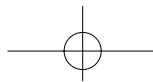

# Keyboard Settings

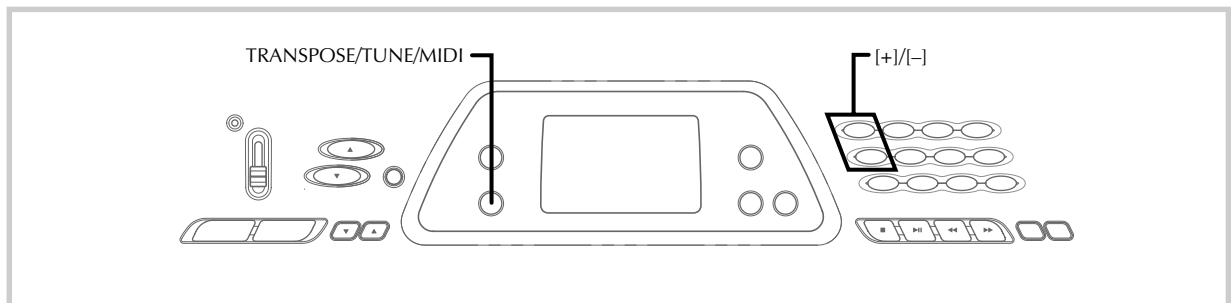

## Transposing the Keyboard

Transpose lets you raise and lower the overall key of the keyboard in semitone units. If you want to play an accompaniment for a vocalist who sings in a key that's different from the keyboard, for example, simply use transpose to change the key of the keyboard.

### To transpose the keyboard

1. Press the **TRANPOSE/TUNE/MIDI** button until the transpose screen appears on the display.

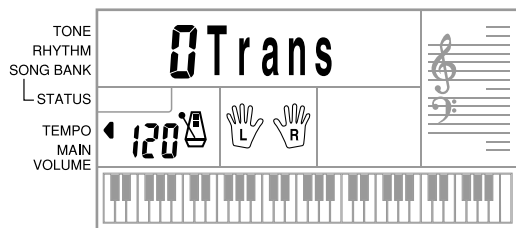

2. Use **[+]** and **[-]** to change the transpose setting of the keyboard.

*Example:* To transpose the keyboard five semitones upwards.



### NOTE

- The keyboard can be transposed within a range of -6 to +5.
- The default transpose setting is "0" when keyboard power is turned on.
- If you leave the transpose screen on the display for about five seconds without doing anything, the screen is automatically cleared.
- The transpose setting also affects Auto Accompaniment.
- Playing back a Song Bank tune automatically returns the transpose setting to its standard default of "0".

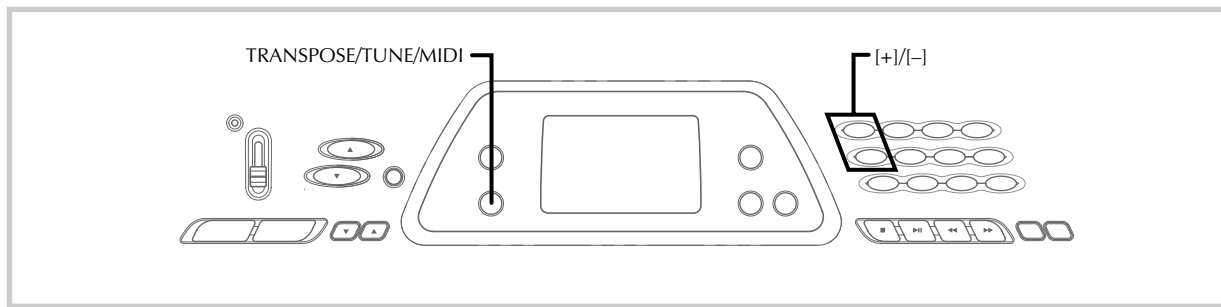
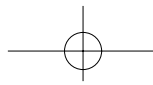

## Tuning the Keyboard

The tuning feature lets you fine tune the keyboard to match the tuning of another musical instrument.

### To tune the keyboard

1. Press the **TRANPOSE/TUNE/MIDI** button twice to display the tuning screen.

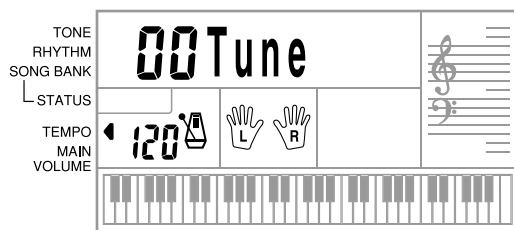

2. Use **[+]** and **[-]** to change the tuning setting of the keyboard.

*Example:* To lower the tuning by 20.

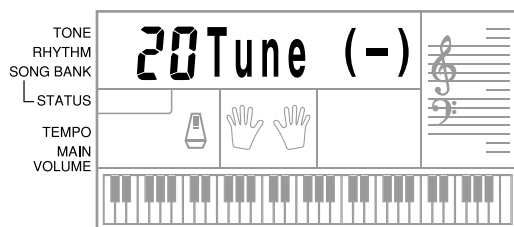

### NOTE

- The keyboard can be tuned within a range of -50 cents to +50 cents.  
\*100 cents is equivalent to one semitone.
- The default tuning setting is "00" when keyboard power is turned on.
- If you leave the tuning screen on the display for about five seconds without doing anything, the screen is automatically cleared.
- The tuning setting also affects Auto Accompaniment.
- Playing back a Song Bank tune automatically returns the tuning setting to its standard default of "00".



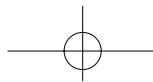

# MIDI

## What is MIDI?

The letters MIDI stand for Musical Instrument Digital Interface, which is the name of a worldwide standard for digital signals and connectors that makes it possible to exchange musical data between musical instruments and computers (machines) produced by different manufacturers. MIDI compatible equipment can exchange keyboard key press, key release, tone change, and other data as messages.

Though you do not need any special knowledge about MIDI to use this keyboard as a stand-alone unit, MIDI operations require a bit of specialized knowledge. This section provides you with an overview of MIDI that will help to get you going.

## MIDI Connections

MIDI messages are sent out through the MIDI OUT terminal of one machine to the MIDI IN terminal of another machine over a MIDI cable. To send a message from this keyboard to another machine, for example, you must use a MIDI cable to connect the MIDI OUT terminal of this keyboard to the MIDI IN terminal of the other machine. To send MIDI messages back to this keyboard, you need to use a MIDI cable to connect the other machine's MIDI OUT terminal to the MIDI IN terminal of this keyboard.

To use a computer or other MIDI device to record and playback the MIDI data produced by this keyboard, you must connect the MIDI IN and MIDI OUT terminals of both machines in order to send and receive data.

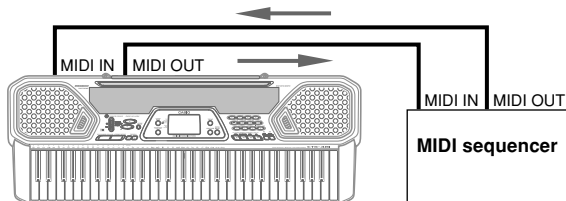

## MIDI Channels

MIDI allows you to send the data for multiple parts at the same time, with each part being sent over a separate MIDI channel. There are 16 MIDI channels, numbered 1 through 16, and MIDI channel data is always included whenever you exchange data (key press etc.).

Both the sending machine and the receiving machine must be set to the same channel for the receiving unit to correctly receive and play data. If the receiving machine is set to Channel 2, for example, it receives only MIDI Channel 2 data, and all other channels are ignored.

With this keyboard, messages received over MIDI Channels 1, 2, 3, 4, and 10 can be used for multi-timbre play of up to five different instrument parts. The tone and volume settings for these five channels must be controlled by messages sent from an external device.

When sending operation of this keyboard to an external device, Channel 1 should be selected as the MIDI send channel.

## General MIDI

General MIDI standardizes MIDI data for all sound source types, regardless of manufacturer. General MIDI specifies such factors as tone numbering, drum sounds, and available MIDI channels for all sound sources. This standard makes it possible for all MIDI equipment to reproduce the same nuances when playing General MIDI data, regardless of the manufacturer of the sound source.

Though the sound source of this keyboard is not General MIDI compatible, you can still connect the keyboard to a computer or other MIDI equipment to playback General MIDI data that is widely available in stores, over computer networks, and from other sources.

### NOTE

- General MIDI data made up of a large number of parts may not play correctly on this keyboard.
- You will have most success playing back General MIDI data that has few parts and is made up of data on channels 1, 2, 3, 4, and 10.

## Messages

There is a wide variety of messages defined under the MIDI standard, and this section details the particular messages that can be sent and received by this keyboard.

### NOTE ON/OFF

This message sends data when a key is pressed (NOTE ON) or released (NOTE OFF).

A NOTE ON/OFF message include a note number (to indicate note whose key is being pressed or released) and velocity (keyboard pressure as a value from 1 to 127).

NOTE ON velocity is always used to determine the relative volume of the note. This keyboard does not receive NOTE OFF velocity data.

Whenever you press or release a key on this keyboard, the corresponding NOTE ON or NOTE OFF message is sent by constant velocity from the MIDI OUT terminal.

### NOTE

- The pitch of a note depends on the tone that is being used, as shown in the Note Table on page A-2. Whenever this keyboard receives a note number that is outside its range for that tone, the same tone in the nearest available octave is substituted.

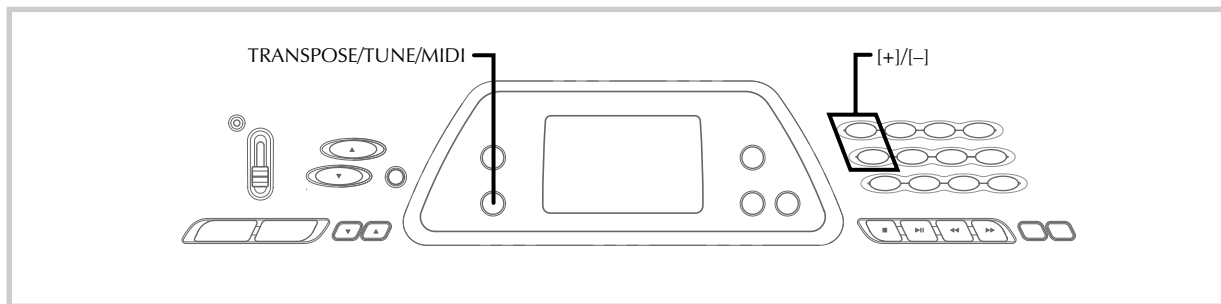
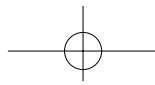

### PROGRAM CHANGE

This is the tone selection message. PROGRAM CHANGE can contain tone data within the range of 0 to 127.

A PROGRAM CHANGE message (0 to 99) is sent out through this keyboard's MIDI OUT terminal whenever you manually change its tone number. Receipt of a PROGRAM CHANGE message from an external machine changes the tone setting of this keyboard (this page).

This keyboard can send tone data within the range of 00 to 99 and receive tone data within the range of 0 to 127.

### PITCH BEND

This message carries pitch bend information for smoothly sliding the pitch upwards or downwards during keyboard play. This keyboard does not send pitch bend data, but is can receive such data.

### CONTROL CHANGE

This message adds effects such as vibrato and volume changes applied during keyboard play.

CONTROL CHANGE data includes a control number (to identify the effect type) and a control value (to specify the on/off status and depth of the effect).

The following is a list of data that can be received using CONTROL CHANGE.

Effect	Control Number
VOLUME	7
HOLD1 *	64
MODULATION	1

\* Pressing the foot pedal causes the sustain effect (HOLD1) to be sent (control number 64).

## Changing MIDI Settings

This keyboard lets you change the settings of two MIDI parameters: TONE MAP and KEYBOARD CHANNEL.

### To change MIDI parameters

1. Press the **TRANSCOPE/TUNE/MIDI** button either three or four times to select the parameter you want.

Press the TRANSCOPE/TUNE/MIDI button three times: KEYBOARD CHANNEL

Press the TRANSCOPE/TUNE/MIDI button four times: TONE MAP

*Example:* To select the TONE MAP parameter.



2. Use **[+]** and **[-]** to change the setting of the parameter.

*Example:* To change the TONE MAP parameter value to "G" (GM).



- If you accidentally go past parameter you want, keep pressing the TRANSCOPE/TUNE/MIDI button until parameter you want reappears on the display.
- If you leave the parameter selection screen on the display for about five seconds without doing anything, the parameter selection screen is automatically cleared.

## Parameters and Their Displays

### ■ KEYBOARD CHANNEL (Basic Channel) (Default: 01)

This parameter specifies the keyboard MIDI message send channel.

TONERHYTHMSONG BANK  
01Keybd CH

### ■ TONE MAP G/N (Default: N)

**N:** This setting specifies the normal tone map, which allows receipt of a program change value in the range of 0 to 99. Only tones that correspond to the 100 built-in tones of this keyboard can be played, and tone numbers outside this range are ignored.

TONERHYTHMSONG BANK  
TonMap=N

**G:** This setting specifies the General MIDI tone map, which allows receipt of a program change value in the range of 0 to 127. Each of the 128 General MIDI tones is automatically assigned to one of the keyboard's 100 built-in tones as shown on page A-2. Select this setting when you want to listen to General MIDI data from a computer or other external equipment.

TONERHYTHMSONG BANK  
TonMap=G

### ■ NOTE

- Playing a Song Bank tune causes all MIDI parameters to revert to their default settings.
- Song Bank data cannot be sent as MIDI data.
- MIDI messages cannot be received while the keyboard is in the Song Bank Mode.

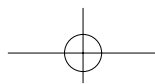

# Troubleshooting

Problem	Possible Cause	Action	See page
No keyboard Sound	<ol style="list-style-type: none"> <li>1. Power supply problem.</li> <li>2. Power is not turned on.</li> <li>3. Volume setting is too low.</li> <li>4. The POWER/MODE switch is in the CASIO CHORD or FINGERED position.</li> </ol>	<ol style="list-style-type: none"> <li>1. Correctly attach the AC adaptor, make sure that batteries poles (+/-) are facing correctly, and check to make sure that batteries are not dead.</li> <li>2. Set the POWER/MODE switch to the NORMAL position.</li> <li>3. Use the MAIN VOLUME buttons to increase volume.</li> <li>4. Normal play is not possible on the accompaniment keyboard while the POWER/MODE switch is set to CASIO CHORD or FINGERED. Change the POWER/MODE switch setting to NORMAL.</li> </ol>	<p>Pages E-13, 14</p> <p>Page E-16</p> <p>Page E-16</p> <p>Page E-16</p>
<p>Any of the following symptoms while using battery power.</p> <ul style="list-style-type: none"> <li>• Dim power indicator</li> <li>• Instrument does not turn on</li> <li>• Display that is flickering, dim, or difficult to read</li> <li>• Abnormally low speaker/headphone volume</li> <li>• Distortion of sound output</li> <li>• Occasional interruption of sound when playing at high volume</li> <li>• Sudden power failure when playing at high volume</li> <li>• Flickering or dimming of the display when playing at high volume</li> <li>• Continued sound output even after you release a key</li> <li>• A tone that is totally different from the one that is selected</li> <li>• Abnormal rhythm pattern and Song Bank play</li> <li>• Loss of power, sound distortion, or low volume when playing from a connected computer or MIDI device</li> </ul> <p>&lt;CTK-491 only&gt;</p> <ul style="list-style-type: none"> <li>• Distortion of microphone input</li> <li>• Dim power supply indicator when a microphone is used</li> <li>• Sudden power failure when using the microphone</li> </ul>	Low battery power	Replace the batteries with a set of new ones or use the AC adaptor.	Pages E-13, 14
Auto Accompaniment does not sound.	Auto accompaniment volume is set to 0.	Use the ACCOMP VOLUME button to increase the volume.	Page E-21
The key or tuning does not match when playing along with another instrument.	The tuning or transpose parameter is set to a value other than 0 or 00.	Change the transpose or tuning parameter value to 0 or 00.	Pages E-29, 30

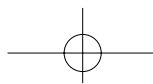

Problem	Possible Cause	Action	See page
Missing Song Bank tune.	1. Left-hand or right-hand part is turned off.  2. Accompaniment volume is set to 0.	1. Check the display to see if the indicator for one of the parts is not displayed. If so, press the part's button (LEFT ON/OFF, RIGHT ON/OFF) to turn it on.  2. Adjust accompaniment volume.	Page E-24  Page E-21
No sound is produced when playing MIDI data from a computer.	MIDI cables are not connected properly.	Connect MIDI cables properly.	Page E-31
The bass notes of General MIDI data being played back by a computer are one octave too low.	TONE MAP is turned "N".	Change TONE MAP parameter to "G".	Page E-33
Playing on the keyboard produces an unnatural sound when connected to a computer.	The computer's MIDI THRU function is turned on.	Turn off the MIDI THRU function on the computer or turn off LOCAL CONTROL on the keyboard.	See the documentation that comes with your computer or sequencer.
Static noise when a microphone is connected.	1. Use of a microphone that is a different from the type that is recommended.  2. Use of the microphone in the vicinity of fluorescent lighting.	1. Use a full metal shielded Cannon type microphone.  2. Move the microphone away from source of the static.	Page E-17  Page E-17
No microphone sound	1. Microphone volume setting is too low.  2. Microphone on/off switch is set to OFF.	1. Increase the microphone volume setting.  2. Change the microphone on/off switch setting to ON.	Page E-17  Page E-17

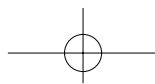

# Specifications

<b>Model:</b>	CTK-481/CTK-491
<b>Keyboard:</b>	61 standard-size keys, 5 octaves
<b>Tones:</b>	100
<b>Polyphony:</b>	12 notes maximum (6 for certain tones)
<b>Auto Accompaniment</b> Rhythm Patterns: Tempo: Chords: Rhythm Controller: Accomp Volume:	100 Variable (236 steps, ♩ = 20 to 255) 2 fingering methods (CASIO CHORD, FINGERED) START/STOP, SYNCHRO/FILL-IN 0 to 9 (10 steps)
<b>Song Bank</b> Tunes: Controllers:	100 PLAY/PAUSE, STOP, REW, FF, LEFT ON/OFF (ACCOMP), RIGHT ON/OFF (MELODY)
<b>Display</b> Name display: Tempo: Chord: Fingering: Song Bank Status: Staff: Keyboard:	TONE, RHYTHM, SONG BANK name/number, keyboard settings name/value Tempo value, metronome, synchro standby, beat indicator, volume setting Chord name, Chord form Fingering indicators, parts PLAY, PAUSE, REW, FF 5 octaves with sharp and flat indications, pedal symbol, octave symbol 5 octaves
<b>MIDI:</b>	5 multi-timbre receive
<b>Other Functions</b> Transpose: Tuning: Volume:	12 steps (-6 semitones to +5 semitones) Variable (A4 = approximately 440Hz ±50 cents) 0 to 9 (10 steps)
<b>Terminals</b> MIDI Terminals: Sustain Terminal: Phones/Output Terminal:  Power Supply Terminal: <CTK-491 only> Microphone In:	IN, OUT Standard jack Stereo standard jack (Output is monaural.) Output Impedance: 78Ω Output Voltage: 4V (RMS) MAX 9V DC  Standard jack (with microphone volume dial) Input impedance: 40kΩ Input sensitivity: 10mV
<b>Power Supply:</b> Batteries: Battery Life:  AC Adaptor: Auto Power Off:	Dual power supply system 6 AA-size batteries Approximately 4 hours continuous operation on alkaline batteries Approximately 2 hours continuous operation on manganese batteries AD-5 Turns power off approximately 6 minutes after last key operation. Enabled under battery power only, can be disabled manually.
<b>Speaker Output:</b>	2.0W + 2.0W
<b>Power Consumption:</b>	9V ∴ 7.7W
<b>Dimensions:</b>	95.6 x 35.3 x 12.5 cm (37 <sup>11</sup> / <sub>16</sub> x 13 <sup>15</sup> / <sub>16</sub> x 4 <sup>15</sup> / <sub>16</sub> inch)
<b>Weight:</b>	Approximately 4.0kg (8.8lbs) (without batteries)

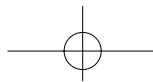

## Care of your keyboard

### ***Avoid heat, humidity or direct sunlight.***

Do not overexpose the instrument to direct sunlight, or place it near an air conditioner, or in any extremely hot place.

### ***Do not use near a TV or radio.***

This instrument can cause video or audio interference with TV and radio reception. If this happens, move the instrument away from the TV or radio.

### ***Do not use lacquer, thinner or similar chemicals for cleaning.***

Clean the keyboard with a soft cloth dampened in a weak solution of water and a neutral detergent. Soak the cloth in the solution and squeeze until it is almost dry.

### ***Avoid use in areas subjected to temperature extremes.***

Extreme heat can cause figures on the LCD screen to become dim and difficult to read. This condition should correct itself when the keyboard is brought back to normal temperature.

#### **NOTE**

- You may notice lines in the finish of the case of this keyboard. These lines are a result of the molding process used to shape the plastic of the case. They are not cracks or breaks in the plastic, and are no cause for concern.

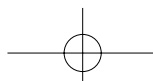

# Appendix/Apéndice

## **Tone List**

### **Lista de sonidos**

SYNTH-SOUND	
60	SYN-LEAD 1
61	SYN-LEAD 2
62	SYN-LEAD 3
63	SYN-CALLIOPE
64	SYN-PAD 1
65	SYN-PAD 2
66	SYN-PAD 3
67	GLASS HMCA
68	COUNTRY FARM
69	SYN-BASS
70	PEARL DROP
71	COSMIC SOUND
72	SOUNDTRACK
73	SPACE PAD
74	VOICE BASS
75	APPLAUSE
76	SYNTH-SFX
77	VEHICLE
78	PHONE
79	FUNNY

LAYER	
80	STR PIANO
81	STR E.PIANO
82	CHOIR E.P
83	CHOIR ORGAN
84	STR GUITAR
85	STR HARP
86	BRASS STR
87	VIB PAD
88	12 STR GTR
89	CHOIR STR



**Note Table**

**Tabla de notas**

(1)	(2)	(3)	(4)	(1)	(2)	(3)	(4)	(1)	(2)	(3)	(4)	(1)	(2)	(3)	(4)	(1)	(2)	(3)	(4)
00	12	A	000	10	12	A	016	20	12	A	024	30	12	A	040, 041	40	12	A	056
01	12	A	001	11	12	A	017	21	12	A	025	31	12	B	042, 043	41	12	B	058
02	6	A	003	12	12	A	018	22	12	A	026	32	12	A	045, 046, 047	42	6	A	057
03	6	A	002	13	6	A	015	23	12	A	027	33	12	A	048, 055	43	12	B	060
04	12	A	004	14	12	A	019	24	12	A	028	34	12	A	049	44	6	B	059
05	12	A	005	15	6	A	104	25	12	A	029, 030, 031, 084	35	6	A	044	45	12	B	061
06	6	A	008	16	12	A	020	26	12	B	032	36	12	A	050	46	6	B	069
07	6	A	009	17	6	A	021	27	12	B	033, 034, 035	37	6	A	051	47	12	B	062
08	12	A	006	18	12	A	023	28	12	B	036, 037	38	12	A	091, 052	48	6	B	063, 083
09	12	A	007	19	12	A	022	29	12	A	105	39	12	A	053	49	6	B	070
50	12	A	064	60	12	A	087	70	6	A	096	80	6	A	106	90	12	E	100, 116
51	12	A	065	61	6	A	081, 086	71	6	A	103	81	6	A	088, 107	91	6	E	117
52	12	A	066, 067	62	12	A	080	72	6	A	097	82	6	A	108	92	12	E	118
53	12	A	068	63	6	A	082	73	6	A	101	83	6	A	109	93	12	E	119
54	12	A	071	64	6	A	089	74	12	B	039	84	6	A	099, 110	94	12	E	120
55	12	C	072	65	6	A	090	75	12	D	126, 127	85	6	A	111	95	12	E	121
56	12	A	073	66	6	A	095	76	6	A	102	86	6	B	112	96	12	E	122
57	12	A	074, 079	67	6	A	092, 093, 098	77	6	D	125	87	6	A	113	97	12	A	010, 011, 014
58	12	A	075, 076, 077	68	6	A	054, 085, 094	78	12	D	124	88	6	A	114	98	12	A	012, 013
59	12	A	078	69	12	B	038	79	6	D	123	89	6	A	115	99	12	D	

- (1): Tone number
- (2): Maximum polyphony
- (3): Range type
- (4): Corresponding General MIDI Number

- (1): Número de sonido
- (2): Polifonía máxima
- (3): Tipo de gama
- (4): Correspondiente al número de la MIDI general

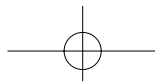

- See the illustration below for a description of range types (A through E).
- Corresponding General MIDI numbers are General MIDI numbers in effect when the tone map setting is "G".
- Vea la ilustración siguiente para una descripción de los tipos de gama (A a E).
- Los números de la MIDI general correspondiente son los números de la MIDI general que se encuentran en efecto cuando el ajuste del mapa de sonidos es "G".

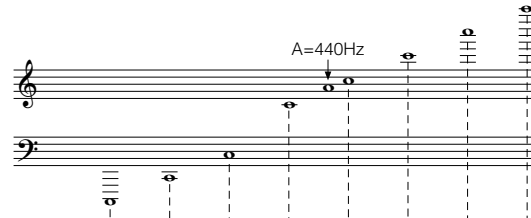

Range Type Tipo de gama	C-1	C0	A0C1	A1C2	A2C3	C4	C5	C6	C7	C8	C9	G9	
<b>A</b> (Standard type) (Tipo estándar)				[Keyboard range bar from A1C2 to C7]									
<b>B*1</b> (Low pitch instruments) (Instrumentos de altura tonal baja)			[Keyboard range bar from A0C1 to C6]										
<b>C*2</b> (“55 PICCOLO” only) (Solamente “55 PICCOLO”)				[Keyboard range bar from A2C3 to C8]									
<b>D</b> (Sound Effect) (Efecto de sonido)	No scale for tones. Sin escala para los sonidos.												
<b>E</b> (SPLIT) (División)	Scale changes in accordance with tone. La escala cambia de acuerdo con el sonido.												

.....Range of keyboard play  
.....Gama de ejecución de teclado

.....Playable range  
(When receiving MIDI data)  
.....Gama ejecutable  
(Al recibir datos MIDI)

.....Range in which same note is played in nearest octave as a result of transpose and MIDI data receive operation.  
(When receiving MIDI data)  
.....Gama en la que la misma nota se ejecuta en la octava más cercana como un resultado de la transposición y operación de recepción de datos MIDI.  
(Al recibir datos MIDI)

\*1 With received MIDI data, notes are played one octave lower.

\*1 Con los datos MIDI recibidos, las notas se ejecutan en una octava inferior.

\*2 With received MIDI data, notes are played one octave higher.

\*2 Con los datos MIDI recibidos, las notas se ejecutan en una octava más alta.

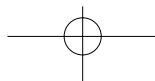

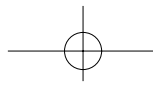

## Fingered Chord Chart

### Cuadros de acordes Fingered

This table shows the left-hand fingerings (including inverted forms) for a number of often-used chords. These fingering indications also appear on the keyboard's display. Chords marked with asterisk (\*) cannot be played in the Fingered Mode on this keyboard.

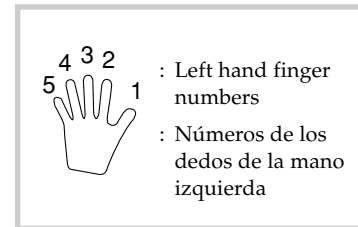

Esta tabla muestra las digitaciones (incluyendo las formas invertidas) para varios de los acordes más a menudo usados. Estas indicaciones de digitación también aparecen sobre la presentación del teclado.

En este teclado, los acordes marcados con asterisco (\*) no pueden ejecutarse en el modo de digitación.

Chord Root Type	M	m	7	m7	dim7	M7	m7-5	dim
C	[5, 3, 1]	[5, 3, 1]	[5, 3, 2, 1]	[5, 3, 2, 1]	[5, 3, 2, 1]	[5, 3, 2, 1]	[5, 3, 2, 1]	[5, 3, 2]
C# (Db)	[5, 3, 1]	[5, 3, 1]	[5, 3, 2, 1]	[5, 3, 2, 1]	[5, 3, 2, 1]	[5, 3, 2, 1]	[5, 3, 2, 1]	[5, 3, 2]
D	[5, 3, 1]	[5, 3, 1]	[5, 3, 2, 1]	[5, 3, 2, 1]	[5, 3, 2, 1]	[5, 3, 2, 1]	[5, 3, 2, 1]	[5, 3, 2]
Eb (D#)	[5, 3, 1]	[5, 3, 1]	[5, 3, 2, 1]	[5, 3, 2, 1]	[5, 3, 2, 1]	[5, 3, 2, 1]	[5, 3, 2, 1]	[5, 3, 2]
E	[5, 3, 1]	[5, 3, 1]	[5, 3, 2, 1]	[5, 3, 2, 1]	[5, 3, 2, 1]	[5, 3, 2, 1]	[5, 3, 2, 1]	[5, 3, 2]
F	[5, 3, 1]	[5, 3, 1]	[5, 3, 2, 1]	[5, 3, 2, 1]	[5, 3, 2, 1]	[5, 3, 2, 1]	[5, 3, 2, 1]	[5, 3, 2]
F# (Gb)	[5, 3, 1]	[5, 3, 1]	[5, 3, 2, 1]	[5, 3, 2, 1]	[5, 3, 2, 1]	[5, 3, 2, 1]	[5, 3, 2, 1]	[5, 3, 2]
G	[5, 3, 1]	[5, 3, 1]	[5, 3, 2, 1]	[5, 3, 2, 1]	[5, 3, 2, 1]	[5, 4, 2, 1]	[5, 3, 2, 1]	[5, 3, 2]
Ab (G#)	[5, 3, 1]	[5, 3, 1]	[5, 4, 2, 1]	[5, 4, 2, 1]	[5, 3, 2, 1]	[5, 4, 2, 1]	[5, 4, 2, 1]	[5, 3, 2]
A	[5, 3, 1]	[5, 3, 1]	[5, 4, 2, 1]	[5, 4, 2, 1]	*	[5, 4, 2, 1]	[5, 4, 2, 1]	[5, 3, 2]
Bb (A#)	[5, 3, 1]	[5, 3, 1]	[5, 4, 2, 1]	[5, 4, 2, 1]	*	[5, 4, 2, 1]	[5, 4, 2, 1]	[5, 3, 2]
B	[5, 2, 1]	[5, 2, 1]	[5, 3, 2, 1]	[5, 3, 2, 1]	*	[5, 3, 2, 1]	[5, 4, 2, 1]	[5, 3, 2]

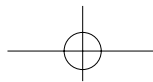

Chord Root Type	aug	sus4	7 sus4	m add9	m M7	7-5	add9
C	[5, 3, 1]	[5, 2, 1]	[5, 3, 2, 1]	[4, 3, 2, 1]	[5, 3, 2, 1]	[5, 3, 2, 1]	[4, 3, 2, 1]
C# (Db)	[5, 3, 1]	[5, 2, 1]	[5, 3, 2, 1]	[4, 3, 2, 1]	[5, 3, 2, 1]	[5, 3, 2, 1]	[4, 3, 2, 1]
D	[5, 3, 1]	[5, 2, 1]	[5, 3, 2, 1]	[4, 3, 2, 1]	[5, 3, 2, 1]	[5, 3, 2, 1]	[4, 3, 2, 1]
Eb (D#)	[5, 3, 1]	[5, 2, 1]	[5, 3, 2, 1]	[4, 3, 2, 1]	[5, 3, 2, 1]	[5, 3, 2, 1]	[4, 3, 2, 1]
E	[5, 3, 1]	[5, 2, 1]	[5, 3, 2, 1]	[4, 3, 2, 1]	[5, 3, 2, 1]	[5, 3, 2, 1]	[4, 3, 2, 1]
F	[5, 3, 1]	[5, 2, 1]	[5, 3, 2, 1]	[4, 3, 2, 1]	[5, 3, 2, 1]	[5, 3, 2, 1]	[4, 3, 2, 1]
F# (Gb)	[5, 3, 1]	[5, 2, 1]	[5, 3, 2, 1]	[4, 3, 2, 1]	[5, 3, 2, 1]	[5, 3, 2, 1]	[4, 3, 2, 1]
G	[5, 3, 1]	[5, 2, 1]	[5, 3, 2, 1]	[4, 3, 2, 1]	[5, 4, 2, 1]	[5, 3, 2, 1]	[4, 3, 2, 1]
Ab (G#)	[5, 3, 1]	[5, 2, 1]	[5, 4, 2, 1]	[4, 3, 2, 1]	[5, 4, 2, 1]	[5, 4, 2, 1]	[4, 3, 2, 1]
A	[5, 3, 1]	[5, 2, 1]	[5, 4, 2, 1]	[4, 3, 2, 1]	[5, 4, 2, 1]	[5, 4, 2, 1]	[4, 3, 2, 1]
Bb (A#)	*	[5, 2, 1]	[5, 4, 2, 1]	[4, 3, 2, 1]	[5, 4, 2, 1]	[5, 4, 2, 1]	[4, 3, 2, 1]
B	*	[5, 2, 1]	[5, 3, 2, 1]	[5, 3, 2, 1]	[5, 3, 2, 1]	[4, 3, 2, 1]	[5, 3, 2, 1]

### Percussion Instrument List

#### Lista de instrumentos de percusión

- PERCUSSION (tone 99) assigns 39 percussion sound to the keyboard as illustrated below. The sound assigned to each key are indicated above the keyboard.
- PERCUSSION (sonido 99) asigna 39 sonidos de percusión al teclado como se ilustra debajo. Los sonidos asignados a cada tecla se indican sobre el teclado.

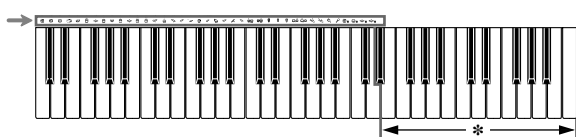

- \* No sound is produced when the keys in this range are pressed.
- \* Cuando se presionan las teclas en esta gama no se produce ningún sonido.

BASS DRUM	OPEN HI-HAT	COWBELL	LOW TIMBALE
SIDE STICK	LOW-MID TOM	CRASH CYMBAL 2	HIGH AGOGO
ACOUSTIC SNARE	HIGH-MID TOM	CLAVES	LOW AGOGO
HAND CLAP	CRASH CYMBAL 1	RIDE CYMBAL 2	CABASA
ELECTRIC SNARE	HIGH TOM	HIGH BONGO	MARACAS
LOW FLOOR TOM	RIDE CYMBAL 1	LOW BONGO	VOICE BASS DRUM
CLOSED HI-HAT	CHINESE CYMBAL	MUTE HIGH CONGA	VOICE SNARE
HIGH FLOOR TOM	RIDE BELL	OPEN HIGH CONGA	VOICE CLOSED HI-HAT
PEDAL HI-HAT	TAMBOURINE	LOW CONGA	VOICE OPEN HI-HAT
LOW TOM	SPLASH CYMBAL	HIGH TIMBALE	

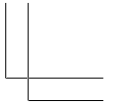
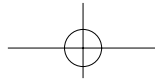
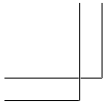

Blank musical staff

Blank musical staff

Blank musical staff

Blank musical staff

Blank musical staff

Blank musical staff

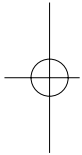

Blank musical staff

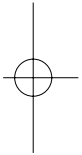

Blank musical staff

Blank musical staff

Blank musical staff

Blank musical staff

Blank musical staff

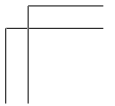
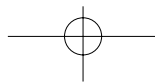
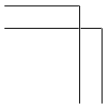

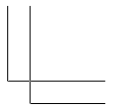
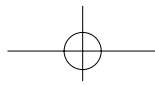
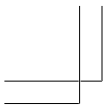

Blank lined text area

Blank lined text area

Blank lined text area

Blank lined text area

Blank lined text area

Blank lined text area

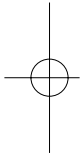

Blank lined text area

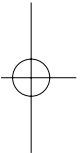

Blank lined text area

Blank lined text area

Blank lined text area

Blank lined text area

Blank lined text area

625A-E-085A

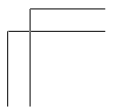
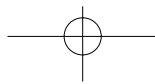
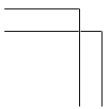

Model **CTK-481/CTK-491 MIDI Implementation Chart** Version: 1.0

Function ...	Transmitted	Recognized	Remarks
<b>Basic Channel</b> Default Changed	1 1-16	1-4, 10 1-4, 10	
<b>Mode</b> Default Messages Altered	Mode 3 X *****	Mode 3 X *****	
<b>Note Number:</b> True voice	36-96 *****	0-127 36-96 *1	*1: Depends on tone
<b>Velocity</b> Note ON Note OFF	0 9nH v = 75,100 *2 X 9nH v = 0	0 9nH v = 1-127 X 9nH v = 0,8nH v = *3	*3 = no relation
<b>After Touch</b> Key's Ch's	X X	X X	
<b>Pitch Bender</b>	X	O	
<b>Control Change</b> 1 6,38 7 10 11 64	X X X X X O	O X O X X O	Modulation Data entry Volume Pan Expression Hold1
<b>Program</b> 100,101 120 121	X X X	X X X	RPN LSB, MSB All sound off Reset all controller
	O 0-99	O 0-127 *4	

<b>Control Change</b>	6,38 7 10 11 64	X X X X O	X X X X O	X X X	X X X	Data entry Volume Pan Expression Hold1  RPN LSB, MSB All sound off Reset all controller
<b>Program Change:</b>	<b>True #</b>	O 0-99 *****	O 0-127 *4 *****			
<b>System Exclusive</b>		X				
<b>System Common</b>	: Song Pos : Song Sel : Tune	X X X				
<b>System Real Time</b>	: Clock : Commands	X X				
<b>Aux Messages</b>	: Local ON/OFF : All notes OFF : Active Sense : Reset	X X X X				
<b>Remarks</b>		*2: V(Velocity)=100 when note on data when the main volume value of this unit is 9 to 2, and V=75 when the main volume value is 1 or 0. *4: Depends on GM tone map setting (page E-32, S-32).				

Mode 1 : OMNI ON, POLY  
 Mode 2 : OMNI ON, MONO  
 Mode 3 : OMNI OFF, POLY  
 Mode 4 : OMNI OFF, MONO  
 O : Yes  
 X : No



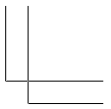
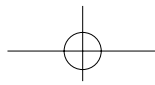
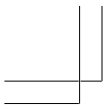

This recycle mark indicates that the packaging conforms to the environmental protection legislation in Germany.

Esta marca de reciclaje indica que el empaquetado se ajusta a la legislación de protección ambiental en Alemania.

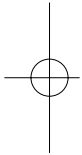

# CASIO®

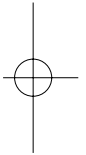

**CASIO COMPUTER CO.,LTD.**  
6-2, Hon-machi 1-chome  
Shibuya-ku, Tokyo 151-8543, Japan

MA0302-B Printed in China  
CTK481/491-ES-1

