

User's Manual

# **SE-C450**

Electronic Cash Register

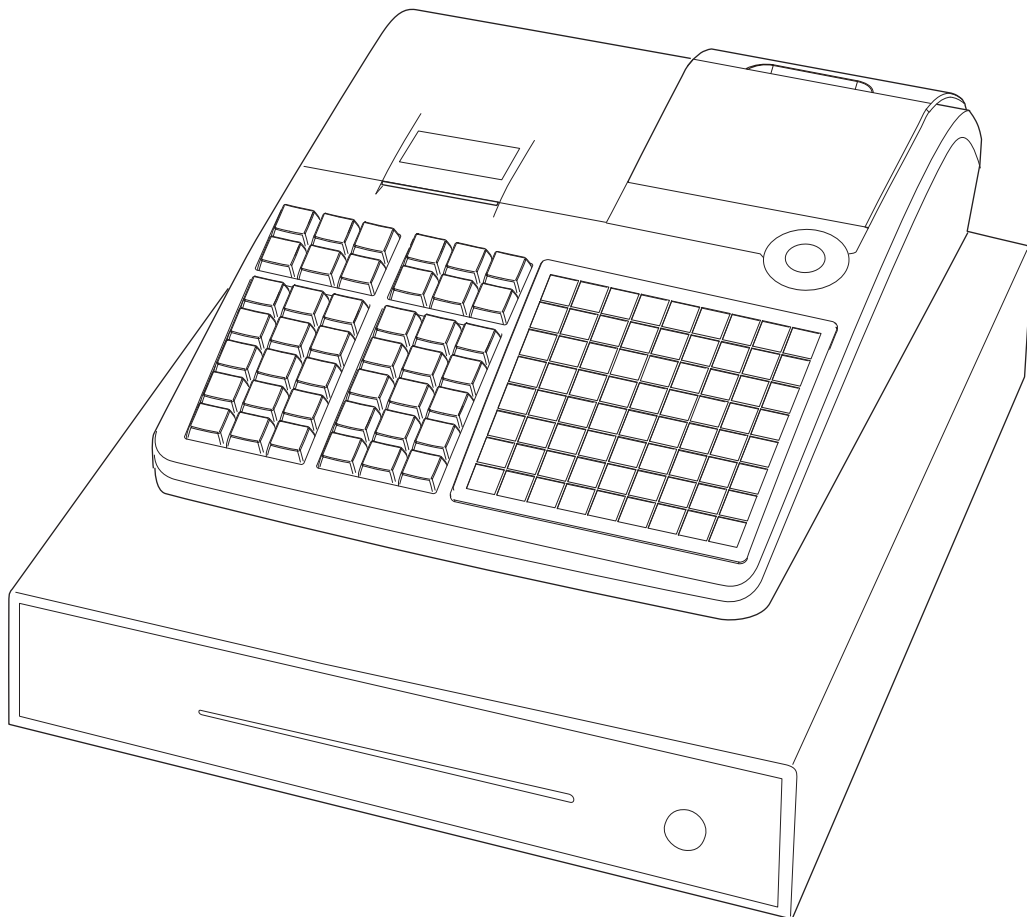

(M size drawer)

## Introduction

Thank you very much for purchasing this CASIO electronic cash register. START-UP is QUICK and EASY!

For the basic settings of your cash register, please see “Quick Start Guide”.

### Original Carton/Package

If for any reason, this product is to be returned to the store where purchased, it must be packed in the original carton/package.

### Location

Locate the Cash register on a flat, stable surface, away from heaters or areas exposed to direct sunlight, humidity or dust.

### Power Supply

Your cash register is designed to operate on standard household current (120 V, 220 V, 230 V, 240 V; 50/60 Hz). Do not overload the outlet by plugging in too many appliances.

### Cleaning

Clean the cash register exterior with a soft cloth which has been moistened with a solution of a mild neutral detergent and water, and wrung out. Be sure that the cloth is thoroughly wrung out to avoid damage to the printer. Never use paint thinner, benzene, or other volatile solvents.

The mains plug on this equipment must be used to disconnect mains power. Please ensure that the socket outlet is installed near the equipment and shall be easily accessible.

### Trademarks

SD and SDHC Logos are trademarks of SD-3C, LLC.

### Trademark





SD and SDHC Logos are trademarks of SD-3C,LLC.





<b>To use the cash register safely .....</b>	<b>E-4</b>
<b>To use the cash register's basic function .....</b>	<b>E-9</b>
Getting started.....	E-10
Getting to know your cash register .....	E-16
How to read the printouts .....	E-24
How to use your cash register .....	E-25
Before opening your store.....	E-26
Registering items in departments .....	E-27
Basic setups and registrations .....	E-31
Other registrations .....	E-40
Daily sales reports.....	E-51
<b>Advanced programmings and registrations .....</b>	<b>E-54</b>
Advanced registrations.....	E-55
Character settings .....	E-74
Advanced programmings .....	E-83
Programming functions of departments and PLUs in a lump .....	E-96
Programming functions of departments and PLUs individually .....	E-99
Printing programmed data.....	E-115
Printing various sales reports.....	E-120
Using an SD card.....	E-127
Before you consider it as a problem .....	E-129
Specifications .....	E-133

# To use the cash register safely

- Congratulations upon your selection of this CASIO product. Be sure to read the following safety precautions before using it for the first time. After reading this guide, keep it close at hand for easy reference.
- Please pay due attention to the following symbols to help you use the product safely and properly and to avoid any personal injury or damage to the product.

 <b>Danger</b>	If this symbol is ignored and the product consequently misused, it can result in serious personal injury and/or death.
 <b>Warning</b>	If this symbol is ignored and the product consequently misused, it may result in serious personal injury and/or death.
 <b>Caution</b>	If this symbol is ignored and the product consequently misused, it may result in personal injury and/or property damage.

- The figures in this manual have the following meanings.

	This symbol means be careful = a warning. The example at left is a warning about an electrical shock.
	This symbol indicates something you must not do = prohibited action. The example at left means never disassemble the product.
	This symbol indicates something you must do = an instruction. The example at left indicates you should unplug the product from the outlet. Please note that instructions that are difficult to express by a figure are indicated by  .

## **Danger**

**If liquid that leaked from a battery gets in your eye, on your skin or clothes, deal with it immediately as follows.**



1. Immediately rinse it off with lots of water.
  2. Immediately get medical treatment.
- Failing to act may result in a rash or loss of sight.

## **Warning**

### Handling the register



- Should the register malfunction, start to emit smoke or a strange odor, or otherwise behave abnormally, immediately shut down the power and unplug the AC plug from the power outlet. Continued use creates the danger of fire and electric shock. Contact CASIO service representative.



- Do not place containers of liquids near the register and do not allow any foreign matter to get into it. Should water or other foreign matter get into the register, immediately shut down the power and unplug the AC plug from the power outlet. Continued use creates the danger of short circuit, fire and electric shock. Contact CASIO service representative.



- Should you drop the register and damage it, immediately shut down the power and unplug the AC plug from the power outlet. Continued use creates the danger of short circuit, fire and electric shock.







- Attempting to repair the register yourself is extremely dangerous. Contact CASIO service representative.
- Never try to take the register apart or modify it in any way. High-voltage components inside the register create the danger of fire and electric shock. Contact CASIO service representative for all repair and maintenance.



# To use the cash register safely

## Warning

### Power plug and AC outlet

-  • Use only a proper AC electric outlet. Use of an outlet with a different voltage from the rating creates the danger of malfunction, fire, and electric shock. Overloading an electric outlet creates the danger of overheating and fire.
-  • Make sure the power plug is inserted as far as it will go. Loose plugs create the danger of electric shock, overheating, and fire.
- Do not use the register if the plug is damaged. Never connect to a power outlet that is loose.
-  • Use a dry cloth to periodically wipe off any dust built up on the prongs of the plug. Humidity can cause poor insulation and create the danger of electric shock and fire if dust stays on the prongs.
-  • Do not allow the power cord or plug to become damaged, and never try to modify them in any way. Continued use of a damaged power cord can cause deterioration of the insulation, exposure of internal wiring, and short circuit, which creates the danger of electric shock and fire.
- Contact CASIO service representative whenever the power cord or plug requires repair or maintenance.

## Caution

-  • Do not place the register on an unstable or uneven surface. Doing so can cause the register - especially when the drawer is open - to fall, creating the danger of malfunction, fire, and electric shock.

### Do not place the register in the following areas.

-  • Areas where the register will be subject to large amounts of humidity or dust, or directly exposed to hot or cold air.
- Areas exposed to direct sunlight, in a close motor vehicle, or any other area subject to very high temperatures.

The above conditions can cause malfunction, which creates the danger of fire.

-  • Do not overlay bend the power cord, do not allow it to be caught between desks or other furniture, and never place heavy objects on top of the power cord. Doing so can cause short circuit or breaking of the power cord, creating the danger of fire and electric shock.

-  • Be sure to grasp the plug when unplugging the power cord from the wall outlet. Pulling on the cord can damage it, break the wiring, or cause short, creating the danger of fire and electric shock.

-  • Never touch the plug while your hands are wet. Doing so creates the danger of electric shock. Pulling on the cord can damage it, break the wiring, or cause short, creating the danger of fire and electric shock.

-  • At least once a year, unplug the power plug and use a dry cloth or vacuum cleaner to clear dust from the area around the prongs of the power plug.

Never use detergent to clean the power cord, especially power plug.

-  • Keep small parts out of the reach of small children to make sure it is not swallowed accidentally.

## To use the cash register's basic function

### **Caution**

#### **Only use the specified batteries.**



- Do not disassemble, modify or short-circuit them.
- Do not put them in fire or water or heat them.
- Do not mix new and old batteries or different types of batteries.
- Orient the terminals +- correctly.
- Remove the batteries if the system will not be used for a long time.
- After batteries are spent, dispose of them as per local regulations.
- Do not try to recharge dry cell batteries.

#### **Disposing of batteries:**



- Make sure that you dispose of used batteries in accordance with the rules and regulations in your local area.

# To use the cash register's basic function

## ■ When the cash drawer does not open!

In case of power failure or the machine is in malfunction, the cash drawer does not open automatically. Even in these cases, you can open the cash drawer by pulling drawer release lever (see below).

**Important:** The drawer will not open, if it is locked with a drawer lock key.

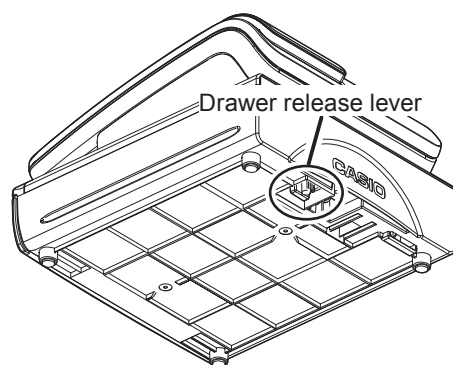

# To use the cash register's basic function



Manufacturer: CASIO COMPUTER CO., LTD.  
6-2, Hon-machi 1-chome, Shibuya-ku, Tokyo 151-8543, Japan  
Responsible within the European Union: CASIO EUROPE GmbH  
CASIO-Platz 1, 22848 Norderstedt, Germany

Please keep all information for future reference.  
The declaration of conformity may be consulted at <http://world.casio.com/>



This mark applies in EU countries only.

This product is also designed for IT power distribution system with phase-to-phase voltage 230 V.

Laite on liitettävä suojamaadoituskostkettimilla vaurstettuun pistorasiaan  
Apparatet må tilkoples jordet stikkontakt  
Apparaten skall anslutas till jordat nätuttag.

The main plug on this equipment must be used to disconnect mains power.  
Please ensure that the socket outlet is installed near the equipment and shall be easily accessible.

## WARNING

THIS IS A CLASS A PRODUCT. IN A DOMESTIC ENVIRONMENT THIS PRODUCT MAY CAUSE RADIO INTERFERENCE IN WHICH CASE THE USER MAY BE REQUIRED TO TAKE ADEQUATE MEASURES.

## GUIDELINES LAID DOWN BY FCC RULES FOR USE OF THE UNIT IN THE U.S.A. (Not applicable to other areas)

**WARNING:** This equipment has been tested and found to comply with the limits for a Class A digital device, pursuant to Part 15 of the FCC Rules. These limits are designed to provide reasonable protection against harmful interference when the equipment is operated in a commercial environment. This equipment generates, uses, and can radiate radio frequency energy and, if not installed and used in accordance with the instruction manual, may cause harmful interference to radio communications. Operation of this equipment in a residential area is likely to cause harmful interference in which case the user will be required to correct the interference at his own expense.

**FCC WARNING:** Changes or modifications not expressly approved by the party responsible for compliance could void the user's authority to operate the equipment.

# To use the cash register's basic function

<b>Getting started</b> .....	<b>E-10</b>
Loading memory protection batteries.....	E-10
Installing paper roll .....	E-11
Setting date, time, and tax table .....	E-13
Setting paper roll as journal records.....	E-14
To set Australian GST .....	E-15
<b>Getting to know your cash register</b> .....	<b>E-16</b>
General guide.....	E-16
To adjust the main display .....	E-17
To set the customer display .....	E-17
To set the menu sheet .....	E-18
Display .....	E-19
Keyboard .....	E-20
<b>How to read the printouts</b> .....	<b>E-24</b>
<b>How to use your cash register</b> .....	<b>E-25</b>
<b>Before opening your store</b> .....	<b>E-26</b>
Checking the time and date.....	E-26
Preparing bills and coins for change .....	E-26
<b>Registering items in departments</b> .....	<b>E-27</b>
<b>Basic setups and registrations</b> .....	<b>E-31</b>
To program basic settings.....	E-31
Programming departments .....	E-33
Registering departments' preset data.....	E-34
Programming PLUs .....	E-35
Registering PLUs' preset data.....	E-36
<b>Other registrations</b> .....	<b>E-40</b>
Discount .....	E-40
Reduction .....	E-41
Registering various payment methods .....	E-42
Registering returned goods .....	E-44
Registrations without transactions .....	E-46
Corrections .....	E-47
<b>Daily sales reports</b> .....	<b>E-51</b>
Print out of daily sales report.....	E-52

# To use the cash register's basic function

## Getting started

This chapter shows how to setup the cash register and get it ready to operate.

### Loading memory protection batteries

**Important:** These batteries protect information stored in your cash register's memory when there is a power failure or when you unplug the cash register. Be sure to install these batteries first.

**1** Remove the printer cover.



**2** Remove the battery compartment cover.

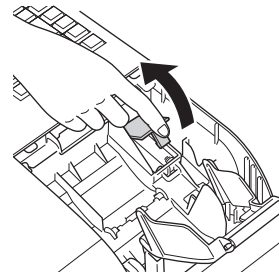

**3** Note the (+) and (-) markings in the battery compartment. Load a set of two new "AA" type manganese batteries so that their plus (+) and minus (-) ends are facing as indicated by the markings.

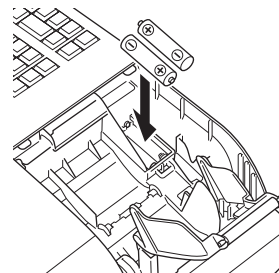

**4** Replace the battery compartment cover and the printer cover.

### Warning

- No battery is included in the accessories.
- Never try to recharge the batteries.
- Do not expose batteries to direct heat, let them become shorted or try to take them apart.
- Keep batteries out of the reach of small children. If your child should swallow a battery, consult a physician immediately.
- There is a risk of explosion if the batteries are replaced with improper type.
- Dispose of used batteries according to the instructions.

# To use the cash register's basic function

## Installing paper roll

You can use the paper roll as receipts or journals (for business records). By default, your cash register is set as receipt printing. Please see page E-14 if you wish to use the paper roll for journals.

The setting methods of the paper roll differ by the usage. Please follow the instructions below in accordance with your usage of the paper roll.

### **Caution (in handling the thermal paper)**

- Never touch the printer head and the platen.
- Unpack the thermal paper just before your use.
- Avoid heat and direct sunlight.
- Avoid dusty and humid places for storage.
- Do not scratch the paper.
- Do not keep the printed paper under the following circumstances:
  - High humidity and temperature/direct sunlight/contact with glue, thinner or a rubber eraser.

### **■ To install receipt paper**

**1** Remove the printer cover.

**2** Open the platen arm by lifting it up.

**3** Ensuring the paper is being fed from the bottom of the roll, lower the roll into the space behind the printer.

**4** Put the leading end of the paper over the printer.

**5** Close the platen arm slowly until it locks securely.

**6** Replace the printer cover, passing the leading end of the paper through the cutter slot. Tear off the excess paper.

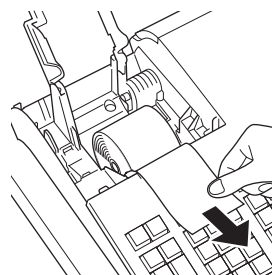
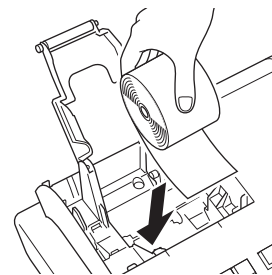
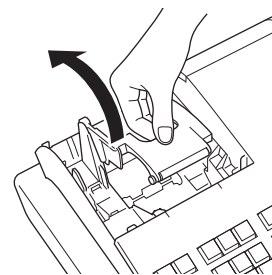

# To use the cash register's basic function

## ■ To install journal paper

**1** Repeat steps 1 through 5 of "To install receipt paper".

**2** Using  key, feed the paper about 20 cm

**3** Remove the paper guide of the take-up reel.

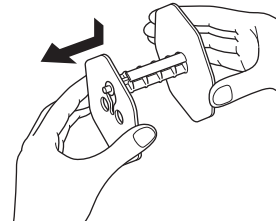

**4** Slide the leading end of the paper into the groove on the spindle of the take-up reel and wind it onto the reel two or three turns.

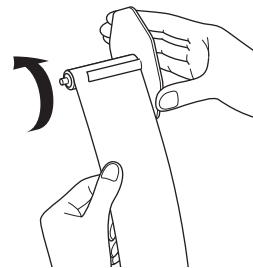

**5** Replace the paper guide of the take-up reel.

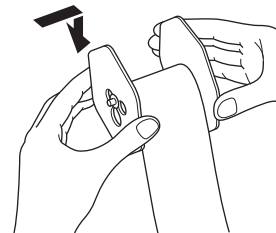

**6** Place the take-up reel into place behind the printer, above the roll paper.

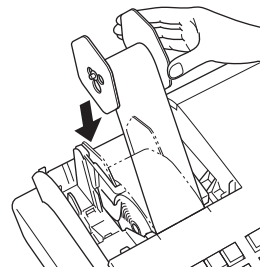

**7** Press the  key to take up any slack in the paper.

**8** Replace the printer cover.



# To use the cash register's basic function

## Setting date, time, and tax table

### 1 Plug in the power socket into a wall outlet.

Be sure to check the rating plate on the side of the cash register to make sure that its voltage matches that of the power supply in your area.

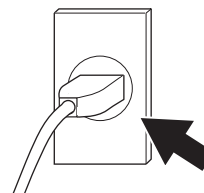

### 2 As soon as the power socket is plugged in, the display shows the language selection display. Choose language and country by using or keys then press key.

```
PLEASE SELECT LANGUAGE.
<CA/AMT TEND>           :ENTER

English(Australia)
English(Czech)
English(Malaysia)
English(New Zealand)
English(Singapore)
```

### 3 Display changes to date and time setting display. Moving the input area (reversed area) by or keys, input date, month, year and time from ten key pad. Input the time by 24 - hour system. For example, 1356 for 1:56 pm. After then press key. For Australian model, the setting is completed by this step To set Australian GST, please see the next section.

```
PLEASE INPUT DATE & TIME.
<CA/AMT TEND>           :ENTER
<SUBTOTAL>             :RETURN

DATE                    [DD]
MONTH                   [MM]
YEAR                    [YYYY]
TIME(24-hour)          [HHMM]
```

### 4 Display then changes to tax table setting screen. Using ten key pad, input tax rates. You can set four kinds of tax rates.

```
PLEASE INPUT TAX RATE.
<CA/AMT TEND>           :ENTER
<SUBTOTAL>             :RETURN

RATE
TABLE1                  [3.000]
TABLE2                  [5.250]
TABLE3                  [8.500]
TABLE4                  [15.000]
```



### 5 Press key.

Now your cash register is ready to operate basic registrations.

# To use the cash register's basic function

## Setting paper roll as journal records

By default, the printer of your cash register issues receipts. If you wish to use the printouts for sales journals, please follow the procedures described below.

- 1 Turn the Mode switch to PGM position and select [Paper Roll Setting] then press  key.  
[Paper Roll Setting] is not shown on the first screen.  
Keep pressing  key until it appears on the screen.

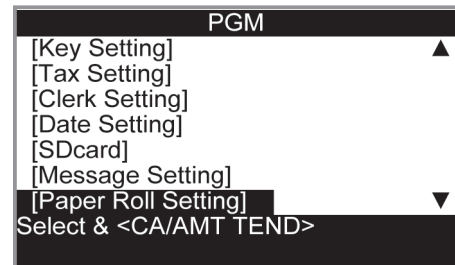

- 2 On the Paper Roll Setting screen, select "Journal" and press  key.  
Now your cash register is set to print sales journals.

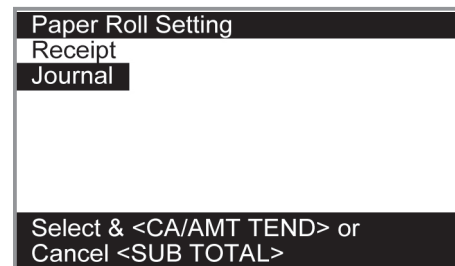

# To use the cash register's basic function

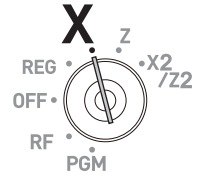

## To set Australian GST

The following operation programs the cash register Australian GST (the Goods and Service Tax) setting. It is not necessary to program this setting for other countries than Australia.



Step	Operation
------	-----------

**1** Turn the Mode switch to X position.

**2** Enter the setting code "01012001" and press  key. (Pressing  key again cancels the setting.)

**0 1 0 1 2 0 0 1** 

**3** Press  key. Now your cash register complies with Australian GST. The printer prints "GST system was changed".



### By setting Australian GST system;

- Australian special rounding system is programmed.
- Tax symbol (\*) will be printed on receipts or journals.
- Taxable amount will not be printed.
- "GST INCLUDED" will be printed on receipts or journals for tax 1.
- "TAXABLE AMT" will be printed on receipts or journals for taxable 1 amount.
- "\$" will be printed as the monetary symbol.
- "MOF" will be printed on receipts.
- Ten percent tax rate, add-in tax, and rounding off are programmed in tax table 1. No setting in other tax tables.
- Other taxable amount and tax amount than TX1 (tax 1) and TA1 (taxable 1) will not be printed on sales reports.
- The lowest significant digit is restricted to 0 or 5 for cash sales, received on account, paid out, and money declaration amounts.
- Total line is printed even in direct (cash) sale.

# To use the cash register's basic function

## Getting to know your cash register

### General guide

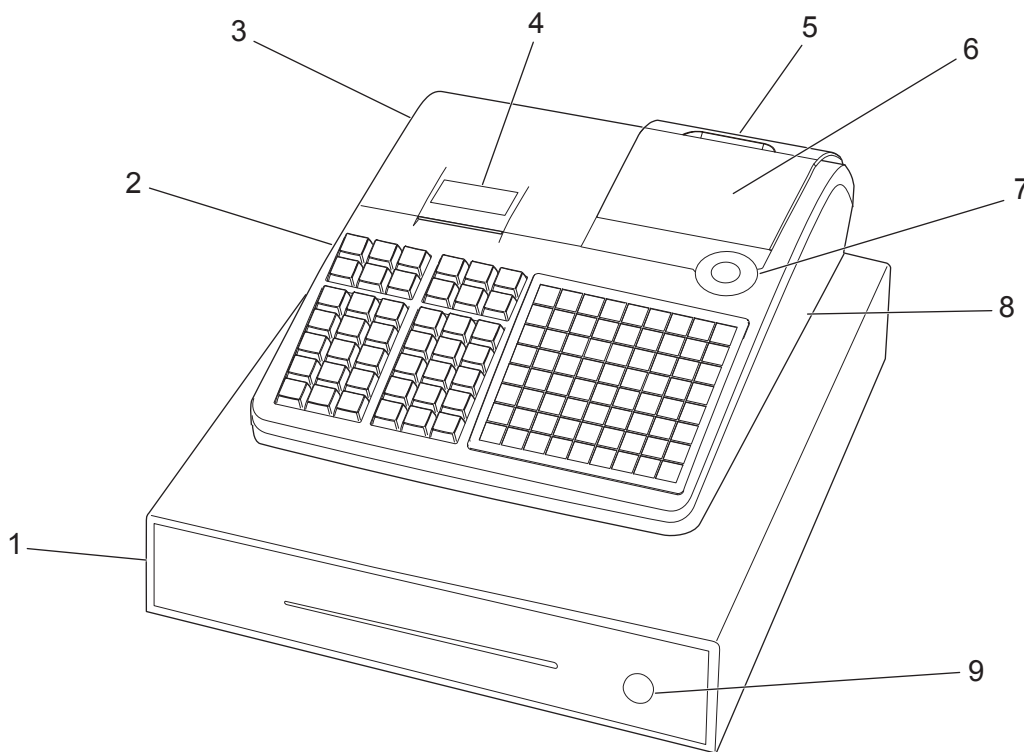

- 1 Drawer
- 2 SD card slot cover
- 3 Printer cover
- 4 Printer
- 5 Customer display

- 6 Main display
- 7 Mode switch
- 8 Com port connector cover
- 9 Drawer lock

### Mode switch

Use the mode keys to change the position of the mode switch and select the mode you want to use.

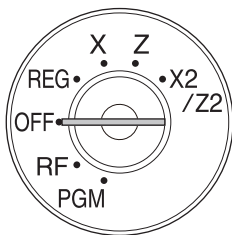

#### **PGM (Programming)**

This position is for setting your cash register to suit the needs of your store.

#### **RF (Refund)**

Use this position to correct registered items.

#### **OFF**

The cash register turns off in this position.

#### **REG (Register)**

This position is for normal transactions.

#### **X (Read)**

This is the position used for issuing daily sales totals report without clearing the data.

#### **Z (Reset)**

This position is for issuing reports of daily totals with clearing the accumulated totals.

#### **X2/Z2 (Periodic sale read/reset)**

Used to obtain periodic sales reports without resetting total data.

# To use the cash register's basic function

## Mode keys

There are two types of mode keys: the program key (marked "PGM") and the operator key (marked "OP"). The program key can be used to set the mode switch to any position, while the operator key can select the REG and OFF position.

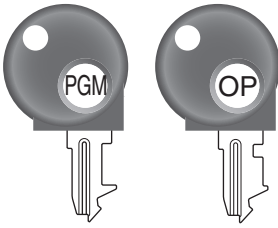

	PGM	RF	OFF	REG	X	Z	X2/Z2
OP key	-	-	○	○	-	-	-
PGM key	○	○	○	○	○	○	○

## Drawer

The drawer opens automatically whenever you finalize a registration and whenever you issue a read or reset report. The drawer will not open if it is locked with the drawer key.

## Drawer key

Use this key to lock and unlock the drawer.

## Magnetic plate

Use this plate for tacking the notes received from customer.

## To adjust the main display

- 1 Put in fingers in the ditch of the main display and tilt it to the angle you can see clearly.

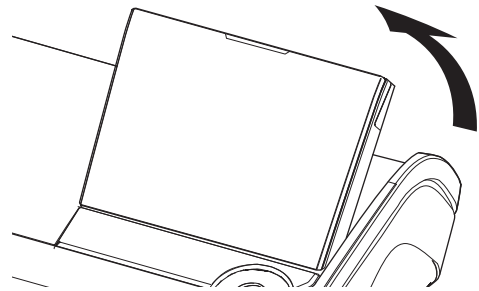

## To set the customer display

- 1 Lift the customer display until it stops.

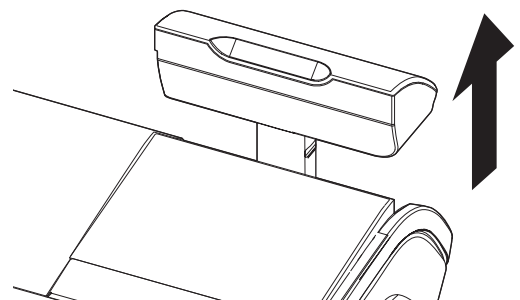

- 2 Rotate the display so that customers can see it.

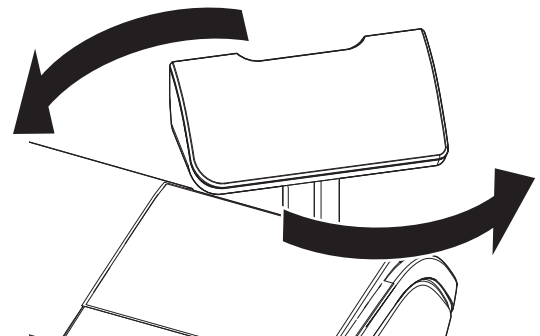

# To use the cash register's basic function

## To set the menu sheet

**1** Pull the sheet cover up and remove the old menu sheet.

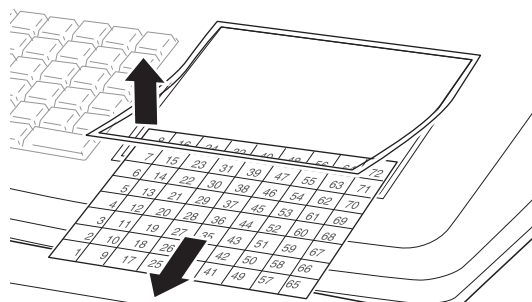

**2** Put the new menu sheet and replace the sheet cover.

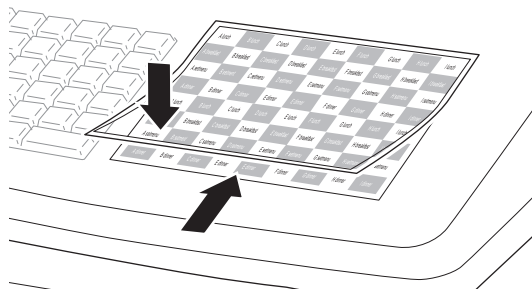

# To use the cash register's basic function

## Display

### ■ Main display

During a registration

CLERK001	REG	000011	1
1	PLU001	·1.00	2
3	DEPT001	·6.00	
<b>SUBTOTAL</b>		<b>·7.00</b>	3
QT	4	6.00	4

After finalization

CLERK001	REG	000011	
1	PLU001	·1.00	
3	DEPT001	·6.00	
	TL	·7.00	5
	CASH	·10.00	6
	CG	·3.00	7
<b>CG</b>		<b>·3.00</b>	8
QT	4	·10.00	9

- |   |                                  |
|---|----------------------------------|
| 1 Clerk Number or name/Mode/Consecutive No. | 5 Total amount                   |
| 2 Registered item Quantity/Category/Price   | 6 Paid by/Tendered amount        |
| 3 Subtotal amount                           | 7 Change                         |
| 4 Total quantity/Price of the last item     | 8 Change                         |
|   | 9 Total quantity/Tendered amount |









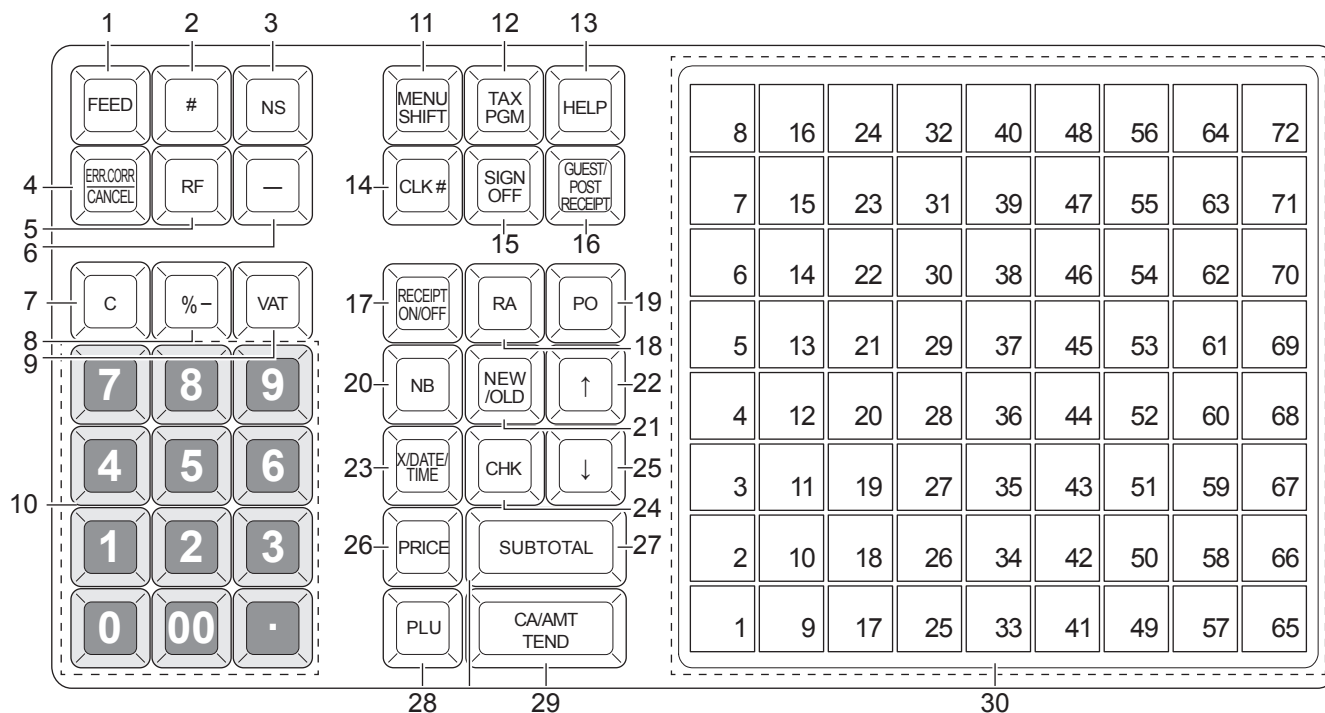







### ■ Customer display



# To use the cash register's basic function















## Keyboard



- 1  Hold this key down to feed paper from the printer.
- 2  Non-add key: Use this key to print reference number (to identify a personal check, credit card, etc.) during a transaction. Use this function after a numeral entry.
- 3  Use this key to open the drawer without registering anything.
- 4  Use this key to correct registration errors or to cancel a transactions.
- 5  Use this key to input refunded amounts or to void preceding inputs.
- 6  Use this key to input reduction values.
- 7  Use this key to clear an entry that has not yet been registered.
- 8  Use this key to register discounts.
- 9  Use this key for printing breakdown of VAT.
- 10  Use these keys to input numbers.
- 11  Use this key to shift flat PLU keys to 1st to 3rd menu.
- 12  Use this key to set the tax status and tax table.
- 13  Use this key to look up the procedures to set date/time, tax table etc.
- 14  Use this key to input a clerk number.
- 15  Use this key to sign clerk off the register.
- 16  Use this key to issue guest or post-finalization receipts..
- 17  Use this key to switch issuing receipts on and off.



# To use the cash register's basic function

- 18  Use this key following a numeric entry to register money received for non-sale transactions.
- 19  Use this key following a numeric entry to register money paid out from the drawer.
- 20  Use this key for adding the latest registered total amount to the previous balance to obtain a new balance.
- 21  Use this key in a check tracking system to input check numbers in order to open new checks and to reopen existing checks.
- 22  Use this key to move the cursor on the display up.
- 23  Use this key to input a quantity for a multiplication. Between transactions, pressing this key displays the current time and date.
- 24  Use this key to register a check tendering.
- 25  Use this key to move the cursor on the display down.
- 26  Use this key to register unit prices for a PLU (subdepartment).
- 27  Use this key to display and print the current subtotal (including tax) amount.
- 28  Use this key to input PLU (subdepartment) numbers.
- 29  Use this key to register a cash sale.
- 30  to  Use these keys to register items to departments.

# To use the cash register's basic function

## ■ Allocatable functions

You can allocate the following functions on the keyboard to suit your purpose of register. The keys shown in < > in this manual are function allocated keys. To set these functions on the keyboard, please see page E-113.

### <Add check>

Use this key in a check tracking system to combine the details of more than one check into a single check.

### <Addition (plus)>

Use this key for registering surcharge.

### <Age verification>

Use this key to enter the birth date of the customer for age verification.

### <Arrangement>

Use this key to activate an arrangement program programmed in the arrangement file. Any operation that can be performed from the keyboard, as well as mode, can be programmed in an arrangement program, and can be performed merely by pressing this key. In addition, one numeric entry can be included in an arrangement program. In this case, input the number and press this key.

The mode control function of this key can be programmed for all modes except for the OFF and PGM mode.

### <Cash amount tendered>

Use this key to register a cash sale.

### <Charge>

Use this key to register a charge sale.

### <Check tendered>

Use this key to register a check tender.

### <Clerk number>

Use this key to sign clerk on and off the register.

### <Coupon>

Use this key to register coupons.

### <Credit>

Use this key to register a credit sale.

### <Currency exchange>

Use this key for calculating subtotal amounts or paying amount due in foreign currency.

### <Customer number>

Use this key to register the number of customers.

### <Department>

Use these keys to register items to departments.

### <Department no. / Department shift>

Department no.: Use this key to input department numbers. Department shift: Use this key to shift the department key number.

### <Discount>

Use this key to register discounts.

### <Error correct / Cancel>

Use this key to correct registration errors and to cancel registration of entire transactions.

### <Flat-PLU>

Use this key to register items to flat-PLUs.

### <Help>

Use this key to look up the procedures to set date/time, tax table etc.

### <Manual tax>

Use this key to register a tax amount.

### <Menu shift>

Use this key to shift flat PLU keys to 1st ~ 3rd menu.

### <Merchandise subtotal>

Use this key to obtain subtotal excluding the add-on tax amount and the previous balance.

### <Multiplication>

Use this key to input a quantity for a multiplication operation. Between transactions, this key displays the current time and date.

### <Multiplication / For>

Use this key to input a quantity for a multiplication operation and registration of split sales of packaged items. Between transactions, this key displays the current time and date.

### <New balance>

Use this key for adding the latest registered total amount to the previous balance to obtain a new balance.

### <New check>

Use this key in a check tracking system to input a new check number in order to open a new check under that number.

### <New / Old check>

Use this key in a check tracking system to input check numbers in order to open new checks and to reopen existing checks. When the clerk inputs a check number, the register checks to see if that number already exists in the check tracking memory. If there is no matching number in the memory, a new check is opened under the input number. If the check number input matches a number already stored in the memory, that check is reopened for further registration or finalization.

### <No sale>

Use this key to open the drawer between transaction.

# To use the cash register's basic function

## <Non-add>

Use this key to print reference numbers (personal check number, card number, etc.)

## <Non-add / No sale>

Non-add: Use this key to print reference number (to identify a personal check, credit card, etc.) during a transaction, use this key after some numerical entries.

No sale: Use this key to open the drawer without registering anything.

## <Old check>

Use this key in a check tracking system to input the number of an existing check (previously created by the New check key) whose details are stored in the check tracking memory. Existing checks are reopened to perform further registration or to finalize them.

## <Open>

Use this key to temporarily release a limitation on the number of digits that can be input for a unit price.

## <Paid out>

Use this key following a numeric entry to register money paid out from the drawer.

Use this key to convert the main currency to the sub currency (the euro/the local money), when registering a subtotal amount. This key is also used for specifying sub currency while entering an amount of payment or declaration in drawers.

## <PLU/Subdepartment>

Use this key to input PLU (subdepartment) numbers.

## <Premium>

Use this key to register premiums.

## <Price>

Use this key to register unit prices for PLU (subdepartment).

## <Post receipt>

Use this key to produce a guest or post-finalization receipt.

## <Receipt on/off>

Use this key twice to change the status "receipt issue" or "no receipt."

## <Received on account>

Use this key following a numeric entry to register money received for non-sale transactions.

## <Reduction (minus)>

Use this key to input values for reduction.

## <Refund>

Use this key to input refund amounts and void certain entries.

## <Sign off>

Use this key to sign clerk off the register.

## <Subtotal>

Use this key to display and print the current subtotal (includes add-on tax) amount.

## <Tax shift>

Use this key to change the Taxable status of the next item.

## <Tax program>

Use this key to program tax status and tax table easily.

## <Text recall (CHAR)>

Use this key to print preset characters.

## <Tip>

Use this key to register tips.

## <VAT>

Use this key to print a VAT breakdown.

# To use the cash register's basic function

## How to read the printouts

- The journal/receipts are records of all transactions and operations.
- The contents printed on receipts and journal are almost identical.
- You can choose the journal skip function.  
If the journal skip function is selected, the cash register will print the total amount of each transaction, and the details of premium, discount and reduction operations only, without printing department and PLU item registrations on the journal.
- The following items can be skipped on receipts and journal.
  - Taxable status
  - Taxable amount
  - Item counter

### Receipt Sample

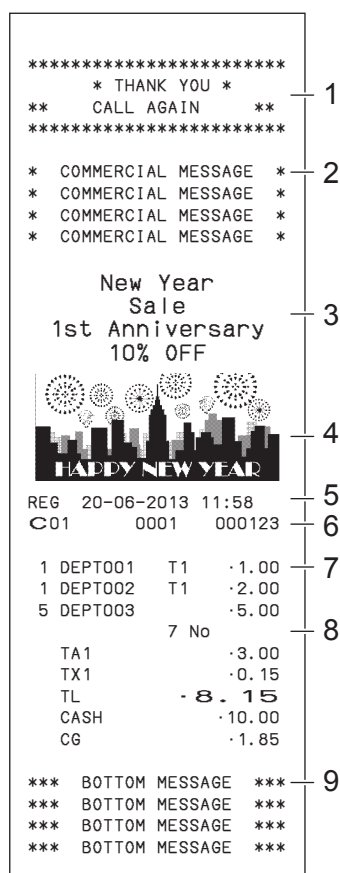

### Journal Sample (with items)

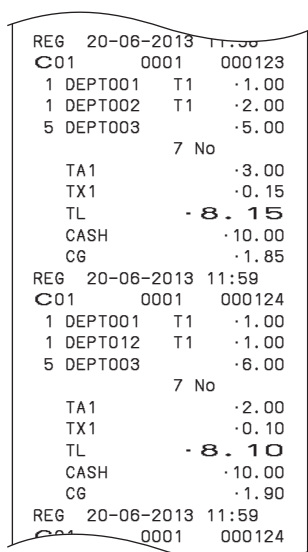

### Journal Sample (by half height character)

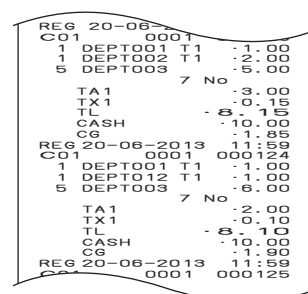

- |                      |                                     |
|----------------------|-------------------------------------|
| 1 Logo message       | 6 Clerk/Machine No./Consecutive No. |
| 2 Commercial message | 7 Q'ty/Item                         |
| 3 Preset message *   | 8 Item counter                      |
| 4 Preset graphic *   | 9 Bottom message                    |
| 5 Mode/Date/Time     |                                     |

\* You can choose to print preset message and graphic at the top or the bottom of the receipt. (See page E-32)

In the operation examples in this manual, the printout samples are what would be printed if the roll paper is being used for receipts.

# To use the cash register's basic function

## How to use your cash register

The following describes the general procedure you should use in order to get the most out of your cash register.

### Before opening your store

---



- Plugged in? (page E-13)
- Enough paper roll? (pages E-11 and E-12)
- Date and time are correct? (pages E-26 and E-31)
- Enough small change in the drawer? (page E-26)



### While the store is open

---



- Registrations (page E-27)
- Issuing latest total sales report if needed. (page E-51)



### After closing the store

---



- Issuing day's total sales report. (page E-51)
- Withdraw the money from the drawer.  
After you withdraw all the money from the drawer, we recommend that you leave the drawer open when you leave your store. (page E-26)
- Turn the Mode switch to OFF. (page E-16)

# To use the cash register's basic function

## Before opening your store

### Checking the time and date

You can check the time or date on the display whenever there is no registration being made.

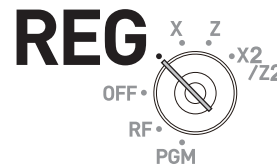

Step	Operation	Display
1 Press  key to show the date and time on the display.		
2 Press  key to clear the date/time display.		

### Preparing bills and coins for change

To prepare coins and bills for change, you can open the drawer by pressing key. This operation must be performed when registrations are not being made.



**NOTE** Opening the drawer by key does not perform any calculation in the register. If you wish to obtain a report that tells you the total amount in drawer, use key instead of key. See page E-46.

Step	Operation	Printout
1 Press . The cash drawer opens.		
2 Prepare coins and bills in the drawer.		

# To use the cash register's basic function

## Registering items in departments

The following examples show how you can use the department keys in various types of registrations.

Departments are used for categorizing items for example, department 01 for vegetables, department 02 for fruits, and department 03 for canned foods etc.



### ■ Single item sale

#### Sample Operation

Item	Unit Price	•1.00	One •1.00 Dept. 01 item is sold and the customer paid the same amount as the total amount.
	Quantity	1	
	Dept.	01	
Payment	Cash	•1.00	

Step	Operation	Printout						
<b>1</b> Enter the unit price.	<b>1 00</b>	<table border="1"> <tr> <td>1 DEPT001</td> <td>• 1.00</td> </tr> <tr> <td>TL</td> <td>- 1.00</td> </tr> <tr> <td>CASH</td> <td>• 1.00</td> </tr> </table>	1 DEPT001	• 1.00	TL	- 1.00	CASH	• 1.00
1 DEPT001	• 1.00							
TL	- 1.00							
CASH	• 1.00							
<b>2</b> Press corresponding department key.	<b>1</b>							
<b>3</b> Press <b>CA/AMT/TEND</b> key.	<b>CA/AMT/TEND</b>							

#### Further operations:

• For simpler operation of single item sales, see page E-57

### ■ Single item sales with change calculation

#### Sample Operation

Item	Unit Price	•12.34	One item is sold and the customer paid more than the total amount.
	Quantity	1	
	Dept.	01	
Payment	Cash	•20.00	

Step	Operation	Printout								
<b>1</b> Enter the unit price.	<b>1 2 3 4</b>	<table border="1"> <tr> <td>1 DEPT001</td> <td>• 12.34</td> </tr> <tr> <td>TL</td> <td>- 12.34</td> </tr> <tr> <td>CASH</td> <td>• 20.00</td> </tr> <tr> <td>CG</td> <td>• 7.66</td> </tr> </table>	1 DEPT001	• 12.34	TL	- 12.34	CASH	• 20.00	CG	• 7.66
1 DEPT001	• 12.34									
TL	- 12.34									
CASH	• 20.00									
CG	• 7.66									
<b>2</b> Press corresponding department key.	<b>1</b>									
<b>3</b> Press <b>SUB/TOTAL</b> key.	<b>SUB/TOTAL</b>									
<b>4</b> Enter the tendered amount then press <b>CA/AMT/TEND</b> key. The display shows the change to be paid.	<b>2 0 00</b> <b>CA/AMT/TEND</b>									

# To use the cash register's basic function

## Repeat registration

### Sample Operation

Item	Unit Price	•1.50	Same priced multiple items are sold.
	Quantity	3	
	Dept.	1	
Payment	Cash	•10.00	

Step	Operation	Printout												
<b>1</b> Enter the unit price.	<b>1 5 0</b>	<table border="1"> <tr><td>1 DEPT001</td><td>· 1.50</td></tr> <tr><td>1 DEPT001</td><td>· 1.50</td></tr> <tr><td>1 DEPT001</td><td>· 1.50</td></tr> <tr><td>TL</td><td>- 4.50</td></tr> <tr><td>CASH</td><td>· 10.00</td></tr> <tr><td>CG</td><td>· 5.50</td></tr> </table>	1 DEPT001	· 1.50	1 DEPT001	· 1.50	1 DEPT001	· 1.50	TL	- 4.50	CASH	· 10.00	CG	· 5.50
1 DEPT001	· 1.50													
1 DEPT001	· 1.50													
1 DEPT001	· 1.50													
TL	- 4.50													
CASH	· 10.00													
CG	· 5.50													
<b>2</b> Press corresponding department key repeatedly for the purchased quantity.	<b>1 1 1</b>													
<b>3</b> Press <b>SUB TOTAL</b> key.	<b>SUB TOTAL</b>													
<b>4</b> Enter the tendered amount then press <b>CA / AMT / TEND</b> key. The display shows the change to be paid.	<b>1 0 00</b> <b>CA / AMT / TEND</b>													

## Multiple items registration using multiplication key

### Sample Operation

Item	Unit Price	•1.00	Twelve pieces of •1.00 item are sold and the customer paid more than the total amount.
	Quantity	12	
	Dept.	1	
Payment	Cash	•20.00	

Step	Operation	Printout								
<b>1</b> Enter the the quantity then press <b>X / DATE TIME</b> key.	<b>1 2</b> <b>X / DATE TIME</b>	<table border="1"> <tr><td>12 DEPT001</td><td>· 12.00</td></tr> <tr><td>TL</td><td>- 12.00</td></tr> <tr><td>CASH</td><td>· 20.00</td></tr> <tr><td>CG</td><td>· 8.00</td></tr> </table>	12 DEPT001	· 12.00	TL	- 12.00	CASH	· 20.00	CG	· 8.00
12 DEPT001	· 12.00									
TL	- 12.00									
CASH	· 20.00									
CG	· 8.00									
<b>2</b> Enter the unit price and press corresponding department key.	<b>1 00</b> <b>1</b>									
<b>3</b> Press <b>SUB TOTAL</b> key.	<b>SUB TOTAL</b>									
<b>4</b> Enter the tendered amount then press <b>CA / AMT / TEND</b> key. The display shows the change to be paid.	<b>2 0 00</b> <b>CA / AMT / TEND</b>									



# To use the cash register's basic function

## ■ Split sales of packaged items

### Sample Operation

Item	Unit Price	4 for •10.00	Three pieces of an item that's price is •10.00 for four pieces are sold.
	Quantity	3	
	Dept.	1	
Payment	Cash	•10.00	

Step	Operation	Printout
1 Enter purchased quantity then press  key.	<b>3</b>	<div style="border: 1px solid black; padding: 5px;">                     3 DEPT001           •7.50                      TL                   - 7.50                      CASH               •10.00                      CG                   •2.50                 </div>
2 Enter the quantity of one set and press  key.	<b>4</b>	
3 Enter the package price and press corresponding department and  keys.	<b>1 0 00</b>	
4 Enter the tendered amount and press  key.	<b>1 0 00</b>	

**NOTE** You need to program key for using split sale of packaged items. See page E-113.

## ■ Department shift

If a key is allocated as <Dept. no./Dept. shift>, you can register items in Dept. 73 through 144. To allocate <Department no. / Department shift> function to a key, please see page E-113.

### Sample Operation

Item	Unit Price	•1.00	Department 73 is assigned by using <Dept. no./ Dept. shift> key.
	Quantity	1	
	Dept.	73	
Payment	Cash	•1.00	

Step	Operation	Printout
1 Press the key on which <Department no. / Department shift> key function is allocated.  "SHIFT/No" will be shown at the bottom of the display.	<Department no. / Department shift>	<div style="border: 1px solid black; padding: 5px;">                     1 DEPT073           •1.00                      TL                   - 1.00                      CASH               •1.00                 </div>
2 Enter the unit price and press corresponding department key. Then press  key. The item is registered in Dept. 73 in this example.	<b>1 00</b>	
3 Press  key to finalize the transaction.		

# To use the cash register's basic function

## ■ Department number entry

If you allocate <Dept. no./Dept. shift> function to a key, you can register items without using Department key.

### Sample Operation

Item	Unit Price	•13.00	Registering an item in Dept. 31 without using Department key.
	Quantity	1	
	Dept.	31	
Payment	Cash	•13.00	

### Step

### Operation

### Printout

**1** Enter Dept. number using ten key pad then press <Dept. no./Dept. shift> key.

**3 1**  
<Dept. no./Dept. shift>

```

1 DEPT031      · 13.00
TL              - 13.00
CASH           · 13.00
    
```

**2** Enter the unit price and press  key. Then press  key. The item is registered in Dept. 31 in this example.

**1 3 00**

**3** Press  key to finalize the transaction.

# To use the cash register's basic function

## Basic setups and registrations

### To program basic settings

You can program basic settings in the PGM mode of the Mode switch.

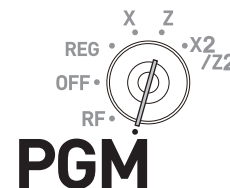

#### Step

#### Display

- 1 By turning the Mode switch to PGM position, the display indicates the programming top menu.
- 2 Use or keys to choose the item you wish to set then press key.  
Repeat the above step until the display shows an entry display.
- 3 Input values you wish to set and press key.

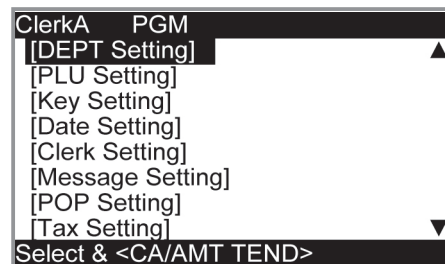

The following table shows the setting items of the basic programming.

### ■ Program menus

Top menu	Sub menu	What is to be set
[DEPT Setting]	DEPT name [DEPT0001 ]	Sets name, unit price, taxable status, item group and high amount limitation in each department. See page E-33.
	Unit Price [ 12.00 ]	
	Taxable Status [NON TAX]	
	Group Link [03]	
	HAL (High amount limit) [0.00]	
[PLU Setting]	PLU name [PLU0001 ]	Sets name, unit price, taxable status, item group, department link and open PLU in each PLU. See page E-35.
	Unit Price [ 12.00 ]	
	Taxable Status [NON TAX]	
	Group Link [03]	
	DEPT Link [003]	
	Open PLU [Yes]	
[Key Setting]	%- [ ]	Sets name, taxable status, and whether to use taxable status or not in each function key.
	- RATE [ ]	
	Taxable Status [ ]	
[Date Setting]	TIME (24 HOUR) [19:56]	Sets date and time.
	DAY [26]	
	MONTH [12]	
	YEAR 20[12]	
[Clerk Setting]	Name [CLERK01 ]	Sets clerk's name and number.
	Secret No [1234]	

# To use the cash register's basic function

Top menu	Sub menu	What is to be set
[Message Setting]	01 Logo 1	Sets logo, commercial, and bottom messages on receipts. See page E-78.
	02 Logo 2	
	03 Logo 3	
	04 Logo 4	
	05 Commercial 1	
	06 Commercial 2	
	07 Commercial 3	
	08 Commercial 4	
	01 Bottom 1	
	02 Bottom 2	
	03 Bottom 3	
	04 Bottom 4	
[POP Setting]	POP Message No. 1 [ ]	Sets preset pop messages and illustration. See page E-78.
	POP Message No. 2 [ ]	
	POP Message No. 3 [ ]	
	POP Message No. 4 [ ]	
	POP Graphic No.[ ]	
	POP Print	
	All Message	
	All Graphic	
[Tax Setting]	[RATE ]	
	[ROUND ]	
	[CAL TYPE ]	
[General Setting]	Enable clerk	Sets general controls of the register such as clerk assignment, printing journal in half size etc.
	Journal 1/2 Print	
	Consecutive No. Reset [Yes]	
	EJ clear (After Daily Z) [Yes]	
	EJ/Sales→SD (After XZ) [Yes]	
[Paper Roll Setting]	[Receipt]	
	[Journal]	
[Water Mark Setting]	YES	
	NO	
[SD card]	[Backup → SD]	Exchanges sales data, program data, and receipt's message data between the register and an SD card. See page E-127.
	[Restore← SD]	
	[Program→ SD]	
	[Program← SD]	
	[SD Format ]	
	[Backup → Flash]	
	[AutoProgram→ SD]	
	[AutoProgram← SD]	
[System Setting]		Used to set characters, functions of keys, or calculation methods etc.

# To use the cash register's basic function

## Programming departments

This section explains how you can set unit prices, taxable statuses, and item groups. You can program each department linking to a certain group. For example, department 01 is for packed milk, department 02 is for cheese and both belong to group 03 (dairy goods).

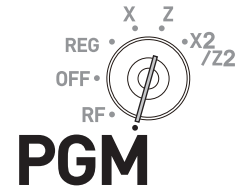

### Sample Operation

Dept. 01	Unit Price	•2.50	Programming Dept. 01 as unit price •2.50, non taxable, belonging to Group 02.
	Taxable status	Non tax	
	Group	02	

### Step

**1** Turn the Mode switch to PGM position. The display shows the top screen of programming.

**2** Using or keys, select [DEPT Setting] then press key. The display shows [DEPT Setting] screen.

**3** Enter the department number (01 in this example) then press key. The display shows department selection screen. You can change the department by using or keys.

**4** Press key. The display shows program input screen. Input unit price and group link you wish to program. The top column is for setting characters to the dept. You can leave the column empty. If you wish to set characters now, please see page E-74.

**5** Select [Taxable Status] and press key. The display shows taxable status selection screen. Choose the taxable status and press key.

### Display

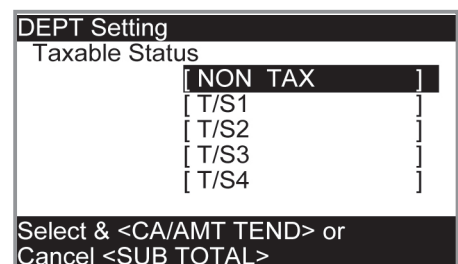
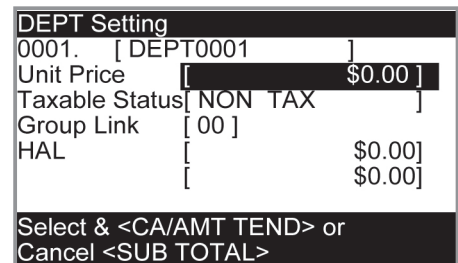
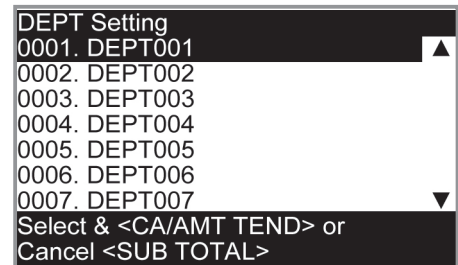
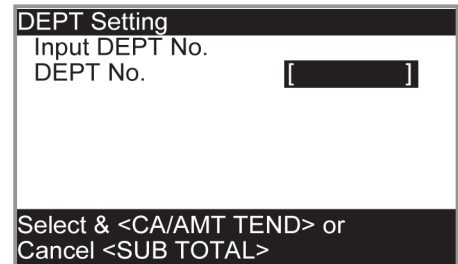
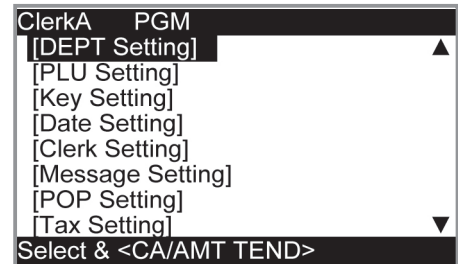

# To use the cash register's basic function

**NOTE** The display returns to the previous screen by pressing  key.

## Registering departments' preset data

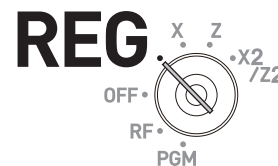

The following examples explain the operations using preset department data programmed in the previous section.



### ■ Using preset prices

#### Sample Operation









Item	Unit Price	•2.50	Unit price •2.50 is preset in Dept. 02.
	Quantity	1	
	Dept.	02	
Payment	Cash	•2.50	

Step	Operation	Printout
<b>1</b> Just press the corresponding Department key.		<div style="border: 1px solid black; padding: 5px;"> <pre> 1 DEPT002      • 2.50   TL           - 2.50   CASH         • 2.50                     </pre> </div>
<b>2</b> Press  key to finalize the transaction.		

### ■ Using preset tax statuses

#### Sample Operation

Item 1	Unit Price	•2.00	<ul style="list-style-type: none"> <li>• Dept. 03 presets: Unit price •2.00, Tax status 1 (4%).</li> <li>• Dept. 04 presets: Unit price •2.00, Tax status 2 (10%).</li> </ul>
	Quantity	5	
	Dept.	03	
	Taxable	1	
Item 2	Unit Price	•2.00	
	Quantity	1	
	Dept.	04	
	Taxable	2	
Payment	Cash	•2.50	

Step	Operation	Printout
<b>1</b> Register five pieces of Dept. 03 item using the multiplication key.	  	<div style="border: 1px solid black; padding: 5px;"> <pre> 5 DEPT003  T1  •10.00  1 DEPT004  T2  • 2.00   TA1       •10.00   TX1       • 0.40   TA2       • 2.00   TX2       • 0.20   TL       -12.60   CASH     •20.00   CG       • 7.40                     </pre> </div>
<b>2</b> Press Dept. 04 key to register one •2.00 item.		
<b>3</b> Press  key to indicate the total amount including tax.		
<b>4</b> Enter the tendered amount and press  key.		

# To use the cash register's basic function

## Programming PLUs

Like departments, you can program unit price, taxable status, and linking item group in a PLU (Price Look Up). Using PLUs allow you to register items quickly and accurately. You can use up to 3,000 PLUs.

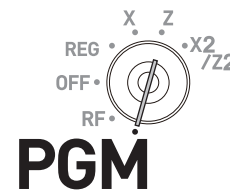

### Sample Operation

PLU 0014	Unit Price	•2.50	Programming PLU 0014 as unit price •2.50, non taxable, belonging to Group 03.
	Taxable status	Non tax	
	Group	03	

### Step

**1** Turn the Mode switch to PGM position. The display shows the top screen of programming.

### Display

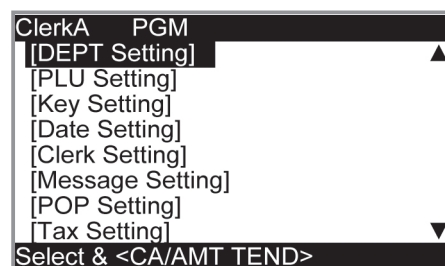

**2** Using or keys, select [PLU Setting] then press key. The display shows [PLU Setting] screen.

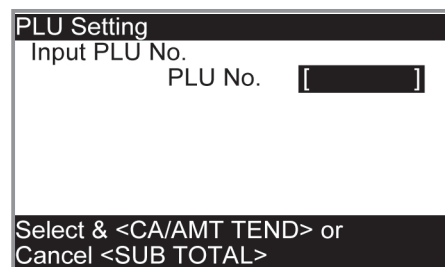

**3** Enter the PLU number (0014 in this example) then press key. The display shows [PLU Setting] screen. You can change the PLU number by using or keys.

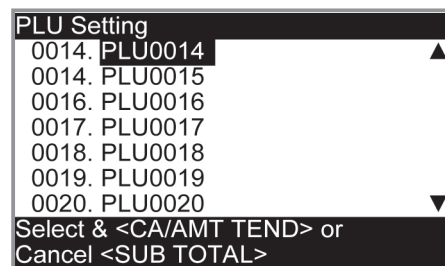

**4** Press key. The display shows program input screen. Input unit price and group link you wish to program. The top column is for setting characters to the PLU. You can leave the column empty. If you wish to set characters now, please see page E-74.

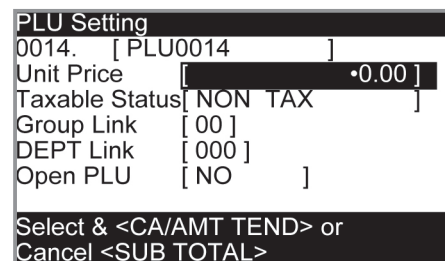

**5** Select [Taxable Status] and press key. The display shows taxable status selection screen. Choose the taxable status and press key.

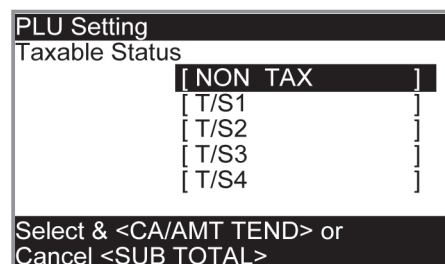

# To use the cash register's basic function

**NOTE** The display returns to the previous screen by pressing  key.

## Registering PLUs' preset data



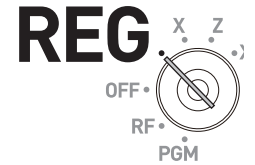



The following examples explain the operations using preset PLU data programmed in the previous section.



### ■ Single item sales using PLU

#### Sample Operation

Item	Unit Price	•2.50	One piece of PLU number 14 (preset unit price •2.50) is sold.
	Quantity	1	
	PLU No.	14	
Payment	Cash	•3.00	

Step	Operation	Printout
<b>1</b> Enter the PLU number and press  key. One piece of PLU number 14 item has been registered. Then press  key.	 	<div style="border: 1px solid black; padding: 5px;">                     1 PLU0014           •2.50                      TL                   - 2.50                      CASH               •3.00                      CG                   •0.50                 </div>
<b>2</b> Enter tendered amount and press  key.		



# To use the cash register's basic function

## ■ PLU repeat registration

### Sample Operation

Item	Unit Price	•2.50	Three pieces of PLU number 14 (preset unit price •2.50) is sold.
	Quantity	3	
	PLU No.	14	
Payment	Cash	•10.00	

Step	Operation	Printout												
<b>1</b> Enter the PLU number.	<b>1 4</b>	<table border="1"> <tr><td>1 PLU0014</td><td>•2.50</td></tr> <tr><td>1 PLU0014</td><td>•2.50</td></tr> <tr><td>1 PLU0014</td><td>•2.50</td></tr> <tr><td>TL</td><td>- 7.50</td></tr> <tr><td>CASH</td><td>•10.00</td></tr> <tr><td>CG</td><td>•2.50</td></tr> </table>	1 PLU0014	•2.50	1 PLU0014	•2.50	1 PLU0014	•2.50	TL	- 7.50	CASH	•10.00	CG	•2.50
1 PLU0014	•2.50													
1 PLU0014	•2.50													
1 PLU0014	•2.50													
TL	- 7.50													
CASH	•10.00													
CG	•2.50													
<b>2</b> Press <b>PLU</b> key repeatedly for the number of sold quantity. Three pieces of PLU 14 have been registered. Then press <b>SUB TOTAL</b> key.	<b>PLU</b> <b>PLU</b> <b>PLU</b> <b>SUB TOTAL</b>													
<b>3</b> Enter the tendered amount and press <b>CA / AMT / TEND</b> key.	<b>1 0 00</b> <b>CA / AMT / TEND</b>													

## ■ PLU registration with multiplication key

### Sample Operation

Item	Unit Price	•2.00	Ten pieces of PLU number 7 item (preset unit price •2.00) are sold.
	Quantity	10	
	PLU No.	7	
Payment	Cash	•20.00	

Step	Operation	Printout								
<b>1</b> Enter the quantity sold then press <b>X / FOR / DATE / TIME</b> key. Up to 9999.999 can be entered for multiplication calculations.	<b>1 0</b> <b>X / FOR / DATE / TIME</b>	<table border="1"> <tr><td>10 PLU0007</td><td>•20.00</td></tr> <tr><td>TL</td><td>- 20.00</td></tr> <tr><td>CASH</td><td>•20.00</td></tr> <tr><td>CG</td><td>•0.00</td></tr> </table>	10 PLU0007	•20.00	TL	- 20.00	CASH	•20.00	CG	•0.00
10 PLU0007	•20.00									
TL	- 20.00									
CASH	•20.00									
CG	•0.00									
<b>2</b> Enter the PLU number and press <b>PLU</b> key. Then press <b>SUB TOTAL</b> key.	<b>7</b> <b>PLU</b> <b>SUB TOTAL</b>									
<b>3</b> Enter tendered amount and press <b>CA / AMT / TEND</b> key.	<b>2 0 00</b> <b>CA / AMT / TEND</b>									

# To use the cash register's basic function

## ■ Split sales of packaged PLU item

By using allocated <X/For/Date Time> key, the register allows you split sales of packaged PLU items. Please see page E-113 for the key allocation.

### Sample Operation

Item	Unit Price	5 for •20	Selling three pieces of an item that is priced •20.00 for five pieces.
	Quantity	3	
	PLU No.	28	
Payment	Cash	•15.00	

Step	Operation	Printout
<p><b>1</b> Enter the quantity being purchased and press &lt;X/For/Date Time&gt; key for multiplication calculation. You can enter up to 9999.999 for multiplication calculations.</p>	<p><b>3</b> &lt;X/For/Date Time&gt;</p>	<div style="border: 1px solid black; padding: 5px;"> <p>3 PLU0028           • 12.00            TL                   • 12.00            CASH               • 15.00            CG                   • 3.00</p> </div>
<p><b>2</b> Enter the packaged quantity and press &lt;X/For/Date Time&gt; key. You can enter up to 9999.999 for packaged quantity.</p>	<p><b>5</b> &lt;X/For/Date Time&gt;</p>	
<p><b>3</b> Enter the PLU number of the item and press <b>PLU</b> key. Then press <b>SUB TOTAL</b> key.</p>	<p><b>2 8</b> <b>PLU</b> <b>SUB TOTAL</b></p>	
<p><b>4</b> Enter the tendered amount and press <b>CA / AMT / TEND</b> key.</p>	<p><b>1 5 00</b> <b>CA / AMT / TEND</b></p>	

# To use the cash register's basic function

## ■ Open PLU

Although unit price is preset in a PLU, you can enter price manually if the PLU is programmed as "Open PLU". To program open PLU, see page E-31.

### Sample Operation

Item 1	Unit Price	•32.80	PLU numbers 30 and 31 are programmed as open PLU so that the unit prices can be entered manually.
	Quantity	1	
	PLU No.	30	
Item 2	Unit Price	•13.00	
	Quantity	2	
	PLU No.	31	
Payment	Cash	•60.00	

Step	Operation	Printout												
<b>1</b> Enter the PLU number of the first item then press <input type="button" value="PLU"/> key.	<b>3 0</b> <input type="button" value="PLU"/>	<table border="1"> <tbody> <tr> <td>1 PLU0030</td> <td>•32.80</td> </tr> <tr> <td>1 PLU0031</td> <td>•13.00</td> </tr> <tr> <td>1 PLU0031</td> <td>•13.00</td> </tr> <tr> <td>TL</td> <td>- 58.80</td> </tr> <tr> <td>CASH</td> <td>•60.00</td> </tr> <tr> <td>CG</td> <td>•1.20</td> </tr> </tbody> </table>	1 PLU0030	•32.80	1 PLU0031	•13.00	1 PLU0031	•13.00	TL	- 58.80	CASH	•60.00	CG	•1.20
1 PLU0030	•32.80													
1 PLU0031	•13.00													
1 PLU0031	•13.00													
TL	- 58.80													
CASH	•60.00													
CG	•1.20													
<b>2</b> Enter the unit price and press <input type="button" value="PRICE"/> key.	<b>3 2 8 0</b> <input type="button" value="PRICE"/>													
<b>3</b> Enter the PLU number of the second item then press <input type="button" value="PLU"/> key.	<b>3 1</b> <input type="button" value="PLU"/>													
<b>4</b> Enter the unit price.	<b>1 3 00</b>													
<b>5</b> Press <input type="button" value="PRICE"/> key repeatedly for the number of purchased quantity and press <input type="button" value="SUB TOTAL"/> key.	<input type="button" value="PRICE"/> <input type="button" value="PRICE"/> <input type="button" value="SUB TOTAL"/>													
<b>6</b> Enter the tendered amount and press <input type="button" value="CA / AMT / TEND"/> key.	<b>6 0 00</b> <input type="button" value="CA / AMT / TEND"/>													

# To use the cash register's basic function

## Other registrations

### Discount

The following example shows how you can use the  $\%-\text{}$  key for discount registrations.

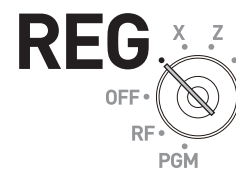

### ■ Discounts on items and subtotals

#### Sample Operation

Item 1	Dept. 01	•5.00	Five percent (preset in $\%-\text{}$ key) discount on PLU number 16 (preset unit price •10.00) and discount 3.5% on the subtotal amount.
	Quantity	1	
	Taxable	1 (preset)	
Item 2	PLU 16	•10.00 (preset)	
	Quantity	1	
	Taxable	2 (preset)	
Discount	Rate	5% (preset in $\%-\text{}$ )	
	Subtotal discount	Rate	
Subtotal discount	Taxable	Non taxable (preset)	
	Payment	Cash	

Step	Operation	Printout
1 Enter the unit price and corresponding department key.	<b>5</b> <b>00</b> <b>1</b>	<pre> 1 DEPT001  T1  -5.00 1 PLU0016  T2  -10.00   5% %-          T2  -0.50 ST          -14.50   3.5% %-          -0.51 TL          -13.99 CASH          -15.00 CG           -1.01                     </pre>
2 Enter the PLU number then press $\text{PLU}$ key. The preset unit price (•10.00) is registered.	<b>1</b> <b>6</b> $\text{PLU}$	
3 Press $\%-\text{}$ key. The discount amount with the preset rate (5%) is subtracted from the last item registered (PLU 16).	$\%-\text{}$	
4 Press $\text{SUB TOTAL}$ key for giving discount on the subtotal amount.	$\text{SUB TOTAL}$	
5 Enter the discount rate manually and press $\%-\text{}$ key. Discount amount with inputted rate is subtracted from the subtotal amount.	<b>3</b> <b>.</b> <b>5</b> $\%-\text{}$	
6 Press $\text{SUB TOTAL}$ key to show the total amount including tax and discounts.	$\text{SUB TOTAL}$	
7 Enter the tendered amount and press $\text{CA/AMT/TEND}$ key.	<b>1</b> <b>5</b> <b>00</b> $\text{CA/AMT/TEND}$	

Printout differs depending on preset tax statuses.

#### NOTE

- When you perform a discount operation on the last item registered, the tax of discount amount is calculated in accordance with the tax status programmed to the item.
- When you perform a discount operation on a subtotal amount, the tax of discount amount from subtotal is calculated in accordance with the tax status programmed in the  $\%-\text{}$  key.
- To program discount rate in  $\%-\text{}$  key, please see page E-31.

# To use the cash register's basic function

## Reduction

Using the reduction feature, you can subtract a certain amount from an item's unit price or from a subtotal amount.

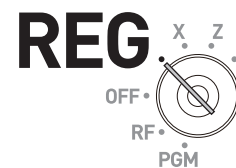

### Sample Operation

Item 1	Dept. 01	•5.00	<ul style="list-style-type: none"> <li>• Reducing •0.25 (manual input) from item 1 unit price.</li> <li>• Reducing •0.50 (preset amount) from item 2.</li> <li>• Reducing •0.75 (manual input) from subtotal amount.</li> </ul>
	Quantity	1	
	Taxable	1 (preset)	
	Reduction	•0.25	
Item 2	PLU 45	•6.00 (preset)	
	Quantity	1	
	Taxable	1 (preset)	
	Reduction	•0.50 (preset)	
Subtotal	Reduction	•0.75	
	Taxable	Non taxable (preset)	
Payment	Cash	•10.00	

Step	Operation	Printout
1 Register item 1 by inputting the unit price and department key.	<b>5 0 0</b> <input type="button" value="1"/>	<pre> 1 DEPT001  T1  ·5.00 -          T1  -0.25 1 PLU0045  T1  ·6.00 -          T1  -0.50 -          -0.75 TL          -9.50 CASH              ·10.00 CG                ·0.50                     </pre>
2 Enter reduction amount manually and press <input type="button" value="-"/> key. •0.25 is subtracted from the unit price.	<b>2 5</b> <input type="button" value="-"/>	
3 Register item 2 by inputting the PLU number and <input type="button" value="PLU"/> key.	<b>4 5</b> <input type="button" value="PLU"/>	
4 Press <input type="button" value="-"/> key. Pressing <input type="button" value="-"/> key without numeral entry subtracts the preset reduction amount (•0.50 in this example) from the PLU's unit price.	<input type="button" value="-"/>	
5 Press <input type="button" value="SUB TOTAL"/> key for reducing amount from the subtotal.	<input type="button" value="SUB TOTAL"/>	
6 Enter reduction amount manually then press <input type="button" value="-"/> key. The inputted amount is subtracted from the subtotal amount.	<b>7 5</b> <input type="button" value="-"/>	
7 Enter the tendered amount then press <input type="button" value="CA / AMT / TEND"/> key.	<b>1 0 00</b> <input type="button" value="CA / AMT / TEND"/>	

Printout differs depending on preset tax statuses.

**NOTE**

- You can input up to seven digits reduction amount manually.
- To program preset reduction amount, please see page E-31.

# To use the cash register's basic function

## Registering various payment methods

Other than cash payments, you can register transactions made by checks, charges, credits, or even mixed tendering.

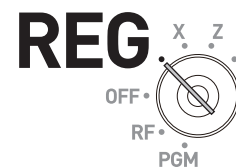

### ■ Check sale

#### Sample Operation

Item	Unit Price	•11.00	A •11.00 item is sold and customer paid by •20.00 check (check number 1234).
	Quantity	1	
Reference no. of check		1234	
Payment	Check	•20.00	

Step	Operation	Printout
<b>1</b> Register the item purchased.	<b>1 1 00</b> <input type="text" value="1"/>	<pre> 1 DEPT001      · 11.00 #              1234 TL            - 11.00 CHECK         · 20.00 CG           · 9.00                     </pre>
<b>2</b> If you wish to record reference number such as a check number, enter the number then press <input type="text" value="#"/> key.	<b>1 2 3 4</b> <input type="text" value="#"/>	
<b>3</b> Enter the paid amount then press <input type="text" value="CHK"/> key.	<b>2 0 00</b> <input type="text" value="CHK"/>	

### ■ Charge sale

If <Charge> function is allocated to a key, you can register a charge sale. To allocate <Charge> function on a key, please see page E-113.

#### Sample Operation

Item	Dept. 04	•15.00	A purchased item is transacted by charge sale.
	Quantity	1	
Payment	Charge	•15.00	

Step	Operation	Printout
<b>1</b> Register the item purchased and press <input type="text" value="SUB TOTAL"/> key.	<b>1 5 00</b> <input type="text" value="4"/> <input type="text" value="SUB TOTAL"/>	<pre> 1 DEPT004      · 15.00 TL            - 15.00 CHARGE        · 15.00                     </pre>
<b>2</b> Press <Charge> key to finalize the charge transaction.	<Charge>	

# To use the cash register's basic function

## ■ Credit sale

### Sample Operation

Item	Dept. 03	•10.00	A purchased item is paid by a credit card.
	Quantity	1	
Payment	Credit	•10.00	

Step	Operation	Printout						
<b>1</b> Register the item purchased and press <input type="button" value="SUB TOTAL"/> key.	<b>1 0 00</b> <input type="button" value="3"/> <input type="button" value="SUB TOTAL"/>	<table border="1"> <tr> <td>1 DEPT003</td> <td>· 10.00</td> </tr> <tr> <td>TL</td> <td>- 10.00</td> </tr> <tr> <td>CREDIT</td> <td>· 10.00</td> </tr> </table>	1 DEPT003	· 10.00	TL	- 10.00	CREDIT	· 10.00
1 DEPT003	· 10.00							
TL	- 10.00							
CREDIT	· 10.00							
<b>2</b> Press <input type="button" value="CR"/> key to finalize the transaction.	<input type="button" value="CR"/>							

## ■ Mixed payments (cash and check)

### Sample Operation

Item	Dept. 04	•55.00	Customer paid •30.00 by check and the rest in cash for •55.00 item.
	Quantity	1	
Payment	Check	•30.00	
	Cash	•25.00	

Step	Operation	Printout										
<b>1</b> Register the item purchased and press <input type="button" value="SUB TOTAL"/> key.	<b>5 5 00</b> <input type="button" value="4"/> <input type="button" value="SUB TOTAL"/>	<table border="1"> <tr> <td>1 DEPT004</td> <td>· 55.00</td> </tr> <tr> <td>TL</td> <td>- 55.00</td> </tr> <tr> <td>CHECK</td> <td>· 30.00</td> </tr> <tr> <td>CASH</td> <td>· 25.00</td> </tr> <tr> <td>CG</td> <td>· 0.00</td> </tr> </table>	1 DEPT004	· 55.00	TL	- 55.00	CHECK	· 30.00	CASH	· 25.00	CG	· 0.00
1 DEPT004	· 55.00											
TL	- 55.00											
CHECK	· 30.00											
CASH	· 25.00											
CG	· 0.00											
<b>2</b> Enter the amount paid by a check then press <input type="button" value="CHK"/> key.	<b>3 0 00</b> <input type="button" value="CHK"/>											
<b>3</b> Enter the paid cash amount then press <input type="button" value="CA / AMT / TEND"/> key.	<b>2 5 00</b> <input type="button" value="CA / AMT / TEND"/>											

# To use the cash register's basic function

## Registering returned goods

### ■ Registering returned goods in the REG mode

The following example shows how to operate for registering goods returned by customer in the REG mode.

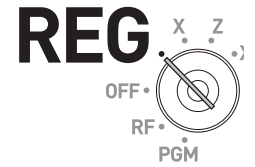

### Sample Operation

Item 1	Dept. 01	•2.35	Customer returned items 1 and 3 during the registration.
	Quantity	1	
Item 2	Dept. 02	•2.00	
	Quantity	1	
Item 3	PLU 001	•1.20 (preset)	
	Quantity	1	
Refunded Item 1	Dept. 01	•2.35	
	Quantity	1	
Refunded Item 3	PLU 0001	•1.20 (preset)	
	Quantity	1	
Payment	Cash	•2.00	

Step	Operation	Printout
<b>1</b> Register purchased item 1.	<b>2</b> <b>3</b> <b>5</b> <b>1</b>	<pre> 1 DEPT001      -2.35 1 DEPT002      -2.00 1 PLU0001      -1.20 RF             ..... 1 DEPT001      -2.35 RF             ..... 1 PLU0001      -1.20 TL             -2.00 CASH           -2.00                     </pre>
<b>2</b> Register purchased item 2.	<b>2</b> <b>00</b> <b>2</b>	
<b>3</b> Register purchased item 3.	<b>1</b> <b>PLU</b>	
<b>4</b> Press <b>RF</b> key prior to registering returned item 1.	<b>RF</b>	
<b>5</b> Register returned item 1.	<b>2</b> <b>3</b> <b>5</b> <b>1</b>	
<b>6</b> Press <b>RF</b> key and register returned item 3. Then press <b>SUB TOTAL</b> key.	<b>RF</b> <b>1</b> <b>PLU</b> <b>SUB TOTAL</b>	
<b>7</b> Press <b>CA / AMT / TEND</b> key as the customer paid exact amount.	<b>CA / AMT / TEND</b>	



# To use the cash register's basic function



## ■ Registering returned goods in the RF mode

When a customer returns goods after the transaction has been completed, use RF mode for the refund operation.



### Sample Operation

Refunded Item 1	Dept. 03	•4.00	A customer returned two items. Item 1 was sold with •0.15 reduction and item 2 was sold with pre-programmed 5% discount.
	Quantity	1	
	Reduced	•0.15	
Refunded Item 2	PLU 002	•1.20 (preset)	
	Quantity	1	
	Discounted	5% (preset)	
Payment	Cash	•4.99	

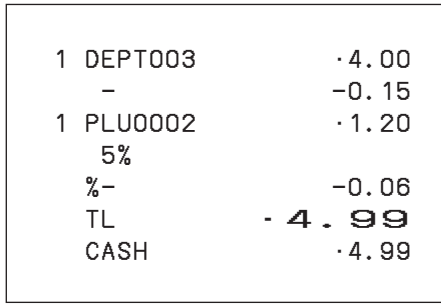
Step	Operation	Printout
1	Turn the Mode switch to RF position.	
2	Register the returned items by the same operations as normal registration and press  key.	
3	Press  key and pay the total amount back to the customer.	

### Important

- After the refund operation, please do not forget to return the Mode switch to REG position otherwise the following registrations are stored as minus transactions.

# To use the cash register's basic function

## Registrations without transactions

The followings are the operations other than normal sales transactions. Please do not perform these operations during a sales transaction.

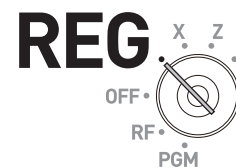

### ■ Registering money received on account

Use this operation when you put money in the drawer without any sales transactions such case as preparing change.

#### Sample Operation

Received amount	•70.00	Prepared •70.00 in the drawer for change before opening the store.
-----------------	--------	--

Step	Operation	Printout		
1 Enter the amount put in the drawer then press <input type="button" value="RA"/> key.	<input type="button" value="7"/> <input type="button" value="0"/> <input type="button" value="00"/> <input type="button" value="RA"/>	<table border="1"> <tr> <td>RA</td> <td>•70.00</td> </tr> </table>	RA	•70.00
RA	•70.00			

### ■ Registering money paid out from the drawer.

Use this operation when you withdraw money from the drawer without any sales transactions such case as paying for a cash-on-delivery item.

#### Sample Operation

Paid out amount	•1.50	Paying •1.50 from the drawer.
-----------------	-------	-------------------------------

Step	Operation	Printout		
1 Enter the amount withdrawn from the drawer then press <input type="button" value="PO"/> key.	<input type="button" value="1"/> <input type="button" value="5"/> <input type="button" value="0"/> <input type="button" value="PO"/>	<table border="1"> <tr> <td>PO</td> <td>•1.50</td> </tr> </table>	PO	•1.50
PO	•1.50			

### ■ Opening the drawer without putting money in or out

Use this operation to open the drawer without putting money in or out. The number of  key operations will be printed on X or Z reports.

Step	Operation	Printout		
1 Just press <input type="button" value="NS"/> key. The drawer opens.	<input type="button" value="NS"/>	<table border="1"> <tr> <td>NS</td> <td>.....</td> </tr> </table>	NS	.....
NS	.....			

# To use the cash register's basic function

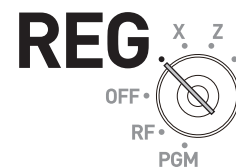

## Corrections

There are three ways to correct erroneous operations that are;

- Correcting erroneous item not registered
- Correcting erroneous item already registered
- Cancelling all the items registered in a transaction

### ■ Correcting erroneously entered item not registered

Step	Operation	Printout														
<b>1</b> Correcting wrong unit price •2.00 to •1.00.	<b>2 00</b> <input type="button" value="C"/>	<div style="border: 1px solid black; padding: 5px;"> <table style="width: 100%; border-collapse: collapse;"> <tr><td style="width: 60%;">1 DEPT001</td><td style="text-align: right;">• 1.00</td></tr> <tr><td>11 DEPT002</td><td style="text-align: right;">• 22.00</td></tr> <tr><td>1 PLU0003</td><td style="text-align: right;">• 1.30</td></tr> <tr><td>1 PLU0015</td><td style="text-align: right;">• 10.00</td></tr> <tr><td>TL</td><td style="text-align: right;"><b>- 34.30</b></td></tr> <tr><td>CASH</td><td style="text-align: right;">• 15.00</td></tr> <tr><td>CHECK</td><td style="text-align: right;">• 19.30</td></tr> </table> </div>	1 DEPT001	• 1.00	11 DEPT002	• 22.00	1 PLU0003	• 1.30	1 PLU0015	• 10.00	TL	<b>- 34.30</b>	CASH	• 15.00	CHECK	• 19.30
1 DEPT001	• 1.00															
11 DEPT002	• 22.00															
1 PLU0003	• 1.30															
1 PLU0015	• 10.00															
TL	<b>- 34.30</b>															
CASH	• 15.00															
CHECK	• 19.30															
<b>2</b> Correcting wrong quantity 12 to 11.	<b>1 00</b> <input type="button" value="1"/> <input type="button" value="C"/>															
<b>3</b> Correcting wrong PLU number 002 to 003.	<b>1 2</b> <input type="button" value="X/DATE TIME"/> <input type="button" value="C"/>															
<b>4</b> Correcting open PLU unit price •6.00 to •10.00. You must re-enter the PLU number prior to entering correct unit price.	<b>1 1</b> <input type="button" value="X/DATE TIME"/> <b>2 00</b> <input type="button" value="2"/> <input type="button" value="C"/>															
<b>5</b> Correcting wrong partially tendered cash amount •10.00 to •15.00.	<b>3</b> <input type="button" value="PLU"/> <b>1 5</b> <input type="button" value="PLU"/> <b>6 00</b> <input type="button" value="C"/>															
<b>6</b> The remaining amount is paid by check.	<b>1 5</b> <input type="button" value="PLU"/> <b>1 0 00</b> <input type="button" value="PRICE"/> <input type="button" value="C"/>															
	<b>1 0 00</b> <input type="button" value="C"/>															
	<b>1 5 00</b> <input type="button" value="CA / AMT TEND"/> <input type="button" value="CHK"/>															

# To use the cash register's basic function

## ■ Correcting items immediately after the registration

Step	Operation	Printout
1 Registering an item.	<b>1</b> <b>00</b> <b>1</b>	
2 By mistake, Dept. key has been pressed twice so cancelling the preceding registration by <b>ERR CORR CANCEL</b> key.	<b>2</b> <b>00</b> <b>2</b> <b>2</b> <b>ERR CORR CANCEL</b>	
3 Cancelling wrong PLU registration (PLU No. 2) and re-registering correct PLU (PLU No. 5).	<b>2</b> <b>PLU</b> <b>ERR CORR CANCEL</b> <b>5</b> <b>PLU</b>	
4 Cancelling a registration of an open PLU's (PLU No. 15) wrong unit price •6.00 and re-registering the item with the correct unit price •10.00.	<b>1</b> <b>5</b> <b>PLU</b> <b>6</b> <b>00</b> <b>PRICE</b> <b>ERR CORR CANCEL</b> <b>1</b> <b>5</b> <b>PLU</b> <b>1</b> <b>0</b> <b>00</b> <b>PRICE</b>	
5 Cancelling a registration of an item with wrong quantity (8 pieces) and re-registering the item with the correct quantity (6 pieces).	<b>8</b> <b>X/DATE TIME</b> <b>4</b> <b>00</b> <b>4</b> <b>ERR CORR CANCEL</b> <b>6</b> <b>X/DATE TIME</b> <b>4</b> <b>00</b> <b>4</b>	
6 The remaining amount is paid by check.  Cancelling wrong subtotal discount calculation (with rate of 50%) and re-calculating the discount amount with the correct rate (5%).	<b>SUB TOTAL</b> <b>5</b> <b>0</b> <b>%-</b> <b>ERR CORR CANCEL</b> <b>SUB TOTAL</b> <b>5</b> <b>%-</b>	
7 Cancelling wrong refund amount (•2.00) and re-registering correct amount (•2.20).	<b>RF</b> <b>2</b> <b>00</b> <b>2</b> <b>ERR CORR CANCEL</b> <b>RF</b> <b>2</b> <b>2</b> <b>0</b> <b>2</b>	
8 Getting the subtotal amount.	<b>SUB TOTAL</b>	
9 Cancelling partially tendered cash amount (•20.00) and re-registering correct amount (•15.00).	<b>2</b> <b>0</b> <b>00</b> <b>CA / AMT / TEND</b> <b>ERR CORR CANCEL</b> <b>1</b> <b>5</b> <b>00</b> <b>CA / AMT / TEND</b>	
10 The customer paid the balance due by check.	<b>CHK</b>	

1	DEPT001	· 1.00
1	DEPT002	· 2.00
1	DEPT002	· 2.00
	C0RR	-2.00
1	PLU0002	· 2.00
	C0RR	-2.00
1	PLU0005	· 1.50
1	PLU0015	· 6.00
	C0RR	-6.00
1	PLU0015	· 10.00
8	DEPT004	· 32.00
	C0RR	-32.00
6	DEPT004	· 24.00
	ST	· 38.50
	50%	
	%-	-19.25
	C0RR	· 19.25
	ST	· 38.50
	5%	
	%-	-1.93
	RF	· · · · · · · ·
1	DEPT	-2.00
	C0RR	· 2.00
	RF	· · · · · · · ·
1	DEPT002	-2.20
	TL	- 34.37
	CASH	· 20.00
	C0RR	-20.00
	CASH	· 15.00
	CHECK	· 19.37

Corrected items are not printed on receipt if programmed as "Buffered receipt printing".

# To use the cash register's basic function

## ■ Voiding an item which has been already registered

### Step

### Display

**1** During a registration.

CLERK001	REG	000011
3	DEPT001	•6.00
1	PLU002	•2.00
3	DEPT002	•9.00
2	PLU003	•4.00
1	DEPT003	•2.00
<b>SUBTOTAL</b>		<b>•24.00</b>
QT	11	0.00

**2** Using  or  keys, select the item you have mis-registered.

[ REVIEW / VOID ]		
1	PLU001	•1.00
3	DEPT001	•6.00
1	PLU002	•2.00
3	DEPT002	•9.00
2	PLU003	•4.00
1	DEPT003	•2.00
VOID :<CA AMT/TEND>		
CANCEL:<SUB TOTAL>		
		0.00



**3** Press  key. The selected item is voided.

CLERK001	REG	000011
2	PLU003	•4.00
1	DEPT003	•2.00
1	DEPT003	•2.00
<b>SUBTOTAL</b>		<b>•22.00</b>
QT	10	0.00

# To use the cash register's basic function

## ■ Cancelling all items in a transaction

### Step

**1** Press  key after items have been registered then press  key.

**2** Select [YES] on the pop up display.

**3** Press  key. The registered items are cancelled.

### Display

CLERK001	REG	000011
3	DEPT001	•6.00
1	PLU002	•2.00
3	DEPT002	•9.00
2	PLU003	•4.00
1	DEPT003	•2.00
<b>SUBTOTAL</b>		<b>•24.00</b>
QT	11	0.00

CLERK001	REG	000011
CANCEL OPERATION		
Please select		
Yes	:<CA/AMT TEND>	
No	:<C>	
<b>ST</b>		<b>•24.00</b>
QT	11	0.00

CLERK001	REG	000011
1	PLU002	•2.00
3	DEPT002	•9.00
2	PLU003	•4.00
1	DEPT003	•2.00
CANCEL		.....
<b>SUBTOTAL</b>		<b>•0.00</b>
CANCEL		0.00

# To use the cash register's basic function

## Daily sales reports

At the end of the business day, you can print categorized and summarized results of the day. Reset report (Z) clears all the sales data whereas the data remains in memory by Read report (X).

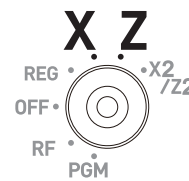



**NOTE** Please do not perform the Reset report (Z) printing while your store is open. It clears all the sales data.

### Step

**1** Turn the Mode switch to X or Z position. The display shows top display of sales reports.

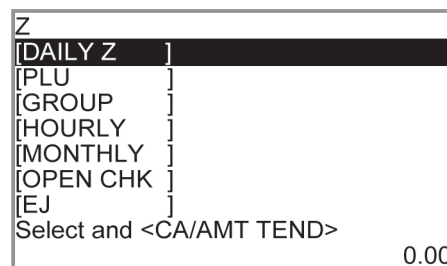
### Display



**2** Select [DAILY Z] (DAILY X when you set the Mode switch to X) and press  key. The printer prints a sales report.

### Further operations:

- For individual reports, please see page E-120.

# To use the cash register's basic function

## Print out of daily sales report

Z	20-06-2013 17:00		1
	0001	000231	2
-----			
Z	DAILY Z		3
-----			
Z	DEPT	0001	4
		0001015	5
-----			
DEPT001		203.25	6
		·1,108.54	
DEPT002		183	
		·1,362.26	
		5	
		47.00	
-----			
TL		421.25	7
		·2,872.28	
-----			
Z	FIX	0001	8
		0001011	9
-----			
GROSS		981.25	
		·6,574.40	10
NET	No 111		
		·7,057.14	11
CAID		·1,919.04	12
CHID		·139.04	13
CKID		·859.85	14
CRID(1)		·709.85	15
CRID(2)		·0.00	16
CRID(3)		·0.00	17
CRID(4)		·0.00	18
-----			
RF	No 3		19
		·10.22	
CUST	CT 111		20
AVRG		·63.57	21
DC		·1.22	22
REF		·2.42	23
ROUND		·0.00	24
CANCEL	No 2		25
		·12.97	
-----			

- 1 Date/time
- 2 Machine No./consecutive No.
- 3 Report title
- 4 Department report title/reset counter
- 5 Report code
- 6 Department count/amount \*1
- 7 Department total count/total amount
- 8 Fixed total report title/reset counter
- 9 Report code
- 10 Gross total \*2
- 11 Net total \*2
- 12 Cash in drawer \*2
- 13 Charge in drawer \*2
- 14 Check in drawer \*2
- 15 Credit in drawer 1 \*2
- 16 Credit in drawer 2 \*2
- 17 Credit in drawer 3 \*2
- 18 Credit in drawer 4 \*2
- 19 Refund mode \*2
- 20 Number of customer \*2
- 21 Average sales per customer \*2
- 22 Discount total \*2
- 23 Refund key \*2
- 24 Rounding total \*2
- 25 Cancellation

\* 1 If total amount is zero, these items will not be printed.

\* 2 These items can be skipped by programming.



# To use the cash register's basic function

TA1		·2,369.69	26
TX1		·128.86	27
TA2		·2,172.96	28
TX2		·217.33	29
-----			
GT		·00000000125478.96	30
-----			
Z	TRANS	0001	31
		0001012	32
CASH	No	362	33
		·1,638.04	
CHARGE	No	56	
		·1,174.85	
RA	No	4	
		·810.00	
P0	No	5	
		·520.00	
		·5.00	
CORR	No	14	
		·39.55	
RCT	No	3	
NS	No	5	
-----			

- 26 Taxable 1 amount \*2
- 27 Tax 1 amount \*2
- 28 Taxable 2 amount \*2
- 29 Tax 2 amount \*2
- 30 Grand total \*2
- 31 Function key report title/reset counter
- 32 Report code
- 33 Function key count/amount \*1

\* 1 If total amount is zero, these items will not be printed.

\* 2 These items can be skipped by programming.

# Advanced programmings and registrations

Advanced registrations.....	E-55
Enabling clerk assignment.....	E-55
Registrations with clerk assignment.....	E-56
Single item cash sales .....	E-57
Other operations.....	E-59
Character settings.....	E-74
Using character keyboard.....	E-74
Using ten key pad .....	E-75
Setting characters .....	E-77
Setting pop messages on receipts.....	E-78
Setting symbol characters .....	E-80
Advanced programmings .....	E-83
Programming detail settings .....	E-84
Programming functions of departments and PLUs in a lump .....	E-96
Programming department and flat PLU functions in a lump .....	E-96
Programming PLU functions in a lump .....	E-98
Programming functions of departments and PLUs individually .....	E-99
Programming functions of departments individually.....	E-99
Programming functions of PLUs individually.....	E-101
Programming functions of transaction keys .....	E-102
Programming further clerk functions.....	E-109
Programming auto operation of <Arrangement> .....	E-112
Printing programmed data .....	E-115
To print programmed unit price or percentage (other than PLU).....	E-115
To print programmed characters (except PLUs) .....	E-116
To print general programming (except PLUs).....	E-117
To print preset unit price of PLU .....	E-118
To print preset characters of PLU.....	E-119
To print PLU programmings .....	E-119
To print key allocation program .....	E-119
Printing various sales reports.....	E-120
Printing various sales reports.....	E-120
To print individual department, PLU, and Flat PLU .....	E-124
Periodic sales report.....	E-124
Using an SD card.....	E-127
To format an SD card.....	E-127
To store program data in an SD card.....	E-128
Before you consider it as a problem .....	E-129
Error code table .....	E-129
When “EJ FULL” sign appears on the display.....	E-131
In case of power failure.....	E-131
In case the register is locked up.....	E-131
About the low battery indicator .....	E-132
Specifications .....	E-133

## Advanced registrations

### Enabling clerk assignment

By assigning a clerk, clerk number or name will be printed on receipts. The following operation enables the register to use the clerk assignment.

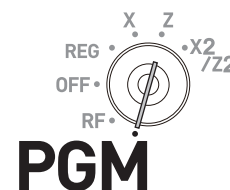

Step	Operation
1	Turn the Mode switch to PGM position. The display shows programming top menu.
2	Using  and  keys, select [System Setting] and press  key. [System Setting] is the last column on the programming top menu and is not shown on the first screen. Keep pressing  key until it appears on the screen.
3	Enter  from ten key pad then press  key. This operation sets the register in program mode.
4	Enter  from ten key pad and press  key. Number 2722 is the program code for clerk assignment setting.
5	Enter  and eight zeros from the ten key pad then press  key. Number 40000000 is the set code to enable clerk assignment.
	If you wish to disable the clerk assignment feature later on, perform these steps and enter nine zeros in this step.
6	Press  key to complete the setting.

**NOTE** You can also program fro enabling clerk operations by detail setting program. Please see page E-93 "Set code 27".

# Advanced programmings and registrations

## Registrations with clerk assignment

By signing a clerk on, the clerk name will be printed on receipts and sales reports.

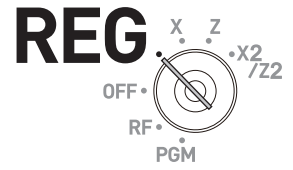

Step	Operation	Printout
<b>1</b> Enter the clerk number and press <input type="button" value="CLK#"/> key.	<b>1</b> <input type="button" value="CLK#"/>	<pre>* commercial message * REG 20-06-2013 11:58 C01 0001 000123 1 1 DEPT01 T1 .1.00</pre>
<b>2</b> Perform registration operations. The clerk name is printed on receipts and displayed on top of the display.		
<b>3</b> To sign a clerk off, enter <b>0</b> and <b>0</b> <input type="button" value="CLK#"/> press <input type="button" value="CLK#"/> key. Or just press <input type="button" value="SIGN OFF"/> key.	<b>0</b> <input type="button" value="CLK#"/>	1: Clerk Name/Machine No./Consecutive No.

### NOTE

- During a registration, another clerk can take over the transaction. Enter another clerk's clerk number during a registration and press  key. The display shows the confirmation display. Select [YES] then press  key.
- The clerk number is cleared when the Mode switch is turned to OFF position.

### Further operation:

You can sign on the register by clerk's secret number instead of clerk number. Also you can set characters for clerks' names. To set clerks' secret numbers and names, see page E-31.

# Advanced programmings and registrations

## Single item cash sales

A department key or a PLU programmed as single item sale status finalizes the transaction as soon as it is registered. This feature can be used only in cash sales. To program single item sales status see pages E-99 and E-100.

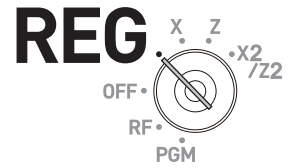



### Sample operation 1: Simple single item sale

Item	Dept. 01	•1.00	Dept. 01 is programmed as single item sale and unit price is not preset.
	Quantity	1	
	Preset	Single item	
Payment	Cash	•1.00	

Step	Operation	Printout
<b>1</b> Enter the unit price then press corresponding department key. The transaction is finalized immediately after the department key depression.	<b>1</b> <b>00</b> <b>1</b>	<pre> 1 DEPT001      .1.00   TL           - 1.00   CASH         .1.00                     </pre>

### Sample operation 2: Single item sale with multiplication

Item	Dept. 01	•1.00	Selling three pieces of items of dept. 01 in which unit price •1.00 and single item sale status is pre-programmed.
	Quantity	3	
	Preset	Single item	
Payment	Cash	•3.00	

Step	Operation	Printout
<b>1</b> Enter the quantity and press  key for multiplication.	<b>3</b> 	<pre> 3 DEPT001      .3.00   TL           - 3.00   CASH         .3.00                     </pre>
<b>2</b> Press corresponding department key. The transaction is finalized immediately.	<b>1</b>	

Useful features

# Advanced programmings and registrations

## Sample operation 3: Single item sale with another item

Item 1	Dept. 03	•2.00	Dept. 03 is a normal department while dept. 01 is programmed as unit price •1.00 and single item sale status.
	Quantity	1	
	Preset	Normal	
Item 2	Dept. 01	•1.00	
	Quantity	1	
	Preset	Single item	
Payment	Cash	•3.00	

Step	Operation	Printout								
<b>1</b> Register item 1.	<b>2</b> <b>00</b> <b>3</b>	<table border="1"> <tr> <td>1 DEPT003</td> <td>•2.00</td> </tr> <tr> <td>1 DEPT001</td> <td>•1.00</td> </tr> <tr> <td>TL</td> <td>- 3.00</td> </tr> <tr> <td>CASH</td> <td>•3.00</td> </tr> </table>	1 DEPT003	•2.00	1 DEPT001	•1.00	TL	- 3.00	CASH	•3.00
1 DEPT003	•2.00									
1 DEPT001	•1.00									
TL	- 3.00									
CASH	•3.00									
<b>2</b> Single item sale department key does not finalize the transaction as it is not single item sale.	<b>1</b>									
<b>3</b> Press <input type="button" value="CA/AMT/TEND"/> key to finalize the transaction.	<input type="button" value="CA/AMT/TEND"/>									

# Advanced programmings and registrations

## Other operations

### ■ Transactions with coupons

If <Coupon> function is allocated on a key, you can register items with coupons.  
To allocate <Coupon> function on a key, please see page E-113.

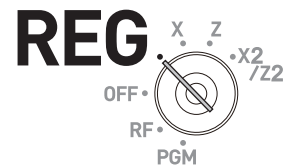

### Sample operation

Item 1	Dept. 01	•3.00	Customer paid two •0.50 coupons for item 1 and a •1.00 coupon for item 2. Amount•1.00 is preprogrammed in <Coupon> key.
	Quantity	2	
	Coupon.	•0.50 × 2	
Item 2	Dept. 03	•4.00	
	Quantity	1	
	Coupon.	•1.00 (preset)	
Payment	Cash	•8.00	

Step	Operation	Printout
<b>1</b> Register the item 1.	<b>2</b> <b>3 00</b> <b>1</b>	<pre> 2 DEPT001          ·6.00   COUPON           ·1.00 1 DEPT003          ·4.00   COUPON           ·1.00   TL               - 8.00   CASH             ·8.00                 </pre>
<b>2</b> Use multiplication key for the number of coupons.	<b>2</b>	
<b>3</b> Enter the amount of a coupon and press <Coupon> key.	<b>5 0</b> <Coupon>	
<b>4</b> Register item 2.	<b>4 00</b> <b>3</b>	
<b>5</b> Without entering a price of a coupon, press <Coupon> key for preset coupon price.	<Coupon>	
<b>6</b> Press  key to finalize the transaction.		

**NOTE** An error occurs if the register is programmed to prohibit credit balance and the result of a calculation is negative.

# Advanced programmings and registrations

## ■ Transactions with premium

If <Premium> function is allocated on a key, you can add premiums on items or on the subtotal. To allocate <Premium> function on a key, please see page E-113.

### Sample operation

Item 1	Dept. 01	•1.00	<ul style="list-style-type: none"> <li>• 10% premium is added to item1.</li> <li>• 15% (preprogrammed in &lt;Premium&gt; key) is added to the subtotal amount.</li> </ul>
	Quantity	1	
	Premium.	10%	
Item 2	Dept. 01	•2.00	
	Quantity	3	
Subtotal	Premium.	15% (preset)	
Payment	Cash	•8.17	

### Step

### Operation

### Printout

**1** Register the item 1.

**1** 00

**2** Enter premium rate and press <Premium> key.

**1** 0 <Premium>

**3** Register the item 2

**3**  **2** 00

**4** Press  key.

**5** Press <Premium> key. Preprogrammed premium rate will be added to the subtotal.

<Premium>

**6** Press  key to finalize the transaction.

1	DEPT001	· 1.00
	10%	
	%+	· 0.10
3	DEPT001	· 6.00
	ST	· 7.10
	15%	
	%+	· 1.07
	TL	- 8.17
	CASH	· 8.17



# Advanced programmings and registrations

## ■ VAT breakdown printing

You can force printing of VAT breakdown at the finalize stage, regardless of whether the cash register is programmed to print or skip printing of the VAT breakdown.

Please note that you need to allocate <VAT> function to a key. See page E-113.

### Sample operation

Item 1	Dept. 01	•1.00	<ul style="list-style-type: none"> <li>• Dept. 01 is programmed as taxable 1 and PLU 0001 is programmed as taxable 2.</li> <li>• Printing breakdowns of those taxes.</li> </ul>
	Taxable status	1 (preset)	
Item 2	PLU 0001	•2.00 (preset)	
	Taxable status	2 (preset)	
Payment	Cash	•3.00	

Step	Operation	Printout
<b>1</b> Register the item 1.	<b>1</b> <b>00</b> <b>1</b>	<pre> 1 DEPT001   T1   ·1.00 1 PLU0001   T2   ·2.00   TA1                ·0.90   TX1                ·0.10   TA2                ·1.90   TX2                ·0.10   TL                - 3.00   CASH                ·3.00           </pre>
<b>2</b> Register the item 2	<b>1</b> <b>PLU</b>	
<b>3</b> Press <b>VAT</b> key to print breakdowns of taxes.	<b>VAT</b>	
<b>4</b> Press <b>CA/AMT/TEND</b> key to finalize the transaction.	<b>CA/AMT/TEND</b>	

# Advanced programmings and registrations

## ■ Age verification

This function prohibits to register items if the customer is under the preprogrammed age. Please note that you need to allocate <Age verification> function to a key. See page E-113.

### Sample operation

Item 1	Dept. 01	•1.00	<ul style="list-style-type: none"> <li>• Item 1's age limitation is 18 and item 2's age limitation is 20.</li> <li>• Customer's age is 18 so he or she is able to purchase the item 1 but not the item 2.</li> </ul>
	Quantity	1	
	Age limitation.	18	
Item 2	Dept. 03	•2.00	
	Quantity	1	
	Age limitation.	20	
Payment	Cash	•1.00	
Customer's birth date: May 03, 1995			
Present date: April 03, 2013			

### Step

### Operation

### Printout

**1** Register the item 1. The display shows "PLEASE ENTER BIRTHDATE". The item 1 is not registered yet.

**1** 00

**2** Enter the customer's birth date.

**0** **5** **0** **3**

**1** **9** **9** **5**

<Age verification>

**3** Register the item 1. The item is registered.

**1** 00

**4** Register item 2. The display shows "AGE DOES NOT PERMIT PRODUCT PURCHASE" and you cannot register the item.

**2** 00

**5** Finalize the transaction.

CA/AMT  
TEND

1	DEPT001	T1	•1.00
1	PLU0001	T2	•2.00
	TA1		•0.90
	TX1		•0.10
	TA2		•1.90
	TX2		•0.10
	TL		- 3.00
	CASH		•3.00

# Advanced programmings and registrations

## ■ Check tracking system

Check tracking system holds (temporarily finalize) a check and you can add orders later on.

Held check is cleared when the guest check receipt is finalized and printed, when new/old check operation is performed, or when the same check number is assigned.

• For <NEW CHECK>

Re-input the correct check number, or cancel the original check number, issue a receipt, then re-input the correct check number.

• For <OLD CHECK>, <NEW/OLD>

Temporarily finalize the original check number, issue a receipt, then re-input the correct check number.

## ■ Opening a check

### Sample operation

Check number		1234	Taking new order with check number 1234.
Item 1	Dept. 01	•10.00	
	Quantity	2	
Item 2	Dept. 02	•20.00	
	Quantity	2	
Item 3	Dept. 03	•30.00	
	Quantity	1	

### Step

### Operation

### Printout

**1** Input the check number and press <New check> key.

**1** **2** **3** **4**  
<New check>

**2** Register the ordered items.

**1** **0** **00** **1** **1**  
**2** **0** **00** **2** **2**  
**3** **0** **00** **3**

**3** Press **NB** key to close the check temporarily. If you wish to finalize the check immediately, use the transaction keys such as **CA/AMT/TEND** or **CHK** keys.

**NB**

```

CHECK No. 1234
1 DEPT001      · 10.00
1 DEPT001      · 10.00
1 DEPT002      · 20.00
1 DEPT002      · 20.00
1 DEPT003      · 30.00
SRVC TL       - 90.00
    
```

# Advanced programmings and registrations

## ■ Adding orders to a held check

### Sample operation

Check number		1234	Taking additional orders on the check number 1234.
Item 1	Dept. 01	•30.00	
	Quantity	1	
Item 2	Dept. 02	•10.00	
	Quantity	1	

### Step

### Operation

### Printout

- 1 Input the check number and press <Old check> key.
- 2 Register the additionally ordered items.
- 3 Press **NB** key to close the check temporarily. If you wish to finalize the check immediately, use the transaction keys such as **CA/AMT/TEND** or **CHK** keys.

**1 2 3 4**  
 <Old check>  
**3 0 00** **1**  
**1 0 00** **2**  
**NB**

```

                                CT    1
CHECK No. 1234

ST                               ·90.00
1 DEPT001                         ·30.00
1 DEPT002                         ·10.00
SRVC TL
                                - 130.00
    
```

## ■ Issuing a guest check

Guest check shows the balance of a held (not finalized) check.

### Step

### Operation

### Printout

- 1 Input the check number and press **GUEST/POST/RECEIPT** key.



**1 2 3 4** **GUEST/POST/RECEIPT**

```

                                CT    1
CHECK No. 1234
1 DEPT001                         ·10.00
1 DEPT001                         ·10.00
1 DEPT002                         ·20.00
1 DEPT002                         ·20.00
1 DEPT003                         ·30.00
1 DEPT001                         ·30.00
1 DEPT002                         ·10.00
SRVC TL
                                - 130.00
    
```

# Advanced programmings and registrations

## ■ Closing a held check

Step	Operation	Printout
1 Input the check number and press <Old check> key.	<b>1 2 3 4</b> <Old check>	<div style="border: 1px solid black; padding: 5px;"> <p style="text-align: right;">CT 1</p> <p>CHECK No. <b>1234</b></p> <p>ST . 130.00</p> <p>TL - <b>130.00</b></p> <p>CASH . 150.00</p> <p>CG . 20.00</p> </div>
2 Enter tendered amount and press  key to close the check.	<b>1 5 0 00</b> 	

## ■ About key

The  key works as the same function as <New check> when a new check is opened with a check number which the same number is not existed.





When a check number is entered and if there is a held check with the same number, the  button works as the same function as <Old check> key.

## ■ Adding checks together

Using <Add check> key, you can add two or more held checks together.

### Sample operation

Check 1	Check No.	1234	Putting check numbers 1234 and 3456 together.
	Subtotal	•20.00	
Check 2	Check No.	3456	
	Subtotal	•30.00	

Step	Operation	Printout
1 Input the check number and press <Old check> key.	<b>1 2 3 4</b> <Old check>	<div style="border: 1px solid black; padding: 5px;"> <p style="text-align: right;">CT 1</p> <p>CHECK No. <b>1234</b></p> <p>ST . 20.00</p> <p>ADD CHK 3456</p> <p>ST . 30.00</p> <p>SRVC TL - <b>50.00</b></p> </div>
2 Input the number of adding check and press <Add check> key.	<b>3 4 5 6</b> <Add check>	
3 Press  key to close the check temporarily. If you wish to finalize the check immediately, use the transaction keys such as  or  keys.		

# Advanced programmings and registrations

## ■ About Flat PLU

If <Flat PLU> keys are allocated on the keyboard, you can use them as the same function as department keys.

Instead of using department keys  ....., use flat PLU keys  ..... and use  key instead of <Dept. no./Dept. shift> key.

## ■ Text recall

If <Text recall> key is allocated, you can recall a stored text and print it on receipts or journals.

### Sample operation

Check 1	Check No.	1234	Putting check numbers 1234 and 3456 together.
	Subtotal	•20.00	
Check 2	Check No.	3456	
	Subtotal	•30.00	

Step	Operation	Printout
<b>1</b> Register the item 1.	<input type="text" value="4"/> <input type="text" value="6"/> <input type="text" value="00"/> <input type="text" value="1"/>	<pre> CT                3 1 DEPT001         ·46.00 MEDIUM SIZE 1 DEPT002         ·10.00 SMALL SIZE TL                ·56.00 CASH              ·56.00                     </pre>
<b>2</b> Recall text 1.	<input type="text" value="1"/> <Text recal>	
<b>3</b> Register the item 2.	<input type="text" value="1"/> <input type="text" value="0"/> <input type="text" value="00"/> <input type="text" value="2"/>	
<b>4</b> Recall text 2.	<input type="text" value="2"/> <Text recal>	
<b>5</b> Finalize the transaction.	<input type="text" value="SUB TOTAL"/> <input type="text" value="CA / AMT / TEND"/>	

## ■ Inputting number of customers

If <Customer number> function is allocated on the keyboard, you can print the number of customers.

### Sample operation

Item 1	Unit price	•15.00	Printing number of customers on a receipt/journal.
	Dept.	01	
Item 2	Unit price	•5.00	
	Dept.	02	
Number of customers		2	
Payment	Cash	•20.00	

Step	Operation	Printout
<b>1</b> Input the number of customers and press <Customer number> key.	<input type="text" value="2"/> <Customer number>	<pre> CT                2 1 DEPT001         ·15.00 1 DEPT002         ·5.00 TL                ·20.00 CASH              ·20.00                     </pre>
<b>2</b> Register the items.	<input type="text" value="1"/> <input type="text" value="5"/> <input type="text" value="00"/> <input type="text" value="1"/> <input type="text" value="5"/> <input type="text" value="00"/> <input type="text" value="2"/>	
<b>3</b> Press <input type="text" value="SUB TOTAL"/> key.	<input type="text" value="SUB TOTAL"/>	
<b>4</b> Finalize the transaction.	<input type="text" value="CA / AMT / TEND"/>	

# Advanced programmings and registrations

## ■ About clerk interrupt function

There are two types of clerk interrupt function, PROCEDURE 1 and PROCEDURE 2 illustrated below.

In PROCEDURE 1, each clerk has a unique clerk interrupt buffer (memory), and the clerk interrupt function gives each individual clerk the ability to perform an independent registration operations. In this case, each clerk is individually linked to a unique clerk interrupt buffer.

In PROCEDURE 2, multiple clerks use the same clerk interrupt buffer, and single clerk interrupt operation (clerk change during registration) can be performed even when any registration is in progress. In this case, multiple clerks are linked to a single clerk interrupt buffer.

In the REG and RF modes, clerks can be changed while a transaction is in progress so that multiple clerks can operate single register simultaneously. For example, if clerk 1 is registering a transaction, clerk 2 can use the same machine to register a different transaction. Clerk 1 can continue the original registration from the interrupted point.

### PROCEDURE 1

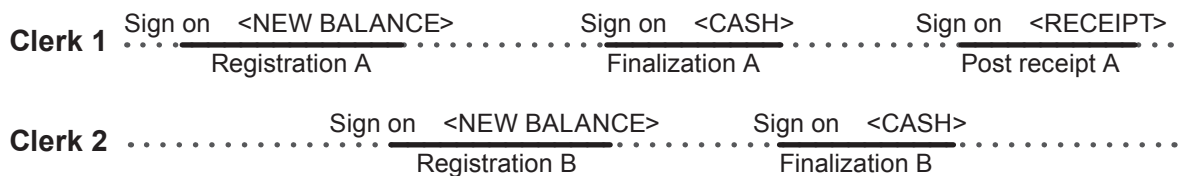

### PROCEDURE 2

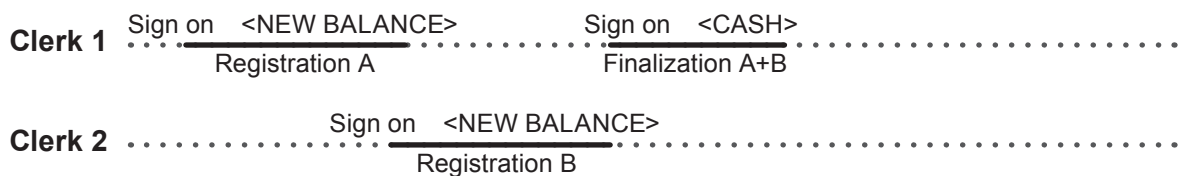

#### NOTE

- The register must be programmed to allow the clerk interrupt function.
- You cannot use the clerk interrupt function on a register together with the check tracking system.

# Advanced programmings and registrations

## ■ Condiment/preparation PLUs

By programming, you can force the register to input condiment PLU or preparation PLU together with main PLU. For the programming, please see pages E-99 and E-100.

### Sample operation 1

Main PLU	PLU0001	•10.00	Registering main PLU0001 with condiment PLUs 0011, 0012, and 0013..
Condiment PLUs	PLU0011	•0.10	
	PLU0012	•0.20	
	PLU0013	•0.30	
Payment	Cash	•10.60	

Step	Operation	Printout
<b>1</b> Register the main PLU item.	<b>1</b> <input type="button" value="PLU"/>	<pre> 1  PLU0001      · 10.00    PLU0011     ·  0.10    PLU0012     ·  0.20    PLU0013     ·  0.30    TL          · 10.60    CASH        · 10.60                 </pre>
<b>2</b> Register condiment PLUs. If a condiment PLU is not registered, an error occurs.	<b>1</b> <b>1</b> <input type="button" value="PLU"/> <b>1</b> <b>2</b> <input type="button" value="PLU"/> <b>1</b> <b>3</b> <input type="button" value="PLU"/>	
<b>3</b> Finalize the transaction.	<input type="button" value="CA / AMT / TEND"/>	

### Sample operation 2

Main PLU	PLU0020	•20.00	Registering main PLU0020 with condiment PLUs 0021, 0022, and 0023.
Condiment PLUs	PLU0021	•0.00	
	PLU0022	•0.00	
	PLU0023	•0.00	
Payment	Cash	•20.00	

Step	Operation	Printout
<b>1</b> Register the main PLU item.	<b>2</b> <b>0</b> <input type="button" value="PLU"/>	<pre> 1  PLU0020      · 20.00    PLU0021    PLU0022    PLU0023    TL          · 20.00    CASH        · 20.00                 </pre>
<b>2</b> Register preparation PLUs. If a preparation PLU is not registered, an error occurs.	<b>2</b> <b>1</b> <input type="button" value="PLU"/> <b>2</b> <b>2</b> <input type="button" value="PLU"/> <b>2</b> <b>3</b> <input type="button" value="PLU"/>	
<b>3</b> Finalize the transaction.	<input type="button" value="CA / AMT / TEND"/>	



# Advanced programmings and registrations

## ■ Set menu

When a set menu is registered, the register stores the sales data of the menu but also stores sales data (amount, quantity) of items in the set in respective PLU memory.

### Sample operation

Set menu	PLU0035	•5.00	Registering a set menu. Items in the set will be registered in the respective PLU automatically.
Items in the set	PLU0001	-	
	PLU0002	-	
	PLU0003	-	
	PLU0004	-	
Payment	Cash	•5.00	

Step	Operation	Printout
<b>1</b> Register the set menu.	<b>3</b> <b>5</b> <b>PLU</b>	<pre> 1 PLU0035          · 5.00   PLU0001   PLU0002   PLU0003   PLU0004   TL                · 5.00   CASH              · 5.00                     </pre>
<b>2</b> Finalize the transaction.	<b>CA/AMT</b> <b>TEND</b>	

## ■ Tips

By usein allocated <Tips> key, you can register and print the amount of tips.

### Sample operation

Item 1	Unit price	•3.00	A customer gave •0.80 tip to the clerk.
	Dept.	01	
Item 2	Unit price	•5.00	
	Dept.	02	
Tip		•0.80	
Payment	Cash	•10.00	

Step	Operation	Printout
<b>1</b> Register items.	<b>3</b> <b>00</b> <b>1</b> <b>5</b> <b>00</b> <b>2</b>	<pre> 1 DEPT001          · 3.00 1 DEPT002          · 5.00   TIP              · 0.80   TL               · 8.80   CASH            · 10.00   CG              · 1.20                     </pre>
<b>2</b> Press <b>SUB TOTAL</b> key.	<b>SUB TOTAL</b>	
<b>3</b> Input the amount of the tip..	<b>8</b> <b>0</b> <b>&lt;Tips&gt;</b>	
<b>4</b> Finalize the transaction.	<b>CA/AMT</b> <b>TEND</b>	

# Advanced programmings and registrations

## ■ Registrations with <Arrangement> key

By using allocated <Arrangement> key, the register performs programmed functions automatically.

### Sample operation 1

Arrangement 1			Arrangement 1 is programmed as selling one PLU0001 (•8.00 preset) and PLU0002 (•5.00 preset) and paid in exact amount of cash.
Item 1	PLU0001	•8.00 (preset)	
	Quantity	1	
Item 2	PLU0002	•5.00 (preset)	
	Quantity	1	
Payment	Cash	•13.00	

Step	Operation	Printout
------	-----------	----------

**1** Just press <Arrangement> key.      <Arrangement>

1	PLU0001	•8.00
1	PLU0002	•5.00
	TL	- 13.00
	CASH	•13.00

### Sample operation 2

Arrangement 5			Arrangement 5 is programmed as selling one Dept. 01 item with •1.00, one Dept. 02 item with •2.00 and paid in exact amount of cash..
Item 1	PLU0001	•1.00	
	Quantity	1	
Item 2	PLU0002	•2.00	
	Quantity	1	
Payment	Cash	•3.00	

Step	Operation	Printout
------	-----------	----------

**1** Enter arrangement number and press <Arrangement> key.      **5** <Arrangement>

1	DEPT001	•1.00
1	DEPT002	•2.00
	TL	- 3.00
	CASH	•3.00



# Advanced programmings and registrations

## ■ To add a certain amount

By using allocated <Addition (plus)> key, you can add a certain amount on a transaction.

### Sample operation

Item 1	Dept. 01	•1.00	<ul style="list-style-type: none"> <li>• Adding •0.10 to the item 1.</li> <li>• Adding 3 × •0.20 (preset amount) to item 2.</li> </ul>
	Quantity	1	
	Add	•0.10	
Item 2	Dept. 01	•2.00	
	Quantity	3	
	Add	3 × •0.20 (preset)	
Payment	Cash	•7.70	

Step	Operation	Printout
<b>1</b> Register the item 1.	<b>1</b> <b>00</b> <b>1</b>	<pre> 1 DEPT001      - 1.00 +              - 0.10 3 DEPT001      - 6.00 +              - 0.60 TL              - 7.70 CASH           - 7.70                     </pre>
<b>2</b> Enter the adding amount and press <Addition> key.	<b>1</b> <b>0</b> <Addition>	
<b>3</b> Register the item 2.	<b>3</b>  <b>2</b> <b>00</b> <b>1</b>	
<b>4</b> Enter the adding amount using multiplication key and press <Addition> key.	<b>3</b>  <Addition>	
<b>5</b> Finalize the transaction.		

# Advanced programmings and registrations

## ■ To transact in Euro

By using **PD** key, the register allows you to register items in the local currency and transact in Euro or vice versa. To set the currency rate between Euro and local currency, please see page E-93.

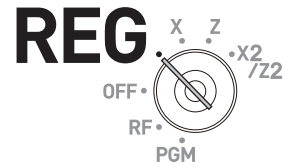

### Sample Operation 1

Item	Unit price	•6.00	Main currency: Local Sub currency: Euro A •6.00 item is sold and the customer paid in Euro.
	Quantity	1	
	Dept.	01	
Exchange rate		€1.00 = •0.50	
Payment		€15.00	

Step	Operation	Printout
<b>1</b> Register the item in local currency.	<b>6 00</b> <b>1</b>	<pre> 1 DEPT001  T1  •6.00   TL          - 6.00               (€12.00)  EURO money CASH          €15.00 CASH          (•7.50) CG            •1.50               (€3.00)                     </pre>
<b>2</b> Press <b>PO</b> key. The register calculates the price in Euro.	<b>PO</b>	
<b>3</b> Press <b>SUB TOTAL</b> key to indicate the price in Euro.	<b>SUB TOTAL</b>	
<b>4</b> Press <b>PO</b> key before entering tendered amount in Euro.	<b>PO</b>	
<b>5</b> Enter the tendered amount in Euro.	<b>1 5 00</b>	
<b>6</b> Press <b>CA/AMT /TEND</b> key. The display indicates the change in local currency.	<b>CA/AMT /TEND</b>	

# Advanced programmings and registrations

## Sample Operation 2

Item	Unit price	€12.00	Main currency: Euro Sub currency: Local A €12.00 item is sold and the customer paid in local currency.
	Quantity	1	
	Dept.	01	
Exchange rate	•1.00 = €2.00		
Payment		•10.00	

Step	Operation	Printout
<b>1</b> Register the item in Euro.	<b>1</b> <b>2</b> <b>00</b> <b>1</b>	<pre> 1 DEPT001      €12.00   TL           €12.00               (·6.00)  LOCAL money CASH          ·10.00 CASH          (€20.00) CG            €8.00               (·4.00)                     </pre>
<b>2</b> Press <b>PO</b> key. The register calculates the price in local currency.	<b>PO</b>	
<b>3</b> Press <b>SUB TOTAL</b> key to indicate the price in local currency.	<b>SUB TOTAL</b>	
<b>4</b> Press <b>PO</b> key before entering tendered amount in local currency.	<b>PO</b>	
<b>5</b> Enter the tendered amount in local currency.	<b>1</b> <b>0</b> <b>00</b>	
<b>6</b> Press <b>CA / AMT / TEND</b> key. The display indicates the change in Euro.	<b>CA / AMT / TEND</b>	

# Advanced programmings and registrations

## Character settings

This chapter explains how you can program department or PLU descriptions, store messages, key descriptions, report title, total descriptions (such as gross total, net total etc.) and clerk names.

There are two ways to program characters which are using character keyboard and using multi typing of ten key.

### Using character keyboard

#### ■ Character keyboard

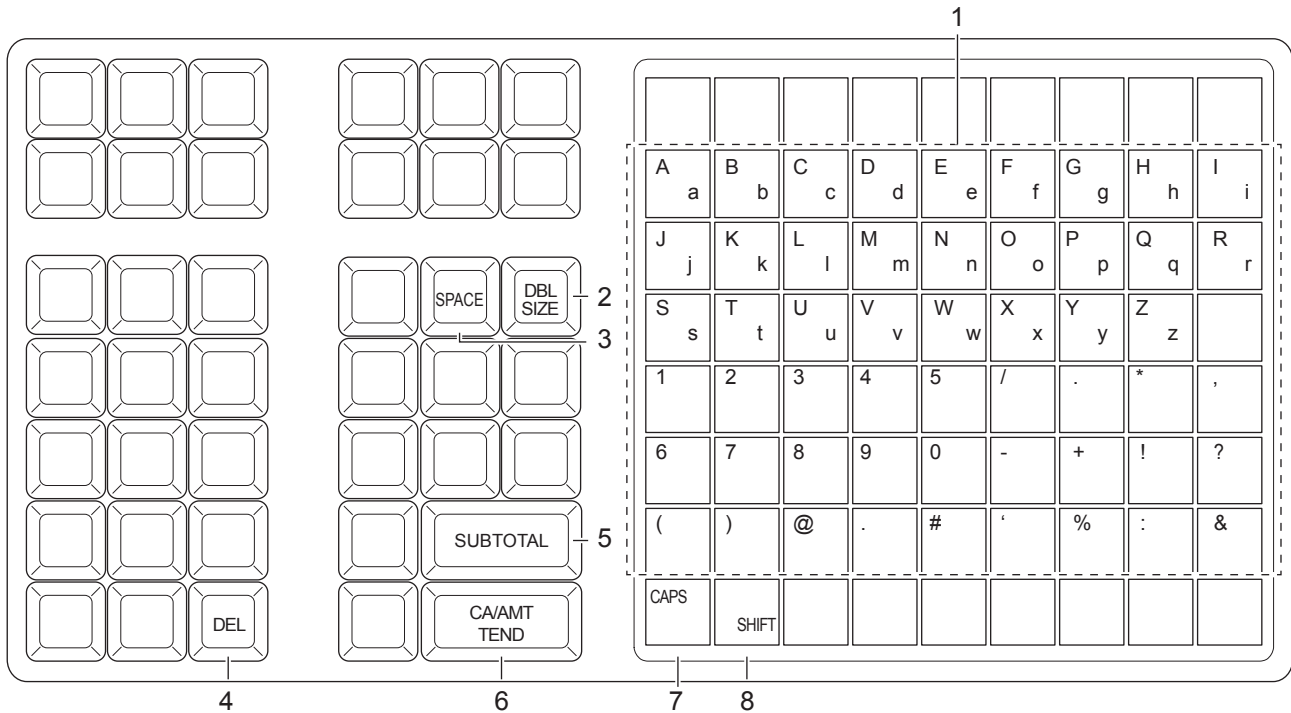

- |  |   |
|--|---|
| <p>1 <b>Alphabet keys</b></p> <p>2 <b>Double size letter key</b></p> <p>3 <b>Space key</b></p> <p>4 <b>Delete key</b></p> <p>5 <b>Program end key</b></p> <p>6 <b>Character enter key</b></p> <p>7 <b>CAPS key</b></p> <p>8 <b>Shift key</b></p> | <p>Used to input characters.</p> <p>Assigns the next input character to be double sized. After setting a double sized character, press this key again to back to normal size.</p> <p>Sets a space.</p> <p>Clears the last input character.</p> <p>Terminates the character programming.</p> <p>Registers the programmed characters.</p> <p>Pressing this key shifts a character from the lowercase letter to upper case letter.</p> <p>Pressing this key shifts the character from the uppercase letter to lower case letter.</p> |
|--|---|

**Example:** To set "Apple Juice"

**A**                      **p p l e**                      **J**                      **u i c e**  
 <DBL> <A> <DBL> <Shift> <p> <p> <l> <e> <Space> <CAPS> <J> <Shift> <u> <i> <c> <e> .

# Advanced programmings and registrations

## Using ten key pad

To set characters by using ten key, you need to press one of the ten key repeatedly until desired character appears on the display.

### ■ Multi typing keyboard

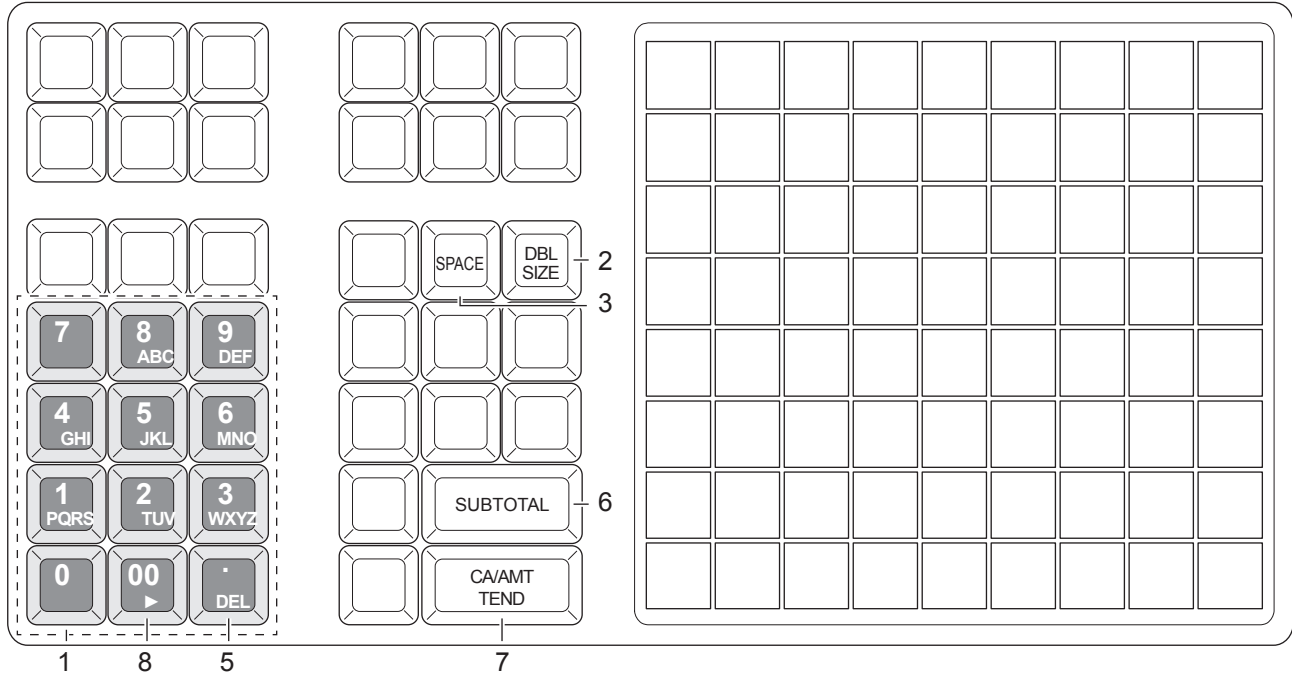

#### 1 Alphabet keys

Hitting one of those keys repeatedly changes characters in the order shown in the table below.

<b>8</b>	A → B → C → a → b → c → 8 → Ä → Å → Æ → Á → Â → Æ → Æ → Ç → â → ä → à → â → æ → á → ã → ç returns to the beginning
<b>9</b>	D → E → F → d → e → f → 9 → Đ → É → Ê → Ë → È → ħ → é → ê → ë → è → f returns to the beginning
<b>4</b>	G → H → I → g → h → i → 4 → Í → Î → Ï → I → Ì → Î → Î → î → ï → í → í returns to the beginning
<b>5</b>	J → K → L → j → k → l → 5 returns to the beginning
<b>6</b>	M → N → O → m → n → o → 6 → Ñ → Ö → ø → Ó → Ô → Ò → Õ → ñ → ô → ö → ò → ø → ó → õ returns to the beginning
<b>1</b>	P → Q → R → S → p → q → r → s → 1 → Þ → þ → ß returns to the beginning
<b>2</b>	T → U → V → t → u → v → 2 → TEL → Ü → Ú → Û → Ù → ü → û → ù → ú → μ returns to the beginning
<b>3</b>	W → X → Y → Z → w → x → y → z → 3 → Ÿ → ŷ → ŷ returns to the beginning
<b>0</b>	0
<b>00</b>	(Right cursor)
<b>.</b>	(Delete)
<b>7</b>	7 → @ → - → / → : → ! → ? → ~ → ( → ) → * → # → + → , → ^ → ; → < → → = → > → \$ → ¥ → % & → [ → ] → ' → { →   → } → • → “ → . → \ → _ → ` → £ → x → ç → i → € → \$ → space returns to the beginning

# Advanced programmings and registrations

- 2 **Double size letter key** Assigns the next input character to be double sized. After setting a double sized character, press this key again for normal size.
- 3 **Space key** Sets a space.
- 4 **Clear key** Clears all the characters.
- 5 **Delete key** Clears the last input character.
- 6 **Program end key** Terminates the character programming.
- 7 **Character enter key** Registers the programmed characters.
- 8 **Right cursor key** Moves the cursor to the right.

**Example:** To set **C**LASS a



C            L            A            S                    S                            a

<DBL> 8 8 8 5 5 5 <DBL> 8 1 1 1 1 00 1 1 1 1 <Space> 8 8 8 8



# Advanced programmings and registrations

## Setting characters

The following explanation shows how you can set a name in a PLU. You can also set names to departments, function keys ( ,  ), and clerks by the same method.

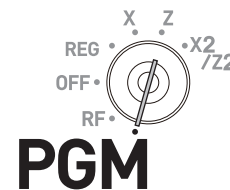





### Sample Operation



To set "MILK" to PLU0001 by using ten key pad.

#### Step

**1** Turn the Mode switch to PGM position. The display shows the program top menu.

**2** Using  or  keys, select [PLU Setting] and press  key.

Enter the PLU number in which you wish to set characters and press  key.

**3** On the next screen, make sure that the PLU number you wish to set is selected. If you wish to change it, use  or  keys.

Press  key.

**4** Select the top column of the [PLU Setting screen] and input the character you wish to set. In this example, **6 4 4 4 5 5 5 00 5 5** (for MILK). Then press  key to complete the setting.

#### Display

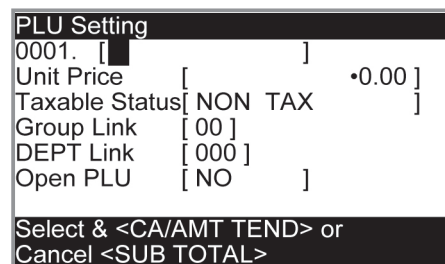
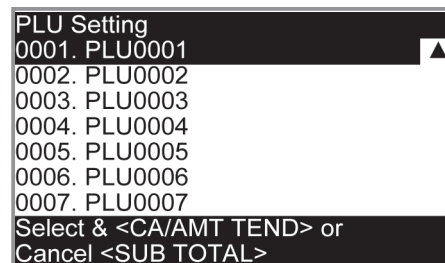
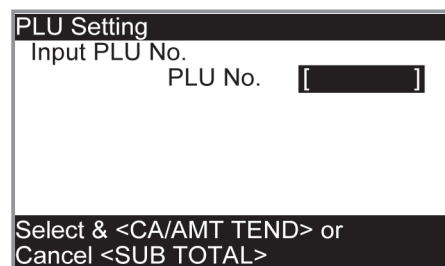
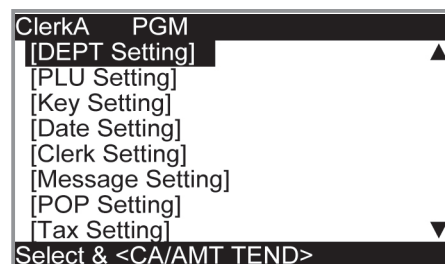

# Advanced programmings and registrations

## Setting pop messages on receipts

You can set pop messages printed on receipts.



- 1 Pop message 1st. line
- 2 Pop message 2nd. line
- 3 Pop message 3rd. line
- 4 Pop message 4th. line
- 5 Pop illustration

### ■ To set pop message

#### Step

**1** Turn the Mode switch to PGM position and select [POP Setting] then press  key.

**2** Select [All Message] and press  key. Preset messages will be printed.

**3** Select the line number of the pop message and press  key.

**4** Referring printed preset messages, input the message number you wish to set and press  key.

**5** Repeat the steps 3 and 4 for other message lines.

### ■ To set other messages

To set logo message, commercial message, and bottom message (refer to page E-24 "Receipt sample"), perform the same procedure as the above operations except selecting [Message Setting] in step 1.



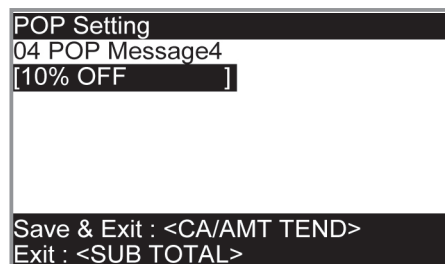
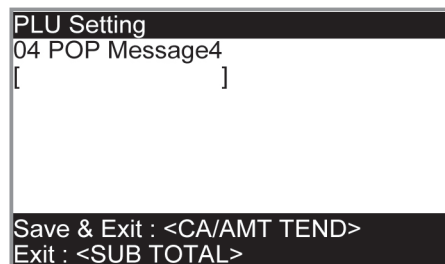
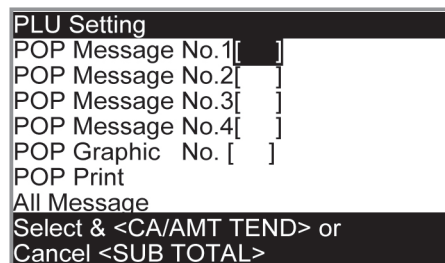

#### Display



# Advanced programmings and registrations

## ■ To set pop illustration

### Step

- 1 Turn the Mode switch to PGM position and select [POP Setting] then press  key.
- 2 Select [All Graphic] and press  key. The printer prints preset pop illustrations.
- 3 From the printout, select an illustration you wish to print on receipts.
- 4 Select [Print Graphic No. [ ] ] and input the illustration number from ten key pad. Then press  key.
- 5 Select [POP Print] and press  key. Make sure that the illustration you select comes out from the printer.

### Display

```
PLU Setting
POP Message No.1[ ]
POP Message No.2[ ]
POP Message No.3[ ]
POP Message No.4[ ]
POP Graphic No. [ ]
POP Print
All Message
Select & <CA/AMT TEND> or
Cancel <SUB TOTAL>
```

```
POP Setting
POP Message No.2 [ ]
POP Message No.3 [ ]
POP Message No.4 [ ]
POP Graphic No. [ ]
POP Print
All Message
All Graphic
Select & <CA/AMT TEND> or
Cancel <SUB TOTAL>
```

```
POP Setting
POP Message No.1[ ]
POP Message No.2[ ]
POP Message No.3[ ]
POP Message No.4[ ]
POP Graphic No.[ ]
POP Print
All Message
Select & <CA/AMT TEND> or
Cancel <SUB TOTAL>
```

```
POP Setting
POP Message No.1[ ]
POP Message No.2[ ]
POP Message No.3[ ]
POP Message No.4[ ]
POP Graphic No. [ ]
POP Print
All Message
Select & <CA/AMT TEND> or
Cancel <SUB TOTAL>
```

# Advanced programmings and registrations

## Setting symbol characters

You can change the symbols or titles of sales reports for example, printing “CASH IN DRW” on the sales reports instead of “CAID” for cash amount in drawer.

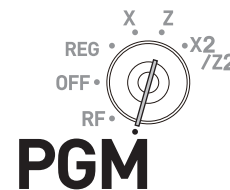

Step	Operation
<p><b>1</b> Turn the Mode switch to PGM position and select [System Setting] then press  key.</p> <p>[System Setting] is the last column on the programming top menu and is not shown on the first screen. Keep pressing  key until it appears on the screen.</p>	.....
<p><b>2</b> Enter  and press  key to set the register in the character setting mode.</p>	
<p><b>3</b> Referring the following tables, enter two-digit memory number and program code. Then press  key.</p>	 [Memory No.](Program code)
<p><b>4</b> Referring the character entry methods on pages E-74 and E-75, input characters you wish to set and press  key.</p>	.....  (Character keys)
<p><b>5</b> If you wish to set in the next memory number, repeat step 4. If you wish to set other memory number than the next number, repeat steps 3 and 4.</p>	
<p><b>6</b> Press  key to complete the setting.</p>	

**Example:** To set “CASH IN DRW” in memory number 3

Press [C][A][S][H][SPACE][I][N][SPACE][D][R][W]



# Advanced programmings and registrations

## Other symbols

Numbers in ( ) are digits to be used.

Memory No.	Program code	Contents	Default character
01	23	main currency symbol (2), @ (2), No.(2), split pricing (2), not used (4), sub currency symbol (2)	· @ N o / * *
02		No. of item sold (2), No. of customers (2), not used (6), multiplication display(2)	N o C T @ L B * Q T
03		multiplication symbol (6), not used (6)	X B U S Y
04		taxable symbols (3 each)	T 1 T 1 T 3 T 4 T 5
06		taxable symbols (3 each)	T 1 2 T 1 3 T 1 4 T 2 3
08		foreign currency (2 each) not used (8)	* * * * *
09		mode symbols (4 each) (REG, RF, not used)	R E G R F R
10		mode symbols (4 each) (PGM, Daily X, Daily Z, Periodic)	P X Z X Z
11		mode symbols (4 each) (not used, PGM read)	T R G P G M X
12		decimal (1) (for amount/ q'ty), separator (main/ sub 1 each), not used (3), square (7)	· · · · · , X
13		am, pm (3each) ST symbol on main display (2)	A M P M S T
16		subtotal symbol on main display (16)	S T
17		subtotal symbol for discount/premium (16)	S T
18		post receipt total symbol (16)	T L
19		change symbol (16)	C G
01		20	grand total symbol (16)

## Title of sales reports

Memory No.	Program code	Contents	Default character	Memo for your settings
01	24	Fixed total report title	FIX	
02		Transaction key report title	TRANS	
03		PLU sales report title	PLU	
04		Department sales report title	DEPT	
05		Group sales report title	GROUP	
06		Clerk sales report title	CASHIER	
08		Hourly sales report title	HOURLY	
09		Monthly sales report title	MONTHLY	
16		Flash report title	FLASH	

## Text recall character

Memory No.	Program code	Contents	Default character	Memo for your settings
01	39	Text recall character 01		
02		Text recall character 02		
03		Text recall character 03		
04		Text recall character 04		

# Advanced programmings and registrations

## Advanced programmings

This section explains how you can program detail settings of the register such as setting register's specific number, whether to reset consecutive number on the receipt after a Reset (Z) report or not, whether to print taxable amounts on receipts or not, etc.

The following table lists what can be programmed in this settings.

Set code	Settings	No. of digit to be set
02	Cash register's unit number	4
03	Whether to reset consecutive number after Reset (Z) report or not	8
04	Tax and rounding systems	10
05	Contents of receipt/journal print	10
06	Calculation and operation methods	10
08	Contents of sales reports	10
10	Whether to print taxable amount or not	10
14	Printing of period or comma for decimal and separator on fixed total report print	8
15	Printing methods of sales reports	10
16	Printing methods of grand total	7
17	Date/time printing on journals/receipts	4
19	Double height character printing on receipts	7
21	Printing methods of messages	10
27	Clerk operation selections	9
28	Euro settings 1	10
29	Euro settings 2	10
30	Receipt message/Compressed journal print selection	5
34	Backlight on/off selection	4

# Advanced programmings and registrations

## Programming detail settings

To program the detail settings of the register, please follow the operations shown below.

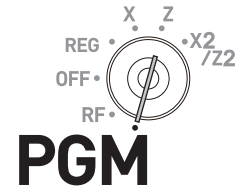

Step	Operation
<p><b>1</b> Turn the Mode switch to PGM position and select [System Setting] then press <input type="button" value="CA/AMT/TEND"/> key.</p> <p>[System Setting] is the last column on the programming top menu and is not shown on the first screen. Keep pressing <input type="button" value="↓"/> key until it appears on the screen.</p>	<p><input type="button" value="↓"/> ..... <input type="button" value="↓"/> <input type="button" value="CA/AMT/TEND"/></p>
<p><b>2</b> Enter <b>3</b> and press <input type="button" value="SUB TOTAL"/> key to set the register in the programming mode.</p>	<p><b>3</b> <input type="button" value="SUB TOTAL"/></p>
<p><b>3</b> Referring the following tables, enter two-digit set code you wish to program followed by two 2s. "22" is the identification code for programming detail settings.</p>	<p><input type="text"/> <input type="text"/> <b>2 2</b> [set code] For example, if you wish to program tax system:</p> <p><b>0 4 2 2</b></p>
<p><b>4</b> Referring the tables below, enter program code of up to 10 digits and press <input type="button" value="CA/AMT/TEND"/> key.</p>	<p><input type="text"/> <input type="text"/> ..... <input type="text"/> <input type="text"/> <input type="button" value="CA/AMT/TEND"/> [Program code (up to 10 digits)]</p>
<p><b>5</b> Press <input type="button" value="SUB TOTAL"/> key to complete the program.</p>	<p><input type="button" value="SUB TOTAL"/></p>

### Set code 02 (Machine number)

Description	Selection	Program code	Default value
Machine number	Machine number	<input type="text"/> <input type="text"/> <input type="text"/> <input type="text"/> D4 D3 D2 D1	<input type="text"/> <input type="text"/> <input type="text"/> <input type="text"/> D4 D3 D2 D1

**Example:** To set the register's specific unit number 1234.

Press **3**  **0 2 2 2**  **1 2 3 4**

### Set code 03 (Whether to reset consecutive number after Reset (Z) report or not)

Description	Selection	Program code	Default value
Reset consecutive number after daily reset report is issued.	Yes = 0 No = 1	<input type="text"/> D8	<input type="text"/> D8
Must be "0000000" (seven zeros)		<input type="text"/> to <input type="text"/> D7 to D1	<input type="text"/> to <input type="text"/> D7 to D1

**Example:** Not resetting the consecutive number after Z report printing.

Press **3**  **0 3 2 2**  **1 0 0 0 0 0 0 0**



# Advanced programmings and registrations

## Set code 04 (Tax and rounding systems)

Description	Selection	Program code	Initial value
Apply rounding for registration: No rounding = 0, IF1 = 1, IF2 = 2, Danish = 3, Singaporean = 5, Finnish = 6, Australian = 7, South African = 8, Other roundings = 9 (Refer to D1) See the following tables for IF1 and IF2	0 to 9	<input type="checkbox"/> D10	<input type="checkbox"/> D10
Tax system: Single tax system (1 ~ 4) = 0, Singaporean tax system = 3	0 or 3	<input type="checkbox"/> D9	<input type="checkbox"/> D9
Must be "0000000"		<input type="checkbox"/> <input type="checkbox"/> D8 to D2	<input type="checkbox"/> <input type="checkbox"/> D8 to D2
Other rounding: New Zealander (A) = 0, New Zealander (B) = 1, Malaysian = 2, Norwegian/Czech = 3 (D10 must be set to "9".)	0 to 3	<input type="checkbox"/> D1	<input type="checkbox"/> D1

## Rounding systems for each country

IF 1 rounding	
Last digit of ST	Result
0 to 2	0
3 to 7	5
8 to 9	10

Australian rounding	
Last digit of ST/CA CG	Result
0 to 2	0
3 to 7	5
8 to 9	10

IF 2 rounding	
Last digit of ST	Result
0 to 4	0
5 to 9	10

South African rounding	
Last digit of ST	Result
0 to 4	0
5 to 9	5

Danish rounding	
Last 2 digits of ST/CA CG	Result
00 to 24	00
25 to 74	50
75 to 99	100

New Zealander (A/B) rounding	
Last digit of ST/CA CG	Result
0 to 4/5	0
5/6 to 9	10

Singaporean rounding	
Last digit of item, %- REG	Result
0 to 2	0
3 to 7	5
8 to 9	10

Malaysian rounding	
Last digit of ST/ CA CG	Result
0 to 2	0
3 to 7	5
8 to 9	10

Finnish rounding	
Last digit of ST/CA CG	Result
0 to 2	0
3 to 7	5
8 to 9	10

Norwegian/Czech rounding	
Last digit of ST	Result
00 to 49	00
50 to 99	100

# Advanced programmings and registrations

## Set code 05 (Receipt printing selections)

Description	Selection	Program code	Default value
Print total line during finalization.	a Yes = 0 No = 1	<input type="checkbox"/> (a+b) D10	<input type="text" value="0"/> (a+b) D10
24- hour system (0) or 12 -hour system (2)	b Select 0 or 2		
Buffered receipt print (enables key operations during printing)	No = 0 Yes = 2	<input type="checkbox"/> D9	<input type="text" value="0"/> D9
Skip item prints on journal. (journal skip)	No = 0 Yes = 1	<input type="checkbox"/> D8	<input type="text" value="0"/> D8
Must be "000"		<input type="text" value="0"/> <input type="text" value="0"/> <input type="text" value="0"/> D7 D6 D5	<input type="text" value="0"/> <input type="text" value="0"/> <input type="text" value="0"/> D7 D6 D5
Print number of item sold. (item counter)	a No = 0 Yes = 1	<input type="checkbox"/> (a+b) D4	<input type="text" value="0"/> (a+b) D4
Print tax symbols.	b Yes = 0 No = 2		
Must be "00"		<input type="text" value="0"/> <input type="text" value="0"/> D3 D2	<input type="text" value="0"/> <input type="text" value="0"/> D3 D2
Print number of customers	Yes = 0 No = 2	<input type="checkbox"/> D1	<input type="text" value="0"/> D1

### Example:

- On a receipt, not printing total amount (a = 1), printing 12 -hour system (b = 2): D10 = 3 (1 + 2).
- Buffered receipt printing: D9 = 2.
- Not printing items on journal (journal skip): D8 = 1.
- D7 – D5 must be 000.
- Printing number of items (a = 1), not printing tax symbols (b = 2): D4 = 3 (1 + 2).
- D3 – D2 must be 00.
- Not printing number of the customers: D1 = 2.

Press **3**  **0 5 2 2**  **3 2 1 0 0 0 3 0 0 2**

# Advanced programmings and registrations

## Set code 06 (Calculation and operation methods)

Description	Selection	Program code	Default value
Succeeds the taxable status and commission status of previous item when +/- operation is performed.	a	<input type="checkbox"/> (a+b) D10	<input type="checkbox"/> 0 (a+b) D10
Force money declarations before read(X) or reset (Z) reports operations.	b	<input type="checkbox"/> (a+b+c) D9	<input type="checkbox"/> 0 (a+b+c) D9
Force to press <input type="button" value="SUB TOTAL"/> key before finalization.	a	<input type="checkbox"/> (a+b+c) D9	<input type="checkbox"/> 0 (a+b+c) D9
Allow finalization when subtotal amount is zero or minus.	b	<input type="checkbox"/> (a+b+c) D9	<input type="checkbox"/> 0 (a+b+c) D9
Allow multiple refund operation.	c	<input type="checkbox"/> (a+b+c) D9	<input type="checkbox"/> 0 (a+b+c) D9
Affects the results of +/-, %+/%- calculations to items. (Net totaling)	No = 0 Yes = 1	<input type="checkbox"/> D8	<input type="checkbox"/> 0 D8
Include commission in net total.	No = 0 Yes = 2	<input type="checkbox"/> D7	<input type="checkbox"/> 0 D7
Clears the key buffer when a receipt is issued. (REG mode only)	a	<input type="checkbox"/> (a+b+c) D6	<input type="checkbox"/> 0 (a+b+c) D6
Sounds key catch tone.	b	<input type="checkbox"/> (a+b+c) D6	<input type="checkbox"/> 0 (a+b+c) D6
Allow to issue post receipt, even the original one is issued.	c	<input type="checkbox"/> (a+b+c) D6	<input type="checkbox"/> 0 (a+b+c) D6
Must be "00"		<input type="checkbox"/> 0 <input type="checkbox"/> 0 D5 D4	<input type="checkbox"/> 0 <input type="checkbox"/> 0 D5 D4
Numeral entry of flat PLU ①: Treats as amount override ②: Treats as quantity extension	① = 0 ② = 2	<input type="checkbox"/> D3	<input type="checkbox"/> <input type="checkbox"/> D3
Must be "00"		<input type="checkbox"/> 0 <input type="checkbox"/> 0 D2 D1	<input type="checkbox"/> 0 <input type="checkbox"/> 0 D2 D1

### Example:

- A +/- operation not succeeds taxable status and commission status (a = 1), amount in drawer should be declared before Z reporting (b = 4): D10 = 5 (1 + 4).
- key must always be pressed for a finalization (a = 1), not allowing zero or minus subtotal in a transaction (b = 2), not allowing multiple refund operations (c = 4): D9 = 7 (1 + 2 + 3).
- Affecting the result of +/-, %+/%- to an item: D8 = 1.
- Not including commission in net total: D7 = 2.
- Clearing key buffer when a receipt is issued (a = 1), not sounding key catch tone (b = 2), issues post receipts even the original receipt is issued (c = 4): D6 = 7 (1 + 2 + 3).
- D5 – D4 must be 00.
- Numeral entry of flat PLU is processed as quantity. D3 = 2.
- D1 and D2 must be 00.

Press

# Advanced programmings and registrations

## Set code 08 (Fixed total print control)

Description	Selection	Program code	Default value
Print gross sales total (GROSS) on fixed total report.	a	<input type="checkbox"/> (a+b+c) D10	<input type="text" value="0"/> (a+b+c) D10
Print net sales total (NET) on fixed total report.	b		
Print cash in drawer (CAID) on fixed total report.	c		
Print charge in drawer (CHID) on fixed total report.		<input type="checkbox"/> D9	<input type="text" value="0"/> D9
Print check in drawer (CKID) on fixed total report.	a	<input type="checkbox"/> (a+b) D8	<input type="text" value="0"/> (a+b) D8
Print credit in drawer on (CRID(1) ~ (4)) on fixed total report.	b		
Must be "0"		<input type="text" value="0"/> D7	<input type="text" value="0"/> D7
Print RF mode total (RF) on fixed total report.		<input type="checkbox"/> D6	<input type="text" value="0"/> D6
Print the net number of customers (CUST) on fixed total report.	a	<input type="checkbox"/> (a+b) D5	<input type="text" value="2"/> (a+b) D5
Print average sales per customer (AVER) on fixed total report.	b		
Must be "0"	c	<input type="text" value="0"/> D4	<input type="text" value="0"/> D4
Print commission 1 total (C-1) on fixed total report.	a	<input type="checkbox"/> (a+b+c) D3	<input type="text" value="7"/> (a+b+c) D3
Print commission 2 total (C-2) on fixed total report.	b		
Print foreign currency cash in drawer (CECA1, CECA2) and check in drawer (CECK1, CECK2) on fixed total report.	c		
Print <MINUS>, <COUPON>, <%-> and mix & match operation net total (DC) on fixed total report.	a	<input type="checkbox"/> (a+b) D2	<input type="text" value="3"/> (a+b) D2
Print total number of <REFUND> operation (RF) on fixed total report.	b		
Print nontaxable totals (NON TAX) on fixed total report.	a	<input type="checkbox"/> (a+b+c) D1	<input type="text" value="3"/> (a+b+c) D1
Print rounded fractions (ROUND) on fixed total report.	b		
Print number of cancellation (CANCEL) on fixed total report.	c		

# Advanced programmings and registrations

## Example:

- On the fixed total report, not printing gross sales total (a = 1), not printing net sales total (b = 2), not printing cash in drawer. (c = 4): D10 = 7 (1 + 2 + 4).
- Not printing amount in drawer on fixed total report: D9 = 1.
- On fixed total report, not printing check amount in drawer (a = 1), not printing credit amount in drawer (b = 4): D8 = 5 (1 + 4).
- D7 must be always 0.
- Not printing refunded amount in RF mode on fixed total report: D6 = 4.
- Not printing total number of customers on fixed total report (a = 1), not printing average sales amount per customer (b = 2): D5 = 5 (1 + 4).
- D4 must be always 0.
- On fixed total report, not printing commission 1 amount (a = 1), not printing commission 2 amount (b = 2), not printing amount of foreign currency cash and check (c = 4): D3 = 7 (1 + 2 + 3).
- On fixed total report, not printing net total of <MINUS>, <COUPON>, <%-> etc. (a = 1), not printing <REFUND> and <VOID> amounts (b = 2): D2 = 3 (1 + 2).
- On fixed total report, not printing non-taxable amounts (a = 1), not printing rounded down amount (b = 2), not printing cancelled amount (c = 4): D1 = 7 (1 + 2 + 3).

Press **3**  **0 8 2 2**  **7 1 5 0 4 5 0 7 3 7**

## Set code 10 (Print control of taxable amount)

Description	Selection	Program code	Default value
Print taxable amount 1 on receipt/journal.	a	<input type="checkbox"/> (a+b+c) D10	<input type="text" value="0"/> (a+b+c) D10
Print taxable amount 2 on receipt/journal.	b		
Print taxable amount 3 on receipt/journal.	c		
Print taxable amount 4 on receipt/journal.	Yes = 0 No = 1	<input type="checkbox"/> D9	<input type="text" value="0"/> D9
Must be "00000000" (eight zeros)		<input type="text" value="0"/> to <input type="text" value="0"/> D8 to D1	<input type="text" value="0"/> to <input type="text" value="0"/> D8 to D1

## Set code 14 (Currency exchange)

Description	Selection	Program code	Default value
Monetary mode of CECA1 and CECK1 in fixed total report. CECA: Foreign currency cash in drawer CECK: Foreign currency check in drawer	0 to 9	<input type="checkbox"/> D8	<input type="text" value="0"/> D8
Decimal for CECA1 and CECK1 in fixed total report: Period = 0, Comma = 1	a	<input type="checkbox"/> (a+b) D7	<input type="text" value="0"/> (a+b) D7
Separator for CECA1 and CECK1 in fixed total report: Comma = 0, Period = 4	b		
Monetary mode of CECA2 and CECK2 in fixed total report.	0 to 9	<input type="checkbox"/> D6	<input type="text" value="0"/> D6
Decimal for CECA2 and CECK2 in fixed total report: Period = 0, Comma = 1	a	<input type="checkbox"/> (a+b) D5	<input type="text" value="0"/> (a+b) D5
Separator for CECA2 and CECK2 in fixed total report: Comma = 0, Period = 4	b		
Always "0000"		<input type="text" value="0"/> to <input type="text" value="0"/> D4 to D1	<input type="text" value="0"/> to <input type="text" value="0"/> D4 to D1

# Advanced programmings and registrations

## Set code 15 (Printing methods of sales reports)

Description	Selection	Program code	Default value
Department zero skip (Departments of sales amount zero are not printed on sales reports.)	a Yes = 0 No = 1	<input type="checkbox"/> (a+b) D10	<input type="checkbox"/> 0 (a+b) D10
Clerk zero skip (Zero amounted clerks are not printed on sales reports.)	b Yes = 0 No = 2		
Transaction key zero skip (Transaction keys of sales amount zero are not printed on sales reports.)	a Yes = 0 No = 1		
PLU zero skip (Zero amounted PLUs are not printed on sales reports.)	b Yes = 0 No = 2	<input type="checkbox"/> (a+b+c) D9	<input type="checkbox"/> 0 (a+b+c) D9
Hourly sales report skip (Zero amounted time zones are not printed on sales reports.)	c Yes = 0 No = 4		
Group zero skip (Zero amounted groups are not printed on sales reports.)	Yes = 0 No = 1	<input type="checkbox"/> D8	<input type="checkbox"/> 0 D8
Must be "0"		<input type="checkbox"/> 0 D7	<input type="checkbox"/> 0 D7
Prohibit to issue "OPEN CHECK Z" report	No = 0 Yes = 1	<input type="checkbox"/> D6	<input type="checkbox"/> 0 D6
Print PLU numbers on the PLU report.	No = 0 Yes = 4	<input type="checkbox"/> D5	<input type="checkbox"/> 0 D5
Print sales ratio on sales reports.	a No = 0 Yes = 1	<input type="checkbox"/> (a+b) D4	<input type="checkbox"/> 0 (a+b) D4
Issue double Z repors.	b No = 0 Yes = 2		
Must be "000"		<input type="checkbox"/> 0 <input type="checkbox"/> 0 <input type="checkbox"/> 0 D3 D2 D1	<input type="checkbox"/> 0 <input type="checkbox"/> 0 <input type="checkbox"/> 0 D3 D2 D1

## Set code 16 (Printing methods of grand total)

Description	Selection	Program code	Default value
Print range of consecutive number on fixed total report.	No = 0 Yes = 1	<input type="checkbox"/> D7	<input type="checkbox"/> 0 D7
Must be "00111"		<input type="checkbox"/> 0 <input type="checkbox"/> 0 <input type="checkbox"/> 1 <input type="checkbox"/> 1 <input type="checkbox"/> 1 D6 D5 D4 D3 D2	<input type="checkbox"/> 0 <input type="checkbox"/> 0 <input type="checkbox"/> 1 <input type="checkbox"/> 1 <input type="checkbox"/> 1 D6 D5 D4 D3 D2
Print grand total on daily sales reset (Z) report.	Yes = 0 No = 1	<input type="checkbox"/> D1	<input type="checkbox"/> 0 D1

# Advanced programmings and registrations

## Set code 17 (Date/time printing on journals/receipts)

Description	Selection	Program code	Default value
Print date on journal.	a Yes = 0 No = 2	<input type="checkbox"/> (a+b) D4	<input type="checkbox"/> 0 (a+b) D4
Print consecutive number on receipt/journal.	b Yes = 0 No = 4		
Print time on receipt.	a Yes = 0 No = 1	<input type="checkbox"/> (a+b) D3	<input type="checkbox"/> 0 (a+b) D3
Print time on journal.	b Yes = 0 No = 2		
Must be "00"		<input type="checkbox"/> 0 <input type="checkbox"/> 0 D2 D1	<input type="checkbox"/> 0 <input type="checkbox"/> 0 D2 D1

## Set code 18 (Print control for guest receipt)

Description	Selection	Program code	Default value
Classify registered items by groups on guest receipts.	No = 0 Yes = 4	<input type="checkbox"/> D6	<input type="checkbox"/> 0 D6
Must be "0"		<input type="checkbox"/> 0 D5	<input type="checkbox"/> 0 D5
Print date on guest receipts.	a Yes = 0 No = 1	<input type="checkbox"/> (a+b) D4	<input type="checkbox"/> 0 (a+b) D4
Print time on guest receipts	b Yes = 0 No = 2		
Merge the same registrations in a guest receipt (item consolidation)	Yes = 0 No = 4	<input type="checkbox"/> D3	<input type="checkbox"/> 0 D3
Must be "00"		<input type="checkbox"/> 0 <input type="checkbox"/> 0 D2 D1	<input type="checkbox"/> 0 <input type="checkbox"/> 0 D2 D1

## Set code 19 (Double height character printing on receipts)

Description	Selection	Program code	Default value
Print receipt in double height characters	No = 0 Yes = 1	<input type="checkbox"/> D7	<input type="checkbox"/> 0 D7
Must be "000000" (six zeros)		<input type="checkbox"/> 0 <input type="checkbox"/> 0 <input type="checkbox"/> 0 <input type="checkbox"/> 0 <input type="checkbox"/> 0 <input type="checkbox"/> 0 D6 D5 D4 D3 D2 D1	<input type="checkbox"/> 0 <input type="checkbox"/> 0 <input type="checkbox"/> 0 <input type="checkbox"/> 0 <input type="checkbox"/> 0 <input type="checkbox"/> 0 D6 D5 D4 D3 D2 D1

# Advanced programmings and registrations

## Set code 21 (Printing methods of messages)

Description	Selection	Program code	Default value
Print graphic type logo. (If "No" is selected, character logo will be printed.)	No = 0 Yes = 2	<input type="checkbox"/> D10	<input type="checkbox" value="2"/> D10
Print commercial message on guest receipts.	a No = 0 Yes = 1	<input type="checkbox"/> (a+b) D9	<input type="checkbox" value="0"/> (a+b) D9
Print bottom message on guest receipts.	b No = 0 Yes = 2		
Must be "00"		<input type="checkbox" value="0"/> <input type="checkbox" value="0"/> D8 D7	<input type="checkbox" value="0"/> <input type="checkbox" value="0"/> D8 D7
Print commercial message on receipts in REG/RF mode.	a No = 0 Yes = 1	<input type="checkbox"/> (a+b) D6	<input type="checkbox" value="0"/> (a+b) D6
Print bottom message on receipts in REG/RF mode.	b No = 0 Yes = 2		
Must be "0000"		<input type="checkbox" value="0"/> <input type="checkbox" value="0"/> <input type="checkbox" value="0"/> <input type="checkbox" value="0"/> D5 D4 D3 D2	<input type="checkbox" value="0"/> <input type="checkbox" value="0"/> <input type="checkbox" value="0"/> <input type="checkbox" value="0"/> D5 D4 D3 D2
Must be "0".		<input type="checkbox" value="0"/> D1	<input type="checkbox" value="0"/> D1

## Set code 25 (Entry restriction)

Description	Selection	Program code	Default value
Restrict (to 0 or 5) to the last digit for amount tender.	a No = 0 Yes = 1	<input type="checkbox"/> (a+b) D1	<input type="checkbox" value="0"/> (a+b) D1
Restriction (to 0 or 5) to the last digit for <CASH>. <RC>, <PD>, money declaration amount.	b No = 0 Yes = 4		

## Set code 26 (Check tracking)

Description	Selection	Program code	Default value
Force to enter check number	a No = 0 Yes = 1	<input type="checkbox"/> (a+b+c) D7	<input type="checkbox" value="0"/> (a+b+c) D7
Force to enter number of customersl.	b No = 0 Yes = 2		
Force to issue guest receipts.	c No = 0 Yes = 4		
Must be "0"		<input type="checkbox"/> D6	<input type="checkbox" value="0"/> D6
Tax calculation by new balance. (Calculation result is not saved into the totalizer)	No = 0 Yes = 1	<input type="checkbox"/> D5	<input type="checkbox" value="0"/> D5
Must be "0000" (four zeros)		<input type="checkbox" value="0"/> to <input type="checkbox" value="0"/> D4 to D1	<input type="checkbox" value="0"/> to <input type="checkbox" value="0"/> D4 to D1



# Advanced programmings and registrations

## Set code 27 (Clerk operation selections)

Description	Selection	Program code	Default value
Allow clerk interruption.	No = 0 Yes = 1	<input type="checkbox"/> D10	<input type="checkbox"/> D10
Allow clerk functions.	No = 0 Yes = 4	<input type="checkbox"/> D9	<input type="checkbox"/> D9
Must be "00000000"		<input type="checkbox"/> to <input type="checkbox"/> D8 to D1	<input type="checkbox"/> to <input type="checkbox"/> D8 to D1

## Set code 28 (Euro 1)

Description	Selection	Program code	Default value
Define Euro as the main currency.	Yes = 0 No = 1	<input type="checkbox"/> D10	<input type="checkbox"/> D10
Select rounding option: Round off = 0, Cut off = 1, Round up = 2	0,1 or 2	<input type="checkbox"/> D9	<input type="checkbox"/> D9
Exchange rate (in 6 digits)	Exchange rate	<input type="checkbox"/> to <input type="checkbox"/> D8 to D3	<input type="checkbox"/> to <input type="checkbox"/> D8 to D3
Decimal point position of exchange rate: Integer only = 0, 1st decimal place = 1, 2nd decimal place = 2, 3rd decimal place = 3, 4th decimal place = 4, 5th decimal place = 5, 6th decimal place = 6 Example: (D8 ~ D2): 1 Euro = 1.955 DM; set "0019553" 1 Euro = 1957.77319 Lit; set "1957772"	0 to 6	<input type="checkbox"/> D2	<input type="checkbox"/> D2
Must be "0"		<input type="checkbox"/> D1	<input type="checkbox"/> D1

**Example 1:** To set Euro as main currency, rounding off, exchange rate €1.00 = DM 1.9558

**3**  SUB TOTAL **2 8 2 2**  SUB TOTAL **0 0 0 1 9 5 5 8 4 0**  CA / AMT / TEND  SUB TOTAL

**Example 2:** To set Euro as sub currency, rounding up, exchange rate €1.00 = £0.8573

**3**  SUB TOTAL **2 8 2 2**  SUB TOTAL **1 2 0 0 8 5 7 3 4 0**  CA / AMT / TEND  SUB TOTAL

# Advanced programmings and registrations

## Set code 29 (Euro 2)

Description	Selection	Program code	Default value
ADD mode of sub currency: 0. = 0, 0.0 = 1, 0.00 = 2, 0.000 = 3	0 to 3	<input type="checkbox"/> D10	<input type="checkbox"/> 0 D10
Apply rounding for sub currency. * No rounding = 0, IF1 = 1, IF2 = 2, Danish = 3, Finnish = 6, Australian = 7, South African = 8	0 to 8	<input type="checkbox"/> D9	<input type="checkbox"/> 0 D6
Must be "0"		<input type="checkbox"/> 0 D8	<input type="checkbox"/> 0 D8
Print tendered amount in sub currency converted to main currency.	a No = 0 Yes = 1	<input type="checkbox"/> (a+b+c) D7	<input type="checkbox"/> 0 (a+b+c) D7
Selection of the currency of subtotal printout: 1 Main currency only, 2 Main and sub currency	b ① = 0 ② = 2		
Print total in sub currency by double sized letter.	c No = 0 Yes = 4		
Selection of the currency of change: 1 Main currency only, 2 Sub currency	a ① = 0 ② = 1	<input type="checkbox"/> (a+b+c) D6	<input type="checkbox"/> 0 (a+b+c) D6
Print the cash in drawer in sub currency on fixed total reports. (If the cash in drawer of main currency is skipped, this line is also skipped.)	b No = 0 Yes = 2		
Display symbols of sub currency: 1 e (Euro), 2 l (Local)	c ① = 0 ② = 4		
Restrict (to 00, 25, 50, 75) on last two digits for amount tendered: 1 Main currency, 2 Sub currency (It is necessary to set this restriction to <CASH> key.)	a ① = 0 ② = 1	<input type="checkbox"/> (a+b+c) D5	<input type="checkbox"/> 0 (a+b+c) D5
Print rounding total of sub currency on fixed totalizer report.	b No = 0 Yes = 2		
Restrict the last digit for sub currency monetary amount entries to 0 or 5.	c No = 0 Yes = 4		
Selection of the change amount printout: 1 Main and sub currency, 2 Dependent upon D6 -a of this worksheet	a ① = 0 ② = 1	<input type="checkbox"/> (a+b) D4	<input type="checkbox"/> 0 (a+b) D4
Calculation method of change amount in sub currency: 1 Convert the change amount in main currency into sub currency. 2 Subtract the equivalent value of subtotal amount in sub currency from the equivalent value of the tendered amount in sub currency,	b ① = 0 ② = 2		
Must be "000"	000	<input type="checkbox"/> 0 <input type="checkbox"/> 0 <input type="checkbox"/> 0 D3 D2 D1	<input type="checkbox"/> 0 <input type="checkbox"/> 0 <input type="checkbox"/> 0 D3 D2 D1

# Advanced programmings and registrations

## Set code 30 (Thermal printer control)

Description		Selection	Program code	Default value
Print preset receipt message and graphic.	a	No = 0 Yes = 1	<input type="checkbox"/> (a+b) D5	<input type="checkbox"/> (a+b) D5
Print preset receipt message and graphic:① at the bottom of the receipt, ② at the top of the receipt	b	① = 0 ② = 2		
Journal compressed print (print half height characters)		Yes = 0 No = 1	<input type="checkbox"/> D4	<input type="checkbox"/> D4
Must be "000"			<input type="checkbox"/> <input type="checkbox"/> <input type="checkbox"/> D3 D2 D1	<input type="checkbox"/> <input type="checkbox"/> <input type="checkbox"/> D3 D2 D1

## Set code 34 (Backlight control)

Description		Selection	Program code	Default value
Backlight		Functions = 0 Not functions = 1	<input type="checkbox"/> D4	<input type="checkbox"/> D4
Must be "000"			<input type="checkbox"/> <input type="checkbox"/> <input type="checkbox"/> D3 D2 D1	<input type="checkbox"/> <input type="checkbox"/> <input type="checkbox"/> D3 D2 D1

# Advanced programmings and registrations

## Programming functions of departments and PLUs in a lump

There are two methods to set functions of departments or PLUs which are programming at once and programming individual functions.







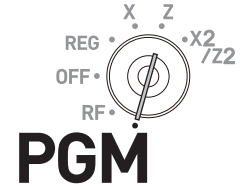

### Programming department and flat PLU functions in a lump

This method programs function of a department at one time.

For shifted departments, press <Department no./Department shift> key first.

For shifted flat PLU, press  key first.



Step	Operation
1 Turn the Mode switch to PGM position and select [System Setting] then press  key.	 .....  
2 Enter <b>3</b> and press  key to set the register in the programming mode.	<b>3</b> 
3 You can skip this step if you program in departments 01 through 25. If you wish to program in departments 26 through 50, press <Dept. no./Dept. shift> key.	<Dept. no./Dept. shift>
4 Referring following table, input 12- digit program code.	<input type="text"/> <input type="text"/> ..... <input type="text"/> <input type="text"/> [Program code (12 digits)]
5 Press the department key you wish to program	<input type="text"/> <b>1</b> For example, programming in dept. 26.
6 Repeat steps 3 through 5 if you wish to program functions in another departments.	
7 Press  key to complete the program.	

### Example:

Programming department 26 as;

- Normal item: D12 = 0.
- D11 through D8 must be 0000.
- US taxable status 1 (a = 1) and 2 (b = 2): D7 = 3 (1 + 2)
- Allowing zero unit price (a = 1), not allowing negative unit price (b = 0), hash item (c = 4): D6 = 5 (1 + 0 + 4).
- D5 must always be 0.
- Limiting minimum entry digit: 3 digits: D4 = 3.
- As this example is for setting functions in a department, D3 should be 0.
- Applying commission 1 (a = 1), not applying commission 2 (b = 0): D2 = 1 (1 + 0).
- D1 must always be 0.

Press **3**   **0 0 0 0 0 3 5 0 3 0 1**  **1** 

# Advanced programmings and registrations

## Department and PLU lump set code

Description			Selection	Program code	Default value
Single item sales: Normal item = 0, Single item = 3			0 or 3	<input type="checkbox"/> D12	<input type="checkbox"/> D12
Must be "000"			000	<input type="checkbox"/> <input type="checkbox"/> <input type="checkbox"/> D11 D10 D9	<input type="checkbox"/> <input type="checkbox"/> <input type="checkbox"/> D11 D10 D9
Taxable status	For singapore	D8 must be 0	a 0	<input type="checkbox"/> D8	<input type="checkbox"/> D8
		Taxable status 1	a No = 0 Yes = 1	<input type="checkbox"/> (a+b+c) D7	<input type="checkbox"/> D7
		Taxable status 2	b No = 0 Yes = 2		
		Taxable status 3	c No = 0 Yes = 4		
	For other countries	Non tax = 00, Taxable 1 = 01, Taxable 2 = 02, Taxable 3 = 03, Taxable 4 = 04, All taxable = 99 (only for transaction keys)		<input type="checkbox"/> <input type="checkbox"/> D8 D7	<input type="checkbox"/> <input type="checkbox"/> D8 D7
Enable zero unit price.		a No = 0 Yes = 1	<input type="checkbox"/> (a+b+c) D6	<input type="checkbox"/> (a+b+c) D6	
Enable negative price.		b No = 0 Yes = 2			
Hash item		c No = 0 Yes = 4			
Must be "0"			0	<input type="checkbox"/> D5	<input type="checkbox"/> D5
Low digit limitation (LDL) for manually entered unit price.			Number of digits	<input type="checkbox"/> D4	<input type="checkbox"/> D4
Open PLU (only for PLU)			No = 0 Yes = 4	<input type="checkbox"/> D3	<input type="checkbox"/> D3
Commission 1 (give commission on items)		a No = 0 Yes = 1	<input type="checkbox"/> (a+b) D2	<input type="checkbox"/> (a+b) D2	
Commission 2		b No = 0 Yes = 2			
Must be "0"				<input type="checkbox"/> D1	<input type="checkbox"/> D1

# Advanced programmings and registrations

## Programming PLU functions in a lump

This method programs functions of a PLU at one time.

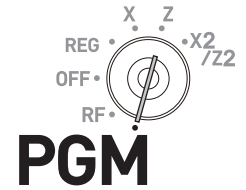

### Step

- 1 Turn the Mode switch to PGM position and select [System Setting] then press key.
- 2 Enter **3** and press key to set the register in the programming mode.
- 3 Enter four-digit PLU number then press key.
- 4 Referring the table in the previous section, input 12- digit program code.
- 5 Press key.
- 6 Repeat steps 3 through 5 if you wish to program functions in another PLU.
- 7 Press key to complete the program.

### Operation



For example, to program PLU number fourteen.



## Programming functions of departments and PLUs individually

### Programming functions of departments individually

This part explains programming methods of each function of departments individually.

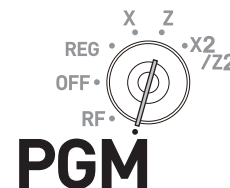

Step	Operation
<p><b>1</b> Turn the Mode switch to PGM position and select [System Setting] then press  key.</p>	.....
<p><b>2</b> Enter <b>3</b> and press  key to set the register in the programming mode.</p>	<b>3</b>
<p><b>3</b> Referring the following table, enter two-digit set code you wish to program followed by two 6s. The “66” is the identification code for individual programming of departments and PLUs. Then press  key.</p>	<b>6</b> <b>6</b> (set code)
<p><b>4</b> You can skip this step if you program in departments 01 through 25. If you wish to program in departments 26 through 50, press &lt;Dept. no./Dept. shift&gt; key.</p>	<Dept. no./Dept. shift>
<p><b>5</b> Referring the following table, enter program code and press the department key in which you wish to set.</p>	<b>1</b> <b>2</b> <b>3</b> <p>This example is for linking dept. 03 to item group 123 assuming set code 11 has been entered in step 3 and &lt;Dept. no./Dept. shift&gt; key is not pressed in step 4.</p>
<p><b>6</b> If you wish to set the same function in another department, press the corresponding dept. key.</p>	<p>This example is for setting the same linking group in dept. 04.</p>
<p><b>7</b> Repeat steps 4 and 5 to set another function in another department.</p>	
<p><b>8</b> Press  key to complete the program.</p>	

# Advanced programmings and registrations

## Set code table

Set code	Description		Selection	Program code
01	Normal item /condiment item /preparation item Normal item = 0, Condiment item = 1, Preparation item = 2		0,1 or 2	<input type="checkbox"/>
03	Taxable status	For singapore	D2 must be 0	0 <input type="checkbox"/> D2
			Taxable status 1	a No = 0 Yes = 1
			Taxable status 2	b No = 0 Yes = 2
	Taxable status 3	c No = 0 Yes = 4	<input type="checkbox"/> (a+b+c) D1	
	For other countries	Non tax = 00, Taxable 1 = 01, Taxable 2 = 02, Taxable 3 = 03, Taxable 4 = 04, All taxable = 99 (only for transaction keys)	00 to 04	<input type="checkbox"/> <input type="checkbox"/> D2 D1
04	Open PLU (Only for PLU)		No = 0 Yes = 4	<input type="checkbox"/>
05	Allow unit price 0		a No = 0 Yes = 1	<input type="checkbox"/> (a+b+c)
	Allow negative unit price.		b No = 0 Yes = 2	
	Hash item		c No = 0 Yes = 4	
07	Minimum digit of manual input unit price		Number of minimum digit	<input type="checkbox"/>
09	Commission 1		a No = 0 Yes = 1	<input type="checkbox"/> (a+b)
	Commission 2		b No = 0 Yes = 2	
11	Linking group (000 to 999)		000 to 999	<input type="checkbox"/> <input type="checkbox"/> <input type="checkbox"/> D7 D6 D5
	Must be 0		0	<input type="checkbox"/> D4
	Linking dept. (000 to 999) (Only for PLU)		000 to 999	<input type="checkbox"/> <input type="checkbox"/> <input type="checkbox"/> D3 D2 D1
13	Set menu table number (only for PLU)		Table No.	<input type="checkbox"/> <input type="checkbox"/> <input type="checkbox"/> <input type="checkbox"/> D4 D3 D2 D1
15	Maximum amount of manual input unit price (up to 9999.99)			<input type="checkbox"/> <input type="checkbox"/> <input type="checkbox"/> <input type="checkbox"/> <input type="checkbox"/> <input type="checkbox"/> D6 D5 D4 D3 D2 D1
18	Single item control: Normal item = 0, Single item = 3		0 or 3	<input type="checkbox"/>
26	Age limitation (no limitation if "00" is set)		Age	<input type="checkbox"/> <input type="checkbox"/>

**Example:** To program dept. 02 to allow manual input unit price up to •99.00.

**3**  SUB TOTAL **1 5 6 6**  SUB TOTAL **9 9 0 0**  2  SUB TOTAL



# Advanced programmings and registrations

## Programming functions of PLUs individually

This part explains programming methods of each function of PLUs individually.

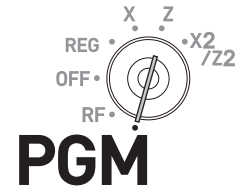

Step	Operation
<p><b>1</b> Turn the Mode switch to PGM position and select [System Setting] then press  key.</p>	.....
<p><b>2</b> Enter <b>3</b> and press  key to set the register in the programming mode.</p>	<b>3</b>
<p><b>3</b> Referring the tables in the proceeding section, enter two-digit set code you wish to program followed by two 6s. The “66” is the identification code for individual programming of departments and PLUs. Then press  key.</p>	<b>6</b> <b>6</b> (set code)
<p><b>4</b> Enter PLU number you wish to set and press  key.</p>	<b>0</b> <b>0</b> <b>0</b> <b>5</b>
<p><b>5</b> Referring the table in the preceding section, enter program code and press  key.</p>	..... (Program code)
<p><b>6</b> If you wish to set the same program code in the next PLU number, press  key again.</p> <p>Perform step 5 if you wish to set another program code to the next PLU number.</p> <p>To program in another PLU number (not next PLU number), repeat steps 4 and 5.</p>	
<p><b>7</b> Press  key to complete the settings.</p>	

**Example 1:** To set PLU 0001 as “Open PLU”.





Press **3** **0** **4** **6** **6** **0** **0** **0** **1** **4**

**Example 2:** To set PLU0012 to link item group 12 and dept. 04.









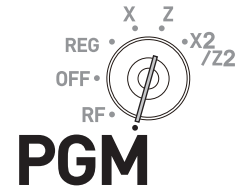



Press **3** **1** **1** **6** **6** **0** **0** **1** **2** **0** **1** **2** **0** **0** **0** **4**

# Advanced programmings and registrations

## Programming functions of transaction keys

This section explains how you can program functions in each transaction keys such as ,  or  keys. For example, programming  key to force entry of tendered amount.



Step	Operation
<b>1</b> Turn the Mode switch to PGM position and select [System Setting] then press  key.	 .....  
<b>2</b> Enter <b>3</b> and press  key to set the register in the programming mode.	 
<b>3</b> Referring the following tables, enter the program code then press corresponding transaction key.	 .....   (Program code) The above example is for programming minus key.
<b>4</b> If you wish to program another transaction key, return to step 3.	
<b>5</b> Press  key to complete the program.	

# Advanced programmings and registrations

## Program code tables

**NOTE** Default value of all the program codes are “0”.

Program code for  CA / AMT / TEND, <Charge> and  CHK keys.

Description		Selection	Program code
Restrict to 00/55 on last two digits for amount tendered (only for <input type="checkbox"/> CA / AMT / TEND in Danish rounding)		No = 0 Yes = 4	<input type="checkbox"/> D10
Must be “00”.		00	<input type="checkbox"/> <input type="checkbox"/> D9 D8
Prohibit partial payment.	a	No = 0 Yes = 1	<input type="checkbox"/> (a+b+c) D7
Prohibit tendered amount entry	b	No = 0 Yes = 2	
Force to enter tendered amount.	c	No = 0 Yes = 4	
Print breakdown of VAT. (Option for Single item or Currency exchange (including partial tendering foreign currency).)		No = 0 Yes = 1	<input type="checkbox"/> D6
French food coupon	a	No = 0 Yes = 1	<input type="checkbox"/> (a+b) D5
Perform French rounding	b	No = 0 Yes = 4	
Maximum amount for subtotal and tendered amount. e.g.) •9000, D4 = 9, D3 = 3		D4: Maximum value (0 ~ 9)	<input type="checkbox"/> <input type="checkbox"/>
		D3: Number of zeros (0 ~ 9)	D4 D3
Maximum amount of change due.		Maximum value (0 ~ 9)	<input type="checkbox"/> <input type="checkbox"/>
		Number of zeros (0 ~ 9)	D2 D1

**Example :** To set  CA / AMT / TEND key as prohibiting partial payment (a = 1), not prohibiting tendered amount entry (b = 0), and forcing to enter tendered amount (c = 4): D7 = 6.

Press

# Advanced programmings and registrations

## Program code for RA and PO keys

Description	Selection	Program code
Maximum amount. e.g.) *10,000; D4 = 1, D3 = 4.	Maximum value (0 ~ 9)	<input type="checkbox"/> <input type="checkbox"/> D4 D3
	Number of zeros (0 ~ 9)	
Must be "00"	00	<input type="checkbox"/> <input type="checkbox"/> D2 D1

**Example :** To set  PO key not allowing to enter more than \$900.

Press  3  SUB TOTAL  9  2  0  0  PO  SUB TOTAL

## Program code for -, <Addition (plus)> and <Coupon> keys

Description		Selection	Program code	
Taxable status	D8 must be 0	0	<input type="checkbox"/> D8	
	For singapore	Taxable status 1	a	No = 0 Yes = 1
		Taxable status 2	b	No = 0 Yes = 2
		Taxable status 3	c	No = 0 Yes = 4
	For other countries	Non tax = 00, Taxable 1 = 01, Taxable 2 = 02, Taxable 3 = 03, Taxable 4 = 04, All taxable = 99 (only for transaction keys)		00 to 04 <input type="checkbox"/> <input type="checkbox"/> D8 D7
Allow credit balance ( <input type="checkbox"/> - <Coupon> only)		a	No = 0 Yes = 1	
Allow credit balance (<Addition (plus)> only)		b	No = 0 Yes = 2	
Must be "00"		00	<input type="checkbox"/> <input type="checkbox"/> D5 D4	
Maximum digit of manual input unit price (Setting "9" programs NOT allowing manual entry.)		Number of digit	<input type="checkbox"/> D3	
Give commission 1		a	No = 0 Yes = 1	
Give commission 2		b	No = 0 Yes = 2	
Must be "0"		0	<input type="checkbox"/> D1	

# Advanced programmings and registrations

## Program code for - key

Description		Selection	Program code
Taxable status	For singapore	D8 must be 0	<input type="checkbox"/> 0 D8
		Taxable status 1	a No = 0 Yes = 1
		Taxable status 2	b No = 0 Yes = 2
	Taxable status 3	c No = 0 Yes = 4	<input type="checkbox"/> (a+b+c) D7
For other countries	Non tax = 00, Taxable 1 = 01, Taxable 2 = 02, Taxable 3 = 03, Taxable 4 = 04, All taxable = 99 (only for transaction keys)	00 to 99	<input type="checkbox"/> <input type="checkbox"/> D8 D7
Prohibit manual rate entry.		No = 0 Yes = 2	<input type="checkbox"/> D6
Rounding: Round off = 0, Cut off = 1, Round up = 2		0, 1 or 2	<input type="checkbox"/> D5
Must be "00"		00	<input type="checkbox"/> <input type="checkbox"/> D4 D3
Give commission 1	a	No = 0 Yes = 1	<input type="checkbox"/> (a+b)D2
Give commission 2	b	No = 0 Yes = 2	
Must be "0"		0	<input type="checkbox"/> D1

## Program code for and keys

Description	Selection	Program code
Allow mode change or clerk change after the key operation as first transaction. (Only for Non-add function)	Yes = 0 No = 1	<input type="checkbox"/> D7
Must be "000000"	000000	<input type="checkbox"/> <input type="checkbox"/> <input type="checkbox"/> <input type="checkbox"/> <input type="checkbox"/> <input type="checkbox"/> D6 D5 D4 D3 D2 D1

## Program code for key

Description	Selection	Program code
Print when the key is pressed.	No = 0 Yes = 4	<input type="checkbox"/> D6
Always "00000"	00000	<input type="checkbox"/> <input type="checkbox"/> <input type="checkbox"/> <input type="checkbox"/> <input type="checkbox"/> D5 D4 D3 D2 D1

# Advanced programmings and registrations

## Program code for <Age verification> key

Description	Selection	Program code
Print the registered date.	Yes = 0 No = 1	<input type="checkbox"/> D10
Must be "000000000" (nine zeros).	000000000	All <input checked="" type="checkbox"/> D9 to D1

## Program code for <Currency exchange> key.

Description	Selection	Program code
Define foreign currency symbol (0, 1, 2, 3, or 4). See "Setting symbol characters" on page E-82. Setting "0" defines the local currency.	0 to 4	<input type="checkbox"/> D7
Define foreign currency totalizer number. (0, 1, 2) (Totalizer 1 is defined if "0" is set)	0, 1 or 2	<input type="checkbox"/> D6
Roundings Round off = 0, Cut off = 1, Round up = 2	0, 1 or 2	<input type="checkbox"/> D5
Must be "0".	0	<input checked="" type="checkbox"/> D4
ADD (decimal point position) 0. = 0, 0.0 = 1, 0.00 = 2, 0.000 = 3	0 to 9	<input type="checkbox"/> D3
Symbol for decimal point	Point = 0 Comma = 1	<input type="checkbox"/> D2(a+b) e.g.) for 1,234.56 D2 = 0+0
Symbol for separator	Comma = 0 Point = 4	
Must be "0"	0	<input checked="" type="checkbox"/> D1

## Program code for <Arrangement> key

Description	Selection	Program code
Process numeric entry as programmed arrangement number.	No = 0 Yes = 1	<input type="checkbox"/> D7
Arrangement program number.	Program number	<input type="checkbox"/> to <input type="checkbox"/> D6 to D1

## Program code for <Text recall> key

Description	Selection	Program code
Character file number.	File number	<input type="checkbox"/> <input type="checkbox"/> D6 D5
Must be "0000"	0000	All <input checked="" type="checkbox"/> D4 to D1

# Advanced programmings and registrations

## Program code for <Multiplication> <Multiplication for> keys

Description	Selection	Program code
Multiplication procedure ① Quantity × Amount, ② Amount × Quantity	① = 0 ② = 1	<input type="checkbox"/> D6
Roundings: Round off = 0, Cut off = 1, Round up = 2	0, 1, or 2	<input type="checkbox"/> D5
Must be "0000"	0000	<input type="checkbox"/> <input type="checkbox"/> <input type="checkbox"/> <input type="checkbox"/> D4 D3 D2 D1

## Program code for <Tax shift> key

Description	Selection	Program code
Taxable status (01 ~ 04) (Taxable 1 if "00" is set)	01 to 04	<input type="checkbox"/> <input type="checkbox"/> D8 D7
Must be "000000"	000000	<input type="checkbox"/> <input type="checkbox"/> <input type="checkbox"/> <input type="checkbox"/> <input type="checkbox"/> <input type="checkbox"/> D6 D5 D4 D3 D2 D1

## Program code for <Credit> key.

Description	Selection	Program code
Prohibit partial payment.	a No = 0 Yes = 1	<input type="checkbox"/> (a+b+c) D7
Prohibit tendered amount entry	b No = 0 Yes = 2	
Force to enter tendered amount.	c No = 0 Yes = 4	
Print breakdown of VAT.	No = 0 Yes = 1	<input type="checkbox"/> D6
French food coupon	a No = 0 Yes = 1	<input type="checkbox"/> (a+b)D5
Performs Finnish rounding	b No = 0 Yes = 4	
Maximum amount for subtotal and tendered amount. e.g.) •9,000, D4 = 9, D3 = 3	D4: Maximum value (0 ~ 9)	<input type="checkbox"/> <input type="checkbox"/>
	D3: Number of zeros (0 ~ 9)	D4 D3
Must be "00"	00	<input type="checkbox"/> <input type="checkbox"/> D2 D1

# Advanced programmings and registrations

## Program code for <New balance> key

Description	Selection	Program code
Cancel the transaction if no item is registered.	No = 0 Yes = 4	<input type="checkbox"/> D10
Must be "00".	00	<input type="text" value="0"/> <input type="text" value="0"/> D9 D8
Function after normal (not in check tracking) registration. Error = 0, Auto cash = 1 (see below)	0 or 1	<input type="checkbox"/> D7
Print breakdown of VAT.	No = 0 Yes = 1	<input type="checkbox"/> D6
Must be "00000"	00000	<input type="text" value="0"/> to <input type="text" value="0"/> D5 to D1

Auto cash: <New balance> key functions as key if it is pressed without opening a new check or calling old check in the check tracking system.



## Programming further clerk functions

This section explains how you can set further programming for clerks such as setting clerks' secret number, setting the register in training mode or setting commission rates given to clerks. In the training mode, the register operates normally but the results will not be stored in the memory. You can use this feature for getting to know the operations of the cash register for yourself or for newly hired clerks.

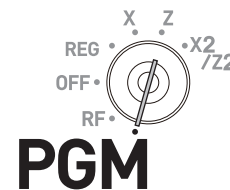

### ■ Setting check number for clerk interruption and clerks' secret number















Step	Operation
<b>1</b> Turn the Mode switch to PGM position and select [System Setting] then press <input type="button" value="CA/AMT/TEND"/> key.	
<b>2</b> Enter <b>3</b> and press <input type="button" value="SUB TOTAL"/> key to set the register in the programming mode.	<b>3</b> <input type="button" value="SUB TOTAL"/>
<b>3</b> Enter 2 -digit clerk number followed by 07. The "07" is the identification code for further program of clerks. Then press <input type="button" value="SUB TOTAL"/> key. The example on the right is for programming to clerk number 10.	<b>1 0 0 7</b> <input type="button" value="SUB TOTAL"/> (Clerk no.)
<b>4</b> Enter the program code and press <input type="button" value="CA/AMT/TEND"/> key. The example on the right is for setting check number "123456" for clerk interruption and clerk's secret number "7890".	<b>1 2 3 4 5 6 7 8 9</b> (program code) <input type="button" value="CA/AMT/TEND"/>
<b>5</b> If you wish to set the same program to the next clerk number, perform the step 4 again. When you set to another clerk (not next clerk number), repeat steps 3 and 4.	
<b>6</b> Press <input type="button" value="SUB TOTAL"/> key to complete the settings.	<input type="button" value="SUB TOTAL"/>

### Program code for check number for clerk interruption and clerks' secret number

Description	Selection	Program code
Must be "000000" (six zeros).	000000	<input type="text" value="0"/> <input type="text" value="0"/> <input type="text" value="0"/> <input type="text" value="0"/> <input type="text" value="0"/> <input type="text" value="0"/> D10 D9 D8 D7 D6 D5
Clerks' secret number	Secret number	<input type="text"/> <input type="text"/> <input type="text"/> <input type="text"/> D4 D3 D2 D1

# Advanced programmings and registrations

## Other clerk settings

Step	Operation
1 Turn the Mode switch to PGM position and select [System Setting] then press  key.	 .....  
2 Enter <b>3</b> and press  key to set the register in the programming mode.	<b>3</b> 
3 Enter 2 -digit clerk number followed by 07. The “07” is the identification code for further program of clerks. Then press  key. The example on the right is for programming to clerk number 10.	<b>1 0 0 7</b>  (Clerk no.)
4 Referring the following tables, input the set code you wish to program and press  key. The example on the right is for setting a commission rate.	<b>6 8</b>  (set code)
5 Enter the program code and press  key. The example on the right is for setting 8.5% to commission rate 1 and 5% to commission 2.	<b>0 8 5 0 0 5 0 0</b>  (program code)
6 If you wish to set the same program to the next clerk number, perform the step 5 again. When you set to another clerk (not next clerk number), repeat steps 3 through 5.	
7 Press  key to complete the settings.	

### Set code 67 (Training mode)

Description	Selection	Program code
Training mode	No = 0 Yes = 1	<input type="checkbox"/> D6
Must be “00000”		<b>0 0 0 0 0</b> D5 D4 D3 D2 D1

**Example 1:** To set the clerk number 15 as a clerk being trained.

Press **3**  **1 5 0 7**  **1 0 0 0 0 0**  

### Set code 68 (Commission rates)

Description	Selection	Program code
Commission rate 1 (integer)	00 to 99	<input type="checkbox"/> <input type="checkbox"/> D8 D7
Commission rate 1 (decimal)	00 to 99	<input type="checkbox"/> <input type="checkbox"/> D6 D5
Commission rate 2 (integer)	00 to 99	<input type="checkbox"/> <input type="checkbox"/> D4 D3
Commission rate 2 (decimal)	00 to 99	<input type="checkbox"/> <input type="checkbox"/> D2 D1

# Advanced programmings and registrations

## ■ Programming set menu

This program sets the menu number and sub items' (included in the menu) PLU number. You can set up to 15 items in a set menu.

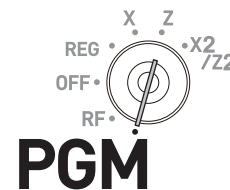









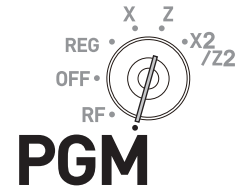







Step	Operation
1 Turn the Mode switch to PGM position and select [System Setting] then press  key.	.....
2 Enter <b>3</b> and press  key to set the register in the programming mode.	<b>3</b>
3 Enter 2 -digit set menu number followed by 28. The “28” is the identification code for setting menu programming. Then press  key.	<b>1 0 2 8</b> This example is for programming set menu number 10.
4 If you wish to use allocated flat PLU, proceed to step 5. If you use normal PLU, enter 4- digit PLU number of an item included in the menu and press  key.	<b>0 0 1 2</b> This example is for setting PLU 0012 in the menu.
5 If you wish to use allocated <flat PLU> key, press <Flat PLU> key. If you use shifted flat PLU, press  and <Flat PLU> keys.	) <Flat PLU>
6 Press  key. If you wish to set another item in the menu, perform the step 4 or 5. To set another menu, repeat the steps 3 through 5.	
7 Press  key to complete the settings.	

# Advanced programmings and registrations

## Programming auto operation of <Arrangement>

By using allocated <Arrangement> key, programmed operations are performed automatically just by pressing <Arrangement> key. The following explains to set the automatic operations.



Step	Operation
<b>1</b> Turn the Mode switch to PGM position and select [System Setting] then press  key.	 .....  
<b>2</b> Enter <b>3</b> and press  key to set the register in the programming mode.	 
<b>3</b> Enter 4- digit record number followed by 38. The “38” is the identification code for arrangement programming. If you enter “0000”, the register searches a vacant record number. Then press  key.	  This example is for searching a vacant arrangement program number.
<b>4</b> Press <Arrangement> key and input 6- digit arrangement number then press  key.	<Arrangement> <input type="text"/> <input type="text"/> <input type="text"/> <input type="text"/> <input type="text"/> <input type="text"/>  Arrangement number
<b>5</b> Input keys you wish to program automatic operations and press <Arrangement> key.	 For programming to register a dozen of •0.50 dept. 01 item.
<b>6</b> Press <Arrangement> and  keys to complete the program.	<Arrangement> 

# Advanced programmings and registrations

## ■ Key allocation

This section explains how you can allocate various functions on the keyboard.

**NOTE** Before you allocate functions on the keyboard, please execute daily and periodic reset (Z) report.

### Allocatable keys

FEED	039	036	033	026	021
040	038	035	032	025	020
C	037	034	031	024	019
7	8	9	030	023	018
4	5	6	029	022	015
1	2	3	028	SUBTOTAL	
0	011	012	027		013

049	057	065	073	081	089	097	105	113
048	056	064	072	080	088	096	104	112
047	055	063	071	079	087	095	103	111
046	054	062	070	078	086	094	102	110
045	053	061	069	077	085	093	101	109
044	052	060	068	076	084	092	100	108
043	051	059	067	075	083	091	099	107
042	050	058	066	074	082	090	098	106

### Step

- 1 Turn the Mode switch to PGM position and select [System Setting] then press  (#013) key.
- 2 Enter  and press  key to set the register in the programming mode.
- 3 If you are allocating department or flat- PLU function, enter the department or flat PLU number in 4 digits. If not, skip this step.
- 4 Referring the following table, input 3- digit function code you wish to allocate.
- 5 Referring the above figure, press corresponding key.
- 6 Repeat step 3 through 5 for another key location.
- 7 Press  key to complete the settings.

### Operation

.....

Dept. or flat PLU number

This example is for allocating <Flat PLU> function.

**Example 1:** To allocate <Flat PLU> number 1000 on #113 key:

[113]

**Example 2:** To allocate <Addition (Plus)> on #049 key:

[049]

## Advanced programmings and registrations

Function	Code	Function	Code	Function	Code
Cash/amount tendered	001	Non-add	040	Multiplication	082
Charge	002	Non-add/no sale	041	Multiplication / For	083
Check tendered	003	No sale	042	New check	091
Credit	004	Customer number	043	Old check	092
New balance	006	Arrangement	044	New/old check	093
Text recall	010	Currency exchange	045	Add check	094
Tip	015	VAT	046	Age verification	106
Received on account	020	PLU	048	Help	141
Paid out	021	Price	049	Sign off	150
Coupon	023	Department	051	Tax Program	151
Reduction (Minus)	027	Tax shift	057	Dept no./Dept shift	152
Discount	028	Flat PLU	063	Cancel	236
Addition (Plus)	029	Menu shift	064	"00" double zero *1	096
Premium	030	Open	067	"000" triple zero *1	097
Manual tax	032	Clerk number	072	"." decimal point *1	098
Refund	033	Subtotal	075		
Error correct/cancel	034	Receipt on/off	076		
Receipt	038	Merchandise subtotal	080		

- <sup>1</sup> Two zero key, three zero key, decimal point key can only be allocated on #011 and #012 keys.

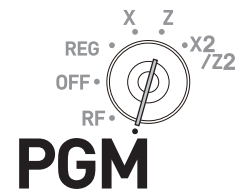

## Printing programmed data

After programs have been set, you can print the programmed data.



## To print programmed unit price or percentage (other than PLU)

### Step

- 1 Turn the Mode switch to PGM position and select [System Setting] then press  key.
- 2 Enter **1** and press  key.
- 3 Press  key again. The printer starts to print preset data.

### Printout





P01.....		1
CASH	@0.00	
-	@1.00	2
%-	10%	
DEPT001	0001-05	3
	@1.00	4
DEPT002	0002-05	
	@2.00	

- 1: Program read symbol
- 2: Transaction key unit price or rate
- 3: Department descriptor/rec-#/05
- 4: Unit price

# Advanced programmings and registrations

## To print programmed characters (except PLUs)

### Step

- 1 Turn the Mode switch to PGM position and select [System Setting] then press  key.
- 2 Enter  and press  key.
- 3 Press  key again. The printer starts to print preset data.

### Printout

P02.....		1
GROSS	0001-01	
NET	0002-01	
CAID	0003-01	2
	0004-01	
	0005-01	
CASH	0001-02	
CHECK	0002-02	3
	0003-02	
	0004-02	
DEPT001	0001-05	
DEPT002	0002-05	4
	0003-05	
	0004-05	
GROUP01	0001-06	
GROUP02	0002-06	5
GROUP03	0003-06	
	0004-06	
C01	0001-07	
C02	0002-07	6
	0003-07	
	0004-07	
GT	0001-20	7
. @No/ ** /		
NoCT @LB *QT	0002-23	8
Y- CUSV	0003-23	
	0001-24	
FIX		
TRANS	0002-24	9
	0003-24	
	0004-24	
DAILY X	0001-29	10
PERIODIC 1X	0002-29	
PERIODIC 2X	0003-29	
	0004-29	
0001-32		
YOUR RECEIPT		11
0002-32		
THANK YOU		
0001-39		
CHARACTER RECALL*****		12
*****		



- 1: Program read symbol
- 2: Fix total character
- 3: Transaction key character
- 4: Department character
- 5: Group character
- 6: Clerk character
- 7: GT character
- 8: Special character
- 9: Report header character
- 10: Batch X/Z character
- 11: Receipt message
- 12: Text recall character



# Advanced programmings and registrations

## To print general programming (except PLUs)

### Step

- 1 Turn the Mode switch to PGM position and select [System Setting] then press  key.
- 2 Enter **3** and press  key.
- 3 Press  key again. The printer starts to print preset data.

### Printout

P03.....		1
CASH	0001-02	
	00000000000000	2
CHECK	0002-02	3
	00000000000000	4
FD	0003-02	
	00000000000000	
DEPT001	0001-05	5
	00000000000000	6
11-66	00000000	7
15-66	@1.23	8
	0002-05	
C01	0001-07	9
	0000010001	10
67	0000000000	11
68	00000000	12
	0001-09	
	00:00 -> 01:00	
	0002-09	13
	01:00 -> 02:00	
	02:00 -> 03:00	
0001-22	2200000000	
0002-22	0000000000	14
0003-22	0000000000	
0001-28		
0002-28		
0001-25		
TX1	10.25%	15
TX1	0000	
TX1	5003	
DAILY X	0001-29	16
00	11-12-17-15-00	
	00-00-00-00-00	
PERIODIC	1X 0002-29	

- 1: Program read symbol
- 2: Transaction key program
- 3: Key character/rec-#/file-#
- 4: Key program
- 5: Department program/Key character/rec-#/file-#
- 6: Key program
- 7: Address code 11 program
- 8: Address code 15 program
- 9: Clerk program/Clerk name/rec-#/file-#
- 10: Check #/secret-#
- 11: Compulsory
- 12: Commission rate
- 13: Time range program
- 14: General control program
- 15: Tax table
- 16: Batch X/Z program

# Advanced programmings and registrations

## Printout

0001-30 NET	0001-01 0020-01	17
0001-38 REG1	000001 204-000	18
1	001-000	19
2	002-000	
DEPT001	026-051	
CASH	013-001	
0001-62	000000 00000000000000 0000000000	20
MC#01	0001-91 00000000	
0001-98	0000000000000000	21
0002-98	0000000000000000	

- 17: Clerk detail link program
- 18: Arrangement program/Rec-#/file-#/arrange no.
- 19: Key descriptor/rec-#/file-#
- 20: Scheduler program
- 21: I/O parameter table

## To print preset unit price of PLU

### Step

- 1 Turn the Mode switch to PGM position and select [System Setting] then press  key.
- 2 Enter **6** and press  key to set the register in the programming mode.
- 3 Enter **1 0 4** and press  key.
- 4 Enter starting PLU number and press  key. For example, if you wish to print from PLU number 0001, input **0 0 0 1** .
- 5 Enter the last PLU number and press  key. For example, if you wish to print up to PLU number 0884, input **0 8 8 4** .

### Printout

P01.....	1
#0001 - #0884	2
PLU0001      0001-04	3
@1.00	4
PLU0002      0002-04	
@2.00	

- 1: Program read symbol
- 2: Range of PLU No.
- 3: PLU name/rec-#/04
- 4: Unit price

# Advanced programmings and registrations

## To print preset characters of PLU

### Step

- 1 Turn the Mode switch to PGM position and select [System Setting] then press  key.
- 2 Enter **6** and press  key to set the register in the programming mode.
- 3 Enter **2 0 4** and press  key.
- 4 Enter starting PLU number and press  key.
- 5 Enter the last PLU number and press  key.

### Printout

```

P02..... 1
      #0001 - #0010 2
PLU0001      0001-04 3
PLU0002      0002-04
PLU0003      0003-04
    
```

- 1: Program 2 mode symbol
- 2: Range of PLU No.
- 3: PLU character

## To print PLU programmings

### Step

- 1 Turn the Mode switch to PGM position and select [System Setting] then press  key.
- 2 Enter **6** and press  key to set the register in the programming mode.
- 3 Enter **3 0 4** and press  key.
- 4 Enter starting PLU number and press  key.
- 5 Enter the last PLU number and press  key.

### Printout

```

P03..... 1
      #0001 - #0010 2
PLU0001      0001-04 3
                0000000000000000 4
11-66                000000 5
13-66      <- 0001-28 6
14-66                0
15-66                @1234.56 7
PLU0002      0002-04
    
```

- 1: Program 3 mode symbol
- 2: Range of PLU No.
- 3: PLU name/rec-#/file-#
- 4: Address code 01 ~ 10, 18 program
- 5: Address code 11 program
- 6: Address code 13 program
- 7: Address code 15 program

## To print key allocation program

### Step

- 1 Turn the Mode switch to PGM position and select [System Setting] then press  key.
- 2 Enter **4** and press  key to set the register in the programming mode.
- 3 Press  key.

### Printout

```

P03..... 1
1----- 2
00      0015-02 3
        011-096
.      0009-02
        012-098
CASH   0004-02
        013-001
    
```

- 1: Program read symbol
- 2: Function character/rec-#/file-#
- 3: Hard key code/function code

# Advanced programmings and registrations

## Printing various sales reports

You can print categorized sales reports such as PLU sales report, item group sales report, hourly sales report etc.

**NOTE**

- Please do not perform the reset (Z) report during the business hour as it clears stored sales data from the memory.
- Please see page E-52 for printout sample of a daily report.

## Printing various sales reports

The followings are the example operation for printing an electronic journal of February 28, 2013.

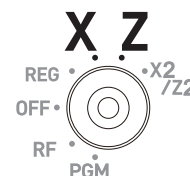

### Step

**1** Turn the Mode switch to X or Z position. The display shows the top menu of sales reports.

**2** Using or keys select the report you wish to obtain. The example on the right is for selecting electronic journal. As it is the lowest column, [EJ ] is hidden from the default top menu. Select it by keep pressing key.

**3** Press key. The display shows the next screen asking date or consecutive number. Select [Date] and press key.

**4** Input year, month, and day from ten key pad. The journal of assigned date will be printed if you press key.

### Display

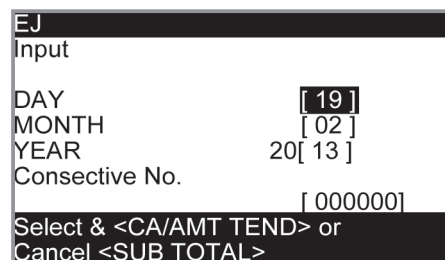
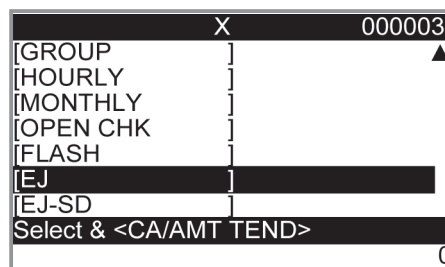
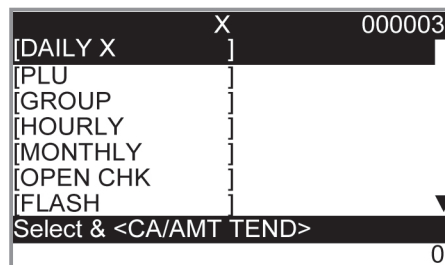

# Advanced programmings and registrations

## ■ PLU sales report

X	PLU		0000014	1
				2
	PLU0001	17		3
	0.53%		·17.00	4
	#0001			5
	PLU0100	42		
	1.03%		·69.00	
	#0100			
-----				
	TL	188.61		6
			·516.10	7

- 1 Read symbol/report title
- 2 Report code
- 3 PLU name/Quantity
- 4 Sales ratio/PLU amount
- 5 PLU code
- 6 Total Quantity
- 7 Total amount

## ■ Item group sales report

X	GROUP		0000016	1
				2
	GROUP01	203.25		3
	33.87%		·1,108.54	4
	GROUP02	183		
	40.58%		·1,327.80	
	GROUP03	12		
	0.40%		·13.25	
	GROUP99	13		
	0.54%		·17.80	
-----				
	TL	862		5
			·3,272.00	6

- 1 Read symbol/report title
- 2 Report code
- 3 Group No./Quantity
- 4 Sales ratio/group amount
- 5 Total quantity of group
- 6 Group total amount

## ■ Hourly sales report

X	HOURLY		0000019	1
				2
	00:00->01:00			3
	CT	1		4
	GROSS		·1.10	5
	NET	No	1	6
	1.90%		·1.20	7
	23:00->00:00			
	CT	1		
	GROSS		·3.45	
	NET	No	1	
	3.90%		·3.59	
-----				
	TL	CT	280	8
	GROSS		·1,937.61	9
	NET	No	25	10
			·2,096.80	11

- 1 Read symbol/report title
- 2 Report code
- 3 Time zone
- 4 No. of customers
- 5 Gross sales amount
- 6 No. of receipts
- 7 Sales ratio/net sales amount
- 8 Total No. of customers
- 9 Gross total amount
- 10 Total No. of receipt
- 11 Net total amount

# Advanced programmings and registrations

## ■ Monthly sales report

X	MONTHLY		1
		0000020	2
	1.....		3
GROSS		1236.76	4
		·12,202.57	5
NET	No	214	6
		·12,202.57	7
	31.....		
GROSS		2132	
		·14,187.57	
NET	No	205	
		·13,398.76	
-----			
TL			8
GROSS		9746.63	9
		·161,022.49	10
		·16.52	11
NET	No	2351	12
		·161,022.49	13
		·68.49	14

- 1 Read symbol/report title
- 2 Report code
- 3 Month
- 4 Gross symbol/Quantity
- 5 Gross sales amount
- 6 Net symbol/No. of customers
- 7 Net sales amount
- 8 Total symbol
- 9 Gross symbol/Quantity
- 10 Gross sales amount
- 11 Daily gross sales average
- 12 Net symbol/No. of customers
- 13 Net sales amount
- 14 Daily net sales average

## ■ Flash report

X	FLASH		1
		0000071	2
DECLA		·6,919.04	3
		·0.00	4
GROSS		111.15	5
		·7,054.14	
NET	No	120	6
		·7,263.20	
CAID		·6,919.04	7

- 1 Read report symbol/report title
- 2 Report code
- 3 Declared amount
- 4 Difference
- 5 Gross total
- 6 Net total
- 7 Cash in drawer

### About “Declared money” and “Cash in drawer”

If you programmed the register to force entry of total amount in drawer, you need to count the money in the drawer and input the amount (money declaration) before read (X) or reset (Z) report printing. On the other hand, “Cash in drawer” is the total money in the drawer calculated by the register so that you can compare the actual amount and the calculated amount.

To program money declaration, please see page E-87.

# Advanced programmings and registrations

## ■ Open check report

Z	OPEN CHECK		1
		0001025	2
REG	06-20-2013	11:58	3
C01	0001	000004	4
TABLE	No. 123456	CT 12	5
CHECK	No. 123		6
		-250.00	7
REG	06-20-2013	11:58	3
C01	MC#01	000006	4
TABLE	No. 111111	CT 14	5
CHECK	No. 12345678		6
BUSY		-300.00	8
TL	No	28	9
		-1,374.00	10

- 1 Report header/title
- 2 Report code
- 3 Mode symbol/date/time
- 4 Clerk descriptor/Mc- No./consecutive No.
- 5 Table No./No. of customer
- 6 Check No.
- 7 Subtotal amount
- 8 Print "BUSY", if the check is currently opened.
- 9 No. of open check
- 10 Open check total

## ■ Electronic journal

X	E-JOURNAL		1
		0000058	2
REG	06-20-2013	11:58	3
C01	0001	000123	4
1	DEPT01	T1	·1.00
1	DEPT02	T1	·2.00
5	DEPT03		·5.00
		7 No	3
TA1			
TX1		·0.15	
TX1		·0.10	
TL		-8.10	
CASH		·10.00	
CG		·1.90	
REG	06-20-2013	11:59	3
C01	0001	000124	4

- 1 Report header/title
- 2 Report code
- 3 Journal image

### About electronic journal

Instead of printing days' sales journal, the register stores daily sales report in the memory and you can obtain the report by assigning day or consecutive number.

# Advanced programmings and registrations

## To print individual department, PLU, and Flat PLU

Instead of printing sales reports in a lump, you can obtain reports of specific departments, PLUs, or Flat PLUs.

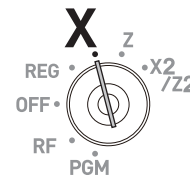

### Step

- 1 Turn the Mode switch to X position.
- 2 Just press department keys or enter PLU numbers.  
For example,  for Dept.003.  
 <Dept. no./Dept. shift>   <Dept. no./Dept. shift> for PLUs 1 and 89.  
  for flat PLUs 0001 and 0002.
- 3 Press  key to exit from individual report printing.

### Printout

X	INDIVIDUAL		1
	DEPT028	38	2
	8.13%	·257.53	3
	PLU0001	17	4
	0.53%	·17.00	5
	#0001		6
-----			
	TL	88.61	7
		·516.10	8

- 1: Read symbol/report title
- 2: Department Name/No. of items
- 3: Sales ratio/amount
- 4: PLU Name/No. of items
- 5: Sales ratio/PLU amount
- 6: PLU code
- 7: Total No. of items
- 8: Total amount

## Periodic sales report

Apart from daily report, you can obtain periodic sales report. The register prints total sales data from the last periodic report. Namely, if you do this operation monthly, you can obtain monthly sales reports. The cash register allows you to obtain two kinds of periodic reports so that not only monthly reports, you can also get weekly reports.

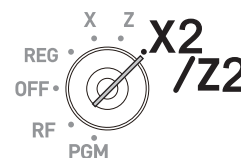

### Step

- 1 Turn the Mode switch to X2 or Z2 position. The display shows report selection screen.
- 2 Select a report using  or  keys. Z1 and Z2 clear the accumulated data while X1 and X2 store the sales data remained.
- 3 Press  key. The printer prints out the periodic report.

### Display

XZ	000003
[PERIODIC 1X]	
[PERIODIC 2X]	
[PERIODIC 1Z]	
[PERIODIC 2Z]	
Select & <CA/AMT TEND>	0



# Advanced programmings and registrations

-----					
ZZ1 PERIODIC 1Z					1
-----					
ZZ1 DEPT		0001			2
		0001115			3
DEPT001		38			4
8.13%		.257.53			5
DEPT002		18			
-----					
TL		88.61			6
		.1,916.10			7
-----					
ZZ1 FIX		0001			8
		0001111			9
GROSS		981.25			10
		.6,574.40			
NET	No	111			11
		.7,057.14			
CAID		.6,919.04			12
CHID		.139.04			13
CKID		.859.85			14
CRID(1)		.709.85			15
CRID(2)		.0.00			16
CRID(3)		.0.00			17
CRID(4)		.0.00			18
-----					
RF	No	3			19
		.10.22			
CUST	CT	111			20
AVRG		.63.57			21
DC		.1.22			22
REF		.2.42			23
ROUND		.0.00			24
CANCEL	No	2			25
		.12.97			
-----					
TA1		.2,369.69			26
TX1		.128.86			27
TA2		.2,172.96			28
TX2		.217.33			29

- 1 Report title
- 2 Department report title/reset counter
- 3 Report code
- 4 Department Name/No. of items \*1
- 5 Sales ratio/amount \*1
- 6 Total No. of items
- 7 Total amount
- 8 Fixed total report title/reset counter
- 9 Report code
- 10 Gross total \*2
- 11 Net total \*2
- 12 Cash in drawer \*2
- 13 Charge in drawer \*2
- 14 Check in drawer \*2
- 15 Credit in drawer 1 \*2
- 16 Credit in drawer 2 \*2
- 17 Credit in drawer 3 \*2
- 18 Credit in drawer 4 \*2
- 19 Refund mode \*2
- 20 Customer number \*2
- 21 Average sales per customer \*2
- 22 Discount total \*2
- 23 Refund key \*2
- 24 Rounding total \*2
- 25 Cancellation \*2
- 26 Taxable 1 amount \*2
- 27 Tax 1 amount \*2
- 28 Taxable 2 amount \*2
- 29 Tax 2 amount \*2

# Advanced programmings and registrations

-----				
ZZ1	TRANS		0001	1
			0001112	2
CASH	No	362		3
			·1,638.04	
CHARGE	No	56		
			·1,174.85	
RC	No	4		
			·810.00	
PD			5	
			·5.00	
CORR	No	14		
			·39.55	
RCT	No	3		
NS	No	5		
-----				
ZZ1	CASHIER		0001	4
			0001117	5
C01	.....	1		6
NET	No	111		
			·1,845.35	7
C02	.....	1		8

- 1 Function key report title/reset counter
- 2 Report code
- 3 Function key count/amount \*1
- 4 Clerk report title/reset counter
- 5 Report code
- 6 Clerk name
- 7 Net total
- 8 Clerk name

- <sup>1</sup>Zero totalled departments/functions (the amount and item numbers are both zero) are not printed.
- <sup>2</sup>These items can be skipped by programming.

## Using an SD card

You can store sales data or program data to an SD card or you can restore the data from SD card to your cash register.

The following table explains what you can do with an SD card.

[Backup→SD]	Stores sales data and program data of register to SD card.
[Restore←SD]	Restores sales data and program data from SD card to register.
[Program→SD]	Stores program data to SD card.
[Program←SD]	Restores program data from SD card to register.
[Backup→Flash]	Stores program data into the register's built-in flash memory (for a case of power failure with flat batteries).
[SD Format]	Formats an SD for the first usage.

The following sections explain the operation examples of the features using an SD card.

### To format an SD card

When you use a new SD card, you must format the SD card first.

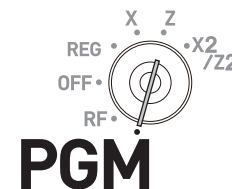

**NOTE** All the data stored in the SD card will be cleared if you execute formatting.

#### Step

#### Display

- 1 Insert an SD card into the SD card slot.
- 2 Turn the Mode switch to PGM position and select [SDcard Setting].
- 3 Press  key.  
Select [SD Format] on the SD card setting screen.
- 4 Select [YES] and press  key.  
The register starts to format the SD card.

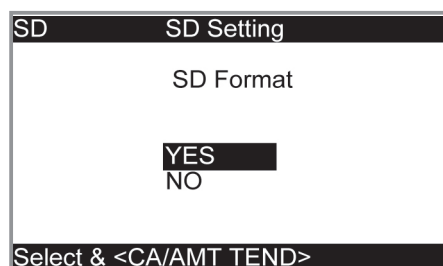
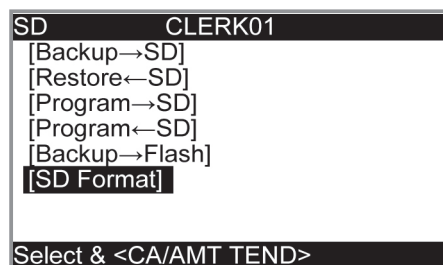
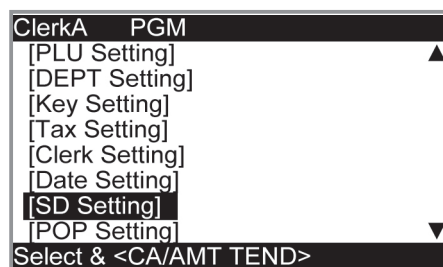

# Advanced programmings and registrations

## Step

**5** Now the SD card is formatted and you can use it for storing cash register data in it.

## Display

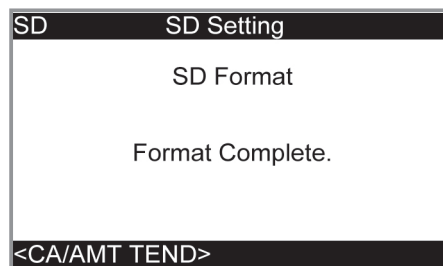

## To store program data in an SD card

The following operation explains how you can back up all the program data in an SD card.

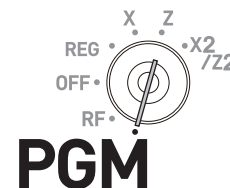

## Step

- 1 Insert an SD card into the SD card slot.
- 2 Turn the Mode switch to PGM position and select [SDcard Setting]. Then press key.

## Display

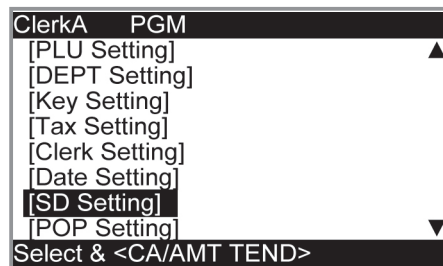

**3** Select [Program→SD] and press key.

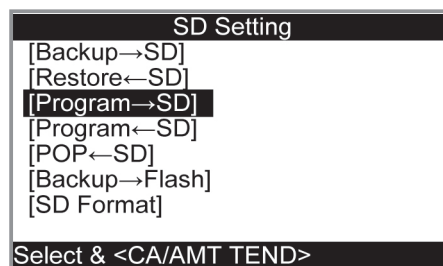

**4** Select [YES] and press key.

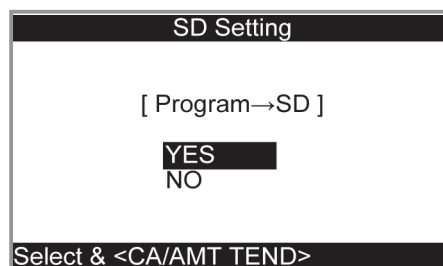

**5** After for a while, the display indicates “Backup complete”.

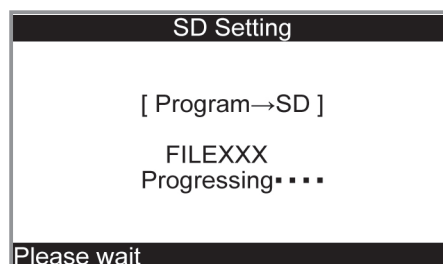

## Before you consider it as a problem

### Error code table

Error code	Message	Meaning	Action
E001	Wrong mode	Mode switch position changed before finalization.	Return the mode switch to its original setting and finalize the operation.
E003	Wrong operator	The signed on clerk differs from the clerk performed the tracking check registration.	Input correct check number or assign the proper clerk number.
E004	Error INIT/FC	Initialization or unit lock clear operation in progress.	Complete operation.
E008	Please sign on	Registration without entering a clerk number.	Enter a clerk number.
E010	Close the drawer	The drawer is left open longer than the program time (drawer open alarm).	Close the drawer.
E011	Close the drawer	Attempt to register while the cash drawer is open.	Close the drawer.
E016	Change back to REG mode	Two consecutive transactions attempted in the refund mode.	Switch to another mode and then back to the RF mode for the next transaction.
E017	Enter CHK/TBL number	Attempt made to register an item without inputting a check number.	Input a check number.
E018	Enter Table number	Attempt made to register an item without inputting a table number.	Input a table number.
E019	Enter number of customers	Finalize operation attempted without entering the number of customer.	Enter the number of customer.
E021	No DEPT Link	No department linked PLU is registered.	Correct the program.
E026	Enter condiment/preparation PLU	No condiment/preparation PLU is registered.	Register condiment/preparation PLU.
E029	In the tender operation	Item registration is prohibited, while partial tender.	Finalize the transaction.
E031	Press ST key	Finalization of a transaction attempted without confirming the subtotal.	Press  key.
E033	Enter tendered amount	Finalize operation attempted without entering amount tender.	Enter the amount tendered.
E035	Change amount exceeds limit	Change amount exceeds preset limit.	Input amount tendered again.
E036	Remove money from the drawer	Contents of the drawer exceed programmed limit.	Perform payout operation.
E037	Digit or amount limitation over	High amount lock out/low digit lock out error	Enter correct amount.
E038	Perform money declaration	Read/reset operation without declaring cash in drawer.	Perform money declaration.

## Advanced programmings and registrations

Error code	Message	Meaning	Action
E040	Issue guest receipt	Attempt to register a new transaction without issuing a guest receipt.	Issue a guest receipt.
E046	REG buffer full	Registration buffer full.	Finalize the transaction.
E049	CHECK memory full	Check tracking index memory full.	Finalize and close the check number currently used.
E050	DETAIL memory full	Check tracking detail memory full.	Finalize and close the check number currently used.
E051	CHK/TBL No. is occupied	Attempt to made use <New Check> to open a new check using a number that is already used for an existing check in check tracking memory.	Finalize and close the check that is currently under the number that you want to use or use a different check number.
E053	CHK/TBL No. is not opened	Attempt made to use <Old Check> reopen a new check using a number that is not used for an existing check in check tracking memory.	Use the correct check number (if you want to reopen a check that already exists in check tracking memory) or use <New Check> to open a new check.
E075	Negative balance cannot be finalized	Attempt to finalize a transaction when balance is less than or equal to zero.	Register item(s) until the balance becomes positive amount.
E101	PLU maintenance file full. Press <#2> to exit	Scanning PLU direct maintenance/ batch maintenance file becomes full.	Terminate the maintenance.
E103	PLU Code is not exist. Input the PLU Code	PLU code is not existed in the file.	Enter proper PLU code.
E105	PLU file full	Scanning PLU file full	Modify the designated item.
E106	Item exists in the PLU FILE	The designated item has already existed in the scanning PLU file.	
E112	Close the journal platen arm	The journal platen arm is opened.	Close the journal platen arm.
E114	Close the receipt platen arm	The receipt platen arm is opened.	Close the receipt platen arm.
E139	Negative balance is not allowed	Attempt to register <--> or <CPN> when the balance becomes negative.	Enter proper minus/coupon amount.
E146	Arrangement file full	Arrangement file is full.	Set the arrangement properly.
E200	Insert SD	SD is set.	Set SD.
E201	Illegal Format	Illegally formatted SD	Format the SD.
E202	File not found	The designated file is not found in the SD.	Enter proper file name.
E205	File already exist.	Can not write, because designated file has already been in the SD.	Check the operation and retry.

## When “EJ FULL” sign appears on the display

When the register shows this sign, issue electronic journal read report (if necessary) and reset the memory immediately.

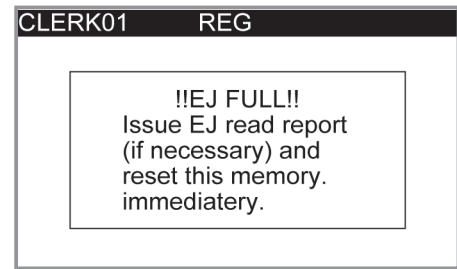

## In case of power failure

If the power supply to the cash register is cut by a power failure or any other reason, simply wait for power to be restored. The details of any ongoing transaction as well as all sales data in memory are protected by the memory backup batteries. (This is the reason to install the batteries.)

- Power failure during a registration  
The subtotal for items registered up to the power failure is retained in memory. You will be able to continue with the registration when power is restored.
- Power failure during printing a read / reset report  
The data already printed before the power failure is retained in memory. You will be able to issue a report when power is restored.
- Power failure during printing of a receipt / journal  
Printing will resume after power is restored. A line that was being printed when the power failure occurred is printed in full.
- Other  
The power failure symbol is printed and any item that was being printed when the power failure occurred is reprinted in full.

## In case the register is locked up

If you make a mistake in operation, the cash register may lock up to avoid damage to programs and preset data. Should it happens, you can use the following procedure to clear the lock up without losing any data.

- 1** Power off the register.
- 2** Insert the PGM key in the mode switch.
- 3** Press down , and turn the mode switch to PGM mode.
- 4** The display shows 0.00, then release .
- 5** Press  then issue a receipt.

# Advanced programmings and registrations

## About the low battery indicator

If this indicator appears when you switch the cash register on, it can mean one of three things:

- No memory backup batteries are loaded in the cash register.
- The power of the batteries loaded in the unit is below a certain level.
- The batteries loaded in the unit are dead.

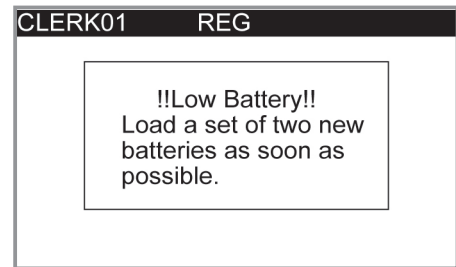

### Important !

Whenever the low battery indicator appears on the display, load a set of two new batteries as soon as possible. If there is a power failure or you unplug the cash register when this indicator appears, you will lose all of your sales data and settings.

**Be sure to keep the power cord of the cash register plugged in whenever you replace the batteries.**

Category	No. of totalizers	Contents				Periodic totalizer
		Amount (10 digits)	No. of items (4 digits)	Count (4 digit)	No. of items (4 digits)	
Department	200	○ *1	○ *3			○
PLU	3000	○ *1	○ *3			
Hourly sales	24	○ *1		○ *4	○ *5	
Monthly sales	31	○ *1			○ *5	
Clerk	50	○ *1			○ *5	
Transaction key & fix total	--	○ *1 or ○ *3 or ○ *4 or ○ *5				○
Non resettable grand sales total	1	○ *2				
Reset counter	8			○ *4		○
Comsecutive No.	1				○ *5	

- <sup>1</sup> -9,999,999.99 ~ 99,999,999.99

- <sup>2</sup> -9,999,999,999,999.99 ~ 99,999,999,999,999.99

- <sup>3</sup> -99,999.999 ~ 999,999.999

- <sup>4</sup> 1 ~ 9999

- <sup>5</sup> 1 ~ 999999

Specifications and design are subject to change without notice.



# Advanced programmings and registrations

## Specifications

Entry	10-key system, buffer memory 8 keys (2-key roll over)
Department	Full key system
Main display	26 characters x 10 lines, Dept. name, PLU name, Total, Transaction names, Change
Customer display	20 characters x 1 line. Amount 10 digits (zero suppression)
Printer	
Receipt/Journal	Thermal alpha-numeric system 24 digits, receipt on/off key
	Store name or slogan is printed automatically
Paper roll	58 (W) × 80 (D) mm
Paper thickness	0.06 to 0.08 mm
Paper feed	Receipt or Journal
Print speed	About 14 l/s
Listing capacity	
Amount	9999999999
Quantity	9999.999
Tendered amount	9999999999
Percent	99.99
Tax rate	9999.9999
Numbers	9999999999999999
Chronological data	
Date print	Automatic date printout on receipt or journal, automatic calendar
Time print	Automatic time printout on receipt or journal, 24-hour system/12-hour system
Alarm	Key catch tone, error alarm
Memory protection battery	The effective service life of memory protection batteries (two new size AA manganese batteries) is approximately one year from installation into the machine.
Power supply/power consumption	See the rating plate.
Operation temperature	32°F to 104°F (0°C to 40°C)
Humidity	10 to 90%
Dimensions	220 mm (H) × 400 mm (W) × 450 mm (D) (8.6" (H) × 15.7" (W) × 17.7" (D))
Weight	10 kg (22 lbs.).

