

The cover features a dark brown horizontal band with a white brushstroke effect. The title is centered in white, bold, italicized text. The background is white with a faint, light gray geometric pattern of overlapping hexagons and lines. A vertical gray bar is on the right side.

***SOHOSpeed
ADSL Ethernet/Wireless Gateway
User's Manual***

**Revision 1.0
July 2004**

Table of Contents

1. INTRODUCTION	4
1.1 FEATURES	4
2. GATEWAY OVERVIEW	5
2.1 PORTS AND BUTTONS	5
2.2 LED DESCRIPTION	6
3. INSTALLING YOUR GATEWAY	7
4. SETTING UP YOUR GATEWAY	8
4.1 LOG INTO YOUR GATEWAY	8
4.2 HOME SCREEN	9
4.3 SETUP	10
4.3.1 <i>Wide Area Network Connection</i>	10
4.3.2 <i>Local Area Network Connection</i>	10
4.4 CONFIGURING THE WAN	10
4.4.1 <i>New Connection</i>	11
4.4.1.1 Bridged gateway profile and Connection	11
4.4.1.2 PPPoA Connection Setup	12
4.4.1.3 PPPoE Connection Setup	13
4.4.1.4 DHCP Connection Setup	14
4.4.1.5 Static Connection Setup	15
4.4.1.6 Classical IP over ATM Connection Setup	16
4.4.2 <i>Modify an Existing Connection</i>	17
4.4.3 <i>Modem Setup</i>	17
4.5 CONFIGURING THE WLAN	18
4.6 CONFIGURING THE LAN	19
4.6.1 <i>Enable/Disable DHCP</i>	20
4.6.2 <i>Changing the gateways IP address</i>	21
4.6.2.1 Static IP address assignment	21
4.6.3 <i>Firewall/NAT Services</i>	22
4.7 ADVANCED	22
4.7.1 <i>Wireless Security</i>	23
4.7.1.1 WEP	23
4.7.1.2 802.1x.....	24
4.7.1.3 WPA.....	25
4.7.2 <i>Wireless Management</i>	26
4.7.2.1 Access List	26
4.7.2.2 Associated Stations	27
4.7.2.3 Multiple SSID	28
4.7.3 <i>UPnP</i>	29
4.7.4 <i>Port Forwarding</i>	30
4.7.5 <i>Advanced Security</i>	31
4.7.5.1 DMZ configuration	31
4.7.5.2 Enable Remote Web	31
4.7.5.3 Enable Remote Telnet.....	32
4.7.5.4 Enable Incoming ICMP Ping	32
4.7.6 <i>Access Control</i>	32
4.7.7 <i>LAN clients</i>	32

4.7.8	<i>Bridge Filters</i>	32
4.7.9	<i>Multicast</i>	34
4.7.10	<i>Static Routing</i>	35
4.7.11	<i>Dynamic Routing</i>	36
4.8	TOOLS	37
4.8.1	<i>System Commands</i>	37
4.8.2	<i>Remote Log</i>	37
4.8.3	<i>User Management</i>	38
4.8.4	<i>Update Gateway</i>	38
4.8.5	<i>Ping Test</i>	39
4.8.6	<i>Modem Test</i>	39
4.8.7	<i>UI Support</i>	39
4.9	STATUS	40
4.9.1	<i>Network Statistics</i>	40
4.9.2	<i>Connection Status</i>	40
4.9.3	<i>DHCP Clients</i>	40
4.9.4	<i>Modem Status</i>	40
4.9.5	<i>Product Information</i>	40
4.9.6	<i>System Log</i>	40
5.	APPENDIX A: TROUBLESHOOTING	41
5.1	THE GATEWAY IS NOT FUNCTIONAL.	41
5.2	I CAN'T CONNECT TO THE GATEWAY.	41
5.3	THE LEDs BLINK IN A SEQUENTIAL PATTERN.	42
5.4	THE DSL LINK LED CONTINUES TO BLINK BUT DOES NOT GO SOLID.	42
5.5	THE DSL LINK LED IS ALWAYS OFF.	42
6.	GATEWAY TERMS	43

1. Introduction

The SOHOSpeed ADSL Gateway is the perfect high-speed WAN bridge/router. This full-featured product is specifically designed to connect to the Internet and directly connect to your local area network via high speed 10/100 Mbps Ethernet or 802.11b/g. The gateway also has full NAT firewall and DMZ services to block unwanted users from accessing your network.

1.1 Features

- Equipped with a 1 or 4-Port 10/100 Ethernet Switch
- Equipped with IEEE 802.11b/g WLAN AP (wireless models)
- High speed wireless connection, up to 54 Mbps (wireless models)
- Connects multiple PCs to the Internet with just one WAN IP Address (when configured in router mode with NAT enabled)
- Configurable through user-friendly web pages
- Supports Single-Session IPSec and PPTP Pass-Through for Virtual Private Network (VPN)
- Several popular games are already pre configured. Just enable the game and the port settings are automatically configured.
- Configurable as a DHCP Server on Your Network
- Compatible with virtually all standard Internet applications
- Industry standard and interoperable DSL interface
- Address Filtering, DMZ Hosting, and Much More
- Support 64, 128 and 256 bits WEP / WPA / WPA-PSK / 802.1x (wireless models)
- Simple web based status page displays a snapshot of your system configuration, and links to the configuration pages
- Downloadable flash software upgrades
- Support for up to 8 Permanent Virtual Circuits (PVC)
- Support for up to 8 PPPoE sessions
- Supports Classical IP over ATM (CLIP or also referred to as RFC1577)

2. Gateway Overview

Your gateway has many ports, switches and LEDs. Let's take a look at the different options. Depending upon your model of gateway, your gateway may have some or all of the features listed below

2.1 Ports and Buttons

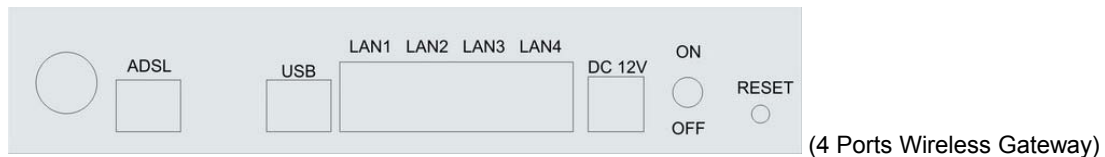
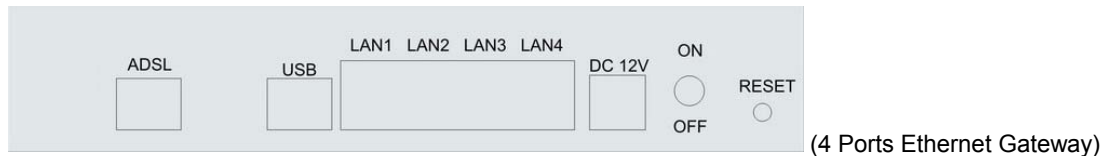
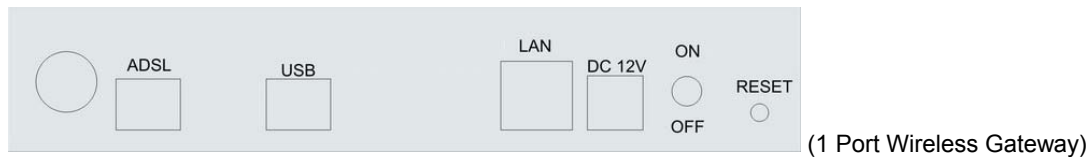
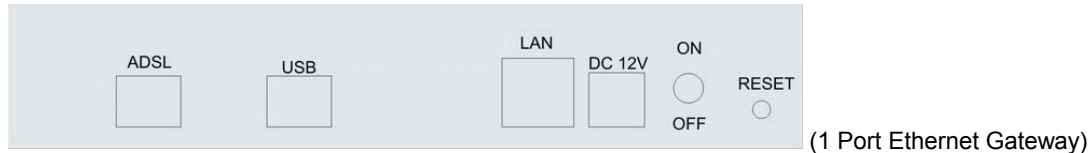

RESET: The RESET button will set the gateway to its factory default setting and reset the gateway. You may need to place the gateway into its factory defaults if the configuration is changed, you lose the ability to enter the gateway via the web interface, or following a software upgrade, and you lose the ability to enter the gateway. To reset the gateway, simply press the reset button for more than 10 seconds. The gateway will be reset to its factory defaults and after about 30 seconds the gateway will become operational again.

POWER: Connect the power adapter that came with the Gateway. Using a power supply with a different voltage rating will damage this product. Make sure to observe the proper power requirements. The power requirement is 12 volts.

LAN (local area network) port(s): Connect to Ethernet network devices, such as a PC, hub, switch, or router. Some gateways come with a single LAN connection and some come with four LAN connections. Depending on the connection, you may need a cross over cable or a straight through cable.

USB (universal serial port): Connects this port to a PC's USB port. The gateway only supports Windows-based PCs via an RNDIS driver (included in the software).

ADSL port: This is the WAN interface which connects directly to your phone line.

2.2 LED Description

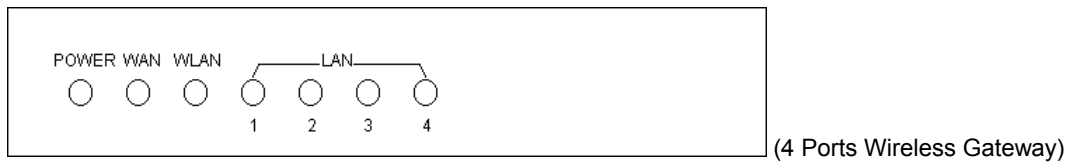
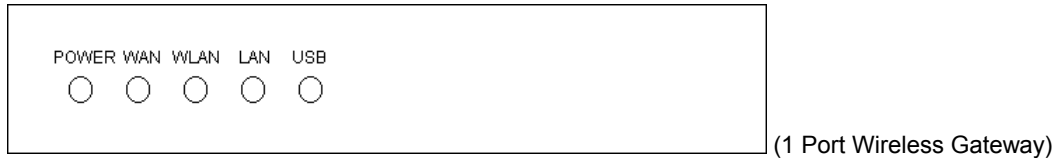
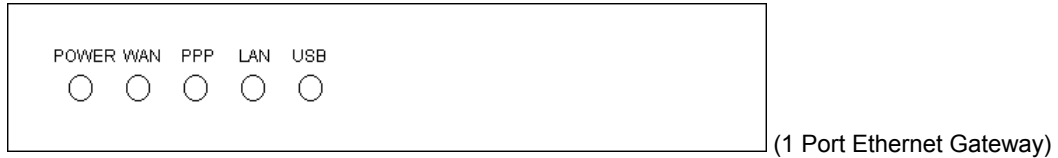

Power LED: The LED stays lighted to indicate the system is power on properly.

WAN LED: This LED is lighted when the WAN connection is established and flashes when the WAN port is sending/receiving data.

WLAN LED: This LED is lighted when a wireless link is established and flashes when the data is sending/receiving via wireless. (wireless models)

PPP LED: This LED is lighted when a PPP link is established and flashes when the data is sending/receiving via PPP. (Ethernet models)

LAN LED: The LED is lighted when a connection is established to LAN port and flashes when LAN port is sending/receiving data. (The number of LAN ports depends on your model.)

USB LED: The LED is lighted when a connection is established to USB port and flashes when USB port is sending/receiving data.

3. Installing Your Gateway

1. Locate an optimum location for the gateway.
2. For connections to the Ethernet and DSL interfaces, refer to the quick start guide.
3. Connect the AC Power Adapter. Depending upon the type of network, you may want to put the power supply on an uninterruptible supply. Only use the power adapter supplied with the gateway. A different adapter may damage the product.

Now that the hardware installation is complete, proceed to **Chapter 4: Setting up your gateway**

4. Setting up Your Gateway

This section will guide you through your gateway's configuration. The gateway is shipped with a standard default bridge configuration; for most users, you may want to change the gateway from a bridge to a router.

4.1 Log into Your Gateway

To configure your gateway, open your web browser. You may get an error message at this point; this is normal. Don't panic. Continue following these directions. Type the default IP address (**192.168.1.1**) Press the **Enter** key and the following screen, shown in Figure 1 will appear. The default user name is **Admin** (case sensitive) and the password is **Admin** (case sensitive).

Note: Before setting up your gateway, make sure you have followed the quick start guide. You should have your computers configured for DHCP mode and have proxies disabled on your browser. Also if you access the Gateway, and instead of getting a login screen, the browser instead displays a login redirection screen, you should check your browser's setting, and verify that JavaScript support is enabled. Also, if you do not get the screen shown in Figure 1, you may need to delete your temporary Internet files (basically flush the cached web pages).

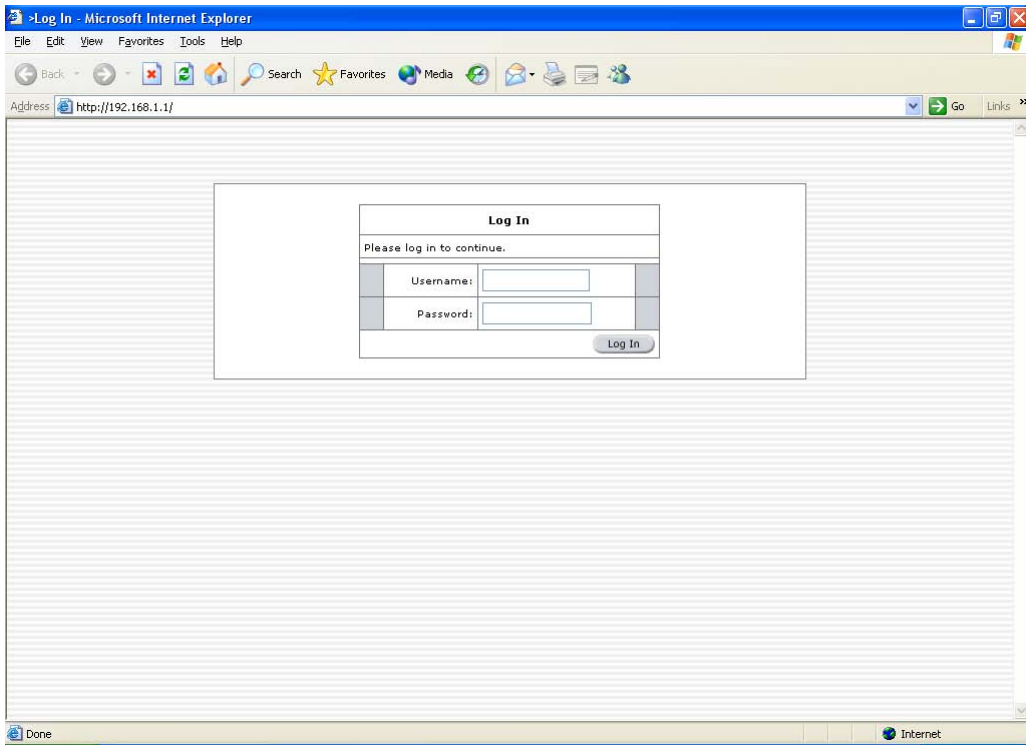

Figure 1 (Log-in screen)

4.2 Home Screen

The first screen (Figure 2) that appears (after the log in screen) is the Home screen. From this screen the user can setup the modem (configure the LAN and WAN connection(s), configure the advanced configuration options within the modem (security, routing, and filtering), access tools that are helpful for debug purposes, obtain the status of the modem, and view the extensive online help.

The basic layout of the Home page consists of a page selection list across the top of the browser window. The footer displays gateway status, connection information, and other useful information. The center display is where most of the configuration will take place.

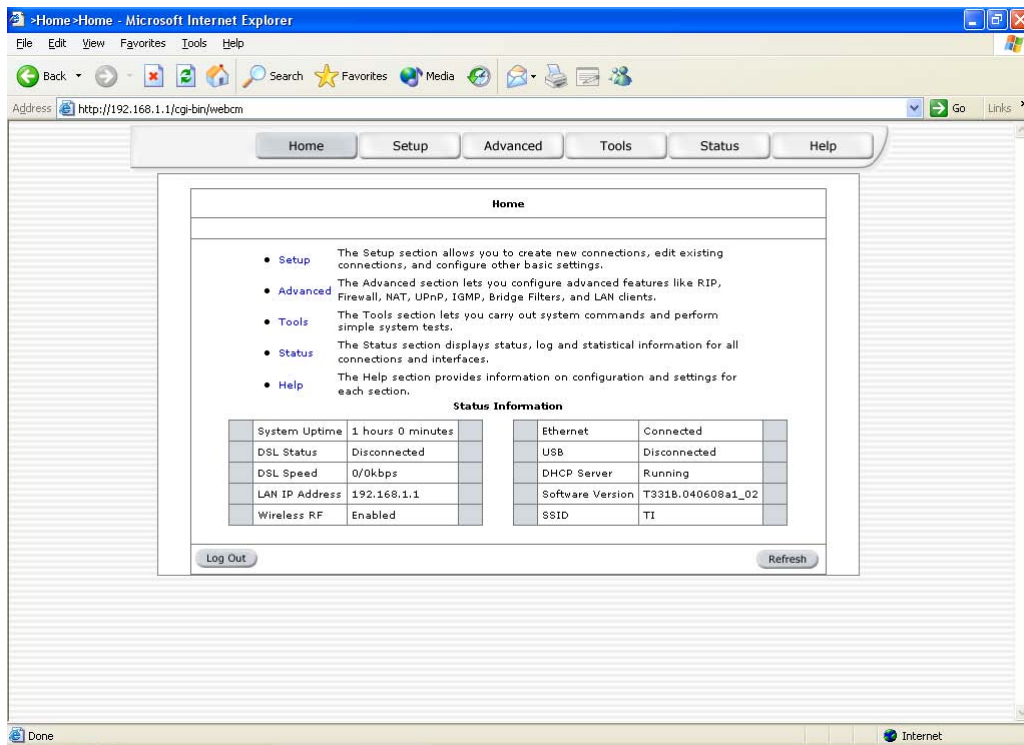

Figure 2 (Home page)

4.3 Setup

To setup your gateway with a basic configuration, from the Home page, select Setup. Figure 3 illustrates the setup page. The page is broken into two subsections the WAN configuration and the LAN configuration.

Before configuring the Gateway, there are several concepts that you should be familiar with on how your new Gateway works. Please take a moment to familiarize yourself with these concepts, as it should make the configuration much easier.

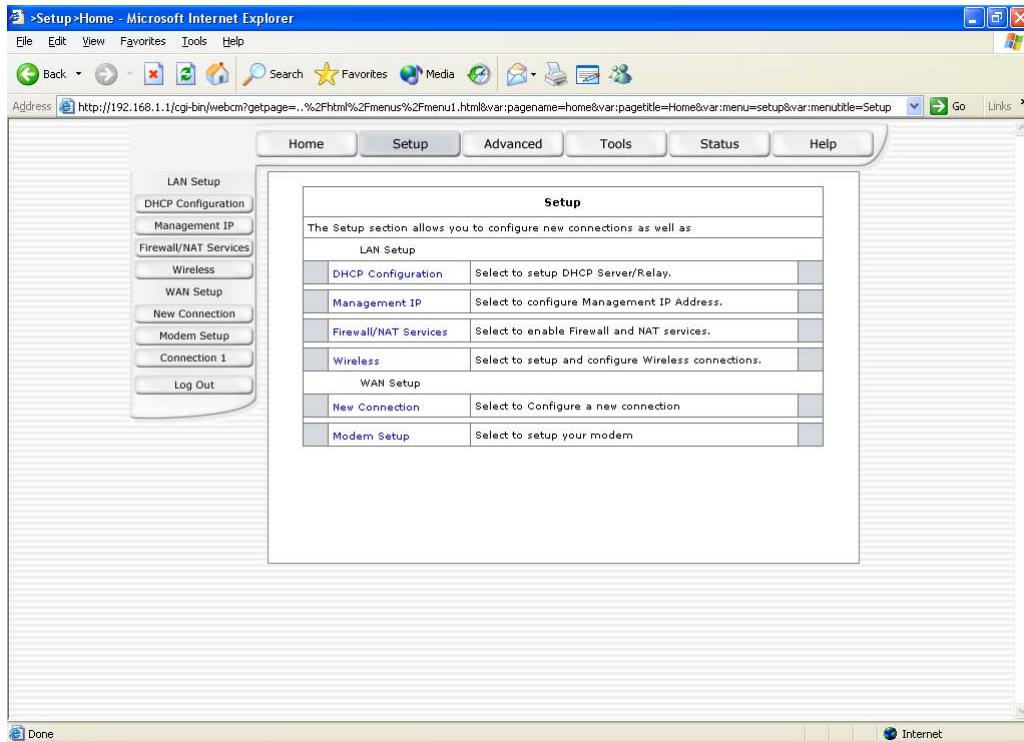

Figure 3 (Setup page)

4.3.1 Wide Area Network Connection

On the other side of the Gateway is where your Wide Area Network (WAN) connection; also referred to as a broadband connection. This WAN connection is different for every WAN supplier. Most of the configuration you will perform will be in this area.

4.3.2 Local Area Network Connection

On one side of your Gateway, you have your own Local Area network (LAN) connections. This is where you plug in your local computers to the Gateway. The Gateway is normally configured to automatically provide all the PC's on your network with Internet addresses.

4.4 Configuring the WAN

Before the gateway will pass any data between the LAN interface(s) and the WAN interface, the WAN side of the modem must be configured. Depending upon your DSL service provider or your ISP, you will need some (or all) of the information outlined below before you can properly configure the WAN:

- Your DSL line VPI and VCI
- Your DSL encapsulation type and multiplexing
- Your DSL training mode (default is MMODE)

For **PPPoA** or **PPPoE** users, you also need these values from your ISP:

- Your username and password

For **RFC 1483** users, you may need these values from your ISP:

- Your DSL fixed Internet IP address
- Your Subnet Mask
- Your Default Gateway
- Your primary DNS IP address

4.4.1 New Connection

A new connection is basically a virtual connection. Your gateway can support up to 8 different (unique) virtual connections. If you have multiple different virtual connections, you may need to utilize the static and dynamic routing capabilities of the modem to pass data correctly.

4.4.1.1 Bridged gateway profile and Connection

A pure bridged connection does not assign an IP address to the WAN interface. NAT and firewall rules are not enabled. This connection method makes the Gateway act as a hub, and just passes packets across the WAN interface to the LAN interface.

To configure the gateway as a bridge, from the Home page, click on Setup and then click on **New Connection**. The default PPPoE connection setup is displayed. At the Type field select **Bridge** and the Bridge connection setup page is displayed (see Figure 4). Give your Bridge connection a unique name; the name must not have spaces and cannot begin with numbers. In this case the unique name is called **bridge1**. Select the encapsulation type (LLC or VC); if you are not sure just use the default mode. Select the VPI and VCI settings; your DSL service provider or your ISP will supply these; in this case the DSL service provider is using **0,35**. Also select the quality of service (QoS); leave the default value if you are unsure or the ISP did not provide this information.

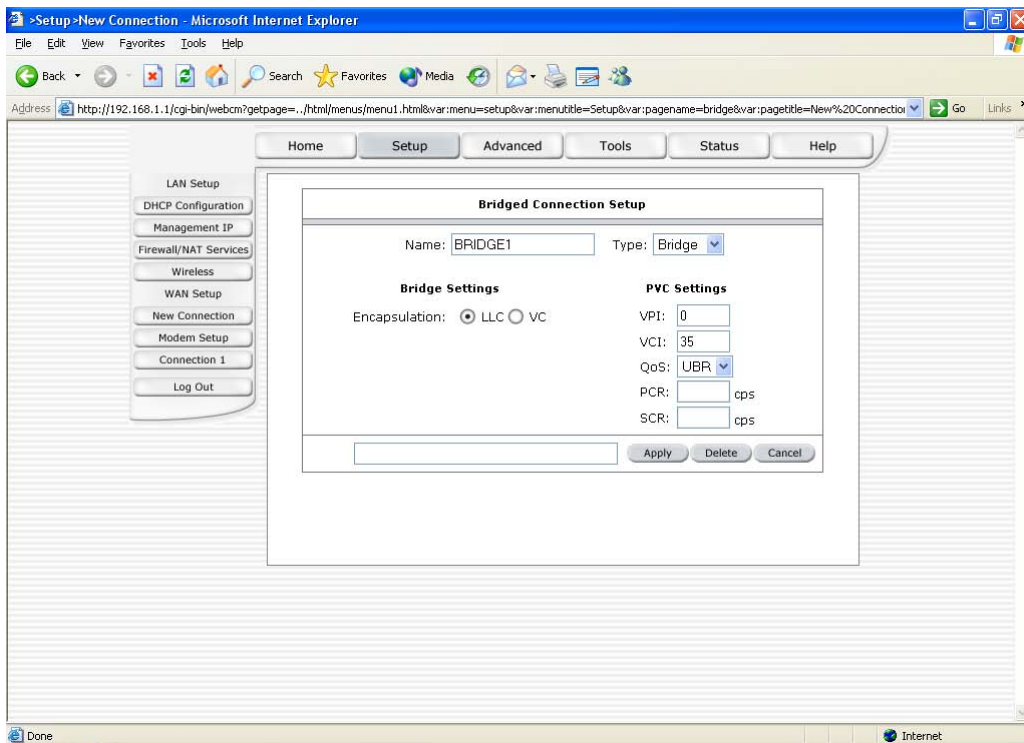

Figure 4 (Bridge Connection Setup)

To complete the new connection you must now click the apply button. The apply button will temporarily save this connection. To make the change permanent you need to click on **Tools**

(at the top of the page) and select **System Commands**. At the system commands page, click on **Save All**.

4.4.1.2 PPPoA Connection Setup

PPPoA is also known as RFC 2364. It is a method of encapsulating PPP packets over ATM cells which are carried over the DSL line. PPP or Point-to-Point protocol is a method of establishing a network connection / session between network hosts. It usually provides a mechanism of authenticating users. LLC and VC are two different methods of encapsulating the PPP packet. Contact your ISP to make sure which encapsulation is being supported.

By selecting PPPoA, you are forcing your gateway to terminate the PPPoA connection. The advantage is that the PPPoA termination is done within the gateway and not on your PC; this frees up your PC resources and allows multiple users to utilize the PPPoA connection.

To configure the gateway for PPPoA, click on Setup and then click on **New Connection**. The default PPPoE connection setup is displayed. At the Type field select **PPPoA** and the PPPoA connection setup page is displayed; figure 5 illustrates a typical PPPoA configuration. Give your PPPoA connection a unique name; the name must not have spaces and cannot begin with numbers. In this case the unique name is called **PPPOA1**. Select the encapsulation type (LLC or VC); if you are not sure just use the default mode. Select the VPI and VCI settings; your DSL service provider or your ISP will supply these; in this case the DSL service provider is using **0,40**. Also select the quality of service (QOS); leave the default value if you are unsure or the ISP did not provide this information.

Following is a description of the different options:

- a. Username: The username for the PPPoA access; this is provided by your DSL service provider or your ISP.
- b. Password: The password for the PPPoA access; this is provided by your DSL service provider or your ISP.
- c. On-Demand: Enables on-demand mode. The connection will disconnect if no activity is detected after the specified idle timeout value.
- d. Idle Timeout: Specifies that PPPoA connection should disconnect if the link has no activity detected for n seconds. This field is used in conjunction with the On-Demand feature. To ensure that the link is always active, enter a 0 in this field.
- e. Keep Alive: When on-demand option is not enable, this value specifies the time to wait without being connected to your provider before terminating the connection. To ensure that the link is always active, enter a 0 in this field.
- f. Maxfail: As long as a DSL connection is established, the gateway will attempt to establish a PPPoA connection. If after n consecutive failed connection attempts the gateway will wait for some random time before trying to establish the connection again. A value of 0 means no limit.
- g. Set Route: Specify this connection as the default-route.
- h. MRU: Maximum Receive Unit the DSL connection can receive. It is a negotiated value that asks the provider to send packets of no more than n bytes. The maximum specified value is 1500 although some DSL/ISP providers require a larger value. The minimum MRU value is 128.
- i. Debug: Enables PPPoA connection debugging facilities. Debugging is talked about later.

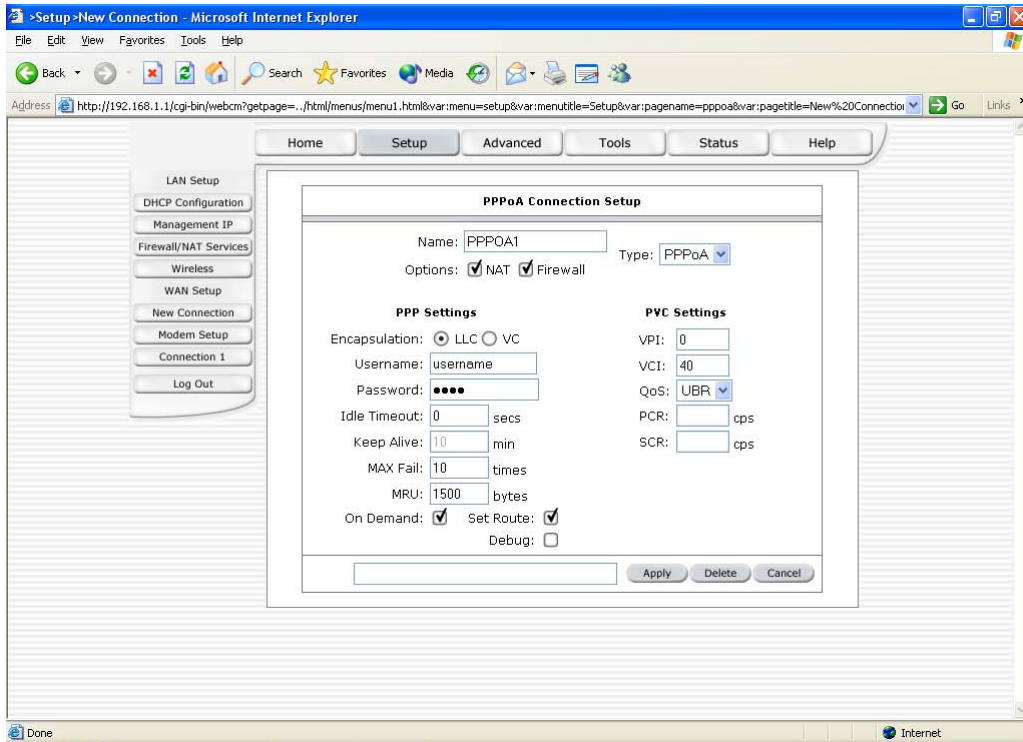

Figure 5 (PPPoA Connection Setup)

To complete the connection you must now click the apply button. The apply button will temporarily save this connection. To make the change permanent you need to click on **Tools** (at the top of the page) and select **System Commands**. At the system commands page, click on **Save All**.

4.4.1.3 PPPoE Connection Setup

PPPoE is also known as RFC 2516. It is a method of encapsulating PPP packets over Ethernet. PPP or Point-to-Point protocol is a method of establishing a network connection/session between network hosts. It usually provides a mechanism of authenticating users.

To configure the gateway for PPPoE, click on Setup and then click on **New Connection**. The default PPPoE connection setup is displayed. At the Type field select **PPPoE** and the PPPoE connection setup page is displayed; figure 6 illustrates a typical PPPoE configuration. Give your PPPoE connection a unique name; the name must not have spaces and cannot begin with numbers. In this case the unique name is called **PPPOE1**. Select the encapsulation type (LLC or VC); if you are not sure just use the default mode. Select the VPI and VCI settings; your DSL service provider or your ISP will supply these; in this case the DSL service provider is using **0,30**. Also select the quality of service (QoS); leave the default value if you are unsure or the ISP did not provide this information.

Following is a description of the different options:

- j. Username: The username for the PPPoE access; this is provided by your DSL service provider or your ISP.
- k. Password: The password for the PPPoE access; this is provided by your DSL service provider or your ISP.
- l. On-Demand: Enables on-demand mode. The connection will disconnect if no activity is detected after the specified idle timeout value.
- m. Idle Timeout: Specifies that PPPoE connection should disconnect if the link has no activity detected for n seconds. This field is used in conjunction with the On-Demand feature. To ensure that the link is always active, enter a 0 in this field.

- n. Keep Alive: When on-demand option is not enable, this value specifies the time to wait without being connected to your provider before terminating the connection. To ensure that the link is always active, enter a 0 in this field.
- o. Maxfail: As long as a DSL connection is established, the gateway will attempt to establish a PPPoE connection. If after n consecutive failed connection attempts the gateway will wait for some random time before trying to establish the connection again. A value of 0 means no limit.
- p. Set Route: Specify this connection as the default-route.
- q. MRU: Maximum Receive Unit the DSL connection can receive. It is a negotiated value that asks the provider to send packets of no more than n bytes. The maximum specified value is 1500 although some DSL/ISP providers require a larger value. The minimum MRU value is 128.
- r. Enforce MRU: Check this box if you experience problems accessing the Internet over a PPPoE connection. This feature will force all TCP traffic to conform with PPP MRU by changing TCP Maximum Segment Size to PPP MRU.
- s. Debug: Enables PPPoE connection debugging facilities. Debugging is talked about later.

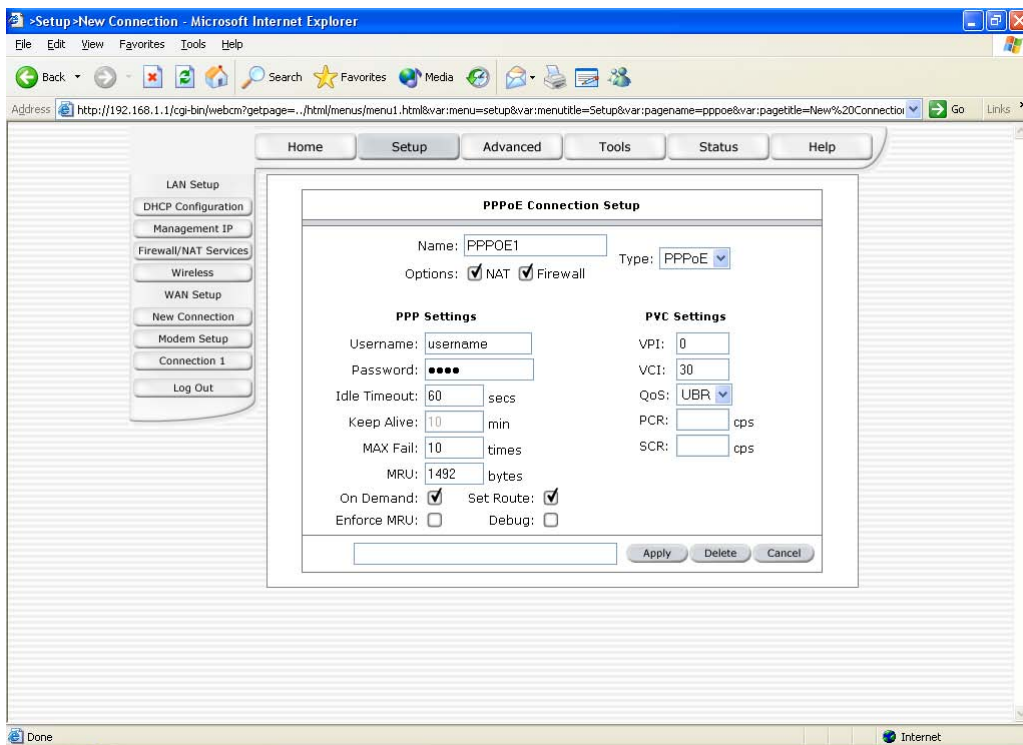

Figure 6 (PPPOE Connection Setup)

To complete the connection you must now click the apply button. The apply button will temporarily save this connection. To make the change permanent you need to click on **Tools** (at the top of the page) and select **System Commands**. At the system commands page, click on **Save All**.

4.4.1.4 DHCP Connection Setup

Dynamic Host Configuration Protocol (DHCP) allows the gateway to automatically obtain the IP address from the server. This option is commonly used in situations where IP is dynamically assigned and is not known prior to assignment.

To configure the gateway for a DHCP connection, click on Setup and then click on **New Connection**. The default DHCP connection setup is displayed. At the Type field select **DHCP** and the DHCP connection setup page is displayed; figure 7 illustrates a typical DHCP configuration. Give your DHCP connection a unique name; the name must not have spaces and cannot begin with numbers. In this case the unique name is called **DHCP1**. Select the encapsulation type (LLC or VC); if you are not sure just use the default mode. Select the VPI and VCI settings; your DSL service provider or your ISP will supply these; in this case the DSL service provider is using **0,35**. Also select the quality of service (QoS); leave the default value if you are unsure or the ISP did not provide this information.

If your DSL line is connected and your DSL/ISP provider is supporting DHCP, you can click the renew button and the gateway will retrieve an IP address, Subnet mask, and Gateway address. At anytime, you can renew the DHCP address by clicking on the renew button; in most cases you will never have to use this button.

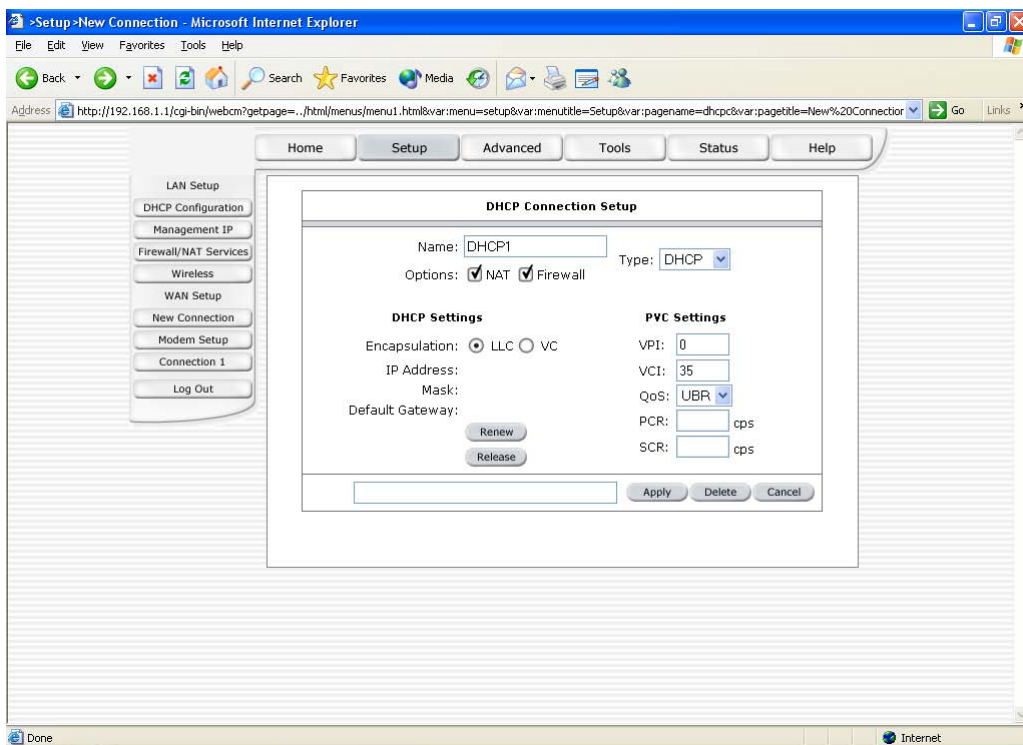

Figure 7 (DHCP Connection Setup)

To complete the connection you must now click the apply button. The apply button will temporarily save this connection. To make the change permanent you need to click on **Tools** (at the top of the page) and select **System Commands**. At the system commands page, click on **Save All**.

4.4.1.5 Static Connection Setup

Static is used whenever a known static IP is assigned. The accompanying information such as the Subnet mask and the gateway should also be specified. Up to three Domain Name Server (DNS) addresses can also be specified. These servers would enable you to have access to other web servers. Valid IP addresses range is from 0.0.0.0 to 255.255.255.255.

To configure the gateway for a Static connection, click on Setup and then click on **New Connection**. The default Static connection setup is displayed. At the Type field select **Static** and the Static connection setup page is displayed; figure 8 illustrates a typical Static configuration. Give your Static connection a unique name; the name must not have spaces and cannot begin with numbers. In this case the unique name is called **STATIC1**. Select the encapsulation type (LLC or VC); if you are not sure just use the default mode. Select the VPI and VCI settings; your DSL service provider or your ISP will supply these; in this case the DSL service provider is using **0,35**. Also select the quality of service (QoS); leave the default value if you are unsure or the ISP did not provide this information. You can also enable Network Address Translation (NAT) and the Firewall options. If you are unsure, leave these in the default mode.

Based upon the information your DSL/ISP provided, enter your assigned IP address, Subnet Mask, Default Gateway (if provided), and Domain Name Services (DNS) values (if provided). For the static configuration, you can also select a bridge connection or a routed connection. Since static IP address is typically used to host WEB servers, you may want to use a bridge connection.

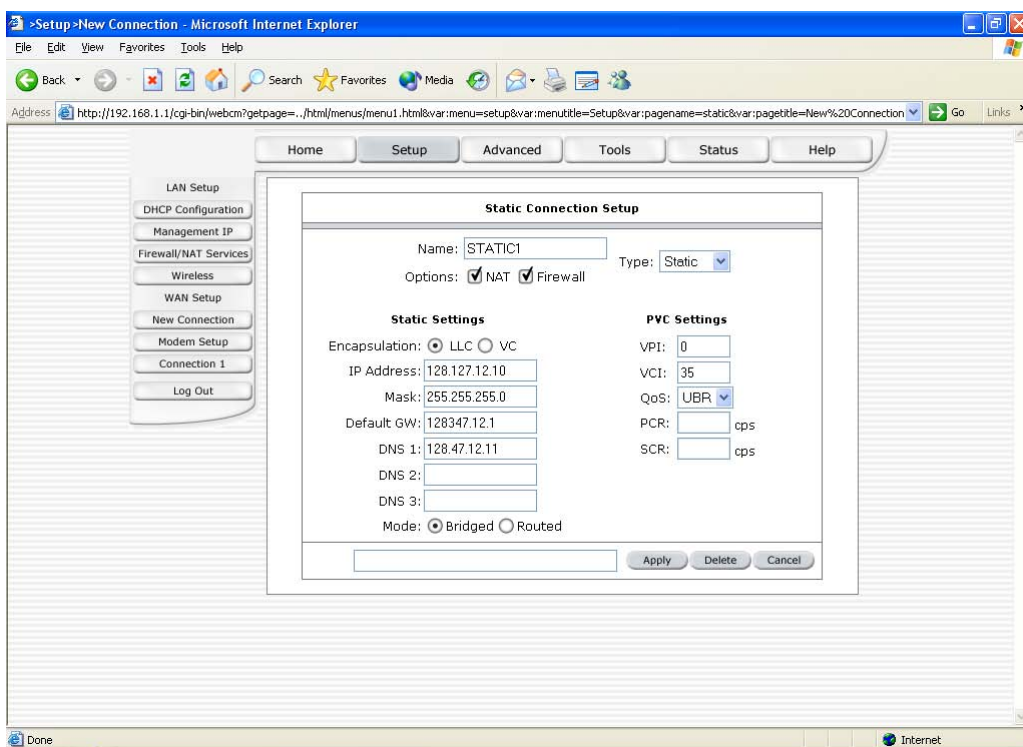

Figure 8 (Static IP Connection Setup)

To complete the connection you must now click the apply button. The apply button will temporarily save this connection. To make the change permanent you need to click on **Tools** (at the top of the page) and select **System Commands**. At the system commands page, click on **Save All**.

4.4.1.6 Classical IP over ATM Connection Setup

The Classical IP over ATM (CLIP) support provides the ability to transmit IP packets over an ATM network, SOHOSpeed ADSL Gateway's CLIP support will encapsulate IP in an AAL5 packet data unit (PDU) frame using RFC1577 and it utilizes an ATM aware version of the ARP protocol. (ATMARP. SOHOSpeed ADSL Gateway's CLIP support only allows for PVC support; it does not support SVC.)

To configure the gateway for a CLIP connection, click on Setup and then click on **New Connection**. The default CLIP connection setup is displayed. At the Type field select **CLIP** and the CLIP connection setup page is displayed; figure 9 illustrates a typical CLIP configuration. Give your CLIP connection a unique name; the name must not have spaces and cannot begin with numbers. In this case the unique name is called **CLIP1**. Select the VPI and VCI settings; your DSL service provider or your ISP will supply these; in this case the DSL service provider is using **0,35**. Also select the quality of service (QoS); leave the default value if you are unsure or the ISP did not provide this information.

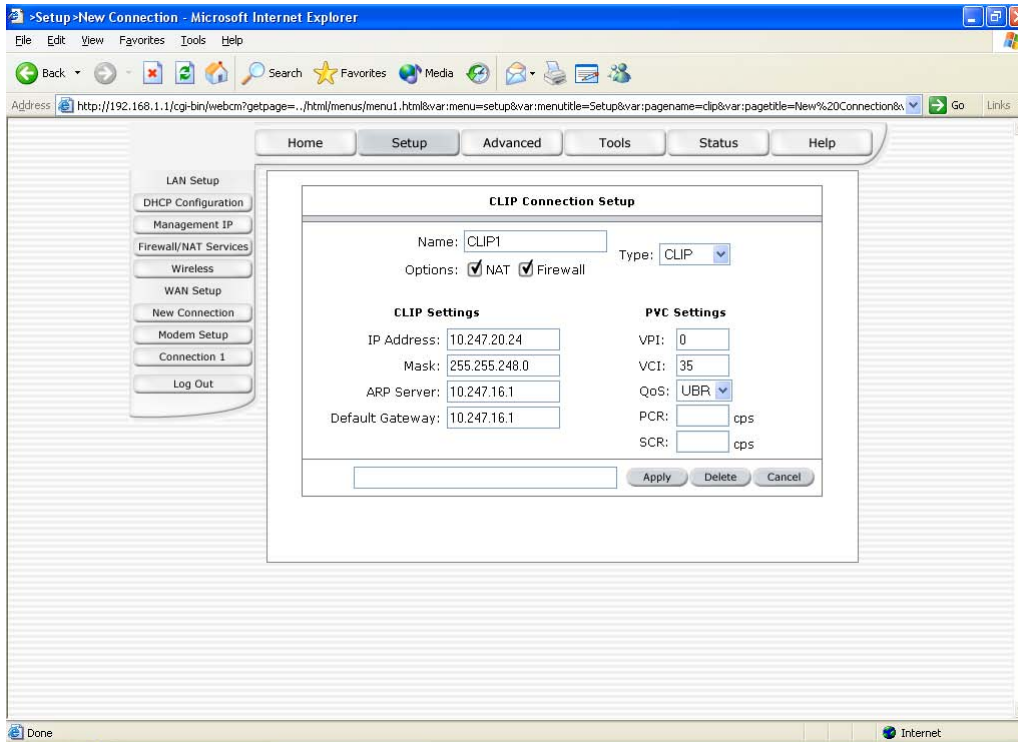

Figure 9 (CLIP Connection Setup)

To complete the connection you must now click the apply button. The apply button will temporarily save this connection. To make the change permanent you need to click on **Tools** (at the top of the page) and select **System Commands**. At the system commands page, click on **Save All**.

4.4.2 Modify an Existing Connection

To modify an existing connection, from the Home screen, click setup and then click the connection you want to modify. The connections are listed as Connection 1 through Connection 8.

As a note, if you delete the connection, to make the change permanent you need to click on **Tools** (at the top of the page) and select **System Commands**. At the system commands page, click on **Save All**.

4.4.3 Modem Setup

To configure the DSL modulation type, go to the Home screen, Click setup. Under WAN Setup, select Modem Setup. This will bring up the modem setup screen. Leave the default value if you are unsure or the DSL/ISP did not provide this information. For most all cases, this screen should not be modified.

The apply button will temporarily save this connection. To make the change permanent you need to click on **Tools** (at the top of the page) and select **System Commands**. At the system commands page, click on **Save All**.

4.5 Configuring the WLAN

Before you can use the wireless to access Internet or wire LAN via the modem, you must enable the AP functionality of this modem first. You can enable it following below setting, **Setup → Wireless → Enable AP**. Then you can select a **channel** to use and entry your AP's **SSID**.

Note: you must Restart Access Point for Wireless changes to take effect.

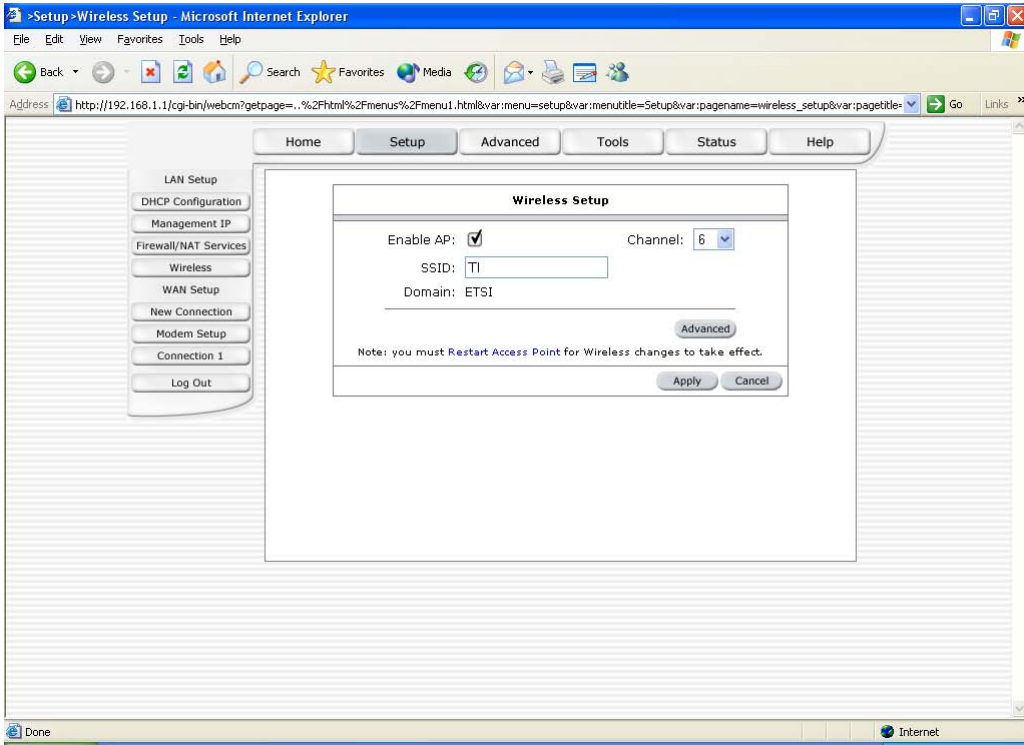

- Enable AP: enable/disable AP functionality
- Channel: select the working channel this AP will used
- SSID: service set ID
- Advanced: additional parameter setting

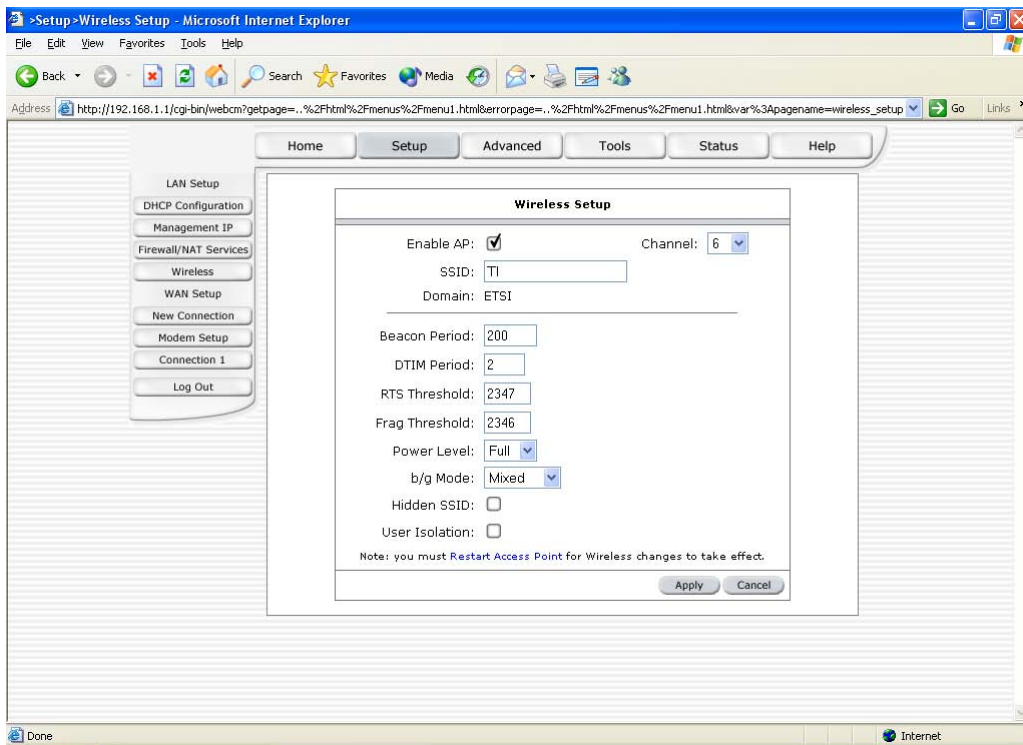

Following is a description of the different options:

Beacon Period: Beacon is a special broadcast packet sent by AP, the unit is 1024 us

DTIM Period: Delivery Traffic Indication Message (DTIM), if AP have broadcast packets need to transmit in Beacon packet will include this parameter, to indicates the number of Beacon intervals between successive DTIMs, default value is 2

RTS Threshold: if the packet size is large than this value, AP will start RTS/CTS transmitted, default value is 2347 bytes

Frag Threshold: if the packet size is large than this value, AP will fragment this packet, default value is 2346 bytes

Power Level: adjust the Tx power level, there have 5 levels you can choice, Full, 50%, 25%, 12% and 6%, default is Full power

b/g Mode: select the operation mode of wireless, Mixed (b and g), b only, b+ (22M) and g only, default is Mixed

Hidden SSID: by default SSID information will include in the beacon packet to notice user, for security issue you can remove SSID from beacon.

4.6 Configuring the LAN

By default, your gateway has DHCP server (LAN side) enabled. If you already have a DHCP server running on your network, you *must* disable one of the two DHCP servers; if you plug a second DHCP server into the network, you will experience network errors and the network will not function normally.

4.6.1 Enable/Disable DHCP

To enable or disable DHCP go to the Home screen, Click setup. Under LAN Setup, select DHCP Configuration. This will bring up the screen shown in Figure 10.

The Start IP Address is where the DHCP server starts issuing IP addresses. This value must be greater than the gateways IP address value. For example if the gateways IP address is 192.168.1.1 (default) than the starting IP address must be 192.168.1. 2 (or higher).

The End IP Address is where the DHCP server stops issuing IP addresses. The ending address cannot exceed a subnet limit of 254. Hence the max value for our default gateway is 192.168.1.254. If the DHCP server runs out of DHCP addresses, users will not get access to network resources. If this happens you can increase the Ending IP address (to the limit of 255) or reduce the lease time.

The Lease Time is the amount of time a network user will be allowed connection to the Gateway with their current dynamic IP address. The amount of time is in units of seconds; the default value is 3600 seconds (1 hour).

Note: If you change the start or end values, make sure the values are still within the same subnet as the gateways IP address. In other words, if the gateways IP address is 192.168.1.1 (default) and you change the DHCP start/end IP addresses to be 192.128.1.2/192.128.1.100, you will not be able to communicate to the gateway if your PC has DHCP enabled.

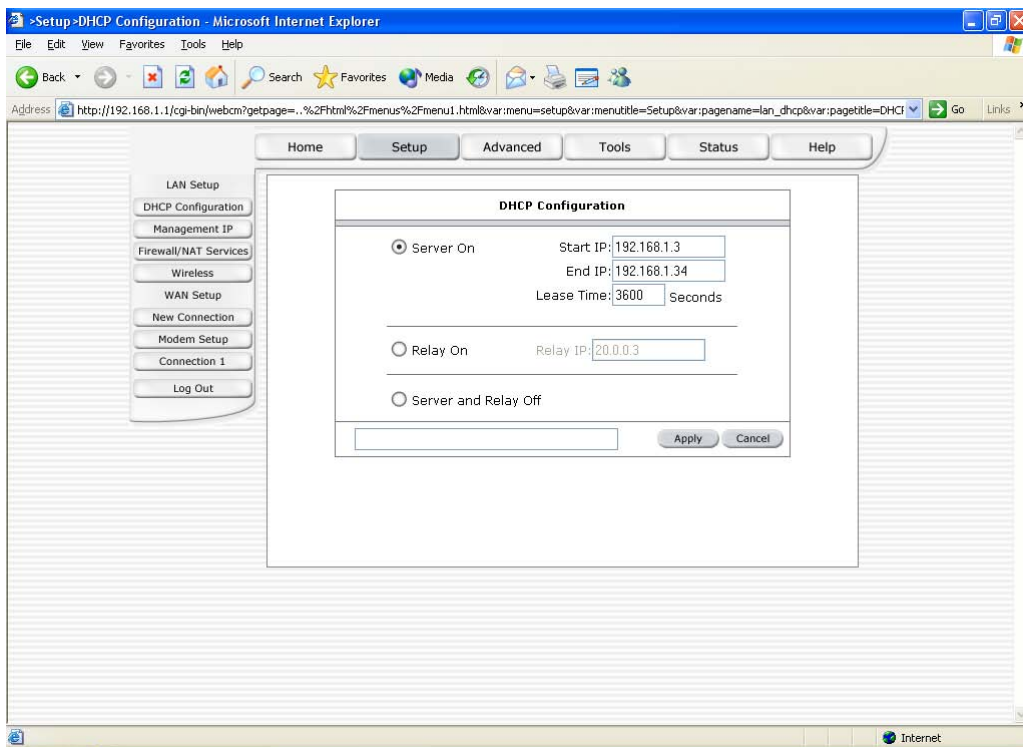

Figure 10 (DHCP Server configuration)

In addition to the DHCP server feature, the gateway supports the DHCP relay function. When the gateway is configured as DHCP server, it assigns the IP addresses to the LAN clients. When the gateway is configured as DHCP relay, it is responsible for forwarding the requests and responses negotiating between the DHCP clients and the server. See figure 11.

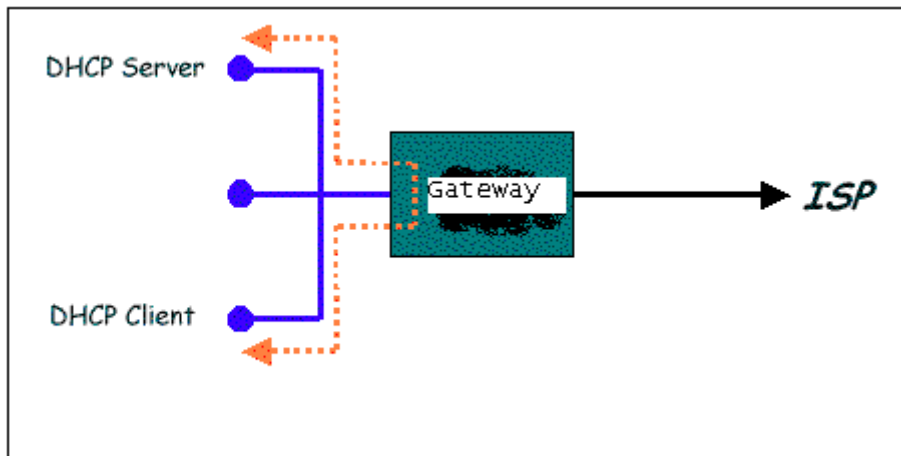

Figure 11 (Example of a DHCP Relay configuration)

By turning off the DHCP server and relay the network administrator must carefully configure the IP address, Subnet Mask and DNS settings of every computer on your network. Do not assign the same IP address to more than one computer and your Gateway must be on the same subnet as all the other computers.

The apply button will temporarily save this connection. To make the change permanent you need to click on **Tools** (at the top of the page) and select **System Commands**. At the system commands page, click on **Save All**.

4.6.2 Changing the gateways IP address

You can change the gateway's IP address by going to the Home screen, click setup and under LAN Setup, select Management. This will bring up the screen shown in Figure 12.

4.6.2.1 Static IP address assignment

Your gateway's default IP address and subnet mask are 192.168.1.1/255.255.255.0; this subnet mask will allow the gateway to support 254 users. If you want to support a larger number of users you can change the subnet mask; but remember. The DHCP server is defaulted to only give out 255 IP addresses. Further remember that if you change your gateways' IP address and you have DHCP enabled, the DHCP configuration must reside within the same subnet.

The default gateway is the routing device used to forward all traffic that is not addressed to a station within the local subnet. Your ISP will provide you with the default gateway Address. Figure 12 shows a default gateway address of 10.247.16.1 because this was the default gateway defined when the CLIP connection was configured.

The hostname can be any alphanumeric word that does not contain spaces. The domain name is used to in conjunction with the host name to uniquely identify the gateway. To access the gateway's web pages the user can type 192.168.1.1 (the gateway's default IP address) or type mygateway.ar7.

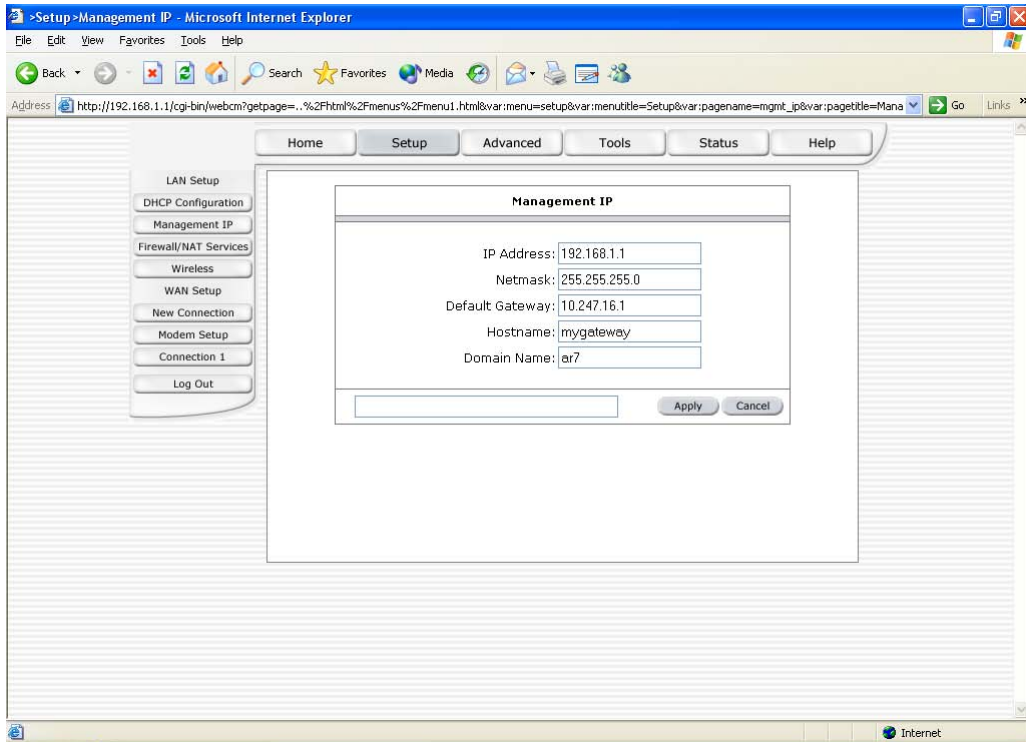

Figure 12 (Management IP address)

The apply button will temporarily save this connection. To make the change permanent you need to click on **Tools** (at the top of the page) and select **System Commands**. At the system commands page, click on **Save All**.

4.6.3 Firewall/NAT Services

You can enable or disable Firewall and NAT by going to the Home screen, click setup and under LAN Setup, select Firewall/NAT Services. By unselecting the “Enable Firewall and NAT Services” button the firewall and NAT services is disabled for all WAN connections.

The apply button will temporarily save this connection. To make the change permanent you need to click on **Tools** (at the top of the page) and select **System Commands**. At the system commands page, click on **Save All**.

4.7 Advanced

The gateway supports a host of advanced features. For basic Gateway functionality, the user does not need to utilize these advanced features. The features help with routing, security, port configuration, and plug and play capability.

4.7.1 Wireless Security

For security issue, when you using wireless you probable want to enable wireless security functionality, there have three methods of security supported in this modem. Following the instruction **Advanced** → **Wireless Security**, by default security is disable.

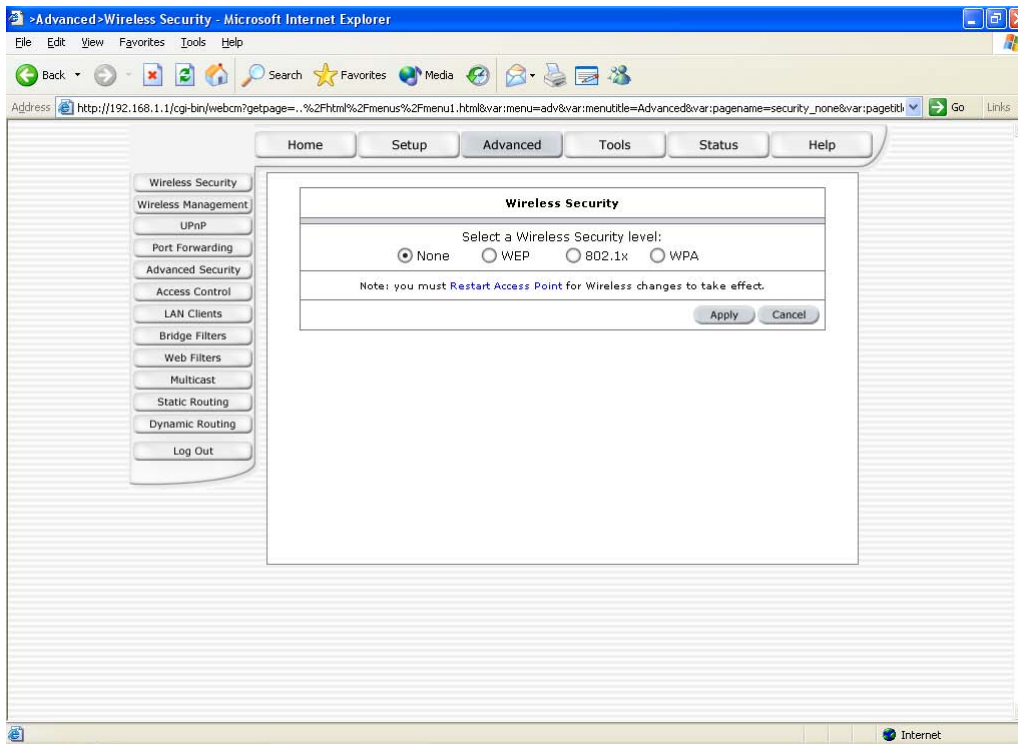

None: By default, the wireless security functionality is disabled

WEP: defined in IEEE802.11, this modem support 64, 128 and 256 bits encryption key

802.1x: IEEE802.1x with RADIUS Server support

WPA: support both 802.1x with RADIUS Server and PSK (pre shared key)

4.7.1.1 WEP

First you have to enable WEP, and then choice one of the four key sets and key length, finally entry the encryption key word. The number of digits of encryption key word is depend on which key length you selected, enter 10, 26, or 58 hexadecimal digits for 64, 128 or 256 bit Encryption Keys respectively. e.g., AA AA AA AA AA for a key length of 64 bits.

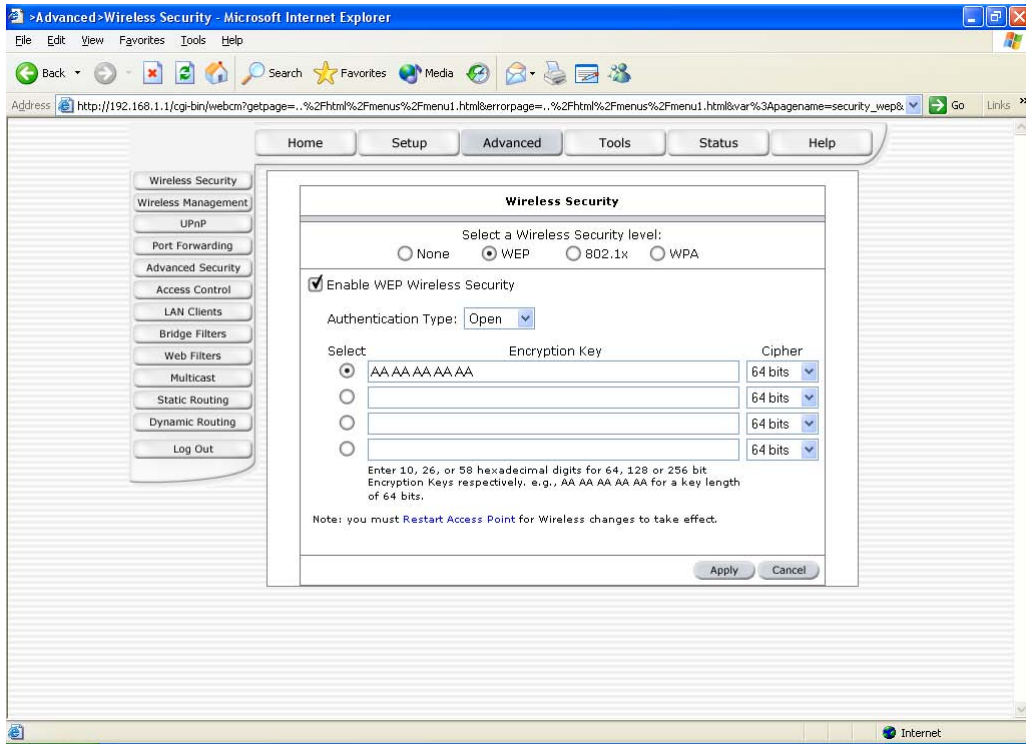

Notice that after you change any parameters of Wireless, you must **Restart** the AP.

4.7.1.2 802.1x

Before you used 802.1x to secure your WLAN, you need to setup RADIUS Server to provide authentication service, then you type the IP of the RADIUS Server in **Server IP Address** record, and secret key in **Secret** record.

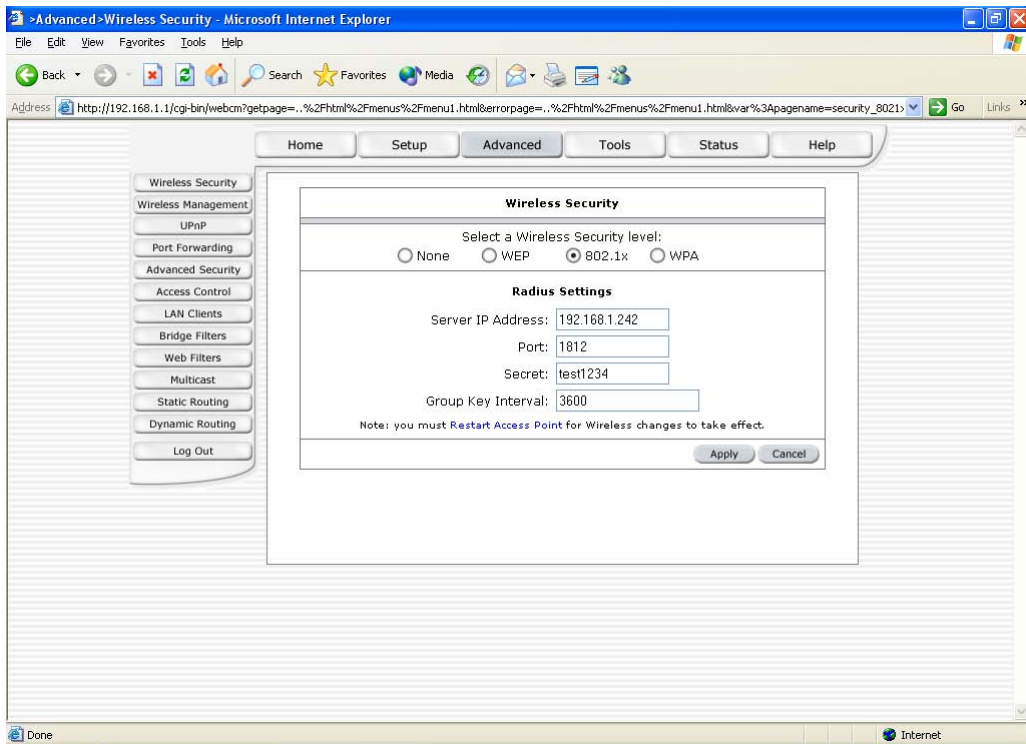

Following is a description of the different options:

Port: the RADIUS Server's TCP/IP port number

Group Key Interval: one problem of WEP is WEP never change the encapsulation key, RADIUS can fix this problem by renew key in a time period.

4.7.1.3 WPA

WPA is instructed by 802.1x, EAP and TKIP, but for SOHO environment, where there are no central authentication servers or EAP framework, WPA provide another method for such environment call Pre-Shared Key (PSK).

Regarding 802.1x, the setup is description as before.

To use PKI, you only have to do is type a secret key in it.

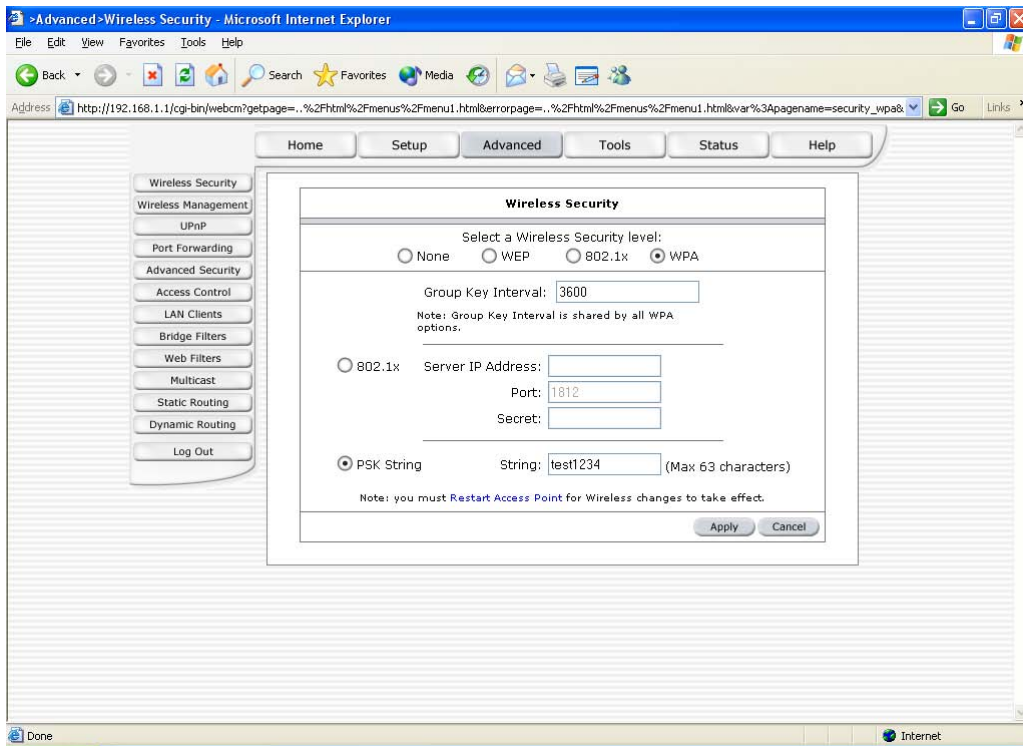

4.7.2 Wireless Management

There have three methods to help administrator to manage Wireless, Access List, Associated Stations and Multiple SSID.

4.7.2.1 Access List

You can allow/ban a user to access Internet via wireless by put its MAC address on this access list.

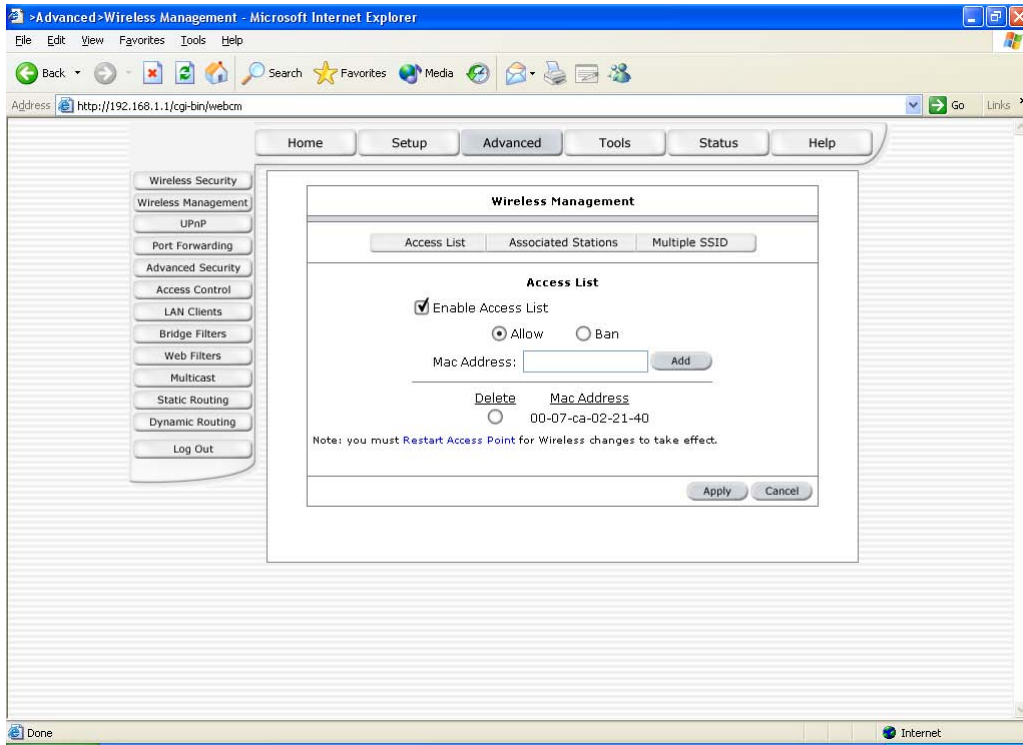

1. Enable Access List functionality
2. Selection this is a Allow or Ban list

If you select Allow list, by default, no one can pass through this AP after you put its MAC address on this list.

If you select Ban list, by default, anyone can pass through this AP after you put someone's MAC address in this list, then it will be reject to access via this AP.

3. You can manually type the MAC address which you want to Allow/Ban asceed.
4. Click the Apply button
5. Don't forget to restart Access Point

4.7.2.2 Associated Stations

You can see a user information list that is associated with this AP, you can reject its access by click the Ban Station button on the left side in each row.

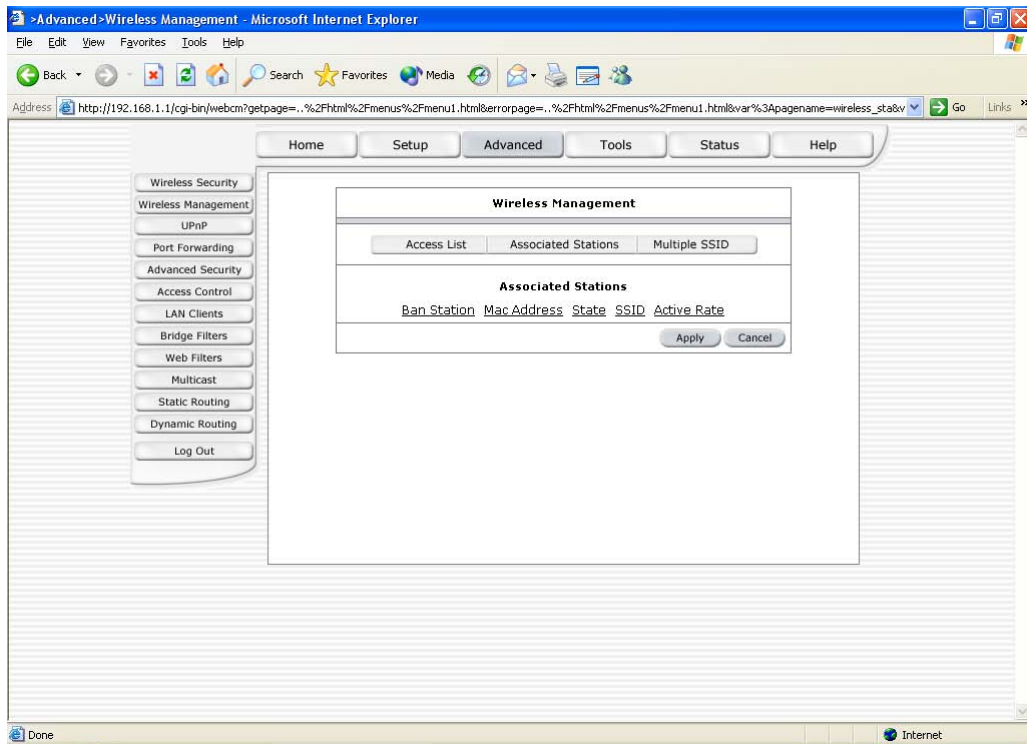

4.7.2.3 Multiple SSID

This functionality can not used combine with any wireless security functionality, you must disable wireless security function before use it.

To enable this functionality, just select **Enable Multiple SSID**, type a new SSID and click **Add** button.

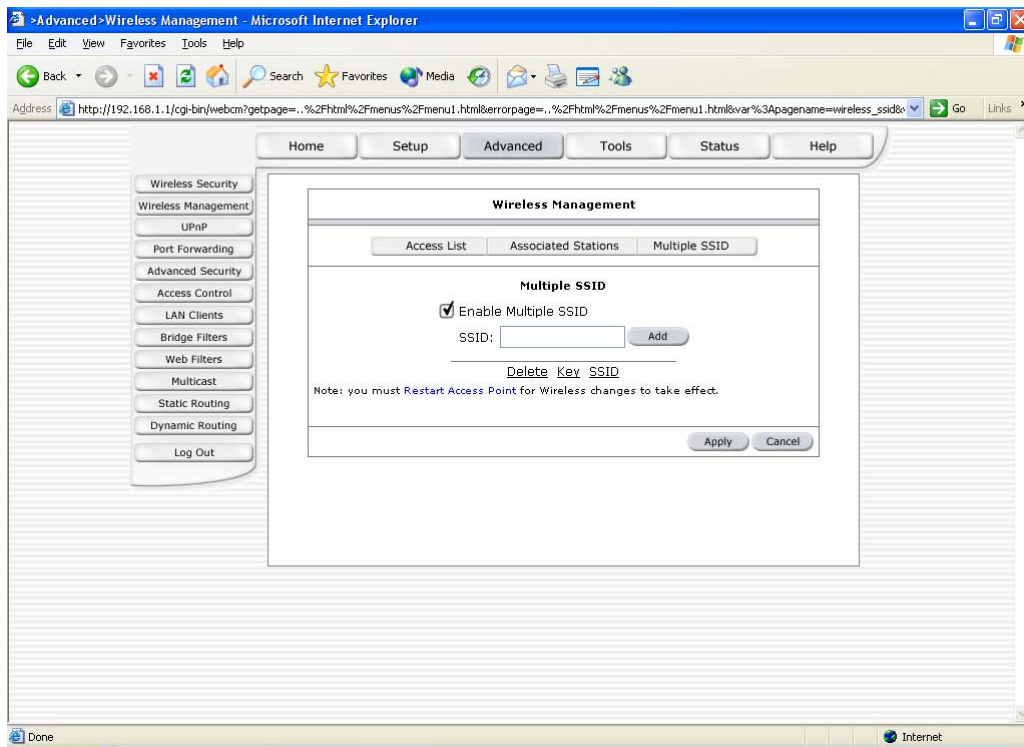

4.7.3 UPnP

UPnP NAT and Firewall Traversal allow traffic to pass-thru the Gateway for applications using the UPnP protocol. This feature requires one active DSL connection. In presence of multiple DSL connections, select the one over which the incoming traffic will be present, for example the default Internet connection.

To enable UPnP, you must first have a WAN connection configured. Once a WAN connection is configured, from the Home screen, click Advanced and under Advanced, select UPnP. This will bring up the screen shown in Figure 13. You must enable UPnP and then select which connection will utilize UPnP.

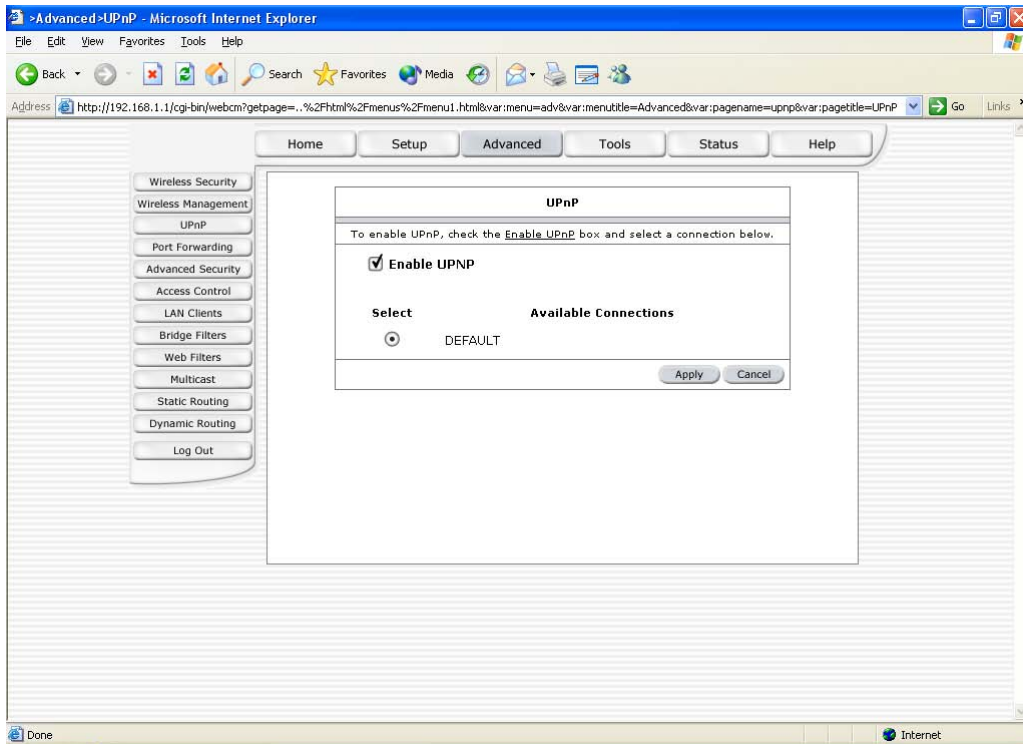

Figure 13 (Management IP address)

The apply button will temporarily save this connection. To make the change permanent you need to click on **Tools** (at the top of the page) and select **System Commands**. At the system commands page, click on **Save All**.

4.7.4 Port Forwarding

Using the Port Forwarding page, you can provide local services (for example web hosting) for people on the Internet or play Internet games. When users send this type of request to your network via the Internet, the Gateway will forward those requests to the appropriate PC. Port forwarding can be used with DHCP assigned addresses but remember that a DHCP address is dynamic (not static). For example, if you were configuring a netmeeting server, you would want to assign this server a static IP address so that the IP address is not reassigned. Also remember that if an Internet user is trying to access an Internet application, they must use the WAN IP address. The port forwarding will translate the WAN IP address into a LAN IP address.

To configure a service, game, or other application select the external connection (for example the Internet connection), from the Home screen, click Advanced and under Advanced, select Port Forwarding. Next select the computer hosting the service and add the corresponding firewall rule. If you want to add a custom application, select the User category, click New and fill in the port, protocols and description for your application.

For example, if you want to host a Netmeeting session, from the Home screen, click Advanced and under Advanced, select Port Forwarding. First select the IP address for your Netmeeting server. Next select the Audio/Video category and add Netmeeting to the applied rules box. To view the management rules, highlight Netmeeting and select view; this will display the pre configured protocols and ports that Netmeeting will use. Now assuming that your WAN connection is correct, you can run Netmeeting from your server and call users that are on the Internet. If you know your WAN IP address, users can call you. Figure 14 illustrates a typical Port Forwarding configuration.

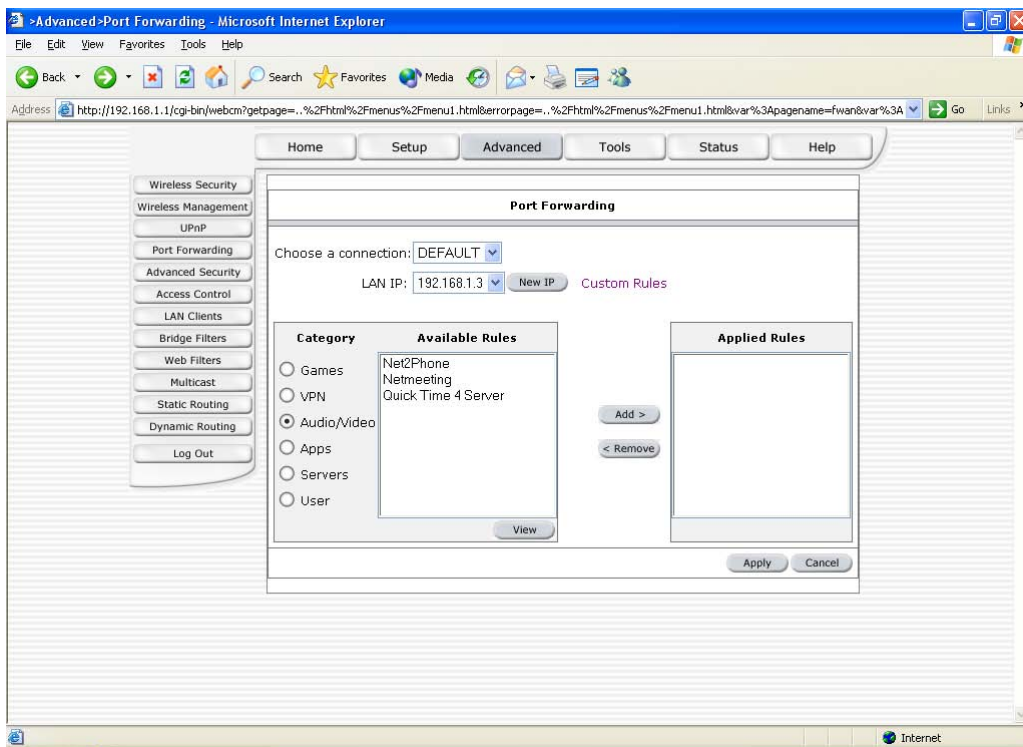

Figure 14 (Port Forwarding: Netmeeting)

The apply button will temporarily save this connection. To make the change permanent you need to click on **Tools** (at the top of the page) and select **System Commands**. At the system commands page, click on **Save All**.

4.7.5 Advanced Security

In the presence of the firewall, anonymous Internet traffic is blocked. Using the advanced security features, you can redirect this traffic to a dedicated computer on your local network (DMZ) or open the access from the Internet to the Gateway's management ports (web, telnet). The Gateway's firewall and NAT services (port forwarding, access control) can be disabled for all interfaces by un-checking the "Enable Firewall and NAT Service"

To enable any of the advanced security features, from the Home screen, click Advanced and under Advanced, select Advanced Security. Figure 15 illustrates the typical advanced security configuration.

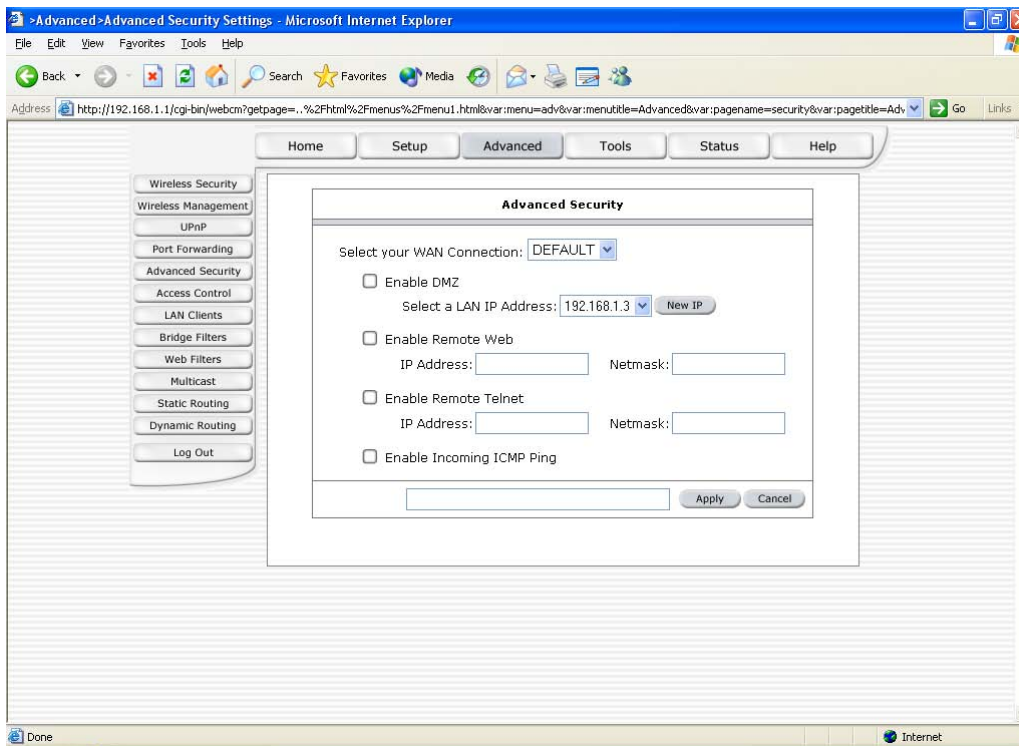

Figure 15 (Advanced Security)

The apply button will temporarily save this connection. To make the change permanent you need to click on **Tools** (at the top of the page) and select **System Commands**. At the system commands page, click on **Save All**.

4.7.5.1 DMZ configuration

Setting a computer (on your local network) as a DMZ forwards any network traffic that is not redirected to another computer via the port-forwarding feature to the computer's IP address. This opens the access to the DMZ computer from the Internet.

4.7.5.2 Enable Remote Web

Enabling the Remote Web on your local network allows Web requests that come from the Internet to be re-routed to a Web Server that is on a different subnet. This is different than the Web server rule that is configurable via the port-forwarding page. In this case, the web server is on a different subnet.

4.7.5.3 Enable Remote Telnet

Enabling the Remote Web on your local network allows telnet requests that come from the Internet to be re-routed to a telnet Server that is on a different LAN IP subnet. This is different that the telnet server rule that is configurable via the port-forwarding page. In this case, the telnet server is on a different subnet.

4.7.5.4 Enable Incoming ICMP Ping

Enabling the Incoming Internet Control Message Protocol (ICMP) Ping will allow Echo requests to come into the gateway. The gateway will respond with an ICMP Echo response message. The option allows the DSL provider or ISP to determine the following:

- a. The status of the network.
- b. Tracking and isolating hardware and software problems.
- c. Testing, measuring, and managing networks.

4.7.6 Access Control

Access control can also be called port blocking. Specific types of traffic that is destined to a selected LAN IP address can be blocked. To enable any of the Access Control features, from the Home screen, click Advanced and under Advanced, select Access Control. A page similar to the port-forwarding page appears. Similar to the port-forwarding page, an IP address can be added to a rule. All Access Control rules have precedence over rules that were added via the port-forwarding page.

The apply button will temporarily save this connection. To make the change permanent you need to click on **Tools** (at the top of the page) and select **System Commands**. At the system commands page, click on **Save All**.

4.7.7 LAN clients

To add a LAN client, from the Home screen, click Advanced and under Advanced, select LAN Clients. If DHCP is used, all DHCP clients are automatically assigned. If a fixed IP address server is on the LAN and you want this server to be visible via the WAN, you must add its IP address. Once the IP address has been added to you can apply Port Forwarding and Access Control rules to this IP address.

The apply button will temporarily save this connection. To make the change permanent you need to click on **Tools** (at the top of the page) and select **System Commands**. At the system commands page, click on **Save All**.

4.7.8 Bridge Filters

The bridge filtering mechanism provides a way for the users to define rules to allow/deny frames through the bridge based on source MAC address, destination MAC address and/or frame type. When bridge filtering is enabled, each frame is examined against the defined filter rules sequentially, and when a matched is determined, the appropriate filtering action (determined by the access type selected ... i.e. allow or deny) is performed. The user should note that the bridge filter will only examined frames from interfaces which are part of the bridge itself. Twenty filter rules are supported with bridge filtering. To enable Bridge Filters, from the Home screen, click Advanced and under Advanced, select Bridge Filters. Figure 16 illustrates a typical Bridge filter configuration.

The User Interface for Bridge Filter allows the user to add/edit/delete, as well as, enables the filter rules. To add rules, simply define the source MAC address, destination MAC address and frame type with desired filtering type (i.e. allow/deny), and press the "Add" button. The MAC address must be in a xx-xx-xx-xx-xx-xx format, with 00-00-00-00-00-00 as "don't care". Blanks can be used in the MAC address space, and would be considered also as "don't care".

To edit/modify an existing filter rule, select the desired rule created previously from "Add" in the "Edit" select box. The selected filter rule will appear on top section, as with the "Add" filter rule. Make the desired change to the MAC address, frame type and/or access type, and press "Apply".

To delete filter rule(s), select the filter rule entry to delete in the "Delete" selection box. Note that multiple deletions are possible. Once all the desired filter rule(s) is/are selected for deletion, press the "Apply" button. The "Select All" select box can also be used to delete the entire filter rule. It provides a quick method of selecting all filter rules for deletion.

The "Enable Bridge Filters" button allow the user to enable or disable bridge filtering. It can be set/unset during any add/edit/delete operation. It can also be set/unset independently by just pressing the "Apply" button.

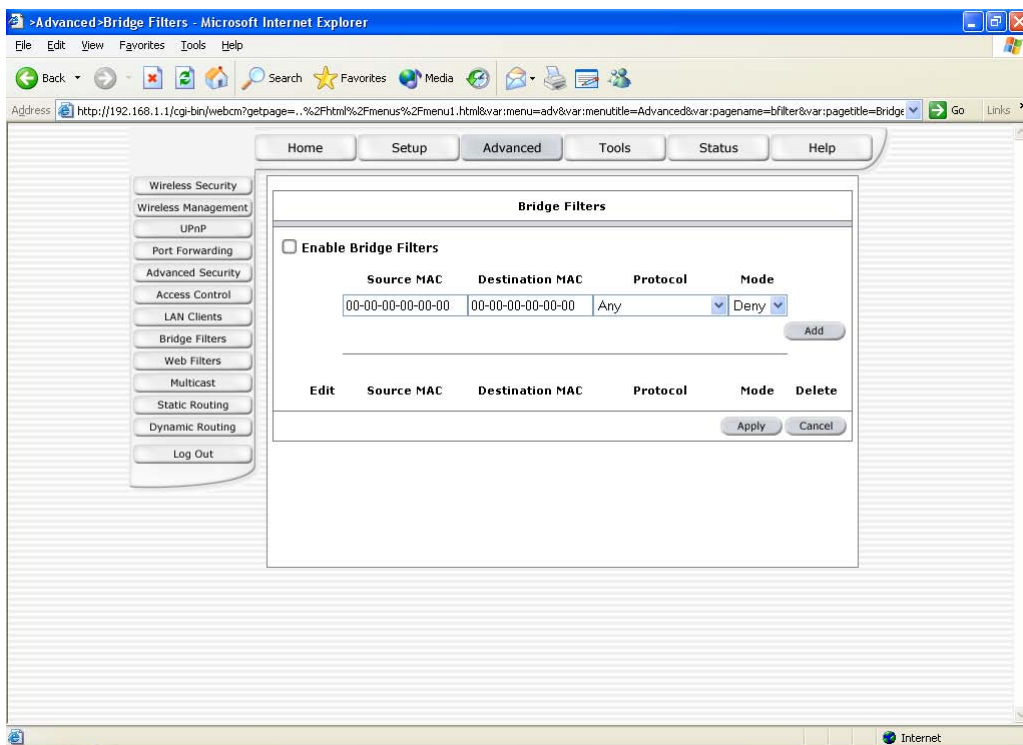

Figure 16 (Bridge Filters)

Note: The bridge filter table contains 3 hidden rules. These rules are entered automatically by the system to ensure the user does not "lock" them out of the system. The first rule allows any and all ARP frames through the system. The second rule allows all IPv4 frames with the destination MAC address of the bridge to go through. The third rule allows all IPv4 frames with the source MAC address of the bridge to go through.

Tip: On a windows based machine, to find a MAC address, at a DOS prompt type **ipconfig /all**.

The apply button will temporarily save this connection. To make the change permanent you need to click on **Tools** (at the top of the page) and select **System Commands**. At the system commands page, click on **Save All**.

4.7.9 Multicast

Multicasting is a form of limited broadcast. UDP is used to send datagrams to all hosts that belong to what is called a "host group." A host group is a set of zero or more hosts identified by the same destination IP address. The following statements apply to host groups.

- a. Anyone can join or leave a host group at will.
- b. There are no restrictions on a host's location.
- c. There are no restrictions on the number of members that may belong to a host group.
- d. A host may belong to multiple host groups.
- e. Non-group members may send UDP datagrams to the host group.

Multicasting is useful when data needs to be sent to more than one other device. For instance, if one device is responsible for acquiring data that many other devices need, then multicasting is a natural fit. Note that using multicasting as opposed to sending the same data to individual devices uses less network bandwidth.

To enable Multicasting, from the Home screen, click Advanced and under Advanced, select Multicast. Figure 17 illustrates a typical Multicast configuration.

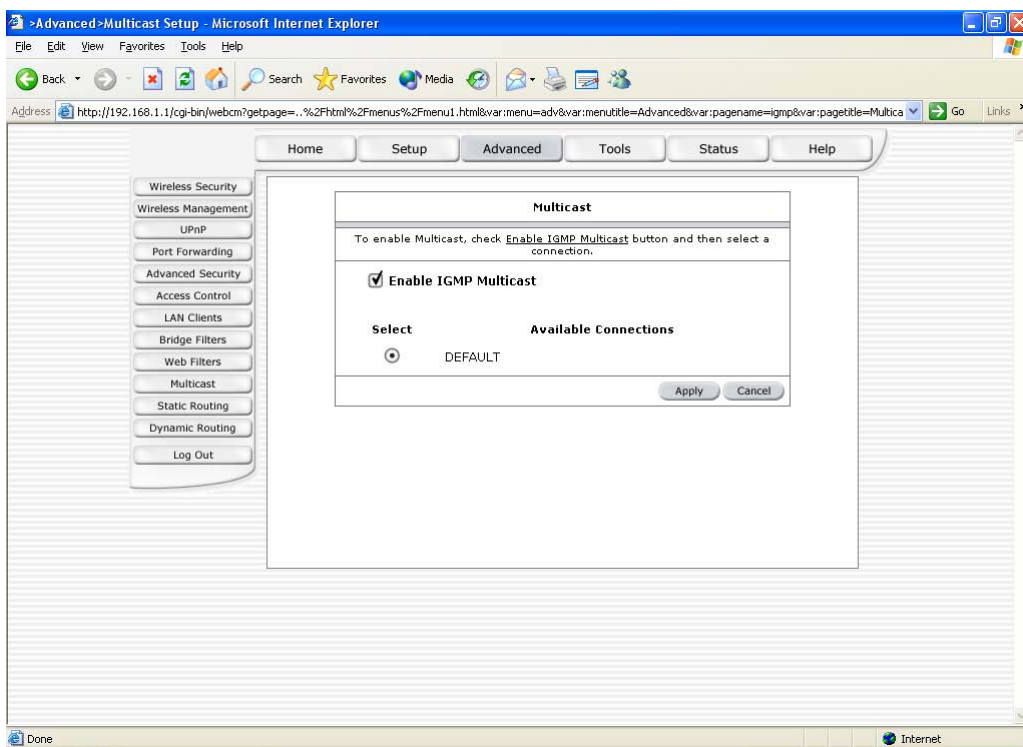

Figure 17 (Multicast)

The apply button will temporarily save this connection. To make the change permanent you need to click on **Tools** (at the top of the page) and select **System Commands**. At the system commands page, click on **Save All**.

4.7.10 Static Routing

If the Gateway is connected to more than one network, you may need to set up a static route between them. A static route is a pre-defined pathway that network information must travel to reach a specific host or network. You can use static routing to allow different IP domain users to access the Internet through the Gateway.

The New Destination IP is the address of the remote LAN network or host to which you want to assign a static route. Enter the IP address of the host for which you wish to create a static route here. For a standard Class C IP domain, the network address is the first three fields of the New Destination IP, while the last field should be 0. The Subnet Mask identifies which portion of an IP address is the network portion, and which portion is the host portion. For a full Class C Subnet, the Subnet Mask is 255.255.255.0. The Gateway IP address should be the IP address of the gateway device that allows for contact between the Gateway and the remote network or host. The Hop Count determines the maximum number of steps between network nodes that data packets will travel. A node is any device on the network (such as a router or switch).

To enable Static Routing, from the Home screen, click Advanced and under Advanced, select Static Routing. Figure 18 illustrates a typical Static Route.

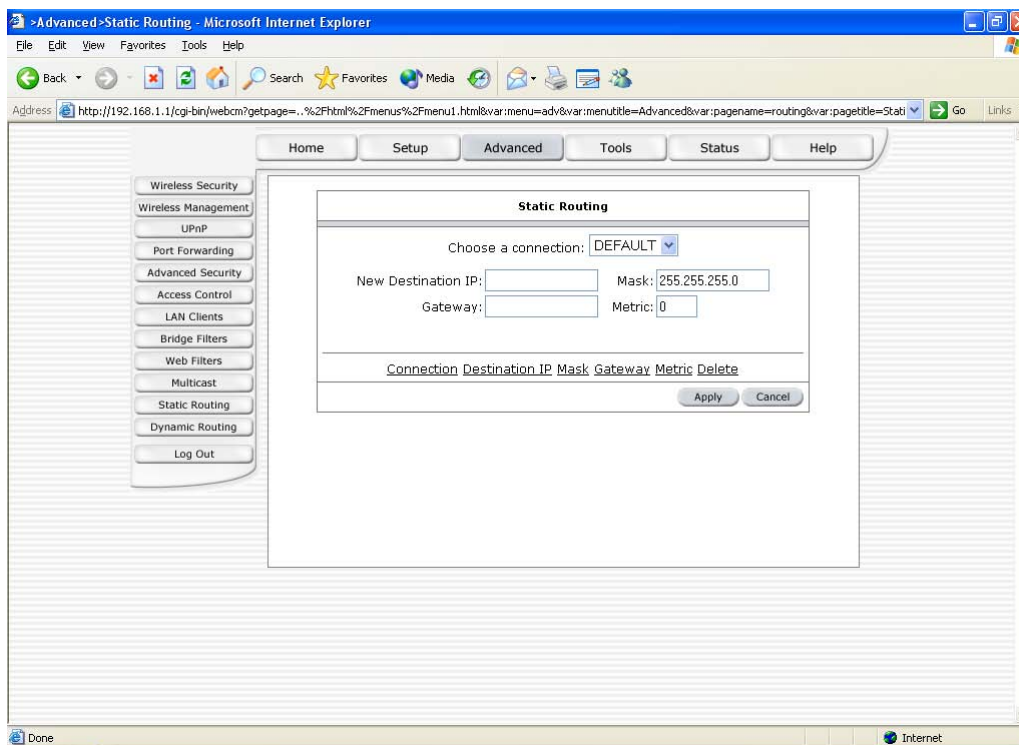

Figure 18 (Static Routing)

The apply button will temporarily save this connection. To make the change permanent you need to click on **Tools** (at the top of the page) and select **System Commands**. At the system commands page, click on **Save All**.

4.7.11 Dynamic Routing

Dynamic Routing allows the Gateway to automatically adjust to physical changes in the network. The Gateway, using the RIP protocol, determines the network packets' route based on the fewest number of hops between the source and the destination. The RIP protocol regularly broadcasts routing information to other routers on the network.

The Direction determines the direction that RIP routes will be updated. Selecting In means that the Gateway will only incorporate received RIP information. Selecting Out means that the Gateway will only send out RIP information. Selecting both means that the Gateway will incorporate received RIP information and send out updated RIP information.

The protocol is dependent upon the entire network. Most networks support Rip v1. If RIP v1 is selected, routing data will be sent in RIP v1 format. If Rip V2 is selected, routing data will be sent in RIP v2 format using subnet broadcasting. If Rip V1 Compatible is selected, routing data will be sent in RIP v2 format using multicasting.

To enable Dynamic Routing, from the Home screen, click Advanced and under Advanced, select Dynamic Routing. Figure 19 illustrates a typical Dynamic Route.

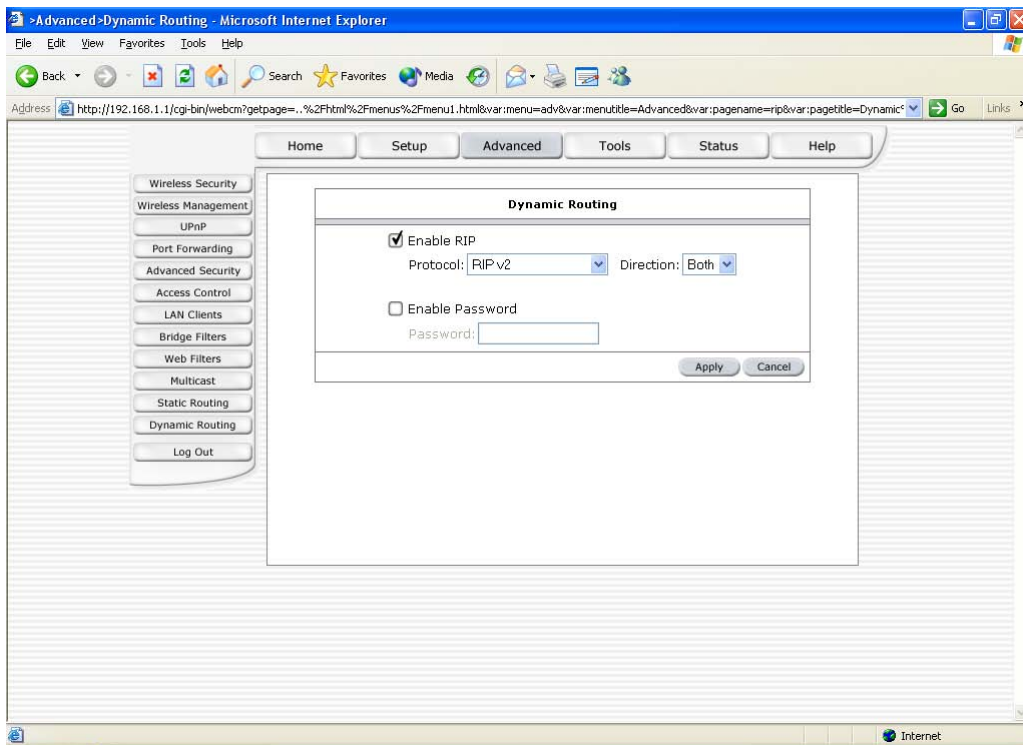

Figure 19 (Dynamic Routing)

The apply button will temporarily save this connection. To make the change permanent you need to click on **Tools** (at the top of the page) and select **System Commands**. At the system commands page, click on **Save All**.

4.8 Tools

The gateway supports a host of tools which will allow you to customize and debug your gateway.

4.8.1 System Commands

To make the changes permanent you need to click on **Tools** (at the top of the page) and select **System Commands**. The following commands are used to configure the gateway:

- a. **Save all:** Press this button in order to permanently save the current configuration of the Gateway. If you do re-start the system without saving your configuration, the Gateway will revert back to the previously saved configuration.
- b. **Restart:** Use this button to re-start the system. If you have not saved your configurations, the Gateway will revert back to the previously saved configuration upon re-starting. **NOTE:** Connectivity to the unit will be lost. You can reconnect after the unit reboots.
- c. **Restore Defaults:** Use this button to restore factory default configuration. **NOTE:** Connectivity to the unit will be lost. You can reconnect after the unit reboots.

4.8.2 Remote Log

The remote log feature is used in conjunction with the PC tool (software provided with your gateway). For PPPoE and PPPoA connections, you can select debug if you want to log the connection information. This is helpful when trying to debug connection problems.

The remote log feature will forward all logged information to the remote PC. The type of information forwarded to the remote PC depends upon the Log level. Each log message is assigned a severity level, which indicates how seriously the triggering event affects Gateway functions. When you configure logging, you must specify a severity level for each facility; messages that belong to the facility and are rated at that level or higher are logged to the destination.

Table 1 defines the different severity levels.

To forward logging information, you need to click on **Tools** (at the top of the page) and select **Remote Log**.

Severity Level	Description
panic	System panic or other condition that causes the router to stop functioning.
alert	Conditions that require immediate correction, such as a corrupted system database.
critical	Critical conditions, such as hard drive errors.
error	Error conditions that generally have less serious consequences than errors in the emergency, alert, and critical levels.
warning	Conditions that warrant monitoring.
notice	Conditions that are not errors but might warrant special handling.
info	Events or non-error conditions of interest.
debug	Software debugging messages. Specify this level only when so directed by a technical support representative.

Table 1 (Severity Level)

4.8.3 User Management

You can change your gateway's username and password by going to the Home screen, under the tools menu, click User Management. From here you can change the login name and password. You can also change the idle timeout; you will need to log back onto the gateway once the timeout expires.

If you forget your password, you can press and hold the reset to factory defaults button for 10 seconds (or more). The gateway will reset to its factory default configuration and all custom configurations will be lost.

The apply button will temporarily save this connection. To make the change permanent you need to click on **Tools** (at the top of the page) and select **System Commands**. At the system commands page, click on **Save All**.

4.8.4 Update Gateway

You can remotely upgrade the gateway's firmware by going to the Home screen, under the tools title, click Update Gateway. This will bring up the screen shown in Figure 19. SOHOSpeed ADSL Gateway will provide two different images; one image is the kernel (operating system) and the other image is the file system.

To upgrade the firmware, click browse, find the firmware file to download. Make sure this is the correct file. Click on upgrade firmware (as shown in Figure 20). Once the upgrade is complete the gateway will reboot. You will need to log back onto the gateway after the firmware upgrade is complete.

The firmware upgrade should take less than 5 minutes to complete. If it takes longer than 5 minutes, something has gone wrong.

Note: Do not remove power from the gateway during the firmware upgrade procedure.

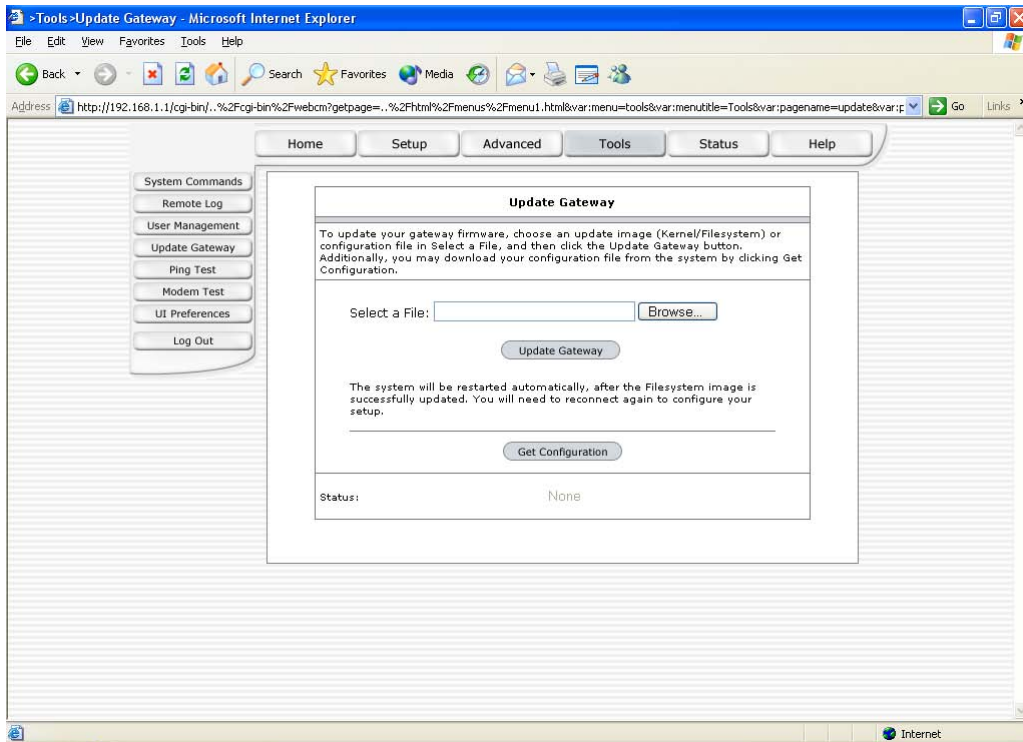

Figure 20 (Update Gateway)

4.8.5 Ping Test

Once you have your gateway configured, it is a good idea to make sure you can Ping the network. You can get to the Ping web page by going to the Home screen, under the Tools title, click Ping Test. Type the target address that you want to ping. If you have your PC connected to the gateway via the default DHCP configuration, you should be able to Ping the network address 192.168.1.1. If your ISP has provided their server address you can try to ping the address. If the pings for both the WAN and the LAN side complete, and you have the proper protocols configured, you should be able to surf the Internet.

By default when you select ping test, the gateway will ping itself 3 times. As shown in Figure 21, the gateway passed the Ping test; this basically means that the TCP/IP protocol is up and running. If this first Ping test does not pass, the TCP/IP protocol is not loaded for some reason; you should restart the modem.

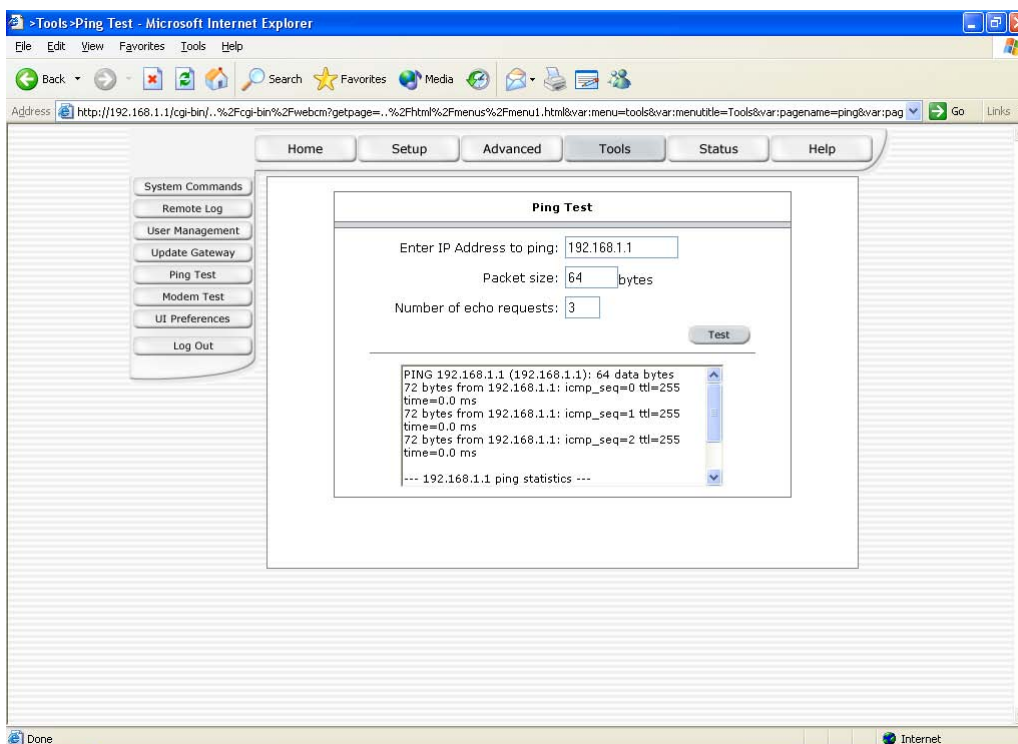

Figure 21 (Ping test)

4.8.6 Modem Test

The Modem Test is used to check whether your Modem is properly connected to the WAN Network. This test may take a few seconds to complete. To perform the test, select your connection from the list and press the Test button. Before running this test, make sure you have a valid DSL link; if the DSL link is not connected, this test will always fail.

Also the DSLAM must support this feature; not all DSLAMs have F4 and F5 support.

4.8.7 UI Support

If you are having difficulty viewing the gateways' web pages, you can change the resolution. You can get to the UI support page by going to the Home screen, under the Tools title, click UI support. The modem supports 640x480, 800x600, and 1024x780 (default).

4.9 Status

The Status section allows you to view the Status/Statistics of different connections and interfaces.

4.9.1 Network Statistics

Select to view the Statistics of different interfaces - Ethernet/USB/DSL.

4.9.2 Connection Status

Select to view the Status of different connections.

4.9.3 DHCP Clients

Select to view the list of DHCP clients.

4.9.4 Modem Status

Select to view the Status and Statistics of your broadband (DSL) connection.

4.9.5 Product Information

You can display the gateway's driver and run-time information by going to the Home screen, under the Status title, click Product Information. Figure 22 illustrates the typical product information, which is provided.

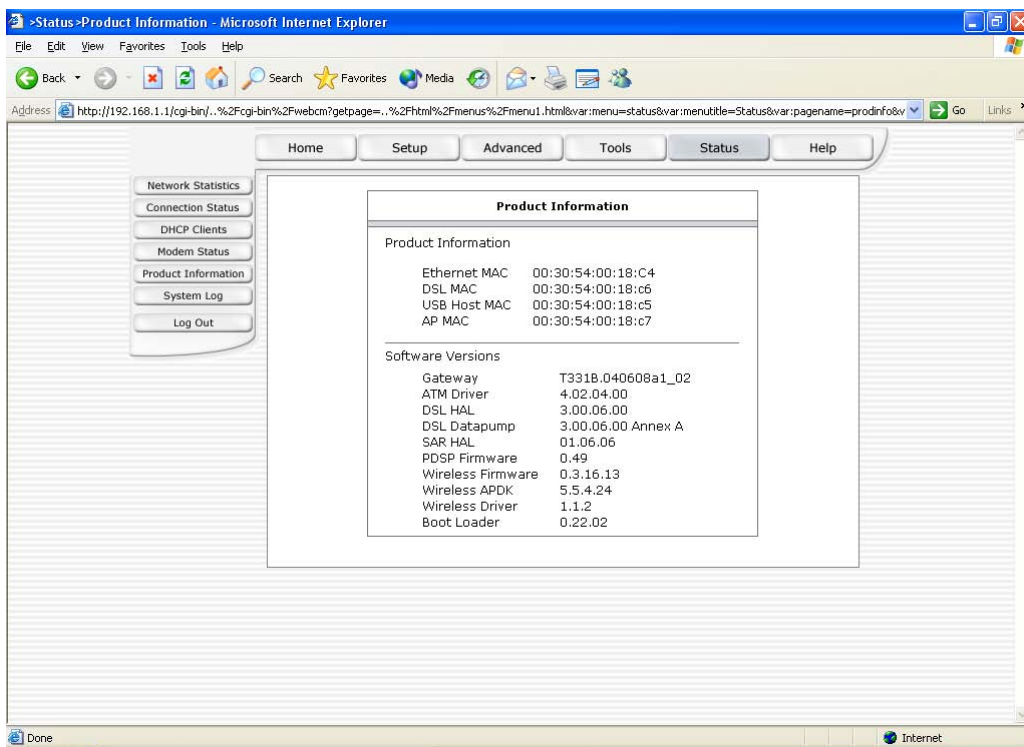

Figure 22 (Product Information)

4.9.6 System Log

You can display the Gateway's log by going to the Home screen, under the Status title, click System log. From here you can view all logged information. Depending upon the severity level, this logged info will generate log reports to a remote host (if remote logging is enabled).

5. Appendix A: Troubleshooting

Below is a list of commonly asked questions. Before calling technical support, please look through these issues to see if they help solve your problem.

5.1 The gateway is not functional.

1. Check to see that the power LED is green and than the network cables are installed correctly. Refer to the quick start guide for more details.
2. Check to see that the LAN and WAN LEDs are green.
3. Check to see that the DSL LED is green
4. Make sure you are not connecting the USB and the Ethernet port at the same time. You must only use 1 interface at a time.
5. Check the settings on your PC. Again, refer to the quick start guide for more details
6. Check the gateway's settings.
7. From your PC, can you PING the gateway? Assuming that the gateway has DHCP enabled and your PC is on the same subnet as the gateway, you should be able to PING the gateway.
8. Can you PING the WAN? Your ISP should have provided the IP address of their server. If you can ping the gateway and your protocols are configured correctly, you should be able to ping the ISPs network. If you cannot PING the ISPs network, make sure your using the correct protocols with the correct VPI/VCI values.
9. Make sure NAT is enabled for your connection. If NAT is disabled you the gateway will not route frames correctly.

5.2 I can't connect to the gateway.

1. Check to see that the power LED is green and that the network cables are installed correctly; see the quick start guide for more details.
2. Make sure you are not connecting the USB and the Ethernet port at the same time. You must only use 1 interface at a time.
3. Make sure that your PC and the gateway is on the same network segment. The gateway's default IP address is 192.168.1.1. If you are running a Windows based PC, you can open a DOS window and type IPCONFIG; make sure that the network adapter that is connected to the gateway is within the same 192.168.1.x subnet.
4. Also, your PC's Subnet Mask should match the gateways subnet mask. The gateway has a default subnet mask of 255.255.255.0.
5. If this still does not work, press the reset button for 10 seconds. This will place the gateway into its factory default state. Go through the above procedures again.
6. Make sure NAT is enabled for your connection. If NAT is disabled you the gateway will not route frames correctly.

5.3 The LEDs blink in a sequential pattern.

This typically means that either the kernel or flash file system is corrupted. The only way to recover from this type of failure is via the PC tool. You need to install the PC tool that was provided with SOHOSpeed ADSL Gateway and perform the following steps:

1. In windows disable all network adapters except the one, which is connected to the gateway.
2. Disable zone alarm or any IP blocking software that is running on the PC.
3. Run the PC tool application. At the IP address prompt, type 192.168.1.1 and retrieve/assign IP address. The PC application should come back with information about the gateway. You then need to load the kernel image, flash file system, and config.xml file to the flash.
4. Once all three codes have been loaded into the gateway, the gateway will automatically reboot. As long as there is no problem with the Flash memory, the gateway should be functional and the LEDs should light correctly.

5.4 The DSL Link LED continues to blink but does not go solid.

1. This means that the DSL line is trying to train but for some reason it cannot establish a valid connection. The main cause of this is that you are too far away from the central office. Contact your DSL service provider for further assistance.

5.5 The DSL Link LED is always off.

1. Make sure you have DSL service. You should get some kind of information from your ISP which states that DSL service is installed. You can usually tell if the service is installed by listening to the phone line; you will hear some high-pitched noise. If you do not hear high-pitched noise, contact your ISP.
2. Verify that the phone line is connected directly to the wall and to the line input on the gateway. If the phone line is connected to the phone side of the gateway or you have a splitter installed on the phone line, the DSL light will not come on.

6. Gateway terms

What is a firewall?

A firewall is protection between the Internet and your local network. It acts similarly to the firewall in your car, protecting the interior of the car from the engine. Your car's firewall has very small opening that allow desired connections from the engine into the cabin (gas pedal connection, etc), but if something happens to your engine, you are protected.

The firewall in the Gateway is very similar. Only the desired connections that you allow are passed through the firewall. These connections are normally originating from the local network; such as web browsing, checking your email, downloading a file, and playing a game. However, in some cases, you can allow incoming connections so that you can run programs like a web server.

What is NAT?

NAT stands for Network Address Translation. Another name for it is Connection Sharing. What does this mean? Your ISP provides you with a single network address for you to access the Internet through. However, you may have several machines on your local network that want to access the Internet at the same time. The Gateway provides NAT functionality that converts your local network addresses to the single network address provided by your ISP. It keeps track of all these connections and makes sure that the correct information gets to the correct local machine.

Occasionally, there are certain programs that don't work well through NAT. Some games, and some specialty applications have a bit of trouble. The Gateway contains special functionality to handle the vast majority of these troublesome programs and games. NAT does cause problems when you want to run a SERVER though. When running a server, please see the DMZ section below.

What is a DMZ?

DMZ really stands for Demilitarized Zone. It is a way of separating out part of your local network so that is more open to the Internet. Suppose that you want to run a web-server, or a game server. Normal servers like these are blocked from working by the NAT functionality. The solution is to "isolate" the single local computer into a DMZ. This makes the single computer look like it is directly on the Internet, and others can access this machine. Your machine isn't really directly connected to the Internet, and it really has an internal local network address. When you provide the servers network address to others, you must provide the address of the Gateway. The Gateway "fakes" the connection to your machine. You should use the DMZ when you want to run a server that others will access from the Internet. Internal programs and servers (like print servers, etc) should NOT be connected to the DMZ

What is a Gateway?

The Internet is so large that a single network cannot handle all of the traffic and still deliver a reasonable level of service. To overcome this limitation, the network is broken down into smaller segments or subnets that can deliver good performance for the stations attached to that segment. This segmentation solves the problem of supporting a large number of stations, but introduces the problem of getting traffic from one subnet to another.

To accomplish this, devices called routers or gateways are placed between segments. If a machine wishes to contact another device on the same segment, it transmits to that station directly using a simple discovery technique. If the target station does not exist on the same segment as the source station, then the source actually has no idea how to get to the target.

One of the configuration parameters transmitted to each network device is its default gateway. This address is configured by the network administrators and it informs each personal computer or other network device where to send data if the target station does not reside on the same subnet as the source. If your machine can reach all stations on the same subnet (usually a building or a sector within a building), but cannot communicate outside of this area, it is usually because of an incorrectly configured default gateway.

FEDERAL COMMUNICATIONS COMMISSION

This device complies with Part 15 of the FCC Rules. Operation is subject to the following two conditions:(1) this device may not cause harmful interference, and (2) this device must accept any interference received, including interference that may cause undesired operation.

Changes or modifications not expressly approved by the party responsible for compliance could void the user's authority to operate the equipment.

NOTE

This equipment has been tested and found to comply with the limits for a Class B digital device, pursuant to Part 15 of the FCC Rules. These limits are designed to provide reasonable protection against harmful interference in a residential installation. This equipment generates, uses and can radiated radio frequency energy and, if not installed and used in accordance with the instructions, may cause harmful interference to radio communications.

However, there is no guarantee that interference will not occur in a particular installation. If this equipment does cause harmful interference to radio or television reception, which can be determined by turning the equipment off and on, the user is encouraged to try to correct the interference by one or more of the following measures:

- Reorient or relocate the receiving antenna.
- Increase the separation between the equipment and receiver.
- Connect the equipment into an outlet on a circuit different from that to which the receiver is connected.
- Consult the dealer or an experienced radio/TV technician for help.

Note:

This device and its antenna(s) used for this transmitter must not be co-located or operating in conjunction with any other antenna or transmitter.

This equipment complies with FCC radiation exposure limits set forth for an uncontrolled environment. In order to avoid the possibility of exceeding the FCC radio frequency exposure limits, human proximity to the antenna shall not be less than 20cm (8 inches) during normal operation.