



CBW560 Series
DOCSIS/EURODOCSIS 2.0 Compliant
4 Ports Ethernet Cable Modem Router with Wireless
User's Manual

Revision 1.0
Jan 2008

Federal Communication Commission Interference Statement

This equipment has been tested and found to comply with the limits for a Class B digital device, pursuant to Part 15 of the FCC Rules. These limits are designed to provide reasonable protection against harmful interference in a residential installation. This equipment generates, uses and can radiate radio frequency energy and, if not installed and used in accordance with the instructions, may cause harmful interference to radio communications. However, there is no guarantee that interference will not occur in a particular installation. If this equipment does cause harmful interference to radio or television reception, which can be determined by turning the equipment off and on, the user is encouraged to try to correct the interference by one of the following measures:

- Reorient or relocate the receiving antenna.
- Increase the separation between the equipment and receiver.
- Connect the equipment into an outlet on a circuit different from that to which the receiver is connected.
- Consult the dealer or an experienced radio/TV technician for help.

This device complies with Part 15 of the FCC Rules. Operation is subject to the following two conditions:

- (1) This device may not cause harmful interference, and
- (2) This device must accept any interference received, including interference that may cause undesired operation.

Information to User

To assure continued compliance, (example - use only shielded interface cables when connecting to computer or peripheral devices) any changes or modifications not expressly approved by the party responsible for compliance could void the user's authority to operate this equipment.

Only Coaxial cables are to be used with this device in order to ensure compliance with FCC emissions limits. Accessories connected to this device by the user must comply with FCC Class B limits. The manufacturer is not responsible for any interference which results from use of improper cables, or which results from unauthorized changes or modifications to the device.

"A Minimum 26 AWG Line Core should be used for connection to the cable modem"

IMPORTANT NOTE:

FCC Radiation Exposure Statement:

This equipment complies with FCC radiation exposure limits set forth for an uncontrolled environment. This equipment should be installed and operated with minimum distance 20cm between the radiator & your body.

This transmitter must not be co-located or operating in conjunction with any other antenna or transmitter.

Warranty

Items sold by manufacturer/distributor/agent, hereinafter called "Seller", are warranted only as follows: Except as noted below Seller will correct, either by repair or replacement at its option, any defect of material or workmanship which develops within one year after delivery of the item to the original Buyer provided that evaluation and inspection by Seller discloses that such defect developed under normal and proper use. Repaired or replaced items will be further warranted for the unexpired term of their original warranty. All items claimed defective must be returned to Seller, transportation charges prepaid, and will be returned to the Buyer with transportation charges collect unless evaluation proves the item to be defective and that the Seller is responsible for the defect. In that case, Seller will return to Buyer with transportation charge prepaid. Seller may elect to evaluate and repair defective items at the Buyer's site. Seller may charge Buyer a fee (including travel expenses, if needed) to cover the cost of evaluation if the evaluation shows that the items are not defective or that they are defective for reasons beyond the scope of this warranty.

The Seller makes no warranty concerning components or accessories not manufactured by it. However, in the event of failure of such a part, Seller will give reasonable assistance to Buyer in obtaining from the manufacturer whatever adjustment is reasonable in light of the manufacturer's own warranty. Seller will not assume expense or liability for repairs made outside the factory by other than Seller's employees without Seller's written consent.

SELLER IS NOT RESPONSIBLE FOR DAMAGE TO ANY ASSOCIATED EQUIPMENT, NOR WILL SELLER BE HELD LIABLE FOR INCIDENTAL, CONSEQUENTIAL, OR OTHER DAMAGES. THIS WARRANTY IS IN LIEU OF ALL OTHER WARRANTIES EXPRESSED OR IMPLIED INCLUDING THE IMPLIED WARRANTY OF "MERCHANTABILITY" AND "FITNESS FOR PARTICULAR PURPOSE."

Trademarks

All trademarks are the property of their respective owners.

Table of Contents

1. INTRODUCTION.....	1
1.1 FEATURES	1
1.2 SYSTEM REQUIREMENTS.....	1
1.3 UNPACKING AND INSPECTION	2
1.4 SAFETY PRECAUTIONS	2
2. HARDWARE OVERVIEW.....	3
2.1 FRONT PANEL AND LEDS	3
3. ETHERNET INSTALLATION.....	5
4. USB DRIVER INSTALLATION	6
4.1 WINDOWS XP	6
4.2 WINDOWS 2003	8
4.3 WINDOWS VISTA	10
5. WEB MANAGEMENT	12
5.1 ENTER MODEM'S IP ADDRESS	12
5.2 STATUS	13
5.2.1 <i>Software Status</i>	13
5.3 BASIC.....	14
5.3.1 <i>DHCP</i>	14
5.4 ADVANCED	15
5.4.1 <i>Options</i>	15
5.4.2 <i>IP Filtering</i>	16
5.4.3 <i>MAC Filtering</i>	16
5.4.4 <i>Port Filtering</i>	17
5.4.5 <i>Forwarding</i>	17
5.4.6 <i>Port Triggers</i>	18
5.4.7 <i>DMZ Host</i>	18
5.5 FIREWALL	19
5.5.1 <i>Local Log</i>	19
5.6 PARENTAL CONTROL	20
5.7 WIRELESS	22
5.7.1 <i>Basic</i>	22
5.7.2 <i>Security</i>	22
5.7.3 <i>Access Control</i>	23
5.7.4 <i>Advanced</i>	23
5.7.5 <i>Bridging</i>	24
5.7.6 <i>WMM</i>	24
5.7.7 <i>Guest Network</i>	24
5.8 MTA.....	25
5.8.1 <i>Status</i>	25
APPENDIX: CABLE MODEM SPECIFICATION.....	26

1. Introduction

The CBW560 is a Voice over IP Wireless Residential Gateway integrated with Cable Modem which allows you implement your VoIP phone call directly through Cable Modem Broadband Network service with its built-in PacketCable 1.5 and DOCSIS/EURODOCSIS 2.0 compliant specification.

Equipped with two standard phone ports, CBW560 series could easily provide end-users low-cost, long-distance calling, faxing, and a host of advanced service including CBW560-to-Phone, Phone-to-CBW560, and CBW560-to-CBW560.

And with the integration of 4 ports switch and IEEE 802.11g wireless functionality, the CBW560 series could also be used as a Wireless Cable Modem Residential Gateway in your home or small office. The ability to route data information into your broadband network could help you easily extend your local network via wire or wireless.

The CBW560 is MGCP/SIP compliant and has been tested with most major VoIP Softswitch vendors' Call Management systems. And it also has voice support that includes hardware based Quality of Service (QoS), voice compression (popular voice CODECs G.711, G.729A, G.723.1, and so on), echo cancellation, dynamic latency (jitter) buffers, silence suppression, and comfort noise generator.

Features

- Fully DOCSIS / EURODOCSIS 1.1/2.0 Compliant with Channel Bonding and 2.0b
- TurboQAM Performance Enhancements
- SmartSpectrum Noise Immunity Technology
- Propane Packet Accelerator
- Super I/O Configuration
- 10/100 Fast Ethernet
- USB2.0
- IEEE802.11b/g with Detachable antennas
- IEEE802.11n future supported
- WPS (WiFi Security Setup) Supported

System Requirements

- IBM Compatible, Macintosh or other workstation supports TCP/IP protocol.
- An Ethernet port supports 10Base-T/100Base-TX Ethernet connection or USB-equipped PC.
- Subscribed to a Cable Television company for Cable Modem services.

Unpacking and Inspection

Included in the kit is the following:

- CBW560 Cable Modem Router * 1
- Quick Installation Guide * 1
- RJ-45 CAT 5 cable * 1
- 12 V/1.0A Power Adaptor * 1
- USB Cable * 1
- CD-ROM containing USB driver and User's Manual * 1

If any of above items lost or damaged, please contact your retailer or ISP for assistance.

Safety Precautions

For your protection, observe the following safety precautions when setting up and using your equipment. Failure to observe these precautions can result in serious personal injury and damage to your equipment.

- Make sure the voltages and frequency of the power outlet matches the electrical rating labels on the AC Adapter.
- Do not place any object on top of the device or force it into a confined space.
- Never push objects of any kind through openings in the casing. Dangerous voltages may be present. Conductive foreign objects could produce a short circuit that could cause fire, electrical shock, or damage to the equipment.
- Whenever there is danger of lightning, disconnect the power cable and the Hybrid-Fiber Coax cable from the cable modem to prevent damage to the unit. The use of an AC protection device will not completely protect the cable modem product from damage caused from the transmission across the Hybrid-Fiber Coax network.

2. Hardware Overview

Front Panel and LEDs

There are Eleven Light-Emitting-Diodes (LEDs) located on the front panel top provide status information to the user.



LED	COLOR	MODE	STATUS
WPS	Blue	Blinking	WPS Activating
		On	WPS Connected
		Off	No WPS Connection
POWER	Green	On	Connected with power
		Off	Power failure or disconnect
RX	Green	On	Downstream Data traffic
		Off	Without data
TX	Green	On	Upstream Data traffic
		Off	Without data
CABLE	Green	Blinking	TFTP/DHCP in process
		On	Cable connected
		Off	Disconnected
LAN 1	Green	Blinking	Data traffic
		On	Ethernet port 1 linked
		Off	Disconnected
LAN 2	Green	Blinking	Data traffic
		On	Ethernet port 2 linked
		Off	Disconnected
LAN 3	Green	Blinking	Data traffic
		On	Ethernet port 3 linked
		Off	Disconnected
LAN4	Green	Blinking	Data traffic
		On	Ethernet port 4 linked
		Off	Disconnected
USB	Green	Blinking	USB activity
		On	USB linked
WIFI	Green	Blinking	Data traffic
		On	WiFi Device Working

2.2 Rear Panel and Hardware Connection

This chapter describes the proper steps for connecting your cable modem. Please be sure to follow the steps in the sequence outlined below. Failure to do so could result in improper operation or failure of your cable modem.

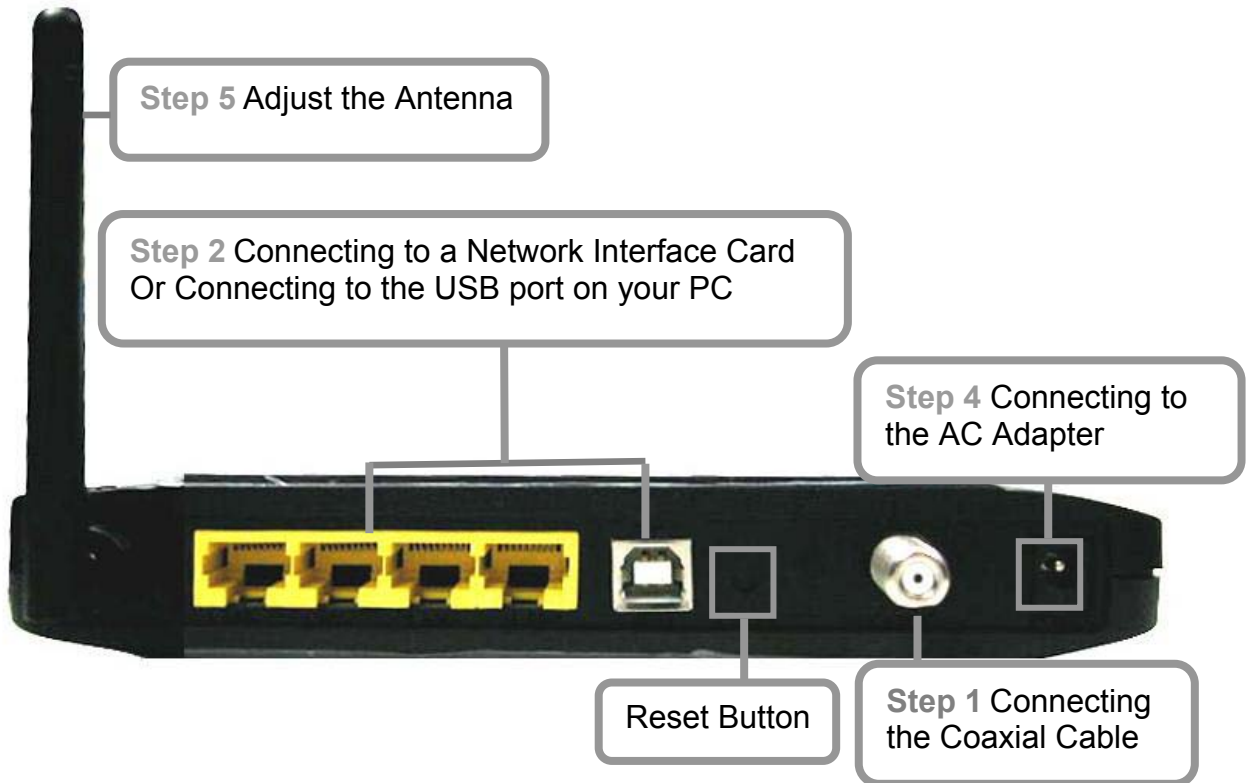

Step 1: Connect a cable by feeding the F-connector on the back of the cable modem. Ensure the center conductor of the 75 ohm coaxial cable is inserted directly into the center of the F-connector. Secure the coaxial cable by carefully threading the outer shell of the coaxial cable connector onto the F-connector in a clockwise direction until tight. Be careful not to over-tighten the connector or you may damage either the connector or the cable modem.

Step 2: Connect the data cable modem to an IEEE 802.3 10BaseT / 802.3u 100Base-TX Network using a RJ-45 male-terminated Ethernet cable or an USB cable to the PC.

Step 3: Connect the AC Adapter to the cable modem by inserting the barrel-shaped connector into the mating power connector on the back of the cable modem. Exercise carefully to ensure the connectors are properly aligned prior to insertion and ensure the two connectors engage completely. The cable modem is shipped with an AC adapter. Remember to use only power adapter that came with the cable modem. Other power adapters might have voltages that are not correct for your particular cable modem. Using a power adapter with the wrong voltage can damage the cable modem.

- This product can be mounted on wall, There are two holes in the lower case , you can use the screw to mount it.

3. Ethernet Installation

The LAN port you are using is auto-negotiating 10/100Mbps (Switch) Ethernet Interface. You can use the Ethernet port to connect to the Internet with an Ethernet network device such as NIC/Hub/Switch through RJ45.

Before you connect to and install the cable modem, please set the IP address to "Obtain an IP address automatically" as below and do ensure the TCP/IP protocol is installed on your system and configured correctly in your PC.

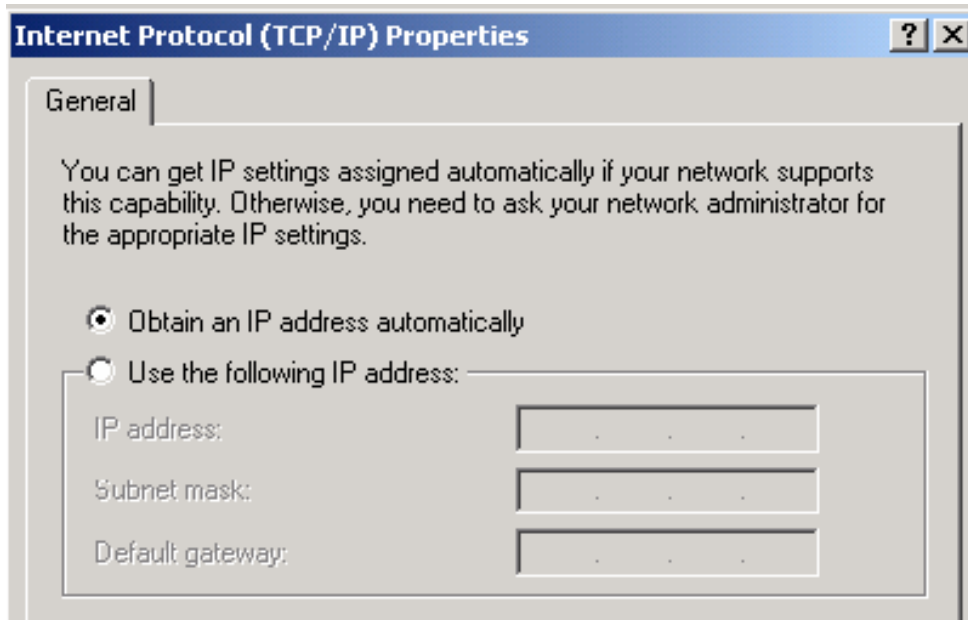

Following is an example of configuring the TCP/IP Protocol on Windows 98 Operating Systems:

1. Click **Start**→**Settings**→**Control Panel**. Double click on the **Network** icon click **Properties**.
2. A list of installed network components appears. Look for an entry named TCP/IP. This entry may be followed by an arrow and a description of the NIC hardware device installed in the computer. If you don't see "TCP/IP" listed anywhere in the "The following network components are installed" box, click the **Add** button, choose **Protocol**, and click the **Add** button. Select "Microsoft" as the manufacturer and then scroll down in the list on the right to find "TCP/IP". If you see "TCP/IP" listed, proceed to step 4.
3. Click the **OK** button. You will be prompted to insert the Windows 98 installation/upgrade CD.
4. Scroll down in the box until you find a line that says "TCP/IP -> " followed by the name of your Ethernet adapter. Click on **Properties** and choose "Obtain an address automatically" which means that your PC has been configured to use DHCP (Dynamic Host Configuration Protocol).
5. Click **OK**.

Congratulations! You have successfully set up your cable modem.

4. USB Driver Installation

Using the USB port to connect to the Internet allows you to install the cable modem more quickly and easily than connecting to the Internet using the Ethernet port, since you do not need to install a network interface card (NIC).

Windows XP

1. Connect USB cable from PC to cable modem.
2. Connect RF cable and power on Cable Modem. Wait until it register, it will take about 40 seconds to 4 minutes depends on network traffic. Cable Modem may reboot if you previously connect it through Ethernet port.
3. Windows will prompt new hardware found, insert the Driver CD into your CD-ROM drive.
4. You may see this window if you had update your Windows XP to Service Pack 2. Select "Yes, this time only" and then click **Next**.



5. Select "Install the software automatically (Recommended)" and then click **Next**.

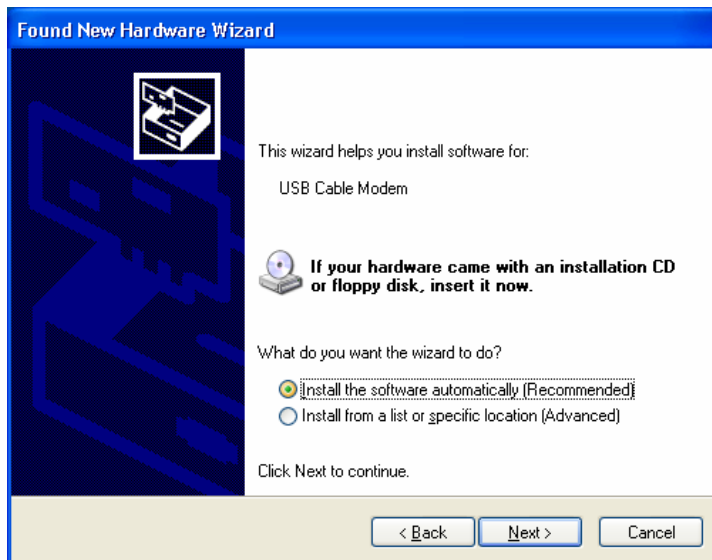

6. Windows will locate the driver automatically. Please click **Continue Anyway** to continue the installation process.



7. Windows shall find the location of USB driver and complete the installation. Click **Finish**.



Windows 2003

1. Connect USB cable from PC to cable modem.
2. Connect RF cable and power on Cable Modem. Wait until it register, it will take about 40 seconds to 4 minutes depends on network traffic. Cable Modem may reboot if you previously connect it through Ethernet port.
3. Windows will prompt new hardware found, insert the Driver CD into your CD-ROM drive.
4. Select "Yes, this time only" and then click **Next**.



5. Select "Install the software automatically (Recommended)" and then click **Next**.

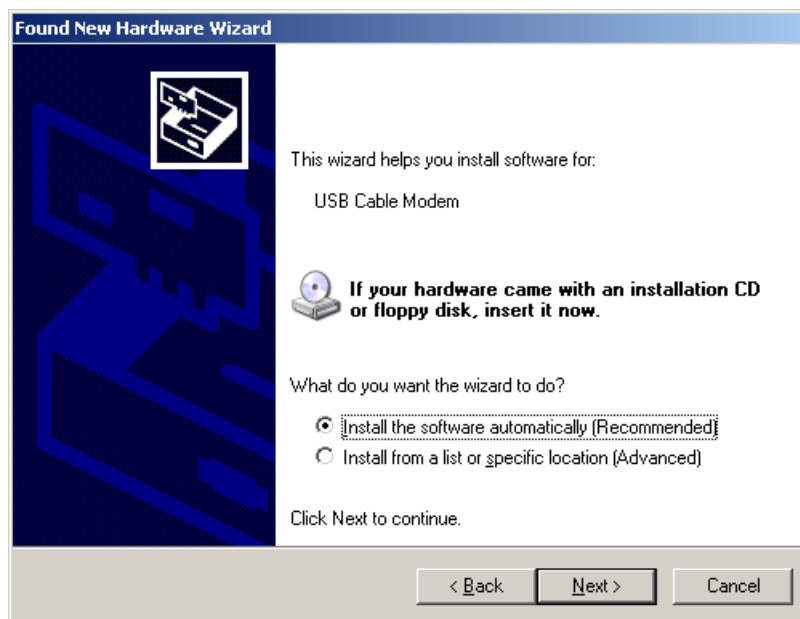

6. Windows will locate the driver automatically. Please click **Continue Anyway** to continue the installation process.



7. Windows shall find the location of USB driver and complete the installation. Click **Finish**.

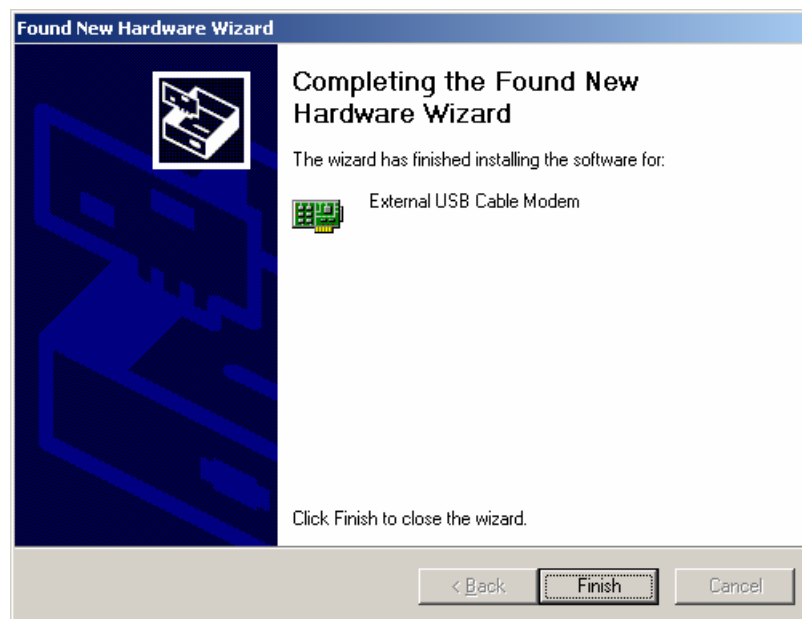

Windows Vista

1. Connect USB cable from PC to cable modem.
2. Connect RF cable and power on Cable Modem. Wait until it register, it will take about 40 seconds to 4 minutes depends on network traffic. Cable Modem may reboot if you previously connect it through Ethernet port.
3. Windows will prompt new hardware found, insert the Driver CD into your CD-ROM drive.
4. Click "Locate and install driver software (recommended)" item

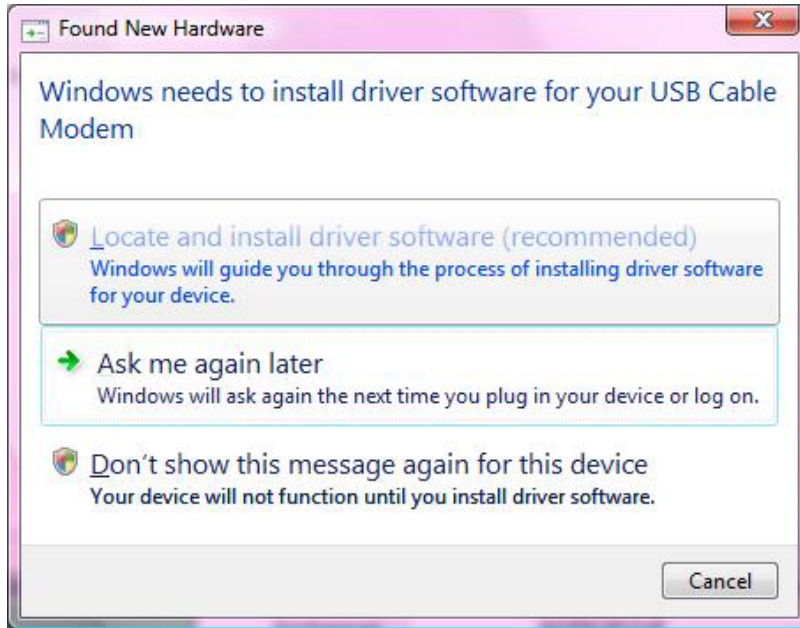

5. Insert the Driver disk that came with your cable modem into your CD-ROM drive. Windows Vista will automatically searched and found this driver.

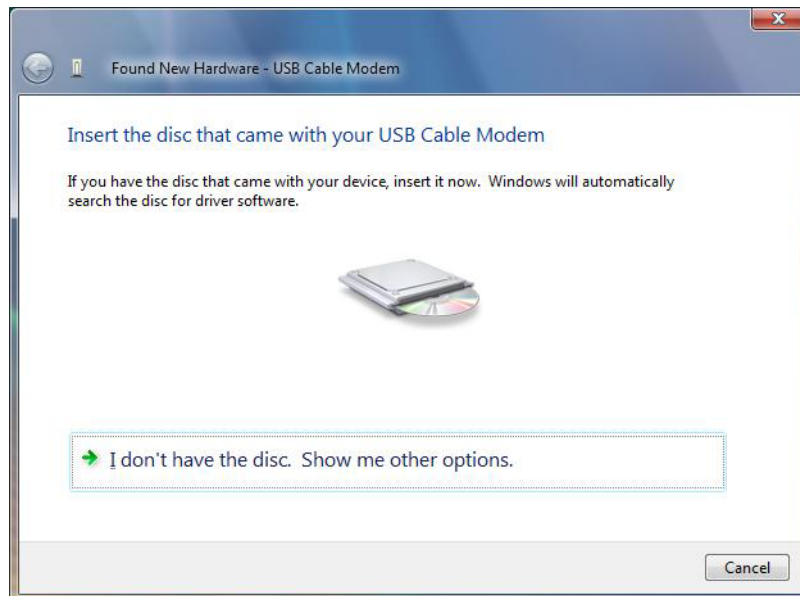

6. During the driver installation, your system may pop-up a dialogue as below window, just click "Install this driver software anyway".

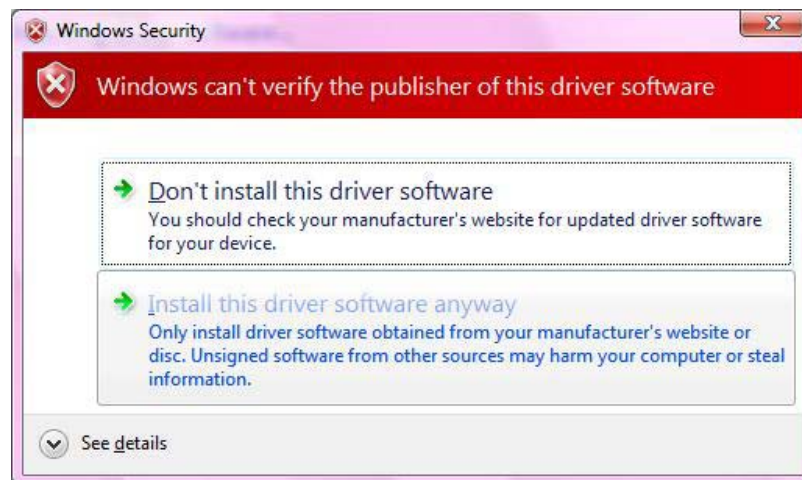

7. During the driver installation, your system may pop-up a dialogue as below window, just click "Install this driver software anyway".

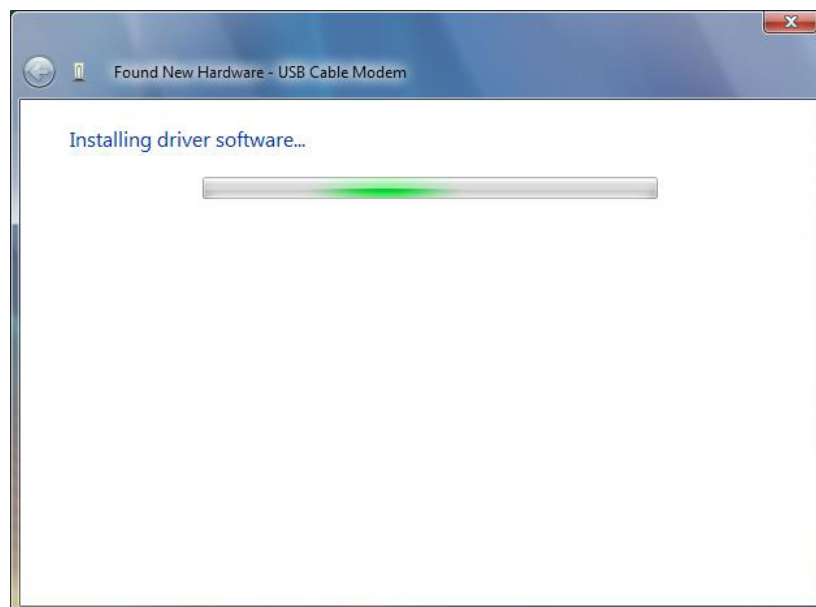

8. Click "Close" button to finish the driver installation.

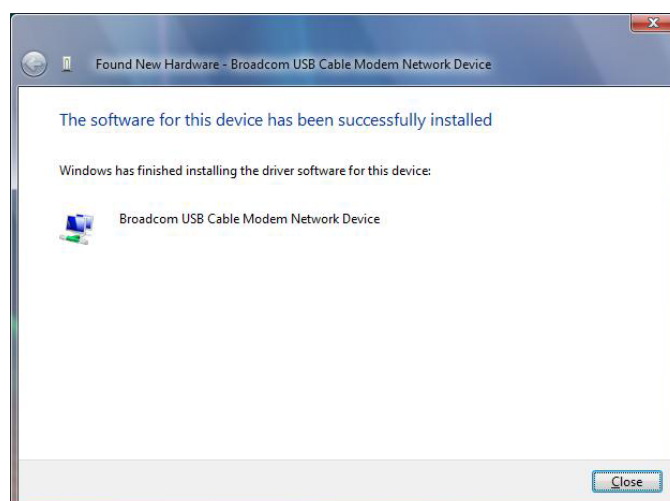

5. Web Management

For easy-changing the default setting or quick-checking diagnostics for troubleshooting, a Web-based GUI is built-in for your access.

Enter Modem's IP address

Use the following procedures to login to your CBW560.

1. Open your web browser.
You may get an error message. This is normal. Continue on to the next step.
2. Type the default IP address of the CBW560 (e.g. **192.168.0.1**) and press Enter.

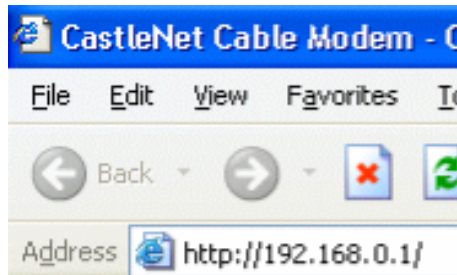

3. The Log In page appears. Type the password (cable) in the respective fields.(user name is blank space)

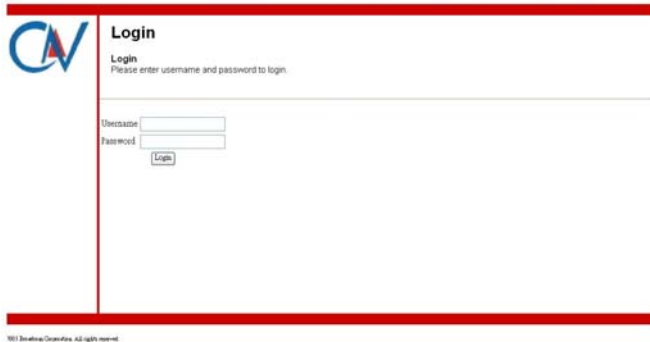

4. click the Logout button to leave the application.

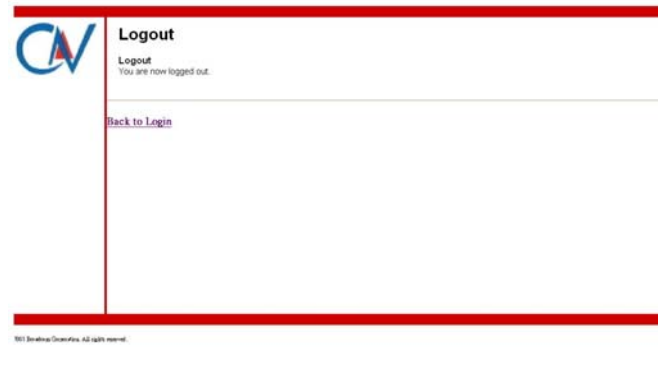

There are seven categories in this web management including Status, Basic, Advanced and Firewall. The following sections describe their details.

Status

The Status page shows hardware and software information about the CBW560 that may be useful to your cable service provider.

5.1.1 Software Status

The Software page shows how long the CBW560 has operated since last being powered up, and some key information the CBW560 received during the initialization process with your cable service provider.

The screenshot shows the 'Status' page of the CBW560 router. The navigation bar at the top includes 'Status', 'Basic', 'Advanced', 'Firewall', 'Parental Control', 'Wireless', 'MTA', and 'Logput'. The 'Status' page features the 'CN' logo and a 'Software' section with the text: 'Software. This page displays information on the current system software.' Below this, there are two tables. The first table, titled 'Information', lists system details. The second table, titled 'Status', shows operational metrics.

Information	
Standard Specification Compliant	DOCSIS 2.0
Hardware Version	6879
Software Version	3.9.21.1
Cable Modem MAC Address	00:10:18:de:ad:01
Cable Modem Serial Number	dead01
CM certificate	Not installed

Status	
System Up Time	0 days 00h:19m:35s
Network Access	Allowed
Cable Modem IP Address	192.168.13.10

If Network Access shows “Allowed,” then your cable service provider has configured the CBW560 to have Internet connectivity. If Network Access shows otherwise, you may not have Internet access, and please contact your cable service provider for assistance.

Basic

The Basic page contains the basic features of CBW560 including Setup, DHCP and Backup

5.1.2 DHCP

The DHCP page allows you to activate/deactivate the DHCP server function of the CBW560, and, if the DHCP server is activated, to see DHCP leases it has provided.

Status Basic Advanced Firewall Parental Control Wireless MTA Logout

Basic

DHCP

This page allows configuration and status of the optional internal DHCP server for the LAN.

DHCP Server Yes No

Starting Local Address

Number of CPEs

Lease Time

DHCP Clients

MAC Address	IP Address	Subnet Mask	Duration	Expires	Select
0018f3c92d2f	192.168.000.010	255.255.255.000	D:00 H:01 M:00 S:00	Tue Jun 26 08:59:29 2007	<input type="button" value="Select"/>

Current System Time: Tue Jun 26 08:58:44 2007

With this function activated, your cable service provider's DHCP server provides one IP address for the CBW560, and the CBW560's DHCP server provides IP addresses, starting at the address you set in **Starting Local Address** field, to your PCs. A DHCP server leases an IP address with an expiration time.

To set the maximum number of PCs to which the CBW560 will issue IP addresses, enter it in the **Number of CPEs** box and then click **Apply**. (CPE is another term sometimes used for PC.)

The table on the bottom of this page shows the information of DHCP clients including the IP and MAC addresses of each PC. Since MAC addresses are unique and permanently fixed into hardware, you can identify any PC listed by its MAC address. The CBW560 provides leases for 3600 seconds (default), and has an automatic renewal mechanism that will keep extending a lease as long as the associated PC remains active.

You can cancel an IP address lease by selecting it in the DHCP Client Lease Info list and then clicking the **Force Available** button. If you do this, you may have to perform a DHCP Renew on that PC, so it can obtain a new lease.

Advanced

The Advanced page allows you to enable/disable some advanced features of the CBW560.

5.1.3 Options

The Options page allows you to enable/disable some advanced features supported by CBW560.

The screenshot shows the 'Advanced' configuration page for the CBW560 router. The 'Options' section is active, displaying a list of features with checkboxes. The 'Apply' button is visible below the list. Below the 'Apply' button is a section for 'PassThrough Mac Addresses' with an input field, an 'Add Mac Address' button, and a 'Remove Mac Address' button. The status 'Addresses entered: 0/32' is shown below the input field.

Check the option you want to use and click **Apply** button to enable the function(s).

- **WAN Blocking:** To prevent others on the WAN side from being able to ping your CBW560. With WAN Blocking on, your CBW560 will not respond to pings it receives, effectively “hiding” your gateway.
- **Isec PassThrough:** To enable IpSec type packets to pass through between WAN and LAN.
- **PPTP PassThrough:** To enable PPTP type packets to pass through between WAN and LAN.
- **Remote Config Management:** To make the Web Management pages of your CBW560 accessible from the WAN side. Page access is limited to only those who know the CBW560 access password you set in the **Status--Security** page.
When accessing the CBW560 from a remote location, you must use HTTP port 8080 and your IP address. This is the "WAN IP address" that appears at the **Basic--Setup** page. For example, if this IP address were 211.20.15.28, you would navigate to `http:// 211.20.15.28:8080` to reach the CBW560's Web Management page from a remote location.
- **Multicast Enable:** To enable multicast traffic to pass through between WAN and LAN. You may need to enable this to see some types of broadcast streaming and content on the Internet, such as webcasting of a popular live event.
- **UPnP Enable:** UPnP (Universal Plug and Play) offers pervasive peer-to-peer network connectivity of PCs of all form factors, intelligent appliances, and wireless devices. UPnP architecture leverages TCP/IP and the Web to enable seamless proximity networking in addition to control and data transfer among networked devices in the home, office, and everywhere in between.

5.1.4 IP Filtering

The IP Filtering page enables you to enter the IP address ranges of PCs on your LAN that you don't permit to have outbound access ability to the WAN. These PCs can still communicate with each other on your LAN, but packets they originate to WAN addresses are blocked by the CBW560.

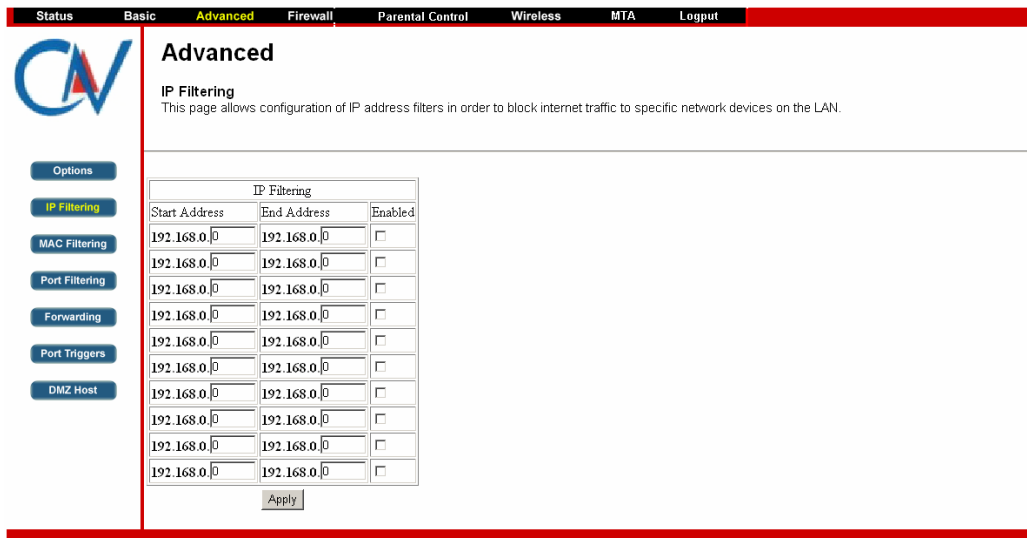

To enable IP Filtering feature of CBW560, check the **Enable** box and click **Apply** button.

5.1.5 MAC Filtering

The MAC Filtering page enables you to enter the MAC address of specific PCs on your LAN that you don't permit to have outbound access ability to the WAN. These PCs can still communicate with each other through the CBW560, but packets they send to WAN addresses are blocked.

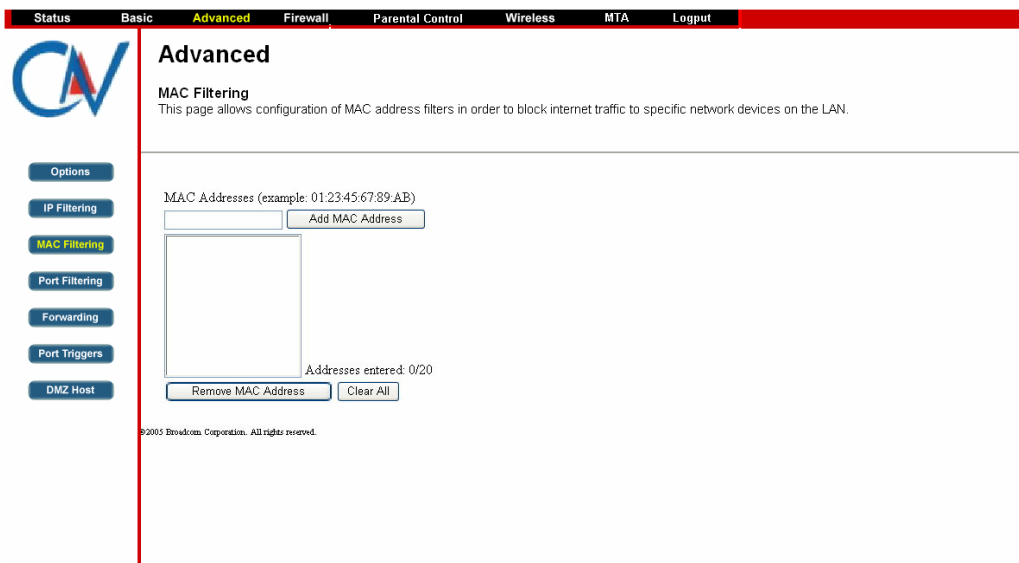

To enable MAC filtering feature of CBW560, enter the MAC address of the LAN device and click **Apply** button.

5.1.6 Port Filtering

The Port Filtering page allows you to enter ranges of destination ports (applications) that you don't want your LAN PCs to send packets to. Any packets your LAN PCs send to these destination ports will be blocked. For example, you could block access to worldwide web browsing (HTTP port 80) but still allow email service (SMTP port 25 and POP3 port 110).

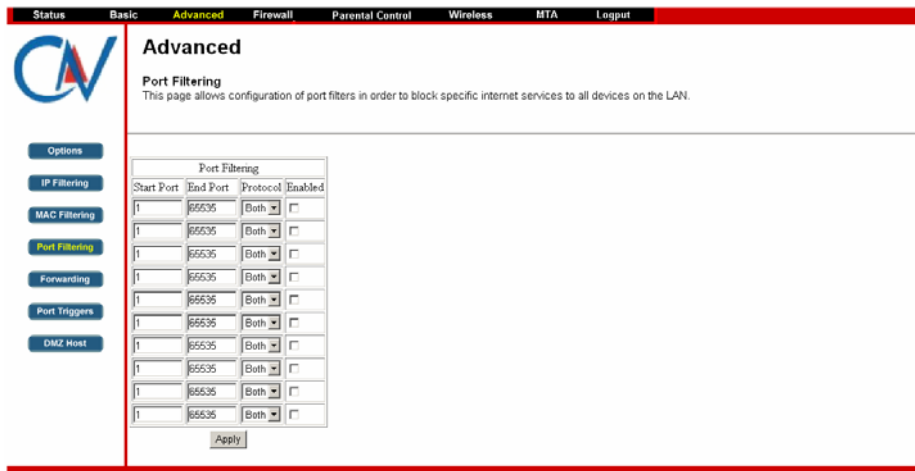

To enable port filtering, enter the **Start port** and **End port** for each range. Then select its protocol from the drop-down list and check the **Enable** box, and click **Apply** button. To block only one port, set both Start and End ports the same.

5.1.7 Forwarding

For communications between LAN and WAN, the CBW560 normally only allows you to originate an IP connection with a PC on the WAN; it will ignore attempts of the WAN PC to originate a connection onto your PC. This protects you from malicious attacks from outsiders. However, sometimes you may wish for anyone outside to be able to originate a connection to a particular PC on your LAN if the destination port (application) matches one you specify. The Forwarding page allows you to specify up to 10 rules.

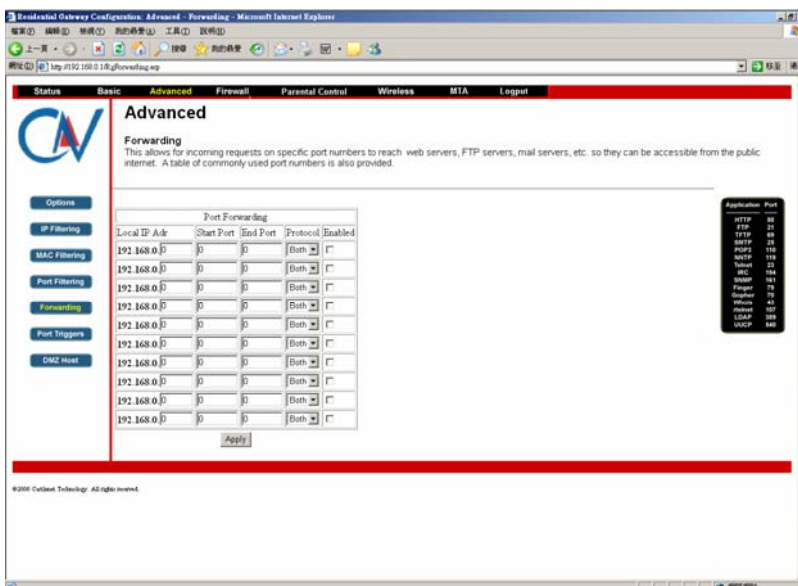

Using the Port Forwarding page, you can provide local services (web servers, FTP servers, mail servers, etc) for people on the Internet or play Internet games. A table of commonly used port numbers is also provided.

5.1.8 Port Triggers

The Port Triggers page allows you to configure dynamic triggers to specific devices on the LAN. This allows for special applications that require specific port numbers with bi-directional traffic to function properly. Applications such as video conferencing, voice, gaming, and some messaging program features may require these special settings.

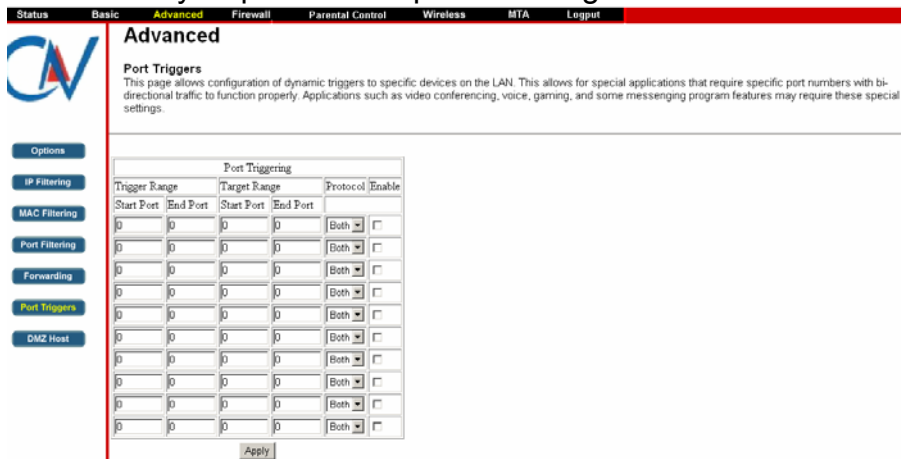

Port Triggering is an elegant mechanism that does the forwarding for you, each time you play the game. You can specify up to 10 port ranges on which to trigger.

5.1.9 DMZ Host

The DMZ page allows you to configure a specific network device to be exposed or visible directly to the WAN (public Internet). Setting a host on your local network as demilitarized zone (DMZ) forwards any network traffic that is not redirected to another host via the port forwarding feature to the IP address of the host (PC). This designates one PC on your LAN that should be left accessible to all PCs from the WAN side for all ports. For example, if you locate a HTTP server on this machine, anyone will be able to access that HTTP server by using your CBW560's IP address as the destination. This may be used when problem applications do not work with port triggers. The setting of "0" indicates NO DMZ PC.

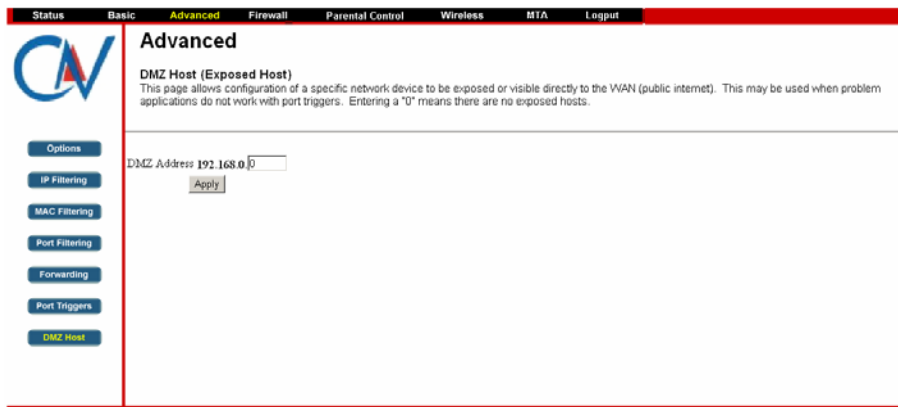

Firewall

The CBW560 provides built-in firewall functions, enabling you to protect the system against denial of service (DoS) attacks and other unwelcome or malicious accesses to your LAN.

5.1.10 Local Log

The Local Log page allows you to configure the firewall event log reported via email alert, and these attack records are also visible in the table on the bottom of this page.

The screenshot shows the 'Firewall' configuration page, specifically the 'Local Log' section. The page has a red navigation bar at the top with tabs for Status, Basic, Advanced, Firewall (selected), Parental Control, Wireless, MTA, and Logout. The main content area is titled 'Firewall' and 'Local Log'. It contains a description: 'This page allows configuration of Firewall event log reporting via email alerts and a local view of the attacks on the system.' Below this are input fields for 'Contact Email Address' and 'SMTP Server Name', an 'E-mail Alerts' checkbox with an 'Enable' label, and an 'Apply' button. At the bottom, there is a table header with columns: 'Description', 'Count', 'Last Occurrence', 'Target', and 'Source'. Below the header are two buttons: 'E-mail Log' and 'Clear Log'.

Specifies the e-mail address and its SMTP of the administrators who should receive notices of any attempted firewall violations. Type the addresses in standard Internet e-mail address format, for example, `yourname@onecompany.com`. Then check the **Enable** box to enable the alert feature.

Click **E-mail Log** to immediately send the email log. Click **Clear Log** to clear the table of entries for a fresh start.

Parental Control

5.6.1 User Setup

This page allows configuration of users. “White List Only” feature limits the user to visit only the sites, specified in the Allowed Domain List of his/her content rule.

©2003 Broadcom Corporation. All rights reserved.

5.6.2 Basic Setup

This page allows basic selections of rules which block certain Internet content and certain Web sites. When you change your Parental Control settings, you must click on the appropriate “Apply”, “Add” or “Remove” button for your new setting to take effect. If you refresh your browser’s display, you will see the currently active settings.

©2003 Broadcom Corporation. All rights reserved.

5.6.3 Time of Day Access Policy

This page allows configuration of time access policies to block all internet traffic to and from specific network devices based on time of day setting.

The screenshot shows the 'Parental Control' section of the router's web interface. The top navigation bar includes 'Status', 'Basic', 'Advanced', 'Firewall', 'Parental Control', 'Wireless', 'MTA', and 'Logout'. The left sidebar contains navigation buttons for 'User Setup', 'Basic', 'ToD Filter', and 'Local Log'. The main content area is titled 'Parental Control' and contains a sub-section 'Time of Day Access Policy' with a descriptive paragraph. Below this is the 'Time Access Policy Configuration' section, which includes a text input field and an 'Add New Policy' button. The 'Time Access Policy List' section shows a dropdown menu with 'No filters entered.', an 'Enabled' checkbox, and a 'Remove' button. Under 'Days to Block', there are checkboxes for 'Everyday', 'Sunday', 'Monday', 'Tuesday', 'Wednesday', 'Thursday', 'Friday', and 'Saturday'. The 'Time to Block' section has an 'All day' checkbox and time selection fields for 'Start' and 'End', each with hour, minute, and AM/PM dropdowns, and an 'Apply' button.

©2003 Broadcom Corporation. All rights reserved.

5.6.4 Event Log

This page displays Parental Control event log reporting.

The screenshot shows the 'Parental Control' section of the router's web interface. The top navigation bar includes 'Status', 'Basic', 'Advanced', 'Firewall', 'Parental Control', 'Wireless', 'MTA', and 'Logout'. The left sidebar contains navigation buttons for 'User Setup', 'Basic', 'ToD Filter', and 'Local Log'. The main content area is titled 'Parental Control' and contains a sub-section 'Event Log' with a descriptive paragraph. Below this is a table with the following headers: 'Last Occurrence', 'Action', 'Target', 'User', and 'Source'. A 'Clear Log' button is located below the table.

©2003 Broadcom Corporation. All rights reserved.

Wireless

5.1.11 Basic

The Wireless Connection Status page allows configuration of the Access Point parameters including the SSID and channel number.

Wireless
802.11b/g Basic
This page allows configuration of the Access Point parameters, including the SSID and channel number.

Wireless MAC Address: 00-16-38-EA-A5-45
Network Name (SSID): BROADCOM
Network Type: Open
Country: USA
Channel: 1 Current: 1
Interface: Enabled

Apply Restore Wireless Defaults

SecureEasySetup
Use these buttons to manage your SecureEasySetup network.

Create SES Network Open SES Window

©2005 Broadcom Corporation. All rights reserved.

5.1.12 Security

This page allows configuration of the WEP keys and/or passphrase.

Wireless
802.11b/g Privacy
This page allows configuration of the WEP keys and/or passphrase.

WPA: Disabled
WPA-PSK: Enabled
WPA2: Disabled
WPA2-PSK: Disabled

WiFi Protected Setup (WPS)
WPS Config: Enable
Button Mode: WPS
Device Name: BroadcomAP
STA PIN: 94380507

WPA/WPA2 Encryption: TKIP
WPA Pre-Shared Key: [Redacted] Show Key
RADIUS Server: [Redacted]
RADIUS Port: 1612
RADIUS Key: [Redacted]

Group Key Rotation Interval: 0
WPA/WPA2 Re-auth Interval: 300

WEP Encryption: Disabled
Shared Key Authentication: Optional
802.1x Authentication: Disabled

Network Key 1: [Redacted]
Network Key 2: [Redacted]
Network Key 3: [Redacted]
Network Key 4: [Redacted]
Current Network Key: 2
PassPhrase: [Redacted]

Apply Show Key Generate WEP Keys

©2005 Broadcom Corporation. All rights reserved.

5.1.13 Access Control

This page allows configuration of the Access Control to the AP as well as on the connected clients.

The screenshot shows the 'Wireless' configuration page for '802.11b/g Access Control'. The navigation bar at the top includes 'Status', 'Basic', 'Advanced', 'Firewall', 'Parental Control', 'Wireless', 'MTA', and 'Logout'. The left sidebar contains buttons for 'Basic', 'Security', 'Access Control', 'Advanced', 'Bridging', 'WMM', and 'Guest Network'. The main content area has the title 'Wireless' and subtitle '802.11b/g Access Control'. Below the subtitle is a description: 'This page allows configuration of the Access Control to the AP as well as status on the connected clients.' The configuration section includes a 'MAC Restrict Mode' dropdown menu set to 'Disabled' and a table for 'MAC Addresses' with 8 rows and 2 columns. An 'Apply' button is located below the table. At the bottom, there is a 'Connected Clients' section with a red bar containing the text 'MAC Address', 'Type', 'IP Address', and 'Host Name', followed by the message 'No wireless clients are connected.' The footer contains the copyright notice '©2005 Broadcom Corporation. All rights reserved.'

5.1.14 Advanced

This page allows configuration of data rates and WiFi thresholds.

The screenshot shows the 'Wireless' configuration page for '802.11b/g Advanced'. The navigation bar at the top includes 'Status', 'Basic', 'Advanced', 'Firewall', 'Parental Control', 'Wireless', 'MTA', and 'Logout'. The left sidebar contains buttons for 'Basic', 'Security', 'Access Control', 'Advanced', 'Bridging', 'WMM', and 'Guest Network'. The main content area has the title 'Wireless' and subtitle '802.11b/g Advanced'. Below the subtitle is a description: 'This page allows configuration of data rates and WiFi thresholds.' The configuration section includes several dropdown menus and text input fields: '54g™ Mode' (54g Auto), 'Basic Rate Set' (Default), '54g™ Protection' (Auto), 'XPress™ Technology' (Disabled), 'Afterburner™ Technology' (Disabled), 'Rate' (Auto), 'Output Power' (100%), 'Beacon Interval' (100), 'DTIM Interval' (1), 'Fragmentation Threshold' (2346), and 'RTS Threshold' (2347). An 'Apply' button is located at the bottom of the configuration section. The footer contains the copyright notice '©2005 Broadcom Corporation. All rights reserved.'

5.1.15 Bridging

This page allows configuration of WDS features.

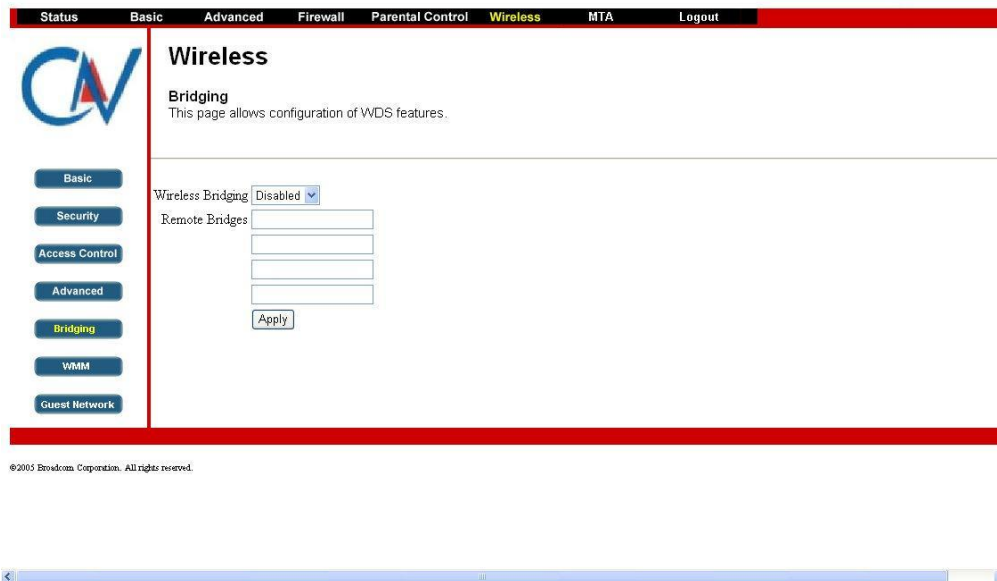

5.1.16 WMM

This page allows configuration of the Wi-Fi Multimedia QoS.

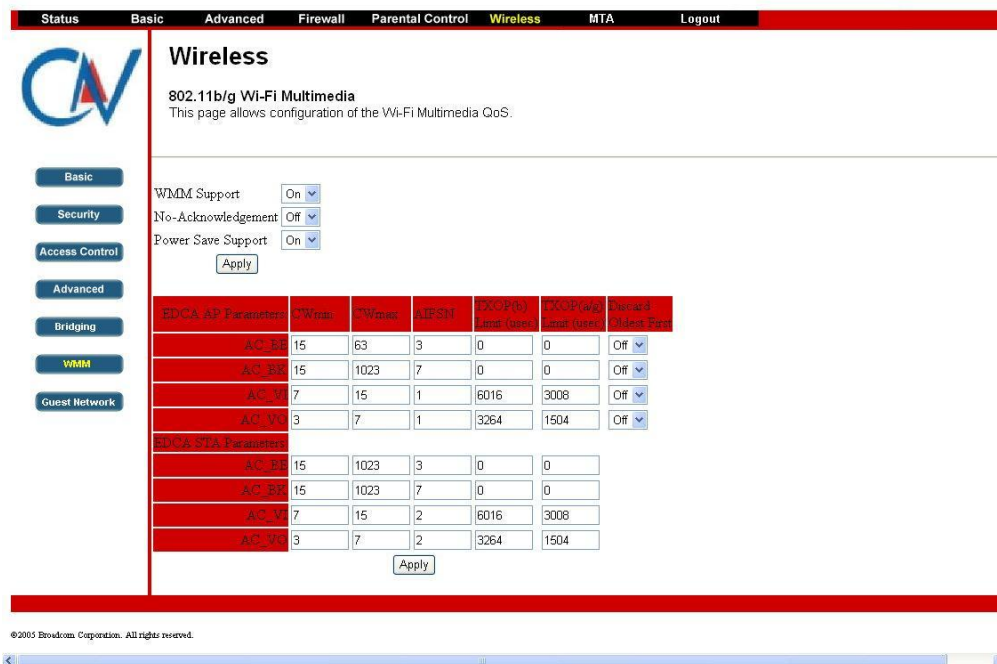

5.1.17 Guest Network

This page allows configuration of a guest network..

Wireless

802.11b/g Guest Network
This page allows configuration of a guest network.

Guest Network: BROADCASTOM_GUEST_0 (02:16:38:EA:A5:3C)

Guest WiFi Security Settings

Guest Network: Enabled
 Guest Network Name (SSID): BROADCASTOM_GUEST_0
 Closed Network: Disabled
 WPA: Disabled
 WPA-PSK: Disabled
 WPA2: Disabled
 WPA2-PSK: Disabled
 WPA/WPA2 Encryption: Disabled
 WPA Pre-Shared Key: [Redacted]
 RADIUS Server: 10.0.0.0
 RADIUS Port: 1812
 RADIUS Key: [Redacted]
 Group Key Rotation Interval: [Redacted]
 WPA/WPA2 Re-auth Interval: 300
 WEP Encryption: Disabled
 Shared Key Authentication: Optional
 802.1x Authentication: Disabled
 Network Key 1: [Redacted]
 Network Key 2: [Redacted]
 Network Key 3: [Redacted]
 Network Key 4: [Redacted]
 Current Network Key: [Redacted]
 PassPhrase: [Redacted]
 Generate WEP Keys
 Apply

Guest LAN Settings

DHCP Server: Enabled
 IP Address: 192.168.1.1
 Subnet Mask: 255.255.255.0
 Lease Pool Start: 192.168.1.10
 Lease Pool End: 192.168.1.99
 Lease Time: 86400
 Apply
 Restore Guest Network Defaults

©2005 Broadcom Corporation. All rights reserved.

MTA

Section MTA has 5 sub-items, which indicate the status of MTA. These information can help you to understand the parameters of MTA operation.

5.1.18 Status

This page displays initialization status of the MTA.

MTA

Status
This page displays initialization status of the MTA.

Startup Procedure

Task	Status
Telephony DHCP	In Progress
Telephony Security	[Error: FAIL]
Telephony TFTP	In Progress
Telephony Call Server Registration	L1: No Security Association / L2: No Security Association
Telephony Registration Complete	In Progress

MTA Line State

Line 1 On-Hook
 Line 2 On-Hook

Appendix: Cable Modem Specification

Table 1. RF Downstream Specification (DOCSIS)

Parameter	Value	Notes
Frequency range	88 MHz to 860 MHz +/- 30 kHz	
Demodulation	64QAM. 256QAM	
Input power range	-15 dBmV to +15 dBmV	One Channel
Symbol Rate	5.056941 Msym/sec (30 Mbps) 5.360537 Msym/sec (43 Mbps)	64QAM 256QAM
Bandwidth	6 MHz	
Total Input Power	<30 dBmV	
Input Impedance	75 Ohms	

Table 2. RF Upstream Specification (DOCSIS)

Parameter	Value				
Frequency Range	5 MHz to 42 MHz				
Modulation	QPSK, 8QAM, 16QAM, 32QAM, 64QAM, 128QAM (SCDMA only)				
Symbol Rate	TDMA: 160K, 320K, 640K, 1280K, 2560K, 5120Ksym/sec S-CDMA: 1280K, 2560K, 5120Ksym/sec				
Bandwidth	TDMA: 200K, 400K, 800K, 1600K, 3200K, 6400KHz S-CDMA: 1600K, 3200K, 6400KHz				
Output power	<table border="1"> <tr> <td>TDMA</td> <td>QPSK: 8 ~ 58 dBmV 8/16QAM: 8 ~ 55 dBmV 32/64QAM: 8 ~ 54 dBmV</td> </tr> <tr> <td>S-CDMA</td> <td>QPSK, 8/16/32/64/128QAM: 8 ~ 53 dBmV</td> </tr> </table>	TDMA	QPSK: 8 ~ 58 dBmV 8/16QAM: 8 ~ 55 dBmV 32/64QAM: 8 ~ 54 dBmV	S-CDMA	QPSK, 8/16/32/64/128QAM: 8 ~ 53 dBmV
TDMA	QPSK: 8 ~ 58 dBmV 8/16QAM: 8 ~ 55 dBmV 32/64QAM: 8 ~ 54 dBmV				
S-CDMA	QPSK, 8/16/32/64/128QAM: 8 ~ 53 dBmV				
Output Impedance	75 Ohms				

Table 3. RF Downstream Specification (for EuroDOCSIS system)

Parameter	Value	Notes
Frequency Range	108 MHz to 862 MHz	
Demodulation	64QAM. 256QAM	
Input power range	+13dBmV to -17dBmV (65QAM) +17dBmV to -13dBmV (256QAM)	
Symbol Rate	056941 Msym/sec (30 Mbps) 5.360537 Msym/sec (43 Mbps)	64QAM 256QAM
Bandwidth	8MHz	
Total Input Power	<30 dBmV	
Input Impedance	75 Ohms	

Table 4. RF Upstream Specification (for EuroDOCSIS system)

Parameter	Value	
Frequency Range	5 MHz to 65 MHz	
Modulation	QPSK, 8QAM, 16QAM, 32QAM, 64QAM, 128QAM (TCM only)	
Symbol Rate	TDMA: 160K, 320K, 640K, 1280K, 2560K, 5120Ksym/sec S-CDMA: 1280K, 2560K, 5120Ksym/sec	
Bandwidth	TDMA: 200K, 400K, 800K, 1600K, 3200K, 6400KHz S-CDMA: 1600K, 3200K, 6400KHz	
Output power	TDMA	QPSK: 8 ~ 58 dBmV 8/16QAM: 8 ~ 55 dBmV 32/64QAM: 8 ~ 54 dBmV
	S-CDMA	QPSK, 8/16/32/64/128QAM: 8 ~ 53 dBmV
Output Impedance	75 Ohms	

Table 5. Electrical Specification

Parameter	Measured Value	Notes
Input Voltage	12VDC/1A	
Power consumption	< 9.5W	With AC adaptor

Table 6. Physical Specification

Parameter	Value
Size	170(H) x 135(W) x 29(D)mm
Weight	280g +/- 10g (Modem only)

Table 7. Environmental Specification

Parameter	Value
Operating Temperature	0 °C to +40 °C
Operating Relative Humidity	10% to 90% (Non-condensing)
Operating Altitude	-100 to +7,000 feet
Storage Temperature	-10 °C to +60 °C

Table 8. RF Specification

Parameter	Value
Frequency Band	2.412 – 2.462GHz(2.4GHz ISM Band)
Number of Channels	11 Channels.
Modulation	DBPSK,DQPSK,CCK DSSS for 802.11b & g; DPSK,QPSK,16QAM OFDM for 802.11g
Supported Rates	1,2,5.5,11 Mbps for 802.11b; 6,9,12,18,24,36,48,54 Mbps for 802.11g
Maximum Receive Level	-20dBm (with PER<10%) for 802.11g
Antenna	External (Hirose U-F-L)
11g PER-Compliant Output Power (Typical)	11b: 17dBm 11g: 16dBm Note: Actual output power may vary based on manufacturing process variations
Under Storage	Temperature: -10°C to + 45°C ambient temperature. Humidity: 95% (non-condensing)

FEDERAL COMMUNICATIONS COMMISSION

This device complies with Part 15 of the FCC Rules. Operation is subject to the following two conditions : (1) this device may not cause harmful interference, and (2) this device must accept any interference received, including interference that may cause undesired operation.