



RF / Microwave Components

Attenuators

Adapters

Bias Tees

Couplers

DC Blocks

Gain Equalizers

Power Dividers

Terminations

Test Cables



Short Form Catalog

Company Profile	1
Attenuators	2-8
Impedance Matching Pads	5
Terminations	9-12
iCALIBER Test Cables	13
Adapters	13-17
DC Blocks	18-19
Bias Tees	20
Equalizers	21
Power Dividers	22
Directional Couplers, Opens, Shorts, Detectors, Dust Caps	23
How to Order	24
Distribution.....	Inside Back Cover

Catalog Notes

The 2.9mm products shown herein are in fact 2.92mm components. Aeroflex / Inmet has elected to use 2.9mm as a "shorthand" designation for the 2.92mm standard.

Components with SMP connectors will also mate with GPO™ products; and the SMPM products mate with GPPO™ components.

The trademarks "GPO™" and "GPPO™" appearing in this catalog are trademarks of Corning Gilbert Inc.

How to use this catalog

This catalog is designed to give you a general description of the broad selection of products manufactured by Aeroflex / Inmet. When used in conjunction with our web site, you can view, print, or download detailed data sheets for each product in PDF format. Each sheet contains an outline drawing, electrical and mechanical specifications, as well as part number examples. It's easy:

1. Simply log on to www.aeroflex.com/inmet.
2. Select the first item "INMET MODEL SEARCH" in the drop-down menu box at left.
3. Enter the Model Number of the Product you wish to see, and touch enter.
4. In the results box that appears, click on the link under the "Product Page" heading, and you will be directed to web page for the selected item.
5. From here you can download a Product Data Sheet for the selected item, or you may request a quote by clicking on the "Quote" button next to the model number.

RoHS Statement

All standard catalog products designed by Aeroflex / Inmet shipped after July 1, 2006 conform to the requirements as specified in the Directive 2002/95/EC of the European Parliament and of the Council of 27 January 2003 and related Annex and Amendments on the Restriction of the Use of Certain Hazardous Substances in Electrical and Electronic Equipment (RoHS). The information presented herein is believed to be accurate, reliable and is a result of review of numerous sources including vendor submitted data sheets and certifications.

Please note:

1. Equalizers are not considered standard catalog products for the purpose of this statement.
2. Some equalizer products may already be RoHS compliant. Please direct any questions to inmet-sales@eroflex.com



Manufacturer and designer of wireless and microwave components, Aeroflex / Inmet's custom design capabilities have generated a substantial number of innovative microwave and wireless components for many markets and programs for more than 35 years.

As product development is a core value, Aeroflex / Inmet will continue to demonstrate its talent for tackling new design tasks. Unusual customer specifications which require Inmet engineering to build custom components enable Inmet to stay ahead in wireless technology by designing, creating, testing and delivering products to be used in 2G, 3G, 4G systems and beyond.

Enthusiastic reaction to Aeroflex / Inmet's total commitment to quality, selection, and just-in-time delivery of precision-made microwave and wireless components has resulted in Inmet's "preferred supplier" designation by many buyers. With notable success in advancing new products, the company's widely known lineup of off-the-shelf products is relied upon by its many customers.

Coaxial components in the DC to 65 GHz frequency range with power levels from 1 to 300 Watts, enhance Inmet's vision to become the world's number one source for coaxial attenuators. The company offers over 3,000 variations of coaxial products including:

- Coaxial Attenuators (1-300 Watt, DC-50 GHz)
- Adapters (In-series and Between Series, DC-65 GHz)
- DC Blocks (Inner, Outer, Inner/Outer Designs up to 40 GHz)
- Equalizers (High Performance, DC-40 GHz)
- Short and Open Circuits (DC-18 GHz)
- Terminations (1-300 Watts, DC-50 GHz)
- Power Dividers, (DC-26.5 GHz)
- Bias Tees (General Purpose, High Power, Broadband)

Aeroflex / Inmet also designs and manufactures multi-component hybrid products such as "between series attenuators," combination "DC block/attenuators," and "by-pass attenuators." Today, Aeroflex / Inmet is a leader in reducing the costs of components while maintaining "first class performance." On demand inventory features hundreds of off-the-shelf catalog items ready for same-day shipment, or overnight delivery.

In addition, many products are available through Richardson RFPD, or RFMW, Aeroflex / Inmet's distributors. By increasing your efficiency and profitability through our total commitment to service, support, quality, delivery, low prices and innovation, Inmet ensures your success...which in turn becomes Aeroflex / Inmet's success as well.

Model A/AH SMA 2 Watt

SHORT: 0.86"
Nominal Length



Models 2A, 6A, 18A, 23A 2AH, 6AH, 18AH, 23AH

Frequency Range..... DC to 23GHz
Available Values..... 0-10, 12, 15, 20, 30dB
Accuracy of Attenuation:
0 through 6dB.....±0.3dB maximum
7 through 20dB.....±0.5dB maximum
21 through 30dB.....±0.75dB maximum
VSWR:
DC to 4GHz.....1.15:1 maximum
4GHz to 8GHz.....1.20:1 maximum
8GHz to 12.4GHz.....1.25:1 maximum
12.4GHz to 18GHz.....1.35:1 maximum
18GHz to 23GHz.....1.40:1 maximum
Overall length in inches

	0-12dB	13-30dB
M/F	.86 ± .03	.99 ± .03
M/M	.98 ± .03	1.11 ± .03
F/F	.87 ± .03	1.00 ± .03

Complete Specification Sheet Available

Model C SMA 2 Watt

SHORTER: 0.76"
Nominal Length



Models 2C, 6C, 18C

Frequency Range..... DC to 18GHz
Available Values..... 0-10, 12, 15, 20, 30dB
Accuracy of Attenuation:
0 through 6dB.....±0.3dB maximum
7 through 20dB.....±0.5dB maximum
21 through 30dB.....±0.75dB maximum
VSWR:
DC to 4GHz.....1.15:1 maximum
4GHz to 8GHz.....1.20:1 maximum
8GHz to 12.4GHz.....1.25:1 maximum
12.4GHz to 18GHz.....1.35:1 maximum
Overall length in inches

	0-12dB	13-30dB
M/F	.76 ± .03	.89 ± .03

Complete Specification Sheet Available

Model DH SMA 2 Watt

SHORTEST: 0.70"
Nominal Length



Models 2DH, 6DH, 18DH, 23DH

Frequency Range..... DC to 23GHz
Available Values..... 0-10, 12, 15, 20, 30, 40dB
Accuracy of Attenuation:
0 through 6dB.....±0.3dB maximum
7 through 19dB.....±0.5dB maximum
20 through 30dB.....±0.7dB maximum
31 through 35dB.....±1.0dB maximum
36 through 40dB.....±1.5dB maximum
VSWR:
DC to 4GHz.....1.15:1 maximum
4GHz to 8GHz.....1.20:1 maximum
8GHz to 12.4GHz.....1.25:1 maximum
12.4GHz to 23GHz.....1.35:1 maximum
Overall length in inches

	0-20dB	21-40dB
M/F	.70 ± .03	.83 ± .03
M/M	.76 ± .03	.89 ± .03
F/F	.64 ± .03	.77 ± .03

Complete Specification Sheet Available

Model AS398 SMA 1 Watt



Model AS398

Frequency Range..... DC to 3 GHz
Available Values..... 1-10, 12, 15, 20, 30dB
Accuracy of Attenuation:
1 through 10,12,15,20dB.....±0.3dB maximum
30dB.....±0.5dB maximum
VSWR:
DC to 3 GHz.....1.20:1 maximum
Overall length in inches

	1-20dB	30dB
M/F	.83 ± .05	1.02 ± .05

Complete Specification Sheet Available

Model AHC SMA 2 Watt



Model AHC

Frequency Range..... DC to 6 GHz
Available Values... 0-10, 12, 15, 20, 30, 40dB
Accuracy of Attenuation:
1 through 10dB.....±0.5dB maximum
12, 15, 20dB.....±0.7dB maximum
30dB.....±0.9dB maximum
40dB.....±1.5dB maximum
VSWR:
DC to 6 GHz.....1.20:1 maximum
Overall length in inches

	0-12,15 & 20dB	30 & 40dB
M/F	.86 ± .03	.97 ± .03

Complete Specification Sheet Available

9000 Series General Purpose 18GHz SMA Attenuators

Models 9023, 9024, 9025 (2 Watts)

Available Values 0-10, 12, 15, 20, 30, 40, 50, 60dB
Accuracy of Attenuation:
0 through 12dB.....±0.75dB maximum
13 through 20dB.....±1.00dB maximum
21 through 40dB.....±1.50dB maximum
41 through 60dB.....±2.00dB maximum

Models 9026 through 9031 (2 Watts)

Available Values..... 0-10, 12, 15, 20, 30dB
Accuracy of Attenuation:
0 through 12dB.....±0.75dB maximum
13 through 20dB.....±1.00dB maximum
21 through 30dB.....±1.50dB maximum
VSWR: (All Models)
DC to 4GHz.....1.20:1 maximum
4GHz to 12.4GHz.....1.40:1 maximum
12.4GHz to 18GHz.....1.60:1 maximum
Overall length in inches

		0-30&40dB	31-60dB (except 40)
9023	M/F no hex	1.21±.03	1.49±.03
9024	M/M no hex	1.33±.03	1.62±.03
9025	F/F no hex	1.06±.03	1.35±.03
		0-12 dB	13-30dB
9026	M/F no hex	.86±.03	.99±.03
9027	M/M no hex	.98±.03	1.11±.03
9028	F/F no hex	.87±.03	1.00±.03
9029	M/F w/hex	.86±.03	.99±.03
9030	M/M w/hex	.98±.03	1.11±.03
9031	F/F w/hex	.87±.03	1.00±.03

Complete Specification Sheets Available

Model B SMA 2 Watt 1.21" Nominal Length



Models 2B, 6B, 18B

Frequency Range..... DC to 18GHz
Available Values...0-10, 12, 15, 20, 30, 40, 50, 60dB
Accuracy of Attenuation:
0 through 6dB.....±0.3dB maximum
7 through 20dB.....±0.5dB maximum
21 through 30dB.....±0.75dB maximum
31 through 60dB.....±1.50dB maximum
VSWR:
DC to 4GHz.....1.15:1 maximum
4GHz to 8GHz.....1.20:1 maximum
8GHz to 12.4GHz.....1.25:1 maximum
12.4GHz to 18GHz.....1.35:1 maximum

Overall length in inches

	0-30 & 40dB	31-60dB
M/F	1.21 ± .03	1.49 ± .03
M/M	1.33 ± .03	1.62 ± .03
F/F	1.06 ± .03	1.35 ± .03

Complete Specification Sheet Available

High Frequency 2.9mm Series DC-26.5 GHz



MODELS 26A AND 26AH (2 Watts)

Frequency Range..... DC to 26.5GHz
Available Values..... 0, 3, 6, 10, 20, 30dB
VSWR:
DC to 18GHz.....1.30:1 maximum
18GHz to 26.5GHz.....1.40:1 maximum

Overall length in inches

	26.5GHz	0-12dB	13-30dB
M/F	.88 ± .05	1.01 ± .05	

Complete Specification Sheet Available

High Frequency 2.9mm Series DC-40 GHz



MODELS 40A, 40AH (0.5 Watt)

Frequency Range..... DC to 40GHz
Available Values.....0, 3, 6, 10, 20, 30dB
VSWR:
DC to 18GHz..... 1.30:1 maximum
18GHz to 40GHz..... 1.40:1 maximum

MODELS 40A2W, 40AH2W (2 Watts)

Frequency Range..... DC to 40GHz
Available Values.....3, 6, 10, 20, 30dB
VSWR:
DC to 18GHz.....1.30:1 maximum
18GHz to 40GHz.....1.40:1 maximum

Overall length in inches

	40GHz	0-30dB	
M/F	.88 ± .05		

Complete Specification Sheet Available

High Frequency 2.4mm & 1.85mm Series DC-50 GHz



Models 40EH and 50EH - 2.4mm (0.5 Watt)

Frequency Range..... DC to 50GHz
Available Values..... 0, 3, 6, 10, 20, 30dB
Accuracy of Attenuation:
DC - 26.5 GHz
0 through 10dB.....±0.5dB maximum
20 & 30dB.....±0.75dB maximum
26.5 - 40 GHz
0 through 10dB.....±1.0dB maximum
20 & 30dB.....±1.25dB maximum
40 - 50 GHz
0 through 10dB.....±1.5dB maximum
20 & 30dB.....±2.0dB maximum
VSWR:
DC to 26.5 GHz.....1.35:1 maximum
26.5 to 40 GHz.....1.60:1 maximum
40 to 50 GHz.....1.75:1 maximum

Models 50V - 1.85mm (2 Watts)

Frequency Range..... DC to 50GHz
Available Values..... 3, 6, 10dB

Complete Specification Sheet Available

SMP, GPO™ Series DC-26.5 GHz



Models 18G, 18P (2 Watts)

Frequency Range.....DC to 18GHz
Available Values.....0-10, 12, 15, 20 and 30dB
Accuracy of Attenuation:
0 through 6dB.....±0.4dB maximum
7 through 12dB.....±0.6dB maximum
20 and 30dB.....±0.8dB maximum
VSWR:
DC to 8GHz.....1.25:1 maximum
8GHz to 18GHz.....1.35:1 maximum

Models 26G, 26P (2 Watts)

Frequency Range.....DC to 26.5GHz
Available Values.....0, 3, 6, 10, 20 and 30dB
Accuracy of Attenuation:
DC-26.5GHz
0-4 and 6dB.....±0.6dB maximum
10dB.....±0.8dB maximum
20 and 30dB.....±1.2dB maximum
VSWR:
DC to 26.5GHz.....1.45:1 maximum

Note: GPO™ and SMP male connectors are available in full and limited detent.

Complete Specification Sheet Available

SMPM Series DC-26.5 GHz



MODELS 6MP and 18MP (2 Watts)

Frequency Range..... DC to 18GHz
Available Values.....0-10, 12, 15, 20, 30dB
VSWR:
DC to 18GHz.....1.35:1 maximum

MODEL 26MP (2 Watts)

Frequency Range.....DC to 26.5GHz
Available Values..... 3, 6, 10, 20, 30dB
VSWR:
DC to 18GHz..... 1.35:1 maximum
18 to 26.5GHz.....1.50:1 maximum

Overall length in inches

	18GHz	0-15, 20 dB	30 dB
M/F	.61 ± .05	.74 ± .05	
M/M	.61 ± .05	.74 ± .05	
F/F	.61 ± .05	.74 ± .05	

Complete Specification Sheet Available

TNC Series 2 Watts



Model 9042 & 9036 (Nickel Plated Brass)
Frequency Range..... DC to 12.4GHz
Available Values...0-10, 12, 15, 20, 30 & 40dB

Models 18T (Stainless Steel)
Frequency Range...0-10,12,15,20,30,40,60dB
Available Values
Accuracy of Attenuation:
0 through 6dB.....±0.3dB maximum
7 through 20dB.....±0.5dB maximum
30dB.....±0.75dB maximum
40dB.....±1.0dB maximum
50 & 60dB.....±1.50dB maximum*
VSWR:
DC to 4GHz.....1.15:1 maximum
4GHz to 8GHz.....1.20:1 maximum
8GHz to 12.4GHz.....1.25:1 maximum
12.4GHz to 18GHz.....1.35:1 maximum*

*18T only

Complete Specification Sheet Available

N Series (50 and 75 Ohms)



50 Ohms
Nickel Plated Brass
Models 9070 (2 Watts)
Frequency Range.....DC to 6GHz
Available Values.....10, 12, 15, 20, 30, and 40 dB
VSWR:
DC to 2GHz.....1.25:1 maximum

Models 2N, 6N, 18N (Stainless Steel)
(2 Watts)
Frequency Range..... DC to 18GHz
Available Values.....0-10, 12, 15, 20, 30, 40, 50 and 60dB
VSWR:
DC to 4GHz.....1.15:1 maximum
4GHz to 8GHz.....1.20:1 maximum
8GHz to 12.4GHz.....1.25:1 maximum
12.4GHz to 18GHz.....1.35:1 maximum

75 Ohms
Model 4N-XX/75 (2 Watts)
Frequency Range.....DC to 4GHz
Available Values.....1, 2, 3, 6, 10, 20 and 30dB
VSWR.....1.30:1 maximum

Complete Specification Sheet Available

BNC Series (50 and 75 Ohms)



50 Ohms
Model 9033 (2 Watts)
Frequency Range..... DC to 4 GHz
Available Values..... 0-10, 12, 15, 20, 30dB
VSWR:
DC to 4GHz.....1.25:1 maximum

Model 9014 (2 Watts)
Frequency RangeDC to 4 GHz
Available Values.....40, 50 & 60 dB
VSWR:
DC to 4 GHz.....1.25:1 maximum

Model 2051 (2 Watts)
Frequency Range.....DC to 12.4 GHz
Available Values.....3, 6, 10, 20 & 30dB
VSWR:
DC to 4GHz.....1.25:1 maximum
4GHz to 8GHz.....1.30:1 maximum
8GHz to 12.4GHz.....1.35:1 maximum

75 Ohms
Model 9033-XX/75 (2 Watts)
Frequency Range..... DC to 4GHz
Available Values..... 0, 3, 6, 10, 20 & 30dB
VSWR:
DC to 1GHz.....1.10:1 maximum
1GHz to 2GHz.....1.20:1 maximum
2GHz to 4GHz.....1.35:1 maximum

Complete Specification Sheet Available

MODEL NO. FREQ. (GHz) CONNECTOR VSWR ATTN (dB)

0.5 Watt, 1 Watt and 2 Watt Attenuators

AS398 (1 Watt)	3	SMA-M/F	1.20:1	1-10,12,15,20,30
AHC	6	SMA-M/F	1.20:1	1-10,12,15,20,30
9026, (Style A)	18	SMA-M/F	1.60:1	0-10,12,15,20,30
9029, (Style AH)	18	SMA-M/F	1.60:1	0-10,12,15,20,30
9023, (Style B)	18	SMA-M/F	1.60:1	0-10,12,15,20,30,40,50,60
2A, 2AH	2.5	SMA-M/F, M/M, F/F	1.15:1	0-10,12,15,20,30,40
2B	2.5	SMA-M/F, M/M, F/F	1.15:1	0-10,12,15,20,30,40,50,60
2C	2.5	SMA-M/F	1.15:1	0-10,12,15,20,30
2DH	2.5	SMA-M/F, M/M, F/F	1.15:1	0-10,12,15,20,30,40
6A, 6AH	6	SMA-M/F, M/M, F/F	1.20:1	0-10,12,15,20,30,40
6B	6	SMA-M/F, M/M, F/F	1.20:1	0-10,12,15,20,30,40,50,60
6C	6	SMA-M/F	1.20:1	0-10,12,15,20,30
6DH	6	SMA-M/F, M/M, F/F	1.20:1	0-10,12,15,20,30,40
18A, 18AH	18	SMA-M/F, M/M, F/F	1.35:1	0-10,12,15,20,30,40
18B	18	SMA-M/F, M/M, F/F	1.35:1	0-10,12,15,20,30,40,50,60
18C	18	SMA-M/F	1.35:1	0-10,12,15,20,30
18DH	18	SMA-M/F, M/M, F/F	1.35:1	0-10,12,15,20,30,40
23A, 23AH	23	SMA-M/F, M/M, F/F	1.40:1	0-10,12,15,20,30,40
23DH	23	SMA-M/F, M/M, F/F	1.35:1	0-10,12,15,20,30
26A, 26AH	26.5	2.9mm-M/F	1.40:1	0,3,6,10,20,30
40A, 40AH (0.5W)	40	2.9mm-M/F	1.40:1	0,3,6,10,20,30
40A2W, 40AH2W	40	2.9mm-M/F	1.40:1	3,6,10,20,30
40EH (0.5W)	40	2.4mm-M/F	1.60:1	0,3,6,10,20,30
50EH (0.5W)	50	2.4mm-M/F	1.75:1	0,3,6,10,20,30
50V	50	1.85mm-M/F	1.75:1	3,6,10

H=with Hex

See pages 2 and 3 and above for more detailed specifications. All models 2 Watt unless indicated

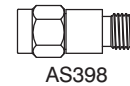

AS398

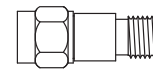

SMA A Series

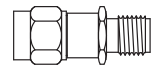

SMA AH Series

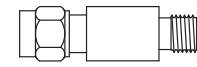

SMA B Series

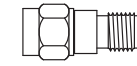

SMA C Series

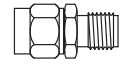

SMA DH Series

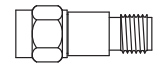

2.9mm 26A, 40A Series

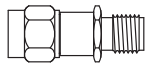

2.9mm 26AH, 40AH Series

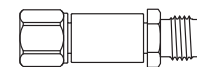

2.4mm EH Series

Attenuator Reference Guide



MODEL NO.	FREQ. (GHz)	CONNECTOR	VSWR	ATTN (dB)
2 Watt Attenuators, N, BNC, SMB, TNC, GPO™, SMP, SMPM				
9070	6	N-M/F	1.25:1	1-10,12,15,20,30,40
2N	2.5	N-M/F, M/M, F/F	1.15:1	0-10,12,15,20,30,40,50,60
6N	6	N-M/F, M/M, F/F	1.20:1	0-10,12,15,20,30,40,50,60
18N	18	N-M/F, M/M, F/F	1.35:1	0-10,12,15,20,30,40,50,60
9033	4	BNC-M/F	1.25:1	0-10,12,15,20,30
9014	4	BNC-M/F	1.25:1	40,50,60
2051	12.4	SMB-M/F	1.35:1	3,6,10,20,30
9056	4	SMB-M/F, M/M, F/F	1.25:1	0-12,15,20,30
9042	2.5	TNC-M/F	1.25:1	0-10,12,15,20,30,40
9036	12.4	TNC-M/F	1.25:1	0-10,12,15,20,30,40
18T	18	TNC-M/F, M/M, F/F	1.35:1	0-10,12,15,20,30,40,50,60
18G	18	GPO-M/F, M/M, F/F	1.35:1	0-10,12,15,20,30
26G	26.5	GPO-M/F, M/M, F/F	1.45:1	3,6,10,20,30
18P	18	SMP-M/F, M/M, F/F	1.35:1	0-10,12,15,20,30
26P	26.5	SMP-M/F, M/M, F/F	1.45:1	3,6,10,20,30
6MP	6	SMPM-M/F, M/M, F/F	1.35:1	0-10,12,15,20,30
18MP	18	SMPM-M/F, M/M, F/F	1.35:1	0-10,12,15,20,30
26MP	26.5	SMPM-M/F, M/M, F/F	1.50:1	3,6,10,20,30

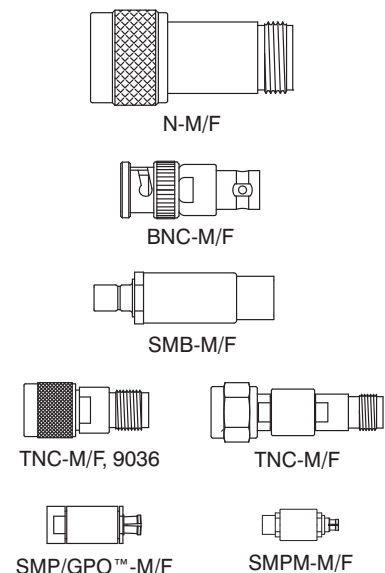

Note: GPO™ and SMP male connectors are available in full and limited detent.

2 Watt 75 Ohm Attenuators

3F	3	F-M/F	1.15:1	3,6,10,15,20,30
9033-XX/75	4	BNC-M/F	1.35:1	0,3,6,10,20,30

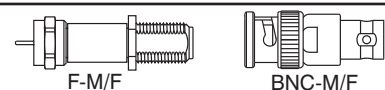

1 Watt Impedance Matching Pads (50 to 75 Ohm)

9033-50/75	1	BNC-M/F	1.20:1	5.7
9033-75/50	1	BNC-M/F	1.20:1	5.7
9070-50/75	3	N-M/F	1.35:1	5.7
9070-75/50	3	N-M/F	1.35:1	5.7
9076-50/75	3	SMA-M/F-F	1.25:1	5.7
9077-50/75	3	N-M/F-F	1.25:1	5.7
9078-50/75	3	BNC-M/F-F	1.25:1	5.7
9079-50/75	3	SMA-F/F-M	1.25:1	5.7
9080-50/75	3	SMA-M/F-M	1.25:1	5.7
9082-50/75	3	N-F/F-M	1.25:1	5.7
9083-50/75	3	N-M/F-M	1.25:1	5.7
9084-50/75	3	TNC-F/F-M	1.25:1	5.7
9085-50/75	3	TNC-M/F-M	1.25:1	5.7
9086-50/75	3	BNC-F/F-M	1.25:1	5.7
9087-50/75	3	BNC-M/F-M	1.25:1	5.7
9088-50/75	3	SMA-F/F-F	1.25:1	5.7
9089-50/75	3	N-F/F-F	1.25:1	5.7
9090-50/75	3	BNC-F/F-F	1.25:1	5.7
9091-50/75	3	TNC-M/F-F	1.25:1	5.7
9092-50/75	3	TNC-F/F-F	1.25:1	5.7

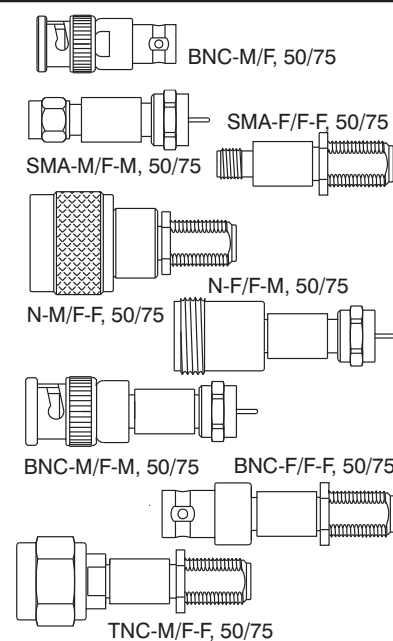

2 Watt DC Bias Passing RF Attenuators

9093-N	0.50-2	N-M/F	1.35:1	4,6,10,15,20,25
9093-SMA	0.50-2	SMA-M/F	1.35:1	4,6,10,15,20,25
9093-TNC	0.50-2	TNC-M/F	1.35:1	4,6,10,15,20,25
9093-F	0.50-2	F-M/F	75Ω	1.45:1 3,4,6,7,8,9,10,11,20
9095-N	0.05-3	N-M/F	1.35:1	3,4,6,10,15,20,25
9095-SMA	0.05-3	SMA-M/F	1.35:1	3,4,6,10,15,20,25
9095-TNC	0.05-3	TNC-M/F	1.35:1	3,4,6,10,15,20,25

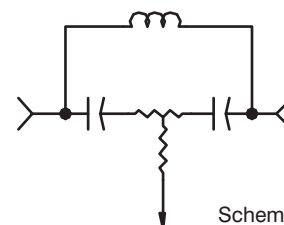

Schematic Diagram

MODEL NO. FREQ. (GHz) CONNECTOR VSWR ATTN (dB)

2 Watt DC Blocking Attenuators (Also See DC Block Section, page 19)

8516S-XX	0.01-2	SMA-M/F	1.15:1	0-10,12,20
----------	--------	---------	--------	------------

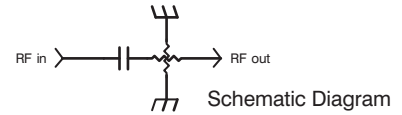

2 Watt Flange Mount Attenuators

2004	18	SMA-M/F	1.35:1	0-10,12,15,20,30
2086K	18	2.9mm-F/PIN 4 hole	1.50:1	0-12
2087K	18	2.9mm-M/PIN 4 hole	1.50:1	0-12

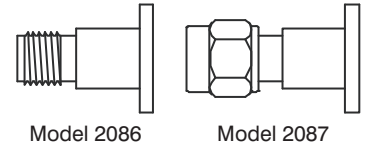

Adapting Attenuators, Between Series

2028	18	N/M-SMA/M	1.30:1	0-10,12,15,20
2029	18	N/M-SMA/F	1.30:1	0-10,12,15,20
2030	18	N/F-SMA/M	1.30:1	0-10,12,15,20
2031	18	N/F-SMA/F	1.30:1	0-10,12,15,20

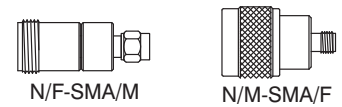

Calibrated Attenuator Sets

9401	18	N		3,6,10,20
9402	12.4	N		3,6,10,20
9403	18	SMA	(A Style)	3,6,10,20
9404	12.4	SMA	(A Style)	3,6,10,20
9405	18	N		1,3,6,10,20,30
9406	12.4	N		1,3,6,10,20,30
9407	18	SMA	(A Style)	1,3,6,10,20,30
9408	12.4	SMA	(A Style)	1,3,6,10,20,30
9477	23	SMA	(AH Style)	1,3,6,10,20,30
9473	23	SMA	(DH Style)	1,3,6,10,20,30
9411	26.5	2.9mm	(A Style)	3,6,10,20
9412	26.5	2.9mm	(A Style)	1,3,6,10,20,30
9413	(0.5W)	40	2.9mm (A Style)	3,6,10,20
9414	(0.5W)	40	2.9mm (A Style)	1,3,6,10,20,30
9415	(0.5W)	40	2.4mm (EH Style)	3,6,10,20
9416	(0.5W)	50	2.4mm (EH Style)	3,6,10,20

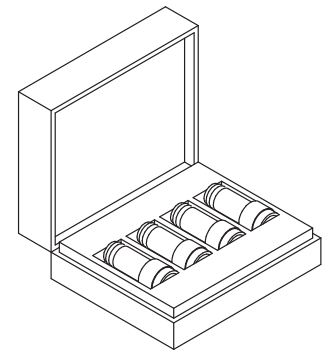

Set 9401

5 Watt Attenuators, Convection Cooled

6B5W	6	SMA-M/F, M/M, F/F	1.20:1	0-12,15,20,30,40
18B5W	18	SMA-M/F, M/M, F/F	1.35:1	0-10,12,15,20,30,40
6N5W	6	N-M/F, M/M, F/F	1.20:1	0-12,15,20,30,40
18N5W	18	N-M/F, M/M, F/F	1.35:1	0-10,12,15,20,30,40
2D5W	2.5	7/16 DIN-M/F, M/M, F/F	1.25:1	0-12,15,20,30,40
7D5W	7.5	7/16 DIN-M/F, M/M, F/F	1.45:1	0-12,15,20,30,40
4BNC5W	4	BNC-M/F, M/M, F/F	1.25:1	0-12,15,20,30,40
6T5W	6	TNC-M/F, M/M, F/F	1.20:1	0-12,15,20,30,40
18T5W	18	TNC-M/F, M/M, F/F	1.35:1	0-10,12,15,20,30,40

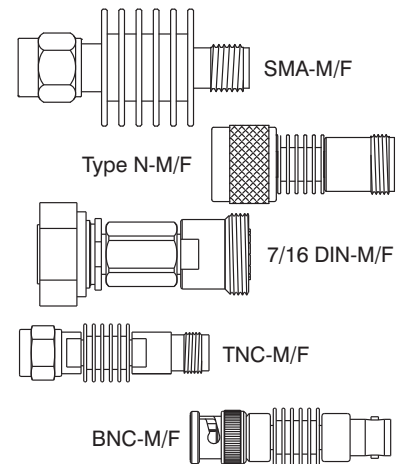

Attenuator Reference Guide



MODEL NO. FREQ. (GHz) CONNECTOR VSWR ATTN (dB)

10 Watt Attenuators, Convection Cooled

6B10W	6	SMA-M/F, M/M, F/F	1.20:1	0-10,12,20,30,40
18B10W	18	SMA-M/F, M/M, F/F	1.40:1	0-10,12,20,30,40
6N10W	6	N-M/F, M/M, F/F	1.20:1	0-10,12,20,30,40
18N10W	18	N-M/F, M/M, F/F	1.40:1	0-10,12,20,30,40
2D10W	2.5	7/16 DIN, M/F, M/M, F/F	1.25:1	0-10,12,20,30,40
7D10W	7.5	7/16 DIN-M/F, M/M, F/F	1.45:1	0-10,12,20,30,40
4BNC10W	4	BNC-M/F, M/M, F/F	1.25:1	0-10,12,15,20,30
6T10W	6	TNC-M/F, M/M, F/F	1.20:1	0-10,12,20,30,40
18T10W	18	TNC-M/F, M/M, F/F	1.40:1	0-10,12,20,30,40

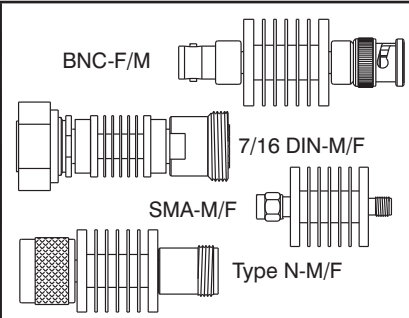

20 Watt Attenuators, Convection Cooled

6B20W	6	SMA-M/F, M/M, F/F	1.20:1	0,3,6,10,20,30,40
18B20W	18	SMA-M/F, M/M, F/F	1.40:1	0,3,6,10,20,30,40
2099 w/mounting holes	18	SMA-M/F, M/M, F/F	1.40:1	0,3,6,10,20,30,40
6N20W	6	N-M/F, M/M, F/F	1.20:1	0,3,6,10,20,30,40
2100 w/mounting holes	18	N-M/F, M/M, F/F	1.40:1	0,3,6,10,20,30,40
18N20W	18	N-M/F, M/M, F/F	1.40:1	0,3,6,10,20,30,40
2D20W	2.5	7/16 DIN-M/F, M/M, F/F	1.25:1	0,3,6,10,20,30,40
7D20W	7.5	7/16 DIN-M/F, M/M, F/F	1.45:1	0,3,6,10,20,30,40
4BNC20W	4	BNC-M/F, M/M, F/F	1.25:1	0,3,6,10,20,30,40
6T20W	6	TNC-M/F, M/M, F/F	1.20:1	0,3,6,10,20,30,40
18T20W	18	TNC-M/F, M/M, F/F	1.40:1	0,3,6,10,20,30,40

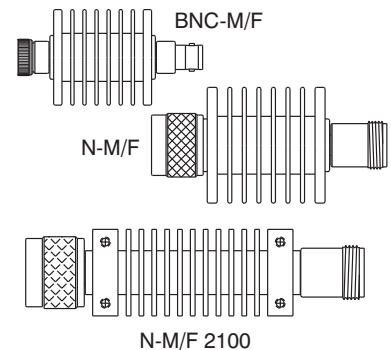

25 Watt Attenuators, Convection Cooled

6B25W	6	SMA-M/F, M/M, F/F	1.20:1	0,3,6,10,20,30,40
18B25W	18	SMA-M/F, M/M, F/F	1.40:1	0,3,6,10,20,30,40
6N25W	6	N-M/F, M/M, F/F	1.20:1	0,3,6,10,20,30,40
18N25W	18	N-M/F, M/M, F/F	1.40:1	0,3,6,10,20,30,40
2D25W	2.5	7/16 DIN-M/F, M/M, F/F	1.25:1	0,3,6,10,20,30,40
7D25W	7.5	7/16 DIN-M/F, M/M, F/F	1.45:1	0,3,6,10,20,30,40
2BNC25W	2.5	BNC-M/F, M/M, F/F	1.25:1	0,3,6,10,20,30,40
4BNC25W	4	BNC-M/F, M/M, F/F	1.25:1	0,3,6,10,20,30,40
6T25W	6	TNC-M/F, M/M, F/F	1.20:1	0,3,6,10,20,30,40
18T25W	18	TNC-M/F, M/M, F/F	1.40:1	0,3,6,10,20,30,40

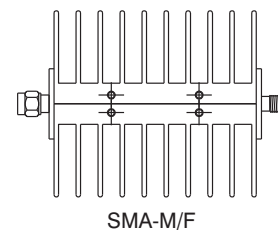

50 Watt Attenuators, Convection Cooled

6B50W	6	SMA-M/F, M/M, F/F	1.25:1	0,3,6,10,20,30,40
18B50W	18	SMA-M/F, M/M, F/F	1.45:1	0,3,6,10,20,30,40
6N50W	6	N-M/F, M/M, F/F	1.25:1	0,3,6,10,20,30,40
18N50W	18	N-M/F, M/M, F/F	1.45:1	0,3,6,10,20,30,40
2D50W	2.5	7/16 DIN-M/F, M/M, F/F	1.25:1	0,3,6,10,20,30,40
7D50W	7.5	7/16 DIN-M/F, M/M, F/F	1.45:1	0,3,6,10,20,30,40
4BNC50W	4	BNC-M/F, M/M, F/F	1.25:1	0,3,6,10,20,30,40
6T50W	6	TNC-M/F, M/M, F/F	1.25:1	0,3,6,10,20,30,40
18T50W	18	TNC-M/F, M/M, F/F	1.45:1	0,3,6,10,20,30,40

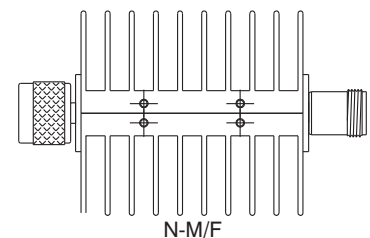

50 Watt Attenuators, Conduction Cooled

2042S	4	SMA-M/F, M/M, F/F	1.25:1	3,6,10,20,30,40
9037	18	SMA-M/F, M/M, F/F	1.45:1	3,6,10,20,30,40
2042	4	N-M/F, M/M, F/F	1.25:1	3,6,10,20,30,40
2042T	4	TNC-M/F, M/M, F/F	1.25:1	3,6,10,20,30,40

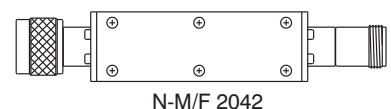

MODEL NO.	FREQ. (GHz)	CONNECTOR	VSWR	ATTN (dB)
100 Watt Attenuators, Convection Cooled				
2B100W	2.5	SMA-M/F, M/M, F/F	1.35:1	3,6,10,20,30,40
6B100W	6	SMA-M/F, M/M, F/F	1.45:1	3,6,10,20,30,40
2N100W	2.5	N-M/F, M/M, F/F	1.35:1	3,6,10,20,30,40
6N100W	6	N-M/F, M/M, F/F	1.45:1	3,6,10,20,30,40
2D100W	2.5	7/16 DIN-M/F, M/M, F/F	1.35:1	3,6,10,20,30,40
6D100W	6	7/16 DIN-M/F, M/M, F/F	1.45:1	3,6,10,20,30,40
2BNC100W	2.5	BNC-M/F, M/M, F/F	1.35:1	3,6,10,20,30,40
4BNC100W	4	BNC-M/F, M/M, F/F	1.45:1	3,6,10,20,30,40
2T100W	2.5	TNC-M/F, M/M, F/F	1.35:1	3,6,10,20,30,40
6T100W	6	TNC-M/F, M/M, F/F	1.45:1	3,6,10,20,30,40

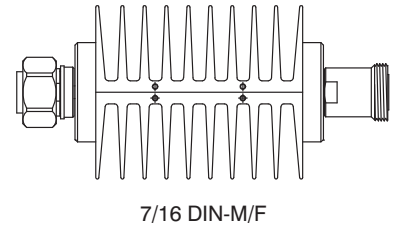

150 Watt Attenuators, Convection Cooled				
2B150W	2.5	SMA-M/F, M/M, F/F	1.25:1	3,6,10,20,30,40
4B150W	4	SMA-M/F, M/M, F/F	1.35:1	3,6,10,20,30,40
2N150W	2.5	N-M/F, M/M, F/F	1.25:1	3,6,10,20,30,40
4N150W	4	N-M/F, M/M, F/F	1.35:1	3,6,10,20,30,40
2D150W	2.5	7/16 DIN-M/F, M/M, F/F	1.30:1	3,6,10,20,30,40
4D150W	4	7/16 DIN-M/F, M/M, F/F	1.40:1	3,6,10,20,30,40
2T150W	2.5	TNC-M/F, M/M, F/F	1.25:1	3,6,10,20,30,40
4T150W	4	TNC-M/F, M/M, F/F	1.35:1	3,6,10,20,30,40

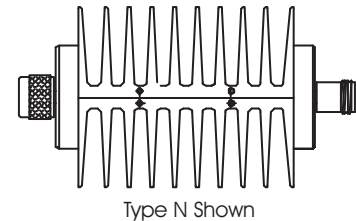

200 Watt Attenuators, Convection Cooled				
2B200W	2.5	SMA-M/F, M/M, F/F	1.25:1	3,6,10,20,30,40
4B200W	4	SMA-M/F, M/M, F/F	1.50:1	3,6,10,20,30,40
2N200W	2.5	N-M/F, M/M, F/F	1.25:1	3,6,10,20,30,40
4N200W	4	N-M/F, M/M, F/F	1.50:1	3,6,10,20,30,40
2D200W	2.5	7/16 DIN-M/F, M/M, F/F	1.25:1	3,6,10,20,30,40
4D200W	4	7/16 DIN-M/F, M/M, F/F	1.50:1	3,6,10,20,30,40
2T200W	2.5	TNC-M/F, M/M, F/F	1.25:1	3,6,10,20,30,40
4T200W	4	TNC-M/F, M/M, F/F	1.50:1	3,6,10,20,30,40

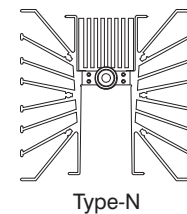

300 Watt Attenuators, Convection Cooled				
2B300W	2.5	SMA-M/F, M/M, F/F	1.25:1	3,6,10,20,30,40
4B300W	4	SMA-M/F, M/M, F/F	1.50:1	3,6,10,20,30,40
2N300W	2.5	N-M/F, M/M, F/F	1.25:1	3,6,10,20,30,40
4N300W	4	N-M/F, M/M, F/F	1.50:1	3,6,10,20,30,40
2D300W	2.5	7/16 DIN-M/F, M/M, F/F	1.25:1	3,6,10,20,30,40
4D300W	4	7/16 DIN-M/F, M/M, F/F	1.50:1	3,6,10,20,30,40
2T300W	2.5	TNC-M/F, M/M, F/F	1.25:1	3,6,10,20,30,40
4T300W	4	TNC-M/F, M/M, F/F	1.50:1	3,6,10,20,30,40

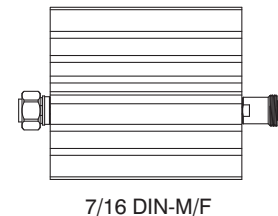

Termination Reference Guide

MODEL NO.	FREQ. (GHz)	CONNECTOR	VSWR
-----------	-------------	-----------	------

1 and 2 Watt Ultra Low Cost Terminations

TS398M	(1W)	6 SMA-M	1.20:1
3202-NM	2.5	N-M	1.10:1
3206-NM	6	N-M	1.10:1
3204A-BNCM	4	BNC-M	1.35:1
3206-TNCM	6	TNC-M	1.30:1

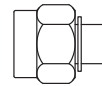

TS398

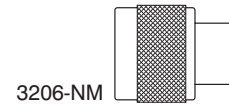

3206-NM

0.5 Watt and 1 Watt Terminations

TS060*	6	SMA-M, SMA-F	1.10:1
3016B*	18	SMA-M	1.20:1
TS180*	18	SMA-M, SMA-F	1.20:1
TS260*	26.5	SMA-M, SMA-F	1.25:1
3206-SMARP	6	SMA-M Reverse Polarity	1.20:1
3201-TNCRP	1	TNC-M, Reverse Polarity	1.25:1
TP180M (1.0W)	18	SMP-M	1.20:1
TMP400 (0.5W)	40	SMPM-F	1.50:1
TMP500 (0.5W)	50	SMPM-F	2.00:1
TG180 (1.0W)	18	GPO-M, GPO-F	1.20:1
TS400* (0.5W)	40	2.9mm-M, 2.9mm-F	1.20:1
TS400H* (0.5W)	40	2.9mm-M, 2.9mm-F	1.20:1
TE400* (0.5W)	40	2.4mm-M, 2.4mm-F	1.40:1
TE500* (0.5W)	50	2.4mm-M, 2.4mm-F	1.60:1

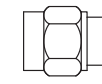

SMA-M

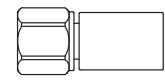

2.4mm-M

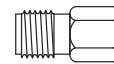

SMA-F

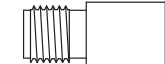

2.9mm-F

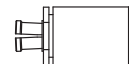

GPO™-F

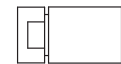

SMP-M

*With chain, add suffix "C" Note: G and P models are full detent, GL and PL models are limited detent Note: GPO™ and SMP male connectors are available in full and limited detent.

2 Watt Terminations

3029*	4	BNC-F	1.15:1
3038*	4	BNC-M	1.20:1
3030*	4	BNC-M	1.15:1
3004-067*	6	SMA-M, SMA-F	1.10:1
3004*	18	SMA-M, SMA-F	1.20:1
3070-067*	6	N-M, N-F	Brass 1.10:1
TN060*	6	N-M, N-F	1.15:1
TN180*	18	N-M, N-F	1.25:1
3018*	18	N-M, N-F	Brass 1.30:1
3070*	18	N-M, N-F	Brass 1.20:1
3101*, 3102*	18	N-M, N-F	1.06:1
TT060*	6	TNC-M, TNC-F	1.15:1
3069*	12.4	TNC-M, TNC-F	Brass 1.15:1
TT180*	18	TNC-M, TNC-F	1.25:1

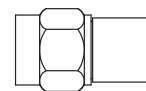

SMA-M

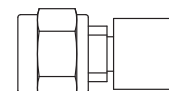

TNC-M

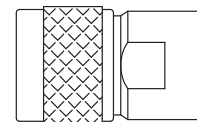

N-M

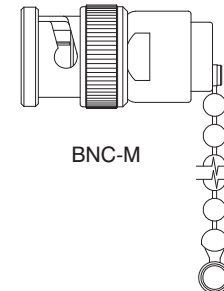

BNC-M

*With chain, add suffix "C"

75 Ohm 1 and 2 Watt Terminations

3038/75 (1W)	1	BNC-M	1.10:1
TF030M	3	F-M	1.20:1
TF030F	3	F-F	1.20:1
TN040/75	4	N-M, N-F	1.25:1

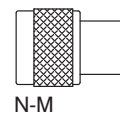

N-M



BNC-M

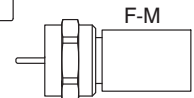

F-M

1 Watt DC Blocking Terminations (Also See DC Block Section, page 19)

8530S	30 kHz-18	SMA-M, SMA-F	INNER
8530N	30 kHz-18	N-M, N-F	INNER
8530PF	30 kHz-23	SMP-F	INNER
8541-MPF	100 kHz-50	SMPM-F	INNER

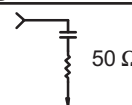

50 Ω

Schematic Diagram

MODEL NO. FREQ. (GHz) CONNECTOR VSWR

2 Watt Terminations, Feedthru

3032	0.5	BNC-M/F	1.25:1
3008, 3008H	1	SMA-M/F	1.25:1

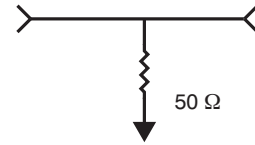
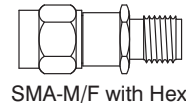

5 Watt Terminations, Convection Cooled

TS060-5W	6	SMA-M, SMA-F	1.15:1
3073	12.4	SMA-M, SMA-F	1.20:1
TS180-5W	18	SMA-M, SMA-F	1.25:1
TN060-5W	6	N-M, N-F	1.25:1
3073N	12.4	N-M, N-F	1.20:1
TN120-5W	12.4	N-M, N-F	1.20:1
TN180-5W	18	N-M, N-F	1.25:1
3018-5W	18	N-M Brass	1.30:1
TD020-5W	2.5	7/16 DIN-M, 7/16 DIN-F	1.25:1
TD075-5W	7.5	7/16 DIN-M, 7/16 DIN-F	1.45:1
3073D	7.5	7/16 DIN-M, 7/16 DIN-F	1.45:1
TT060-5W	6	TNC-M, TNC-F	1.15:1
3073T	12.4	TNC-M, TNC-F	1.20:1
TT180-5W	18	TNC-M, TNC-F	1.25:1

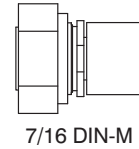
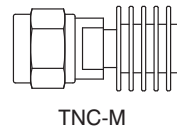
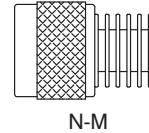
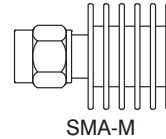

10 Watt Terminations, Convection Cooled

TB040-10W	4	BNC-M, BNC-F	1.25:1
TS060-10W	6	SMA-M, SMA-F	1.20:1
TS180-10W	18	SMA-M, SMA-F	1.40:1
3074	12.4	SMA-M, SMA-F	1.20:1
3093	12.4	N-M, N-F	1.25:1
TN060-10W	6	N-M, N-F	1.25:1
TN180-10W	18	N-M, N-F	1.35:1
TD020-10W	2.5	7/16 DIN-M, 7/16 DIN-F	1.20:1
TD075-10W	7.5	7/16 DIN-M, 7/16 DIN-F	1.30:1
TT060-10W	6	TNC-M, TNC-F	1.20:1
TT180-10W	18	TNC-M, TNC-F	1.40:1

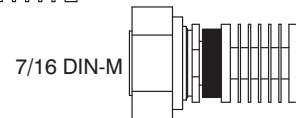
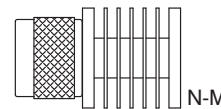
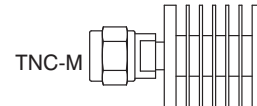
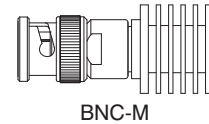
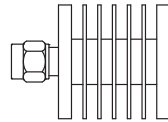

25 Watt Terminations, Convection Cooled

TS060-25W	6	SMA-M, SMA-F	1.20:1
TS180-25W	18	SMA-M, SMA-F	1.40:1
TN060-25W	6	N-M, N-F	1.20:1
TN180-25W	18	N-M, N-F	1.40:1
TD020-25W	2.5	7/16 DIN-M, 7/16 DIN-F	1.20:1
TD075-25W	7.5	7/16 DIN-M, 7/16 DIN-F	1.30:1
3112-XX	18	7/16 DIN, SMA, TNC, N	1.50:1
TT060-25W	6	TNC-M, TNC-F	1.20:1
TT180-25W	18	TNC-M, TNC-F	1.40:1

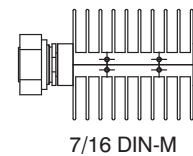
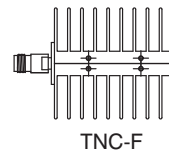
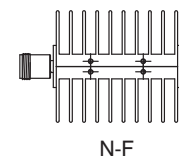
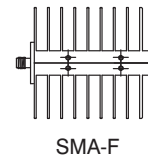

Termination Reference Guide

MODEL NO.	FREQ. (GHz)	CONNECTOR	VSWR
-----------	-------------	-----------	------

40 Watt Termination, Convection Cooled

3114SX	12.4	SMA-M, SMA-F	1.35:1
--------	------	--------------	--------

50 Watt Terminations, Convection Cooled

TS060-50W	6	SMA-M, SMA-F	1.25:1
TS180-50W	18	SMA-M, SMA-F	1.45:1
TN060-50W	6	N-M, N-F	1.25:1
3114NX	12.4	N-M, N-F	1.35:1
TN180-50W	18	N-M, N-F	1.45:1
TB040-50W	4	BNC-M, BNC-F	1.25:1
3114BX	4	BNC-M, BNC-F	1.25:1
TD020-50W	2.5	7/16 DIN-M, 7/16 DIN-F	1.25:1
TD075-50W	7.5	7/16 DIN-M, 7/16 DIN-F	1.45:1
3114DX	7.5	7/16 DIN-M, 7/16-DIN-F	1.25:1
TT060-50W	6	TNC-M, TNC-F	1.25:1
TT180-50W	18	TNC-M, TNC-F	1.45:1
3114TX	12.4	TNC-M, TNC-F	1.35:1

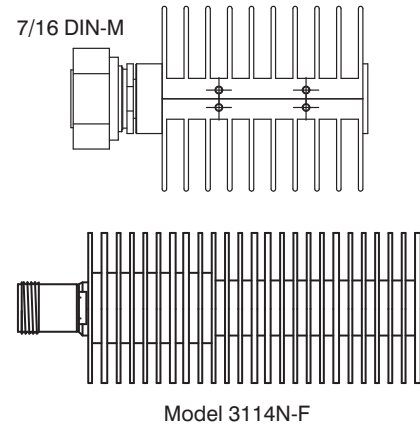

100 Watt Terminations, Convection Cooled

TS020-100W	2.5	SMA-M, SMA-F	1.30:1
TS060-100W	6	SMA-M, SMA-F	1.40:1
TN020-100W	2.5	N-M, N-F	1.30:1
TN060-100W	6	N-M, N-F	1.40:1
TB040-100W	4	BNC-M, BNC-F	1.45:1
TT020-100W	2.5	TNC-M, TNC-F	1.30:1
TT060-100W	6	TNC-M, TNC-F	1.40:1
TD020-100W	2.5	7/16 DIN-M, 7/16 DIN-F	1.35:1
TD060-100W	6	7/16 DIN-M, 7/16 DIN-F	1.45:1

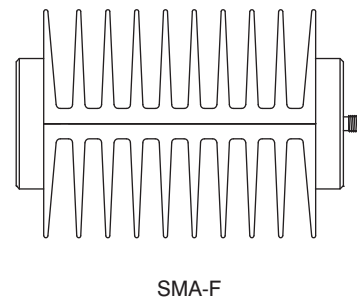

150 Watt Terminations, Convection Cooled

TS020-150W	2.5	SMA-M, SMA-F	1.25:1
TS040-150W	4	SMA-M, SMA-F	1.35:1
TN020-150W	2.5	N-M, N-F	1.25:1
TN040-150W	4	N-M, N-F	1.35:1
TT020-150W	2.5	TNC-M, TNC-F	1.25:1
TT040-150W	4	TNC-M, TNC-F	1.35:1
TD020-150W	2.5	7/16 DIN-M, 7/16 DIN-F	1.30:1
TD040-150W	4	7/16 DIN-M, 7/16 DIN-F	1.40:1

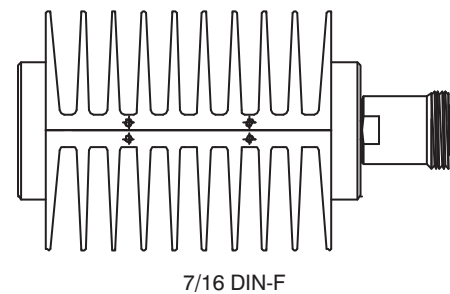

300 Watt Terminations, Convection Cooled

TS020-300W	2.5	SMA-M, SMA-F	1.30:1
TS040-300W	4	SMA-M, SMA-F	1.35:1
TN020-300W	2.5	N-M, N-F	1.30:1
TN040-300W	4	N-M, N-F	1.35:1
TT020-300W	2.5	TNC-M, TNC-F	1.25:1
TT040-300W	4	TNC-M, TNC-F	1.35:1
TD020-300W	2.5	7/16 DIN-M, 7/16 DIN-F	1.35:1
TD040-300W	4	7/16 DIN-M, 7/16 DIN-F	1.35:1

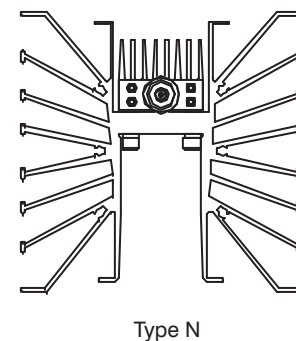

SERIES PCX HIGH POWER COAXIAL TERMINATIONS, DC TO 6 GHz

The PCX Series of High Power Terminations are designed to dissipate RF power when mounted to a heat sink or chill plate. Power levels up to 500 Watts in 50 Ohm impedance are available in units with SMA and Type N male or female connectors. High stability thin film resistive elements on beryllium oxide substrates are used to insure stable VSWR performance over temperature and environmental conditions. Input power ratings are based on case temperature of 85°C maximum.

PERFORMANCE SPECIFICATIONS

Part Number	Input Power (Watts)	Frequency Range	Connector Type	VSWR Typical	Outline
PCX050-F-50 PCX050-M-50	50	DC - 6 GHz	SMA Female SMA Male	DC - 3 GHz: 1.25:1 3 - 6 GHz: 1.35:1	A
PCX050-F-100 PCX050-M-100	100	DC - 3 GHz	SMA Female SMA Male	DC - 3 GHz: 1.25:1	A
PCX050-F-150 PCX050-M-150 PCX100-F-150 PCX100-M-150	150	DC - 2 GHz	SMA Female SMA Male N Female N Male	DC - 1 GHz: 1.15:1 1 - 2 GHz: 1.40:1	B
PCX050-F-250 PCX050-M-250 PCX100-F-250 PCX100-M-250	250	DC - 800 MHz	SMA Female SMA Male N Female N Male	DC - 200 MHz: 1.15:1 200 - 400 MHz: 1.40:1 400 - 800 MHz: 1.30:1	B
PCX100-M-500	500	DC - 200 MHz	N Male	DC - 200 MHz: 1.15:1	B

SMA Connectors are Stainless Steel Passivated per MIL-C-39012, Type N Connectors are Nickel Plated Brass per MIL-C-39012
Housings are Copper; Nickel Plated Brass per MIL QQ-N-290

PHYSICAL DIMENSIONS

OUTLINE A (Shown with SMA)

MODEL	"x"	"y"	"z"
PCX050-F-50	.375 [9.53]	.560 [14.22]	.260 [6.60]
PCX050-M-50	.507 [12.88]	.560 [14.22]	.260 [6.60]
PCX050-F-100	.375 [9.53]	.560 [14.22]	.260 [6.60]
PCX050-M-100	.507 [12.88]	.560 [14.22]	.260 [6.60]

SMA 50 & 100 WATTS

OUTLINE B (Shown with TYPE N)

MODEL	"x"	"y"
PCX050-F-150, 250	.375 [9.53]	.515 [13.08]
PCX050-M-150, 250	.375 [9.53]	.515 [13.08]
PCX100-F-150, 250, 500	.736 [18.69]	.508 [12.9]
PCX100-M-150, 250, 500	.819 [20.8]	.508 [12.9]

SMA OR N CONNECTORS
150, 250 & 500 WATTS

KEY: Inches [Millimeters] .XX ±.03 .XXX ±.010 [X ±0.8 .XX ±0.25]







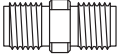

Model	Connector	Frequency	Standard Lengths	Body Style
iCALIBER Test Cables				
ICAL18-SM	SMA-M/M	DC - 18 GHz	2, 3, & 4 feet 1, 1.5 & 2 meters	
ICAL18-NM	N-M/M	DC - 18 GHz	2, 3, & 4 feet 1, 1.5 & 2 meters	
ICAL26-35M	3.5mm-M/M	DC - 26.5 GHz	2, 3, & 4 feet	

Adapter Reference Guide

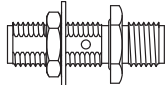
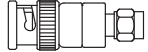
Connector	F	7/16	BNC	N	TNC	7mm	SMA	3.5mm	2.9mm	GPO™/SMP	2.4mm	1.85mm
F	①		①②	①②	②		②					
7/16				③								
BNC	①②											
N	①②	③					③					
TNC	②											
7mm												
SMA	②			③			③					
3.5mm												
2.9mm												
GPO™/SMP												
2.4mm												
1.85mm												

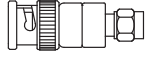
Highlighted squares denote available connector configurations

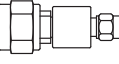

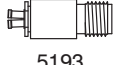
- ① Adapter, 75 Ω both sides (page 16)
- ② Impedance Matching Pad where F connector only is 75 Ω (page 5)
- ③ Also available with Quick Connect Option

CONNECTORS	MODEL NO.	FREQ. (Ghz)	VSWR	DESCRIPTION	
SMA In Series Adapters					
F/F with O-Ring Seal	5211-137	3	1.10:1	Bulkhead Feedthru	
F/F M/M M/F	5010, 5020, 5030	18	1.20:1		
F/F M/M M/F	5043, 5044, 5045	18	1.20:1	Gold Plated	
M/F	5030Q	18	1.25:1	Quick Connect	
F/F	5313	18	1.25:1	Flange Mount, 0.5" Sq	
M/F M/M F/F	5311A, 5312A, 5313A	18	1.20:1	Flange Mount, 0.5" Sq.	
F/F with O-Ring Seal	5211	18	1.15:1	Bulkhead Feedthru	
F/F (Au is Gold Plated)	5205, 5205/Au	18	1.15:1	Bulkhead Feedthru	
F/F M/M M/F	5163, 5164, 5165	26.5	1.20:1		
F/F with O-Ring Seal	5218	26.5	1.30:1	Bulkhead Feedthru	
SMA Between Series Adapters					
SMA-M N-M	5061	6	1.30:1	Ultra Low Cost Brass	
SMA-M N-F	5062	6	1.30:1	Ultra Low Cost Brass	
SMA-F N-M	5063	6	1.30:1	Ultra Low Cost Brass	
SMA-F N-F	5064	6	1.30:1	Ultra Low Cost Brass	
SMA-M N-M	5056	18	1.25:1	Short Profile	
SMA-M N-F	5057	18	1.25:1	Short Profile	
SMA-F N-F	5058	18	1.25:1	Short Profile	
SMA-F N-M	5059	18	1.25:1	Short Profile	
SMA-M N-M	5106	18	1.12:1	Precision	
SMA-M N-F	5107	18	1.12:1	Precision	
SMA-F N-M	5108	18	1.12:1	Precision	
SMA-F N-F	5109	18	1.12:1	Precision	
SMA-M N-F	5057Q	18	1.30:1	Quick Connect	
SMA-M N-M	5306	18	1.12:1	Flange Mount 1" Sq.	
SMA-M N-F	5307	18	1.12:1	Flange Mount 1" Sq.	
SMA-F N-M	5308	18	1.12:1	Flange Mount 1" Sq.	
SMA-F N-F	5309	18	1.12:1	Flange Mount 1" Sq.	
SMA-F N-F	5209	18	1.20:1	Bulkhead Feedthru	
SMA-M N-F	5210	18	1.20:1	Bulkhead Feedthru	
SMA-F N-F w/ O-Ring Seal	5212	18	1.20:1	Bulkhead Feedthru	
SMA-M N-F w/ O-Ring Seal	5213	18	1.20:1	Bulkhead Feedthru	
SMA-M BNC-M	5011	8	1.25:1		
SMA-M BNC-F	5012	8	1.25:1		
SMA-F BNC-M	5013	8	1.25:1		
SMA-F BNC-F	5014	8	1.25:1		
SMA-M TNC-M	5015	18	1.25:1		
SMA-M TNC-F	5016	18	1.25:1		
SMA-F TNC-M	5017	18	1.25:1		
SMA-F TNC-F	5018	18	1.25:1		
SMA-M GPO-M	5190G	18	1.20:1	Full Detent	
SMA-M GPO-M	5190GL	18	1.20:1	Limited Detent	
SMA-F GPO-M	5191G	18	1.20:1	Full Detent	
SMA-F GPO-M	5191GL	18	1.20:1	Limited Detent	
SMA-M GPO-F	5192G	18	1.20:1		
SMA-F GPO-F	5193G	18	1.20:1		
SMA-M SMP-M	5190P	18	1.20:1	Full Detent	
SMA-M SMP-M	5190PL	18	1.20:1	Limited Detent	
SMA-F SMP-M	5191P	18	1.20:1	Full Detent	
SMA-F SMP-M	5191PL	18	1.20:1	Limited Detent	

Adapter Reference Guide

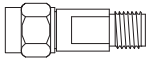
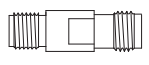
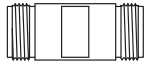
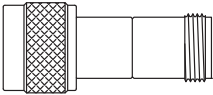
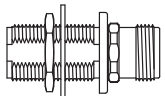
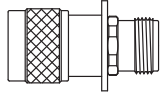
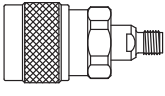
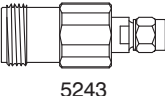
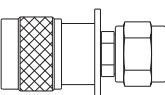
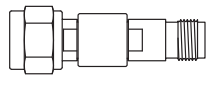

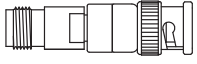
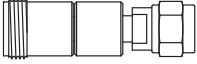
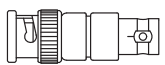
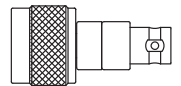
CONNECTORS	MODEL NO.	FREQ. (Ghz)	VSWR	DESCRIPTION	
SMA Between Series Adapters, Continued					
SMA-M SMP-F	5192P	18	1.20:1		
SMA-F SMP-F	5193P	18	1.20:1		
SMA-M 3.5mm-M	5246	18	1.25:1		
SMA-M 3.5mm-F	5247	18	1.25:1		
SMA-F 3.5mm-M	5248	18	1.25:1		
SMA-F 3.5mm-F	5249	18	1.25:1		
SMA-F 1.85mm-M	5250	18	1.30:1		
SMA-M 1.85mm-M	5251	18	1.30:1		
SMA-M 1.85mm-F	5252	18	1.30:1		
SMA-F 1.85mm-F	5253	18	1.30:1		
TYPE N In Series					
F/F M/M M/F	5185, 5188, 5189	6	1.20:1	Ultra Low Cost, Brass	
F/F	5303-067	6	1.07:1	Flange Mount 1" sq.	
M/M	5304-067	6	1.07:1	Flange Mount 1" sq.	
M/F	5305-067	6	1.07:1	Flange Mount 1" sq.	
F/F M/M M/F	5003, 5004, 5005	18	1.25:1		
F/F M/M M/F	5103, 5104, 5105	18	1.12:1	Precision	
F/F	5208	18	1.15:1	Bulkhead Feedthru	
F/F with O-Ring Seal	5215	18	1.15:1	Bulkhead Feedthru	
F/F M/M M/F	5303, 5304, 5305	18	1.12:1	Flange Mount 1" sq.	
TYPE N Between Series					
N-M TNC-M	5326	18	1.12:1	Flange Mount 1" sq.	
N-M TNC-F	5327	18	1.12:1	Flange Mount 1" sq.	
N-F TNC-M	5328	18	1.12:1	Flange Mount 1" sq.	
N-F TNC-F	5329	18	1.12:1	Flange Mount 1" sq.	
N-M BNC-M	5330	8	1.20:1	Flange Mount 1" sq.	
N-M BNC-F	5331	8	1.20:1	Flange Mount 1" sq.	
N-F BNC-M	5332	8	1.20:1	Flange Mount 1" sq.	
N-F BNC-F	5333	8	1.20:1	Flange Mount 1" sq.	
N-F 2.4mm-M	5155	18	1.15:1		
N-F 2.4mm-F	5156	18	1.15:1		
N-M 2.4mm-M	5157	18	1.15:1		
N-M 2.4mm-F	5158	18	1.15:1		
N-M 2.9mm-M	5166	18	1.15:1		
N-F 2.9mm-F	5167	18	1.15:1		
N-M 2.9mm-F	5168	18	1.15:1		
N-F 2.9mm-M	5169	18	1.15:1		
N-M 3.5mm-M	5144	18	1.12:1		
N-M 3.5mm-F	5145	18	1.12:1		
N-F 3.5mm-M	5146	18	1.12:1		
N-F 3.5mm-F	5147	18	1.12:1		
N-M 1.85mm-M	5242	18	1.25:1		
N-F 1.85mm-M	5243	18	1.25:1		
N-M 1.85mm-F	5244	18	1.25:1		
N-F 1.85mm-F	5245	18	1.25:1		
N-F SMA-F	5293	12.4	1.20:1	Bulkhead Feedthru	
N-F SMA-F w/O-Ring	5294	12.4	1.20:1	Bulkhead Feedthru	
N-M SMA-F	5206	18	1.30:1	Bulkhead Feedthru	
N-F SMA-F	5203	18	1.12:1	Bulkhead Feedthru	
N-F SMA-M	5207	18	1.12:1	Bulkhead Feedthru	
N-F SMA-M w/ O-Ring	5216	18	1.12:1	Bulkhead Feedthru	
N-F SMA-F w/ O-Ring	5217	18	1.12:1	Bulkhead Feedthru	
TNC In Series					
F/F M/M M/F	5186, 5187, 5194	6	1.20:1	Ultra Low Cost, Brass	
M/F F/F M/M	5040, 5041, 5042	18	1.20:1		

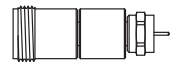
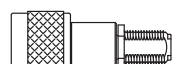
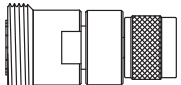
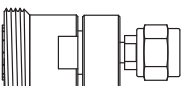
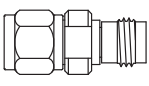
CONNECTORS			MODEL NO.	FREQ.	VSWR	DESCRIPTION		
TNC Between Series				(Ghz)				
TNC-F	SMA-F		5241	18.5	1.30:1	Flange Mount	 <p>5035</p>  <p>5128</p>  <p>5031</p>	
TNC-F	SMA-F		5349	12	1.30:1	Rt. Angle, Flange Mount		
TNC-M	BNC-M		5034	8	1.30:1			
TNC-F	BNC-M		5035	8	1.30:1			
TNC-M	BNC-F		5036	8	1.30:1			
TNC-F	BNC-F		5037	8	1.30:1			
TNC-M	N-F		5026	18	1.25:1			
TNC-F	N-F		5027	18	1.25:1			
TNC-M	N-M		5028	18	1.25:1			
TNC-F	N-M		5029	18	1.25:1			
TNC-M	N-M		5126	18	1.12:1	Precision		
TNC-F	N-M		5127	18	1.12:1	Precision		
TNC-M	N-F		5128	18	1.12:1	Precision		
TNC-F	N-F		5129	18	1.12:1	Precision		
BNC In Series								
M/F	F/F	M/M	5031, 5032, 5033	8	1.25:1		 <p>5022</p>	
M/F	F/F	M/M	5087, 5088, 5089	3	1.30:1	75 Ω		
BNC Between Series								
BNC-M	N-M		5021	8	1.30:1		 <p>5023</p>	
BNC-F	N-M		5022	8	1.30:1			
BNC-M	N-F		5023	8	1.30:1			
BNC-F	N-F		5024	8	1.30:1			
BNC-M	N-M		5130	8	1.15:1	Precision		
BNC-F	N-M		5131	8	1.15:1	Precision		
BNC-M	N-F		5132	8	1.15:1	Precision		
BNC-F	N-F		5133	8	1.15:1	Precision		
TYPE F In Series								
M/F	M/M	F/F	5230, 5231, 5232	3	1.30:1	75 Ω	 <p>5196</p>  <p>5197</p>	
TYPE F Between Series								
F-M	N-M		5195	3	1.30:1	75 Ω Both Sides		
F-M	N-F		5196	3	1.30:1	75 Ω Both Sides		
F-F	N-M		5197	3	1.30:1	75 Ω Both Sides		
F-F	N-F		5198	3	1.30:1	75 Ω Both Sides		
F-M	BNC-M		5070	3	1.30:1	75 Ω Both Sides		
F-M	BNC-F		5071	3	1.30:1	75 Ω Both Sides		
F-F	BNC-M		5072	3	1.30:1	75 Ω Both Sides		
F-F	BNC-F		5073	3	1.30:1	75 Ω Both Sides		
7/16 DIN In Series								
F/F	M/M	M/F	5701, 5702, 5703	7.5	1.35:1			 <p>5705</p>  <p>5709</p>  <p>5150</p>
7/16 DIN Between Series								
7/16 DIN-F	N-F		5704	7.5	1.35:1			
7/16 DIN-F	N-M		5705	7.5	1.35:1			
7/16 DIN-M	N-F		5706	7.5	1.35:1			
7/16 DIN-M	N-M		5707	7.5	1.35:1			
7/16 DIN-M	N-F		5706Q	7.5	1.35:1	Quick Connect		
7/16 DIN-M	N-M		5707Q	7.5	1.35:1	Quick Connect		
7/16 DIN-F	TNC-F		5708	7.5	1.35:1			
7/16 DIN-F	TNC-M		5709	7.5	1.35:1			
7/16 DIN-M	TNC-F		5710	7.5	1.35:1			
7/16 DIN-M	TNC-M		5711	7.5	1.35:1			
1.85mm In Series								
F/F	M/M	M/F	5173, 5174, 5175	65	1.40:1			
M/F			5292	65	1.50:1	Bulkhead Feedthru		
F/F with O-Ring Seal			5289	65	1.40:1	Bulkhead Feedthru		
F/F without O-Ring Seal			5290	65	1.40:1	Bulkhead Feedthru		
2.4mm In Series								
F/F	M/M	M/F	5148, 5149, 5150	50	1.30:1			
F/F with O-Ring Seal			5221	50	1.35:1	Bulkhead Feedthru		

Adapter Reference Guide

CONNECTORS	MODEL NO.	FREQ. (Ghz)	VSWR	DESCRIPTION
2.4mm Between Series				
2.4mm-M SMA-M	5080	26.5	1.20:1	
2.4mm-F SMA-M	5081	26.5	1.20:1	
2.4mm-M SMA-F	5082	26.5	1.20:1	
2.4mm-F SMA-F	5083	26.5	1.20:1	
2.4mm-M 3.5mm-M	5065	34	1.25:1	
2.4mm-M 3.5mm-F	5066	34	1.25:1	
2.4mm-F 3.5mm-M	5067	34	1.25:1	
2.4mm-F 3.5mm-F	5068	34	1.25:1	
2.4mm-F 2.9mm-F	5151	40	1.30:1	
2.4mm-F 2.9mm-M	5152	40	1.30:1	
2.4mm-M 2.9mm-F	5153	40	1.30:1	
2.4mm-M 2.9mm-M	5154	40	1.30:1	
2.4mm-M 1.85mm-M	5075	50	1.35:1	
2.4mm-M 1.85mm-F	5076	50	1.35:1	
2.4mm-F 1.85mm-M	5077	50	1.35:1	
2.4mm-F 1.85mm-F	5078	50	1.35:1	
2.9mm In Series				
F/F M/M M/F	5160, 5161, 5162	26.5	1.15:1	
F/F	5338	26.5	1.25:1	Flange Mount, 0.5" sq.
F/F M/M M/F	5170, 5171, 5172	40	1.30:1	
F/F with O-Ring Seal	5214	40	1.30:1	Bulkhead Feedthru
M/F	5223	40	1.35:1	Bulkhead Feedthru
F/F	5344	40	1.35:1	Flange Mount, 0.5" sq.
2.9mm Between Series				
2.9mm-M SMA-M	5262	26.5	1.25:1	
2.9mm-M SMA-F	5263	26.5	1.25:1	
2.9mm-F SMA-M	5264	26.5	1.25:1	
2.9mm-F SMA-F	5265	26.5	1.25:1	
2.9mm-F 3.5mm-F	5266	34	1.25:1	
2.9mm-F 3.5mm-M	5267	34	1.25:1	
2.9mm-M 3.5mm-F	5268	34	1.25:1	
2.9mm-M 3.5mm-M	5269	34	1.25:1	
2.9mm-M 1.85mm-M	5258	40	1.40:1	
2.9mm-M 1.85mm-F	5259	40	1.40:1	
2.9mm-F 1.85mm-M	5260	40	1.40:1	
2.9mm-F 1.85mm-F	5261	40	1.40:1	
2.9mm-F 2.4mm-F w/ O-Ring	5237	40	1.35:1	Bulkhead Feedthru
3.5mm In Series				
M/F M/M F/F	5084, 5085, 5086	34	1.25:1	
3.5mm Between Series				
3.5mm-F 1.85mm-M	5254	34	1.30:1	
3.5mm-M 1.85mm-F	5255	34	1.30:1	
3.5mm-F 1.85mm-F	5256	34	1.30:1	
3.5mm-M 1.85mm-M	5257	34	1.30:1	
7mm Between Series				
7mm SMA-M	5110	18	1.12:1	
7mm SMA-F	5111	18	1.12:1	
7mm N-M	5112	18	1.12:1	
7mm N-F	5113	18	1.12:1	
7mm TNC-M	5114	18	1.12:1	
7mm TNC-F	5115	18	1.12:1	
7mm 3.5mm-M	5140	18	1.08:1	
7mm 3.5mm-F	5141	18	1.08:1	
7mm 2.4mm-M	5181	18	1.10:1	
7mm 2.4mm-F	5182	18	1.10:1	
7mm 2.9mm-M	5183	18	1.10:1	
7mm 2.9mm-F	5184	18	1.10:1	
7mm SMA-M	5314	18	1.12:1	Flange Mount 1" sq.
7mm SMA-F	5315	18	1.12:1	Flange Mount 1" sq.

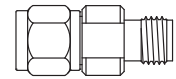

5153

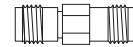

5078

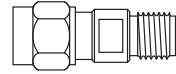

5162

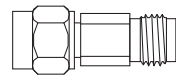

5255

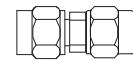

5257

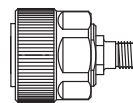

5111

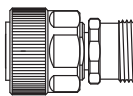

5113

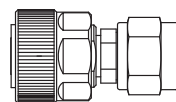

5114

Inmet inner DC blocks have a capacitor in-series with the center conductor which prevents the flow of audio and direct current (DC) frequencies while offering minimum interference to RF signals up to 50GHz. Similarly outer DC blocks have a capacitor in-series with the outer conductor and the inner/outer types have capacitors in-series with both inner and outer conductors.

Insulation material on the outer DC blocks is a PEEK shell. Applications include ground loop elimination, signal source modulation leakage suppression, system signal-to-noise ratio improvement, test setup isolation and other situations where undesired DC or audio current flows in the system.

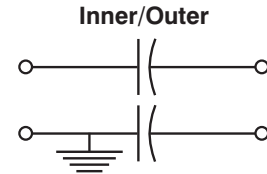
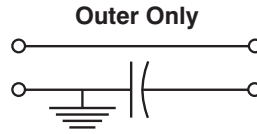
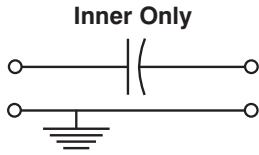

MODEL NO.	FREQ. (GHz)	CONNECTOR	VOLTAGE	BLOCK TYPE
-----------	-------------	-----------	---------	------------

DC Blocks, SMA

8037	0.01-18	SMA-M/F	200	INNER
8038	0.01-18	SMA-M/F	200	OUTER
8039	0.01-18	SMA-M/F	200	INNER-OUTER

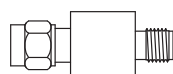

Models 8038 and 8039

DC Blocks, SMA Microminiature

8055	0.01-18	SMA-M/F	200	INNER
8055H	0.01-18	SMA-M/F	200	INNER



Model 8055 with Hex

DC Blocks

8046	0.01-18	N-M/F	200	INNER
8047	0.01-18	N-M/F	200	OUTER
8048	0.01-18	N-M/F	200	INNER/OUTER
8080	0.01-4	BNC-M/F	200	INNER
8081	0.01-4	BNC-M/F	200	OUTER
8082	0.01-4	BNC-M/F	200	INNER/OUTER
8070	0.01-18	TNC-M/F	200	INNER
8071	0.01-18	TNC-M/F	200	OUTER
8072	0.01-18	TNC-M/F	200	INNER/OUTER
8060A	7kHz-26.5	2.9mm-M/F	75	INNER
8063A	7kHz-26.5	2.9mm-F/F	75	INNER
8066A	7kHz-26.5	2.9mm-M/M	75	INNER
8061	0.01-26.5	2.9mm-M/F	200	OUTER
8062A	0.01-26.5	2.9mm-M/F	200	INNER/OUTER
8141A	0.01-40	2.9mm-M/F	200	INNER
8142	0.01-40	2.9mm-M/F	200	OUTER
8143A	0.01-40	2.9mm-M/F	200	INNER/OUTER
8144A	0.01-40	2.9mm-F/F	200	INNER
8145	0.01-40	2.9mm-F/F	200	OUTER
8146A	0.01-40	2.9mm-F/F	200	INNER/OUTER
8177	0.01-50	2.4mm-M/F	75	INNER
8178	0.01-50	2.4mm-M/F	75	OUTER
8179	0.01-50	2.4mm-M/F	75	INNER/OUTER
8100	0.30-2.5	7/16-M/F	100	INNER

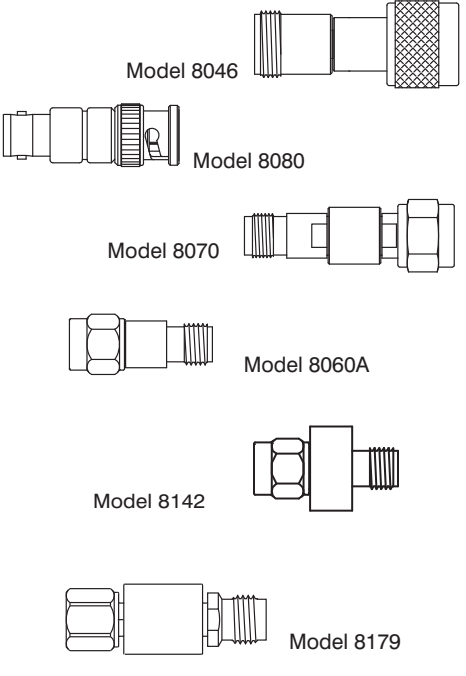

Model 8046 Model 8080 Model 8070 Model 8060A Model 8142 Model 8179

DC Blocks, High Voltage

8529A, AH	0.1-4	SMA-M/F	900	INNER
8532-SI-HV	0.1-18	SMA-M/F	950	INNER
8532-NI-HV	0.1-18	N-M/F	950	INNER
8532-TI-HV	0.1-18	TNC-M/F	950	INNER
8550	0.8-2.8	7/16-M/F	3000	INNER

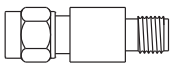

Model 8532-SI-HV

DC Block Reference Guide



MODEL NO. FREQ. (GHz) CONNECTOR VOLTAGE BLOCK TYPE

DC Blocks, Broadband

8535	7 kHz-23	SMA-M/F	100	INNER
8535G, 8535GL	7 kHz-26.5	GPO-M/F	50	INNER
8535P, 8535PL	16kHz-26.5	SMP-M/F	50	INNER
8535K, 8535KH	7 kHz-40	2.9mm-M/F	35	INNER
8535E	7 kHz-50	2.4mm-M/F	35	INNER
8535MP	16kHz-50	SMPM-M/F	10	INNER

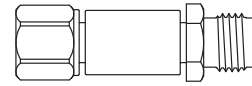

Model 8535E

Note: GPO™ and SMP male connectors are available in full and limited detent.

75 Ohm DC Blocks, In Series

8174	0.01-2	F-M/F	200	INNER
8175	0.01-2	F-M/F	200	OUTER
8176	0.01-2	F-M/F	200	INNER-OUTER
8184	0.1-4	N-M/F	200	INNER
8185	0.1-4	N-M/F	200	OUTER
8186	0.1-4	N-M/F	200	INNER/OUTER
8181	0.1-4	BNC-M/F	200	INNER
8182	0.1-4	BNC-M/F	200	OUTER
8183	0.1-4	BNC-M/F	200	INNER/OUTER

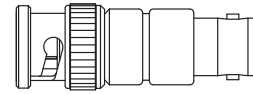

Model 8181



Model 8174

DC Blocks, Between Series

8313	0.01-4	BNC-M/SMA-F	100	INNER
8301	0.01-18	N-M/SMA-M	200	INNER
8302	0.01-18	N-M/SMA-F	200	INNER
8303	0.01-18	N-F/SMA-M	200	INNER
8304	0.01-18	N-F/SMA-F	200	INNER
8306	0.01-40	2.4mm-M/2.9mm-F	200	INNER
8309	0.01-40	2.4mm-F/2.9mm-M	200	INNER
8180	0.01-40	2.4mm-F/2.9mm-F	200	INNER

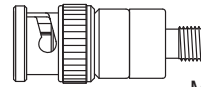

Model 8313

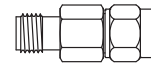

Model 8306

MODEL NO. FREQ. (GHz) CONNECTOR VSWR ATTN (dB)

2 Watt DC Blocking Attenuators (Also See Attenuator Section, page 6)

8516S-XX	0.01-2	SMA-M/F	1.15:1	0-10,12,20
----------	--------	---------	--------	------------

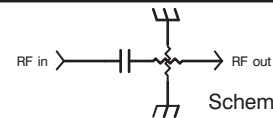

Schematic Diagram

1 Watt DC Blocking Terminations (Also see Termination Section, Page 9)

8530S	30 kHz-18	SMA-M, SMA-F	100	INNER
8530N	30 kHz-18	N-M, N-F	100	INNER
8530PF	30 kHz-23	SMP-F	100	INNER
8541-MPF	100 kHz-50	SMPM-F	10	INNER

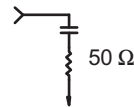

Schematic Diagram

DC Blocking Connectors (Accepts *0.009 and 0.012" Dia. Pins)

8537KF	20 kHz-45	2.9mm-F	25	INNER
8537KM	20 kHz-45	2.9mm-M	25	INNER
8537VF*	25 kHz-50	1.85mm-F	25	INNER
8537VM*	25 kHz-50	1.85mm-M	25	INNER

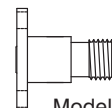

Model 8537KF

MODEL NO. FREQ. (GHz) CONN. CURRENT (Max.) VOLTAGE (Max.)

General Purpose and High Power Bias Tees

8800SMF1-02	.01-2.5	SMA-M/F	2.5A	100V
8800SMF1-04	.01-4	SMA-M/F	2.5A	100V
8800SMF1-06	.01-6	SMA-M/F	2.5A	100V
8800SMF1-09	.01-9	SMA-M/F	2.5A	100V
8800SMF1-12	.01-12.4	SMA-M/F	2.5A	100V
8800NMF1-02	.01-2.5	N-M/F	2.5A	100V
8800NMF1-04	.01-4	N-M/F	2.5A	100V
8800NMF1-06	.01-6	N-M/F	2.5A	100V
8800NMF1-09	.01-9	N-M/F	2.5A	100V
8800NMF1-12	.01-12.4	N-M/F	2.5A	100V
8800DMF1-02	.01-2.5	7/16-M/F	2.5A	100V
8800DMF1-04	.01-4	7/16 DIN-M/F	2.5A	100V
8800DMF1-06	.01-6	7/16-M/F	2.5A	100V
8800DMF1-07	.01-7.5	7/16-M/F	2.5A	100V

High Current Bias Tees

8820SMF1-02	.5-2.5	SMA-M/F	7.0A	100V
8820SMF1-06	1.0-6.0	SMA-M/F	7.0A	100V
8820NMF1-02	.5-2.5	N-M/F	7.0A	100V
8820DMF1-02	.5-2.5	7/16-DIN-M/F	7.0A	100V
8821DMF1-02*	.5-2.5	7/16-DIN-M/F	7.0A	100V

Pulsed Bias Tees

8860SMF2-02	.03-2.5	SMA-M/F	3.0A	100V
8860SMF2-06	.03-6	SMA-M/F	3.0A	100V
8860SMF2-09	.03-9	SMA-M/F	3.0A	100V
8860SMF2-12	.03-12	SMA-M/F	3.0A	100V

75 Ohm Bias Tees

8875NMF1-03	.01-3	N-M/F	2.5A	100V
8875FMF1-03	.01-3	F-M/F	2.5A	100V

Broadband Bias Tees

8810SMF2-12	50 kHz-12.4	SMA-M/F	750mA	25V
8810SMF2-18	50 kHz-18	SMA-M/F	750mA	25V
8810SMF2-26	50 kHz-26.5	SMA-M/F	750mA	25V
8810KMF2-26	50 kHz-26.5	2.9mm-M/F	750mA	25V
8810KMF2-40	50 kHz-40	2.9mm-M/F	150mA	25V
8812KMF2-26	12 kHz-26.5	2.9mm-M/F	150mA	16V
8812KMF2-40	12 kHz-40	2.9mm-M/F	150mA	16V
8810EMF2-50	50 kHz-50	2.4mm-M/F	150mA	25V

*Environmentally Sealed

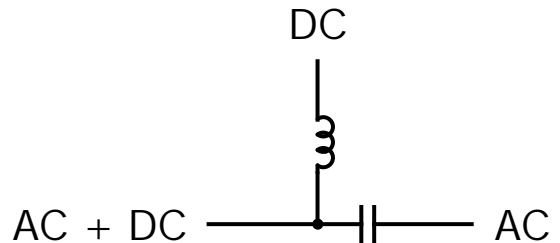
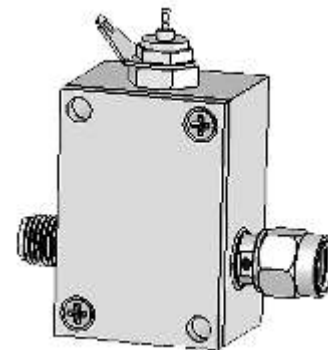
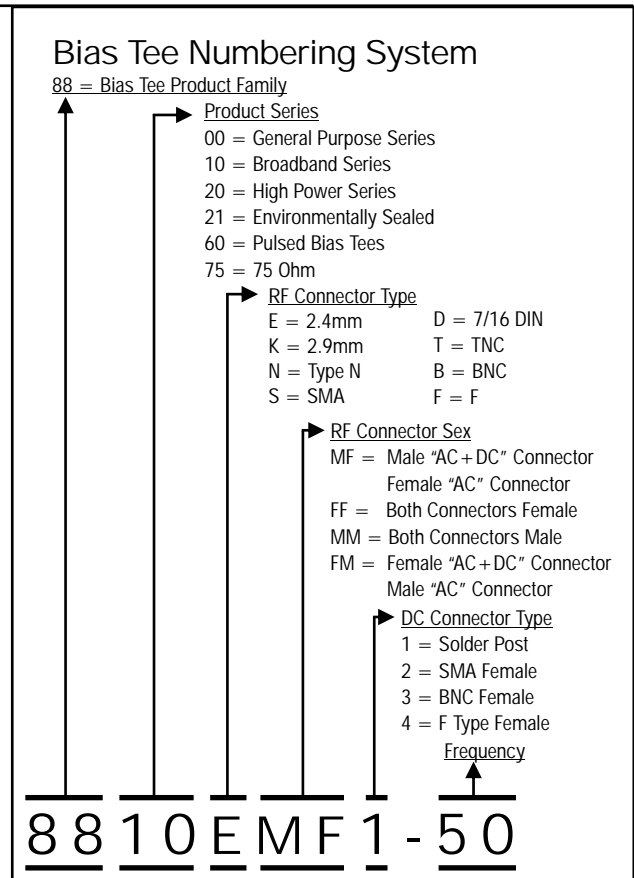

Equalizer Overview



Aeroflex / Inmet Gain Equalizers offer simple solutions to your system slope problems. Negative, Positive, Parabolic or Fine Grain Ripple slope units can be built to meet your desired performance parameters in the DC-40 GHz frequency range. Features include:

- DC to 40 GHz, high performance
- Broadband or narrowband frequency performance
- Fine grain tuning capability
- Standard connectors: SMA, 2.9mm, N, TNC, SMP, 2.4mm
- Meets MIL-SPEC environmental requirements
- Tubular and rectangular available depending on slope and frequency requirements.

Gain equalizers are passive microwave components that have an insertion loss characteristic that varies as a function of frequency. Aeroflex / Inmet can supply both standard and custom-designed equalizers to meet the needs of commercial and military customers alike. Aeroflex / Inmet has the engineering staff devoted exclusively to this product line and can supply designs that precisely define a preset loss characteristic (fixed equalizers) or with the ability to be loss-adjusted to custom-fit the particular variable requirements needed to field-tune a system. Each equalizer application has an insertion loss characteristic and package configuration that is unique. Equalizers can be custom made to meet the desired performance parameters and package configurations for each application.

NEGATIVE SLOPE equalizers are typically used for applications to offset the excessive loss of long cable runs at high frequencies. The loss characteristic of the equalizer decreases linearly with frequency.

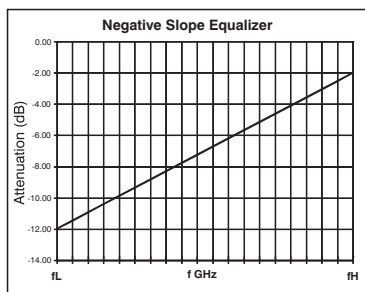

POSITIVE SLOPE equalizers are typically used for applications to offset excessive loss of low frequencies where waveguide transmission characteristics require an equalizer that has increasing attenuation with frequency.

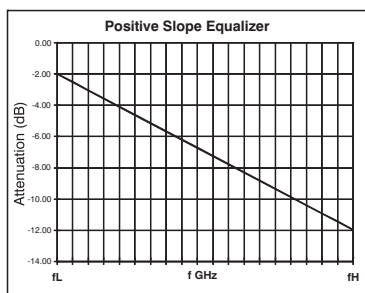

PARABOLIC equalizers are used in applications where a broadband traveling wave tube (TWT) or solid state amplifier (SSA) has maximum gain at or near the center of the frequency band. The characteristics of the equalizer require maximum attenuation at mid-band and decreasing attenuation at band edges. Conversely, an inverted parabolic equalizer has decreased attenuation at mid-band and increasing attenuation at band edges.

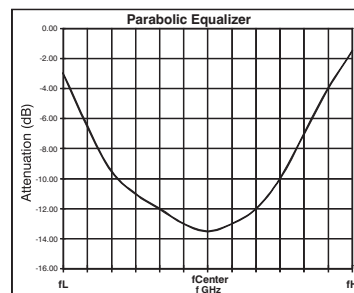

RIPPLE equalizers are used to flatten, gain ripple and spikes in a broadband application. The narrow band attenuation is adjustable in the bands where the ripple or spikes occur and flatten the response in these sub bands.

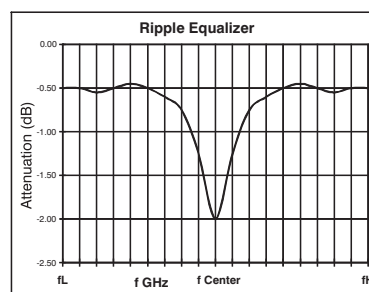

Standard Model Gain Equalizers

MODEL NO.	FREQ. (GHz)	Slope	Connectors
-----------	-------------	-------	------------

Equalizers (A Selection of Standard Models)

EQ1251	2-18 GHz	Negative Slope	SMA/TNC/Type N
EQ2301	.5-18 GHz	Negative Slope	SMA/TNC/Type N
EQ2400	6-18 GHz	Negative Slope	SMA/TNC/Type N
EQ2401	8-18 GHz	Negative Slope	SMA/TNC/Type N
EQ2402	2-18 GHz	Positive Slope	SMA/TNC/Type N

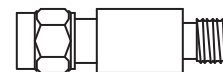

EQ1251-SMA Shown

Wilkinson Power Dividers

Model	Connector	Frequency	Insertion Loss Max.	Phase Balance Max.	Isolation Min.
PD0001-S2	SMA	0.5 - 1.0 GHz	0.25 dB	2°	22 dB
PD0102-S2	SMA	1.0 - 2.0 GHz	0.25 dB	3°	22 dB
PD0002-S2	SMA	0.8 - 2.5 GHz	0.40 dB	3°	20 dB
PD0204-S2	SMA	2.0 - 4.0 GHz	0.30 dB	4°	20 dB
PD0004-S2	SMA	0.5 - 4.0 GHz	0.50 dB	4°	20 dB
PD0408-S2	SMA	4.0 - 8.0 GHz	0.35 dB	4°	20 dB
PD0208-S2	SMA	2.0 - 8.0 GHz	0.40 dB	4°	20 dB
PD0818-S2	SMA	8.0 - 18.0 GHz	0.60 dB	5°	20 dB
PD0218-S2	SMA	2.0 - 18.0 GHz	1.00 dB	5°	17 dB
PD0001-S4	SMA	0.5 - 1.0 GHz	0.40 dB	4°	20 dB
PD0102-S4	SMA	1.0 - 2.0 GHz	0.60 dB	4°	20 dB
PD0002-S4	SMA	0.8 - 2.5 GHz	0.70 dB	4°	20 dB
PD0204-S4	SMA	2.0 - 4.0 GHz	0.60 dB	6°	18 dB
PD0208-S4	SMA	2.0 - 8.0 GHz	1.00 dB	4°	18 dB
PD0218-S4	SMA	2.0 - 18.0 GHz	1.50 dB	6°	15 dB

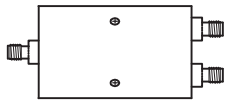

Model PD0001-S2

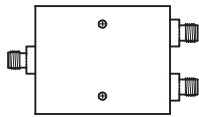

Model PD0102-S2

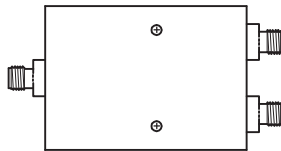

Model PD0002-S2

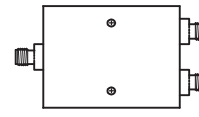

Model PD0204-S2

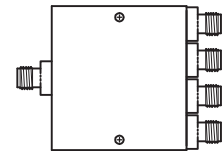

Model PD0102-S4

Wilkinson Power Dividers, GPS 2-Way, Type N

Model	Connector	Frequency	DC Power	DC Resistance (Input to Output)	Isolation Min.
PD1516-N2	Type N	1.5 - 1.6 GHz	12V 2 Amp Max.	0.1 Ohm Max.	22 dB

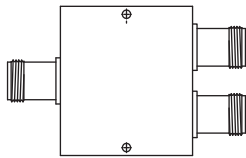

Model PD1516-N2

Resistive Power Dividers

Model	Connector	Frequency	Insertion Loss Max.	Phase Balance Max.	Amplitude Balance Max.
6007-02	Type N	12.4 GHz	6.0dB	±2°	0.4 dB
6007	Type N	18.0 GHz	7.5dB	±3°	0.5 dB
6011-02	Type N	12.4 GHz	6.0dB	±2°	0.4 dB
6011	Type N	18.0 GHz	7.5 dB	±3°	0.5 dB
6019-02	TNC	12.4 GHz	6.0dB	±2°	0.4 dB
6019	TNC	18.0 GHz	7.5 dB	±3°	0.5 dB
6014-03	SMA	6.0 GHz	6.0dB	±2°	0.4 dB
6014F-03	SMA	6.0 GHz	6.0dB	±2°	0.4 dB
6014-01	SMA	12.4 GHz	6.0dB	±2°	0.4 dB
6014F-01	SMA	12.4 GHz	6.0dB	±2°	0.4 dB
6014-02	SMA	18.0 GHz	7.5 dB	±3°	0.5 dB
6014F-02	SMA	18.0 GHz	7.5 dB	±3°	0.5 dB
6005-01	2.9mm	12.4 GHz	6.0dB	±2°	0.4 dB
6005F-01	2.9mm	12.4 GHz	6.0dB	±2°	0.4 dB
6005-02	2.9mm	18.0 GHz	7.5dB	±3°	0.5 dB
6005F-02	2.9mm	18.0 GHz	7.5dB	±3°	0.5 dB
6005-03	2.9mm	26.5 GHz	8.5dB	±4°	1.0 dB

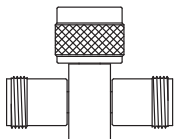

Model 6007

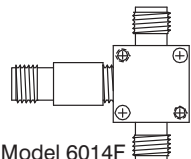

Model 6014F

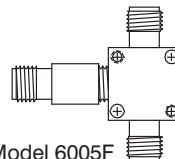

Model 6005F

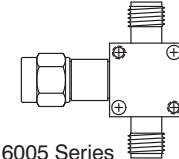

6005 Series

Directional Couplers

MODEL NO.	FREQ. (MHz)	CONNECTOR	Coupling (dB)
6910S	1850-1910	SMA-RT Angle	10
6911S	1850-1910	SMA	10
6910Q	1850-1910	QMA	10
6912S	824-849	SMA	10
6912Q	824-849	QMA	10
6913S	824-849	SMA-RT Angle	10

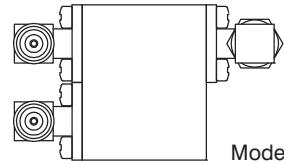

Model 6910S

Open Circuits (also available with chain, add suffix "C")

MODEL NO.	FREQ. (GHz)	CONNECTOR	
7004	18	N-M	
7005	18	N-F	
7006	18	SMA-M	
7007	18	SMA-F	
7013	7.5	7/16 DIN-F	
7014	7.5	7/16 DIN-M	
7015	3	F-M	75 Ohm
7016	3	F-F	75 Ohm

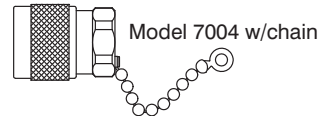

Model 7004 w/chain

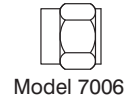

Model 7006

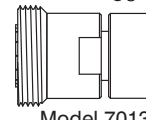

Model 7013

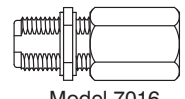

Model 7016

Short Circuits (also available with chain, add suffix "C")

7001	18	N-M	
7002	18	N-F	
7008	18	SMA-M	
7009	18	SMA-F	
7011	7.5	7/16 DIN-F	
7012	7.5	7/16 DIN-M	
7017	3	F-M	75 Ohm
7018	3	F-F	75 Ohm



Model 7002



Model 7009

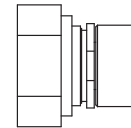

Model 7012

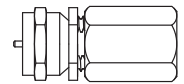

Model 7017

Zero Bias Schottky Detectors

MODEL NO.	FREQ. (GHz)	CONNECTOR	Flatness
4802S	2	SMA-M/F	+/- 0.2 dB TYP.
4804S	4	SMA-M/F	+/- 0.2 dB TYP.

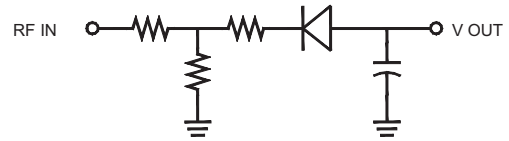

Dust and Moisture Sealing Caps (also available with chain, add suffix "C")

MODEL NO.	CONNECTOR
7602	TNC-M
7603	SMA-M
7604, 7605	N-M, N-F
7606	2.4mm-M
7607	SMP-F

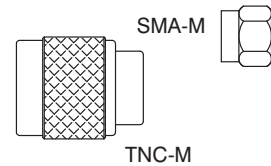

TNC-M

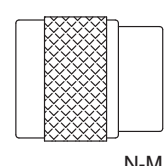

N-M

How to Order

When ordering, state the model number, description of the component and the frequency range as given in the catalog.

You may place your order with the factory, Richardson RFPD, RFMW, or the Aeroflex / Inmet Sales Representative in your area. Factory orders will be accepted by mail, telephone or other electronic communications pending confirmation on your standard purchase order form. Minimum factory order is \$250.00 and subject to change. Quantity minimums may apply for non-standard or special order products.

Address all orders and communications to:
AEROFLEX / INMET INC.
300 Dino Drive
Ann Arbor, MI 48103 USA

Tel.: 888-244-6638 or 734-426-5553
Fax: 734-426-5557
E-mail: inmetsales@aeroflex.com
Web: www.aeroflex.com/inmet
CAGE Code: 64671

Payment Terms

Terms are net 30 days for customers with established credit. All other orders must be prepaid, paid by credit card (VISA, MasterCard and American Express) or C.O.D.

Shipping

All sales are F.O.B. Ann Arbor, Michigan. Unless specified in your order, orders will be shipped "best way" at the company's discretion. Aeroflex / Inmet can only guarantee shipping date. Factory does not assume responsibility for carrier delays and cannot be held responsible for late, lost or damaged shipments. All claims must be filed with the carrier.

Certificate of Compliance

A Certificate of Compliance is shipped with every order. It is located on the reverse side of the packing slip.

Warranty

Aeroflex / Inmet Corporation warrants each product it manufactures to be free from defects in material and workmanship under normal use and service. Aeroflex / Inmet's only obligation under this warranty is to repair or replace, at its factory, any product or part thereof that is returned, with transportation charges prepaid, by the original purchaser within ONE YEAR from the date of shipment.

The foregoing warranty does not apply to, and in Aeroflex / Inmet's sole opinion, products that have been subject to improper or inadequate maintenance, unauthorized modifications, misuse, or operation outside the published specifications for the product.

The warranty stated above is the sole and exclusive warranty and is in lieu of all other warranties, expressed or implied, including, but not limited to, any implied warranty or fitness for any particular purpose. Aeroflex / Inmet shall not be liable for any direct or consequential injury, loss or damage incurred through the use, or inability to use any Aeroflex / Inmet product.

Returns

When returning a component to our factory, a Return Material Authorization (RMA) number must be obtained from Aeroflex / Inmet. When contacting us for an RMA number, please indicate the model number, date of the original purchase, the product lot number and the original invoice number for the purchase. Please also include as much information as possible, including test data, pertaining to the nature of the malfunction or reason for the return and point of contact information for your company.

Cancellations

Orders placed with Inmet may be cancelled only after authorization from Aeroflex / Inmet. Any authorized cancellation is subject to cancellation charges as determined by Aeroflex / Inmet. A component returned for credit will be subject to a restocking charge. If more than 6 months has elapsed since original purchase, the item may not be accepted for credit. Nonstandard components as determined by Aeroflex / Inmet, cannot be returned for credit.

Product Changes

Although all information in this catalog is current at the time of release, Aeroflex / Inmet continuing Product Improvement Program makes it necessary for Aeroflex / Inmet to reserve the right to change specifications without notice.

Quality Assurance

Aeroflex / Inmet's goal is to achieve complete customer satisfaction in the design, quality, delivery, pricing and support of our products. We continue to develop and improve our management systems and manufacturing processes in order to meet this goal.

Aeroflex / Inmet's Quality Assurance system is registered to ISO-9001. Our calibration program for inspection and test equipment complies with the requirements of MIL-STD 45662 and ANSI/NC SLZ540-1.



Certificate No. US-1943



rfd@rell.com
or call 800-737-6937
(U. S. & Canada)



www.rfmw.com
or call 877-367-7369



AEROFLEX

300 Dino Drive
Ann Arbor, MI 48103-9457
www.aeroflex.com/inmet
1-888-244-6638 or 734-426-5553



Our passion for performance is defined by three attributes represented by the icons pictured above: solution-minded, performance-driven and customer-focused.