

Battenfeld® Technologies, Inc.

www.battenfeldtechnologies.com

TWENTY ELEVEN 2011 CATALOG

Caldwell®
Shooting Supplies

Fajen®
*The First Name
in Gunstocks...*

Adams & Bennett™
• Replacement Rifle Barrels •

Frankford Arsenal 
Reloading Tools

LOCKDOWN!™
VAULT ACCESSORIES

Miles Gilbert™
Fine Stockmaking Supplies

PAST 
Recoil Protection

Tipton®
Gun Cleaning Supplies

Wheeler®
Engineering
Fine Gunsmithing Supplies

CATALOG #549922

Specifications and availability are subject to change.

Battenfeld Technologies, Inc. is not responsible for typographic, photographic or descriptive errors.

RUGER®, 10/22® and 10/22 Magnum® are registered trademarks of Sturm, Ruger & Company, Inc.

REMINGTON® and 700® are registered trademarks of Remington Arms Co., Inc.

Battenfeld Technologies, Inc. and its products are not in any way affiliated with, approved by, or sponsored by any of the above mentioned registered trademark companies.

BATTENFELD, ADAMS & BENNETT, CALDWELL, TIPTON, PAST, FAJEN, WHEELER ENGINEERING, FRANKFORD ARSENAL, THE LEAD SLED, E-MAX, TACK DRIVER, DEADSHOT, NXT, FIRE CONTROL, ZEROMAX, STABLE TABLE, BR PIVOT ORANGE PEEL, LEGACY SERIES, GUN BUTLER and F.A.T. WRENCH are registered trademarks of Battenfeld Technologies, Inc.

Other trademarks shown in this catalog are owned by Battenfeld Technologies, Inc. unless otherwise noted.

2

TABLE OF CONTENTS

Caldwell Shooting Supplies	4 - 33
Shooting Rests	4 - 14, 18-19
Shooting Bags	11, 15, 16 - 17
Bipods & Shooting Sticks	20 - 21
Shooting Benches	22 - 23
Targets	24 - 31
Hearing Protection	32 - 33
Shooting Accessories	15
Fajen Stocks	34 - 35
Adams & Bennett Replacement Rifle Barrels	36
Fajen + Adams & Bennett Combos	37
Frankford Arsenal Reloading Tools	38 - 45
LOCKDOWN Vault Accessories	46 - 55
Miles Gilbert Stockmaking Supplies	56 - 57
PAST Recoil Protection	58 - 59
Tipton Gun Cleaning Supplies	60 - 73
Wheeler Engineering Gunsmithing Supplies	74 - 81
Website & Dealer Tools	82
TV Shows & Publications	82
Brand History	83

TERMS & CONDITIONS

Case Packs: Battenfeld Technologies has moved to a “case pack” system for our finished goods. Our case pack quantities will help us and our customers with shipping and receiving efficiencies. We will only deliver case packaged items in their case pack quantities - orders for quantities outside of case pack quantities can no longer be accepted. Our price lists have been updated to note quantity changes.

Freight Claims: Ownership passes to customer when carrier accepts and signs for shipment. Damage or shortages must be reported to carrier and claims must be filed through carrier.

Shipping: Battenfeld Technologies, Inc. Reserves the right to use its designated carriers on all shipments.

Drop Shipping: Battenfeld will drop ship to your customer at your request. The minimum for each order at one time to one location is \$2,000.

Backorders: Backorders ship once they are available, unless purchase orders state otherwise. Battenfeld pays freight on backorders originating from qualified invoices.

Shortages: All shortages must be reported to Battenfeld within 10 days of receipt or shipment.

Returns: All returns require a return authorization number from Battenfeld.

All Battenfeld products have a one-year warranty against manufacturer’s defects. Defective products may be repaired or replaced solely at the discretion of Battenfeld Technologies, Inc.

If product received is not in resalable condition, it may be returned for exchange. If requested, Battenfeld will send materials that would enable the products to be resold (ex. Bags, header cards, labels, ext.).

SALES REPRESENTATIVE GROUPS

(1) **Proactive Sales & Marketing NE, LLC** North-Midwest Territory / Phone: (800) 851-8354 / Email: donhanson@proactivesales.org

(2) **Bruce Odle & Associates** Great Lakes Territory / Phone: (573) 875-5246 / Email: blmay@odle.biz

(3) **H&G Marketing NE** New England Territory / Phone: (518) 583-9963 / Email: jackley@hgreprs.com

(4) **The Giesecke Company** South-Midwest Territory / Phone: (281) 350-0197 / Email: lammymy@aol.com

(5) **Proactive Sales and Marketing** Southeast Territory / Phone: (931) 490-7951 / Email: ProActiveS@aol.com

(6) **H&G Marketing West** West Territory / Phone: (720) 851-5127 / Email: tmzeske@hgreprs.com

(7) **Korth Group Ltd.** Canada (Quebec & Ontario) / Phone: (403) 938-3255 / Email: slclouthier@korthgroup.com

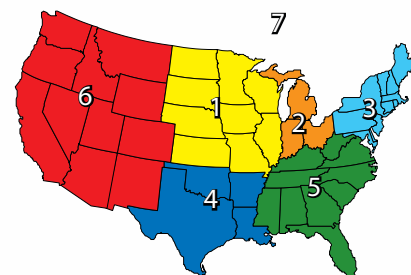

NEW PRODUCTS FOR 2011



Eyes & Ears Belt Clip
Page 33



AR-15 Brass Catcher
Page 15



Clay Launcher
Page 28



DeadShot® FieldPod™
Page 18

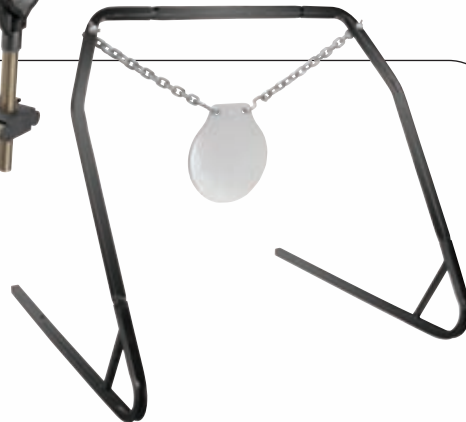

Magnum Rifle Gong
Page 30



Vault Lighting Kit, Page 47



Vault Anchor Kit
Page 47



Hygrometer
Page 48



Dehumidifier Rods
Page 48



Silica Gel
Page 49



Large Document Holder
Page 50



Small Document Holder, Page 51



Firearm Wipe Down Kit, Page 49



Key Rack
Page 51



Large Hanging Organizer
Page 52



Handgun Hanger
Page 53



Small Hanging Organizer
Page 53



Vault Organizer Drawer
Page 54



Magnetic Barrel Rest
Page 54



Professional Reticle
Leveling System
Page 77



Handgun Vaults
Page 56



Handgun Racks
Page 55





PATENT
PENDING

Fire Control®

Caldwell's team of engineers has developed a series of rifle rests that incorporate their new "Fire Control" mechanism. "Fire Control" is an advanced alignment system that allows the shooter continual, one-hand adjustment of downrange crosshair alignment via a multi-directional control arm. The Fire Control mechanism allows continuous adjustment of the front forend support by manipulating the control arm with your fingertips. Once the coarse adjustments have been made to position the rest, the control arm allows fluid movement for precise crosshair alignment without having to change shooting position to loosen or tighten rest components. The end result is unmatched control of crosshair alignment in a rock solid shooting platform which delivers better accuracy than any existing rest.

This revolutionary development allows accuracy and speed previously unavailable in conventional rifle rests. The continuous precision adjustment of Fire Control allows the crosshairs to easily and quickly be manipulated as the shooter maintains a perfectly relaxed shooting position. Fire Control will give you the confidence of knowing your crosshairs will be precisely aligned as the trigger breaks. Providing control right up to the point of trigger break greatly enhances accuracy potential. Rests with fixed adjustment systems require the last micro alignment to come from leaning, pushing or pulling slightly on the gun and or rest, thus greatly limiting accuracy.

Another inherent benefit to the Fire Control rests is ease and speed of realignment after recoil. No more moving the entire rest back into position or loosening knobs and turning screws to realign. With up to 60" of windage and elevation adjustment at 100 yards, getting back on target instantly after recoil from a previous shot is at your fingertips via the control arm.

In addition to the precision alignment mechanism, these rests are built to exacting tolerances and specifications to provide the rock solid performance Caldwell is known for.

Both Shooting Rests include: Stainless Steel Leveling Feet, Forend Stop, Medium Profile Filled Front Bag and 3-lobe bag for wide forend rifles. The coarse elevation provides approximately 4" inches of adjustment at the rest. Adjustable tension of the control arm allows for customized resistance pressure via four nylon tipped set screws.

Shooting with a Fire Control shooting rest is as easy as 1 - 2 - 3.

Step 1: Use threaded feet to raise rest off bench and to level the rest.

Step 2: Set and lock coarse elevation adjustment.

Step 3: Move control arm to align crosshairs, then fire.



Step 3



Fire Control® Front Rest™ / #746884 / Case Pack of 1

Built with the Benchrest shooter in mind the Fire Control Front Rest utilizes a massive 15"x11.5" cast iron base. Overall weight approximately 18 pounds.

Filled medium bag is held securely with threaded fasteners and can be changed out with the 3-lobe bag (included)

Machined hardened steel gear rack for coarse elevation adjustment

Elevation adjustment knob provides quick steady movement

Elevation lock knob quickly and securely locks into position

product accessory

The Medium-High Rear Bag makes an excellent compliment to the Fire Control Front Rest. See page 10 for more details.



Fire Control Front Rest package: 16" wide x 13" high x 9" deep

Forend stop for repeatable firearm positioning

Control arm lever micro-tension adjustments

Spiked stainless steel leveling feet

Precision design and manufacturing provide glass smooth motion

The palm lever can be positioned 360 degrees to the arm.

Cast iron base provides rock-solid stability



Custom logo badge on full-length version

Durable steel tubes connect front and rear bases

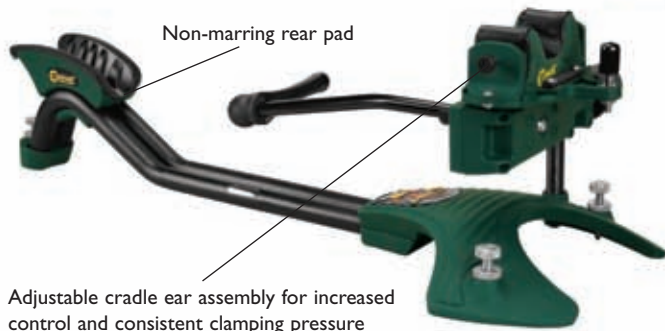

Non-marring rear pad

Adjustable cradle ear assembly for increased control and consistent clamping pressure

Fire Control® Full Length Rest™ / #100259 / Case Pack of 1

The one piece design delivers maximum stability and the convenience of fast set up and transport. Dual steel tubes connect the non-marring overmolded rear support to the sturdy cast aluminum front base. Approximately 15 pounds and 32" overall length.

Fire Control Full Length Rest package: 24.8" wide x 12.6" high x 9.3" deep



Fire Control® Accessories

An optional Control Arm is available for Fire Control rests that is optimized for use with detachable magazine rifles like the AR15. It is slightly shorter than the standard control arm and has a more aggressive offset bend to provide maximum clearance around the magazine.

Fire Control® Detachable Magazine Control Arm / #100260 / Case Pack of 1

NO RECOIL. NO FLINCH. NO EXCUSES.

From the Inventors of the Recoil-Reducing Shooting Rest.

The Original Caldwell Lead Sled revolutionized the way shooters approach shooting firearms with heavy recoil. The groundbreaking Recoil-Reduction Technology took the industry by storm and made the Lead Sled one of the most popular shooting rests of all time. Caldwell has continued to apply Recoil-Reduction Technology throughout an entire line of Lead Sled Rests, offering value and features not available anywhere else.

Recoil anticipation is undoubtedly the biggest limiting factor in accuracy for most shooters. It can contribute to flinching and poor trigger pulls which in turn result in diminished accuracy. Lead Sled rests eliminate the recoil allowing the shooter to remain comfortable, relaxed and able to focus on proper trigger control. **No Recoil. No Flinch. No Excuses.**

The team of engineers at Caldwell has done extensive research and testing on recoil forces and how to capture and dissipate the energy through the frame of a rest and into weighted media held on the rest. Each of the Lead Sled rests is designed to reduce felt recoil from even the heaviest magnum rifles to a comfortable and almost unnoticeable level. Test results show up to 95% recoil reduction. Heavy duty construction and durable components deliver dependable performance throughout the entire line.

The Caldwell Lead Sled Rests continue to be the standard by which other rests are judged.

The Physics Behind Capturing Recoil Energy

$$E = \frac{1}{2} MV^2$$

FREE RECOIL VELOCITY

$$V_{gun} = (M_{bullet} \times V_{bullet} + M_{propellant} \times V_{propellant}) / M_{gun}$$

$$E_{gun} = (M_{bullet} \times V_{bullet} + M_{propellant} \times V_{propellant})^2 / (2 \times M_{gun})$$

$$V_{gun + Lead Sled} = (M_{bullet} \times V_{bullet} + M_{propellant} \times V_{propellant}) / M_{gun + Lead Sled}$$

$$E_{gun + Lead Sled} = (M_{bullet} \times V_{bullet} + M_{propellant} \times V_{propellant})^2 / (2 \times M_{gun + Lead Sled})$$

$$F_{friction} = \mu \times M_{gun + Lead Sled} \times g$$

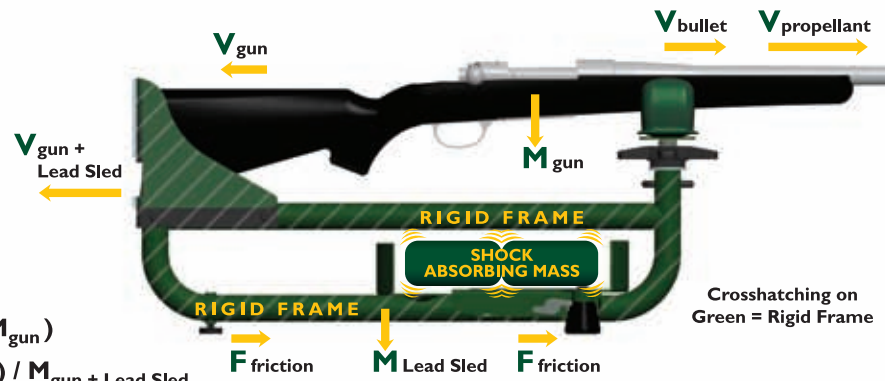

What this means to you...

Check Out These Examples of Felt Recoil (ft.-lbs.)*

Firearm Type	30-06	300 Win Mag	375 H&H	460 Wthby.	12 ga. 3.5"
Gun Only	22.6	36.8	54.9	140.3	75
With Lead Sled	1.1	1.8	2.7	7.0	3.8

KEY: M = Mass V = Velocity E = Energy F = Force μ = Friction Between Lead Sled & Bench g = Gravitational Acceleration

*Actual felt recoil may vary due to key factors such as bullet weight, velocity, shooting surface, firearm stock and recoil pad design.

Pick the best Lead Sled for your needs.

All Caldwell Lead Sled rests deliver great recoil reduction performance. This quick reference chart shows some of the other features and differences between the four models.

Lead Sled® Family Comparison Chart	Lead Sled® Solo™	Lead Sled® Plus™	Lead Sled® DFT™	Lead Sled® FCX™
Dramatically reduces recoil	X	X	X	X
Accepts lead shot bags	X	X	X	X
Precision elevation adjustment	X	X	X	X
Weight tray capacity	25 lbs.	100 lbs.	100 lbs.	75 lbs.
Ideal for extreme magnum rifles & slug guns		X	X	X
Accepts plate (bar bell) weights		X		
Precision windage adjustment			X	X
Overall adjustable length			X	X
AR-15 / Lever action gun compatible	X		X	X
Fire Control system				X

Includes two front bags with extra tall ears to keep the rifle forend from jumping out of the bag during recoil (one bag for standard forends and a second bag for wide forends)

Precision design and manufacturing provide glass-smooth motion

Control arm lever user-adjustable micro-tension screws

Cast aluminum weight tray holds the custom-fit weight bag which is included (unfilled)

Machined steel gear rack for coarse elevation adjustment

Elevation lock knob quickly and securely locks into position

Contoured rear support protects gunstock

The control arm handle can be rotated or removed as desired

Adjustable height rear foot

2-piece design and notched rear frame support allow user to adjust the overall length of the rest

Elevation adjustment knob moves front cradle up and down



PATENT PENDING

The Lead Sled[®] FCX[™] / #820444 / Case Pack of 1

The Fire Control FCX combines the two most innovative rest technologies into the industry's most advanced shooting platform. By incorporating the recoil reduction benefits of the Lead Sled system along with the ground-breaking performance of the Fire Control mechanism, ultimate accuracy and comfort come together in one rest.

The Fire Control mechanism is an advanced rest alignment system that is actuated by a "joystick" style control arm. The Control Arm can be moved in any direction to perfectly align the crosshairs and when it is released it holds the rifle in that exact position. This precision alignment of crosshairs to target allows the shooter to be perfectly relaxed when pulling the trigger, unlike conventional rests that require pushing, pulling or leaning into the gun to gain that final bit of alignment.

The rest is engineered and constructed for ultimate stability and durability. The adjustable length and front cradle height adjustment offer the versatility to accommodate almost any rifle, shotgun or muzzleloader. The FCX truly delivers maximum accuracy potential.

- At 100 yards, the control arm provides approximately 5 feet of adjustment on target
- 2-piece design and notched rear frame support allow user to adjust the overall length of the rest
- Cast aluminum weight tray can accommodate approx 75 pounds of lead
- Custom-fit weight bag, which is included, holds approx 50 pounds of lead shot
- Machined steel gear rack for coarse elevation adjustment
- Precision design and manufacturing provide glass-smooth motion
- The Lead Sled FCX weighs approx 22 pounds and is 35" long by 13" wide

Simply move the control arm in any direction to precisely align the crosshairs on your target. The rest will hold the gun perfectly steady at any point with no additional adjustments.

product accessory An optional control arm specifically designed for detachable magazine rifles, like the AR-15, is available on page 5.

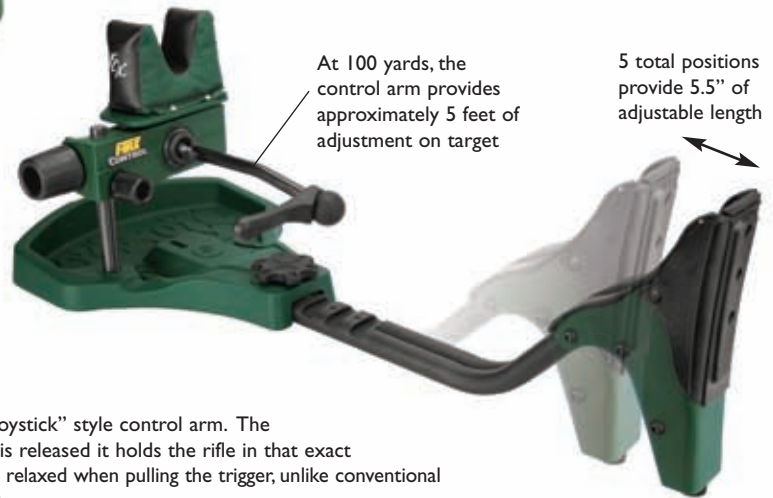

Lead Sled FCX package:
24.25" wide x 8.75" high x 14.25" deep



The Lead Sled® Plus

PATENT
PENDING



The Lead Sled® Plus™ / #820300 / Case Pack of 1

The Lead Sled Plus is the next-generation of Lead Sled offering some key enhancements over the Original. Like the Original, the Plus reduces recoil by up to 95% while securely holding your gun on target. Key improvements include a newly-designed precision elevation shaft that eliminates wobble and play in front elevation keeping you perfectly on target as well as a new Universal Weight Tray. The unique new tray adjusts to accommodate a variety of weight types, including 25 pound bar bell weights, sand or lead shot bags. These improvements along with all the other great features are sure to continue the legacy of The Lead Sled as the world's finest recoil reducing rest.

- Innovative, adjustable weight tray slides to accommodate bar bell weights as well as weight bags
- Ideal for magnum rifles & slug guns
- Holds two 25 lb. bar bell weights
- Holds up to 100lbs. of lead shot
- Improved "no wobble" elevation ram
- Fingertip elevation adjustment
- Filled front forend support bag included
- Non-marring rubber feet
- Adjustable height rear foot
- Padded rear rest protects gun stock
- The Lead Sled Plus weighs approx 15 pounds and is 27" long by 12" wide



Innovative new adjustable weight tray accommodates a variety of weight types, including 25lb. bar bell weights and lead shot bags.

New, precision "no wobble" elevation ram keeps you on target.

Lead Sled Plus
package:
25.8" wide x
11.3" high x 3.9" deep



8



The Lead Sled® Solo™ / #101777 / Case Pack of 1

This new addition to Caldwell's line of recoil reducing rests features a smooth pivoting elevation system that is controlled by a single knob, making adjustments onto target fast and precise. Its unique offset frame is designed to accommodate all rifles, including detachable magazine rifles like the popular AR-15 platform or lever action guns. The integrated weight tray will hold a single 25 pound bag of lead shot. The combination of the weight and a heavy duty spring, located between the frame members, all but eliminates recoil on nonmagnum calibers and greatly reduces recoil on all calibers. The adjustable height front cradle features a forend strap that easily secures your rifle onto the rest. Non-marring contact points protect your gun's finish.

- Heavy-duty steel construction
- AR-15 and Lever Action compatible
- Fast, precise pivoting elevation system
- Heavy-duty spring aids in recoil reduction
- Holds one 25 lb. bag of lead shot
- Forend strap secures rifle in the rest
- Adjustable front cradle height
- Non-marring, easy-turn front leveling feet
- Rubberized, non-marring front & rear cradle
- The Lead Sled Solo weighs approx 14 pounds and is 26" long by 18" wide

The Lead Sled® Solo

PATENT
PENDING



Lead Sled Solo package:
24" wide x 8.5" high x 6.5" deep





Lead Sled DFT package:
30" wide x 12.75" high x 5" deep

Filled bag specially
designed for the DFT

2.5" of elevation
adjustment on smooth
ball bearings

PATENT
PENDING



Lead Sled DFT is 3" longer
than the original Lead Sled

Thick, foam filled sides, as well as a channeled
bottom similar to traditional rear bags

Dual frame technology absorbs recoil

Windage adjustment

Fingertip rear
elevation adjustment

Baffled tray keeps lead shot bags in place
and holds up to 100 lbs. of lead shot – also
holds weight bags full of sand or other media

Rubber tipped feet offer no-skid support on any surface

The Lead Sled® DFT™ / #336647 / Case Pack of 1

The Lead Sled DFT (Dual-Frame Technology) provides shooters with the industry's best recoil reduction system and the versatility to fit virtually any shotgun or rifle, all built around a precision shooting platform. A key feature of the DFT is the ability to slide the front cradle back and forth along the Dual Frame for optimal length adjustment.

Whether you are trying to shoot the very tightest possible groups with your rifle or patterning your favorite shotgun, the Lead Sled DFT provides an optimal platform for shooting without nasty recoil.

- Dual frame design disperses a maximum amount of recoil energy
- 18" of adjustment to fit rifles and shotguns of virtually any size
- Extremely fine windage and elevation adjustments with finger tip control
- Enhanced recoil dispersion through unique baffle and tray system
- Maintain optimal shooting position with rear micro elevation adjustment
- Non-marring rubber feet
- Holds up to 100 pounds of lead shot
- Filled front forend support bag included
- Padded rear rest protects gun stock
- The Lead Sled DFT weighs approx 24 pounds and is 30" long by 12" wide



Lead Sled Weight Bags package: 5.5" wide x 9.25" high x 2" deep

Lead Sled® WEIGHT BAG

Lead Sled® Weight Bags

These stout bags are designed to be placed in the shot tray of your Lead Sled, Lead Sled Plus or Lead Sled DFT and conveniently hold a 25 lb bag of lead shot, sand, or other weighted media. The durable handles make toting your weight bags to the range a snap. Available in Standard (5.5" x 10" x 3") and Large (7" x 11" x 3") size. The Standard Bag holds approximately 7 pounds of sand. The Large Bag holds approximately 20 pounds of sand. Standard available in one and four packs. **Case Pack of 4.**

Standard Bag, Single / #428334

Standard Bag, 4 Bags / #531117

Large Bag, Single / #777800



"The Rock BR"

The Rock BR™ / #440907 / Case Pack of 1

The Rock BR will help you discover the true potential of your rifle and ammunition. This high quality rest is designed for the highest accuracy-minded shooters around, bench rest competitors. Now everyone who wants the best from their rifle can benefit from the advanced design, precision machining, and finely engineered features of the Rock BR.

The Rock BR is loaded with the following features:

- 13 lb. product weight dispersed along 14" cast-iron footprint
- Fine elevation adjustments are possible through our ball bearing rotational system
- Cradle features a sturdy bag tensioning system for improved forend support
- Windage-adjustable cradle allows shooters to make smooth and precise corrections with fingertips and increased stability for refined accuracy
- Rest comes with both 3-lobe bag for wide forends and filled Medium Varmint front bag for sporter style forends
- Accepts any of the Caldwell Deluxe Front Rest Bags
- 2-stage elevation adjustment up to 11 1/2"

The Rock BR package:
16.5" wide x 6.75" high x 10" deep



Front Bag Forend Tension System



Fine Elevation Ram & Sliding Base Collar



New & Improved Windage System



Rock BR & Rock Accessories

BR Feet are designed to provide a stable, non-marring solution that keeps the spiked metal feet of your front rest from gouging or scratching the tabletop of your shooting bench. BR Feet are rubber coated, metal washers that allow the shooting rest's spiked metal feet to nest in the washer to provide a firm, no-slip footprint while protecting your tabletop.

BR Feet (3 BR Feet, metal spikes not included) / #845221 / Case Pack of 6

"The Rock"

The Rock™ / #383774 / Case Pack of 4

The best way to determine the accuracy of your rifle and ammunition is to shoot them from a solid bench, with a quality shooting rest. With precise repeatability of shots as your goal, The Rock Deluxe Front Rest is the right tool for the job. The Rock helps eliminate the "human factor" in shooting and will help you shoot tighter groups.

- Wide and stable footprint dispersed over 8 1/2 lb. rest, 13" diameter base
- 7/8" diameter steel post provides smooth and quick elevation adjustments up to 8 1/4" height
- Use the 3 leveling feet to level your rest on most any surface
- Forend stop ensures consistent stock placement from shot-to-shot
- Forend cradle is designed to accept all Caldwell Deluxe Universal Front Rest Bags
- Filled Medium Varmint front bag Included with rest



The Rock package:
13" wide x 4" high x 14" deep

The Rock Jr.™ / #323225 / Case Pack of 4

Many of the same features as The Rock, but in a sleeker and more economical package. For sighting-in, test firing, and informal competition, it's tough to beat a Rock Jr.

- Y-shaped base dispersed over 5 1/2 lb. rest
- 3/4" diameter steel post provides secure and smooth elevation adjustments up to 8" height
- Comes with interchangeable non-slip rubber feet or metal spike feet
- Filled Medium Varmint front bag included with rest
- 10" diameter base



The Rock Jr. package:
10" wide x 4.25" high x 9.75" deep

"The Rock Jr."



Rear Bags for use with Front Shooting Rests

These innovative, high-quality leather and polyester Rear Shooting Bags function with most brands of front rests. The leather gives you a secure rest and the polyester, which will not stretch or sag, allows the bag to hold its shape. **Case Pack of 4.**

- Standard Rear: for use with the 4" Center Post on the Rock™ and other similar rests
- Medium-High Rear: for use with the Fire Control Front Rest and other similar rests
- Magnum Extended Rear Bag: for use with extended height shooting rests
- Unfilled bags should be filled with dry silica sand or other inert fillers

(A) Standard Rear Bag

Filled: #598458 / Unfilled: #226645

(B) Medium-High Rear Bag

Filled: #800888 / Unfilled: #800777

(C) Magnum Extended Height

Filled: #445389 / Unfilled: #158002

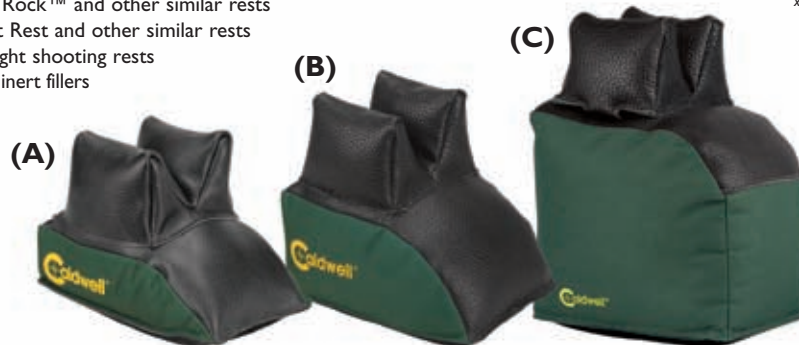

Standard & Medium-High
Rear Bag (unfilled) package:
3.875" wide x 8.25" high
x 2.5" deep



Matrix™ / #101600 / Case Pack of 3

Caldwell Sets a New Standard for Value, Performance and Features in a Shooting Rest.

The highly versatile Matrix combines great new features and rock solid stability in an affordable rest. Central to the design is the innovative, ultra rigid U-channel frame, quickly adjusting in length for the perfect fit with any gun while remaining completely stable. The two piece sliding frame incorporates an open central channel with plenty of clearance for hi-capacity detachable magazines (AR 15 style guns) as well as lever action guns. A convenient storage area incorporated into the front of the base features a removable lid that adds additional clearance when detached but also doubles as a rubberized rear support surface for firing handguns when left in place.

Another key feature is the all new front elevation system. A spring loaded tension mechanism and height adjustment knob allow for one handed elevation adjustments, keeping the front cradle wobble free throughout the entire vertical range. Overmolded front and rear supports protect the guns finish but are firm enough to prevent any give or play.

Shooters will also enjoy the versatility of converting the Matrix into a compact front rest by removing the rear portion of the frame.

Whether used as a front rest or as a full length rest the Matrix provides stability that will deliver maximum accuracy potential.



Matrix package:
16.5" wide x 6.5" high x 19.5" deep



4.5" of
overall
length
adjustment



MATRIX™

SHOOTING REST™



The Matrix is an extremely versatile shooting rest

Pistolero™

Pistolero™ / #562771 / Case Pack of 4

The Caldwell Pistolero is the ideal handgun shooting rest. By combining 5 inches of horizontally adjustable hand-support with 3 inches of vertically adjustable barrel-support, this rest accommodates virtually every size handgun. The front and rear support feature a non-marring material that is gentle on your firearm yet is firm enough to provide a stable shooting surface. In addition, the rugged construction of this rest is virtually impervious to the elements. This combination of versatility, stability and durability make the Pistolero the number one value in handgun rests.

Pistolero package:
16" wide x 8.4" high
x 5.4" deep



The Pistolero is so versatile, it accommodates a handgun like the 1911 just as easily as the big Smith & Wesson 500.



STEADY REST NXT®

Steady Rest NXT® / #548664 / Case Pack of 4

The Steady Rest NXT gives you a steady, elevation-adjustable platform for sighting in rifles, pistols and patterning shotguns. The three-piece design allows the shooter to use the rest in one or two-piece configurations, allowing it to adjust to any length long gun as well as handguns. The front and rear support features a non-marring material that is gentle on your firearm's finish yet is firm enough to provide a stable shooting surface. Overall length of rest is 26". 3" of vertical cradle adjustment.



The front rest alone also doubles as a handgun rest. The neoprene pad provides a firm, cushioned base for your favorite pistol or revolver.



Steady Rest NXT package:
12.2" wide x 10.5" high x 5.4" deep



Retail package is 1/3 the size of the original Steady Rest package!

Handy Rest NXT® / #574662 / Case Pack of 4

The Caldwell Handy Rest NXT is an extremely versatile front rest. It is designed with a full six feet of elevation adjustment at 100 yards (3" at cradle), a front sling stud clearance groove, and is constructed of durable, lightweight materials. The innovative design includes a removable handgun support attachment that easily converts this rifle rest into a handgun rest. The front rest and handgun support feature a material that will not harm your valuable firearm yet also offers a steady shooting surface.

HANDY REST NXT®



Handy Rest NXT package:
14.3" wide x 12.5" high x 4.8" deep



The removable handgun support allows you to use the Handy Rest NXT with a pistol and revolver, in addition to a rifle.

7 Rest™ Shooting Rest / #101557 / Case Pack of 4

The 7-Rest is a truly innovative shooting accessory that utilizes a unique design to deliver exceptional versatility and true value. The asymmetric frame provides great stability while maximizing length adjustability. By simply loosening the lock knob, the angle between the two halves of the frame can be adjusted to change the distance between the front and rear supports. Having the frame offset to the side of the gun also gives adequate clearance for extended magazines on semi-autos (AR-15), lever actions and rolling blocks.

Another benefit of the frame design is the ability to reverse it for right or left handed shooting comfort. Fully adjustable overmolded front and rear supports hold your gun securely while protecting the stock and forend. All these features rolled into one rest result in a rock-solid, all-in-one shooting base with plenty of height and length adjustment to accommodate guns of virtually any length. Folds quickly for easy transport and storage.

- Works great with AR-15s and lever-action rifles
- Ambidextrous - folds to accommodate right or left-handed shooters
- Overmolded supports
- Folds compact for transport and storage



The
7 REST

14

7-Rest package:
8.5" wide x 25.5" high x 2" deep



ZeroMax® Shooting Rest / #546889 / Case Pack of 4

The Caldwell Zero-Max Shooting Rest is a full-length metal rest that comes packed with all of the features that today's shooters demand. This "no frills" full length rest offers the shooter a rock solid platform for quick and convenient set-up without the expense and complexity of other rests.

- Durable tube steel frame fabrication
- Elevation adjustment
- Filled Medium Varmint front bag included
- Micro adjustment for elevation corrections
- Rock-solid shooting base for rifles and shotguns



ZeroMax™

ZeroMax package:
23.8" wide x 6.5" high x 5" deep



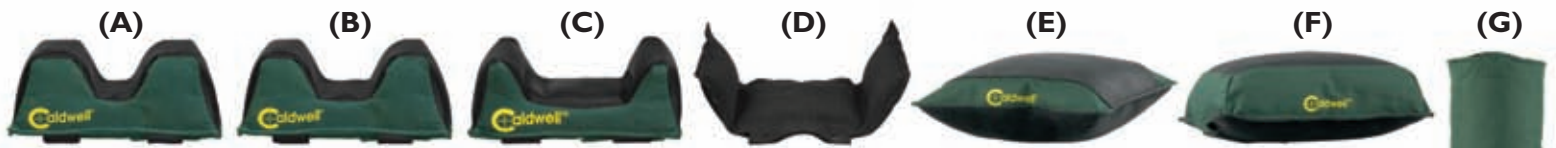

Deluxe Universal Front Bags and Bench Accessory Shooting Bags

These innovative, high-quality leather and polyester Front and Rear Shooting Bags function with most brands of front rests. The exclusive hook and loop tabs or the Front Rests allow quick installation and removal from the cradle without time-consuming need to lace them on. The leather gives you a secure rest and the polyester, which will not stretch or sag, allows the bag to hold its shape. This combination makes for the best shooting bag on the market. **Case Pack of 4.**

- Narrow Bag is ideal for most sporting rifles
- Medium and Wide Bags are perfect for varmint and benchrest rifles
- 3-Lobe Bags give the most clearance for wide, flat forends
- Most bags are available filled or unfilled. Unfilled bags should be filled with dry silica sand or other inert fillers

(A) Narrow Sporter Front Bag / Filled: #108325 / Unfilled: #391981 / Case Pack of 4

(B) Medium Varmint Front Bag / Filled: #263234 / Unfilled: #174122 / Case Pack of 4

(C) Wide Benchrest Front Bag / Filled: #576578 / Unfilled: #489585 / Case Pack of 4

(D) 3-Lobe Bag / Unfilled: #652439 / Case Pack of 4

2 Bag Set (Includes Medium Varmint Front Rest Bag (B) & Standard Rear Bag) / Unfilled: #168634 / Case Pack of 4

4 Bag Set (Includes Narrow (A), Medium (B), Wide Front (C) Bags & Standard Rear Bag) / Unfilled: #421196 / Case Pack of 4

What began as an improvement over the classic front rest bags has been expanded to include a variety of accessory bags for informal as well as competitive shooting. Blending the idea of combination leather and polyester rest bags with classic accessory bags has resulted in new shapes, new uses and a new look. **Case Pack of 6.**

(E) Elbow Bag / Filled: #774317 / Unfilled: #697339 / Case Pack of 6

7" square, approximately 1 3/4" tall: The Elbow Bag saves wear and tear on elbows / forearms.

(F) Universal Bag / Filled: #116375 / Unfilled: #811284 / Case Pack of 6

8" long, 5" wide, 2 1/4" tall: The Universal Bag has many uses. It can be used as a forearm or elbow rest; to raise the height of the rear bag; between the buttstock and the shoulder with heavy recoil long guns; a heel rest for handgun shooting; or even as a practical front rest.

(G) Cylinder Bag / Filled: #368801 / Unfilled: #580680 / Case Pack of 6

9 1/4" tall, 3 1/2" diameter: The cylinder bag can be used as a buffer bag between buttstock and shoulder for heavy recoil firearms; as an ankle support in the kneeling position; or even as a practical forend rest when the situation requires.

Accessory Bag Combination / Filled: #343375 / Unfilled: #506490 / Case Pack of 6 Bags E, F, and G offered together for a package price.

See bag filling instructions on p. 18



AR-15 Brass Catcher / #122231 / Case Pack of 4

Tired of picking up .223 brass from your AR? The AR-15 Brass Catcher attaches to the forearm of any AR with hook and loop webbing and captures the ejected brass. It prevents brass from being scattered around your shooting area. Also works great in preventing hot brass from landing on shooter or other people next to the shooter. Wire frame holds fabric in correct shape and allows brass to enter bag without disruption to bolt function or interrupt cycling. Captures and holds approximately 30 rounds. Convenient zipper at bottom of mesh bag makes emptying simple.

- Quickly attaches to any AR-15
- Holds approx 30 rounds of spent brass
- Zipper for easy emptying
- Won't interfere with gun's cycling



Package: 6" wide
x 10.125" high
x 1.875" deep



NEW FOR
11
TWENTY



Wind Wizard™ / #112350 / Case Pack of 1

The Caldwell Wind Wizard is the ultimate tool for indicating wind speed. Knowing wind speed gives the shooter the ability to judge shot placement in always varying wind conditions. Both compact and portable, this wind meter reads wind and temperature in various units of measure.

- Wind speed measures in mph, ft/min, km/h, m/s, or knots
- Wind measuring range is from .6 m.p.h. to 67 m.p.h.
- Temperature display in Celsius & Fahrenheit
- LCD backlight
- Auto power off
- Neck band included

Wind Wizard package:
6.3" wide x 7" high x 1" deep



WIND WIZARD

Works well with both shotguns and rifles.



16



Shoulder strap for convenience and portability.



Tack Driver® Shooting Rest

The most user-friendly and effective, one-piece shooting bag available. This convenient shooting bag takes the place of two. You can use the Tack Driver almost anywhere, from portable and permanent shooting benches to makeshift positions in the field.

- Self-tightening surface grips your rifle and reduces felt recoil
- Non-marring, non-slip surface will not harm your rifle's finish
- Supports almost any rifle or shotgun type
- Shoulder carrying strap included
- Available filled and unfilled



Tack Driver (filled) / #569230 / Case Pack of 1

Tack Driver (unfilled) / #191743 / Case Pack of 6

Tack Driver Unfilled package: 6.8" wide x 14.8" high x 1.5" deep

HOW DO YOU FILL SHOOTING BAGS?

Proper filling of your shooting bag is critical for performance and durability. Most of the Caldwell bags are available both filled and unfilled. Different model bags will have slightly different filling port designs; however similar techniques can be used.

MEDIA SELECTION: Some of the most common choices for material to fill your bag are sand and case cleaning medias like ground walnut, corn cob or synthetic. We do not recommend using actual grain or rice as it is likely to attract rodents. We recommend ground walnut media because it provides good density, is light weight and relatively resistant to moisture. Sand works well for smaller bags but is not a good choice for large bags as it will be too heavy resulting in unnecessary stress on seams.

FILLING: Once you have media selected and ready, locate the filling port on your bag. Most of the ports will be tucked under a flap or secured with hook and loop in a "closed" position. Use a funnel to pour media into the bag. If a common funnel is not available, a piece of thick paper can be rolled into a cone shape and used as a funnel. We suggest packing the media periodically during filling; this can be done with any blunt ended object. A long screwdriver with an ink pen cap or a empty brass casing taped on will work well. It is important to get the media packed densely to provide stable support for your gun. Once the bag is filled and packed, the filling port can be folded and secured in place to prevent leakage.



DeadShot[™] SHOOTING BAGS



Transport Front & Rear Bags easily using the exclusive Quick-Connect System.

NEW DESIGN
11
TWENTY

DeadShot[®] Shooting Rests

Every hunter and shooter is looking for a versatile and steady shooting system that can be set up almost anywhere, and at any time. Whether you have minutes or seconds to set up for your next shot, the DeadShot Shooting Bags are the answer. These inexpensive and functional bags continue to set the industry standard for quality and functional shooting bags.

- Place them on almost any shooting surface
- Made of durable, water-resistant 600 Denier polyester
- Front shooting bag is the industry's largest (approximately 8lbs.)
- Quick-connect feature makes bag transport easy
- Front bag dimensions: 10" wide x 8 1/2" high x 6" deep, rear bag dimensions: 5" wide x 5" high x 4 1/2" deep
- Available filled and unfilled



DeadShot Combo Unfilled package: 5.5" wide x 9.3" high x 2" deep



DeadShot Combo Filled package: 10.3" wide x 10.5" high x 6.8" deep

DeadShot Front Shooting Rest (filled) / #516620 / Case Pack of 1

DeadShot Rear Shooting Rest (filled) / #640721 / Case Pack of 1

DeadShot Shooting Rest: Front & Rear Combo (filled) / #939333 / Case Pack of 1

DeadShot Shooting Rest: Front & Rear Combo (unfilled) / #248885 / Case Pack of 4

Hunter's Blind Bag

Support and protect your rifle in almost any hunting situation. The Caldwell Blind Bag is the answer when other types of support are unavailable or inappropriate. Quick set-up for accurate shooting when the need for a stable rest is at a premium.

- Quickly sets on any narrow surface such as; deer/turkey stands, fence posts, tree limbs, brick walls or the side of your pickup
- Bag is trim, lightweight, easy-filling and will not sag over time
- Dark green color blends well with natural surroundings
- Narrow contour of rest matches most sporter weight stocks

Hunter's Blind Bag (filled) / #247261 / Case Pack of 6

Hunter's Blind Bag (unfilled) / #740805 / Case Pack of 6



DeadShot® FieldPod™ / #488000 / Case Pack of 1

Achieve benchrest accuracy when it counts most - in the field. Caldwell is known for producing rock solid Shooting Rests; the FieldPod is a highly portable Hunting Rest that allows you to bring that same stability along on the hunt. Its innovative design and versatility make it perfect for a variety of hunting applications.

Height adjustment ranges from 20" to 42" ensures your gun can be precisely positioned and supported whether sitting on the ground or in a chair. Get ideal position and stability for your shotgun, rifle or crossbow while shooting from a stool inside a ground blind. Improve predator hunting success with the perfect gun position on every set, minimize movement, speed up target acquisition and increase effective shooting range. Take advantage of the portable and stable design on western hunts that frequently offer long range shot opportunities. Length and pivot point adjustments ensure a perfect fit and balance for any weapon. Cast aluminum hub provides tension adjustable rotation and tilting for fast and stable target acquisition. Precision cast aluminum hub system allows gun to pivot up/down and rotate left/right. Carry strap included.

- Lightweight aluminum construction, under 6 Pounds
- Innovative design easily adjusts to any gun or crossbow, supporting both forend and stock
- Quickly collapses for transportation
- Adjusts from 20" high up to 42"
- Pivots up/down and rotates left/right for quick target acquisition
- Durable cast aluminum hub for maximum stability and smooth movement
- Great for: Ground Blinds, Predator Calling, Long Range Rifle Shooting and Turkey Hunting
- Enhances success and safety for a beginner by supporting the weight of a gun and provides that extra stability and confidence for the experienced shooter to take a long shot.
- Dual tube frame is fully compatibility with detachable magazine rifles like the popular AR

NEW FOR
11
TWENTY

Independent height adjustable front and rear supports

Overmolded rear stock support

Upper frame balance point adjustment

Overmolded front forend support

Dual frame for maximum stability and length adjustment

Upper frame length adjustment

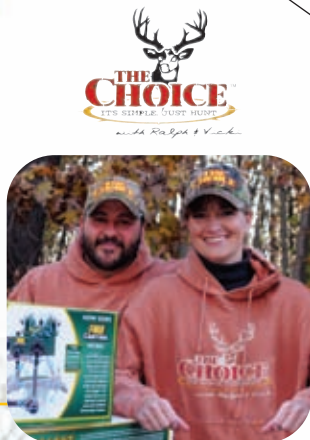

"Innovation, quality and dependability, that's what comes to mind when I think Caldwell. Vicki and I have been working with the team at Caldwell Shooting Supplies for years. We're proud to be associated with such a great company." Ralph Cianciarulo

Tension knob for tilting the frame up or down

Cast aluminum hub design

Tension knob for rotation of upper frame

Durable, lightweight extruded aluminum frame

Fast adjustment for leg height

Durable all-terrain feet

Predator Hunting: Get perfect gun position for any predator calling set, reduce movement and increase accuracy

ADJUSTABLE



Innovative cast aluminum hub provides tension adjustable rotation and tilting for fast and stable target acquisition. Front and rear supports independently adjust for height and upper frame adjusts in length as well as pivot point for perfect fit and balance with any weapon.



Ground Blind: Perfect for use inside a ground blind while seated on a stool or chair

The FieldPod provides the stability required to allow shooters to execute the extreme long range shots that today's advanced weapon systems are capable of.

VERSATILE



The innovative front and rear supports are designed to accept firearms of nearly all shape, width and length.



The dual frame allows for use of detachable magazine rifles such as the popular AR.



Even crossbow users were taken into consideration when designing the new FieldPod.

CONVENIENT



Quickly folds compact for easy transport, detachable carry strap included

XLA Bipod™

The Caldwell Bipod XLAs provide a stable shooting support that conveniently attaches to almost any firearm with a sling swivel stud. The lightweight aluminum design adds minimal weight and deploys quickly, with legs that instantly spring out to the shooting position with the touch of a button. The legs are notched for easy indexing to a specific height. There is a connection point for sling attachment and multi section legs that collapses forward allowing for convenient carry of the firearm. Soft rubber feet provide enhanced stability, while the padded bipod base protects the firearm's forend. Bipod XLAs are available in three heights in both standard and pivoting models.

What are the benefits of having a pivoting model bipod? In the real world of hunting, the chances of the ideal shot opportunity occurring while on a level ground are slim-to-none. A pivoting bipod will allow the shooter to compensate for ground that is unlevel by up to 20 degrees. The lower portion of the bipod pivots independently from the upper stock mount, allowing the firearm to be quickly leveled on uneven ground. The tension knob can be adjusted to control the resistance of the pivoting motion. **Case Pack of 6.**

Bipod Size	Fixed	Weight	Pivot	Weight
6" - 9"	#379852	9 oz.	#247142	12 oz.
9" - 13"	#403215	11 oz.	#571429	13 oz.
13" - 23"	#591336	14 oz.	#701417	16 oz.
13.5" - 27"	#358974	17 oz.	#635705	19 oz.



Bipod XLA package:

6" to 9" and 9" to 13" Models
5.8" wide x 11.8" high x 2.4" deep

13" to 23" and 13.5" to 27" Models
5.8" wide x 18.3" high x 2.4" deep

13.5"- 27" Model
Shown Here

XLA Bipod

6"- 9" Model
Shown Here

9"- 13" Model
Shown Here

6"- 9" Fixed Model
Shown Here

13"- 23" Model
Shown Here

PIVOT MODEL

6"- 9" Pivot
Model
Shown Here



Shooting Sticks

The Caldwell shooting sticks are constructed of lightweight aluminum, offering strong and convenient support for better accuracy. The multi-section sticks fold for easy carrying and feature an elastic retention strap to keep the legs tight and quiet. Internal shock cord allows the sticks to assemble themselves with a quick release of the elastic strap. They fit in a backpack pocket or on your belt with the included carry holster. Lightweight and compact design means they are easily accessible for a quick shot. Non-marring overmolded ends provide secure, quiet support for your gun.

- Available in Standing or Sitting models
- Durable lightweight aluminum construction
- Improves shooter accuracy
- Belt carry holster included
- Elastic strap keeps sticks bound tight and quiet

Shooting Sticks, Sitting Model / #400555 / Case Pack of 4

Sitting model features three sturdy sections which extend to 39".

Shooting Sticks, Standing Model / #400567 / Case Pack of 4

Standing model features five sturdy sections which extend to 72".

Works well with both rifles and shotguns.



Shooting Sticks package:
3.8" wide x 18.8" high
x 2" deep

**SHOOTING
STICKS**

Shooting Bipods

Designed with all of the features necessary for steady, accurate shooting, regardless of the range or terrain. Now you have extreme motion ranging capability with our exclusive wide-pan and stock canting features that come standard with our bipod design. Two-models available for adapting to any shooting situation. Folds out-of-the-way when not in use.

- Easily attachable and detachable from the front swivel stud
- Lightweight aluminum design for quiet, weatherproof performance
- Built-in swivel pan feature left or right 20 degrees combined with an 18 degree bi-directional cant
- Stud for sling attachment

Prone Model, Black / #457855 / Case Pack of 1

Prone: Weighs 10.5 oz., 8 3/4" to 12" height adjustment for prone and bench shooting usage

Sitting Model, Black / #335235 / Case Pack of 1

Sitting: Weighs 15 oz., 14" to 30" height adjustment for prone and sitting usage



Bipod, Sitting package:
6" wide x 22.2" high x 2.3" deep

Bipod, Prone package:
6" wide x 15" high x 2.3" deep



Stable Table® Deluxe Shooting Bench / #252552 / Case Pack of 1

The Stable Table is purpose-built to be the finest value-priced shooting bench in the market. The tripod design is more rigid and has fewer joints than folding-style benches and is appropriate for a wider variety of shooting conditions and disciplines. A T-knob in the base allows position adjustment of a single leg, aligning the tabletop so that it is parallel with the horizon. The central shaft, seat and tabletop are able to pivot around a center axis as a single unit while keeping the tabletop parallel to the horizon. This allows the user to make shots at any angle from a single setup – ideal for varmint hunting. The bench can easily be locked into a single shooting position if desired. The table top is made from molded plastic with a rigid metal under-frame. The top measures 34" x 23" and it includes holes that function as handles for easy transport or as holders for the included cleaning forks, as well as a perimeter rail that keeps ammunition from rolling off the bench top. The entire frame is made from welded steel. The padded seat adjusts from 16" to 22" and rotates in tandem with the tabletop or independently. The Stable Table breaks down into seven pieces and weighs a total of 60 pounds when assembled. The weight limit of the Stable Table is 275 pounds and doesn't include the weight of the shooting rest, firearm and accessories.

22

Highly durable, weatherproof synthetic table top

Quick-release pin for easy seat height adjustment

Stable Table package: 34.7" wide x 23.4" high x 7" deep

PATENTED
US Patent 6,058,641

Two cleaning forks are included. The left one is designed to be used with forends while the one on the right is designed for buttstocks.

Table top and feet pivoting can be locked

Padded seat for prolonged shooting comfort

Reinforced welded steel frame

Molded carrying handles also serve as holders for cleaning forks.

Adjustable leg angle for use on uneven terrain

Quick-release pin for easy takedown

Includes 3 BR Feet to protect your table top from the spiked feet on your shooting rest. (spiked feet not included)

Tubular steel construction

For increased stability on grass or dirt, use these holes to insert stakes or anchors (not included)

STABLE TABLE®

The tabletop features convenient transport handles which are also compatible with the included cleaning forks for easy cleaning after a day of shooting. Simply insert the cleaning forks, rotate the table to a safe direction and the shooting bench is transformed into a handy cleaning table. The polymer tabletop is resistant to cleaning solvents and other chemicals.

The Stable Table works great with shooting rests of all shapes and sizes. The table top is reinforced with a steel frame creating a sturdy shooting surface plenty strong for those heavy recoil-reducing rests. The patented adjustable leg angle ensures a level shooting surface on uneven terrain. This feature cannot be found on other shooting benches. The seat height is easily adjustable to ensure a comfortable position for any shooter.

Stable Table® Carry Bag / #777810 / Case Pack of 1

This heavy-duty carrying bag will hold all pieces of your Stable Table and allows for convenient transport to the range or field. Full wrap shoulder straps, double layer fabric, heavy duty zipper and padded lower portion ensures maximum durability and protection for your Stable Table.

- Carries Caldwell Stable Table conveniently
- Heavy-duty construction
- Double layer fabric and padded lower portion
- Inner bag for the table hub included

Stable Table Carry Bag package:
13" wide x 17.5" high x 3.5" deep



Caldwell Custom Products are only sold via our Drop Ship Program.
Please contact our sales department at 877-509-9160 for pricing and details on the program.

BR Pivot® Premium Shooting Bench

The BR Pivot™ is the finest shooting bench available. It combines the best materials, an unparalleled design and years of thinking, field use and continuous development into a complete package that is ready for a lifetime of service. There's nothing newfangled about the BR Pivot – it's bombproof, foolproof, and ready for users that are serious about accuracy. The "Pivot" part of the name references the most useful feature – use the bolts at the base of the bench to align the bench stem and tabletop so that the top is parallel with the horizon. The seat and bench top then pivot on center and maintain a constant tabletop attitude. You can spin 360° to make shots and your tabletop will always be parallel to the horizon! The padded seat can be adjusted for any height between 16" and 27", and the pivoting function can be locked rigidly in a single shooting position if desired.

There are two tops available. The first is made from a weather-resistant molded plastic that is securely attached to a rigid metal under-frame. The top is a roomy 43" by 30" and features a shallow pocket for accessories, a place to organize binoculars or cleaning rods, and a perimeter rail to keep ammunition from rolling off the bench top. This top is designed for right-handed use only and cannot be converted for left-handed use. The second top is made from edge-glued American hardwood with a durable finish; the top measures 45" x 26". This top is attractive, traditional and functional. It's particularly good for those who prefer to use rests with spiked feet or users that live and shoot in dry climates. The wood top can be installed for right-handed or left-handed shooters. The bench breaks down into four pieces and weighs a total of 70 pounds (synthetic top) or 65 pounds (hardwood top) when assembled. The weight limit of the BR Pivot is 250 pounds and doesn't include the weight of the shooting rest, firearm and accessories. **Case Pack of 1.**

BR Pivot® Premium Shooting Bench, Synthetic Top / #300037

BR Pivot® Premium Shooting Bench, Hardwood Top / #300015

Includes 3 BR Feet to protect your table top from the spiked feet on your shooting rest. (spiked feet not included)

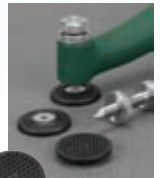

Bench Leveling
The BR Pivot features 3 adjustable height legs for when finding level ground is difficult. Up to 5" of travel on each leg.

Unified Rotation
Lock the table and seat together on the center post allowing 360° rotation as a unit. This is an ideal setup for varmint shooting.

Ultimate Versatility
The tabletop and seat will rotate independently. This will allow the user the broadest possible range of shooting angles for both right and left-handed shooters.

Light-weight aluminum center post with precision machined ends for tight-tolerance fit

Quick-release knob for easy seat height adjustment

Sturdy feet spread contact over a wider area

Adjustable cams on each leg provide up to 5" of travel for leveling shooting bench on uneven terrain

Heavy-duty tubular steel construction

360° Rotation

Table top and seat can swivel 360°, either in unison or independently.

Oversized, plush seat provides all-day comfort

Table top and feet position can be locked

Quickly and easily breaks down for storage / transportation

Patented
US Patent 6,058,641

Synthetic Top Model

- Weather-proof material
- Rigid steel underframe
- Right-hand only
- Raised lip edge
- Recessed accessory pocket

Hardwood Top Model

- Solid wood
- 1" thick
- Ambidextrous
- Polyurethane finish



Featuring Dual-Color Flake-Off Technology!

Get On Target with Orange Peel Targets by Caldwell! Orange Peels let you see hits ON and OFF the bullseye with dual-color flake-off technology that makes your hits look like colorful explosions. If your shot happens to miss the bullseye, you will know exactly where your bullet strayed...instantly. To make things even easier, the vibrant, contrasting colors make the target stick out like a sore thumb with any background, even at long distances. Caldwell makes these great targets in almost every size and shape imaginable at a price that anyone can afford. Orange Peels are clearly the best way to get on-target.

- Adhesive-backed, sticks to any surface
- Huge array of target options to fit all of your shooting season needs
- Hits in the bulls-eye: explode in neon green
- Hits outside the bulls-eye: explode in white
- Instant target feedback-you can see from the bench

**PATENT
PENDING**

ADHESIVE-BACKED
Sticks to your favorite shooting back-drop!

24



We not only have the best looking and functioning shooting targets in the sporting world, they're also packaged in vibrant, self-selling blister boards that demonstrate how Orange Peel shooting targets function.

BULLSEYE SHOOTING TARGETS

Bullseye Variety Pack, 5 sheets / #345582 / Case Pack of 10
2" Bullseye Target, 10 sheets / #686444 / Case Pack of 10
3" Bullseye Target, 15 sheets / #391984 / Case Pack of 10
3" Bullseye Target, 75 sheets / #345468 / Case Pack of 1
4" Bullseye Target, 5 sheets / #405515 / Case Pack of 10
4" Bullseye Target, 10 sheets / #410864 / Case Pack of 10
4" Bullseye Target, 25 sheets / #425824 / Case Pack of 5
4" Bullseye Target, 100 sheets / #410058 / Case Pack of 1
5.5" Bullseye Target, 10 sheets / #550010 / Case Pack of 10
5.5" Bullseye Target, 50 sheets / #555050 / Case Pack of 5

8" Bullseye Target, 5 sheets / #805645 / Case Pack of 10
8" Bullseye Target, 10 sheets / #810894 / Case Pack of 10
8" Bullseye Target, 25 sheets / #825-915 / Case Pack of 5
8" Bullseye Target, 100 sheets / #810099 / Case Pack of 1
12" Bullseye Target, 5 sheets / #120556 / Case Pack of 5
12" Bullseye Target, 10 sheets / #121066 / Case Pack of 5
12" Bullseye Target, 50 sheets / #125094 / Case Pack of 1
12" Bullseye Target, 100 sheets / #121005 / Case Pack of 1
16" Bullseye Target, 5 sheets / #172505 / Case Pack of 5
16" Bullseye Target, 10 sheets / #172510 / Case Pack of 5

SIGHT-IN SHOOTING TARGETS

8" Sight-In Target, 5 sheets / #522357 / Case Pack of 5
8" Sight-In Target, 12 sheets / #425884 / Case Pack of 5
8" Sight-In Target, 100 sheets / #753884 / Case Pack of 1

12" Sight-In Target, 5 sheets / #244561 / Case Pack of 5
12" Sight-In Target, 12 sheets / #266843 / Case Pack of 5
12" Sight-In Target, 100 sheets / #861579 / Case Pack of 1

OVAL AND SILHOUETTE SHOOTING TARGETS

7" Oval Target, 10 sheets / #878998 / Case Pack of 10
7" Oval Target, 50 sheets / #951845 / Case Pack of 1
7" Oval Target, 100 sheets / #558559 / Case Pack of 1
9" Oval Target, 5 sheets / #861558 / Case Pack of 10
9" Oval Target, 25 sheets / #564887 / Case Pack of 5

9" Oval Target, 100 sheets / #215554 / Case Pack of 1
12"x18" Silhouette, 5 sheets / #488789 / Case Pack of 1
12"x18" Silhouette, 25 sheets / #862554 / Case Pack of 1
12"x18" Silhouette, 100 sheets / #123665 / Case Pack of 1

ANIMAL SHOOTING TARGETS

7" Vermin Target, 10 sheets / #554558 / Case Pack of 10
7" Vermin Target, 25 sheets / #159489 / Case Pack of 5
12" Turkey Target, 5 sheets / #586485 / Case Pack of 5

12" Turkey Target, 25 sheets / #847885 / Case Pack of 5
12" Duck Target, 5 sheets / #968667 / Case Pack of 5
12" Duck Target, 25 sheets / #238713 / Case Pack of 5

Orange Peel® Countertop Display

- Durable, welded & painted wire form display
- Complete with 10 each of the 5 targets shown (varies by display chosen)
- Comes with a sturdy, full color display header
- Includes hang tags with product numbers that remind you to reorder when targets run out
- The small 21" x 7" footprint fits easily on your countertop
- Hunter orange targets will easily draw the customer's attention from far away
- Two versions of display are available: Animal or Target

Orange Peel Animal Countertop Display

#355488 / Case Pack of 1

Animal Display Refill Pack (Targets Only)

#462800 / Case Pack of 1

Orange Peel Target Countertop Display

#201639 / Case Pack of 1

Target Display Refill Pack (Targets Only)

#451700 / Case Pack of 1



**Animal Countertop Display
#355488**



**Target Countertop Display
#201639**



Tip Top Targets™

TIP TOP TARGETS

Tip Top Targets blister board package:
 9.4" wide x 13.1" high x .1" deep (10 sheets),
 9.4" wide x 13.1" high x .2" deep (25 sheets)

Everything that a target should be. Tip-Top Targets are made from a bright white material that "punches" rather than "tears" when bullets pass through - resulting in crisp, round bullet holes that give indisputable record of group size. As an added benefit, the material is very difficult to tear and comes pre-punched for storage in a three-ring binder, where it won't tear out like a conventional paper target. The finishing touch is the highly visible ultra-black target outline, which is printed twice for a super-saturated black color that no other target can match! The detailed legend provides an abundance of space for record keeping for handload development and testing. Targets measure 8.5" x 10".

- 4" Bullseye, 10 sheets / #359971 / Case Pack of 10
- 4" Bullseye, 25 sheets / #356647 / Case Pack of 5
- 4" Bullseye, 100 sheets / #323557 / Case Pack of 1
- 8" Bullseye, 10 sheets / #314741 / Case Pack of 10
- 8" Bullseye, 25 sheets / #337664 / Case Pack of 5
- 8" Bullseye, 100 sheets / #994521 / Case Pack of 1
- 8" Sight-In, 10 sheets / #623741 / Case Pack of 10
- 8" Sight-In, 25 sheets / #335791 / Case Pack of 5
- 8" Sight-In, 100 sheets / #257414 / Case Pack of 1
- 100 Yard Benchrest, 10 sheets / #435645 / Case Pack of 10
- 100 Yard Benchrest, 25 sheets / #471337 / Case Pack of 5
- 100 Yard Benchrest, 100 sheets / #224557 / Case Pack of 1
- 200 Yard Benchrest, 10 sheets / #731147 / Case Pack of 10
- 200 Yard Benchrest, 25 sheets / #335717 / Case Pack of 5
- 200 Yard Benchrest, 100 sheets / #689774 / Case Pack of 1
- Iron Sighter (inverted T), 10 sheets / #104111 / Case Pack of 10
- Iron Sighter (inverted T), 25 sheets / #855441 / Case Pack of 5
- Iron Sighter (inverted T), 100 sheets / #533347 / Case Pack of 1

- **NEAR PERFECT BULLET HOLES**
- **RIP-STOP MATERIAL**
- **WEATHER PROOF**
- **RECORDS IMPORTANT DATA**
- **SUPER-SATURATED BLACK INK**
- **3-HOLE PUNCHED**

Bullet punctures look so perfect that you would think that the holes were created with a hole puncher!



Plain Paper Targets package:
9.4" wide x 13.1" high x .2" deep

Plain Paper Targets

These paper targets are great for basic load testing and sighting-in. Packaged in retail-friendly blister board packs of 25. Targets measure 8.5" x 10". **Case Pack of 5.**

Plain Paper 4" Bullseye Target, 25 sheets / #187591

Plain Paper 8" Bullseye Target, 25 sheets / #406891

Plain Paper 8" Sight-In Target, 25 sheets / #398669



Shooting Spots, Squares, Pastors and
Benchrest Targets blister board package:
4" wide x 9" high x .1" deep



Shooting Spots & Squares, 100-Yard Benchrest Targets & Target Pastors

A little bit of color goes a long way on a target and Caldwell's Shooting Spots and Squares are just the way to get it. These adhesive backed spots and squares add a splash of fluorescent orange to any target backer to act as an aiming point or to cover holes from previously fired bullets. The 100-Yard Benchrest target is a must have for every accuracy aficionado. The Target Pastors will come in handy for revitalizing your favorite target for continued usage. All available in retail-friendly blister board packaging. **Case Pack of 10.**

1" Orange Shooting Spots, 12 sheets (216 ct.) / #754883

1.5" Orange Shooting Spots, 12 sheets (96 ct.) / #652710

2" + 1" Orange Shooting Spots, 12 sheets (36-2" + 72-1" ct.) / #754110

3" Orange Shooting Spots, 12 sheets (24 ct.) / #271050

1" Orange Shooting Squares, 12 sheets (216 ct.) / #711236

1.5" Orange Shooting Squares, 12 sheets (96 ct.) / #142385

2" + 1" Orange Shooting Squares, 12 sheets (36-2" + 72-1" ct.) / #432699

3" Orange Shooting Squares, 12 sheets (24 ct.) / #764123

3" White Shooting Spots, 10 sheets (20 ct.) / #879897

White Target Pastors, 10 sheets (320 ct.) / #866571

Black Target Pastors, 10 sheets (320 ct.) / #400102

Brown Target Pastors, 10 sheets (320 ct.) / #351777

Almond Target Pastors, 10 sheets (320 ct.) / #204441

3" x 6" 100 Yard Benchrest Sighter Target, 10 sheets / #321762

3" x 6" 100 Yard Benchrest Record Target, 10 sheets / #224147



The Natural Series retail display:
17" wide x 46" high x 19" deep

Individual Natural Series Targets:
16" wide x 36" high x .5" deep



The Natural Series™ Target Kits

"Aim for the point of the shoulder"...Ever try to teach a new hunter where to shoot a deer? Caldwell's Natural Series Targets are the answer to this age-old problem. These cardboard-backed, life-size color photographs illustrate both the vital organs and skeletal structure of the animals. These illustrations can be easily viewed up close, yet disappear at a distance, allowing the hunter to practice not only accuracy but shot placement selection. **All Case Pack of 6 except Retail Display is Case Pack of 1.**

- All targets feature a sturdy 48" w by 36" h cardboard backer (Turkey: 32" w x 36" h)
- Includes two adhesive-backed replacement vital targets

Natural Series Whitetail Deer Target Kit / #234412

Natural Series Mule Deer Target Kit / #800123

Natural Series Turkey Target Kit / #800234

Natural Series Coyote Target Kit / #800345

Natural Series Retail Display / #800567 (Includes 6 Whitetail Deer and 3 each of the Mule Deer, Turkey & Coyote. 15 total targets)

The Natural Series™



Mule Deer Target is
48" wide by 36" high

Turkey Target is
32" wide by 36" high

Coyote Target is
48" wide by 36" high



Clay Launcher / #505501 / Case Pack of 6

The Caldwell Clay Launcher is designed to provide hours of shooting entertainment. The one piece design is simple to use and makes it easy for anyone to throw clay birds. Simply insert clay target and fling it to send the target sailing. Great for teaching beginners or for sharpening any sportsman's wing shooting skills. Works both right and left handed. Compatible with standard size clay targets (108-110mm). Durable molded plastic construction will hold up to aggressive use for years.

- Portable and affordable handheld clay target launcher
- Works with all standard size clay targets
- Launches right or left handed



**NEW FOR
11
TWENTY**



Ultimate TARGET STAND

Ultimate Target Stand

The durable all-weather design and user-friendly features truly make this the Ultimate Target Stand. The stand features an oversized backer to hold multiple large targets (two 15" targets side by side) and is constructed of an all-weather moisture resistant material. The large size makes sighting in easy, no more bullets missing the target. The modular frame design collapses to occupy much less space during transport & storage. The frame arms are constructed of durable steel rod and hold the backer securely in place. Removable ground stabilizer adds support from wind during use and conveniently stows onto the feet. The base of the stand is open, allowing you to use your foot to drive the molded-in spikes into the ground. It even has an integrated storage container for holding miscellaneous range supplies such as staples or target pasters.



Collapsed View

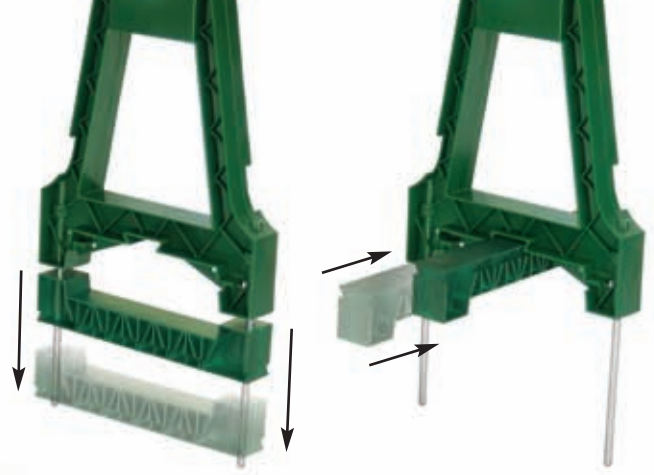

Removable stabilizer adds support while in use and stows away for easy transport.

COLLAPSES FOR EASY TRANSPORT!

Metal target frame arms can be snapped in the upright position to hold the target backer, or secured in compact position for transport.

Ultimate Target Stand / #707055 / Case Pack of 4 Replacement Backer (2 Pack) / #707100 Case Pack of 6

Ultimate Target Stand package:
10.5" wide x 24" high x 2" deep



Use your foot to drive the spikes into the ground.



Extra large backer board easily holds (2) 15" x 15" targets (targets sold separately)

All-weather backer is resistant to moisture and rotting

Removable stabilizer holds backer secure in the wind

The integrated storage compartment is handy for holding your extra staples, target pasters, etc.

Removable stabilizer provides extra front to back stability from the wind

(4) splines keep the trifold backer rigid while in use



5.75" spike

The open cavity area allows the user to apply foot pressure to drive the molded-in spikes into the ground

Built-in storage holds miscellaneous range supplies.



Portable Target Stand Kit package:
24.5" wide x 24" high x 1.3" deep



Portable Target Stand Kit

The Caldwell Portable Target Stand is the most convenient, easy to use target stand available. It is sturdy, yet lightweight, portable and easily storable. All of this comes at a reasonable price.

Includes: target stand, corrugated plastic target backing and 10 Orange Peel Targets

- Range-ready with all of the shooting range components you need, right out of the box
- Sturdy, Lightweight and easily portable while at the range
- 5/16" welded steel makes it the one of the most durable stands available
- 24" wide, 35" tall and weighs less than 2.5lbs.

Target Stand Kit / #146108 / Case Pack of 6

Replacement Target Backer (3 pack) / #186425 Case Pack of 1

Magnum Rifle Gong / #223375 / Case Pack of 2

The Magnum Rifle Gong is a high quality, extremely durable steel target designed to withstand repeated shots from all calibers of high-powered rifles and handguns. It comes complete with a freestanding frame, chains and gong. The overall size of the target system is 38 in. wide by 33 in. tall. The gong has a 10 in. diameter and is 3/8 inch thick. The center of the target hangs 18 in. above the ground. Weighs approximately 21 pounds.

Portability to and from the range is not problem with the Magnum Rifle Gong. The frame is constructed of steel tubing which requires no tools to assemble or disassemble, and entire system packs down for easy transportation. The complete system weighs only 25 pounds. Constructed of industry leading AR-550 steel tested to a Brinell hardness of 550, the Magnum Rifle Gong is designed to withstand bullet impacts without compromising the gong integrity. It is designed to be shot at a minimum distance of 100 yards, for maximum life expectancy impact velocities of 3,000 fps and below are recommended.

- AR-550 Steel construction for professional grade durability
- Designed to withstand impacts with all high power rifles and handguns
- Complete with freestanding frame, chains and 10" gong

Hardened S-hooks and high-grade, heavy-duty chain

Certified through-hardened AR-550 steel target plate



10" target plate

Quickly dismantles without tools for easy transportation.



NEW FOR
11
TWENTY

30



Airgun Target



.22 Rimfire Target



Handgun Target



Resetting Targets

Caldwell Resetting Targets are easily portable and create an interactive shooting experience that makes plinking and target practice fun. Made of heavy-duty steel, these targets are built to last. All of our resetting targets come packaged in sturdy, partial clamshells. Holes are punched in the clamshells for hanging the product on peg hooks. The rimfire and handgun models are reinforced with zip ties to ensure the heavy product is secured inside.

Handgun Resetting Target, (for up to 45 ACP, 44 Special) Target size: 3.5" / #103654 / Case Pack of 2

.22 Rimfire Resetting Target, Target size: 2.5" / #902365 / Case Pack of 4

Airgun Resetting Target, Target size: 1.5" / #820585 / Case Pack of 4

Shooting spots are included with Resetting Targets and the Plink n' Swing™ Targets. Should you wish to purchase additional shooting spots, you can find them on page 27.

Airgun package: 11.5" wide x 15" high x 1" deep

Rimfire package: 16.8" wide x 22.5" high x 1.8" deep

Handgun package: 12" wide x 26.8" high x 1.8" deep



Shootin' Gallery™

Have a youngster in your life that you'd like to take shooting? The Shootin' Gallery's combination of an endless supply of moving targets and interactive confirmation of shot placement will bring grins to your face and the face of the future shooter alike.

The Shootin' Gallery is the first of its kind: an affordable, portable, motor-driven, interactive system that allows you to shoot a steady stream of moving targets with a rimfire firearm at your shooting range or in your backyard. The design of the gallery gives you a never-ending supply of fresh targets – targets that are hit fall over, only to re-emerge from the side of the gallery! Get your trigger finger ready for fast-paced shooting action with Caldwell's Shootin' Gallery!

The Gallery includes a 12 volt rechargeable battery and charger that power a motor which drives targets left-to-right across the length of the gallery.

- Targets topple when hit and reset automatically
 - Includes rechargeable battery and charger
 - Great for practicing shooting at moving targets
 - The gallery is intended for use only with standard velocity (1200 ft/second) .22 rimfire cartridges at a distance of 75 feet.
 - Targets travel left-to-right
 - Weighs approximately 55 pounds for easy transportation
 - Runs 4 to 6 hours on a single charge
- The warranty on the Shootin' Gallery does not cover damage to the gallery resulting from the use of high-velocity rimfire ammunition, including high-velocity .22 Long Rifle ammunition, .22 Magnum, or any .17 caliber rimfire cartridges.*

Shootin' Gallery™ - Standard Rimfire / #558978 / Case Pack of 1

Replacement 2" Round Metal Targets and Couplers, 4 Pack / #344000 / Case Pack of 1

Replacement Metal Duck Targets and Couplers, 4 Pack / #344111 / Case Pack of 1

Replacement 12 Volt Sealed Lead Acid Battery / #558900 / Case Pack of 1

Replacement Battery Charger / #558800 / Case Pack of 1



Be sure to watch the Shootin' Gallery Commercial

The Shootin' Gallery commercial shows a father and son enjoying the easy-to-use interactive Shootin' Gallery. The automatically resetting targets prove to be no match for the father and son tandem. Whether the targets are hit or missed, it is obvious that the fun the two are having will bring them together for bonding and laughter for many weekends to come. Be sure to look for this commercial on the Outdoor Channel & Sportsman's Channel.

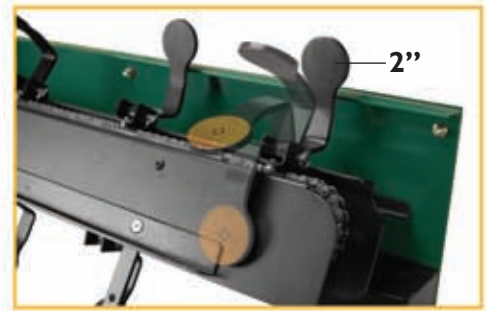

The 2" steel targets automatically reset after impact so you always have a fresh supply of targets for endless fun! The heavy weight of the targets prevents them from bouncing back after being knocked down.



- Heavy-duty Motor
- Steel Chain
- Heavy-duty Steel Sprockets
- Ball Bearings
- Sturdy Steel Legs
- Angled Front Plate
- Reinforced Steel Impact Plate
- Protected Steel Battery Box



Shootin' Gallery package:
37" wide x 8.5" high x 12" deep

Plink N' Swing™ Action Swinging Targets

Shooting is just plain fun when you can see and hear the impact of your bullets. Next time you go to the range, take the Caldwell Plink N' Swing Targets to bring fun and fast-action back to your shooting.

- Swingers and frames are made of durable steel for long life
- Audible feedback makes shooting fun for all ages
- Great instructional tool for beginners.

Plink N' Swing Centerfire Handgun Double Spin / #133565 / Case Pack of 4
Target sizes: 3" & 4.5" (for up to 45 ACP, 44 Special)

Plink N' Swing .22 Rimfire / #147072 / Case Pack of 4
Target sizes: 1.75", 2.5" & 3.5"



Plink 'n Swing Target package, Rimfire:
13" wide x 18.25" high x 1.5" deep

Plink 'n Swing Target package, Handgun:
9.5" wide x 24.5" high x 1.75" deep



Shooting spots are included with Resetting Targets and the Plink n' Swing™ Targets. Should you wish to purchase additional shooting spots, you can find them on page 27.

Comfortable padded
SoftFleece headband

This product has
been CE certified.



2004/108/EC

Durable, soft touch finish



G3 package:
7.3" wide x 8.5" high x 4" deep

Platinum Series™ G3

**Platinum Series™
G3 Electronic Hearing Protection**
#864446 / Case Pack of 1

The new Caldwell Platinum Series G3 earmuffs provide a new level of performance. They offer crystal clear amplification of low level sounds while compressing and blocking out harmful noise. The advanced circuitry delivers constant sound amplification without cutting out, allowing you to hear clearly even as a gun is being fired. The dual microphones deliver true stereo sound improving ability to localize sound. Independent volume adjustment allows for compensation between left and right ears. DualDensity Foam (DDF) Technology delivers 21 NRR to provide a high degree of passive sound protection from gunfire and other loud noise. Headband is padded and lined with SoftFleece fabric to remain comfortable during extended use. Run time approximately 250 hours. Dual LED lights indicate power on status. Battery compartments in each earcup are easily accessible and hold 3 AAA batteries each (not included). Low profile design and durable soft touch finish helps protect against gunstock contact. Compact, collapsible design allows for convenient storage and transport.

- Advanced no "cut out" circuitry delivers unsurpassed performance
- True stereo amplification delivers maximum volume and clarity
- Significantly enhances hearing while protecting at the same time
- DualDensity Foam (DDF) Technology delivers 21 NRR
- Padded SoftFleece headband for maximum comfort
- Compact, collapsible low profile design and soft touch finish
- Extended runtime of 250 hours with power on LED indicator



E-MAX™

E-MAX® Electronic Hearing Protection

#497700 / Case Pack of 6

Standard profile E-Max™ hearing protection combines great circuitry with a standard earcup for better protection. The two microphones in the E-Max™ amplify sounds below 85 decibels, which includes normal communication, range commands, and environmental sounds. Above 85 decibels, the microphones instantly shut off to protect the shooter's hearing. Two microphones - one in each cup - give the user true stereo sound and allow the user to identify the directional source of a sound. Runs on 2 AAA batteries (not included). 25 NRR.



Both E-MAX packages: 9" wide x 10" high x 4" deep



E-MAX™ Low Profile

E-MAX® Low Profile Electronic Hearing Protection

#487557 / Case Pack of 6

The new low-profile E-Max™ hearing protection combines great circuitry with a low profile earcup that's ideal for shotgun shooters and action shooters. The two microphones in the E-Max™ amplify sounds below 85 decibels, which includes normal communication, range commands, and environmental sounds. Above 85 decibels, the microphones instantly shut off to protect the shooter's hearing. Two microphones - one in each cup - give the user true stereo sound and allow the user to identify the directional source of a sound. Runs on 2 AAA batteries (not included). 23 NRR.



Eyes & Ears Belt Clip / #417600 / Case Pack of 6

The Caldwell Eyes and Ears Belt Clip offers shooters a secure, convenient location to store both eye and ear protection when not in use. Ideal for on the range, at the clay stand or in the field, the Eyes and Ears Belt Clip puts an end to the old question of where did those glasses or ear muffs go? Constructed of durable, flexible polymer, the Eyes and Ears Belt Clip will survive years of use. Accepts belts up to 2 1/4" inches wide, and hearing protection with bands up to 2 inches wide.

- Conveniently holds your hearing protection, safety glasses & keys
- Fits up to a 2 1/4" wide belt
- Material bends but won't break



**NEW FOR
2011
TWENTY**

Belt Clip package:
3" wide x 6.75" high x 1" deep

If there were a Gunstock Hall of Fame, Reinhart Fajen would be in the first class of inductees. For over 50 years, the brand name Fajen has meant one thing to custom gun builders-elegant gunstocks produced by an artisan. Fajen stocks are now more available throughout the world than ever, with the same high-degree of craftsmanship and detail.

No other brand of gunstocks has captured the imagination of the world's shooters and hunters quite like Fajen.



10/22 Stock and barrel combos
details available on page 37

Thumbhole Silhouette[®] for Ruger[®] 10/22[®]

The Thumbhole Silhouette is designed with the silhouette shooter in mind. It features a high rollover comb, vertical grip and a specially contoured forend. Its elegant curves are ergonomically designed and add to the beauty of the laminated wood. The Thumbhole Silhouette fits Ruger 10/22s with a .920" heavy barrel. Stock only. Fits 10/22 Long Rifle only, does not fit Ruger 10/22 Magnum. Does not include barrel, action, or scope. Coffee colored finish.

Thumbhole Silhouette Ruger 10/22 Finished Drop-In[†] / #395482 / Case Pack of 1

[†] Right-handed only.





**10/22 Stock and barrel combos
details available on page 37**

Ruger® 10/22® Stocks

Your Ruger 10/22 never looked so good or performed so well! This stock was designed to provide a drop-in fit for your Ruger 10/22 action fitted with a .920" heavy barrel. It features positive checkering on the grip and forearm areas, and is engineered to provide ultimate balance and performance. The Fajen Ruger 10/22 stock is light and durable, and comes with sling swivel studs and non-slip rubber recoil pad installed. Weighs 2 lbs. Fits 10/22 Long Rifle only, does not fit Ruger 10/22 Magnum. Stock only. Does not include action, barrel, or scope. Phantom black finish.

Ruger 10/22 .920" Barrel Channel / #486223 / Case Pack of 1



Mauser 98 Stocks

The Mauser 98 stock from Fajen is the most convenient stock ever made for sporterizing surplus and commercial Mauser 98 rifle actions! Available with two different barrel channels - F34 and F54 - making the stock a drop-in fit with threaded and short-chambered Adams & Bennett Barrels in those contours. There's no barrel channel inletting required. Just drop your barreled action into the stock, tighten the guard screws, and go to the range! Fajen® pioneered the development of stocks that were keyed for a drop-in fit with threaded, short chambered barrels. Military Mausers with the original stepped barrel will fit F34 stocks with removal of the rear sight band and minor fitting. Note: If the original bolt handle has been bent down or replaced, it will be necessary to "rasp-in" a bolt handle notch in the stock. Weighs 2.4 lbs. Stock only. Does not include action, barrel or scope. Phantom black finish.

Mauser 98 F34 Barrel Channel / #429533 / Case Pack of 1

Mauser 98 F54 Barrel Channel / #321565 / Case Pack of 1

Adams & Bennett®

Replacement Rifle Barrels

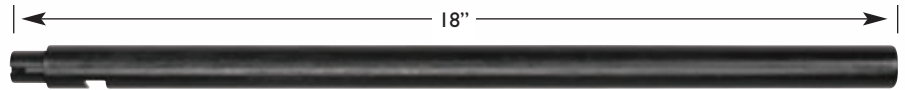

Heavy Match Barrel for Ruger® 10/22®

The Ruger 10/22 is one of the most popular semi-auto 22 rifles of all time, and for good reason. It is lightweight, rugged, dependable and accurate, right out of the box. As good as it is, it also lends itself to do-it-yourself improvement. For those of us who can't help but upgrade, we offer the Adams & Bennett Ruger 10/22 Heavy Match Barrels. These barrels are made from quality barrel steel and are precision reamed and button rifled. The 22 Long Rifle barrels feature a "Bentz" style match chamber, a recessed, target-style crown and are .920" in diameter. All Adams & Bennett Ruger 10/22 barrels are designed for use on scoped rifles. Adams & Bennett Ruger 10/22 barrels are 100% drop-in for stocks with .920" barrel channel inletting. No gunsmithing is required. Shown with Fajen Thumbhole Silhouette stock. Action, scope, and stock not included. These blued barrels are made of 4140 Chrome-moly.

18" 10/22® Long Rifle Blued / #773645 / Case Pack of 1

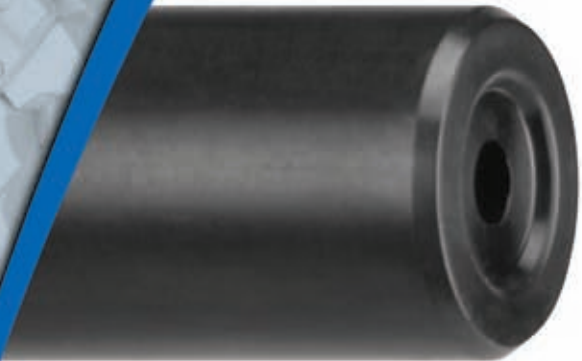

Each barrel features a precision match recessed target crown for maximum accuracy.



1:16 twist match grade rifling with 6 precision lands/grooves.



Extremely tight tolerances and precision manufacturing processes deliver superb accuracy.

36

Easy Installation

Installing a barrel and stock on an existing 10/22 action is very simple and requires no special tools or professional gunsmithing. Full detailed instructions with photos are provided with all of our barrels, stocks and combos. Here is a brief summary of the steps.

Always follow safe gun handling practices. MAKE SURE THE GUN IS UNLOADED.



1) Remove the existing barreled action from the stock.
Simply remove the magazine, remove the takedown screw in the bottom of the stock, remove barrel band if present. The barreled action will lift out.



2) Remove the existing barrel from the action.
Remove the two 5/32" allen bolts that secure barrel to the action with the Barrel Retainer V-Block. Pull the barrel forward out of the action.



3) Install the new barrel.
Clean and lubricate both the inside of the action and the base of the barrel. Insert new barrel, being careful to align the notch for the V-block. Reinstall and tighten the V-block.



4) Reassembly.
Install the newly barreled action into the stock and secure with take down screw.



Combos



Fajen® / Adams & Bennett™ Ruger® 10/22® Synthetic Stock & Barrel Combo

We have combined our Fajen Ruger 10/22 stocks with our Adams & Bennett Ruger 10/22 barrels to bring you both convenience and economy. Dress up your Ruger 10/22 with one affordable package. All the accuracy potential available of our Adams & Bennett barrels combined with the light weight, ruggedness, and great feel of Fajen stocks in one package. All stocks feature a .920" barrel channel for a drop-in fit with the supplied barrel. Fits 10/22 Long Rifle only, does not fit Ruger 10/22 Magnum. Phantom black finish on stock, blued finish on barrel.

Ruger® 10/22® Synthetic Stock & Barrel Combo / #173225 / Case Pack of 1

Ruger 10/22 Synthetic Stock & Barrel Combo
Package: 11" wide x 34" high x 3" deep



Fajen® / Adams & Bennett™ Ruger® 10/22® Wood Stock & Barrel Combos

We have combined our Fajen Ruger 10/22 thumbhole stocks with our Adams & Bennett Ruger 10/22 barrels to bring you both convenience and economy. All the accuracy potential available of our Adams & Bennett barrels combined with the beauty, style, and great feel of Fajen stocks in one attractive, shelf-friendly package. All stocks are finished and feature a .920" barrel channel for a drop-in fit with the supplied barrel. Fits 10/22 Long Rifle only, does not fit Ruger 10/22 Magnum. Coffee colored finish on stock, blued finish on barrel.

Thumbhole Silhouette Stock† & Barrel Combo / #525007 / Case Pack of 1

† Right-handed only.

Ruger 10/22 Wood Stock
& Barrel Combo Package:
11" wide x 34" high x 3" deep



Clean, attractive brass should be the goal of every reloader. Cleaning brass by tumbling is the economical, safe first step in assembling quality handloads. Besides ensuring long life for the most valuable component of your ammunition, cleaning your brass will help reduce wear and tear on your expensive reloading dies, not to mention the chamber of your firearm. Grit and grime from uncleaned brass can become imbedded in the inner surfaces of your sizing dies, scratching and marring every subsequent case. The same grime can be expected to accelerate wear in the chamber and feeding system of your rifle or handgun.



Smallest Tumbler Retail Package on the Market!

Quick-N-EZ Case Tumbler package:
 10.5" wide x 7" high x 10.5" deep

38



(A)



(B)

(C)

PATENTS
 PENDING

This product has been CE certified.

CE
 CE 89/339CEE
 CE 89/686EEC



(G)



(H)



(I)



(J)

QUICK-N-EZ™ CASE TUMBLER

The Frankford Arsenal Case Tumbler provides a quick, easy, and economical means to clean your brass. Used in conjunction with Frankford Arsenal Walnut and Corn Cob Medias, the Quick-N-EZ Case Tumbler removes fouling, lube, and oxidation quickly and conveniently. It will hold up to 600 9mm or 350 223 cases. **Case Pack of 1.**

Case Tumbler (A) / #855020

International Case Tumbler - 220V / #515667



QUICK-N-EZ™ CASE TUMBLER KITS (Pictured above)

Includes Quick-N-EZ Case Tumbler (A), Quick-N-EZ Rotary Media Separator (B), 4 oz Brass Polish (G), 3 lbs Cleaning Media, and Plastic Bucket (C). **Case Pack of 1.**

Case Cleaning Kit (A, B, C & G) / #645880

International Case Cleaning Kit (220v) / #799534

QUICK-N-EZ™ CASE TUMBLER ACCESSORIES

Case Pack of 1.

Extra Bowl for Quick-N-EZ Case Tumbler / #183007

Plastic Bucket / #615520

Lid for Plastic Bucket / #449963

MEDIA SEPARATORS AND KITS Case Pack of 1.

Quick-N-EZ Rotary Separator Kit without Plastic Bucket (B) / #683551

Quick-N-EZ Rotary Separator Kit with Plastic Bucket (B & C) / #507565

Includes Quick-N-EZ Rotary Separator (B) and Plastic Bucket (C).

Quick-N-EZ Standard Separator (J) / #121925

Case Pack of 4. Sits conveniently on top of most 3 1/2 or 5 gallon plastic buckets. Side walls are 4 3/4" in height, giving it the capacity to hold a tumbler full of brass and media. Perforated bottom lets the media fall through, leaving clean brass behind.

CLEANING AND POLISHING SUPPLIES

Corn Cob Media Case Pack of 1.

(Corn polishes better than Walnut)

4.5 lb reusable plastic container (E) / #287178

Treated Corn Cob Media Case Pack of 1.

4.5 lb reusable plastic container (E) / #194524

Walnut Hull Media Case Pack of 1.

(Walnut cleans better than Corn)

5 lb reusable plastic container (D) / #881538

Treated Walnut Hull Media Case Pack of 1.

5 lb reusable plastic container (D) / #347338

Brass Polish Case Pack of 6.

4 oz Bottle (G) / #845677

8 oz Bottle (H) / #887335

32 oz Bottle (I) / #321901

Quick-N-EZ™ Impact Bullet Puller

When you need to pull some bullets, for whatever reason, an impact-style tool is the easiest method. Just one stern "whack" and the bullet is separated from the brass. It is as easy as that. Three different collets are included allowing you to pull bullets from just about every caliber from 22 Hornet to 45-70, whether rimmed or rimless. Versatility like that makes this bullet puller the only one to have. Don't wait until you need it!

Quick-N-EZ Impact Bullet Puller / #836017 / Case Pack of 6

Replacement Aluminum Collet Set for Bullet Puller, Set of 3

#737910 / Case Pack of 6



Quick-N-EZ Bullet Puller package:
6" wide x 14" high x 2" deep



Plastic Ammo Boxes

See-through plastic ammo boxes make storing and identifying your reloaded ammunition a snap. Available in 3 different colors and twelve different sizes to fit most calibers. Our system allows you to get organized and stay organized! Our ammo boxes fit a full variety of calibers, often many more than the description allows for. Please refer to the chart at the left to determine which box is appropriate for your application. **Case Pack of 10.**



Our plastic ammo boxes have a fit guide molded into them that tell you which ammo rounds are compatible with that particular ammo box.

100-ROUND HINGE-TOP BOXES

Box #	Blue	Gray
1001	#688397	#713196
1003	#930447	#185116
1005	#554106	#631312
1007	#912544	#107025
1008	#419448	#515120
1009	#562778	#651533

50-ROUND HINGE-TOP BOXES

Box #	Blue	Gray
501	#114596	#340663
503	#642557	#354668
504	#698582	#441440
505	#690047	#264395
506	#369645	#414965
507	#349962	#398657
508	#718498	#860416
509	#160880	#122804
510	#513329	#450302
511	#162882	#803479
512	#791979	#801326
514	#563412	#118960
515	#296112	#312874

20-ROUND SLIP-TOP BOXES

Box #	Blue	Gray
205	#205111	#205222
209	#533573	#351167
210	#184625	#151242
211	#877991	#227289



	100 Round	50 Round	20 Round	Ammo Vault™
RIFLE				
17 Remington	1005	505	205	
22 Hornet		504		
22 Remington Jet		504		
218 Bee		504		
221 Remington		504		
22 BR		512		
22 PPC		512		
222 Remington	1005	505	205	RMD
223 Remington	1005	505	205	RMD
222 Remington Mag	1005	505	205	RMD
22-250 Remington	1009	509	209	RMD
220 Swift	1009	509	209	RMD
243 Winchester	1009	509	209	RMD
6mm BR		512		RMD
6mm Remington	1009	509	209	RMD
240 Weatherby Mag		210	210	RMD
25-20 WCF	1003	503		
257 Roberts	1009	509	209	RMD
250 Savage	1009	509	209	RMD
25-06 Remington		510	210	RMD
6.5mm Swedish Mauser		510	210	RMD
6.5mm Remington Mag		511	211	RLG
6.8mm SPC		512		RMD
270 Winchester		510	210	RMD
270 Weatherby Mag		511	211	RLG
270 WSM		515		RLG
7x57 Mauser		510	210	RMD
7mm BR	1009	512	209	RMD
7mm SAUM		515		
7mm WSM		515		RLG
7mm-08	1009	509	209	RMD
280 Remington		510	210	RMD
7mm Remington Mag		511	211	RLG
7mm Rem Ultra Mag		511	211	RLG
7mm Remington				
Short Ultra Mag		511	211	RLG
30 M1 Carbine		504		
30 Remington	1009	509	209	RMD
30-30 Winchester	1009	509	209	RMD
300 Savage	1009	509	209	RMD
30-40 Krag		510	210	RLG
308 Winchester	1009	509	209	RMD

	100 Round	50 Round	20 Round	Ammo Vault™
30-06 Springfield		510	210	RMD
300 H&H Mag		511	211	RLG
300 Winchester Mag		511	211	RLG
300 Ultra Mag		511	211	RLG
300 Remington				
Short Ultra Mag		511	211	RLG
300 SAVM		515		
300 WSM		515	211	RLG
300 Weatherby Mag		511	211	RLG
303 British		510	210	RMD
7.62x39mm	1009	512	209	RMD
32-20 WCF	1003	503		
32 Winchester Spl		509	209	RMD
325 WSM		515		RLG
8x57 Mauser		510	210	RMD
8mm Remington Mag		511	211	RLG
338 Winchester Mag		511	211	RLG
338 Lapua Mag		511	211	RLG
340 Weatherby Mag		511	211	RLG
338 Rem Ultra Mag		511	211	RLG
35 Remington	1009	509	209	RMD
350 Remington Mag		511	211	RLG
35 Whelen		510	210	RMD
375 H&H Mag		511	211	RLG
375 Rem Ultra Mag		511	211	RLG
378 Weatherby Mag		511	211	RLG
38-40 WCF		507		
38-56 WCF		514		RLG
38-70 WCF		514		RLG
40-65 WCF		514		RLG
40-65 Ballard		514		
404 Jeffrey		511	211	RLG
405 Winchester		510	210	RLG
416 Taylor		511	211	RLG
416 Rigby		511	211	RLG
444 Marlin	1009	509	209	RLG
45-70 Govt.	1009	514	209	RLG
45-90 WCF		511	211	RLG
45-110 Sharps		511	211	RLG
458 Winchester Mag		511	211	RLG
50-70 Govt.		514		RLG
50 110 WCF		514		RLG

	100 Round	50 Round	20 Round
PISTOL			
25 ACP	1001	501	
32 ACP	1001	501	
32 S&W/32 S&W Long	1003	503	
32 H&R Magnum	1003	503	
380 Auto	1001	501	
9x19mm Luger	1001	501	
9x18 Makarov	1001	501	
38 S&W	1003	503	
38 Special	1003	503	
38 Super	1003	503	
357 Magnum	1003	503	
357 Maximum		505	205
357 Auto Mag		507	
10mm Auto	1008	508	
40 S&W	1008	508	
41 Long Colt	1007	507	
41 Magnum	1007	507	
44 S&W Russian	1007	507	
44 Colt	1007	507	
44 Special	1007	507	
44-40 WCF	1007	507	
44 Magnum	1007	507	
445 Super Mag	1009	509	209
44 Auto Mag	1007	507	
45 S&W Schofield	1007	507	
45 ACP	1008	508	
45 Auto Rim	1008	508	
45 Colt	1007	507	
45 Winchester Magnum	1007	507	
454 Casull	1007	507	
460 S&W		514	
480 Ruger		506	
475 Linebaugh		506	
50 AE		506	
500 Linebaugh		506	
500 S&W			
SHOTGUN			
.410 Gauge 2.5" Shells		509	
.410 Gauge 3" Shells		510	
28 Gauge		514	

Peel & Stick Reloader's Labels

These Peel & Stick Labels help you record all of the important data about your pistol, rifle, or shotgun handloads for future reference and replication. These labels have an adhesive which makes them easy to remove. Works great with plastic ammo boxes.

Pistol & Rifle Reloader's Labels 100 pack / #202364 / Case Pack of 6

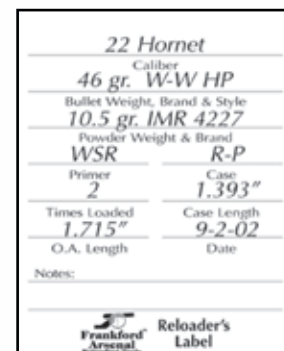



Ammo Vault package:
6.25" wide x 6" high
x 2" deep

Ammo Vault™

The Most Advanced Ammo Storage System Available.

The new Frankford Arsenal Ammo Vault takes ammo storage and transportation to a whole new level. By combining tough, impact resistant materials and an innovative locking design the Ammo Vault offers unsurpassed protection for your rifle cartridges. No more rattling, no more rubber bands, no more cracked and broken boxes. Give your ammunition the protection it deserves. **Two sizes fit nearly all rifle cartridges, see page 41 for fit chart.**

- Securely holds 20 rounds of ammunition
- Locks closed with push button release – locking mechanism keeps lid from coming off even if dropped
- Simply squeeze & pull to unlock the two halves to access your ammo
- Impact-resistant material won't break & protects ammo if dropped
- Highly durable material with overmolded soft-touch top & bottom
- Rubber molded bottom cushions ammo cartridges
- Foam insert holds cartridges securely, prevents rattling & protects bullet tips
- Overall adjustable height accommodates a wide variety of cartridges
- Fit chart on the bottom identifies the most popular cartridges that fit

Ammo Vault™ RMD-20 / #912600 / Case Pack of 4

Ammo Vault™ RLG-20 / #912610 / Case Pack of 4



Adjustable height allows the Ammo Vault to fit a wide range of cartridges.



Yes, that's a truck tire driving over the Ammo Vault. The impact-resistant material won't break & protects ammo.

42



Foam insert holds cartridges securely and prevents rattling

Highly durable material with overmolded soft-touch top and bottom

Rubber molded bottom cushions ammo cartridges

Simply squeeze here to release the two halves to access your ammo

Adjustable height accommodates several different cartridges

Integrated locking mechanism keeps the lid from coming off even if dropped

Molded fit chart on the bottom identifies the most popular cartridges that fit



Simple squeeze & pull operation unlocks the two halves.

DS-750 Digital Scale / #205205 / Case Pack of 1

The Frankford Arsenal DS-750 delivers extreme accuracy for precise measurement of powder, bullets, cases or loaded rounds. With 1/10th grain accuracy you will be able to achieve the maximum potential of your handloads. An integrated clear plastic cover protects the scale during storage and transport. The large, high-contrast backlit display is easy to read. Simple controls allow for easy changes of units, tare weights or counting. Powder pan, carry bag and calibration weight included. The performance and features of this scale make it a great value and will be a welcome addition to your loading bench.

- Capacity: 750 grain (50 gram)
- Accuracy: 0.1 grain (0.01 gram)
- LCD display with blue backlight
- Integrated protective cover
- Carry pouch holds scale, pan and calibration weights
- Auto Calibration
- Measures in: grains, grams, carats and ounces
- Tare Function and Counting Function
- Overload protection
- Auto shutoff after 60 seconds
- Power: 2 AAA batteries (included)

DS-750 package:
4.75" wide x 9.75" high
x 1.75" deep



Kit contents include: The DS-750 Scale with built-in cover, powder tray, calibration weight, batteries and storage case.



Universal Reloading Tray / #393939 / Case Pack of 6

The Universal Reloading Tray is highly versatile. It can be used with a wide variety of rifle cartridges from .17 caliber up to .458 caliber. Also works well for handgun cartridges 9 mm to 500 S&W. 50 round capacity. Conveniently holds brass during different stages of reloading process.

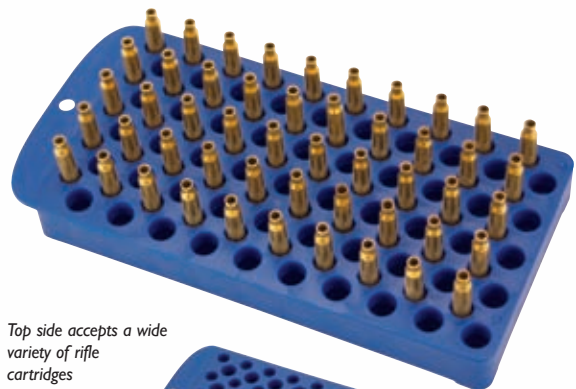

Top side accepts a wide variety of rifle cartridges from .17 to .458 caliber and several various sizes of handgun brass such as 38 Special, 357 Magnum, 40 S&W, and 500 S&W.

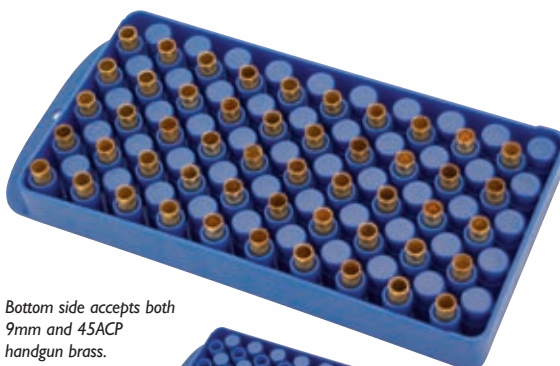

Bottom side accepts both 9mm and 45ACP handgun brass.

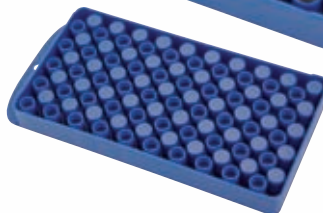

Unique stepped cavity accommodates several different brass cartridges in the same hole

Universal Reloading Tray package:
5.5" wide x 11.25" high x 1.25" deep



Perfect-Fit Reloading Trays

Frankford Arsenal Perfect-Fit Trays are sized for individual calibers or a family of calibers for a precise fit. Perfect-Fit trays are an essential tool for reloading efficiency and organization.

Twelve tray sizes are available for 25 ACP through 500 Nitro. Each tray holds 50 cases (tray number 9 holds 45). A lip around the outside edge provides a sure grip on the tray. **Case Pack of 1.**

Product #	Tray #	Hole Diameter	Hole Depth	Product #	Tray #	Hole Diameter	Hole Depth
#335196	1	0.31	0.3	#844786	5	0.486	0.65
#695795	2	0.375	0.595	#153092	5s	0.486	0.4
#292930	2s	0.375	0.3	#713498	6	0.53	0.65
#824257	3	0.401	0.4	#663641	7	0.56	0.65
#163246	4	0.44	0.625	#290487	8	0.615	0.65
#853739	4s	0.44	0.4	#250083	9	0.665	0.65

Caliber	Tray #	Caliber	Tray #	Caliber	Tray #	Caliber	Tray #	Caliber	Tray #
Rifle		7x57 Mauser	5	32 Winchester Spl	6	458 Winchester Mag	7	44 Special/Magnum	6
17 Remington	2	284 Winchester	6	8x57 Mauser	5	460 Weatherby Mag	8	44-40 WCF	6
22 Hornet	2	280 Remington	5	8mm Remington Mag	7	470 Nitro	9	445 Super Mag	6
218 Bee	4s	7mm Remington Mag	7	33 WCF	8	50-70 Government	9	45 ACP	5s
221 Remington	2	7mm Weatherby Mag	7	338 Winchester Mag	7	500 Nitro	9	45 Colt	6
222 Remington	2	7mm WSM	7	338 Ultra Mag	7			454 Casull	6
223 Remington	2	7mm Remington Ultra Mag	7	348 Winchester	8	Pistol		45 Auto Rim	6
22-250 Remington	5	30 M1 Carbine	2	35 Remington	5	25 ACP	1	45 Winchester Mag	5
220 Swift	5	30 Remington	4	35 Whelen	5	32 ACP	2s	480 Ruger	7
6mm PPC	4	30-30 Winchester	6	375 Winchester	6	32 S&W/S&W Long	2s	475 Linebaugh	8
243 Winchester	5	300 Savage	5	375 H&H Mag	7	32 Colt	2s	50 AE	7
6mm/244 Remington	5	30-40 Krag	7	378 Weatherby Mag	8	32 H&R Mag	2s		
25-20 WCF	4s	308 Winchester	5	38-55 WCF	6	380 Auto	2s		
257 Roberts	5	30-06 Springfield	5	38-56 WCF	8	9x19mm Luger	3		
250 Savage	5	300 WSM	7	40-65 WCF	8	9x18 Makarov	3		
25-06 Remington	5	300 H&H	7	40-82 WCF	8	38 S&W	4s		
6.5x55mm		300 Winchester Mag	7	405 Winchester	7	357 Sig	4s		
Swedish Mauser	5	300 Ultra Mag	7	416 Remington Mag	7	38 Super	4s		
264 Winchester Mag	7	300 Weatherby Mag	7	416 Weatherby Mag	8	38 Special	4		
270 Winchester	5	303 British	7	44-40 WCF	6	357 Magnum	4		
270 WSM	7	7.62x39	4	444 Marlin	6	38-40 WCF	6		
7mm BR	5	7.62x54R Russian	8	45-70 Government	8	40 S&W	4s		
7mm-08	5	32-20 WCF	4s	450 Marlin	7	10mm Auto	4s		
		32-40 WCF	6	45 Sharps	8	41 Magnum	6		



Powder Funnel Kit

#832516 / Case Pack of 4

Sixteen quick-change, caliber specific nozzles, 17-45 caliber, to minimize powder spillage. Also includes large funnel and extension tube. Packaged in a plastic case with marked cavities.

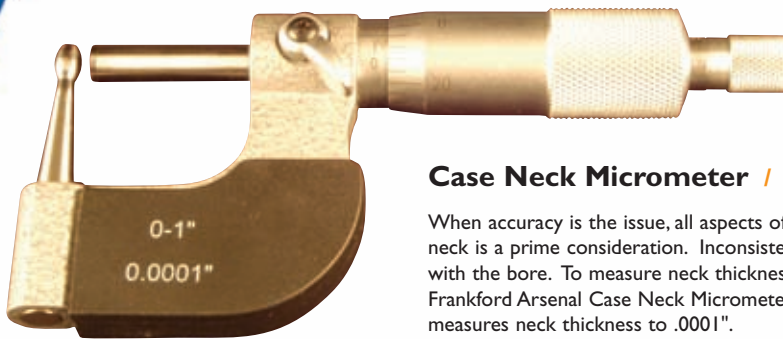

Case Neck Micrometer / #107083 / Case Pack of 1

When accuracy is the issue, all aspects of the cartridge case must be considered. Concentricity of the case neck is a prime consideration. Inconsistent neck wall thickness will cause the seated bullet to be misaligned with the bore. To measure neck thickness, you need a measuring tool designed specifically for this task. The Frankford Arsenal Case Neck Micrometer measures neck thickness to .0001".

44



Electronic Calipers
clamshell package:
8" wide x 12.25" high
x .75" deep

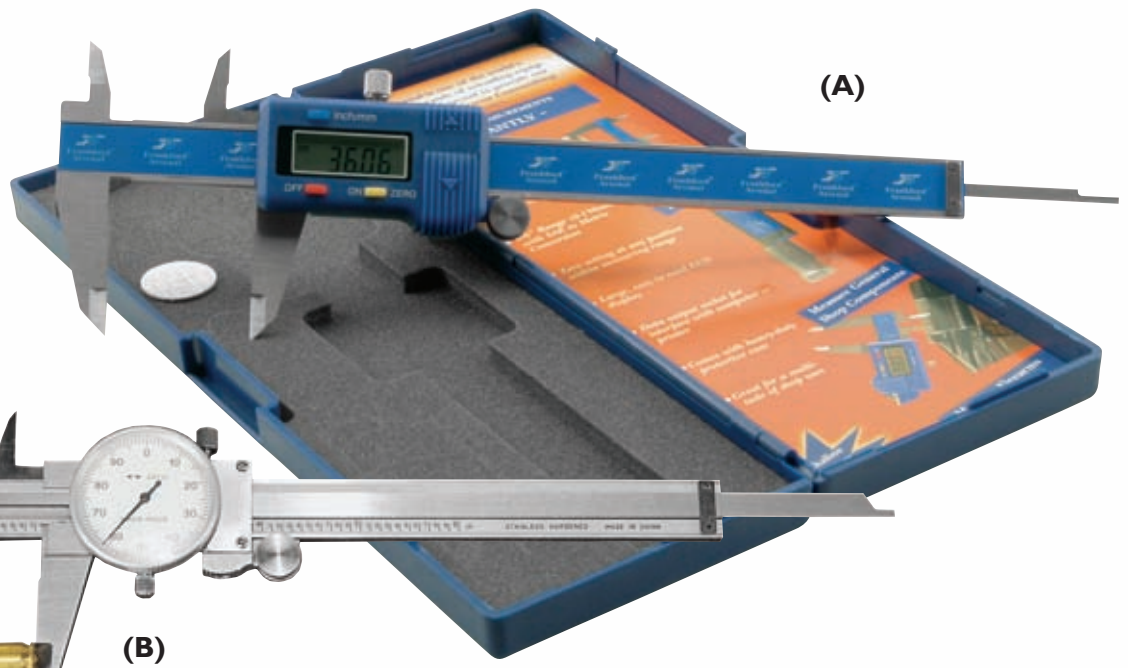

Calipers

Reloading ammunition requires attention to many critical cartridge dimensions, including case length, neck and base diameters, overall length, primer pocket depth, etc. Verifying these dimensions is quick and convenient with the Frankford Arsenal Calipers. The calipers are accurate to within .001". The calipers allow you to measure inside and outside diameters, plus depths. You will find them useful for many measuring tasks on and off the reloading bench. Packaged in a convenient, protective case.

Electronic Calipers (A) / #672060 / Case Pack of 1

Stainless Steel Dial Caliper (B) / #516503 / Case Pack of 1

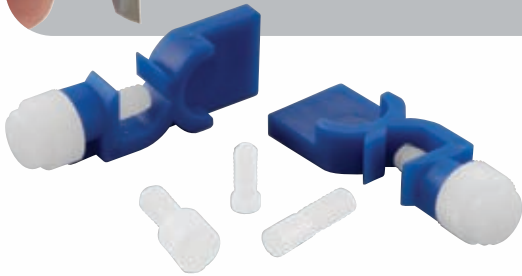
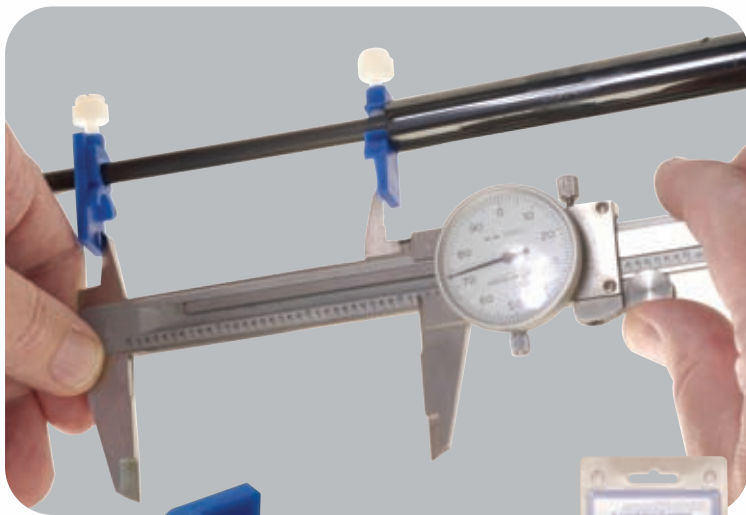

Clamshell package:
4" wide x 7.8" high x .8" deep

Cartridge Overall Length Gauge

#965887 / Case Pack of 6

If you have a cleaning rod and a set of calipers, you can now determine the optimum OAL for any bullet in less than two minutes. This simple kit consists of two clamps that easily attach to any cleaning rod, 1/4" in diameter, or less. Simply install the appropriate size tip on the end of your cleaning rod, insert the cleaning rod to the bolt face, install one clamp, remove the bolt and drop in a bullet (projectile only) into the chamber. Hold the bullet against the rifling with a pencil, touch the bullet tip with the cleaning rod tip and install the other clamp. Now measure the inside distance between the two clamps with a calipers and record, or use as a gauge to check the seating depth set-up during your reloading sequence. Works on all rifles. Complete instructions are included.



Reloading Stand

Mount a press, a powder measure, a trimmer, or almost any reloading tool on this portable reloading stand. The removable 9" x 9" top plate can be drilled for a variety of applications (templates for popular presses included) and the two side bins will hold components or tools to suit the task. The Reloading Stand features an aluminum top and center stand with a hollow plastic base. Overall height is 26.5". **Case Pack of 1.**

Portable Reloading Stand / #155024

Extra Top Plate for Reloading Stand / #188071

Spare Bin for Reloading Stand / #525752

Case Neck Lubricator

Using fine powdered mica to lubricate the inside of the case mouth is faster and more convenient than using a liquid lubricant. After the body of the case has been lubricated, simply dip the case mouth in the mica, run it over the brush, and it is ready for the sizing die. Includes 1/10th oz of fine powdered mica. **Case Pack of 1.**



Case Neck Lubricator / #132530

Replacement Brushes for Case Neck Lubricator / #795118
(6 brush set)

Fine Powdered Mica 1/10th oz. packet / #595942

Fine Powdered Mica 4 oz jar / #757780

Case Lubricants

This convenient, fast-drying liquid provides quick lubrication of the case body before resizing.

Case Lubricant, 8 oz Spray Pump

#460478 / Case Pack of 12



Drop Out / #763758 / Case Pack of 6

The modern way to "smoke" your bullet molds. Applied to the cavities of a cold, clean bullet mold, Frankford Arsenal Drop Out literally allows the just-cast bullets to "drop-out" with no tapping or pounding. 6 oz aerosol.

CleanCast Lead Fluxing Compound

#441888 / Case Pack of 6

Lead fluxing made easy. No more using rosin, paraffin, tallow, bullet lube, and other homemade concoctions. CleanCast is non-smoking, odor-free, and it really works. Only a small amount is necessary to prepare even a 20 pound lead pot for bullet production. Separates dross from your valuable bullet alloy and improves the consistency of the melted lead to eliminate variability during your casting session.



LOCKDOWN™

LOCKDOWN is the most comprehensive line of vault accessories available today. A wide variety of items designed to enhance organization, control climate and generally improve the usability of your vault have all come together under this exciting new brand. The vision behind LOCKDOWN is to significantly enhance the organization and accessibility of items inside any vault and to ensure their condition is preserved. A commitment to high quality, innovative products sets LOCKDOWN apart from the competition.

46



Get the most out of your vault with
LOCKDOWN solutions.

Vault Lighting Kit / #222020 / Case Pack of 4

The LOCKDOWN Vault Lighting Kit can be easily installed in any vault and is designed to provide illumination throughout the entire interior. The flexible rope design can be routed to provide superior light coverage, regardless of shelf configuration inside the vault. The kit includes a 12' section of super-bright white LED lights housed in a durable clear tube, along with a 6' power cord and in-line on/off switch. A quick install plug allows the power cord to be easily routed through the vault wall. Mounting clips and screws provided.



Clamshell package:
8.125" wide x 8.625" high x
3.5" deep

- LED Rope Light is durable and extremely bright
- Provides maximum illumination throughout entire vault
- Simple to install, mounting hardware included
- Power cord with ON / OFF switch and easy-install plug



Easy-Install Electrical Plug

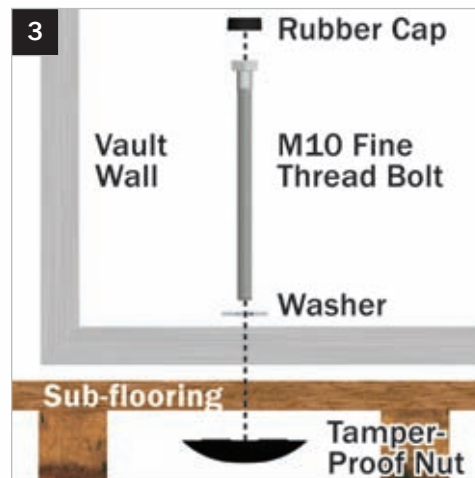
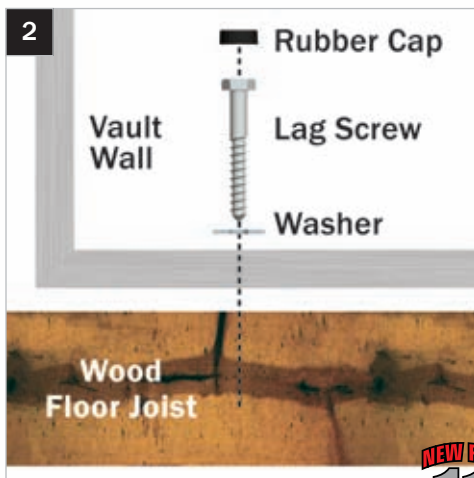
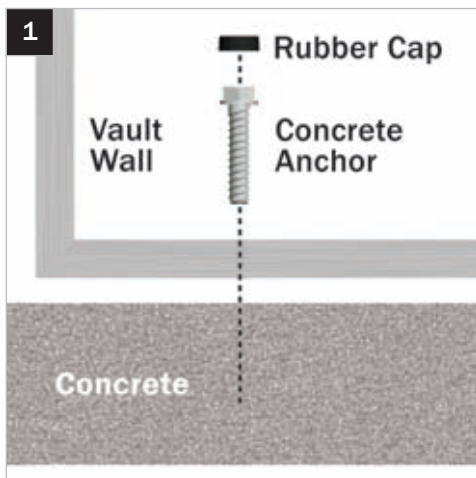

Vault Anchor Kit / #222160 / Case Pack of 3

The first kit of its kind to offer all components necessary to anchor a vault in any location. Three separate structural applications are covered: 1) a concrete floor / wall, 2) a wood floor joist/stud, or 3) sub-flooring.

- Securely anchors your vault so thieves can't steal it
- Includes all hardware and drill bits for anchoring vault to concrete, floor joists/studs, or sub-flooring. Heavy-duty components are easy-to-install
- Kit contains (1) Pilot Hole Drill Bit, (1) Combo Drill Bit, (1) Masonry Drill Bit, (4) Concrete Anchors, (4) Lag Screws, (4) M10 Fine Thread Bolts, (4) Washers, (4) Tamper-Proof Nuts, and (4) Rubber Caps

NEW FOR
20
11
20



Clamshell package:
9.125" wide x
13.25" high x
1" deep



Dehumidifier Rod installs horizontally at the lowest point in a gun safe.



**NEW FOR
11
TWENTY**

18" Rod dimensions:
18.25" w x 1.25" h x 2.5" d



12" Rod dimensions:
12.25" w x 1.25" h x 2.5" d

Dehumidifier Rods

The LOCKDOWN Dehumidifier Rods work by slightly increasing and maintaining the air temperature inside the gun safe or other enclosure. This allows the warm air to circulate throughout the safe on a continual basis, thus eliminating humidity, mildew, and condensation. All of which are dangerous to your expensive firearm collection.

- Removes moisture from gun safe interior
- Dries approx. 100 cubic ft. (12") or 200 cubic ft. (18")
- Protects firearm investment
- Mounting brackets included
- Easy install quick plug attachment, 110v
- Guards against rust

12" Dehumidifier Rod (12" 8 Watt 100 cu ft.) / #222000 / Case Pack of 4

18" Dehumidifier Rod (18" 12 Watt 200 cu ft.) / #222010 / Case Pack of 4

12" Rod clamshell package:
5.125" wide x 18.125" high x 1" deep

18" Rod clamshell package:
5.125" wide x 24.25" high x 1" deep



Hygrometer / #222111 / Case Pack of 1

Managing humidity is critical to protecting and preserving the condition of your firearms. The LOCKDOWN Hygrometer provides accurate relative humidity readings at a glance. Excessive moisture in a vault or storage area can cause rapid corrosion and pitting on metal surfaces. It is important to monitor and control the relative humidity in your storage area to be sure your guns are properly protected.

- Mounts easily with included fastener and/or hook & loop
- Large easy to read numbers
- 2 3/4" diameter



Clamshell package:
4.25" wide x 7.25" high x 1.25" deep



**NEW FOR
11
TWENTY**



Controlling Humidity: Don't Let Your Guns End Up Like This

Humidity control is an essential factor in storing and protecting firearms. Don't expose your valuable firearms to the damaging effects of humidity, moisture and condensation. Maintaining consistent humidity and temperature is very important because fluctuations in either can lead to condensation and corrosion. Extremely low humidity levels can potentially pull too much moisture from wood stocks leading to small cracks. 50% relative humidity and



Silica Can dimensions:
4.25" w x 5.75" h x 4.25" d



Silica Bag dimensions:
8" w x 5.5" h x 1.5" d



Silica Gel Can 750 gram package:
6.5" wide x 4.5" high x 4.5" deep



Silica Gel Bag 450 gram package:
4.5" wide x 6.5" high x 2" deep

Silica Gel

LOCKDOWN Silica absorbs moisture from the air inside a vault or storage area preventing condensation, mildew and rust from damaging valuable firearms. Crystals change color once fully saturated and can be easily recharged in the oven.

- Absorbs moisture from the air
- Easily recharged in oven
- Durable vented can provides protection for up to 57 cubic feet
- Breathable bag provides protection for up to 33 cubic feet



Silica Gel Can, 750 grams / #222178 / Case Pack of 4

Silica Gel Bag, 450 grams / #222179 / Case Pack of 8



Recharging Silica: The silica beads are a light orange color when recharged. They will turn to a darker green color as they absorb moisture. The silica will continue to absorb moisture after they have changed color. Generally, the silica will protect 57 cubic feet (for the Silica Can) and 33 cubic feet (for the Silica Bag) for about 3 to 6 months in normal conditions before recharging is required. Simply use an oven and the instructions on the package to recharge the Silica Gel.

Fully Recharged



Needs Recharged



Clamshell package:
8.125" wide x 8.125" high x 2.875" deep



Firearm Wipe Down Kit / #222162 / Case Pack of 3

Even with properly controlled humidity in a vault, metal surfaces on firearms can be damaged by salts and acids transferred from the skin during handling. The Wipedown Kit comes with a silicone impregnated cloth, a bottle of protecting oil and a small oil application brush. The molded housing hangs conveniently inside or outside any vault and keeps the supplies within reach when you need them.

- Protect the finish of your guns by wiping off fingerprints before storage
- Keeps oil, brush, & silicone cloth handy
- Universal Attachment System includes hooks for carpeted interiors & magnets for metal interiors



Product dimensions:
6.5" w x 4" h x 2.5" d

70 degrees F is considered ideal storage conditions for firearms. Choose a humidity control product and monitoring system that best suits your application.





Large Document Holder / #222166 / Case Pack of 3

Where do you keep your important documents like your college degree, your marriage license, or your living will? Chances are, they aren't in your safe. Even if they are in your safe, they are probably thrown on a shelf with no apparent organization. What you need is a Large Document Holder that can hold up to 500 letter-size pages of your most important documents, all while utilizing vault space that you didn't use before.

- Keeps important documents organized & secure
- Universal Attachment System includes hooks for carpeted interiors & magnets for metal interiors
- Mounts to inside of vault door
- Holds documents up to 10" x 12.5"
- Removable divider

Back of Large Document Holder with Vampire Clips installed.



Clamshell package:
14.625" wide x 11.625" high x 3.5" deep

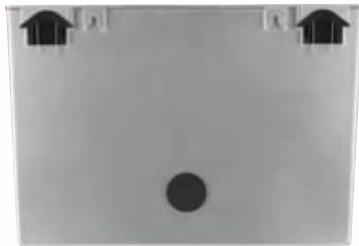

Large Document Holder dimensions:
13.5" w x 9" h x 3" d

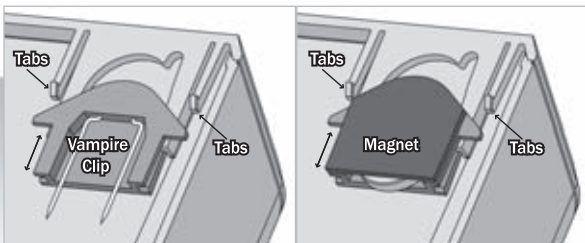

Hanging Organizers Featuring the Universal Attachment System

LOCKDOWN accessories feature a unique Universal Attachment System for easy installation in any vault. All hanging accessories come with both Vampire Clip style inserts for use with carpeted interior vaults as well as High-Strength Magnet inserts for bare metal interiors. The interchangeable inserts can quickly be removed and installed for any particular application. These same inserts are compatible with and are

Product dimensions:
6.5" w x 4" h x 2.5" d



Clamshell package:
8.125" wide x 8.125" high x 2.875" deep

NEW FOR
11
TWENTY



There are hundreds of uses for the Small Document Holder, like storing CDs & DVDs that contain important computer file backups or photos of possessions for insurance purposes. It's also perfect for small electronics, large jewelry, treasured sporting event tickets and so much more.

Small Document Holder / #222164 / Case Pack of 3

Exactly like the Large Document Holder except sized for smaller documents. Can also be used for jewelry and other small collectibles.

- Perfect for organizing & protecting car titles, passports, & other identification
- Universal Attachment System includes hooks for carpeted interiors & magnets for metal interiors
- Mounts to inside of vault door
- Holds documents up to 6" x 6"
- Removable dividers

Product dimensions: 6" w x 3" h x 1.5" d



Clamshell package:
7" wide x 7.5" high x 1.75" deep

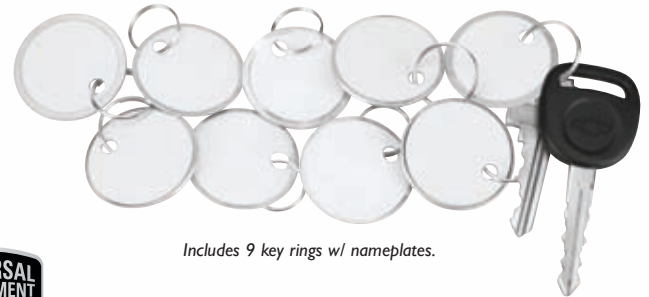

Includes 9 key rings w/ nameplates.

NEW FOR
11
TWENTY

Key Rack / #222188 / Case Pack of 5

The Key Rack is an essential accessory for any vault. No more searching through that drawer full of unlabeled keys and trying to find the one you need. Keep all your important spare keys neatly organized and secure inside your vault. The included key ring nameplates make labeling and identification easy.

- Protect & organize all of your keys
- Universal Attachment System includes hooks for carpeted interiors & magnets for metal interiors
- Mounts to inside of vault door
- Includes 9 key rings with nameplates

included on the molded organizers as well as the fabric hanging organizers. The Vampire Clips incorporate a strong steel wire with two sharp points designed to penetrate fabric or carpeted liners and lock into place. The Magnet inserts utilize very powerful rare-earth magnetic disks which are rubber coated to protect painted surfaces and prevent slipping.





Large Hanging Organizer / #222168 / Case Pack of 5

The Large Hanging Organizer is perfect for organizing all the loose items that tend to clutter the shelves of a vault. With a variety of pocket sizes and configurations it will easily hold handguns, knives, electronics, jewelry or a just about any other small valuables. The three larger pockets feature zippers that can be opened to allow a handgun barrel to protrude through or closed to contain smaller items. A rigid back panel adds support to the organizer. Mesh pockets make it easy to see contents.

- Secure & organize small valuables, handguns, knives, etc.
- Universal Attachment System includes hooks for carpeted interiors & magnets for metal interiors
- Mounts to inside of vault door
- 6 pockets with elastic band and durable mesh fabric

NEW FOR
11
TWENTY

UNIVERSAL
ATTACHMENT
SYSTEM



Zippered pockets allow longer items like handguns to pass through while allowing the user to secure the zipper when storing items like small electronic devices, knives or jewelry.



Clamshell package:
8.5" wide x 14.5" high x 1.875" deep



Large Document Holder dimensions:
13.5" w x 9" h x 3" d

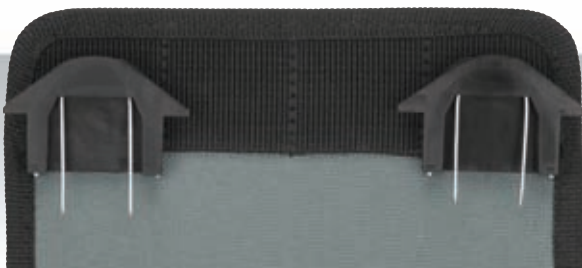

UNIVERSAL
ATTACHMENT
SYSTEM

Hanging Organizers Featuring the Universal Attachment System

LOCKDOWN accessories feature a unique Universal Attachment System for easy installation in any vault. All hanging accessories come with both Vampire Clip style inserts for use with carpeted interior vaults as well as High-Strength Magnet inserts for bare metal interiors. The interchangeable inserts can quickly be removed and installed for any particular application. These same inserts are compatible with and are



**NEW FOR
11
TWENTY**

**UNIVERSAL
ATTACHMENT
SYSTEM**



Also works for small electronics, large jewelry, treasured sporting event tickets, CD & DVD jewel cases and so much more.

Product dimensions:
8.25" w x 6" h x .75" d



Clamshell package:
8.9375" wide x 8.125" high x 1.125" deep

Small Hanging Organizer / #222170 / Case Pack of 5

The compact size of the Small Hanging Organizer allows it to be easily added to small spaces in any vault. A mesh pocket with elastic band keeps small valuables secure and easy to access. Add multiple Small Hanging Organizers for additional storage.

- Secure and organize a variety of small valuables, personal documentation or even vehicle titles
- Universal Attachment System includes hooks for carpeted interiors & magnets for metal interiors
- Elastic band keeps items secure
- Mesh pocket allows visibility of small items



**UNIVERSAL
ATTACHMENT
SYSTEM**



Fits most handguns from compact to large-frame

Product dimensions:
8.6" w x 5" h x .75" d



Clamshell package:
7.125" wide x 7" high x 1.125" deep

Handgun Hanger / #222172 / Case Pack of 5

This universal Handgun Hanger will hold a variety of pistols or revolvers. The wedge shape with open bottom allows the barrel to protrude through. Elastic bands and a rigid back panel provide the structure to hold guns securely in place.

- Universal Attachment System includes hooks for carpeted interiors & magnets for metal interiors
- Mounts to inside of vault door & holds handgun securely
- Fits most compact, medium-frame & large-frame handguns

**NEW FOR
11
TWENTY**

included on the molded organizers as well as the fabric hanging organizers. The Vampire Clips incorporate a strong steel wire with two sharp points designed to penetrate fabric or carpeted liners and lock into place. The Magnet inserts utilize very powerful rare-earth magnetic disks which are rubber coated to protect painted surfaces and prevent slipping.

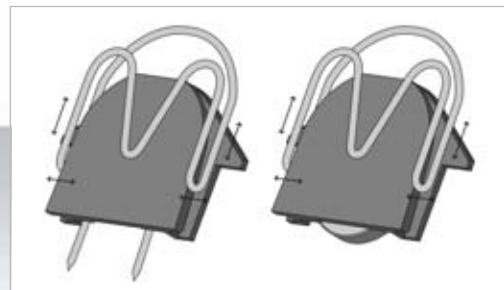

LOCKDOWN™

NEW FOR
11
TWENTY



Clamshell package:
11.5" wide x 7" high x 3.625" deep



Magnetic Barrel Rest / #222177 / Case Pack of 4

Accessing a gun deep in the back of a vault can be challenging. Rather than juggling an armful of long guns, deploy the Lockdown Magnetic Barrel Rest. It conveniently secures to the outside of any vault and provides a perfect staging location. Overmolded contact points protect your gun's finish.

- Serves as an extra hand when moving guns in and out of vault
- Holds 3 guns securely when leaned against vault
- Overmolded rubber contact points to protect firearm finish
- Secures to vault with strong magnets
- Rubber-backed magnets protect vault's finish



Back view of product
showing magnets



Product dimensions: 10.25" w x 3" h x 3" d

54

NEW FOR
11
TWENTY



Clamshell package:
17" wide x 16" high x 3.75" deep

Product dimensions:
14" w x 14" h x 4" d



Vault Drawer / #222155 / Case Pack of 3

Vault space is always a premium! With limited shelf space, try using this Vault Drawer which mounts to the underside of any shelf. It provides 11.5" w x 12" d x 2" h worth of previously unused space. Perfect for a variety of loose valuables and documents. The wire form frame slides over any shelf up to 1" thick. The frame's retaining bar butts up against the tray's molded lip to keep the user from pulling the drawer out too far and spilling its contents.

- Quickly attaches to any vault shelf
- Takes advantage of unused space under shelves
- Organizes jewelry, handguns, small valuables, etc.
- No tools needed to install

View of the wire frame underside
when installed over a shelf.





4 Gun dimensions:
9.5" w x 5.25" h x 6.5" d

**NEW FOR
11
TWENTY**



6 Gun dimensions:
14.25" w x 5.25" h x 6.5" d



Overhead view of handgun channels.

Handgun Racks

These vinyl coated metal handgun racks are extremely handy for use in your gun vault or at the shooting range to provide a safe place to rest your handguns. The individual channels are specially designed to cradle the grip and barrel of the gun and are wide enough to accommodate most wide body pistols or magnum revolvers.

- Holds 4 or 6 handguns (pistols and/or revolvers)
- Free up room in your gun safe or cabinet
- Vinyl coating won't scratch or mar handgun's finish
- Use at range to hold handguns while not in use

4 Gun Handgun Rack / #222200 / Case Pack of 6

6 Gun Handgun Rack / #222210 / Case Pack of 6



Handgun Security Vaults

Lockdown Handgun Security Vaults provide a secure storage solution for handguns and other valuables at home, in the car or when traveling. Designed to provide an additional level of security for conceal carry permit holders. Durable 18 gauge steel construction with extra heavy 12 gauge reinforced side and bottom plate allows these vaults to be secured to any flat surface with the included mounting hardware. A heavy duty 43", 1500lb steel cable is included and allows the vaults to be secured to a stationary object or the internal frame of a piece of luggage. Available in two sizes to accommodate most handguns.

- Perfect for securing handgun in a vehicle or nightstand
- Meets TSA airline guidelines
- 18 gauge walls with an additional 12 gauge side and bottom reinforcement plate
- Compact size fits most compact revolvers and autos
- Large size fits most full size autos and revolvers with barrels up to 4"

Large Handgun Vault / #222144 / Case Pack of 6

Compact Handgun Vault / #222133 / Case Pack of 6



Large package: 11" wide x 9.5" high x 1" deep

Compact package: 9.5" wide x 7.5" high x 1" deep

**NEW FOR
11
TWENTY**

Pre-drilled mounting holes inside vault



Over-Vault Display

The LOCKDOWN two-sided vault display is the perfect merchandising solution for the Vault Accessory category. Gain display space without sacrificing current floor or shelf space. With its heavy duty all steel construction and high definition graphics it looks great on the sales floor. All contact points are vinyl coated or felt padded to provide complete protection for display vault's finish. The adjustable, patent pending, saddle frame fits vaults from 28" to 44" wide. At 24" front to back and 46" high it accommodates the entire family of LOCKDOWN accessories. Contact Battenfeld Technologies Inc. for more information.

Patent Pending.

- Turns previously unused space into prime retail selling space
- Groups innovative accessory products with their intended use in gun vaults
- All contact points are vinyl coated or felt padded to protect the vault's finish

**NEW FOR
11
TWENTY**



Kit Includes:
 Heavy Duty Finish Remover,
 Industrial Grade Sand Paper,
 Stock Sealer, Wood Filler, Walnut
 Stain, Classic Oil Finish, Pumice &
 Rottenstone, Synthetic Steel Wool,
 Instructional DVD

Advanced Stock Re-Finish Kit Formula #5

Refinishing a gunstock can be a satisfying and rewarding experience. Removing the years of wear or neglect and replacing them with a beautiful, durable finish with your own hands provides a deep sense of fulfillment, and may increase the value of your favorite firearm. The Miles Gilbert Gunstock Re-Finish Kit matches the very finest finishing materials and supplies with an easy to follow, professionally produced instructional DVD to allow even the first-time user the opportunity to produce a masterpiece. Formula #5 Classic American Oil Finish is the absolute top of the line hand-applied oil finish for walnut gunstocks. It creates a tough, protective, yet attractive appearance that includes options for low, medium or high gloss. We recommend this kit for all hunting and target guns. Kit includes finish remover, sandpaper, sealer, filler with stain, finish and polishing compounds, and the instructional DVD.

Stock Re-Finishing Kit / #139021 / Case Pack of 4
Finish Remover / #618231 / Case Pack of 4

*Advanced Stock Re-finish Kit:
 5.5" wide x 9" high x 2" deep*



Remove Old Finish



Sand



Seal



Fill



Finish



Magnifier / #639552 / Case Pack of 6.

Perfect for checkering, inletting, action work, assembly, or any projects requiring close observation. Two magnification levels, 1.8X or 2.3X. Accessory loupe for really close inspection comes standard. Adjustable padded head strap. You can use with or without prescription glasses.



Bedrock Epoxy-Bedding Kit:
4.5" wide x 9" high x 2" deep



Bedrock™ Epoxy-Bedding Kit / #190274 / Case Pack of 4

Miles Gilbert Bedrock is the choice to unlock the accuracy potential of your rifle. A rifle's accuracy is dependent on the fit of its barreled action to its stock. Bedrock makes your rifle's stock and metal components fit together to eliminate shift and pressure points caused by recoil and changes in temperature and humidity. Removing the contact points of the stock where the barreled action meets, and replacing them with Bedrock assures you of a perfect, stress-free fit. The stock and barreled action becomes a unit, not just two components fitting arbitrarily together. Ideal for wood, laminated, and synthetic stocks, the Bedrock Kit contains all the necessary components to achieve the perfect fit: 2 oz each of Resin and Hardener, Release Agent with two applicators, Measuring Spoons and Mixing Cups, brown and black dyes, Microballoons for customizing the viscosity, modeling clay, surgical tubing, and the most comprehensive, illustrated instructions ever offered to take you from start to finish with your bedding project. With a 24-hour cure, you're only a day away from a perfect fit and a more accurate rifle.

For use with wood or synthetic stocks, 30 minute working time, 24-Hour Full Cure. Volume: approximately 1.5 cups.

Kit Includes:

- 4 oz Bedrock (2oz resin, 2oz hardener)
- Brown & Black dye for wood or synthetic gunstocks
- 2 fl oz Microballoons
- 3 Mixing Cups
- 3 Mixing/Applicator Sticks
- Release Agent
- 2 Release Agent Applicators
- Modeling Clay
- Surgical Tubing
- Illustrated Instruction Booklet



Recoil Pad Installation Fixture / #184528 / Case Pack of 6

Accurately transfers the toe-line angle and the comb line from the stock to the new recoil pad; also serves as a stable work holding fixture for off-the-stock sanding of the pad. Designed for use with any table-mounted belt or disc sander. Rigid, cast aluminum base and aluminum pad mounting bar.

Inletting Black / #169996 / Case Pack of 10

Apply Inletting Black to the metal components of your rifle and place into the stock. Contact transfers color to the wood, indicating where relief is needed. 1 oz bottle contains enough product to inlet dozens of firearms.





The PAST product line is based on a high-performance foam material that dramatically reduces the felt recoil of rifles, shotguns, and handguns. This foam pad absorbs and spreads the recoil impulse, significantly reducing the recoil felt by the shooter. Other styles of recoil protection tend to bounce into your shoulder, which can create an unstable feeling while offering inadequate protection. The PAST recoil protection system allows a shooter to concentrate on hitting the target instead of fearing the punishment of recoil. Concentration helps to create good shooting habits, and more importantly, prevents developing bad ones.

The World's Most Popular Wearable Recoil Protection

**Reduces Felt Recoil
By Up To 85%!**

With Mag or
Mag-Plus
Shield

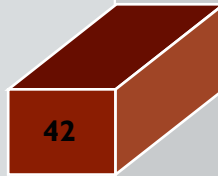

Without
Shield

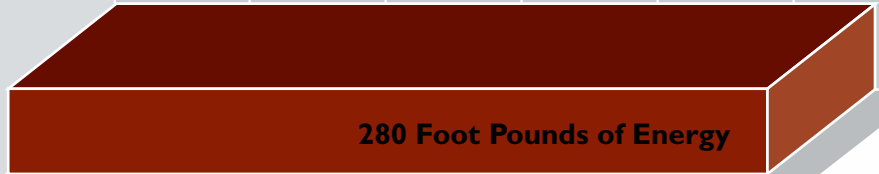

0 50 100 150 200 250 300

Energy in Foot Pounds



Mag Shield™ / #300010 / Case Pack of 6

The PAST original Mag Shield is designed to provide unparalleled recoil protection while sighting in your rifle, benchrest shooting, or participating in many other shooting activities. The size and shape of the Mag Shield creates the perfect combination of function and comfort. It can be worn on the left or right shoulder and attaches with an easily adjustable side closure for a secure fit. The leather on the front secures the gun in place, while the leather on the back of the shield provides a comfortable feel and prevents the shield from sliding around on your shoulder. The shield's 1/2" thick, energy-absorbing pad provides excellent protection for calibers up to 300 Winchester Magnum. Weighs 4 ounces. Ambidextrous.



Mag Plus Shield™ / #310010 / Case Pack of 6

The PAST Mag Plus Shield is designed to provide the same unparalleled recoil protection as the original Mag Shield but features a larger surface area. The heart-shaped design expands the recoil absorption area, extending protection to the upper arm. This quality is especially valuable in those cases when the rifle or shotgun is not shouldered perfectly. The size and shape of the Mag Plus Shield creates the perfect combination of function and comfort. This time-tested design has become a favorite for shooters around the world. The shield's 1/2" thick energy-absorbing pad provides excellent protection for calibers up to 300 Winchester Magnum. Weighs 6 ounces. Ambidextrous.



NEW Packaging

We took our most popular Past products and packaged them in eye-catching clamshells. Not only do they do a better job advertising the product, you can look through the back of the package to see the product inside. Or better yet, the package opens for trying the product on.

All clamshell packages: 8.9" wide x 11.6" high x 1.5" deep



Super Mag Plus Shield™ / #330110 / Case Pack of 6

The PAST Super Mag Plus Shield is designed to tame the real thumpers like the 416 Rigby and the 500 Nitro Express. This shield is 1" thick and provides the highest protection level of any PAST Shield. With the maximum amount of energy-absorbing protection, the Super Mag Plus Shield makes shooting even the biggest calibers tolerable. The heart shaped design provides superior protection for the shoulder and the upper arm. Weighs 10 ounces. Ambidextrous.



Field Shield™ / #350010 / Case Pack of 6

Created with the field shooter in mind. The lightweight, foam recoil system is designed for quick and easy gun mounting in the field, and provides valuable protection from recoil. It is ambidextrous and attaches with an easily adjustable hook and loop closure for a secure fit. Front and back leather faces secure the gun comfortably in place, eliminating any sliding. The shield's 1/4" thick energy-absorbing pad provides excellent protection for all shotguns. Weighs 4 ounces. Ambidextrous.



How To Measure

To determine glove size, use a measuring tape and measure your hand around the palm at knuckles with hand flat. Do not include your thumb.



Professional Handgun Gloves / Case Pack of 6

PAST Professional Handgun Gloves were designed by professional shooters for shooters at all levels. The gloves have a padded recoil reduction area to provide control and give recoil protection to the palm and thumb web area. Sizes Small-Extra Large.

Size	Measurements	
Small	7-7.5"	#151111
Medium	8-8.5"	#151113
Large	9-9.5"	#151114
Extra-Large	10-10.5"	#151115



Hidden Comfort Recoil Shield for Women™

#360000 / Case Pack of 6

The PAST Hidden Comfort Recoil Shield for Women™ is designed to give the female shooter a customized, competitive edge. Worn under clothing, this patented recoil protection has a comfortable cotton blend cover that easily attaches to a bra strap without removing the blouse or shirt, and stays in place with its hook and loop closure system. The result is an unseen protective layer of the PAST recoil absorbing foam for the female shooter. Weighs only 2 ounces. Ambidextrous.



Gun Vise Package
34" wide x 11" high x 9" deep

Gun Vise | #782731 | Case Pack of 1

Secure your rifle or shotgun for just about any work you want to perform on it. The Tipton Gun Vise is an ideal "third hand" for cleaning and gunsmithing. It features a rubberized cradle and jaws to protect and grip your gun, a quick release cam action for easy access, molded-in compartments for solvents and small parts, and is made of tough, solvent-resistant polymers.

60

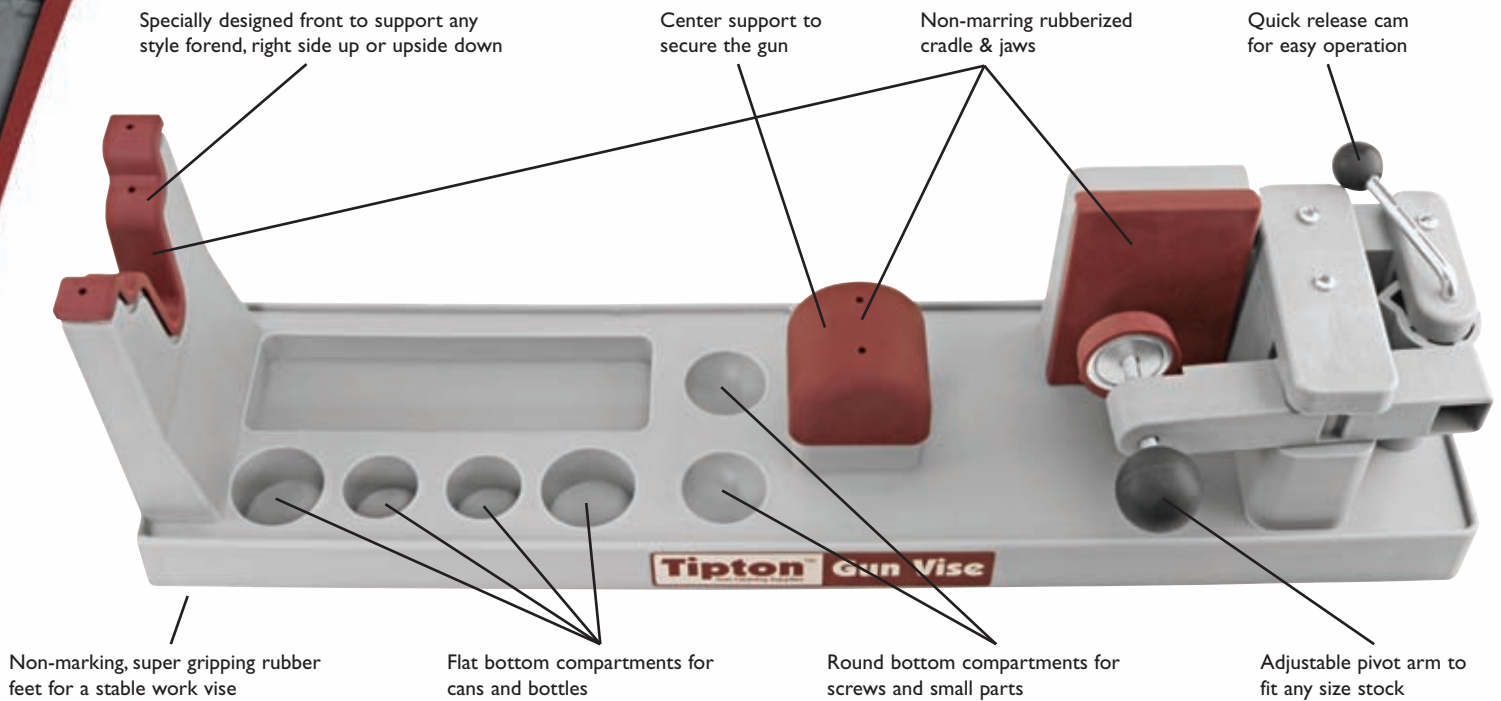

Specially designed front support supports any style forend, right side up or upside down.



Versatile clamp and support system adjusts to fit buttstocks of all shapes and sizes.

Best Gun Vise™ / #181181 / Case Pack of 1

Tipton's Best Gun Vise is the Best tool you can own for working on your guns. The vise was designed to accommodate the widest possible array of firearms for cleaning, maintenance, or gunsmithing, and is easily configurable to handle bolt-action rifles, break-open shotguns, AR-15's, and handguns. A central aluminum channel lets the user move individual components to the ideal position for their firearm. Each individual component then adjusts to the perfect position for secure support. The rear base features two adjustable offset clamps for a tight grip on a wide range of buttstock configurations. The Best Gun Vise is extremely stiff and is made from a high-quality, solvent-resistant polymer material that will stand up to years of hard use.

- Non-marring contact surfaces
- Every component adjusts to accommodate different firearms and projects
- Stiff, solvent-resistant polymer stands up to years of hard use
- Innovative, off-set clamping mechanism on rear base

PATENTED
US Patent 7,584,690 and other patents pending

Best Gun Vise™



Best Gun Vise package:
 36" wide x 12" high x 8" deep



Front support adjustable for height

Three independent supports move the length of the vise on extruded aluminum track

Separate cam blocks move independently to accommodate any stock shape

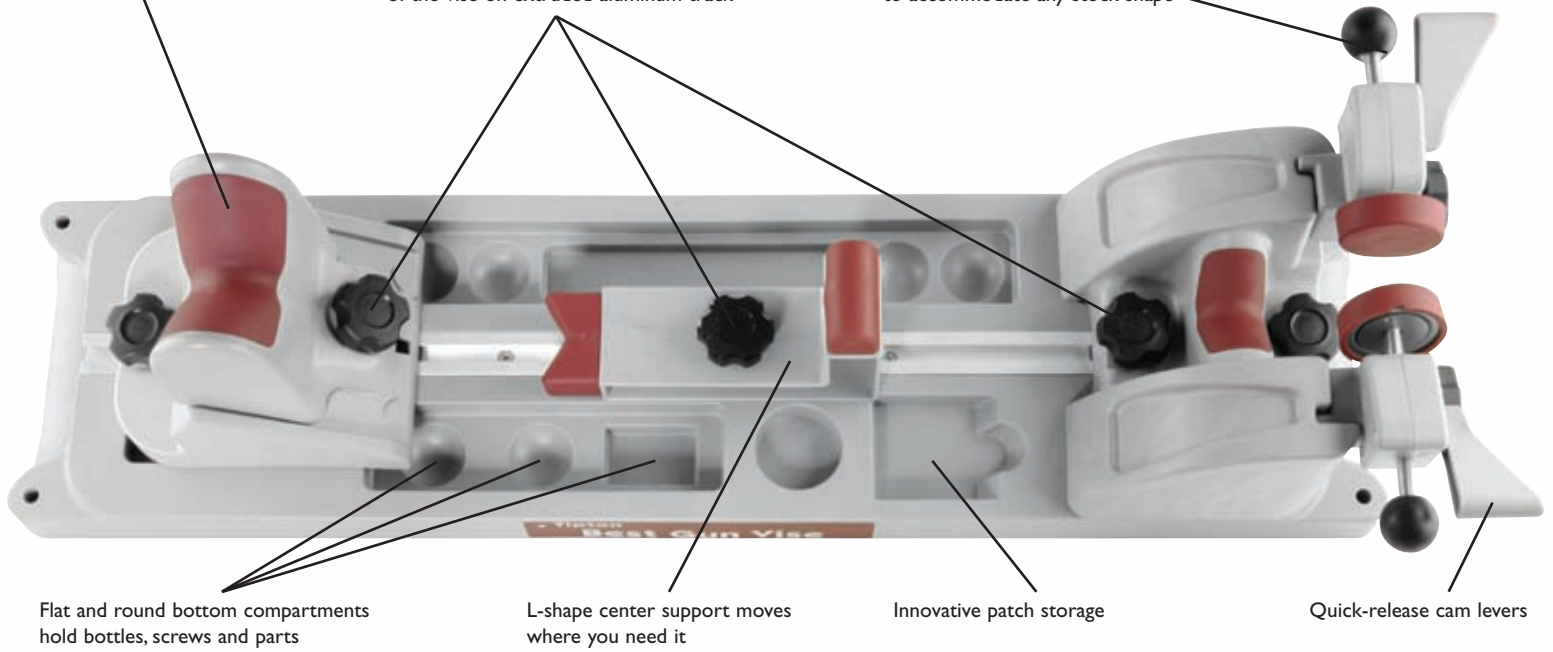

Flat and round bottom compartments hold bottles, screws and parts

L-shape center support moves where you need it

Innovative patch storage

Quick-release cam levers



Exposes the breech on any break-open shotgun for easy cleaning or inspection.



Holds hinged-receiver rifles open to gain access to bore, receiver and fire control components.



Versatile clamp and support system accommodates pistols and revolvers.

The Gun Butler offers a convenient all-in-one solution to all your cleaning/carrying/storage needs. Two removable non-marring forks (which snap into the base for easy storage) hold the gun securely in place, while thoughtfully-planned compartments and slots hold bore solvent, jags, brushes, mops, a cleaning rod, spray lubricant, and tools. The Gun Butler can store everything a shooter needs to clean a gun – all with a convenient carrying handle for easy transport.

For many hunters and shooters, gun cleaning is enough of a chore without having to keep track of all the tools and supplies it takes to clean a gun properly. Serious shooters who clean on a regular basis, often clean both at the shop and on the range. The Gun Butler offers an affordable, convenient solution for storage and transportation of supplies as well as a secure gun holder for the actual cleaning process.

62

Gun Butler product:
23.5" wide x 4.25" high x 9.5" deep



We took retail shelf space into mind when designing the new Gun Butler. The nested design allows multiple units to rest on top of each other, taking up 70% less space than a stand-alone product would. How's that for innovation!



Rifle and contents not included.

This overhead view shows you all the designated cavities for your bore solvents, brushes, screws, cleaning rod, and countless other cleaning station supplies.



Range Box

The Tipton Range Box is the ultimate in convenience for shooters and hunters. It organizes everything you need, cleaning supplies, rifle rest bags, targets and more. It is available with either an empty cleaning kit box, or with a complete cleaning kit that will service any gun.

- Compartmentalized storage spaces
- Removable cleaning kit
- Rubberized forks to hold most firearms
- Solvent resistant polymer construction

Ultimate Pistol and Rifle Range Box w/ Cleaning Kit / #482254 / Case Pack of 1

Rifle, Handgun and Shotgun Range Box with Empty Cleaning Kit / #458509 / Case Pack of 1

Everyone knows... any amount of fouling in your bore impedes accuracy.

A test was conducted to determine which bore solvent available was truly the most effective at removing fouling from your bore. This test consisted of placing a bullet (copper plated) on top of a soaked cotton patch for twelve hours. Each patch was soaked with equal amounts of the top bore solvents on the market today. As you know, bore solvents attack copper fouling in your bore, resulting in a blue discoloration on your cleaning patch. Hence, the patch in the dish that has the most blue, has been the most effective at attacking the copper (fouling). As seen below, the dish containing Tipton Truly Remarkable Bore Solvent has the bluest patch of all.



Truly Remarkable Bore Solvent™ / #746275 / Case Packs of 6

The Tipton Truly Remarkable Bore Solvent is the most aggressive bore solvent currently available. By combining today's advanced chemicals we have developed a bore solvent that quickly works to remove all types of stubborn fouling from your barrel, yet it remains gentle on your bore. You'll be sure to enjoy less time cleaning and more time shooting with the amazingly fast cleaning action of this revolutionary solvent. In fact, this solvent is so good, it is a winner of the prestigious Blue-Patch test!

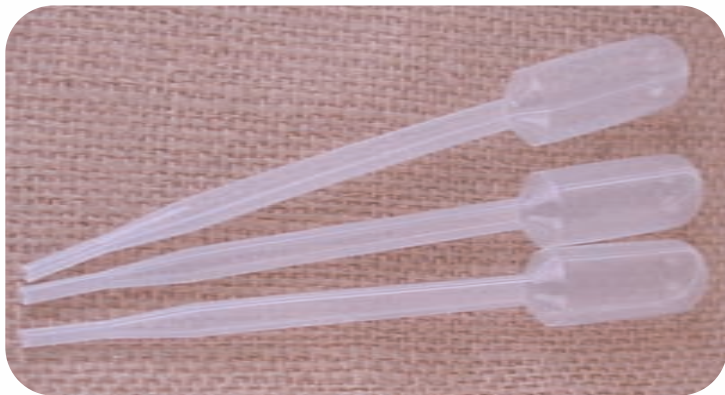

Pipettes, 6", 12 qty. / #146527 / Case Pack of 6

All-plastic, disposable "eye droppers" are just the ticket for measuring and transferring liquid products. Great for cold bluing solutions, cutting oils, solvents, preservatives, etc. Put the product just where you want it.



Flip-Top Solvent Bottles

#197624 / Case Pack of 6

Set of 3 High Density Polyethylene 4 oz bottles are the perfect size for use on the bench or taking to the range. Holds solvents, oils, and many other liquid products. Each bottle comes with two caps, one Flip-Top, one standard.

DELUXE CARBON FIBER CLEANING ROD

Carbon fiber is well-suited to the tough tasks assigned to cleaning rods. It combines the best features of stainless steel and coated cleaning rods, then adds valuable properties of its own. Stainless steel rods can scratch or wear barrels if they're used carelessly - though they won't pick up potentially damaging small abrasive particles. "Coated" rods get part of the job done - they keep the stainless steel shaft from damaging your barrel's rifling, but the coating will pick up small abrasive particles, which means you're effectively running fine-grit sandpaper through your bore. Carbon fiber rods are the best of both: the carbon fiber can't scratch your bore like stainless steel, and they won't embed like coated rods. Plus, Carbon Fiber rods can be bent to an extreme degree and return to their original straightness. During Operation Iraqi Freedom, US military armorers called on Tipton to provide cleaning rods that would clean service rifles in demanding conditions. It made sense to us: Carbon fiber is an ideal material for cleaning rods. We call these cleaning rods "deluxe" because they feature an ergonomically designed handle that spins on two sets of ball bearings - the result is a cleaning rod that smoothly follows the rifling both pushing and pulling, even while under pressure. The "shank-through" construction also allows the user to apply "reasonable" hammer blows to the end of the cleaning rod to get a tight patch through a bore. Available in four diameters and six lengths to fit most rifles, pistols, and shotguns. Rifle and handgun rods are threaded for 8-32 accessories, except 17 caliber and 20 caliber rods which are threaded 5-40. Shotgun rods are threaded 5/16"-27.

64



Hang hole for easy storage. Also allows for reasonable hammer blows to clear a stubborn patch.

Two sets of high quality bearings that won't bind under pressure and allows the shaft to follow the rifling.

Comfortable ergonomic shape. Handle remains fixed in your hand while the shaft rotates on the bearings to follow rifling.

Shank-through construction for working tight patches.

Carbon fiber shaft won't embed particles that could damage your rifle bore.



12", 22-26 Caliber
Model Shown

26", 27-45 Caliber
Model Shown

36", Shotgun Model Shown

40", 40+ Caliber Model Shown

44", 22-26 Caliber Model Shown

62", 50 BMG Model Shown

NEW Retail Packaging for Deluxe Carbon Fiber Cleaning Rods



Unlike Tipton's normal sturdy reshippable cardboard tube packaging for Deluxe Carbon Fiber Cleaning Rods, this retail pack will ship a single 12", 36" or 44" retail cleaning rod in a display-friendly clear tube.



Sturdy Reshipable Cardboard Tube for Deluxe Carbon Fiber Cleaning Rod Case Pack of 1.

	12"	26"	36"	40"	44"	50"	62"
17 Caliber Shaft diameter: .158"		#146468	#107486				
20 Caliber Shaft diameter: .189"				#175401			
22 - 26 Caliber Shaft diameter: .208"	#658675	#216411	#430886	#182978	#783485		
27 - 45 Caliber Shaft diameter: .250"	#303569	#376252	#720747	#413662	#509320	#751235	
40+ Caliber Shaft diameter: .375"			#654574		#189446		
50 BMG Shaft diameter: .375"							#157379
Shotgun Shaft diameter: .375"			#713415				



NEW Retail Packaging for Deluxe Carbon Fiber Cleaning Rod Case Pack of 4.

	12"	26"	36"	40"	44"	50"	62"
17 Caliber Shaft diameter: .158"		#146468R	#107486R				
20 Caliber Shaft diameter: .189"				#175401R			
22 - 26 Caliber Shaft diameter: .208"	#658675R	#216411R	#430886R	#182978R	#783485R		
27 - 45 Caliber Shaft diameter: .250"	#303569R	#376252R	#720747R	#413662R	#509320R	#751235R	
40+ Caliber Shaft diameter: .375"			#654574R		#189446R		
Shotgun Shaft diameter: .375"			#713415R				



Rod Rack / #100335 / Case Pack of 4

Want to organize and keep all your cleaning rods handy? The Tipton Cleaning Rod Rack will hold a wide variety of cleaning rods in various shapes and sizes. Accommodates up to six rods plus has hanging hooks on either end for additional accessories. The Rod Rack even has molded in bumpers designed for securing T-handle rods. Constructed of a durable molded material. Mounting holes and screws included.



Rod Rack package:
6" wide x 18" high x 2.5" deep

Demonstration shown of the RAPID in action, as well as the bore guide and RAPID inserted into a bolt action rifle.

RAPID Deluxe Bore Guide Kit package: 7" wide x 17.25" high x 3" deep

RAPID™

RAPID™ Deluxe Bore Guide Kit | #777999 | Case Pack of 4

The Tipton RAPID Deluxe Bore Guide Kit contains several great tools that ensure the safest, easiest, and most effective cleaning possible.

RAPID allows you to easily align and secure a patch for solvent application, then holds it with the correct amount of tension for perfect jag penetration. When the rod is pushed into the RAPID, it automatically releases the patch. It also keeps harmful solvents off your gun's finish in the process.

A bore guide will help protect the bore and action of your rifle by properly aligning the cleaning rod and reducing solvent overflow. Cleaning without a bore guide can allow the rod to "bow" and rub or gouge the chamber and throat of the bore causing real damage and loss of accuracy. Keeping the rod properly aligned not only protects your barrel, it properly directs the force exerted on the cleaning rod handle, allowing tight patches to be pushed safer and easier. (Will not fit .22 Rimfire)

- Features new RAPID patch insertion device that aligns and holds patch in place
- RAPID cuts cleaning time and reduces solvent mess
- Reduces solvent leakage into gun's action
- Ensures proper rod alignment for easier cleaning
- Bore guides protect chamber & bore from damage
- Anodized aluminum tube for durability
- Integrated solvent port
- Kit includes 4 muzzle guides
- Inserts & secures into the bolt position
- Fits most bolt action rifles & AR-15s
- Convenient storage case included

NEW FOR
2020

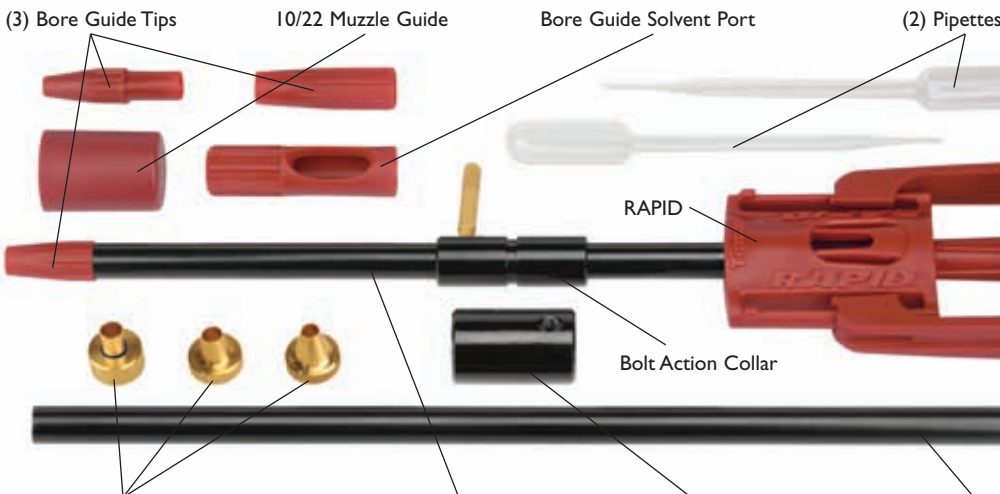

1. With the sliding rear guide pulled out, center the patch with access hole



2. Push the sliding rear guide forward, securing the patch



3. Use the built-in solvent port to apply solvent to the cleaning patch



4. Insert cleaning rod with jag, penetrating patch and releasing it

Universal Bore Guide Kit / #777888 / Case Pack of 4

The Tipton universal bore guide will help protect the bore and action of your rifle by properly aligning the cleaning rod and reducing solvent overflow. Cleaning without a bore guide can allow the rod to "bow" and rub or gouge the chamber and throat of the bore, causing real damage and loss of accuracy. Keeping the rod properly aligned not only protects your barrel, it directs the force exerted on the cleaning rod handle allowing tight patches to be pushed more easily.

- Protects chamber & bore from damage
- Ensures proper rod alignment for easier cleaning
- Reduces solvent leakage into gun's action
- Anodized aluminum tube for durability
- Integrated solvent port
- Fits most bolt action rifles & AR-15s
- Inserts & secures into the bolt position

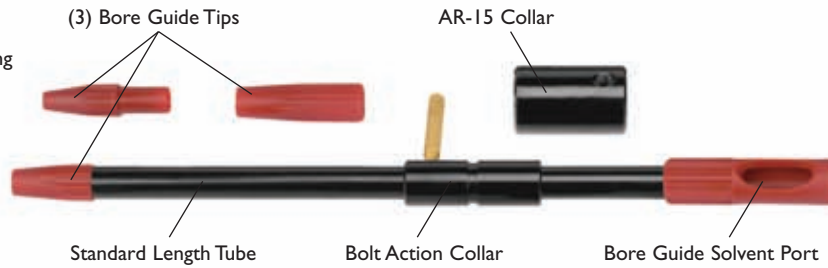

Universal Bore Guide Kit package: 4.75" wide x 16.5" high x 1.5" deep



Fits nearly all centerfire bolt-action rifles



Includes a collar for use on AR-15s



Convenient solvent port protects your finish

With Patch Trap

Patch Trap

Without Patch Trap



Convenient
Clean
Prevents Corrosion
Odor-Free

Inconvenient
Messy
Corrosive
Smelly



Universal Bore Guide Kit package: 8" wide x 11" high x 2" deep

Patch Trap™ / #777890 / Case Pack of 4

Cleaning the barrel on your rifle, shotgun or muzzleloader can be a messy chore. Solvent splatter, drips and dirty patches always seem to end up where you don't want them. Strong solvents and powder residue can stain clothes and work surfaces. The Tipton Patch Trap puts an end to the mess.

The Patch Trap quickly attaches to the end of any rifle, shotgun or muzzleloader barrel. The threaded end accepts a common water or soda bottle. Once secured in place it will safely capture solvent splatter, drips and dirty patches. When you're finished cleaning the barrel, simply discard the used bottle in a safe location. It is constructed of a solvent resistant material and uses a durable rubber strap to secure it in the position on the muzzle of the gun. The Patch Trap makes cleaning quicker and eliminates the mess.

Its simple to use:

- 1) Attach the patch trap to the muzzle of any gun
- 2) Screw an empty water or soda bottle into the threaded end
- 3) Dirty patches and solvent are safely and cleanly contained
- 4) Dispose of used bottle (NOTE: Adhere to cleaning chemical manufacturer's warnings. Dispose of bottle with cap OFF in well ventilated area.)

Tipton®

Gun Cleaning Supplies

PATENT PENDING

What Is Behind Ultra Technology?

Take a modern bore solvent and squirt it on a brass cleaning jag. The liquid will turn blue as it drips off the jag - it's working so fast, it starts to dissolve your cleaning jag in front of your eyes! If you're following conventional wisdom "clean until you get a clear patch" you might be in for a long night. Tipton's Ultra Jags feature a patent-pending technology that covers the surface of a traditional push-type jag with solvent-proof material, keeping aggressive modern bore solvents from creating false blue stains that normally indicate copper fouling. Before Ultra Jags, these false blue stains caused users to over-clean their barrels - and that's been demonstrated to destroy accuracy over time. When you use Ultra Jags, you'll get better, faster cleaning results because you'll know you're getting blue stains from copper fouling from your barrel and not from the surface of your jag. In addition, you will increase the life of your jag by protecting the jags brass core from the aggressive modern solvents with the nickel-plated coating.

Ultra Jag™

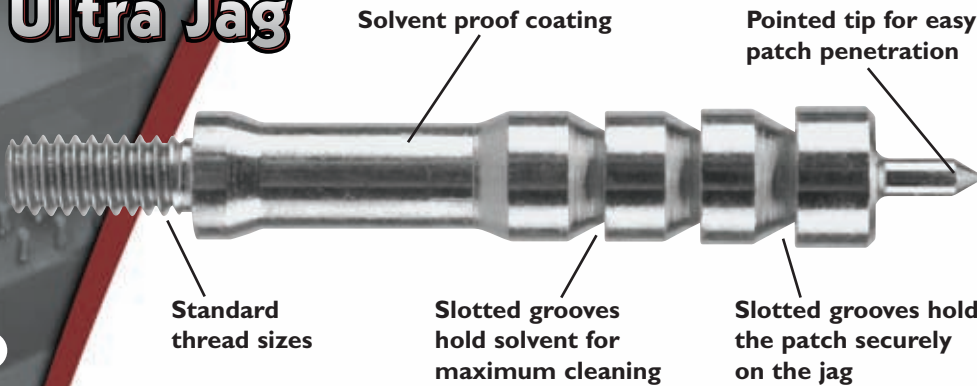

17 Caliber	#175543
22 Caliber	#225659
243/6mm Caliber	#243865
25 Caliber	#255684
270/7mm Caliber	#277555
30, 303 & 32 Caliber	#303033
338/8mm Caliber	#338338
348, 35 & 9mm Caliber	#348359
375 Caliber	#375375
40, 41 & 416 Caliber	#404169
44 Caliber	#444444
45 Caliber	#454545

Ultra Jags™

We believe that the Tipton Ultra Jags are the finest jags ever offered. They use an innovative technology of nickel plating to satisfy the shooter who wants the best tools to maintain his or her guns. The nickel plating will not scratch or in any way harm the finest bore. This solvent-proof material makes this the ultimate jag and the only way to truly get an accurate reading of how clean your bore really is. **Case Pack of 5.**



12-Piece Ultra Jag clamshell package: 5" wide x 6.5" high x 1" deep



12 Piece Ultra Jag™ Set / #500012 / Case Pack of 6

Conveniently packaged 12-piece caliber-specific set of Ultra Jags means you always have the right jag at hand. Contained in a durable, hinged box with marked cavities, it's easy to select the correct Ultra Jag for your particular application. Because they are caliber-specific, you can be assured of an optimum fit to your firearm's bore for efficient and thorough cleaning. 17 to 45 caliber (does not include 20 caliber). All jags have 8-32 threads (17 caliber has 5-40 threads).



The Ultra Jag shows no sign of copper blueing, even after soaking in bore solvent overnight.



It's apparent that brass jags ultimately contribute to false blueing on your cleaning patches.

GET THE BEST OF BOTH WORLDS

Ultra Jag™ Best Bore Brush™

26pc Jag/Brush package:
7" wide x 8.5" high
x 3.25" deep

26 Piece Ultra Jag & Best Bore Brush Set

Combining the Ultra Jags and Best Bore Brushes into one convenient 26-piece set gives you the ultimate storage system for your brushes and jags. Neatly organized in a durable, hinged box with marked cavities, it's easy to select the correct jag and brush for your particular application. Because they are caliber-specific, you can be assured of an optimum fit to your firearm's bore for efficient and thorough cleaning. 17 to 45 caliber (does not include 20 caliber). All jags and brushes have 8-32 threads (17 caliber has 5-40 threads and is a standard bore brush). **Case Pack of 6.**

26pc. Ultra Jag & Best Bore Brush Set / #444777

Ultra Jag & Best Bore Brush Box Only / #856117

Best Bore Brush™



All components are non-marring

20% more bristles than standard brushes

Wire-through coupler for maximum strength

Best Bore Brushes™

We believe that the Tipton Best Bore Brushes are the finest brushes ever offered. They meet or exceed military specifications and are designed to satisfy the shooter who wants the best tools to maintain his or her guns. The components of Tipton Best Bore Brushes will not scratch or in any way harm the finest bore. The core is a single piece of brass wire that passes through the threaded brass coupler, guaranteeing that the core will never separate from the coupler in the barrel. Bristles are made from high-quality bronze, which is much softer than barrel steel but more than aggressive enough to scour away lead fouling, copper fouling, and powder residue. Each brush contains the maximum number of bristles that can be inserted for the caliber. 20% more than standard brushes! You will feel the difference. Because of their density we recommend that Tipton Best Bore Brushes only be used with a quality one-piece rod and an appropriate bore guide. **Case Pack of 5.**

	3 qty.	10 qty.
20 Caliber	#669638	#197356
22 Caliber	#140337	#882927
243/6mm Caliber	#758284	#610187
25 Caliber	#657930	#229196
6.5mm Caliber	#269421	#220568
270 Caliber	#622858	#111345
7mm Caliber	#146917	#355446
30 Caliber	#868556	#634045
8mm Caliber	#427343	#320660
338 Caliber	#178821	#632184
35 Caliber	#606367	#642348
375 Caliber	#127759	#794858
40/416 Caliber	#317183	#236105
44/45 Caliber	#629958	#625005
50 BMG Caliber	#561865	#893880



14-Piece Best Bore Brush clamshell package: 5" wide x 8" high x 1.5" deep



ALL IN ONE CONVENIENT KIT



PATENT PENDING

14 Piece Bronze Best Bore Brush™ Rifle Set #402173 / Case Pack of 6

Conveniently packaged 14-piece caliber-specific set of Best Bore Brushes means you always have the right brush at hand. Contained in a durable, hinged box with marked cavities, it's easy to select the correct Best Bore Brush for your particular application. Because they are caliber-specific, you can be assured of an optimum fit to your firearm's bore for efficient and thorough cleaning. 17 to 45 caliber (does not include 20 caliber). All brushes have 8-32 threads (17 caliber has 5-40 threads and is a standard bore brush.) See page 54 for the complete line of bronze and nylon Tipton Bore Brush Sets for handguns, rifles and shotguns.



Individual Bronze Bore Brushes and Nylon Bore Brushes

Case Pack of 5.

Bronze Bore Brushes

Case Pack of 5.

Nylon Bore Brushes

	3 qty.	10 qty.	3 qty.	10 qty.
Pistol				
22 Caliber		#356062		
25 Caliber		#120466		
32 Caliber		#352897		
38/9mm Auto Cal.		#627021		
41/10mm Auto Cal.		#548257		
44 Caliber		#335060		
45 Caliber		#392203		
475/480 Caliber		#704342		
Rifle				
17 Caliber		#179052	#698306	#691861
22 Caliber		#466875	#749051	#690246
243/6mm Caliber		#543889	#176663	#545852
25 Caliber		#100225	#559632	#125551
6.5mm Caliber		#291327	#413806	#625073
270 Caliber		#848786	#887541	#625053
7mm Caliber		#188414	#355747	#487058
30 Caliber		#113901	#125012	#479395
8mm Caliber		#103729	#437445	#879986
338 Caliber		#103563	#565703	#712091
35 Caliber		#587953	#105458	#196043
375 Caliber		#646413	#468709	#512868
40/416 Caliber		#588385	#592325	#842874
44/45 Caliber		#709648	#303351	#342903
Shotgun				
10 Gauge	#662575			
12 Gauge	#612735			
16 Gauge	#383231			
20 Gauge	#215223			
28 Gauge				
410 Bore	#286637			



12-Piece Jag Set #749245 / Case Pack of 6

These 12 solid brass cleaning jags are the fastest way to thoroughly clean, dry, or oil the bore. Each jag is designed to provide a tight fit between the patch and the bore. A pointed tip keeps the patch centered and allows it to drop off when the jag exits the muzzle. Made with 8-32 threads (17 caliber has 5-40 threads), they will fit most brands of cleaning rods, and should provide years of service. Kit includes 17, 22, 243/6mm, 25/6.5mm, 270/7mm, 30, 338/8mm, 35/9mm, 375, 40, 44 and 45 jags. Convenient storage box features marked cavities for each caliber.

Bore Brush Sets

Tipton Bore Brush Sets are a new concept in firearms maintenance. Conveniently packaged caliber- and gauge-specific sets of brushes means you always have the right brush at hand. Because they are caliber- and gauge-specific, you can be assured of an optimum fit to your firearm's bore for efficient and thorough cleaning. Contained in a durable, hinged box with marked cavities, it's easy to select the correct brush for your particular application. Tipton Bore Brush Sets are available in both bronze and nylon. Bronze brushes are made from premium phosphor bronze for long life and cleaning power. The nylon brushes are made from a material that is unaffected by most modern solvents including copper solvent which can easily deteriorate a bronze brush. Threads fit most popular brands of cleaning rods (8-32 for Rifle and Pistol, except for 17 caliber which is threaded 5-40), and 5/16-27 for Shotguns. Rifle set contains 14 caliber specific brushes (17-45 caliber), Pistol set contains 8 brushes (22-47/48 caliber), Shotgun set contains 6 brushes (410-10 gauge).



Case Pack of 6.

	Nylon	Bronze
14-Piece Rifle Brush Set	#615333	#168577
8-Piece Handgun Brush Set		#845102
6-Piece Shotgun Brush Set		#671861
14-Piece Rifle Best Bore Brushes	#402173	

Bore and Chamber Mops

100% Cotton Mops are ultra absorbent. They hold and carry solvents, lubes, and preservatives into your bore and chamber. Great for applying large quantities of modern copper solvents to fouled bores. Small Rifle Chamber Mops fit 22 Hornet, 222, 223, etc. Large Rifle Chamber Mops fit 22-250, 308, 30-06, belted magnums, etc. Case Pack of 5.



Description	3 qty.	10 qty.
17 Caliber	#312659	#131384
22-25 Caliber	#653568	#709262
6.5mm-338 Caliber	#386626	#478098
8mm-375 Caliber	#181031	#480820
40-45 Caliber	#676648	#353039
Chamber Mop, Large Rifle		#445040
Chamber Mop, Small Rifle		#371484

Description	3 qty.	10 qty.
10, 12 Gauge	#657972	#243027
16, 20 Gauge	#681324	#102015
28 Gauge	#682539	#381271



Individual Solid Brass Slotted Tips

For flooding the barrel with solvent or wiping the bore with oil or preservatives, nothing beats a patch in a Slotted Tip. Tipton offers an assortment of four caliber-range specific Rifle/Pistol tips for your convenience, or they can be purchased separately. Solid brass is softer than barrel steel so there is no worry of damaging your bore, plus they will last much longer than the typical synthetic plastic tips. Rifle/Pistol Tips are threaded 8-32 and the Shotgun Tip 5/16"-27. **Case Pack of 5.**

Rifle/Pistol Set of 4	#554-428
22 - 29 Caliber	#428-953
30 - 35 Caliber	#211-422
35 - 44 Caliber	#777-753
45+ Caliber	#400-385
Universal Shotgun	#339-005

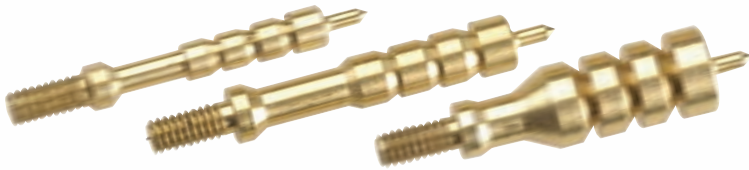

Individual Solid Brass Jags

17 Caliber (5-40 threads)	#154-070
22 Caliber	#356-987
243/6mm Caliber	#696-435
25 - 6.5mm Caliber	#584-696
270 - 7mm Caliber	#768-059
30/303 Caliber	#193-225
8mm - 338 Caliber	#485-467

Case Pack of 5.

338 - 35 Caliber	#434-832
375 Caliber	#272-744
40/41/416 Caliber	#412-599
44 Caliber	#301-110
45 Caliber	#239-013
50 Caliber	#505-050

Cleaning Patches

100% Cotton Flannel Patches, precisely cut to the correct size for use with Tipton Jags. When used with slotted tip, choose the next size larger for optimum performance. **Case Pack of 5.**



Description

17-22 Caliber, .75" Square	100	#476-217
17-22 Caliber, .75" Square	1000	#652-376
22-270 Caliber, 1.13" Square	100	#359-811
22-270 Caliber, 1.13" Square	1000	#618-061
27-35 Caliber, 1.75" Square	100	#444-068
27-35 Caliber, 1.75" Square	1000	#279-375
35-50 Caliber/20 Gauge, 2.25" Square	100	#192-431
35-50 Caliber/20 Gauge, 2.25" Square	500	#364-206
10, 12, 16 Gauge, 3" Square	500	#470-796
45-58 Caliber Black Powder, 2.50" Round	250	#784-909

Qty.



Action / Chamber Cleaning Tool Set

These tools are made specifically for those hard to reach areas inside the receiver of your bolt action rifle. The action cleaning tool utilizes cylindrical swabs to clean and lubricate the locking lug recesses. The chamber cleaning tool uses a mop to remove carbon and powder residue that is often left in the chamber during conventional bore cleaning. Includes both tools, a small and a large rifle chamber mop, 10 swabs, and a nylon cleaning brush. **Case Pack of 12.**

Action / Chamber Cleaning Tool Set / #368-628

Replacement Swabs, Pack of 100 / #115-373

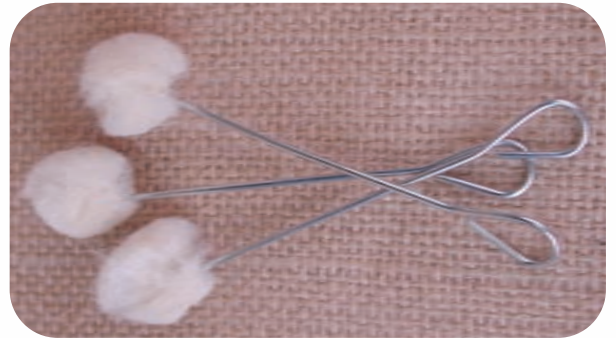

Shooters Swabs

Wire-handled swabs are perfect for applications of lubes and preservatives. They also work well with solvents to scrub out recesses in receivers, bolt bodies, and other hard-to-reach areas. Dozens of uses. 4" long.

Shooters Swabs, 50 qty. / #757-554 / Case Pack of 6

Shooters Swabs, 100 qty. / #350-379 / Case Pack of 6



Gun Cleaning Picks / #549-864 / Case Pack of 6

Here's a clever idea that belongs in every cleaning kit - Gun-Cleaning Picks. This set of four picks with different configurations on each end provide eight different combinations to get into those tight, hard to reach places. Made of high-strength polymer so they won't scratch the finest surface. Set of four picks.

- Handy tools offered only by Tipton
- Helps you reach the most important, tightest spots in your firearms
- Made of a high-strength polymer that won't scratch your gun
- Set of 4 Picks, each has a different shaped tool at each end



Gun Bright / #439-502 / Case Pack of 6

Scrub off grease, grime, and rust without damaging your firearm. Amazing, all stainless steel pad is tough on rust, but gentle on bluing. Used with a penetrating oil and a gentle touch, the Gun Bright Pad is capable of sweeping away surface rust from your firearms while leaving any remaining original bluing intact. Adding a tuft to a shotgun brush quickly scours plastic and powder fouling out of your barrel. Great for removing carbon deposits and other stubborn buildups.



Silicone Cloth / #502-260 / Case Pack of 6

Protect your fine firearms from corrosive fingerprints and the elements. The soft cloth, impregnated with pure silicone, provides the perfect wipe-down for your guns before putting them away. Protects metal surfaces from rust and corrosion at extreme temperatures, and leaves a shiny, well-preserved appearance. Will not evaporate or dry out. 14" x 15".



Heavy Duty Vinyl Gloves

These heavy-duty green vinyl gloves will last through several applications of strong chemicals like rust and blue remover, or any job where skin protection is recommended or required. Keep your hands free of cutting oil, lubes, preservatives, or any product that may cause skin irritation. Available in two sizes, medium and large. (See sizing chart on page 45.)

Medium / #149-472 / Case Pack of 10

Large / #195-845 / Case Pack of 10



Cotton Inspection Gloves / #626-671 / Case Pack of 6

Fine, heavy-duty white cotton gloves ideally suited for wear while inspecting or evaluating fine firearms, knives, swords, or expensive antiques. Prevents fingerprinting or transfer of contaminating material that can degrade the finish of new or vintage firearms and keepsakes. Excellent for collectors, appraisers, or anyone dealing in quality firearms. Package of 4 pair.



Maintenance Mats

The perfect material to lay on your workbench while cleaning or disassembling firearms. Padded neoprene construction protects firearm finishes while helping keep track of small parts. Excess oils and solvents are absorbed into the mat, keeping the surface clean and dry. The Tipton Maintenance Mat rolls easily to fit in your range box. Hand washable.

12" x 24" Maintenance Mats / #602-557 / Case Pack of 6

16" x 54" Maintenance Mats / #380-861 / Case Pack of 6



Metal Magic Gun Cloth / #292-640 / Case Pack of 6

Non-abrasive metal cleaning cloth designed to remove carbon, lead, and burn marks from stainless and nickel-plated firearms. Use as part of regular maintenance to keep your revolver or pistol looking like new. Handy 6-3/4" x 4" size, in easy-close bag. Caution: continual rubbing can remove conventional bluing and case colors.



Snap Caps

Snap Caps have a variety of uses around the bench. It is generally accepted that one shouldn't drop the firing pin on an empty chamber - which is the primary reason to have Snap Caps for your favorite guns. You should always use Snap Caps when checking or adjusting the trigger pull. If you prefer to release the tension on the hammer springs, when storing your guns, Snap Caps are ideal. Whatever your needs, Snap Caps are handy and inexpensive.

Shotgun

	Case Pack of 6
12 Gauge, 2 qty.	#280-986
16 Gauge, 2 qty.	#878-078
20 Gauge, 2 qty.	#191-808
410 Bore, 2 qty.	#358-983

Rifle

	Case Pack of 6	Case Pack of 1
22 Rimfire Long Rifle, 10 qty.	#831-787	25 qty. #486-758
223 Remington, 2 qty.	#415-091	
243 Winchester, 2 qty.	#270-693	
270 Winchester, 2 qty.	#709-600	
308 Winchester, 2 qty.	#134-402	
30-06 Springfield, 2 qty.	#391-320	
7.62x39mm Russian, 2 qty.	#787-336	
45-70 Gov't, 45-90, 45-120, 2 qty.	#378-183	

Pistol

32 ACP, 5 qty.	#647-663
380 ACP, 5 qty.	#337-377
9mm Luger, 5 qty.	#303-958
40 S&W, 5 qty.	#745-435
45 ACP, 5 qty.	#146-331

Revolver

38 Special, 357 Magnum, 6 qty.	#321-398
44 Magnum, 6 qty.	#347-873
45 Colt, 6 qty.	#612-637

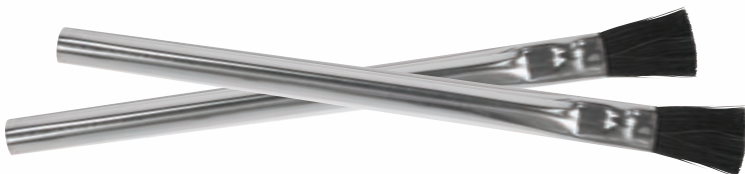

Clean and Lube Brush, 12 Pack / #806-270 / Case Pack of 6

100% natural bristle brush only 1/2" wide is perfect for cleaning and lubricating small, hard to get at areas on all firearms. Use dry to sweep out dust and unburned powder. Use with solvents to loosen up more tenacious fouling. Apply lubes and preservatives to critical points in the action and trigger assembly.



Choke Tube & Accessory Case / #856-100 / Case Pack of 6

Keep your choke tubes organized and handy at all times. Protects threads from damage and deformation. This durable box will hold three full length choke tubes and has space for a 4th shorter tube. Also works great to organize other small accessories such as grease, cleaning brushes, chamber mops, a tube wrench, or snap caps. Snaps closed to keep contents secure.



Clean and Oil Brush / #375-777

Fine natural bristle cleaning and oil application brush. Hundreds of soft 1-3/4" bristles, do a great job cleaning and carrying oil and preservatives to the exterior of your guns, and the hard-to-reach areas like under vent ribs. **Case Pack of 5.**

Professional Gunsmithing Screwdriver Set

Screwdrivers are the most important and most-used gunsmithing tools. Wheeler's Deluxe Gunsmithing Screwdriver Set is the kit that belongs on every gunsmithing bench. The well thought-out bit selection will put an end to burred, bugged, busted up screw slots on any gun that comes your way. The bits make up the heart of any screwdriver set, and Wheeler's are the finest available. **They're made from S2 tool steel and hardened to 56-58 Rockwell "C".**

Unlike other screwdriver suppliers, Wheeler's engineers measured the screws on over one hundred modern and antique firearms to make sure that we offered bits for every situation. Whether you're working on a Browning Superposed, a Remington 700, a Smith & Wesson revolver, or a Colt Single Action, you'll find that there's a bit to fit every screw on your gun. The 54 Hollow-ground flat bits range in size from .120"x.020" to .360"x.070", and includes doubles in the thinnest sizes. Any gunsmith will tell you that you're occasionally going to break the ultra-thin bits on stubborn screws. This set includes two each of the very thinnest bits, which means you'll never be stuck in the middle of a job without the proper bit. The set also includes a complete selection of Phillips, Allen, and Torx bits to cover scope rings, bases, recoil pads, and the like. The difference in the "basic set" and the "professional set" lies in the 15 ingenious "specialty bits" that are included in the "professional" set. These 15 pieces include all of the bits pictured below. These bits are great for installing scope bases, getting you out of a pinch by providing a small pin punch when you really need it, and keeping once-in-a-while lifesaver tools at your fingertips. Both sets come with two handles made from comfortable overmolded plastic. The first is a regular size handle that's good for most jobs, and the second is a shorter "Close Quarters" handle that is good for finesse work with smaller bits. Both sets also come in a durable custom box that's ready for the bench or your range kit. **Case Pack of 1.**

The Professional Set contains: • Hinged storage box • 2 ergonomic handles • 2 1/4" shaft extension • Hex to square drive adapter • 54 Flat Bits • 8 Allen Bits • 4 Phillips Bits • 3 Torx Bits • 15 Specialty Bits and Accessory Tools for Colt®, Remington®, Smith & Wesson®, Mauser, Glock®, Garand, Ruger®, and more!

Deluxe 89 Piece Professional Gunsmithing Screwdriver Set / #562-194

Basic 72 Piece Professional Gunsmithing Screwdriver Set / #776-737

2 SETS TO CHOOSE FROM

Upgrade 17 Piece Screwdriver Set / #748-555

Contains the 15 Specialty Bits, shaft extension, and square to hex adapter found in the Professional Set.

Replacement bits are available in three packs on our website for a very modest price.



PATENTED

US Patent D524,541 and other patents pending



Both Screwdriver Set packages:
8.3" wide x 12.3" high
x 3.1" deep

The 15 Specialty Gunsmithing Bits



Weaver/Ruger Scope Ring Clamp Bit



Redfield Windage Screw Bit



Leupold Windage Screw Bit



Ruger/Colt SA Base Pin Latch Nut Bit



1911 Grip Screw Bushing Driver



M1/M14/M1A Rear Sight Bit



Millett Rear Sight Adjustment Bit



Mauser Stock Bolt Bit



.062" Pin Punch



.093" Pin Punch



.118" Pin Punch



Glock Replacement Front Sight Screw Bit



S&W Rebound Spring Compressor Tool



Remington M870/1100/1187 Trigger Plate Pin Punch



2" #2 Phillips

THE FAT WRENCH®

FIREARM ACCURIZING TORQUE WRENCH

PATENT PENDING

F.A.T. Wrench now comes standard with a convenient storage case



The F.A.T. Wrench®

Wheeler's F.A.T. Wrench brings perfect consistency to every screw on your rifle! This amazing handheld torque wrench lets you apply repeatable, accurate torque settings to scope rings, guard screws and other screws, which aids in accuracy and decreases the opportunity for problems in the field. Detailed instructions and torque recommendations included.

The F.A.T. Wrench is a perfect compliment to the Deluxe Gunsmithing Screwdriver Sets. Together, they can ensure accurate tightening of most every screw on any gun in your collection. **Bits are made from S2 tool steel and hardened to 56-58 Rockwell "C"**.

- Torque adjustment range from 10 inch/pounds to 65 inch/pounds
- Accuracy plus/minus 2 inch/pounds up to 40 inch/pounds; 40-65 is +/- 5%
- Convenient storage case included

The F.A.T. Wrench® / #553-556 / Case Pack of 4
Empty F.A.T. Wrench® Storage Case / #550-001
 Case Pack of 1



FAT Wrench clamshell package:
7.75" wide x 9.75" high x 3" deep



Space Saver GSS package:
9.75" wide x 7.5" high x 1.25" deep

Space Saver Gunsmithing Screwdriver Set / #664-507 / Case Pack of 1

Less than half the size of comparable gunsmithing screwdriver sets! The Wheeler Space Saver Gunsmithing Screwdriver Set takes up very little space on your bench, but contains a durable and comprehensive set of 26 bits chosen to meet most of your gunsmithing needs. Includes a selection of the same high quality bits found in the Professional Gunsmithing Screwdriver Sets. It's also the perfect size to include on your trips to the range and the field. Included with the standard, Phillips, hex, and torx bits, is a 2" long #2 Phillips bit which is ideal for recoil pad installation, and a hex-to-square conversion bit which allows you to use 1/4" square drive sockets and other attachments. The magnetic handle is perfectly sized for gunsmithing needs and is made of comfortable overmolded plastic.



Professional Scope Mount Kit package:
14.1" wide x 17.8" high x 2.3" deep



Professional Scope Mount Combo Kit package:
10" wide x 8" high x 3" deep



PATENT
PENDING



Professional Scope Mounting Kits

Complete kit provides everything necessary to mount a scope the correct way, including an instructional DVD. Proper scope installation is critical to the accuracy of your firearm. Get the most accuracy possible out of your gun by ensuring proper scope installation.

Alignment and Lapping of rings ensure maximum surface area contact between scope tube and rings. This not only helps the rings hold the scope more securely but also protects your scope from damage misalignment can cause. The Wheeler Alignment Bars, Lapping Bars and Lapping Compound allow you to achieve the perfect fit between scope and rings.

Reticle Leveling is also a key component to the accuracy of your set up. Crosshairs that are not properly leveled will result in errors in left/right windage especially at longer distances. Misalignment can also compromise true linear movement from turret adjustments. The Wheeler Level-Level-Level makes it quick and easy to get the reticle perfectly aligned with your gun.

Securing Fasteners properly is critical to accuracy as well. Precisely controlled torque along with thread locking compound will keep your scope held securely in place. Professional grade bits and the F.A.T. Wrench are the perfect combination to properly secure fasteners without deformation.

Complete list of components:

- Scope ring alignment bars
- Lapping compound
- F.A.T. Wrench
- Thread locking compound
- Scope ring lapping rod and handle
- Level-Level-Level
- 10 gunsmithing bits
- Scope mounting DVD

New Combo Case for 2011. The Professional Scope Mounting Kit Combo now comes standard with a convenient molded storage case. The case is designed with special pockets for all of the components in the combo kit. It also includes a pocket that will fit the new Professional Reticle Leveling System (not included) for those wishing to add this new, innovative product to their gunsmithing tool arsenal.

1" Professional Scope Mounting Kit / #540-127 / Case Pack of 1

30mm Professional Scope Mounting Kit / #274-117 / Case Pack of 1

Combo 1" & 30mm Professional Scope Mounting Kit / #545-454 / Case Pack of 1

NEW DESIGN
11





Reference Level

NEW FOR
11
TWENTY



Barrel Clamp Level



Professional Reticle Leveling System / #119050 / Case Pack of 1

Technological advances in today's modern firearms, ammunition and optics have enhanced the potential for long range accuracy. However, precision mounting and alignment of your system's scope is critical to realizing the accuracy. A scope's reticle must be precisely aligned with the weapon to ensure holdover or turret adjustments for bullet drop produce true vertical compensation for point of impact. If the crosshairs are canted left or right both elevation and windage bullet impact error will occur.

The Wheeler Professional Reticle Leveling System is a precision tool and technique designed to allow a scope to be perfectly leveled on any firearm with ease. CNC machining, factory adjusted calibration set screws, anodized aluminum construction and protective molded case put this instrument in a class of its own.

The system is comprised of two machined aluminum level housings calibrated to their integrated levels. The Barrel Clamp Level is attached to the guns barrel while the smaller Reference Level is placed on scope base, bottom half of a ring or other flat surface perpendicular to the vertical axis of the gun. The gun is then rotated until the Reference Level is aligned. The tuning adjustment knob on the Barrel Clamp Level is then turned until its level is centered to match the Reference Level. At this point the Barrel Clamp Level is calibrated to the guns axis. The Scope can be installed loosely and the Reference Level placed on top of the scopes turret cap. The scope is rotated until the Reference Level is aligned with the Barrel Clamp Level and then simply secured in place. The Wheeler PRLS is the most effective instrument available for precision scope alignment.

- Precision tool for scope reticle alignment
- Maximize accuracy potential
- CNC machined aluminum level housings
- Factory calibrated Reference Level
- Tunable Barrel Clamp Level
- Protective storage case

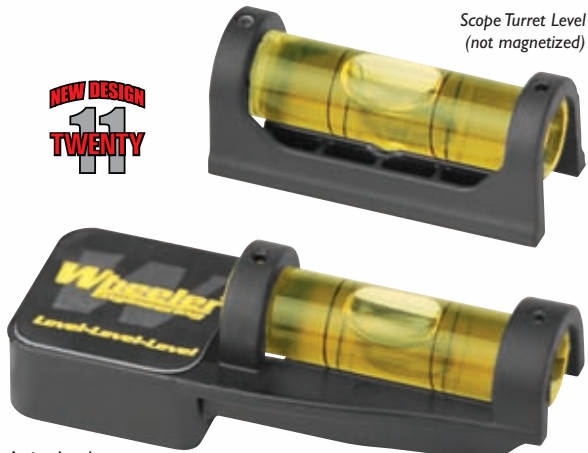

Scope Turret Level
(not magnetized)

Action Level
(magnetized)



PATENT
PENDING

Level-Level-Level / #113-088 / Case Pack of 4

The simplest, most accurate scope leveling system ever devised. Misaligned crosshairs rob you of accurate bullet placement, especially at long range, where it counts. Crooked crosshairs cause your scope adjustments to be unreliable, and even make zeroing your rifle a frustrating and costly experience. The Level-Level-Level works because the scope is leveled to your receiver. An accurate rifle requires level crosshairs, and the Level-Level-Level gives you the means to level your scope perfectly in only minutes. Level your scope as you mount it on your rifle. The magnetic base in the rifle level bridges the bolt raceway, allowing you to position your rifle perfectly level. Then level the scope, tighten the rings, and the job is done. Works with practically any bolt-action rifle, and is adaptable to other designs.

Package: 4" wide x
7.5" high x .5" deep





Package: 4.5" wide x
14.75" high x 1.25" deep



Trigger Pull Scale / #309-888 / Case Pack of 4

The Trigger Pull Scale accurately measures trigger pull weight from 8 ounces to 8 pounds. It features an ergonomically shaped handle for consistent direction of pull. Highly visible increment markings and an easy-to-read sliding indicator that stays on the maximum weight registered, make it easy to use. It measures in 2 oz. increments and is accurate to +/- 2 oz.

The Trigger Pull Scale is an excellent tool for use when adjusting triggers to ensure accuracy and maintain safe performance.

- Accurately measures trigger pull
- Easy-to-read sliding indicator
- Ranges from 8 oz. to 8 lbs.

78



Scope Ring Alignment and Lapping Kit

Aligning and lapping of new rings should become the standard practice whenever a scope is installed on a quality firearm. The alignment bars in this kit provide for perfect alignment of both rings and will also diagnose any misalignment problem, vertical or horizontal, giving you the opportunity to fix the problem before damaging the scope or experiencing frustration at the range. The lapping bar is used to lap the rings to improve alignment, reduce stress on the scope and improve the grip of the rings on the scope. It also serves as a lever to rotate dovetail rings into place. Lapping the rings can also minimize or prevent ring marring of the scope. Kit includes: Two alignment bars, lapping bar, lapping bar handle, 220 grit lapping compound and complete instructions.

Scope Ring Alignment and Lapping Kit - 1" Rings / #204-061 / Case Pack of 1

Scope Ring Alignment and Lapping Kit - 30mm Rings / #633-266 / Case Pack of 1

Scope Ring Alignment and Lapping Kit Combo (1" and 30mm) / #305-172 / Case Pack of 1

Lapping Compound Kit (1 each 220, 320, and 600 grit compound) / #342-303 / Case Pack of 1

Scope Ring Alignment Bar - 1" / #781-366 / Case Pack of 1

Scope Ring Alignment Bar - 30mm / #409-501 / Case Pack of 1



Bore Lapping Kit

Lap your barrels to make them shoot better and easier to clean. Lapping polishes out the tool marks left in rifle barrels during manufacturing. Traditional hand-lapping is very labor intensive and requires pushing lead slugs down the bore by hand. The Wheeler kit allows you to embed lead or jacketed bullets with abrasive and fire them through your barrel. Lapping is as easy as roll, load, and shoot. Works in everything from old .22 rimfires to neglected hunting rifles. Works to improve all but the very roughest bores. The results in appearance and performance can be surprising. Kit includes three jars of high quality abrasive pastes, two steel embedding plates, and complete instructions.

Bore Lapping Kit / #299-849 / Case Pack of 1

220 Grit Lapping Compound, 1 oz. jar / #885-040 / Case Pack of 1

320 Grit Lapping Compound, 1 oz. jar / #378-413 / Case Pack of 1

600 Grit Lapping Compound, 1 oz. jar / #395-155 / Case Pack of 1

Lapping Compound Kit (1 each 220, 320, and 600 grit compound) / #342-303 / Case Pack of 1





Hammer and Punch Set

#951-900 / Case Pack of 1

The Wheeler Hammer and Punch Set includes a polymer/brass combination hammer, eight precision brass punches, four steel punches, and two plastic punches. It comes in a handy molded case. It makes a great tool for driving pins, drifting sights, at the shooting range or on your gunsmithing bench.



Hammer and Punch package:
5.25" wide x 11" high x 1.75" deep

Punch Sets

Quality crafted Steel and Brass Punch Sets assist the gunsmith in assembly and disassembly of all kinds of firearms. Reduce the chances of marring and burring that can occur with improperly sized or makeshift punches. Both Steel and Brass Sets contain eight precision crafted pin punches in sizes you can use. Steel: 1/16", 3/32", 1/8", 5/32", 3/16", 7/32", 1/4", 5/16". Brass: 1/8", 9/64", 5/32", 3/16", 7/32", 1/4", 9/32", 5/16". The larger non-marring brass punches are particularly useful for drifting sights. Handy roll-up pouch keeps your punches clean and in order. Overall length 4".

Brass / #780-194 / Case Pack of 1



Letter and Number Stamp Set / #194-679 / Case Pack of 1

The Wheeler Engineering Letter and Number Stamp Set is especially useful for marking caliber designations on barrels, but you'll find yourself marking tools, keys, and other metal items with these 1/16" high stamps.



Nylon/Brass Hammer / #711-016 / Case Pack of 5

Likely to become your favorite hammer at the bench or on the range. Nylon face is non-marring and is great for alignment and other uses where a steel hammer is not appropriate. Brass face can be used for driving pins and punches, and a multitude of other uses. 11" overall. Weighs 8 oz.



Action Wrenches and Barrel Vise

Heavy-duty tools to deliver the strength and rigidity required for proper barrel removal and installation. The Action Wrench safely surrounds and supports the receiver ring. The 15" long, 1" diameter steel handle will overcome even the tightest assemblies. The double-ended Savage Barrel Nut Wrench fits both early and late model nuts on the 110 and 10 series rifles, and features two 1/2" square drive holes for a swing bar or torque wrench. The Barrel Vise provides plenty of holding force to securely clamp your barrel for removal or installation. The Vise includes two pre-drilled oak blocks, 1" and 3/4", and a solid block for custom drilling. **Case Pack of 1.**

Action Wrench #1 (Mausers with Flat-Bottomed Receivers) / #808-771

Action Wrench #2 (Remington 700) / #414-521

Savage Barrel Nut Wrench / #123-038

Barrel Vise with 3 Oak Bushings / #465-185

Set of 3 Replacement Oak Bushings / #844-879

Lead Barrel Vise Shims (4 Pack) / #239-444

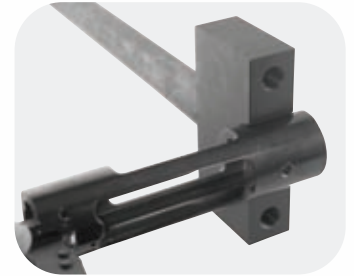

Universal Bench Block / #672-215 / Case Pack of 5

For firearm assembly and disassembly, the Universal Bench Block is your best friend. It features a variety of notches, grooves, and holes on both sides and is ideally suited for M1911-style pistols. Need to install a pin, detent, or spring? The Universal Bench Block is the answer. 1-5/16" high, 4" in diameter. Non-marring urethane for long use.

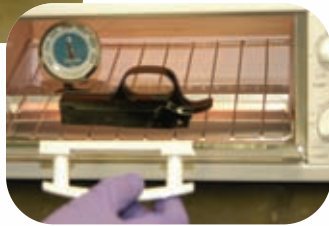

Cerama-Coat Package:
4" wide x 8.3" high x 2.3" deep

Cerama-Coat / #468-993 / Case Pack of 4

Wheeler Engineering's Cerama-Coat is a spray-on metal finish that brings new life to old guns without expensive airbrushes or painting equipment. This one-can solution is the toughest metal finish available. This is an ultra-modern formula that contains a ceramic matrix, giving the finish ultimate durability, wear-resistance, and protection against rust and solvents. The matte black color won't spook game and looks great on any gun. Applying Cerama-Coat is easy. Degrease the item to be coated, shake the Cerama-Coat can vigorously and spray the parts with three light coats of finish. Bake the part in an oven at 350 degrees for 1 hour to cure the finish, and you'll have a finish ready to take the very worst that mother nature can dish out. Each can contains enough to refinish two long guns. Not for use on wood, plastics, or scopes.



Stainless Steel Picks / #324-770 / Case Pack of 10

You'll wonder how you ever got along without these handy tools. Useful for a variety of functions including assembly and disassembly of firearms (especially helpful for hooking and unhooking springs), scraping dirt and residue from hard to reach places, scribing lines in both metal and wood, etc. Four separate double-ended tools offer eight distinctly different picks to accommodate your needs.

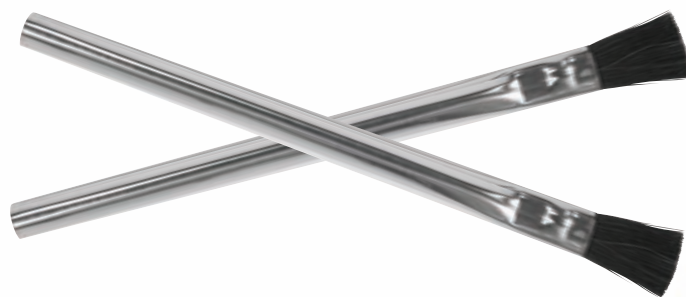

Liquid Applicator Brush

These 100% natural bristle brushes are the perfect tools for application of small amounts of lubes, solvents, Heat Control Paste, blue and rust remover, fluxes, and other liquid products in the shop. Each brush features a 1/2" wide head, bright metal handle, and is 6" in overall length. **Case Pack of 10.**

Liquid Applicator Brushes, 12 qty. / #836-940

Battenfeld Technologies proudly advertises with these fine TV Channels, Shows and Publications. Battenfeld has stepped up it's advertising campaign again for 2011 which means we're driving more customers to your stores in search of our products.

82



WEBSITE / DEALER SUPPORT

Check us out on line at www.Battenfeldtechnologies.com We continually add new products and great content such as product demonstration videos for training and consumer awareness. Other convenient features like a dealer locator, catalog downloads, hi-res images and product instructions are all available for dealers as well as consumers. Or just let us know what you think of our products with our on line surveys and product feedback forms.

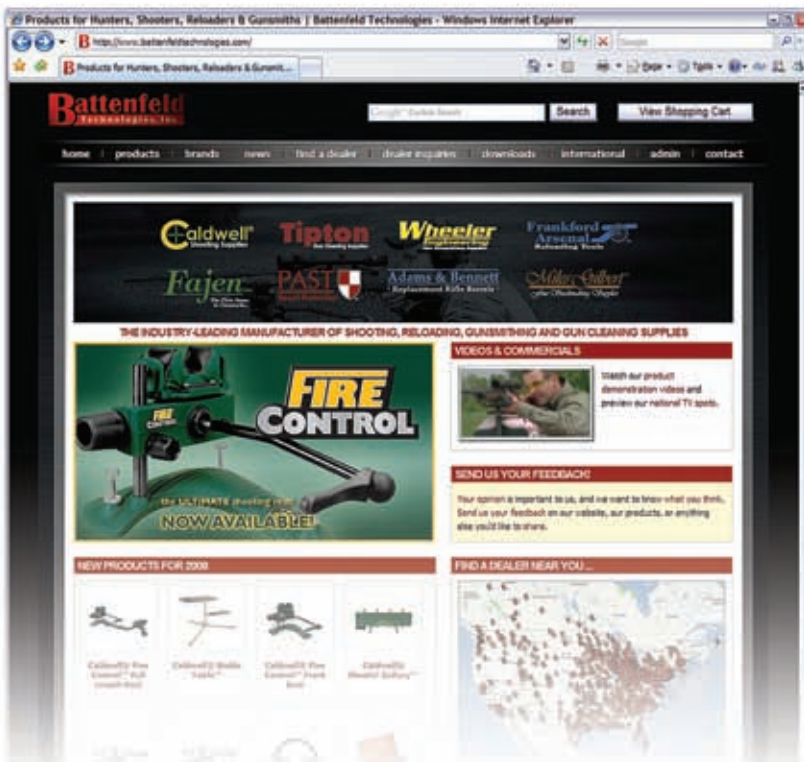



www.battenfeldtechnologies.com

Battenfeld Technologies is the industry leading manufacturer of shooting, reloading, gunsmithing and gun cleaning supplies. We produce innovative, top quality products under the brands consumers recognize and have learned to trust. Our Engineering staff is dedicated to delivering superior products through an intensive ISO 9001:2000 process. With great retail packaging, an aggressive advertising campaign and a professional staff focused on customer service Battenfeld is committed to excellence and eager to earn your business.



Caldwell Shooting Supplies are engineered with innovative designs and steadfast performance specifications for the most discriminating shooters in mind. Our products are created specifically with the needs of a shooter in mind-by a team of experienced shooters. When you head for the range to sight in, do some target practicing, develop load testing or for some serious shooting, you only need to remember one name – Caldwell. From targets and target stands to Rock Solid shooting rests, Caldwell has all your range equipment needs



If there were a Gunstock Hall of Fame, Reinhart Fajen would be in the first class of inductees. For over 50 years, the brand name Fajen has meant one thing to custom gun builders-elegant gunstocks produced by an artisan. Fajen stocks are now more available throughout the world than ever, with the same high-degree of craftsmanship and detail. No other brand of gunstocks has captured the imagination of the world's shooters and hunters quite like Fajen.



There have always been a few hunters and shooters searching for the Holy Grail of accuracy - a rifle capable of five shots in one jagged hole. Benchrest shooters and prairie dog hunters, firing precision reloads, are in the forefront of this quest. With this in mind, Adams and Bennett has developed a line of barrels that gives a shooter the ability to achieve their accuracy goals at an affordable price. This rare combination makes Adams and Bennett Barrels an unbeatable value. No matter what your barrel needs are; when you want "affordable accuracy", think of Adams and Bennett first.



There are few veteran reloaders who are not familiar with the famous initials "FA" on military 30/06 brass – and for good reason. The original Frankford Arsenal Army Ammunition Plant was constructed between 1816 and 1830. In addition to massive small arms ammunition production, Frankford Arsenal was responsible for almost all of the research and development and manufacture of U.S.Army field reloading equipment for the 45/70, 50/70, 30/40 Krag and 30/06 – beginning in the 1880's.

Today, Battenfeld carries on that same spirit through our branded Frankford Arsenal reloading products. By offering well-designed and quality products, we have reestablished Frankford Arsenal as one of the world's leading brands of metallic reloading equipment in hopes of preserving this famous name.



LOCKDOWN is the most comprehensive line of vault accessories available today. Featuring a wide variety of items designed to enhance organization, control climate and generally improve the usability of your vault have all come together under this exciting new brand. The vision behind LOCKDOWN is to significantly enhance the organization and accessibility of items inside any vault and to ensure their condition is preserved. A commitment to high quality, innovative products sets LOCKDOWN apart from the competition.



Stockmaking is often thought of as an art form that only the hardened hands of 3rd generation artisans can perform. While the intricate lines and flowing curves they produce are elegant, they are also attainable for most-with the proper tools. Miles Gilbert Fine Stockmaking Supplies are designed with the inherent insight of those 3rd generation craftsmen, to enable professionals, and the home hobbyist, to produce professional results with quality tools. With the expert guidance of our instructions and the aide of our well thought out tools, you will be taking pride in your artisan – like results.



PAST Recoil Protection is the foremost shooting industry leader in wearable recoil protection and is the most widely recognized by the shooting public. Over our many years, our designers have discovered and engineered a patented foam material that dramatically reduces the effect of felt recoil energy transferred in rifle, shotgun and handgun shooting. This patented foam material absorbs and spreads the recoil impulse, significantly reducing the recoil felt by the shooter-making shooting more enjoyable.



Cleaning and maintaining firearms is either a passion or a chore, depending on your perspective. In either case, the Tipton line of cleaning products is designed to make the job faster and more convenient. With more attention being paid to cleaning and maintaining firearms than ever before, there is clear need for tools and fixtures to enhance the cleaning process. The folks at Tipton are here to help and they want to remind you that no shooting session is complete until the guns are properly cleaned.



Gunsmiths around the world require tools that offer quality, innovation and years of dependable service - at a fair price. Wheeler tools are extremely high quality and most are priced below similar products, making them affordable for both the professional gunsmith and the home do-it-yourselfer. Because of this dedication to quality, service and value, the folks at Wheeler Engineering are committed to meeting the expectations of all gunsmiths – professional, amateur



VAULT ACCESSORIES



YOUR GUN VAULT, ONLY SMARTER.

LOCKDOWN is the most comprehensive line of vault accessories available today. A wide variety of items designed to enhance organization, control climate and generally improve the usability of your vault have all come together under this exciting new brand. The vision behind LOCKDOWN is to significantly enhance the organization and accessibility of items inside any vault and to ensure their condition is preserved. A commitment to high quality, innovative products sets LOCKDOWN apart from the competition. Get the most out of your vault with LOCKDOWN solutions.

Battenfeld
Technologies, Inc.