



INSTRUCTION MANUAL
NexStar 80GTL

TABLE OF CONTENTS

INTRODUCTION	4
Warning.....	4
ASSEMBLY	5
Assembling the NexStar.....	6
Attaching the Telescope to the Tripod.....	7
Balancing the Telescope tube.....	7
The Erect Image Diagonal.....	7
The Eyepiece.....	8
Focusing.....	8
The Star Pointer Finderscope.....	8
Star Pointer Installation.....	9
Star Pointer Operationn.....	9
Using your Solar Filter.....	10
HAND CONTROL	11
Attaching the Hand Control.....	11
Powering the NexStar.....	11
The Hand Control.....	11
Hand Control Operation.....	13
Alignment Procedure.....	13
Auto-Align.....	13
Two Star Alignment.....	14
Quick-Align.....	15
NexStar Re-Alignment.....	15
Object Catalog.....	16
Selecting an Object.....	16
Slewing to an Object.....	16
Tour Mode.....	16
Direction Buttons.....	17
Rate Button.....	17
Set Up Procedures.....	17
Tracking Mode.....	17
Tracking Rate.....	18
View Time-Site.....	18
Sidereal Time.....	18
Filter Limits.....	18
RS-232.....	18
User Defined Objects.....	18
Get RA/DEC.....	19
Get Alt-Az.....	19
Goto R.A/Dec.....	19
Goto Alt-Az.....	19
Utility Features.....	19
Setup Time-Site.....	19
Anti-backlash.....	19
Slew Limits.....	20
Direction Buttons.....	20
Light Control.....	20
Select Model.....	20
TELESCOPE BASICS	22
Focusing.....	22
Image Orientation.....	22
Calculating Magnification.....	22
Determining Field of View.....	23
General Observing Hints.....	23
CELESTIAL OBSERVING	24
Observing the Moon.....	24
Lunar Observing Hints.....	24
Observing the Planets.....	24
Planetary Observing Hints.....	24

Observing the Sun	24
Solar Observing Hints	25
Observing Deep Sky Objects.....	25
Terrestrial (Land) Viewing.....	25
Terrestrial (Land) Viewing Hints	25
Seeing Conditions.....	25
Transparency	25
Sky Illumination.....	26
Seeing.....	26
TELESCOPE MAINTENANCE	27
Care and Cleaning of the Optics.....	27
OPTIONAL ACCESSORIES	28
APPENDIX A - TECHNICAL SPECIFICATIONS	30
APPENDIX B – GLOSSARY OF TERMS	31
APPENDIX C – RS 232 CONNECTION	34
Communication Protocol:.....	34
APPENDIX D – TIME ZONE MAPS	35
SKY MAPS	37

Introduction

Congratulations on your purchase of the Celestron NexStar! The NexStar ushers in a whole new generation of computer automated technology. Simple and friendly to use, the NexStar is up and running after locating just two alignment stars. It's the perfect combination of power and portability. If you are new to astronomy, you may wish to start off by using the NexStar's built-in Sky Tour feature, which commands the NexStar to find the most interesting objects in the sky and automatically slews to each one. Or if you are an experienced amateur, you will appreciate the comprehensive database of over 4,000 objects, including customized lists of all the best deep-sky objects, bright double stars and variable stars. No matter at what level you are starting out, the NexStar will unfold for you and your friends all the wonders of the Universe.

Some of the many standard features of the NexStar include:

- Incredible 4°/second slew speed.
- Fully enclosed motors and optical encoders for position location.
- Computerized hand controller with 4,000 object database.
- Storage for programmable user defined objects; and
- Many other high performance features!

The NexStar's deluxe features combined with Celestron's legendary optical standards give amateur astronomers one of the most sophisticated and easy to use telescopes available on the market today.

Take time to read through this manual before embarking on your journey through the Universe. It may take a few observing sessions to become familiar with your NexStar, so you should keep this manual handy until you have fully mastered your telescope's operation. The NexStar hand control has built-in instructions to guide you through all the alignment procedures needed to have the telescope up and running in minutes. Use this manual in conjunction with the on-screen instructions provided by the hand control. The manual gives detailed information regarding each step as well as needed reference material and helpful hints guaranteed to make your observing experience as simple and pleasurable as possible.

Your NexStar telescope is designed to give you years of fun and rewarding observations. However, there are a few things to consider before using your telescope that will ensure your safety and protect your equipment.

Warning



- Never look directly at the sun with the naked eye or with a telescope (unless using your Celestron solar filter). Permanent and irreversible eye damage may result.
- Never use your telescope to project an image of the sun onto any surface. Internal heat build-up can damage the telescope and any accessories attached to it.
- Never use an eyepiece solar filter or a Herschel wedge. Internal heat build-up inside the telescope can cause these devices to crack or break, allowing unfiltered sunlight to pass through to the eye.
- Never leave the telescope unsupervised, either when children are present or adults who may not be familiar with the correct operating procedures of your telescope.

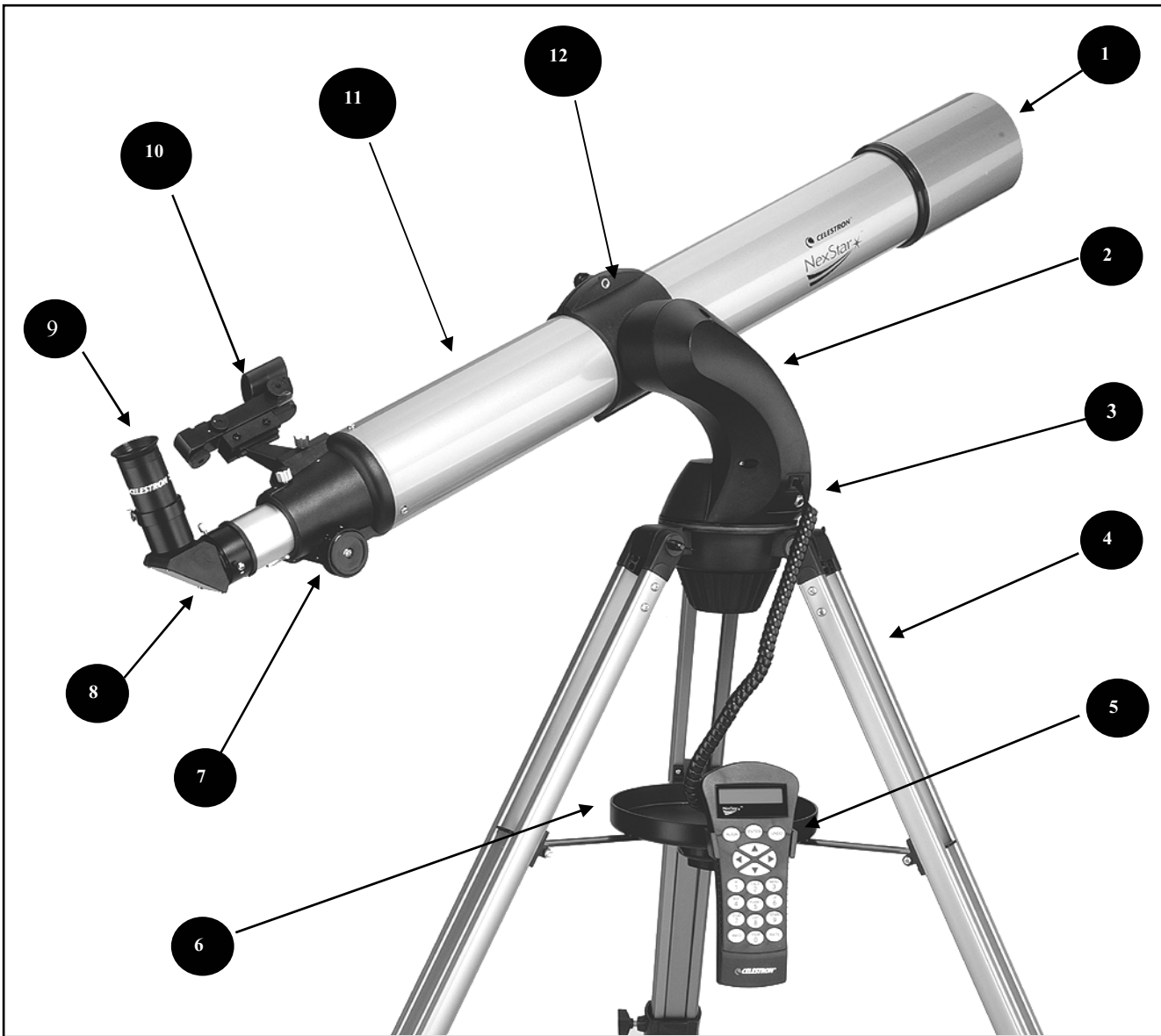

**The NexStar 80GTL
Refractor Telescope**

1	Objective Lens	7	Focuser Knob
2	Fork Arm	8	Erect Image Diagonal - 90°
3	Power Outlet	9	Eyepiece
4	Tripod	10	Star Pointer Finderscope
5	Hand Control	11	Optical Tube
6	Accessory Tray w/ hand control holder	12	Tube Ring Clamp

CELESTRON Assembly

The NexStar comes partially assembled and can be operational in a matter of minutes. The NexStar is conveniently packaged in one reusable shipping carton that contains the following accessories:

NexStar 80 GTL
25mm & 10mm Eyepieces – 1¼"
1¼" Erect Image Diagonal
Star Pointer Finderscope and Mounting Bracket
Deluxe Accessory Tray
Battery Pack
Solar Filter
The Sky™ Level 1 Astronomy Software
Telescope Control Software
NexStar Hand Control w/ Object Database

Assembling the NexStar

Your NexStar comes in three major sections: the optical tube, fork arm and the tripod. These sections can be attached in seconds using the quick release coupling screw located under the tripod mounting platform. Remove all of the accessories from their individual boxes. Remember to save all of the containers so that they can be used to transport the telescope. Before attaching the visual accessories, the telescope tube should be mounted to its tripod. First, install the accessory tray onto the tripod legs:

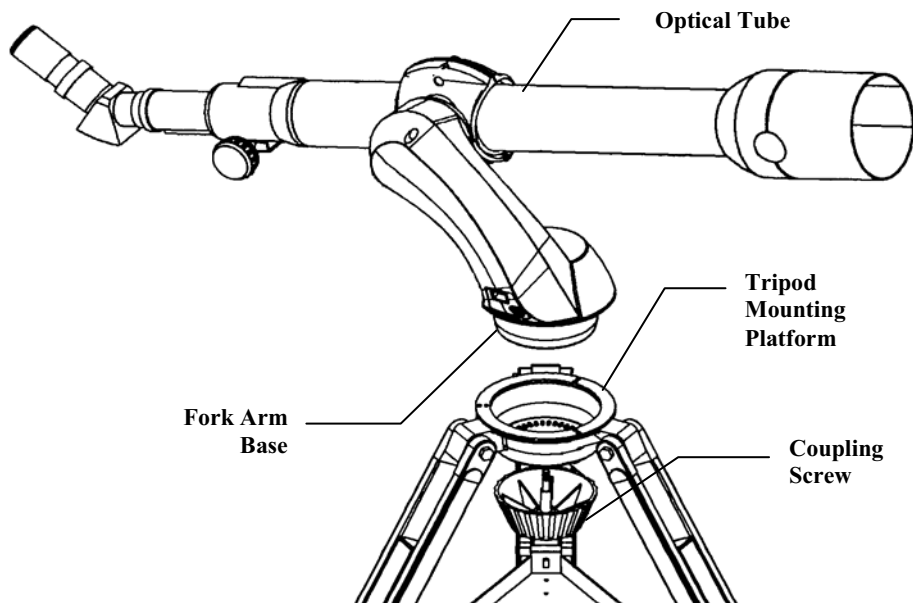

Figure 2-1

1. Remove the tripod from the box and spread the legs apart until the center leg brace is fully extended.
2. Locate the accessory tray, and place it on top of the tripod center support brace in between the tripod legs (see figure 2-2).

3. From underneath the tripod support brace, thread the locking bolt into the hole in the center of the accessory tray. Do not over tighten.

The accessory tray has a built-on hand control holder protruding from the side. The back of the hand control has an opening that slides over the clip on the inside of the holder.

It is a good idea to adjust the height of the tripod before attaching the fork arm and tube. Minor adjustments can be made later. To adjust the height of the tripod legs:

Loosen the tripod leg locking bolt located on the side of each leg.

1. Slide the inner portion of each leg down 6" to 8" inches.
2. Tighten the tripod locking bolts to hold each leg in place.

Attaching the Telescope to the Tripod

With the tripod properly assembled, the telescope tube and fork arm can easily be attached using the quick release coupling screw located underneath the tripod mounting platform:

1. Hold the telescope tube assembly by the fork arm and place the fork arm base inside the tripod mounting platform. See Figure 2-1.
2. Thread the coupling screw into the hole at the bottom of the fork arm base and hand tighten.

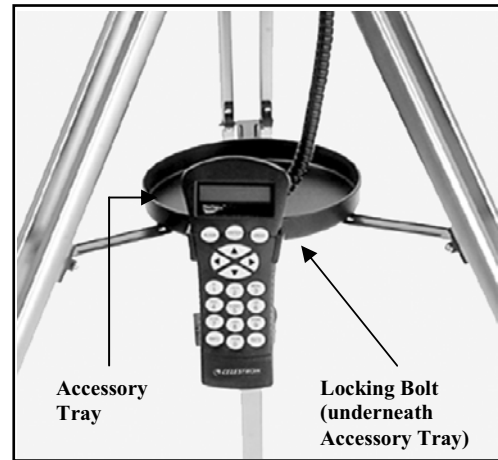

Figure 2-2 – The Accessory Tray/ Hand Control Holder

Balancing the Telescope tube

To ensure optimal performance from your NexStar 80 it is necessary to properly balance the telescope tube inside the tube ring. To assist in balancing the tube, the NexStar 80 has a Solar Warning sticker to help you position the tube. To balance the tube, simply loosen the tube clamp locking screw and slide the telescope tube forward or back until the edge of the tube ring is aligned with the line at the top of the Solar Warning sticker. (see Figure 2-3)

Your NexStar is fully assembled and is ready to attach the accessories.

The Erect Image Diagonal

The diagonal diverts the light at a right angle from the light path of the telescope. For astronomical observing, this allows you to observe in positions that are more comfortable than if you were to look straight through the tube. For daytime viewing, the diagonal uses an erecting prism that allows you see land objects right-side-up To attach the diagonal:

1. Turn the thumbscrew on the eyepiece adapter at the end of the focuser barrel until it no longer extends into (i.e., obstructs) the inner diameter of the focus barrel. Remove the protective dust cap from the focuser barrel.
2. Slide the chrome portion of the diagonal into the eyepiece adapter.
3. Tighten the thumbscrew on the eyepiece adapter to hold the diagonal in place.

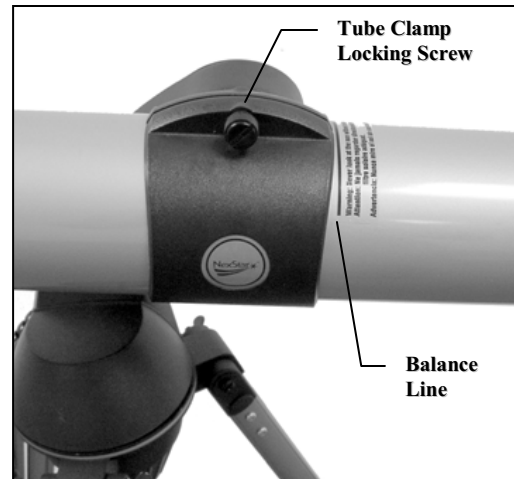

Figure 2-3 – Balancing the Telescope Tube

If you wish to change the orientation of the star diagonal, loosen the thumbscrew on the eyepiece adapter until the star diagonal rotates freely. Rotate the diagonal to the desired position and tighten the thumbscrew.

The Eyepiece

The eyepiece, is the optical element that magnifies the image focused by the telescope. The eyepiece fits either directly into the focuser or into the diagonal. To install the eyepiece:

1. Loosen the thumbscrew on the diagonal so it does not obstruct the inner diameter of the barrel. Remove the protective dust cap from the diagonal's barrel.
2. Slide the chrome portion of the low power 25mm eyepiece into the diagonal.
3. Tighten the thumbscrew to hold the eyepiece in place.

To remove the eyepiece, loosen the thumbscrew on the diagonal and slide the eyepiece out.

Eyepieces are commonly referred to by focal length and barrel diameter. The focal length of each eyepiece is printed on the eyepiece barrel. The longer the focal length (i.e., the larger the number) the lower the eyepiece power or magnification; and the shorter the focal length (i.e., the smaller the number) the higher the magnification. Generally, you will use low-to-moderate power when viewing. For more information on how to determine power, see the section on “Calculating Magnification.”

Barrel diameter is the diameter of the barrel that slides into the star diagonal or focuser. The NexStar uses eyepieces with a standard 1-1/4" barrel diameter.

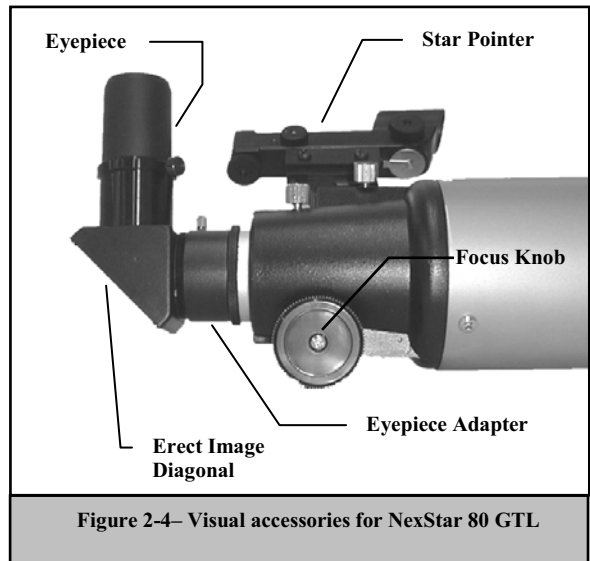

Figure 2-4– Visual accessories for NexStar 80 GTL

Focusing

To focus your telescope, simply turn either of the focus knobs on the sides of the focuser (see figures 2-4). Turn the focus knob until the image is sharp. Once sharp, turn the knob towards you to focus on an object that is closer than the one you are currently observing. Turn the knob away from you to focus on a more distant object than the one you are currently observing.

The Star Pointer Finderscope

The Star Pointer is the quickest and easiest way to point your telescope exactly at a desired object in the sky. It's like having a laser pointer that you can shine directly onto the night sky. The Star Pointer is a zero magnification pointing tool that uses a coated glass window to superimpose the image of a small red dot onto the night sky. While keeping both eyes open when looking through the Star Pointer, simply move your telescope until the red dot, seen through the Star Pointer, merges with the object as seen with your unaided eye. The red dot is produced by a light-emitting diode (LED); it is not a laser beam and will

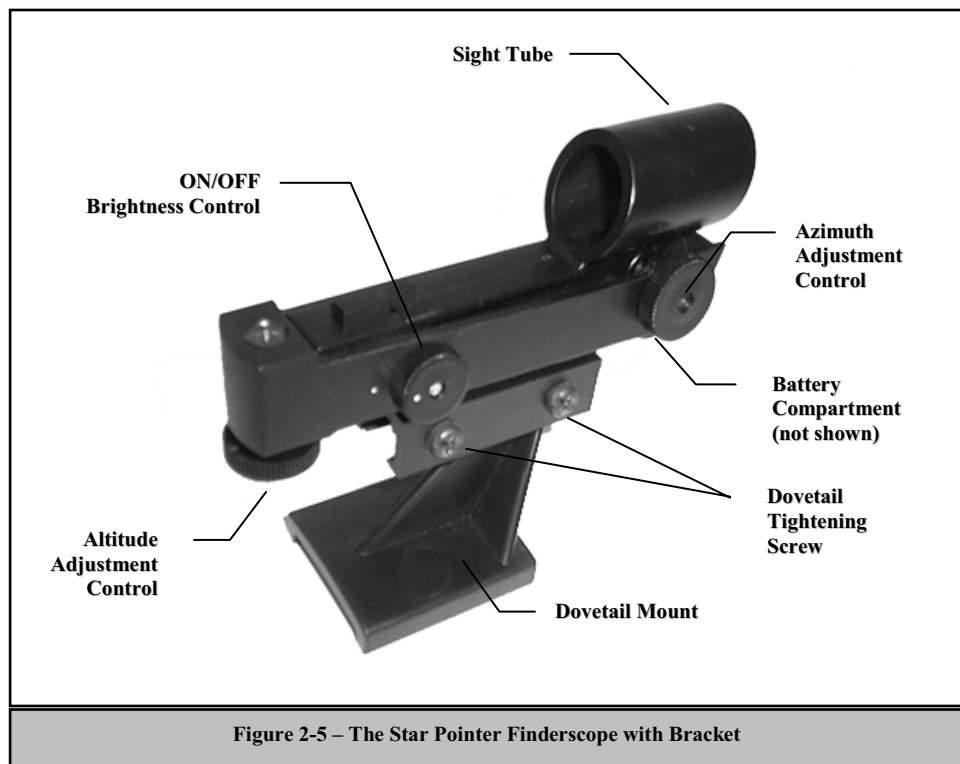

Figure 2-5 – The Star Pointer Finderscope with Bracket

not damage the glass window or your eye. The Star Pointer comes equipped with a variable brightness control, two axes alignment control and mounting brackets. Before the Star Pointer is ready to be used, it must be attached to the telescope tube and properly aligned:

Star Pointer Installation

1. Slide the Star Pointer bracket into the dovetail mounting platform on top of the focuser assembly (see figure 2-6).
2. Orient the Star Pointer so that the sight tube is facing towards the front of the tube.
3. Secure the Star Pointer bracket by tightening the thumb screw on the mounting platform.

Star Pointer Operation

The star pointer is powered by a long life 3-volt lithium battery (#CR2032) located underneath the front portion of the Star Pointer. Like all finderscopes, the Star Pointer must be properly aligned with the main telescope before it can be used. This is a simple process using the azimuth and altitude control knobs located on the side and bottom of the Star Pointer. The alignment procedure is best done at night since the LED dot will be difficult to see during the day. **Note: Before using the StarPointer, you must first remove the protective plastic cover over the battery (see figure 2-7).**

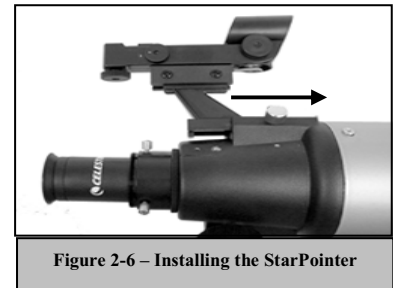

Figure 2-6 – Installing the StarPointer

1. To turn on the Star Pointer, rotate the variable brightness control (see figure 2-5) clockwise until you here a "click". To increase the brightness level of the red dot, continue rotating the control knob about 180° until it stops.
2. Locate a bright star or planet and center it in a low power eyepiece in the main telescope.
3. With both eyes open, look through the glass window at the alignment star.

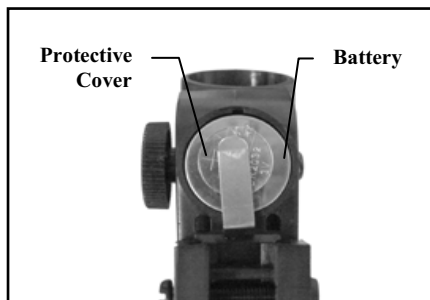

Figure 2-7 – Battery Compartment

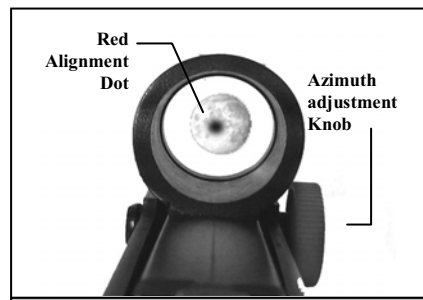

Figure 2-8 – Aligning the StarPointer

If the Star Pointer is perfectly aligned, you will see the red LED dot overlap the alignment star. If the Star Pointer is not aligned, take notice of where the red dot is relative to the bright star.

4. Without moving the main telescope, turn the Star Pointer's azimuth and altitude alignment controls (see figure 2-5) until the red dot is directly over the alignment object.

If the LED dot is brighter than the alignment star, it may make it difficult to see the star. Turn the brightness control counterclockwise, until the red dot is the same brightness as the alignment star. This will make it easier to get an accurate alignment. The Star Pointer is now ready to be used.

Using your Solar Filter

Solar observing is one of the most rewarding forms of celestial observations. Yet, because the Sun is so bright, special precautions must be taken to ensure your safety and protect your equipment. **Therefore, read these instructions through completely BEFORE you attempt to use your solar filter.**

A Word of Caution

Never look through the StarPointer finderscope when pointed at the Sun.

About the Filter

The Celestron AstroSolar™ solar filter by Baader allows direct observations of the Sun in complete safety. The filter, which transmits .00001% of the Sun's visible light, allows you to see the outer atmosphere of the Sun including such features as sunspots, granules and faculae. The material used to make these filters is a precision engineered, high-strength polymer that is ion implanted and metallized with a tough, neutral color layer on both sides of the film.

The Appearance

One of the first things you may notice when you remove your solar filter from the box is that the film is slightly wrinkled. This is the way the filter is supposed to look. The best resolution is obtained when the material is slightly relaxed or wrinkled.

Installation and Use

Before installing the solar filter, you should always inspect the surface of the filter for holes or other damage. To inspect the filter, hold it up to a bright light source (other than the Sun) like a white wall reflecting sunlight or a patch of blue sky away from the sun. Look for any light that may be passing through the filter. If any light is visible, the filter should **NOT** be used.

To install the filter, point your telescope away from the Sun and remove the lens cap. Now, place the solar filter over the front lens or opening of the telescope. Push the filter cell until the inside of the filter cell is flush against the end of the tube. The filter should be tight enough so that it will **NOT** fall off when the telescope is pointed toward the ground.

Once the solar filter is securely in place you are ready for your first look. To do so, point the telescope in the general direction of the Sun. Now, look at the shadow of the telescope tube, which will indicate how close you are to the Sun. Look closely at the shadow cast by the StarPointer finderscope. When you see light shining through the StarPointer's sight tube you are approaching the Sun. The more elongated the light, the farther away from the Sun you are pointing. When the light is circular, you should be pointing directly at the Sun. Look through a low power eyepiece to see if the solar image is there. If not, slowly sweep around until the sun comes into the field.

Cleaning and Storage

To clean the filter, use a photographic cleaning brush to remove dust and other debris. **Never rub the filter.** Be sure that when handling your solar filter not to touch the filter itself. When not in use, store your filter in its box. Place the box in a dry, warm environment that is relatively dust free. Moisture on the filter can and will degrade the performance. Do **not** use the filter if AstroSolar film is punctured in any way.

For tips on viewing the Sun through your filter, see the *Celestial Observing* section of this manual.

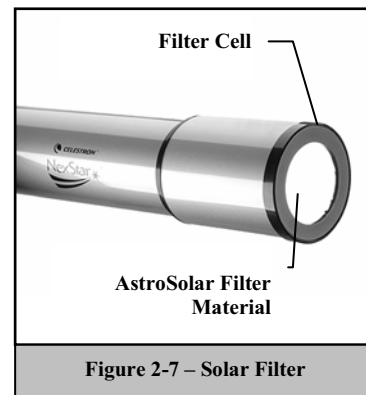

CELESTRON Hand Control

Attaching the Hand Control

The NexStar GT hand control has a phone jack type connector at the end of its cord. Plug the phone jack connector into the outlet at the base of the telescope's fork arm. Push the connector into the outlet until it clicks into place and place the hand control into its holder as described previously in the Assembly section of the manual.

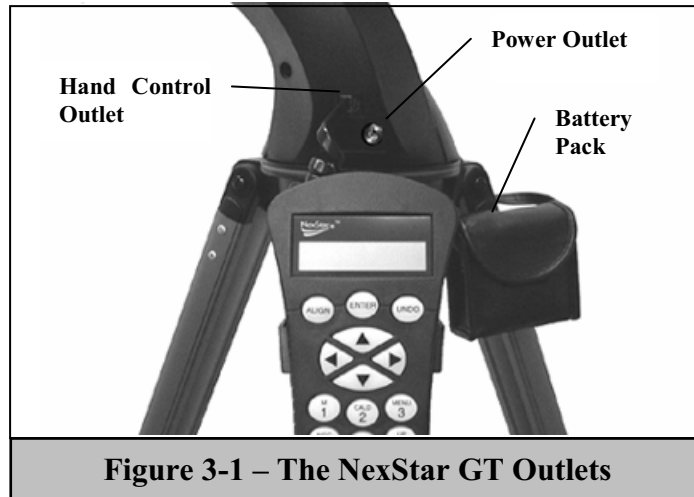

Powering the NexStar

The NexStar GT can be powered by the supplied battery pack or an optional 12v AC adapter. The power pack requires 8 user supplied AA size alkaline batteries. To power the NexStar, insert the batteries into the battery pack and plug the round post into the 12v outlet located on the side of the fork arm. Once the battery pack is plugged in, the NexStar will power on and the red backlight on the hand control display will come on.

Note

In case of a loss of power, the optical tube can be moved by hand. However, when powered on, the telescope should always be controlled via the hand control. The NexStar will lose its star alignment if moved by hand when powered on.

The Hand Control

The NexStar GT's hand controller is designed to give you instant access to all the functions the NexStar has to offer. With automatic slewing to over 4,000 objects, and common sense menu descriptions, even a beginner can master its variety of features in just a few observing sessions. Below is a brief description of the individual components of the NexStar GT hand controller:

1. **Liquid Crystal Display (LCD) Window:** Has a dual-line, 16 character display screen that is backlit for comfortable viewing of telescope information and scrolling text.
2. **Align:** Instructs the NexStar to use a selected star or object as an alignment position.
3. **Direction Keys:** Allows complete control of the NexStar in any direction. Use the direction keys to center objects in the StarPointer finderscope and eyepiece.
4. **Catalog Keys:** The NexStar has a key on the hand control to allow direct access to each of the catalogs in its 4,000+ object database. The NexStar contains the following catalogs in its database:
 - Messier* – Complete list of all Messier objects.
 - NGC* – Many of the brightest deep sky objects from the Revised New General Catalog.
 - Caldwell* – A combination of the best NGC and IC objects.

Planets - All 8 planets in our Solar System plus the Moon.

Stars - A compiled list of the brightest stars from the SAO catalog.

List - For quick access, all of the best and most popular objects in the NexStar database have been broken down into lists based on their type and/or common name:

Named Stars	Common name listing of the brightest stars in the sky.
Named Objects	Alphabetical listing of over 50 of the most popular deep sky objects.
Double Stars	Alphabetical listing of the most visually stunning double, triple and quadruple stars in the sky.
Variable Stars	Select list of the brightest variable stars with the shortest period of changing magnitude.
Asterisms	A unique list of some of the most recognizable star patterns in the sky.

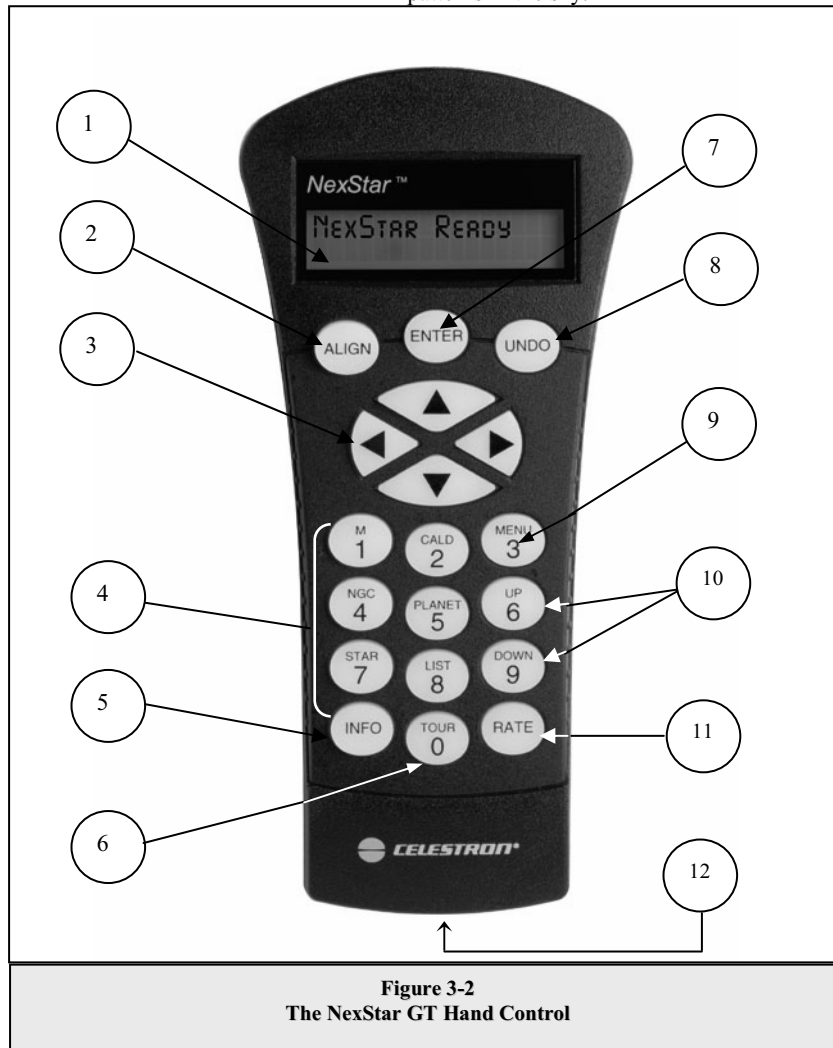

Figure 3-2
The NexStar GT Hand Control

5. **Info:** Displays coordinates and useful information about objects selected from the NexStar database.
6. **Tour:** Activates the tour mode, which seeks out all the best objects for a given month and automatically slews the NexStar to those objects.
7. **Enter:** Pressing *Enter* allows you to select any of the NexStar functions, accept entered parameters and slew the telescope to displayed objects.
8. **Undo:** *Undo* will take you out of the current menu and display the previous level of the menu path. Press *Undo* repeatedly to get back to a main menu or use it to erase data entered by mistake.
9. **Menu:** Displays the many setup and utilities functions such as tracking rate and user defined objects and many others.

10. **Scroll Keys:** Used to scroll up and down within any of the menu lists. A double arrow symbol on the right side of the LCD indicates that the scroll keys can be used to view additional information.
11. **Rate:** Instantly changes the rate of speed of the motors when the direction buttons are pressed.
12. **RS-232 Jack:** Allows use with a computer and software programs for point and click slewing capability.

Hand Control Operation

This section describes the basic hand control procedures needed to operate the NexStar. These procedures are grouped into three categories: Alignment, Setup and Utilities. The alignment section deals with the initial telescope alignment as well as finding objects in the sky; the setup section discusses changing parameters such as tracking mode and tracking rate; finally, the last section reviews all of the utility functions such as adjusting the telescopes slew limits and backlash compensation.

Alignment Procedure

In order for the NexStar to accurately point to objects in the sky, it must first be aligned with two known positions (stars) in the sky. With this information, the telescope can create a model of the sky, which it uses to locate any object with known coordinates.

Auto-Align

Auto-Align is the easiest way to get your NexStar aligned and ready to observe. Even if you do not know a single star in the sky, the NexStar will align itself by guiding the user through the alignment procedure by asking for basic information like the date, time and location. The NexStar will then automatically choose two stars for alignment and roughly center the stars in the field of view of the Star Pointer. Before the telescope is ready to be aligned, it should be set up in an outside location with all accessories (eyepiece, diagonal and Star Pointer) attached and lens cover removed as described in the Assembly section of the manual.

Important

1. Once the NexStar is powered on the display will read NexStar Ready. Press ENTER to begin alignment.

The first time that the NexStar is used, it will request information to help identify the model of telescope. Once powered on, the hand control will display the message **Select Model**. Use the Up and Down menu keys (10) to scroll through the different NexStar models. Press ENTER when *NexStar 80* is displayed on the hand control. This information will be retained for future use and will not be displayed again. If for some reason the incorrect model was selected or you wish to use your hand control on a different NexStar model, the *Select Model* utility feature allows you to re-select the proper NexStar model from the displayed list (see *Select Model* later in this section).

2. Use the Up and Down scroll keys to select *AutoAlign* if it is not already displayed, and press ENTER.
3. The telescope will then ask you to use the direction keys (3) to level the telescope tube and point the front of the telescope towards north. North can be found by using the compass affixed to the accessory tray (see figure 3-3). Use the hand control to point the telescope in the same direction as indicated by the red pointer on the compass. Alignment only needs to be approximate, however a close alignment will make the auto alignment more accurate. Once the telescope is in the north and level position, press ENTER.
4. The hand control display will then ask for the following information:

Location - The NexStar will display a list of cities to choose from. Choose the city from the database that is closest to your current observing site. The city you choose will be remembered in the hand controls memory so that it will be automatically displayed the next time an alignment is done. Alternatively, if you know the exact longitude and latitude of your observing site, it can be entered directly into the hand control and remembered for future use as well. To choose a location city:

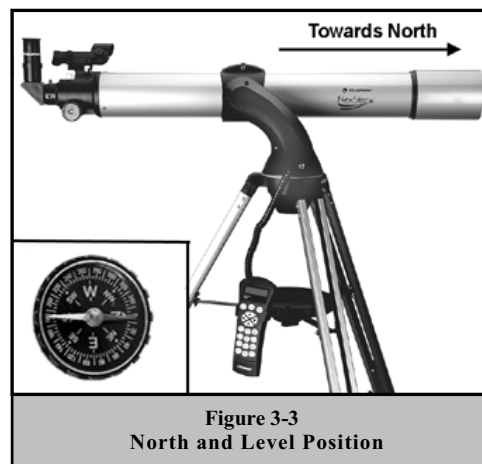

Figure 3-3
North and Level Position

- ❑ Use the Up and Down scroll keys to choose between *City Database* and *Custom Site*. *City Database* will allow you to select the closest city to your observing site from a list of either international or U.S. location. *Custom Site* allows you to enter the exact longitude and latitude of your observing site. Select *City Database* and press ENTER.
- ❑ The hand control will allow you to choose from either U.S. or international locations. For a listing of U.S. locations by state and then by city, press ENTER while *United States* is displayed. For international locations, use the Up or Down scroll key to select *International* and press ENTER.
- ❑ To display a list of local cities, first select your state from the alphabetical listing (or a list of countries if *International* locations was selected) and press ENTER.
- ❑ Choose the closest city to your location from the displayed list and press ENTER.

Time - Enter the current time for your area. You can enter either the local time (i.e. 8:00), or you can enter military time (i.e. 20:00).

- ❑ Select PM or AM. If military time was entered, the hand control will bypass this step.
- ❑ Choose between Standard time or Daylight Savings time. Use the Up and Down scroll buttons (10) to toggle between options.
- ❑ Select the time zone that you are observing from. Again, use the Up and Down buttons (10) to scroll through the choices. For time zone information, refer to the Time Zone map in the appendix of this manual.

Helpful Hints

Date - Enter the month, day and year of your observing session. The display will read: mm/dd/yy.

If the wrong information has been input into the hand control, the UNDO button will act as a backspace allowing the user to re-enter information.

The next time that your NexStar is auto aligned, the hand control will automatically display the last location (either a city or longitude/latitude) that was entered. Press ENTER to accept these parameters if they still apply. Pressing the UNDO button will allow you to go back and select a new city location or longitude/latitude.

- ❑ Based on this information, the NexStar will automatically select a bright star that is above the horizon and slew towards it. At this point the telescope is only roughly aligned, so the alignment star should only be close to the field of view of the Star Pointer finder. Once finished slewing, the display will ask you to use the arrow buttons to align the selected star with the red dot in the center of the Star Pointer. If for some reason the chosen star is not visible (perhaps behind a tree or building) you can press UNDO to select and slew to a different star. Once centered in the finder, press ENTER. The display will then instruct you to center the star in the field of view of the eyepiece. When the star is centered, press ALIGN to accept this star as your first alignment star. (There is no need to adjust the slewing rate of the motors after each alignment step. The NexStar automatically selects the best slewing rate for aligning objects in both the Star Pointer and the eyepiece). After the first alignment star has been entered the NexStar will automatically slew to a second alignment star and have you repeat the same procedure for that star. When the telescope has been aligned to both stars the display will read **Alignment Successful**, and you are now ready to find your first object.

Observing Tips

If the wrong star was centered and aligned to, the NexStar display will read **Align Failed**. Press UNDO to begin the alignment procedure again.

✦ If you are not sure if the correct star was centered, always remember that the alignment star will be the brightest star nearest the field of view of the finder. There may be other fainter stars visible that are closer to the center of the Star Pointer, but the actual alignment star will be obviously brighter than any other star in the area.

✦ When centering the alignment stars in the eyepiece, use the up arrow button and the right arrow button on the hand control. Centering the star from this direction will eliminate much of the backlash between the gears and assure the most accurate alignment possible.

Two Star Alignment

With the two-star alignment method, the NexStar requires the user to know the positions of only two bright stars in order to accurately align the telescope with the sky and begin finding objects. Here is an overview of the two-star alignment procedure:

1. Once the NexStar is powered on, use the Up and Down scroll keys to select **Two-Star Align**, and press ENTER.
2. The NexStar display will ask you to move the telescope tube until it is horizontal to the ground. To do this, use the direction keys (3) to move the telescope until it is roughly level with the ground. Press ENTER.
3. The **SELECT STAR 1** message will appear in the top row of the display. Use the Up and Down scroll keys (10) to select the star you wish to use for the first alignment star. Press ENTER.
4. NexStar then asks you to center in the eyepiece the alignment star you selected. Use the direction buttons to slew the telescope to the alignment star and carefully center the star in the eyepiece.
5. Once the alignment star is centered in the field of view of the eyepiece, press the ALIGN key (2) to accept this position.
6. NexStar will then ask you to select and center a second alignment star and press the ALIGN key. It is best to choose alignment stars that are a good distance away from one another. Stars that are at least 40° to 60° apart from each other will give you a more accurate alignment than stars that are close to each other.

Once the second star alignment is completed properly, the display will read **Alignment Successful**, and you will hear the tracking motors turn-on and begin to track.

Quick-Align

Quick-Align allows you to input all the same information as you would for the AutoAlign procedure. However, instead of slewing to two alignment stars for centering and alignment, the NexStar bypasses this step and simply models the sky based on the information given. This will allow you to roughly slew to the coordinates of bright objects like the moon and planets and gives the NexStar the information needed to track objects in altazimuth in any part of the sky. Quick-Align is not meant to be used to accurately locate small or faint deep-sky objects or to track objects accurately for photography. *Note: Once a Quick-Align has been done, you can use the Re-alignment feature (see below) to improve your telescopes pointing and tracking accuracy.*

To use Quick-Align:

1. Select *Quick-Align* from the alignment options.
2. Use the arrow buttons to level the tube and position the telescope tube towards north and press ENTER.
3. The hand control will then ask you to input all the same time and location information as you would for the AutoAlign procedure.

Once entered, the NexStar will model the sky based on this information and display **Alignment Successful**.

NexStar Re-Alignment

The NexStar has a re-alignment feature which allows you to replace either of the two original alignment stars with a new star or celestial object. This can be useful in several situations:

- If you are observing over a period of a few hours, you may notice that your original two alignment stars have drifted towards the west considerably. (Remember that the stars are moving at a rate of 15° every hour). Aligning on a new star that is in the eastern part of the sky will improve your pointing accuracy, especially on objects in that part of the sky.
- If you have aligned your telescope using the Quick-Align method, you can use *re-align* to align to two actual objects in the sky. This will improve the pointing accuracy of your telescope without having to re-enter additional information.

To replace an existing alignment star with a new alignment star:

1. Select the desired star (or object) from the database and slew to it.
2. Carefully center the object in the eyepiece.
3. Once centered, press the UNDO button until you are at the main menu.
4. With NexStar Ready displayed, press the ALIGN key on the hand control.
5. The display will then ask you which alignment star you want to replace.
6. Use the UP and Down scroll keys to select the alignment star to be replaced, and press ENTER. It is usually best to replace the star closest to the new object. This will space out your alignment stars across the sky.
7. Press ALIGN to make the change.

Object Catalog

Selecting an Object

Now that the telescope is properly aligned, you can choose an object from any of the catalogs in the NexStar's database. The hand control has a key designated for each of the catalogs in its database. There are two ways to select objects from the database; scrolling through the named object lists and entering object numbers:

- Pressing the LIST key on the hand control will access all objects in the database that have common names or types. Each list is broken down into the following categories: Named Stars, Named Object, Double Stars, Variable Stars and Asterisms. Selecting any one of these options will display an alpha-numeric listing of the objects under that list. Pressing the Up and Down keys (10) allows you to scroll through the catalog to the desired object.
- Pressing any of the catalog keys (M, CALD, NGC, or STAR) will display a blinking cursor below the name of the catalog chosen. Use the numeric key pad to enter the number of any object within these standardized catalogs. For example, to find the Orion Nebula, press the "M" key and enter "042".
- Pressing the PLANET button will allow you to use the UP and DOWN arrow keys to scroll through and select the eight planets as well as the moon.

To download a list of all the stars contained in the STAR Catalog with SAO number cross references, logon to our web site at www.celestron.com.

Slewing to an Object

Once the desired object is displayed on the hand control screen, you have two options:

- **Press the INFO Key.** This will give you useful information about the selected object such as magnitude, constellation and fascinating facts about many of the objects.

The speed at which information scrolls across the hand control display can be changed while the information is being viewed:

Press the "1" key repeatedly to speed up the scroll speed.

Press the "4" key repeatedly to slow down the scroll speed.

Press the "7" key to freeze and unfreeze the information on the display.

- **Press the ENTER Key.** This will automatically slew the telescope to the coordinates of the object. While the telescope is slewing to the object, the user can still access many of the hand control functions (such as displaying information about the object).

If you slew to an object that is below the horizon, NexStar will notify you by displaying a message reminding you that you have selected an object outside of your slew limits (see Slew Limits in the Utility Features section of the manual). Press UNDO to go back and select a new object. Press ENTER to ignore the message and continue the slew. The NexStar hand control will only display objects that are below the horizon if the Filter Limits are set below 0° in altitude. See Filter Limits in the Utility Feature section of the manual for more information on setting the filter limits.

Caution: Never slew the telescope when someone is looking into the eyepiece. The telescope can move at fast slew speeds and may hit an observer in the eye.

Object information can be obtained without having to do a star alignment. After the telescope is powered on, pressing any of the catalog keys allows you to scroll through object lists or enter catalog numbers and view the information about the object as described above.

Tour Mode

The NexStar includes a tour feature which automatically allows the user to choose from a list of interesting objects based on the date and time in which you are observing. The automatic tour will display only those objects that are within your set filter limits. To activate the Tour mode, press the TOUR key (6) on the hand control. The NexStar will display the best objects to observe that are currently in the sky.

- To see information and data about the displayed object, press the INFO key.

- To slew to the object displayed, press ENTER.
- To see the next tour object, press the Down key.

Direction Buttons

The NexStar has four direction buttons in the center of the hand control which controls the telescope motion in altitude (up and down) and azimuth (left and right). The telescope can be controlled at nine different speed rates.

1 = 2x	6 = .5° / sec
2 = 4x	7 = 1° / sec
3 = 8x	8 = 2° / sec
4 = 16x	9 = 4° / sec
5 = 32x	
Nine available slew speeds	

Rate Button

Pressing the RATE key (11) allows you to instantly change the speed rate of the motors from high speed slew rate to precise guiding rate or anywhere in between. Each rate corresponds to a number on the hand controller key pad. The number 9 is the fastest rate (approximately 4° per second, depending on power source) and is used for slewing between objects and locating alignment stars. The number 1 on the hand control is the slowest rate (2x sidereal) and can be used for accurate centering of objects in the eyepiece. To change the speed rate of the motors:

- Press the RATE key on the hand control. The LCD will display the current speed rate.
- Press the number on the hand control that corresponds to the desired speed.

The hand control has a "double button" feature that allows you to instantly speed up the motors without having to choose a speed rate. To use this feature, simply press the arrow button that corresponds to the direction that you want to move the telescope. While holding that button down, press the opposite directional button. This will increase the speed to the maximum slew rate.

When using the Up and Down buttons on the NexStar 80, the slower slew rates (6 and lower) move the motors in the opposite direction than the faster slew rates (7- 9). This is done so that an object will move in the appropriate direction when looking into the eyepiece (i.e. pressing the up arrow button will move the star upwards in the field of view of the eyepiece). However, if any of the slower slew rates (rate 6 and below) are used to center an object in the Star Pointer, you may need to press the opposite directional button to make the telescope move in the correct direction.

Set Up Procedures

The NexStar contains many user defined setup functions designed to give the user control over the telescope's many advanced features. All of the set up and utility features can be accessed by pressing the MENU key and scrolling through the options:

Tracking Mode - Once the NexStar is aligned the tracking motors will automatically turn on and begin tracking the sky. However, the tracking can be turned off for terrestrial use:

Alt-Az	This is the default tracking rate and is used when the telescope has been properly aligned.
EQ North	Used to track the sky when the telescope is polar aligned using an equatorial wedge in the Northern Hemisphere.
EQ South	Used to track the sky when the telescope is polar aligned using an equatorial wedge in the Southern Hemisphere.
Off	When using the telescope for terrestrial (land) observation the tracking can be turned off so that the telescope never moves.

Note: The EQ North and EQ South tracking modes are only needed with telescopes that can be polar aligned, such as the NexStar 4, 5 and 8. The NexStar GT's are exclusively Alt-Az mounted telescopes and do not require equatorial tracking.

Tracking Rate - In addition to being able to move the telescope with the hand control buttons, the NexStar will continually track a celestial object as it moves across the night sky. The tracking rate can be changed depending on what type of object is being observed:

Sidereal	This rate compensates for the rotation of the earth by moving the telescope at the same rate as the rotation of the earth, but in the opposite direction. When tracking in Alt-Az mode, the telescope must make corrections in both altitude and azimuth.
Lunar	Used for tracking the moon when observing the lunar landscape.
Solar	Used for tracking the Sun when solar observing using a proper solar filter.

View Time-Site - *View Time-Site* will display the last saved time and longitude/latitude entered in the hand control.

Sidereal Time – Displays the Sidereal time for your current time and location. This is useful for knowing the right ascension of celestial objects that are located on the local meridian at that time.

Filter Limits – When an alignment is complete, the NexStar automatically knows which celestial objects are above the horizon. As a result, when scrolling through the database lists (or selecting the Tour function), the NexStar hand control will display only those objects that are known to be above the horizon when you are observing. You can customize the object database by selecting altitude limits that are appropriate for your location and situation. For example, if you are observing from a mountainous location where the horizon is partially obscured, you can set your minimum altitude limit to read +20°. This will make sure that the hand control only displays objects that are higher in altitude than 20°.

Observing Tip!

If you want to explore the entire object database, set the maximum altitude limit to 90° and the minimum limit to -90°. This will display every object in the database lists regardless of whether it is visible in the sky from your location or not.

RS-232 - The NexStar has a RS-232 port located on the bottom of the hand control that allows it to communicate with many popular astronomy computer programs. Before attempting to create a link with a computer, select the RS-232 option and press Enter.

User Defined Objects - The NexStar can store up to 50 different user defined objects in its memory. The objects can be daytime land objects or an interesting celestial object that you discover that is not included in the regular database. There are several ways to save an object to memory depending on what type of object it is:

Save Sky Object: The NexStar stores celestial objects to its database by saving its right ascension and declination in the sky. This way the same object can be found each time the telescope is aligned. Once a desired object is centered in the eyepiece, simply scroll to the "Save Sky Obj" command and press ENTER. The display will ask you to enter a number between 1-25 to identify the object. Press ENTER again to save this object to the database.

Save Land Object: The NexStar can also be used as a spotting scope on terrestrial objects. Fixed land objects can be stored by saving their altitude and azimuth relative to the location of the telescope at the time of observing. Since these

objects are relative to the location of the telescope, they are only valid for that exact location. To save land objects, once again center the desired object in the eyepiece. Scroll down to the "Save Land Obj" command and press ENTER. The display will ask you to enter a number between 1-25 to identify the object. Press ENTER again to save this object to the database.

Enter R.A. - Dec: You can also store a specific set of coordinates for an object just by entering the R.A. and declination for that object. Scroll to the "Enter RA-DEC " command and press ENTER. The display will then ask you to enter first the R.A. and then the declination of the desired object.

GoTo Object: To go to any of the user defined objects stored in the database, scroll down to either GoTo Sky Obj or GoTo Land Obj and enter the number of the object you wish to select and press ENTER. NexStar will automatically retrieve and display the coordinates before slewing to the object.

To replace the contents of any of the user defined objects, simply save a new object using one of the existing identification numbers; NexStar will replace the previous user defined object with the current one.

Get RA/DEC - Displays the right ascension and declination for the current position of the telescope.

Get Alt-Az - Displays the relative altitude and azimuth for the current position of the telescope.

Goto R.A/ Dec - Allows you to input a specific R.A. and declination and slew to it.

Goto Alt-Az - Allows you to enter a specific altitude and azimuth position and slew to it.



To store a set of coordinates (R.A./Dec) permanently into the NexStar database, save it as a *User Defined Object* as described above.

Utility Features

Scrolling through the MENU options will also provide access to several advanced utility functions such as anti-backlash compensation and slew limits.

Setup Time-Site - Allows the user to customize the NexStar display by changing time and location parameters (such as time zone and daylight savings).

Anti-backlash - All mechanical gears have a certain amount of backlash or play between the gears. This play is evident by how long it takes for a star to move in the eyepiece when the hand control arrow buttons are pressed (especially when changing directions). The NexStar's anti-backlash features allows the user to compensate for backlash by inputting a value which quickly rewinds the motors just enough to eliminate the play between gears. The amount of compensation needed depends on the slewing rate selected; the slower the slewing rate the longer it will take for the star to appear to move in the eyepiece. Therefore, the anti-backlash compensation will have to be set higher. You will need to experiment with different values; a value between 20 and 50 is usually best for most visual observing, whereas a higher value may be necessary for photographic guiding.

To set the anti-backlash value, scroll down to the anti-backlash option and press ENTER. Enter a value from 0-100 for both azimuth and altitude directions and press ENTER after each one to save these values. NexStar will remember these values and use them each time it is turned on until they are changed.

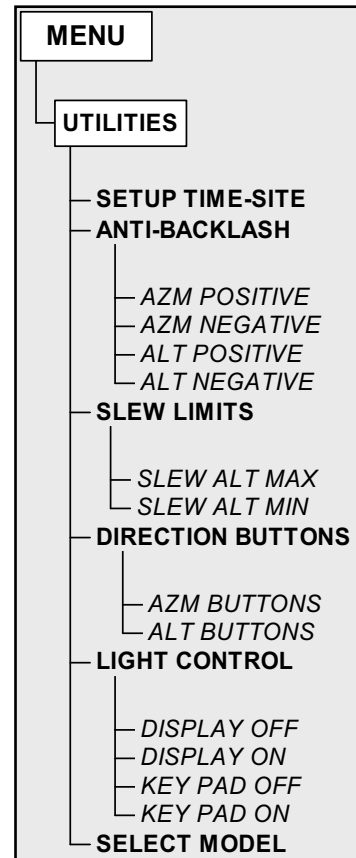

Slew Limits – Sets the limits in altitude that the telescope can slew without displaying a warning message first. The NexStar hand control will warn you before allowing the telescope tube to slew to an object below the horizon or slew to an object that is high enough that the tube might hit one of the tripod legs. However, the slew limits can be customized depending on your needs. For example, if you would like to slew to an object that is close to the zenith and are certain that the tube will not hit the tripod legs, you can set the slew limits to 90° in altitude. This will allow the telescope to slew to any object above the horizon without warning.

Direction Buttons –The direction a star moves in the eyepiece varies depending on the accessories being used. This can create confusion when guiding on a star using an off-axis guider versus a straight through guide scope. To compensate for this, the direction of the drive control keys can be changed. To reverse the button logic of the hand control, press the MENU button and select *Direction Buttons* from the Utilities menu. Use the Up/Down arrow keys (10) to select either the Azimuth buttons (left and right) or Altitude buttons (up and down) and press ENTER. Pressing ENTER again will reverse the direction of the hand control buttons from their current state. Direction Buttons will only change the eyepiece rates (rate 1-6) and will not affect the slew rates (rate 7-9).

Light Control – This feature allows you to turn off both the red key pad light and LCD display for daytime use to conserve power and to help preserve your night vision.

Select Model – The first time the NexStar is powered on, the hand control display allows you to select your NexStar from a list of different models. If for some reason the incorrect model was selected or you wish to use your hand control on a different NexStar model, the *Select Model* utility feature allows you to re-select the proper NexStar model from the displayed list. Once the correct NexStar model has been selected the power needs to be restarted before beginning the alignment procedure. The *Select Model* feature will return the hand control to its original factory settings. Parameters such as backlash compensation values along with slew and filter limits will be reset. However, stored parameters such as user defined objects will remain saved even after the model has been changed.

NexStar Ready

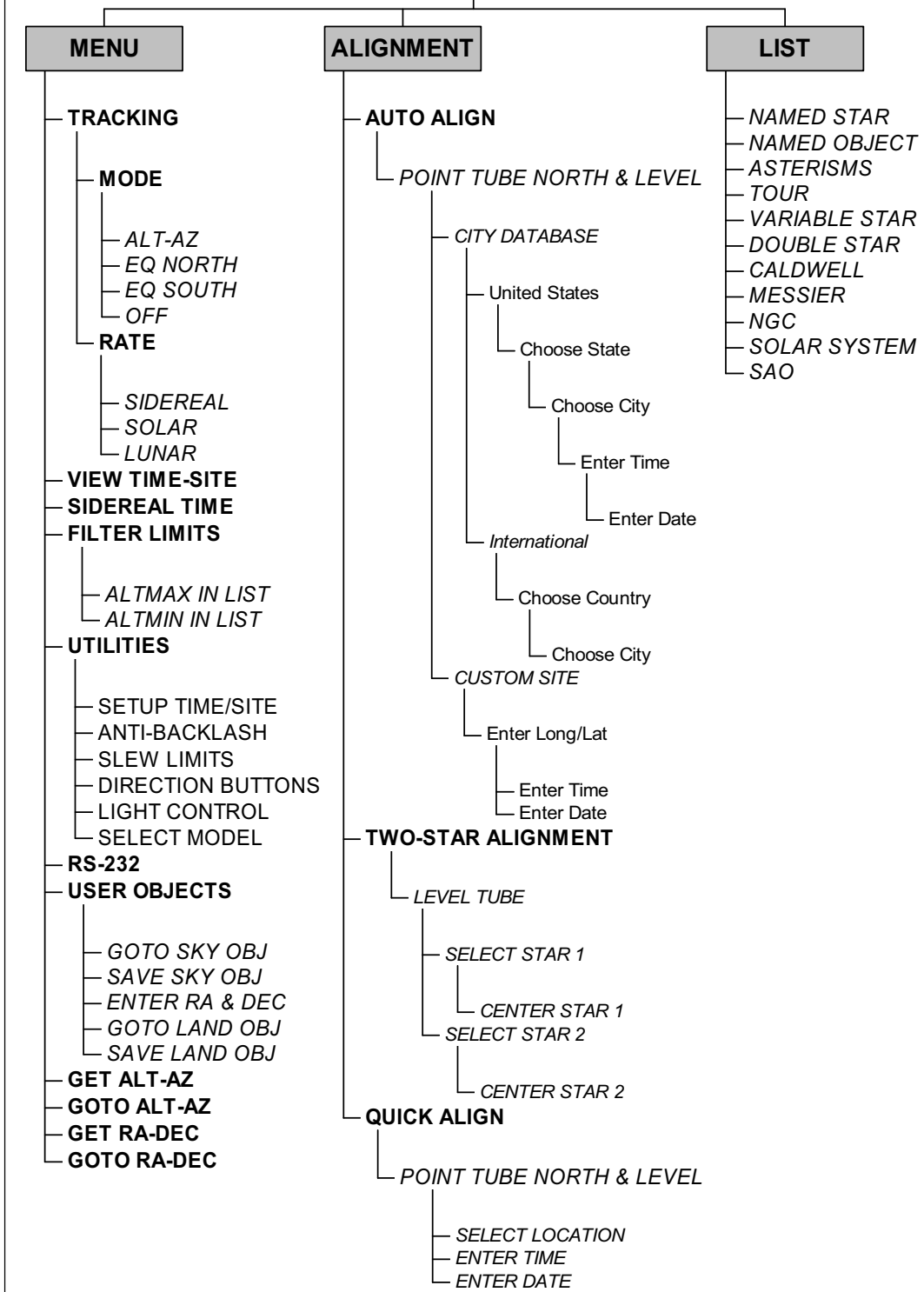

CELESTRON Telescope Basics

A telescope is an instrument that collects and focuses light. The nature of the optical design determines how the light is focused. Some telescopes, known as refractors, use lenses. Other telescopes, known as reflectors, use mirrors. Your NexStar 80 telescope is a refractor telescope that use an objective lens to collect its light.

Focusing

Once you have found an object in the telescope, turn the focusing knob until the image is sharp. To focus on an object that is nearer than your current target, turn the focusing knob toward the eyepiece (i.e., so that the focusing tube moves away from the front of the telescope). For more distant objects, turn the focusing knob in the opposite direction. To achieve a truly sharp focus, never look through glass windows or across objects that produce heat waves, such as asphalt parking lots.

For astronomical viewing, out of focus star images are very diffuse, making them difficult to see. If you turn the focus knob too quickly, you can go right through focus without seeing the image. To avoid this problem, your first astronomical target should be a bright object (like the Moon or a planet) so that the image is visible even when out of focus.

Image Orientation

The image orientation of any telescope changes depending on how the eyepiece is inserted into the telescope. When observing through the NexStar 80 using the erect image diagonal, the image will be right side up, and correct from left to right. However, when observing straight through, with the eyepiece inserted directly into the telescope, the image will be inverted.

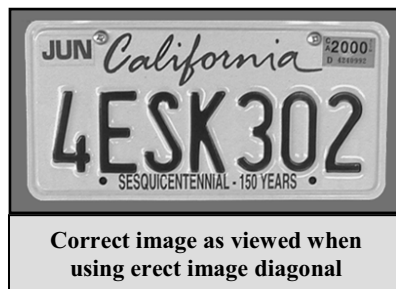

Calculating Magnification

You can change the power of your telescope just by changing the eyepiece (ocular). To determine the magnification of your telescope, simply divide the focal length of the telescope by the focal length of the eyepiece used. In equation format, the formula looks like this:

$$\text{Magnification} = \frac{\text{Focal Length of Telescope (mm)}}{\text{Focal Length of Eyepiece (mm)}}$$

Let's say, for example, you are using the 25mm eyepiece. To determine the magnification you simply divide the focal length of your telescope (for example, the NexStar 80 has a focal length of 900mm) by the focal length of the eyepiece, 25mm. Dividing 900 by 25 yields a magnification of 36 power.

Although the power is variable, each instrument under average skies has a limit to the highest useful magnification. The general rule is that 60 power can be used for every inch of aperture. For example, the NexStar 80 is 3.1" (80mm) in diameter. Multiplying 3.1 by 60 gives a maximum useful magnification of 186 power. Although this is the maximum useful magnification, most observing is done in the range of 20 to 35 power for every inch of aperture which is 62 to 109 times for the NexStar 80 telescope.

Determining Field of View

Determining the field of view is important if you want to get an idea of the angular size of the object you are observing. To calculate the actual field of view, divide the apparent field of the eyepiece (supplied by the eyepiece manufacturer) by the magnification. In equation format, the formula looks like this:

$$\text{True Field} = \frac{\text{Apparent Field of Eyepiece}}{\text{Magnification}}$$

As you can see, before determining the field of view, you must calculate the magnification. Using the example in the previous section, we can determine the field of view using the same 25mm eyepiece. The 25mm eyepiece has an apparent field of view of 56°. Divide the 56° by the magnification, which is 40 power. This yields an actual field of view of 1.4°.

To convert degrees to feet at 1,000 yards, which is more useful for terrestrial observing, simply multiply by 52.5. Continuing with our example, multiply the angular field 1.4° by 52.5. This produces a linear field width of 73.5 feet at a distance of one thousand yards. The apparent field of each eyepiece that Celestron manufactures is found in the Celestron Accessory Catalog (#93685).

General Observing Hints

When working with any optical instrument, there are a few things to remember to ensure you get the best possible image:

- Never look through window glass. Glass found in household windows is optically imperfect, and as a result, may vary in thickness from one part of a window to the next. This inconsistency can and will affect the ability to focus your telescope. In most cases you will not be able to achieve a truly sharp image, while in some cases, you may actually see a double image.
- Never look across or over objects that are producing heat waves. This includes asphalt parking lots on hot summer days or building rooftops.
- Hazy skies, fog, and mist can also make it difficult to focus when viewing terrestrially. The amount of detail seen under these conditions is greatly reduced. Also, when photographing under these conditions, the processed film may come out a little grainier than normal with lower contrast and underexposed.
- If you wear corrective lenses (specifically glasses), you may want to remove them when observing with an eyepiece attached to the telescope. When using a camera, however, you should always wear corrective lenses to ensure the sharpest possible focus. If you have astigmatism, corrective lenses must be worn at all times.

Celestial Observing

With your telescope set up, you are ready to use it for observing. This section covers visual observing hints for both solar system and deep sky objects as well as general observing conditions which will affect your ability to observe.

Observing the Moon

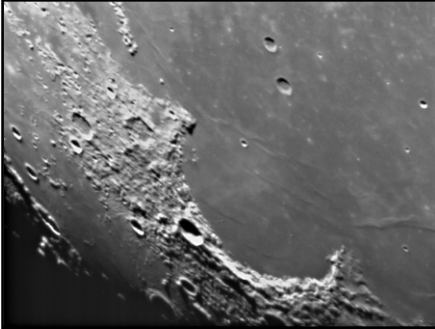

Often, it is tempting to look at the Moon when it is full. At this time, the face we see is fully illuminated and its light can be overpowering. In addition, little or no contrast can be seen during this phase.

One of the best times to observe the Moon is during its partial phases (around the time of first or third quarter). Long shadows reveal a great amount of detail on the lunar surface. At low power you will be able to see most of the lunar disk at one time. Change to higher power (magnification) to focus in on a smaller area. Choose the lunar tracking rate from the NexStar's MENU tracking rate options to keep the moon centered in the eyepiece even at high magnifications.

Lunar Observing Hints

To increase contrast and bring out detail on the lunar surface, use eyepiece filters. A yellow filter works well at improving contrast while a neutral density or polarizing filter will reduce overall surface brightness and glare.

Observing the Planets

Other fascinating targets include the five naked eye planets. You can see Venus go through its lunar-like phases. Mars can reveal a host of surface detail and one, if not both, of its polar caps. You will be able to see the cloud belts of Jupiter and the great Red Spot (if it is visible at the time you are observing). In addition, you will also be able to see the moons of Jupiter as they orbit the giant planet. Saturn, with its beautiful rings, is easily visible at moderate power.

Planetary Observing Hints

Remember that atmospheric conditions are usually the limiting factor on how much planetary detail will be visible. So, avoid observing the planets when they are low on the horizon or when they are directly over a source of radiating heat, such as a rooftop or chimney. See the "*Seeing Conditions*" section later in this section.

To increase contrast and bring out detail on the planetary surface, try using Celestron eyepiece filters.

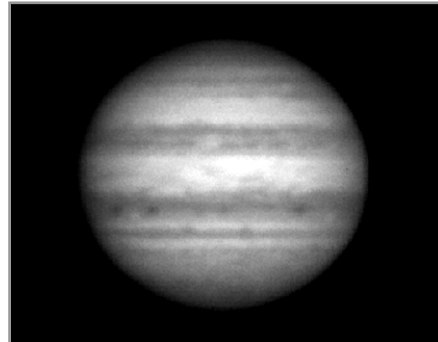

Observing the Sun

Although overlooked by many amateur astronomers, solar observation is both rewarding and fun. However, because the Sun is so bright, special precautions must be taken when observing our star so as not to damage your eyes or your telescope.

For safe solar viewing, use your Celestron solar filter to reduce the intensity of the Sun's light, making it safe to view. For proper installation of your solar filter refer to the *Assembly* section earlier in this manual.

Once you have located and focused the Sun, look for some of the following prominent features:

•**Sunspots:** Dark regions of the sun's photosphere which are cooler than the surrounding area. Sunspots are usually seen to consist of two parts: the inner darker core, the umbra, and the surrounding less dark region, the *penumbra*.

•**Granulation:** Small convection cells in the photosphere that appear as "rice grain" markings.

•**Faculae:** Large patches of bright material probably due to elevated clouds of luminous gas seen in the vicinity of sunspots.

•**Limb Darkening:** An observed darkening near the limb of the sun's surface compared to its brighter center due to the amount of atmospheric layers penetrated when viewing the sun's limb.

Solar Observing Hints

The best time to observe the Sun is in the early morning or late afternoon when the air is cooler.

To center the Sun without looking into the eyepiece, watch the shadow of the telescope tube until it forms a circular shadow.

To ensure accurate tracking on GT models, be sure to select solar tracking rate.

Observing Deep Sky Objects

Deep sky objects are simply those objects outside the boundaries of our solar system. They include star clusters, planetary nebulae, diffuse nebulae, double stars and other galaxies outside our own Milky Way. Most deep sky objects have a large angular size. Therefore, low-to-moderate power is all you need to see them. Visually, they are too faint to reveal any of the color seen in long exposure photographs. Instead, they appear black and white. And, because of their low surface brightness, they should be observed from a dark sky location. Light pollution around large urban areas washes out most nebulae making them difficult, if not impossible, to observe. Light Pollution Reduction filters help reduce the background sky brightness, thus increasing contrast.

Terrestrial (Land) Viewing

Your NexStar 80GTL also makes an excellent daytime spotting scope. For daytime viewing, the 90° erect image diagonal must be inserted into the telescope's focuser. For correct viewing of land objects make sure the eyepiece is pointing straight up out of the diagonal. Rotating the eyepiece and diagonal to either side will cause the image to also rotate in the field of view of the eyepiece.

Terrestrial (Land) Viewing Hints

To save land objects into your hand control's database as *User Defined Objects*, first complete the *Quick Alignment* procedure, this will bypass the normal two star alignment needed for nighttime viewing.

Since daytime land objects usually remain stationary, remember to turn off the telescopes tracking.

Seeing Conditions

Viewing conditions affect what you can see through your telescope during an observing session. Conditions include transparency, sky illumination, and seeing. Understanding viewing conditions and the effect they have on observing will help you get the most out of your telescope.

Transparency

Transparency is the clarity of the atmosphere which is affected by clouds, moisture, and other airborne particles. Thick cumulus clouds are completely opaque while cirrus can be thin, allowing the light from the brightest stars through. Hazy skies absorb more light than clear skies making fainter objects harder to see and reducing contrast on brighter

objects. Aerosols ejected into the upper atmosphere from volcanic eruptions also affect transparency. Ideal conditions are when the night sky is inky black.

Sky Illumination

General sky brightening caused by the Moon, aurorae, natural airglow, and light pollution greatly affect transparency. While not a problem for the brighter stars and planets, bright skies reduce the contrast of extended nebulae making them difficult, if not impossible, to see. To maximize your observing, limit deep sky viewing to moonless nights far from the light polluted skies found around major urban areas. LPR filters enhance deep sky viewing from light polluted areas by blocking unwanted light while transmitting light from certain deep sky objects. You can, on the other hand, observe planets and stars from light polluted areas or when the Moon is out.

Seeing

Seeing conditions refers to the stability of the atmosphere and directly affects the amount of fine detail seen in extended objects. The air in our atmosphere acts as a lens which bends and distorts incoming light rays. The amount of bending depends on air density. Varying temperature layers have different densities and, therefore, bend light differently. Light rays from the same object arrive slightly displaced creating an imperfect or smeared image. These atmospheric disturbances vary from time-to-time and place-to-place. The size of the air parcels compared to your aperture determines the "seeing" quality. Under good seeing conditions, fine detail is visible on the brighter planets like Jupiter and Mars, and stars are pinpoint images. Under poor seeing conditions, images are blurred and stars appear as blobs.

The conditions described here apply to both visual and photographic observations.

The logo for Celestron Telescope Maintenance is enclosed in a black rectangular border. It features the Celestron logo (a stylized 'C' with a globe) to the left of the word 'CELESTRON' in a bold, sans-serif font. Below this, the words 'Telescope Maintenance' are written in a larger, bold, italicized sans-serif font.

CELESTRON Telescope Maintenance

While your NexStar telescope requires little maintenance, there are a few things to remember that will ensure your telescope performs at its best.

Care and Cleaning of the Optics

Occasionally, dust and/or moisture may build up on the lens of your telescope. Special care should be taken when cleaning any instrument so as not to damage the optics.

If dust has built up on the objective lens, you can remove it with a brush (made of camel's hair) or a can of pressurized air. Spray at an angle to the lens for approximately two to four seconds. Then, use an optical cleaning solution and white tissue paper to remove any remaining debris. Apply the solution to the tissue and then apply the tissue paper to the lens. Low pressure strokes should go from the center of the corrector to the outer portion. **Do NOT rub in circles!**

You can use a commercially made lens cleaner or mix your own. A good cleaning solution is isopropyl alcohol mixed with distilled water. The solution should be 60% isopropyl alcohol and 40% distilled water. Or, liquid dish soap diluted with water (a couple of drops per one quart of water) can be used.

To minimize the need to clean your telescope, replace all lens covers once you have finished using it. This will prevent contaminants from entering the optical tube.

CELESTRON Optional Accessories

You will find that additional accessories enhance your viewing pleasure and expand the usefulness of your telescope. For ease of reference, all the accessories are listed in alphabetical order.

Adapter, AC (#18773) – Allows DC (battery) powered telescopes to be converted for use with 120 volt AC power. The adapter attaches to any standard wall outlet.

Adapter, Car Battery (#18769) - Celestron offers the Car Battery Adapter that allows you to run the NexStar drive off an external power source. The adapter attaches to the cigarette lighter of your car, truck, van, or motorcycle.

Barlow lens, OMNI 1.25" (#93326) - Double the magnification of any of your Celestron eyepieces with this fully multi-coated, low profile Barlow lens

Eyepieces - Like telescopes, eyepieces come in a variety of designs. Each design has its own advantages. For the 1-1/4" barrel diameter there are three different eyepiece designs available:

- **OMNI Plössl** - Plössl eyepieces have a 4-element lens designed for low-to-high power observing. The Plössls offer razor sharp views across the entire field, even at the edges! In the 1-1/4" barrel diameter, they are available in the following focal lengths: 4mm, 6mm, 9mm, 12.5mm, 15mm, 20mm, 25mm, 32mm and 40mm.
- **X-Cel** - This 6 element design allows each X-Cel Eyepiece to have 20mm of eye relief, 55° field of view and more than 25mm of lens aperture (even with the 2.3mm). In order to maintain razor sharp, color corrected images across its 50° field of view, extra-low dispersion glass is used for the most highly curved optical elements. The excellent refractive properties of these high grade optical elements, make the X-Cel line especially well suited for high magnification planetary viewing where sharp, color-free views are most appreciated. X-Cel eyepieces come in the following focal lengths: 2.3mm, 5mm, 8mm, 10mm, 12.5mm, 18mm, 21mm, 25mm.
- **Ultima** - Ultima is not really a design, but a trade name for our 5-element, wide field eyepieces. In the 1-1/4" barrel diameter, they are available in the following focal lengths: 5mm, 7.5mm, 10mm, 12.5mm, 18mm, 30mm, 35mm, and 42mm. These eyepieces are all parfocal.



Exotherm, Hand Warmer- (#93504) - Perfect for chilly evenings of star gazing, the Exotherm Hand Warmer is convenient, reusable and provides up to one hour of instant heat.

Filters, Eyepiece - To enhance your visual observations of solar system objects, Celestron offers a wide range of colored eyepiece filter sets that thread into the 1-1/4" oculars. Available sets are:

#94119-10 – Orange, Light Blue, ND13%T, Polarizing (#s 21, 80A, 15, Polarizing)

#94119-20 - Deep Yellow, Red, Light Green, ND25% T (#s 12, 25, 56, 96ND-25)

#94119-30 - Light Red, Blue, Green, ND50% T (#s 23A, 38A, 58, 96ND-50)

#94119-40 - Yellow, Deep Yellow, Violet, Pale Blue (#s 8, 96ND-13, 47, 82A)

Flashlight , Night Vision - (#93588) - Celestron's premium model for astronomy, using two red LEDs to preserve night vision better than red filters or other devices. Brightness is adjustable. Operates on a single 9 volt battery (included).

Flashlight, Red Astro Lite – (#93590) – An economical squeeze-type flashlight fitted with a red cap to help preserve your night vision. Remove the red cap for normal flashlight operation. Very compact size and handy key chain.

Contrast-Booster Filter 1.25" by Baader (#94121) - This is our newest high quality filter that eliminates most color aberration inherent in achromatic refractor telescopes. The filter also reduces your view of the blue hue around lunar and planetary subjects. Features multi-layer coatings for 95% transmission.

Filter, Light Pollution Reduction –LPR (#94126A) - These filters are designed to enhance your views of deep sky astronomical objects when viewed from urban areas. LPR Filters selectively reduce the transmission of certain wavelengths of light, specifically those produced by artificial lights. This includes mercury and high and low pressure sodium vapor lights. In addition, they also block unwanted natural light (sky glow) caused by neutral oxygen emission in our atmosphere.

Filter, Moon (#94119-A) - Celestron's Moon Filter is an economical eyepiece filter for reducing the brightness of the moon and improving contrast, so greater detail can be observed on the lunar surface. The clear aperture is 21mm and the transmission is about 18%.



Polarizing Filter Set (#93608) - The polarizing filter set limits the transmission of light to a specific plane, thus increasing contrast between various objects. This is used primarily for terrestrial, lunar and planetary observing.



PowerTank (#18774) – 12v 7Amp hour rechargeable power supply. Comes with two 12v output cigarette outlets, built-in red flash light , Halogen emergency spotlight. AC adapter and cigarette lighter adapter included.

RS-232 Cable (#93920) – Allows your NexStar telescope to be controlled using a laptop computer or PC. Once connected, the NexStar can be controlled using popular astronomy software programs.

Sky Maps (#93722) - Celestron Sky Maps are the ideal teaching guide for learning the night sky. You wouldn't set off on a road trip without a road map, and you don't need to try to navigate the night sky without a map either. Even if you already know your way around the major constellations, these maps can help you locate all kinds of

fascinating objects.

T-adapter (#93625) - A T-Adapter allows you to attach your 35mm SLR camera to the prime focus of your telescope. Universal 1/4" T-Adapter. Fits (drop in style) any type of telescope that uses a 1/4" focuser or visual back.

Vibration Suppression Pads (#93503) - These pads rest between the ground and tripod feet of your telescope. They reduce the amplitude and vibration time of your telescope when shaken by the wind or an accidental bump.

A full description of all Celestron accessories can be found in the Celestron Accessory Catalog (#93685) or visit our web site at www.celestron.com

APPENDIX A - TECHNICAL SPECIFICATIONS

Optical Specification

	NexStar 80GTL
Design	Refractor
Aperture	80mm
Focal Length	900mm
F/ratio of the Optical System	F/11
Objective Coatings	Fully Coated
Highest Useful Magnification	189x
Lowest Useful Magnification	11x
Resolution: Rayleigh Criterion	1.73 arc seconds
Dawes Limit	1.45 arc seconds
Light Gathering Power	131x unaided eye
Field of View: Standard Eyepiece	1.4°
Linear Field of View (at 1000 yds)	74 feet
Eyepiece Magnification:	36x (25mm) 90x (10mm)
Optical Tube Length	35 inches

Electronic Specifications

Input Voltage	12 V DC Nominal
Maximum	18 V DC Max.
Minimum	8 V DC Min.
Batteries Required	8 AA Alkaline
Power Supply Requirements	12 VDC-750 mA (Tip positive)

Mechanical Specifications

Motor: Type	DC Servo motors with encoders, both axes
Resolution	.26 arc sec
Slew speeds	Nine slew speeds: 4°/sec, 2°/sec, 1°/sec, .5°/sec, 32x, 16x, 8x, 4x, 2x
Hand Control	Double line, 16 character Liquid Crystal Display 19 fiber optic backlit LED buttons
Fork Arm	Cast aluminum

Software Specifications

Software Precision	16 bit, 20 arc sec. calculations
Ports	RS-232 communication port on hand control
Tracking Rates	Sidereal, Solar and Lunar
Tracking Modes	Alt-Az, EQ North & EQ South
Alignment Procedures	AutoAlign, 2-Star Alignment, Quick-Align
Database	25 user defined programmable object. Enhanced information on over 100 objects
Total Object Database	4,033 Objects

GLOSSARY OF TERMS

A-

Absolute magnitude	The apparent magnitude that a star would have if it were observed from a standard distance of 10 parsecs, or 32.6 light-years. The absolute magnitude of the Sun is 4.8. at a distance of 10 parsecs, it would just be visible on Earth on a clear moonless night away from surface light.
Airy disk	The apparent size of a star's disk produced even by a perfect optical system. Since the star can never be focused perfectly, 84 per cent of the light will concentrate into a single disk, and 16 per cent into a system of surrounding rings.
Alt-Azimuth Mounting	A telescope mounting using two independent rotation axes allowing movement of the instrument in Altitude and Azimuth.
Altitude	In astronomy, the altitude of a celestial object is its Angular Distance above or below the celestial horizon.
Aperture	The diameter of a telescope's primary lens or mirror; the larger the aperture, the greater the telescope's light-gathering power.
Apparent Magnitude	A measure of the relative brightness of a star or other celestial object as perceived by an observer on Earth.
Arc minute	A unit of angular size equal to 1/60 of a degree.
Arc second	A unit of angular size equal to 1/3,600 of a degree (or 1/60 of an arc minute).
Asterism	A small unofficial grouping of stars in the night sky.
Asteroid	A small, rocky body that orbits a star.
Astrology	The pseudoscientific belief that the positions of stars and planets exert an influence on human affairs; astrology has nothing in common with astronomy.
Astronomical unit (AU)	The distance between the Earth and the Sun. It is equal to 149,597,900 km., usually rounded off to 150,000,000 km.
Aurora	The emission of light when charged particles from the solar wind slams into and excites atoms and molecules in a planet's upper atmosphere.
Azimuth	The angular distance of an object eastwards along the horizon, measured from due north, between the astronomical meridian (the vertical line passing through the center of the sky and the north and south points on the horizon) and the vertical line containing the celestial body whose position is to be measured. .

B -

Binary Stars	Binary (Double) stars are pairs of stars that, because of their mutual gravitational attraction, orbit around a common center of mass. If a group of three or more stars revolve around one another, it is called a multiple system. It is believed that approximately 50 percent of all stars belong to binary or multiple systems. Systems with individual components that can be seen separately by a telescope are called visual binaries or visual multiples. The nearest "star" to our solar system, Alpha Centauri, is actually our nearest example of a multiple star system, it consists of three stars, two very similar to our Sun and one dim, small, red star orbiting around one another.
--------------	---

C -

Celestial Equator	The projection of the Earth's equator on to the celestial sphere. It divides the sky into two equal hemispheres.
Celestial pole	The imaginary projection of Earth's rotational axis north or south pole onto the celestial sphere.
Celestial Sphere	An imaginary sphere surrounding the Earth, concentric with the Earth's center.
Collimation	The act of putting a telescope's optics into perfect alignment.

D -

Declination (DEC)	The angular distance of a celestial body north or south of the celestial equator. It may be said to correspond to latitude on the surface of the Earth.
-------------------	---

E -

Ecliptic	The projection of the Earth's orbit on to the celestial sphere. It may also be defined as "the apparent yearly path of the Sun against the stars".
Equatorial mount	A telescope mounting in which the instrument is set upon an axis which is parallel to the axis of the Earth; the angle of the axis must be equal to the observer's latitude.

F -

Focal length	The distance between a lens (or mirror) and the point at which the image of an object at infinity is brought to focus. The focal length divided by the aperture of the mirror or lens is termed the focal ratio.
--------------	--

J - Jovian Planets	Any of the four gas giant planets that are at a greater distance from the sun than the terrestrial planets.
K - Kuiper Belt	A region beyond the orbit of Neptune extending to about 1000 AU which is a source of many short period comets.
L - Light-Year (ly)	A light-year is the distance light traverses in a vacuum in one year at the speed of 299,792 km/ sec. With 31,557,600 seconds in a year, the light-year equals a distance of 9.46 X 1 trillion km (5.87 X 1 trillion mi).
M - Magnitude	Magnitude is a measure of the brightness of a celestial body. The brightest stars are assigned magnitude 1 and those increasingly fainter from 2 down to magnitude 5. The faintest star that can be seen without a telescope is about magnitude 6. Each magnitude step corresponds to a ratio of 2.5 in brightness. Thus a star of magnitude 1 is 2.5 times brighter than a star of magnitude 2, and 100 times brighter than a magnitude 5 star. The brightest star, Sirius, has an apparent magnitude of -1.6, the full moon is -12.7, and the Sun's brightness, expressed on a magnitude scale, is -26.78. The zero point of the apparent magnitude scale is arbitrary.
Meridian	A reference line in the sky that starts at the North celestial pole and ends at the South celestial pole and passes through the zenith. If you are facing South, the meridian starts from your Southern horizon and passes directly overhead to the North celestial pole.
Messier	A French astronomer in the late 1700's who was primarily looking for comets. Comets are hazy diffuse objects and so Messier cataloged objects that were not comets to help his search. This catalog became the Messier Catalog, M1 through M110.
N - Nebula	Interstellar cloud of gas and dust. Also refers to any celestial object that has a cloudy appearance.
North Celestial Pole	The point in the Northern hemisphere around which all the stars appear to rotate. This is caused by the fact that the Earth is rotating on an axis that passes through the North and South celestial poles. The star Polaris lies less than a degree from this point and is therefore referred to as the "Pole Star".
Nova	Although Latin for "new" it denotes a star that suddenly becomes explosively bright at the end of its life cycle.
O - Open Cluster	One of the groupings of stars that are concentrated along the plane of the Milky Way. Most have an asymmetrical appearance and are loosely assembled. They contain from a dozen to many hundreds of stars.
P - Parallax	Parallax is the difference in the apparent position of an object against a background when viewed by an observer from two different locations. These positions and the actual position of the object form a triangle from which the apex angle (the parallax) and the distance of the object can be determined if the length of the baseline between the observing positions is known and the angular direction of the object from each position at the ends of the baseline has been measured. The traditional method in astronomy of determining the distance to a celestial object is to measure its parallax.
Parfocal	Refers to a group of eyepieces that all require the same distance from the focal plane of the telescope to be in focus. This means when you focus one parfocal eyepiece all the other parfocal eyepieces, in a particular line of eyepieces, will be in focus.
Parsec	The distance at which a star would show parallax of one second of arc. It is equal to 3.26 light-years, 206,265 astronomical units, or 30,8000,000,000,000 km. (Apart from the Sun, no star lies within one parsec of us.)
Point Source	An object which cannot be resolved into an image because it is too far away or too small is considered a point source. A planet is far away but it can be resolved as a disk. Most stars cannot be resolved as disks, they are too far away.
R - Reflector	A telescope in which the light is collected by means of a mirror.
Resolution	The minimum detectable angle an optical system can detect. Because of diffraction, there is a limit to the minimum angle, resolution. The larger the aperture, the better the resolution.
Right Ascension: (RA)	The angular distance of a celestial object measured in hours, minutes, and seconds along the Celestial Equator eastward from the Vernal Equinox.
S - Sidereal Rate	This is the angular speed at which the Earth is rotating. Telescope tracking motors drive the telescope at this rate. The rate is 15 arc seconds per second or 15 degrees per hour.
T -	

Terminator	The boundary line between the light and dark portion of the moon or a planet.
U -	
Universe	The totality of astronomical things, events, relations and energies capable of being described objectively.
V -	
Variable Star	A star whose brightness varies over time due to either inherent properties of the star or something eclipsing or obscuring the brightness of the star.
W -	
Waning Moon	The period of the moon's cycle between full and new, when its illuminated portion is decreasing.
Waxing Moon	The period of the moon's cycle between new and full, when its illuminated portion is increasing.
Z -	
Zenith	The point on the Celestial Sphere directly above the observer.
Zodiac	The zodiac is the portion of the Celestial Sphere that lies within 8 degrees on either side of the Ecliptic. The apparent paths of the Sun, the Moon, and the planets, with the exception of some portions of the path of Pluto, lie within this band. Twelve divisions, or signs, each 30 degrees in width, comprise the zodiac. These signs coincided with the zodiacal constellations about 2,000 years ago. Because of the Precession of the Earth's axis, the Vernal Equinox has moved westward by about 30 degrees since that time; the signs have moved with it and thus no longer coincide with the constellations.

Appendix C - RS-232 Connection

You can control your NexStar telescope with a computer via the PC port on the hand control and using an optional RS-232 cable (see Optional Accessories section of manual). Once connected, the NexStar can be controlled using popular astronomy software programs.

Communication Protocol:

The NexStar telescopes communicate at 9600 bits/sec, No parity and a stop bit. All angles are communicated with 16 bit angle and communicated using ASCII hexadecimal.

	PC Command ASCII	Hand Control Response	Notes
Echo	Kx	X#	Useful to check communication
Goto Azm/Alt	B12AB, 4000	#	10 characters sent. B=Command, 12AB=Azm, comma, 4000=Alt. If command conflicts with slew limits, there will be no action.
Goto Ra/Dec	R34AB, 12CE	#	Scope must be aligned. If command conflicts with slew limits, there will be no action.
Get Azm/Alt	Z	12AB, 4000#	10 characters returned, 12AB=Azm, comma, 4000=Alt, #
Get RA/Dec	E	34AB, 12CE#	Scope must be aligned
Set Azm-Alt	S12AB, 4000	#	10 characters sent. S=Command, 12AB=Azm, comma, 4000=Alt
Cancel Goto	M	#	
Is Goto in Progress	L	0# or 1#	0=No, 1=Yes; "0" is ASCII character zero
Is Alignment Complete	J	0# or 1#	0=No, 1=Yes

The cable required to interface to the telescope has an RS-232 male plug at one end and a 4-4 telephone jack at the other end. The wiring is as follows:

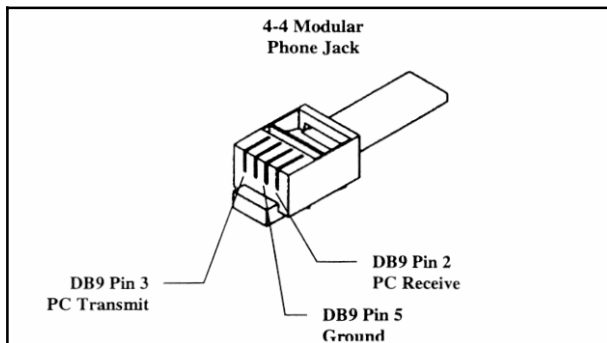

APPENDIX D – MAPS OF TIME ZONES

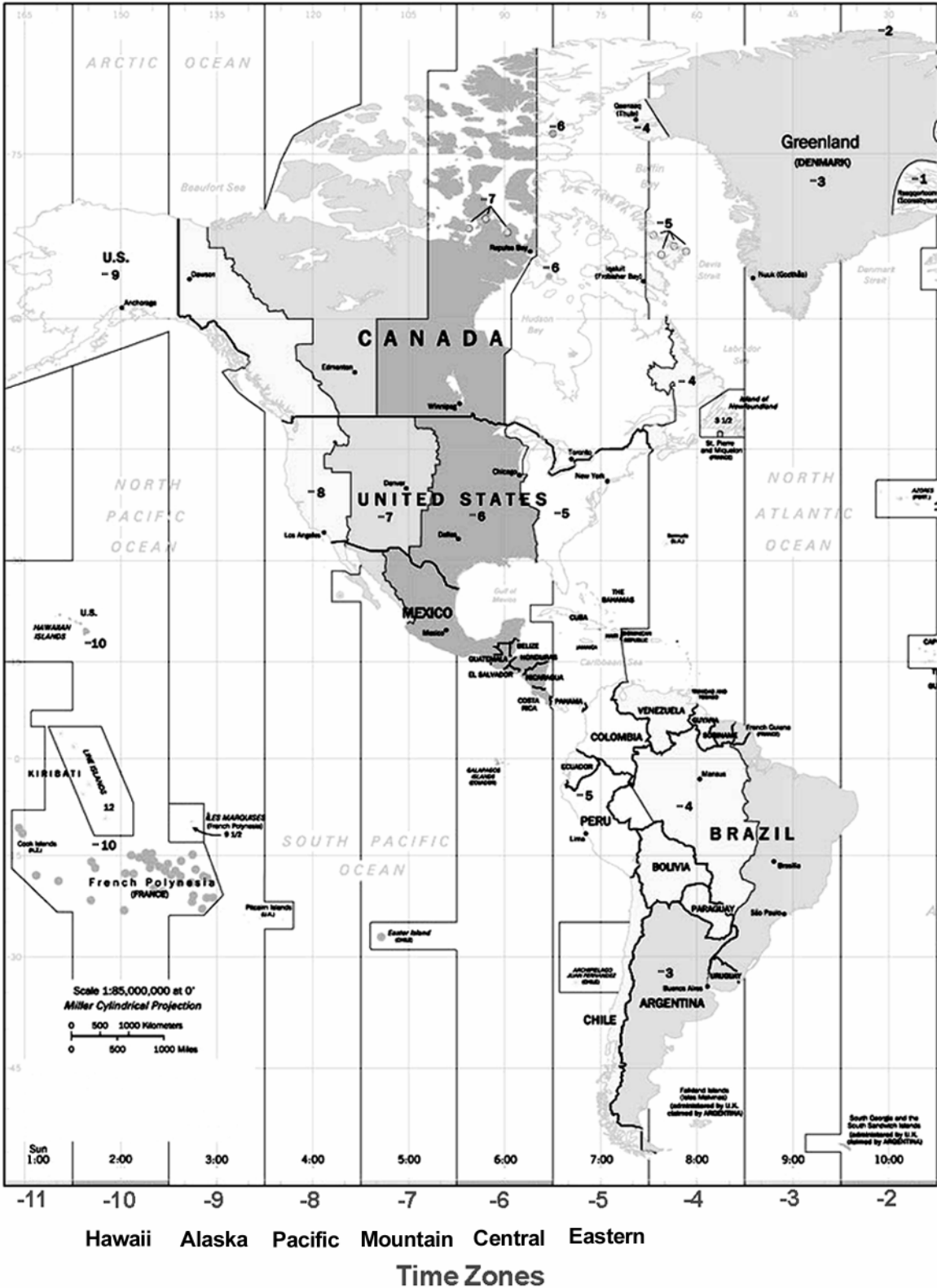

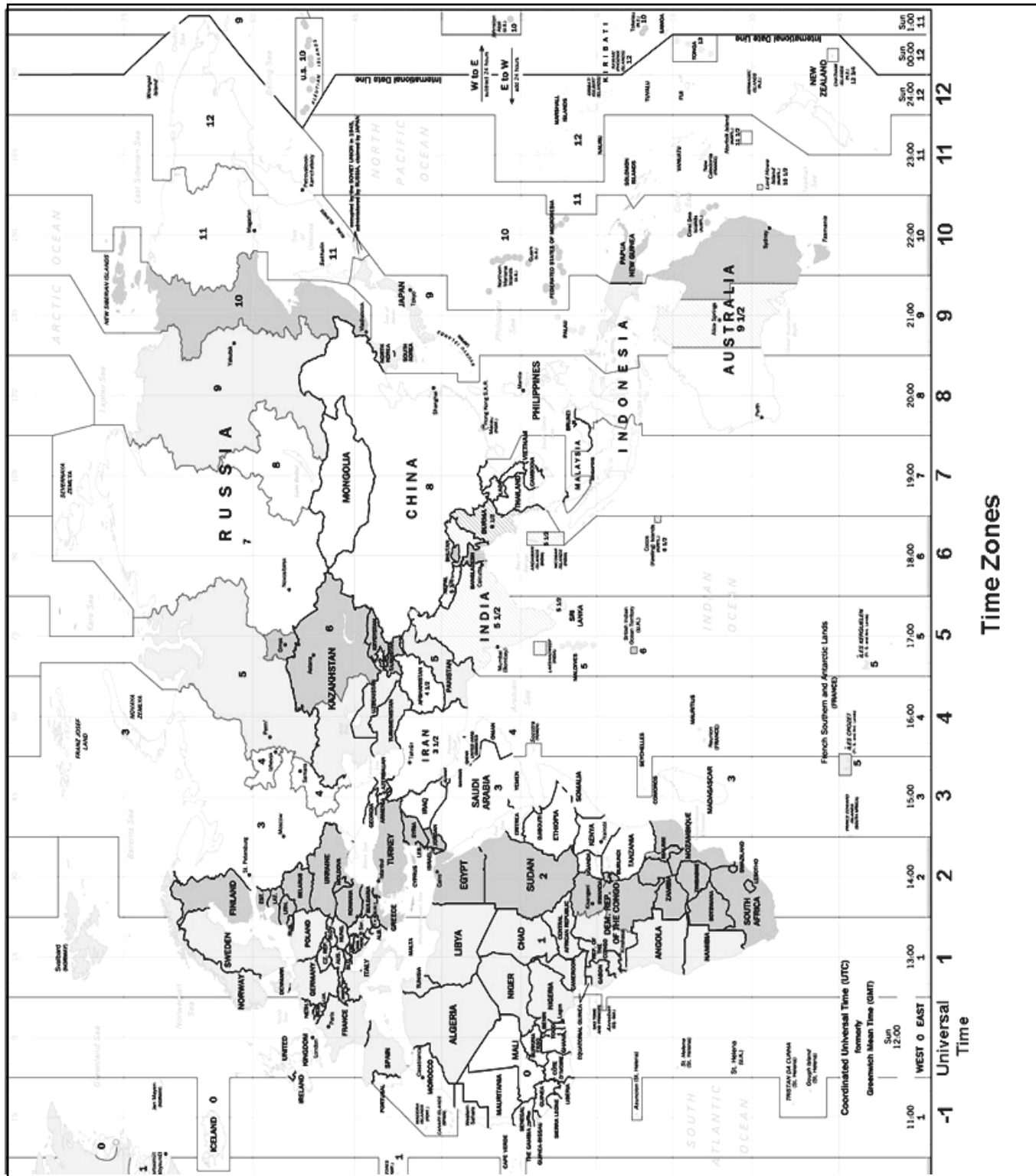

January - February Sky

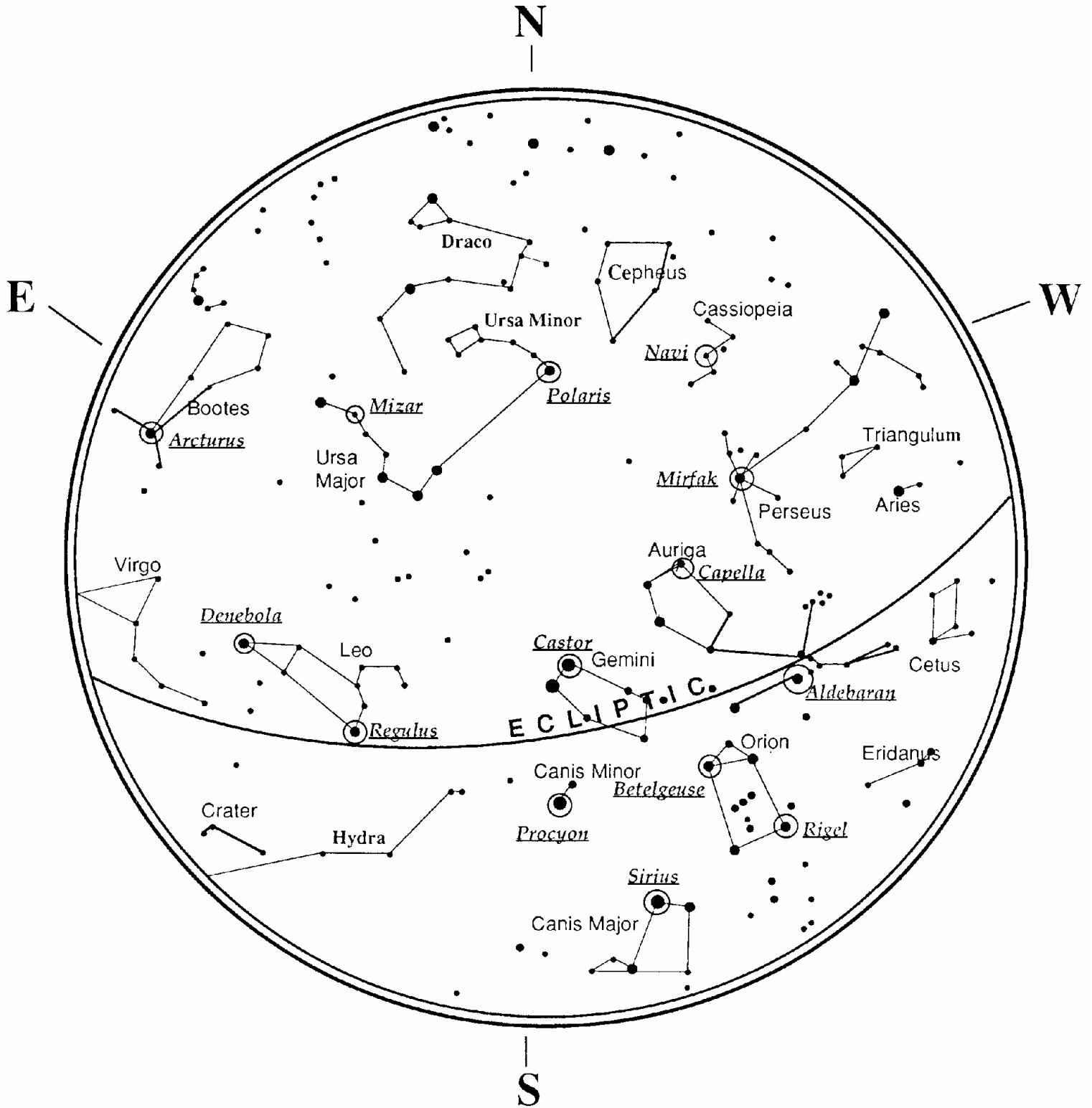

March - April Sky

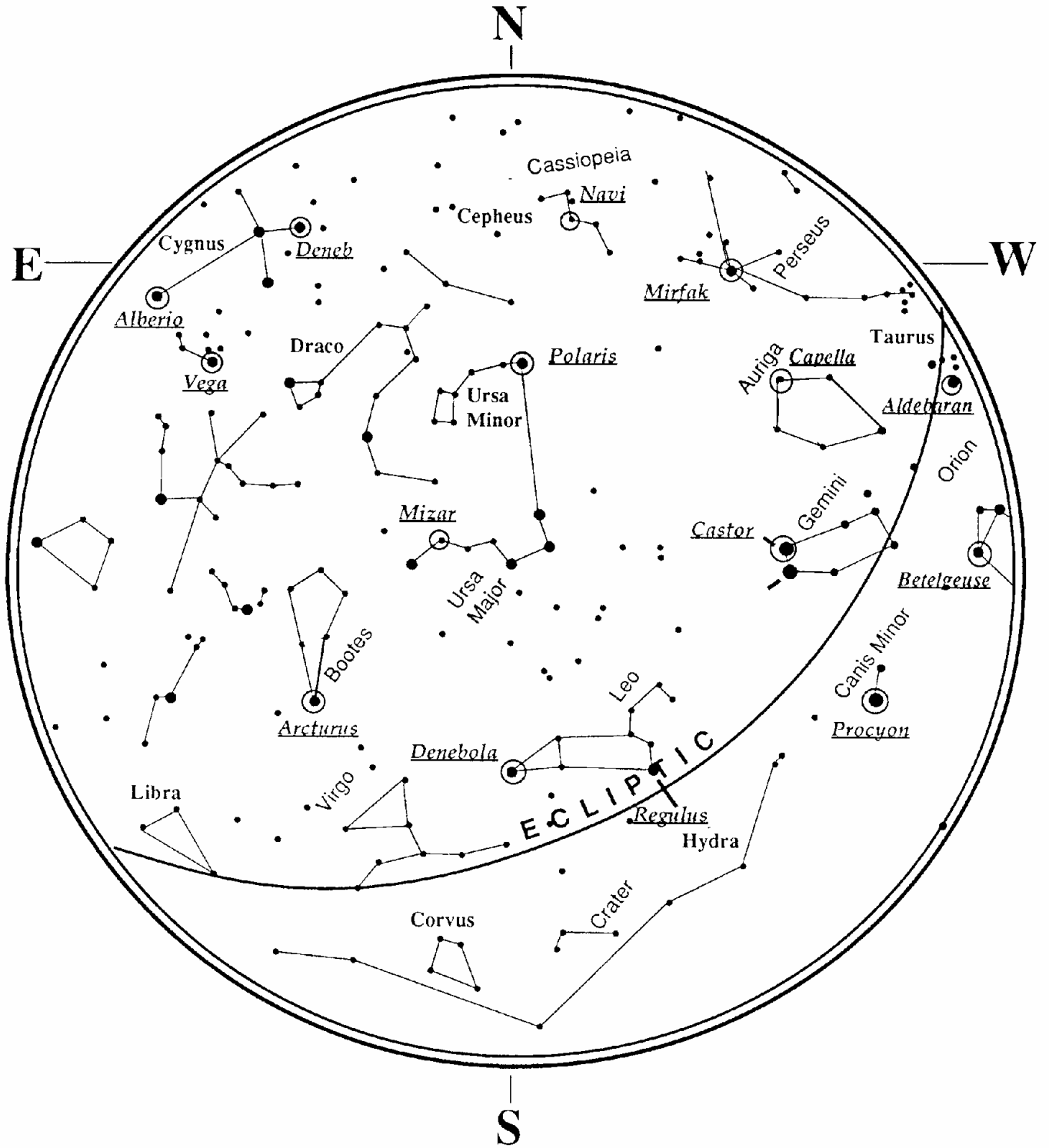

May - June Sky

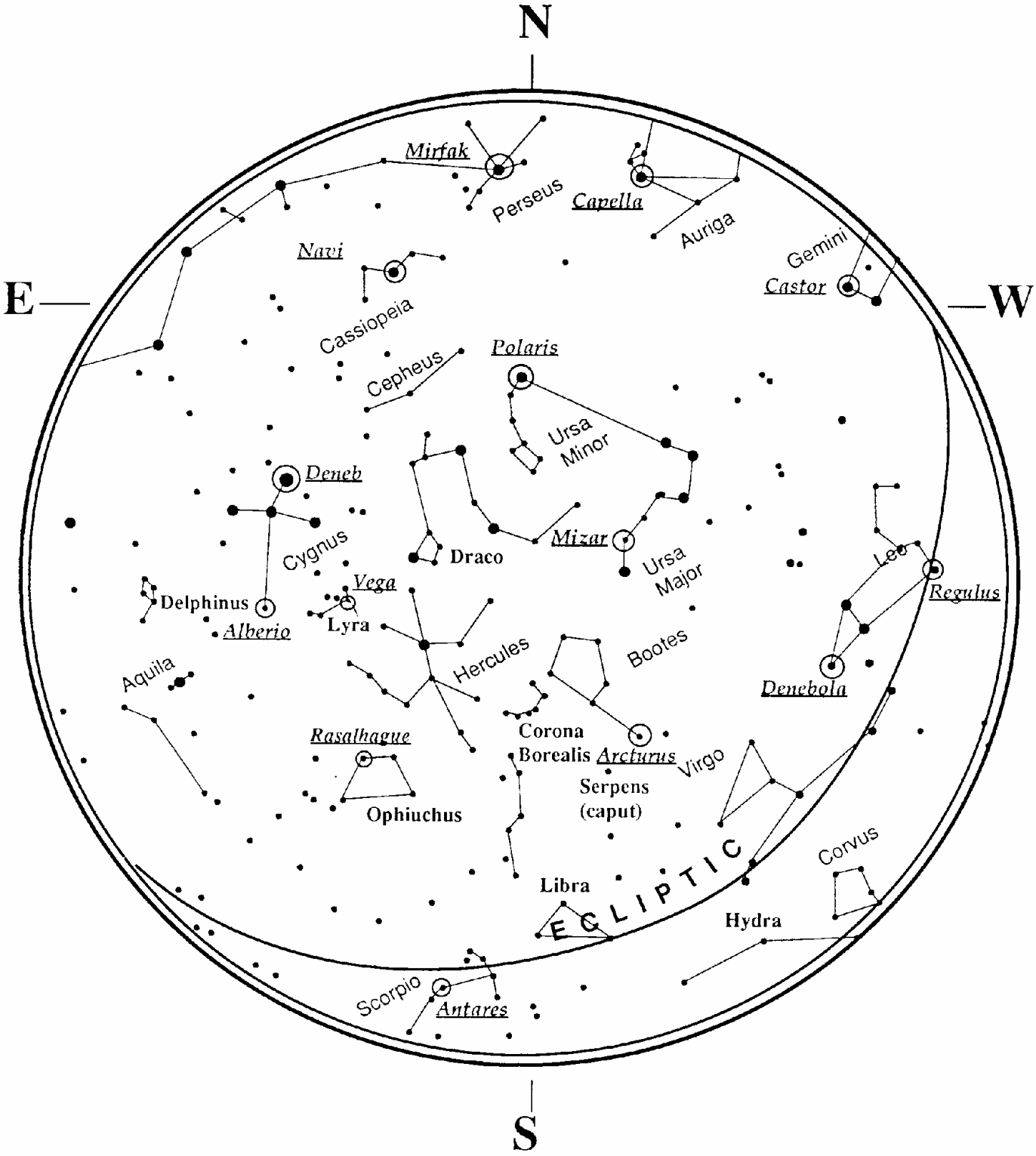

July - August Sky

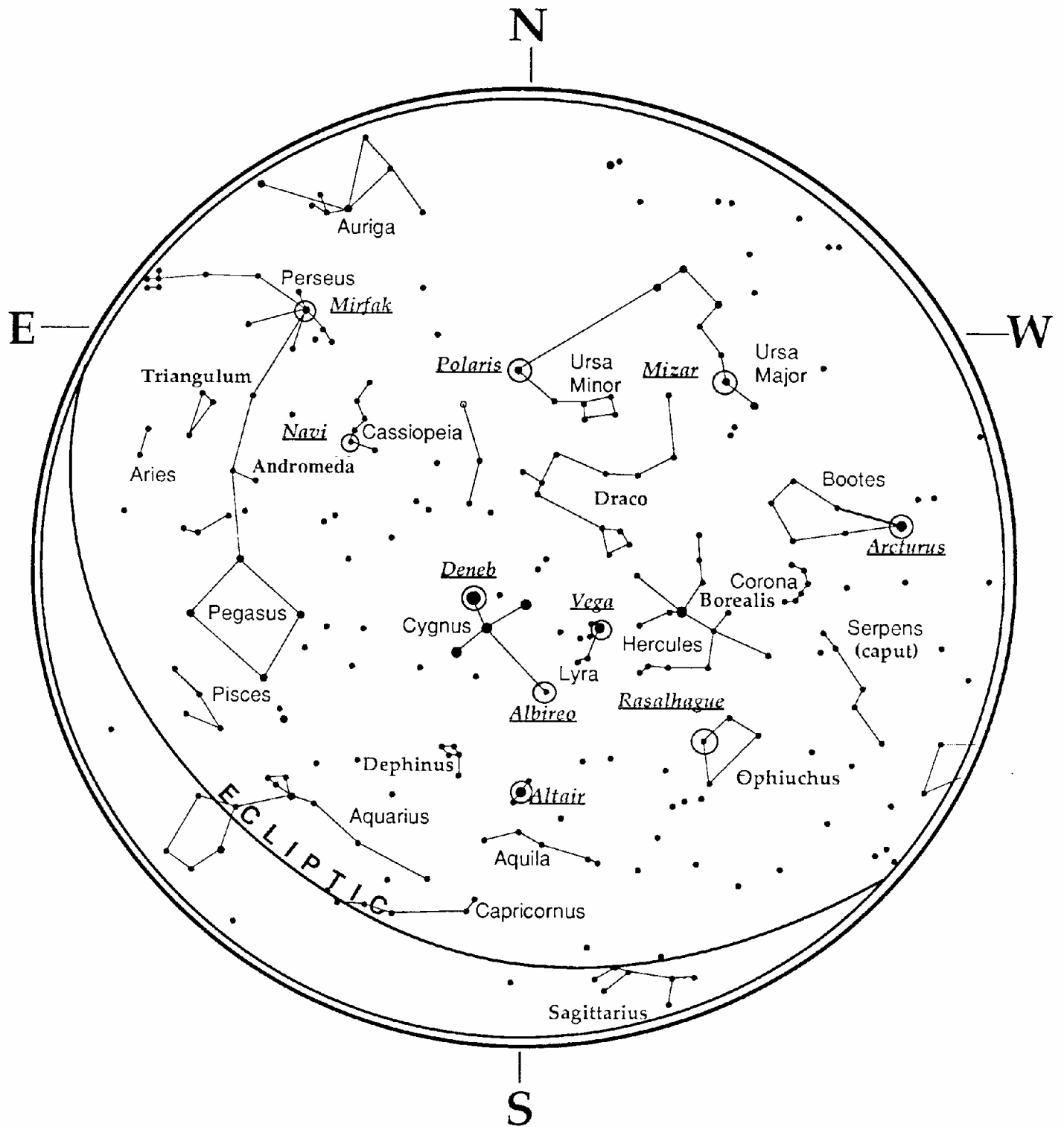

September - October Sky

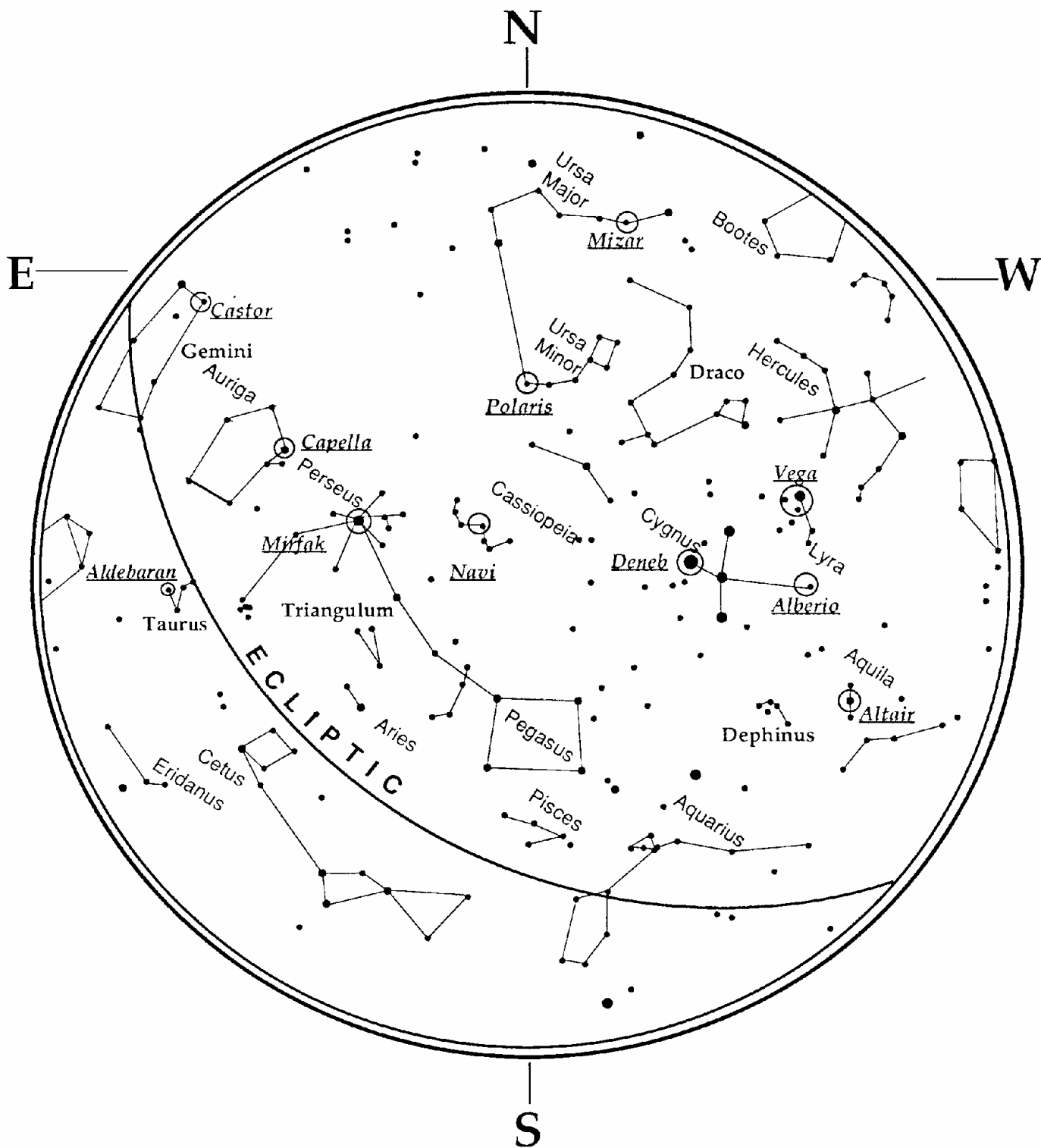

November - December Sky

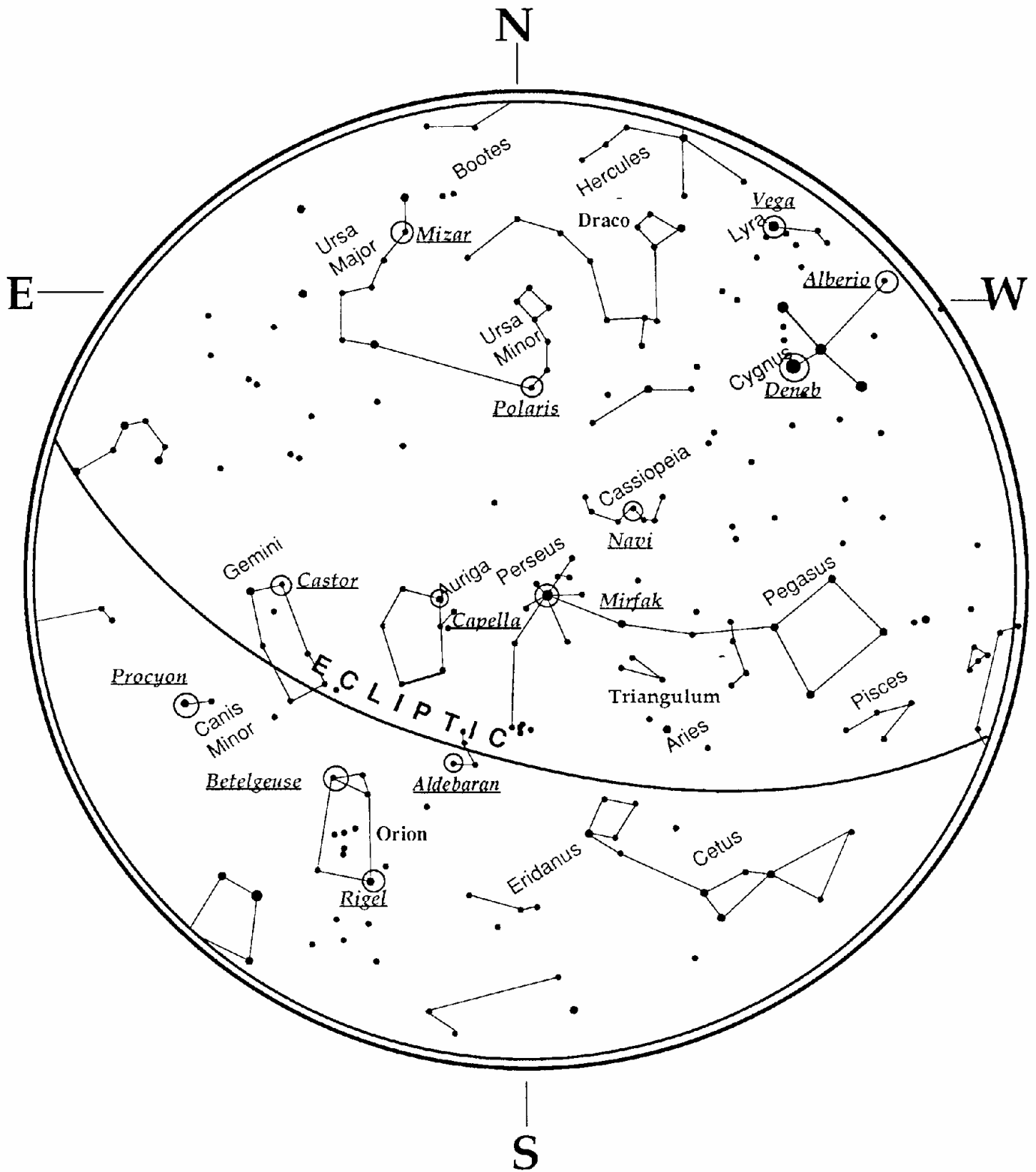

CELESTRON TWO YEAR WARRANTY

A. Celestron warrants this telescope to be free from defects in materials and workmanship for two years. Celestron will repair or replace such product or part thereof which, upon inspection by Celestron, is found to be defective in materials or workmanship. As a condition to the obligation of Celestron to repair or replace such product, the product must be returned to Celestron together with proof-of-purchase satisfactory to Celestron.

B. The Proper Return Authorization Number must be obtained from Celestron in advance of return. Call Celestron at (310) 328-9560 to receive the number to be displayed on the outside of your shipping container.

All returns must be accompanied by a written statement setting forth the name, address, and daytime telephone number of the owner, together with a brief description of any claimed defects. Parts or product for which replacement is made shall become the property of Celestron.

The customer shall be responsible for all costs of transportation and insurance, both to and from the factory of Celestron, and shall be required to prepay such costs.

Celestron shall use reasonable efforts to repair or replace any telescope covered by this warranty within thirty days of receipt. In the event repair or replacement shall require more than thirty days, Celestron shall notify the customer accordingly. Celestron reserves the right to replace any product which has been discontinued from its product line with a new product of comparable value and function.

This warranty shall be void and of no force of effect in the event a covered product has been modified in design or function, or subjected to abuse, misuse, mishandling or unauthorized repair. Further, product malfunction or deterioration due to normal wear is not covered by this warranty.

CELESTRON DISCLAIMS ANY WARRANTIES, EXPRESS OR IMPLIED, WHETHER OF MERCHANTABILITY OF FITNESS FOR A PARTICULAR USE, EXCEPT AS EXPRESSLY SET FORTH HEREIN.

THE SOLE OBLIGATION OF CELESTRON UNDER THIS LIMITED WARRANTY SHALL BE TO REPAIR OR REPLACE THE COVERED PRODUCT, IN ACCORDANCE WITH THE TERMS SET FORTH HEREIN. CELESTRON EXPRESSLY DISCLAIMS ANY LOST PROFITS, GENERAL, SPECIAL, INDIRECT OR CONSEQUENTIAL DAMAGES WHICH MAY RESULT FROM BREACH OF ANY WARRANTY, OR ARISING OUT OF THE USE OR INABILITY TO USE ANY CELESTRON PRODUCT. ANY WARRANTIES WHICH ARE IMPLIED AND WHICH CANNOT BE DISCLAIMED SHALL BE LIMITED IN DURATION TO A TERM OF TWO YEARS FROM THE DATE OF ORIGINAL RETAIL PURCHASE.

Some states do not allow the exclusion or limitation of incidental or consequential damages or limitation on how long an implied warranty lasts, so the above limitations and exclusions may not apply to you.

This warranty gives you specific legal rights, and you may also have other rights which vary from state to state.

Celestron reserves the right to modify or discontinue, without prior notice to you, any model or style telescope.

If warranty problems arise, or if you need assistance in using your telescope contact:

Celestron
Customer Service Department
2835 Columbia Street
Torrance, CA 90503
Tel. (310) 328-9560
Fax. (310) 212-5835
Monday-Friday 8AM-4PM PST

All authorized returns should be shipped to:

Celestron
1380 Charles Willard St.
Carson, CA 90747

This warranty supersedes all other product warranties.

NOTE: This warranty is valid to U.S.A. and Canadian customers who have purchased this product from an Authorized Celestron Dealer in the U.S.A. or Canada. Warranty outside the U.S.A. and Canada is valid only to customers who purchased from a Celestron Distributor or Authorized Celestron Dealer in the specific country and please contact them for any warranty service.



Celestron
2835 Columbia Street
Torrance, CA 90503
Tel. (310) 328-9560
Fax. (310) 212-5835
Web site at <http://www.celestron.com>

Copyright 2004 Celestron
All rights reserved.

(Products or instructions may change
without notice or obligation.)

This device complies with Part 15 of the FCC Rule. Operation is subject to the following two conditions: 1) This device may not cause harmful interference, and 2) This device must accept any interference received, including interference that may cause undesired operations.

04-04
Printed in China
\$10.00