

1 Introduction

1.1 Phone Display





We continuously strive to improve our products. Therefore, we reserve the rights to revise this user manual or withdraw it at any time without prior notice.

MPEG Layer-3 audio coding technology licensed from Fraunhofer IIS and Thomson. Supply of this product does not convey a license nor imply any right to distribute MPEG Layer-3 compliant content created with this product in revenue-generating broadcast systems (terrestrial, satellite, cable and/or other distribution channels), streaming applications (via internet, intranets and/or other networks), other content distribution systems (pay-audio or audio-on-demand applications and the like) or on physical media (compact discs, digital versatile discs, semiconductor chips, hard drives, memory cards and the like). An independent license for such use is required. For details, please visit <http://mp3licensing.com>.













1.2 Key

Key	Function
Dial / Answer Key	Press to answer a call or dial a call after you enter a phone number. In idle mode, press to view the call log.
End / Power Key	Press to end a call. Press and hold to turn the phone on/off. Within a menu, press to return to idle mode.

Left Soft Key	In idle mode, press to enter the main menu. Press to access the option listed directly above it on the display.
Right Soft Key	In idle mode, press to access the Call center. Press to access the option listed directly above it on the display. Within a menu, press to return to the previous screen.
OK Key	In idle mode, press to access the service.
Numeric key	Press to enter the corresponding number, letter or symbol located on the key. Within a menu, press to access the corresponding menu option.
*	Press the * Key twice quickly to enter '+' to make an international call. Press and hold the * Key to toggle between *, +, (pause character) P, and (wait character) W. Press to enter symbol when editing text.
#	In idle mode, press and hold to activate or deactivate the silent mode. Press to switch input modes when entering text.
Navigation Key	Within a menu, press Up, Down, Left or Right to scroll through menu options.

Note: "Press" in this manual, means to press and release the key; "press and hold" means to press and hold the key for at least 2 seconds.

1.3 Icons & Symbols

Icon	Description
	Network - The left portion indicates whether your phone is already registered with a network and the right portion indicates signal strength (from no signal to strongest).
	Battery - Indicates battery level. When charging, a scrolling icon will be displayed. The more bars, the stronger the charge.
	To log on GPRS - The icon will be displayed only when you have logged onto GPRS.
	MMS - Indicates you have one or more unread MMS messages.
	Message - Indicates you have one or more unread messages.
	Push message-Indicates that you have received new push message.
	Voicemail- Indicates voice messages that have not been heard.
	Missed call - Indicates there is a missed call.
	Call Divert - Indicates that “Divert All Voice Calls” is activated.
	Alarm-Indicates that the alarm clock is on.
	Headset-Indicates that headset profile is activated.
	Alert type is “Ring”.

2 Getting Started

Please read the safety instructions in the "Safety Information and Notices" section before use.

2.1 Inserting the SIM Card

Remove the back cover(1), remove the battery (2), and insert the SIM card (3)

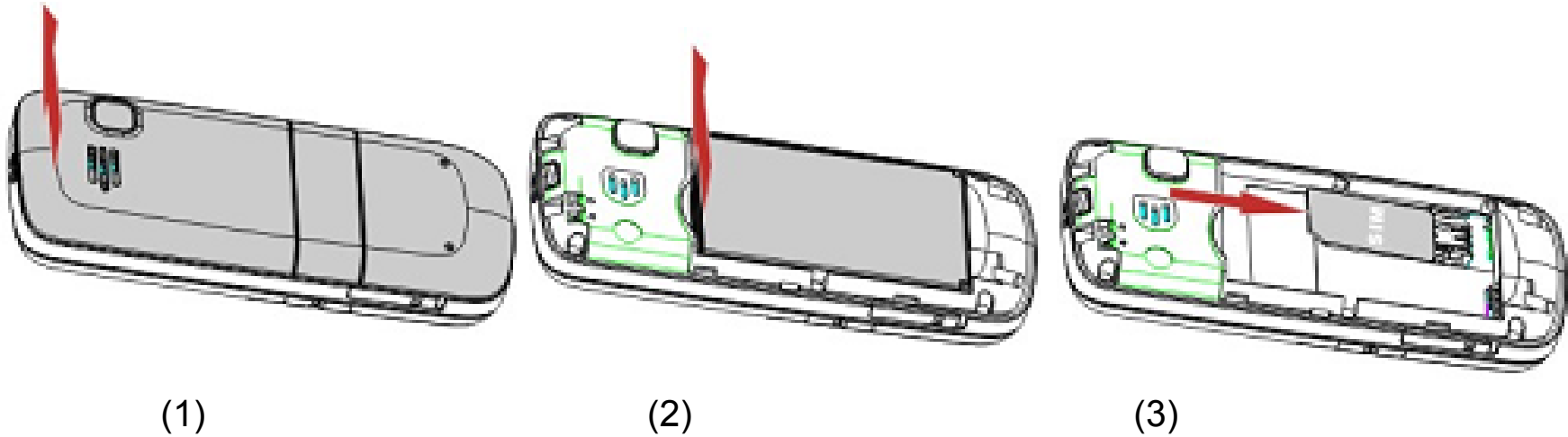

Install the battery and back cover

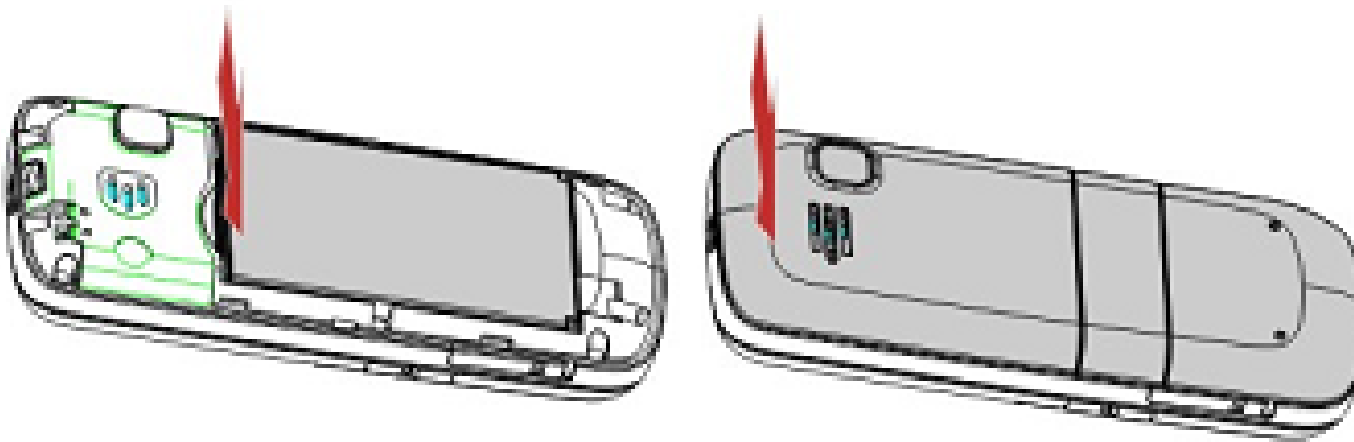

2.2 Turning the phone on

To turn the phone on, press and hold the End / Power key. Enter the PIN code if required.

2.3 Charging the Battery

1. Ensure the battery is inserted in the handset. To charge the battery, plug in the charger connector at the bottom of your phone (USB interface) and then plug the other end into an AC power socket.
2. The battery symbol indicates the charging status. While charging, the charge indicators will scroll. When all the scroll bars are steady, the battery is fully charged.
3. Disconnect the charger from the phone.
4. Disconnect the charger from the AC power socket.

Note: If the battery is powerless, the battery icon will reappear after a few minutes of charging.

2.4 Inserting a T-Flash Card

1. Open the T-Flash cover on the right side of your phone.

2. Gently slide the card into the slot and press it down until the card locks into place. If you want to get the T-Flash card out, gently press the T-Flash card, then you can remove it from your phone.
3. The T-Flash Card is not delivered as an accessory in your packing box.

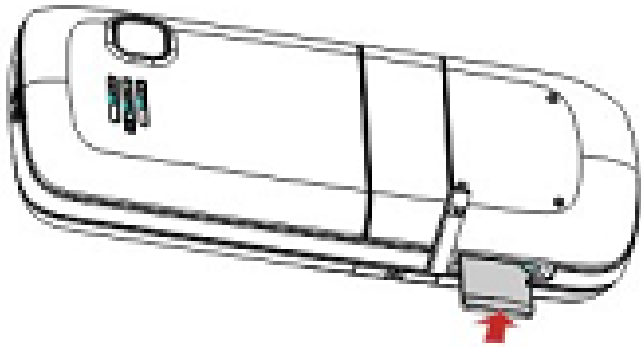

2.5 Important Password

Phone lock password is 1234.

3 Text Entry

3.1 Input Method

During text editing, you can press the # Key to switch input modes or press the Left Soft Key [Option] and select **Input Method** to select different input modes.

3.1.1 Entering Symbols

In any input mode, press the * Key to open the symbols input screen.

3.2 Smart Input Method

2 to 9	Press to input letters
1	Press to input symbol
0	Press to input space
◀/▶	Press to confirm the letter or word, or move the cursor to left or right.
▲/▼	Press to browse the last or next available word.
Left Soft Key (Select) or the OK Key	Press to confirm the letter or word
Right Soft Key (Clear)	Press to clear a letter, press and hold to clear all entries
#	Switch between input mode
*	Press to activate punctuation mode

Example: How to enter the word "HOME"

1. Press the # Key to switch to **Smart ABC**;
2. Press 4 6 6 3, the first word “GOOD” appears;
3. Press ► to browse and select “HOME”;
4. Press the Left Soft Key [Select] or OK Key to confirm “HOME”.

3.3 Multi-tap Input

Using this mode requires you to press a key as many times as needed to enter the desired letter.

To enter the word “casa” in Multi-tap input mode “abc”, press key 2 (ABC) three times, press key 2 (ABC) once, press key 7 (PQRS) four times, press key 2 (ABC) once.

3.4 Numeric Input

Press the # Key to select “123” then you can enter the numbers.

4 Calling

4.1 Making a Call

Note: You can make a call only when the network name appears on the screen.

1. In idle mode, enter the phone number.
2. Press the Dial / Answer Key to dial the number.
3. Press the End / Power Key to end the call.



Note: During a call, press the Navigation Key Up/Down to adjust the volume. You can press the Left Soft Key [Option] to choose **Sound Recorder**.

Note: in most countries, recording telephone conversations is subject to legislation. We advise you to notify the caller if you intend to record your conversation and only do so if they agree.

4.2 Making an International Call

1. Press the * Key twice quickly until "+" appears on the screen.
2. Enter the country code.
3. Enter the area code (normally without the 0 before it) followed by the phone number.
4. Press the Dial / Answer Key to call directly.

4.3 Answering or Rejecting a incoming Call

1. Press the Dial / Answer Key to answer a call.
2. Press the End / Power key to reject a call.

5 Function Menu

5.1 Main Menu

Messaging	Fun & Games	STK Service
Call center	Services	Phonebook
Multimedia	Organizer	Settings

5.2 Messaging

5.2.1 Creating a text message

1. Select **Menu > Messaging > Write message > Text message**.
2. Write a message, please refer to the **Text entry** section of this manual for detailed information.
3. After entering text, you can access the send options by pressing the Left Soft Key [Options] and then select **Send to**

5.2.2 Creating a multimedia message

1. In idle mode, press the Left Soft Key [Menu] to enter the main menu.
2. Select **Messaging > Write Message > Multimedia message**, The MMS editing screen will appear. you are able to add picture, sound and video into your message.
3. After finished, select **Options** and then **Send to**.
4. Add the recipient by inputting the number manually or searching them in the phonebook.
5. Finally, select Options and select the send option to send the message.

5.2.3 Voicemail Server

This menu allows you to set your voice mailbox number and listen to your voice messages.

To set your voice mailbox number, select **Messaging > Message settings > Text message > Voicemail server**.

Note: You can forward your calls to your voice mailbox (the phone number for callers to leave a message) via the Call forwarding feature.

5.2.4 Broadcast Message

1. Select **Menu > Messaging > Broadcast message**.
2. Press the Left Soft Key [On] to activate this function.
3. Press the Navigation Key Down to select **Channel settings** to enter the channel number.

5.3 Fun & Games

Your cellular phone provides you with several games.

You can also adjust the game settings when you enter the game menu.

5.4 STK Service



Note: The submenus of this feature depends on the operator and different operators may provide different services (some SIM cards do not support STK), which cannot be modified.

Please contact your operator.

5.5 Call Center

5.5.1 View Call History

1. Select **Menu > Call center > Call history**.
2. Press the Navigation Key to view different call logs.
3. Choose a particular number and press the Dial Key to call the number directly.

5.5.2 Adjust Call Settings

1. Select **Menu > Call center > Call settings**.
2. Now you can set the call waiting, call divert, and so on.

5.6 Services

Network Settings

In general, your phone has a built-in data account and WAP settings, so you do not need to change these settings. If you cannot connect the WAP, you should follow the steps below to change the WAP settings. Please contact your operator for more information.

1. Press **Menu > Services > Data account**.
2. Select the network type, press **Options>Add** .
3. Set the account information to save the settings.
4. Go to **Menu > Services > Internet service > Settings > Profiles**.
5. Select one of the profiles, press the OK Key.
6. Select **View** or **Edit** , you can view or edit the profile information.
7. Activate the account.

Connecting to the Network

1. Press **Menu > Services > Internet Service > Input Address**.
2. Enter the URL address.
3. Press the Left Soft key [Options] and select “**Done**” to access the address.

5.7 Phonebook

Your phone features two phonebooks, the SIM phonebook and the smart phonebook which is integrated in the phone memory.

5.7.1 Search contact

1. Press **Menu > Phonebook**.
2. Enter the first few letters of the contact name to search.



Note: You can also press the Navigation Down Key in the idle mode to access the contact list.

5.7.2 Add New Contact

To create a new SIM/phone contact:

1. Select **Menu > Phonebook > Add new contact**.

If you want to change the storage position, press the Left Soft Key [Options] and then select **Phonebook setting > Preferred storage** to set the storage position.

2. Press the **Options > select** to enter the contact information.
3. Press the OK Key or **Done** to save the contact.

5.7.3 Phonebook settings

1. Select **Menu > Phonebook**
2. If you select a contact, press the Left Soft Key [Options] can call, edit, copy, move, and so on.
3. Select one item, press the Left Soft Key [Options] and select **Phonebook settings**.

Now you can set the speed dial, view the memory status, copy or move contacts, and so on.

5.8 Multimedia

5.8.1 Camera

Please ensure that the camera lens is clean before you take pictures, as small dust particles can strongly affect the picture quality.

How to ...

Launch Camera	From idle mode, press the Left Soft Key to enter the main menu then select Multimedia > Camera .
Adjust settings	Press the Left Soft Key
Take a picture	Press the OK Key. After taking, the picture will be saved as JPG format in Multimedia > File Manager > Phone/Memory card >Photos menu automatically.
Exit	Press the End / Power Key or the Right Soft Key.

5.8.2 Image Viewer

This menu lists the picture from **Multimedia > File Manager > Phone/Memory card > Photos** according to its storage setting.

5.8.3 Video Recorder

1. Select **Menu > Multimedia > Video Recorder**.
2. Press the Left Soft Key to adjust settings.
3. On the previous menu, press the “OK” key to record. Press “OK” key again to pause or resume.

4. If you have finished, press the Right Soft Key to stop recording.
5. Press the Left Soft Key [Yes] to save the video just recorded.

5.8.4 Video Player

Keys Operation

The keypad operations during video playback are as follows:

Key	Description
The OK key	Press to play/pause/resume the selected video file.
Navigation key ▲ or ▼	Set the play speed.
Navigation key ◀ or ▶	Press to rewind or fast forward the selected video file.
Right Soft key [Stop]	Press to stop playing.
The * or # key	Adjust volume.

5.8.5 Audio Player

Keys Operation

The keypad operations during music playback are as follows:

Key	Description
The OK Key	List the audio file from the storage you set.
Navigation Key Down ▼	Press to stop the music.

Navigation Key ◀ or ▶	Short press to select the previous song/next song. Press and hold to rewind/fast forward the track during playback.
*, #	Adjust volume. Once you have set the volume, the settings will be saved until the next time you adjust the volume.
Left Soft Key [List]	List the audio file from the storage you set.
Right Soft Key [Back]	Return to previous menu.
Navigation Key Up ▲	Press to Start/Pause/resume the current music.

5.8.6 Sound Recorder

1. Select **Menu > Multimedia > Sound Recorder**.
2. Press the Left Soft Key [Options] and select **Settings** to set your preferred storage, file format and audio quality.
3. Back to the previous menu, select **New Record**.
4. In the recording screen, you can press the Left Soft Key to pause or continue.
5. If you have finished, press the Right Soft Key [Stop] to stop recording.

Note: Saved sound files can be found in the **Multimedia > File Manager > Phone/ Memory card > Audio** menu according to your storage setting.

5.8.7 FM Radio

Note: The radio will not work unless the headset is attached. Attach the headset included with your phone

to the USB port located at the bottom of the phone.

To operate the radio:

1. Press the Navigation Key Down to activate or deactivate the FM radio.
2. Press the * / # Key to adjust the volume.
3. Press the Navigation Key Up to activate or deactivate **Auto search**.
4. Press the Navigation Key Right/Left to switch the channels. If auto search is activated, pressing the Navigation Key Right/Left will switch the available searched channels; if auto search is deactivated, pressing the Navigation Key Right/Left will switch to varying channels by 0.1 intervals.
5. Press the Left Soft Key [Options] to access FM settings.

5.8.8 File manager

1. Select **Menu > Multimedia > File Manager**.
2. Press the Left Soft Key [Options] and select Open to view different folders.

Note: maybe some folders do not appear, such as “My Music”, if user enters Multimedia > Audio Player, “My Music” folder will automatically be created in File Manager.

5.9 Organizer

This menu contains features and options designed to keep you organized and informed while on the go. As most of the features are very simple, here you can only view some important features.

5.9.1 Create a new event

1. Select **Menu > Organizer > Calendar**.
2. Press the Navigation Key to select a date.
3. Press the Left Soft Key [Options] and select **Add event**.
4. Select the event type.
5. Enter the event informations.
6. Press the Right Soft Key [Done] to save it.

5.9.2 Set an alarm

1. Select **Menu > Organizer > Alarm**.
2. Select an alarm and then press the Left Soft Key [Edit] to create.
3. Press the Navigation Key Left or Right to turn it on or off.
4. Enter other informations, such as time, repeat, and so on.

5.9.3 Calculator

Your phone has a built in calculator. Enter the numbers using the keypad. An icon will appear on the screen indicating how to do calculations:

Keys	Operation
Up	Addition
Down	Subtraction
Left	Multiplication

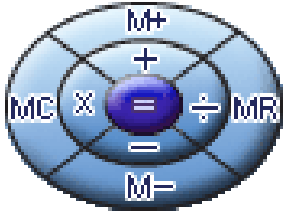

Right	Division
Left Soft Key	To calculate
Right Soft Key	To clear or exit Calculator
# key	To enter decimal point

Note: Pressing the Navigation Key Up/ Down can switch between +, M+, M-, -; press the Navigation Key Left/ Right can switch between MC, x, ÷, MR.

5.10 Settings

You can configure your cellular phone to best suit your usage preferences.

5.10.1 Activate user profiles

1. Select **Menu > Settings > User profiles**.
2. Select one of the profile.
3. Select **Customize** to adjust the settings.
4. Back to previous menu, select **Activate**.



Note: Headset profile can only be activated by plugging in a headset.

5.10.2 Set Wallpaper

1. Select **Menu > Settings > Phone settings > Display > Wallpaper**.
2. Select **System** if you want to choose from the default pictures.
3. Select **User defined** if you want to choose a picture from **Menu > Multimedia > File Manager**.

6 Precautions



Please carefully read and observe the terms below:

Safe power on

Do not use your cellular phone where it is forbidden to use or you might cause a disturbance or danger.



Safe transportation first

Please observe all related local laws and regulations.

Please drive with both hands.

Safe transportation should be considered first when driving.

Disturbance

All cellular phone performances might be disturbed.

Switch off in hospital

Please follow related limitations.

Please switch your cellular phone off when near a medical instrument.



Switch off on airplane

Please follow related limitations.

Do not use your cellular phone on an airplane.



Switch off when pumping gasoline

Do not use your cellular phone at a filling station or around fuels or chemicals.

Switch off near exposure Area

Please observe related limitations and do not use your cellular phone near an area where explosions can occur.

Proper use

As described in this manual, your cellular phone can be used only in the correct location.

If possible, please do not touch the antenna area of your phone.

Use qualified after sales service

Only a qualified technician can install or repair your cellular phone.



Accessories and batteries

Only use the authorized accessories and batteries and do not connect to incompatible manufacturers or products.



Waterproof

Your cellular phone is not waterproof. Please keep it away from water.

Backup

Remember to make a backup or keep a written record of all important information saved in your cellular phone.

Connect to other devices

Please read the user manual of the device to get more detailed security instructions before connecting to other devices and do not connect to an incompatible product.

SOS emergency calls

Make sure your cellular phone is switched on and in a service area. In idle mode, input the SOS number, then press the Dial Key. Advise where you are and do not hang up without permission.

7 Troubleshooting

Common issue	Reason	Troubleshooting
Bad connection	Using cellular phone in an area where the network connection is poor, such as around a tower or basement where radio wave cannot be sent effectively.	Try to avoid.
	Using cellular phone when network is busy, such as an on-off duty time, line busy.	Try to avoid.
	Related to the distance of the send basis of the network.	Ask your operator to provide a map of your service area.
Aftersound or cacophony	It is caused by network connection and it is a regional problem.	Hang up and redial the number.
	Network connection is not good in some areas.	
Idle time becomes short	Idle time is related to network settings.	If the cellular phone is in the area where the network connection is not good, please temporarily shut off your phone.

	Need to change battery.	Insert a new battery.
	When you cannot receive signals, your cellular phone will continue to send to find a basis. A lot of battery power is used, so as to limit idle time.	Please move to an area where signal is strong or temporarily turn off your phone.
Cannot switch on	Battery is drained.	Check battery volume or charge battery.
Wrong SIM card	SIM card is damaged.	Contact your operator.
	SIM card is not inserted properly.	Make sure SIM card is inserted properly.
	Dirt on metal side of SIM card.	Wipe metal point of SIM card with a clean cloth.
Cannot connect to network	SIM card is unusable.	Contact your operator.
	Out of GSM service area.	Request service area to operator.

	Feeble signal.	Please move to an area where signal is stronger and try again.
Cannot call	Activate call barring	Cancel call barring
	Activate fix dialing	Cancel fix dialing
Wrong PIN code	Entered the wrong PIN code three times.	Contact your operator.
Cannot charge	Battery or charger is damaged.	Change battery or charger.
	Charge in area where the temperature is lower than 0°C or higher than 40°C.	Change charging environment.
	Bad connection	Check the connection between the phone and the charger.
Cannot add contact	Contacts memory is full.	Delete some contacts.
Cannot set some functions	Operator does not support the function or you have not applied the function.	Contact your operator.

8 Safety Information and Notices

Using the Cellular Phone and Charger

Danger:

Only use the battery and charger approved by the manufacturer. Using other brands may cause battery leakage, overheating, explosion or even fire.

Caution:

Keep the phone away from dust, water and damp areas. Dust, water or other liquids may cause overheating, electrical leakage, and/or phone failure.

The phone, battery, charger and AC adapter are not waterproof. Keep them away from rain and liquid.

Warning:

Do not bump, shake or tamper with the phone or charger. This may cause battery leakage, overheating, explosion or even fire.

Do not place the battery, phone or charger near a microwave or high-voltage device. This may cause battery leakage, overheating, explosion or even fire; also prevent the phone and AC adapter from overheating, smoking or short circuiting.

Do not use the phone around volatile oil. This may cause fire, breakdown or damage.

To avoid any damage or breakdown, do not disassemble the phone, battery, charger or internal components by yourself.

Using the Cellular Phone

Warning:

Do not use the phone while you are driving. Pull over and stop your automobile to dial or listen to a phone call.

Usage of cellular phones in aircrafts or hospitals is prohibited. Switch the phone off to prevent interference with electronic medical devices. Follow any rules or regulations in such places.

Do not use the phone at a gas station, near fuel or near chemicals.

Do not use the phone near electronic medical devices such as hearing aids, pacemakers and auto-control devices such as fire detectors and automatic doors.

If you have to use your cellular phone near an electronic medical device such as a pacemaker, please contact your manufacturer or dealer for information about preventing interference.

Caution:

Electronic systems in automobiles such as anti-lock brakes, speed control, or fuel spraying systems, are usually not influenced by wireless devices. Manufacturers of these systems will tell you whether they are provided with good screening functions. If you suspect that an automobile failure is caused by a wireless wave, please contact your automobile dealer.

Avoid using your phone in crowded places.

Do not store your cellular phone near or with a credit card, disk or other magnetic materials. This may effect information stored on your phone.

Keep your phone away from pins. Pins can be absorbed by the phone's receiver magnet, which may cause harm.

Using the Battery

Danger:

Do not dispose of the battery into a fire. Doing so may cause battery explosion or even fire.

If you have difficulties installing the battery, do not force the installation. This may cause battery leakage, overheating, explosion or even fire.

Keep metal objects away so they do not come in contact with the battery or its connectors as it may cause the battery to short circuit, overheat or explode.

Do not weld the polarities of the battery directly together. This may cause battery leakage, overheating, explosion or even fire.

Battery liquid is severely harmful for your eyes. If battery liquid gets in your eyes, do not rub them. Instead, wash your eyes with water first and then go directly to a doctor for help.

Do not use or store your phone in high temperature areas. This may cause battery leakage, overheating, explosion or even fire.

Warning:

Replace the battery when the normal usage time begins to decrease or if you notice the battery is overheated or has changed shape or color.

If battery liquid leaks onto your skin or clothes, immediately wash the affected parts with water.

If the battery begins to leak or emits a strange odor, properly dispose of the battery according to local regulations. Do not throw it into a fire.

Caution:

Do not leave the product or its battery inside a vehicle or in places where the temperature may exceed 60°C (140°F), such as on a car dashboard, window sill, or behind a glass that is exposed to direct sunlight or strong ultraviolet light for extended periods of time. This may damage the product, overheat

the battery, or pose a risk to the vehicle.

Using the Charger

Danger:

Only use the charger that came with the phone. Using a different charger may cause the phone to breakdown or explode.

If the charger short circuits, a fire may occur.

Do not use a damaged, worn or broken charger. This may cause a fire.

Clean dust away from the power socket to avoid the possibility of a fire.

Do not store the charger near any liquids. If liquids spill onto the charger it may cause it to overheat or breakdown.

If liquid does spill onto the charger, immediately unplug the power cable to prevent overheating, fire or another type of breakdown.

Do not use the charger in places with high humidity like a bathroom. This may cause a fire or other breakdown.

Do not touch the charger, power cable or socket with wet hands. This may cause an electric shock.

Caution:

Keep the environment temperatures within the range of 0°C ~40°C while charging. Temperature below 0°C or higher than 40°C will cause insufficient charging, terminate charging or even cause the battery to explode.

Unplug the charger from its power source before cleaning it.

Do not place heavy objects on the power cord. This may cause electric shock or fire.

Hold the plug while unplugging the power cord. This will avoid any potential damage or even fire.

Requirements for Cellular Phone

Avoid using your cellular phone in extremely high or low temperatures. Use the phone in a temperature range between $-10\sim 55^{\circ}\text{C}$ and humidity of $35\%\sim 85\%$.

It is recommended that you do not use your cellular phone near a telephone, TV set, radio or other radio frequency sensitive devices.

Requirements for the Battery

When not in use, store the battery in a cool, well-ventilated place with sunshine.

If you will not be using the cellular phone for an extended period of time, charge the battery on a regular basis to avoid battery breakdown.

The phone battery wears out fast. If charging the battery does not improve its performance, it is time to replace the battery. Properly dispose of the battery according to local regulations. Do not throw it into a fire.

Requirements for the Charger and AC Adapter

Do not charge your phone under the following circumstances: sunshine, temperatures equal to or lower than 0°C , temperatures equal to or higher than 40°C , high humidity, dust, high vibration areas, or near a TV, a radio, etc.

Specific Absorption Rate (SAR) information

The SAR limit of USA (FCC) is 1.6 W/kg averaged over one gram of tissue. This models (FCC ID: T38PCD1017) has also been tested against this SAR limit. The highest SAR value reported under this standard during product certification for use at the ear is 1.396 W/kg and when properly worn on the body

is 1.190 W/kg. This device was tested for typical body-worn operations with the back of the handset kept 1.5cm from the body. To maintain compliance with FCC RF exposure requirements, use accessories that maintain a 1.5cm separation distance between the user's body and the back of the handset. The use of belt clips, holsters and similar accessories should not contain metallic components in its assembly. The use of accessories that do not satisfy these requirements may not comply with FCC RF exposure requirements, and should be avoided.

Any Changes or modifications not expressly approved by the party responsible for compliance could void the user's authority to operate the equipment.

This device complies with part 15 of the FCC Rules. Operation is subject to the following two conditions: (1) This device may not cause harmful interference, and (2) this device must accept any interference received, including interference that may cause undesired operation.

Cleaning and Maintenance

The cellular phone, the battery and the charger are not waterproof. Do not use them in places with high humidity like a bathroom and also avoid spilling any liquids on them.

Use a soft cloth to clean the cellular phone, the battery and the charger.

Do not use alcohol, diluted liquid or benzene to clean the cellular phone.

If dust gets in the sockets the phone can be damaged, short-circuit or even the lose the ability to be re-charged. Be sure to clean the socket regularly.

912 MONTH LIMITED WARRANTY

PERSONAL COMMUNICATIONS DEVICES (the Company) warrants to the original retail purchaser of this PCD handheld portable cellular telephone, that should this product or any part thereof during normal consumer usage and conditions, be proven defective in material or workmanship that results in product failure within the first twelve (12) month period from the date of purchase, such defect(s) will be repaired or replaced (with new or rebuilt parts) at the Company's option, without charge for parts or labor directly related to the defect(s).

The antenna, keypad, display, rechargeable battery and battery charger, if included, are similarly warranted for twelve (12) months from date of purchase.

This Warranty extends only to consumers who purchase the product in the United States or Canada and it is not transferable or assignable.

This Warranty does not apply to:

Product subjected to abnormal use or conditions, accident, mishandling, neglect, unauthorized alteration, misuse, improper installation or repair or improper storage;

Product whose mechanical serial number or electronic serial number has been removed, altered or defaced.

Damage from exposure to moisture, humidity, excessive temperatures or extreme environmental conditions;

Damage resulting from connection to, or use of any accessory or other product not approved or authorized by the Company;

Defects in appearance, cosmetic, decorative or structural items such as framing and non-operative parts; Product damaged from external causes such as fire, flooding, dirt, sand, weather conditions, battery leakage, blown fuse, theft or improper usage of any electrical source.

The Company disclaims liability for removal or reinstallation of the product, for geographic coverage, for inadequate signal reception by the antenna or for communications range or operation of the cellular system as a whole.

When sending your wireless device to PERSONAL COMMUNICATIONS DEVICES for repair or service, please note that any personal data or software stored on the device may be inadvertently erased or altered. Therefore, we strongly recommend you make a back up copy of all data and software contained on your device before submitting it for repair or service. This includes all contact lists, downloads (i.e. third-party software applications, ringtones, games and graphics) and any other data added to your device. In addition, if your wireless device utilizes a SIM or Multimedia card, please remove the card before submitting the device and store for later use when your device is returned, PERSONAL COMMUNICATIONS DEVICES is not responsible for and does not guarantee restoration of any third-party software, personal information or memory data contained in, stored on, or integrated with any wireless device, whether under warranty or not, returned to PERSONAL COMMUNICATIONS DEVICES for repair or service.

To obtain repairs or replacement within the terms of this Warranty, the product should be delivered with proof of Warranty coverage (e.g. dated bill of sale), the consumer's return address, daytime phone number and/or fax number and complete description of the problem, transportation prepaid, to the Company at the address shown below or to the place of purchase for repair or replacement processing.

In addition, for reference to an authorized Warranty station in your area, you may telephone in the United States (800) 229-1235, and in Canada (800) 465-9672 (in Ontario call 416-695-3060).

THE EXTENT OF THE COMPANY'S LIABILITY UNDER THIS WARRANTY IS LIMITED TO THE REPAIR OR REPLACEMENT PROVIDED ABOVE AND, IN NO EVENT, SHALL THE COMPANY'S LIABILITY EXCEED THE PURCHASE PRICE PAID BY PURCHASER FOR THE PRODUCT.

ANY IMPLIED WARRANTIES, INCLUDING ANY IMPLIED WARRANTY OF MERCHANTABILITY OR FITNESS FOR A PARTICULAR PURPOSE, SHALL BE LIMITED TO THE DURATION OF THIS WRITTEN WARRANTY. ANY ACTION FOR BREACH OF ANY WARRANTY MUST BE BROUGHT WITHIN A PERIOD OF 18 MONTHS FROM DATE OF ORIGINAL PURCHASE. IN NO CASE SHALL THE COMPANY BE LIABLE FOR AN SPECIAL CONSEQUENTIAL OR INCIDENTAL DAMAGES FOR BREACH OF THIS OR ANY OTHER WARRANTY, EXPRESS OR IMPLIED, WHATSOEVER. THE COMPANY SHALL NOT BE LIABLE FOR THE DELAY IN RENDERING SERVICE UNDER THIS WARRANTY OR LOSS OF USE DURING THE TIME THE PRODUCT IS BEING REPAIRED OR REPLACED.

No person or representative is authorized to assume for the Company any liability other than expressed herein in connection with the sale of this product.

Some states or provinces do not allow limitations on how long an implied warranty lasts or the exclusion or limitation of incidental or consequential damage so the above limitation or exclusions may not apply to

you. This Warranty gives you specific legal rights, and you may also have other rights, which vary from state to state or province to province.

IN USA: PERSONAL COMMUNICATIONS DEVICES

555 Wireless Blvd.

Hauppauge, NY 11788

(800) 229-1235

IN CANADA: PCD COMMUNICATIONS CANADA LTD.

5535 Eglinton Avenue West

Suite# 234

Toronto, ON M9C 5K5

(800) 465-9672