

# Adjustments

## 1 Program the Travel

### **WARNING**

Without a properly installed safety reversal system, persons (particularly small children) could be **SERIOUSLY INJURED** or **KILLED** by a closing garage door.

- Incorrect adjustment of garage door travel limits will interfere with proper operation of safety reversal system.
- After **ANY** adjustments are made, the safety reversal system **MUST** be tested. Door **MUST** reverse on contact with 1-1/2" (3.8 cm) high object (or 2x4 laid flat) on floor.

While programming, the UP and DOWN buttons can be used to move the door as needed.

1. Press and hold the Adjustment Button until the UP Button begins to flash and/or a beep is heard.
2. Press and hold the UP Button until the door is in the desired UP position.
3. Once the door is in the desired UP position press and release the Adjustment Button. The garage door opener lights will flash twice and the DOWN Button will begin to flash.
4. Press and hold the DOWN button until the door is in the desired DOWN position.
5. Once the door is in the desired DOWN position press and release the Adjustment Button. The garage door opener lights will flash twice and the UP Button will begin to flash.
6. Press and release the UP Button. When the door travels to the programmed UP position, the DOWN Button will begin to flash.
7. Press and release the DOWN Button. The door will travel to the programmed DOWN position. Programming is complete.

If the garage door opener lights are flashing 5 times during the steps for Program the Travel, the programming has timed out. If the garage door opener lights are flashing 10 times during the steps for Program the Travel, the safety reversing sensors are misaligned or obstructed (refer to page 24). When the sensors are aligned and unobstructed, cycle the door through a complete up and down cycle using the remote control or the UP and DOWN buttons. Programming is complete. If you are unable to operate the door up and down, repeat the steps for Programming the Travel.

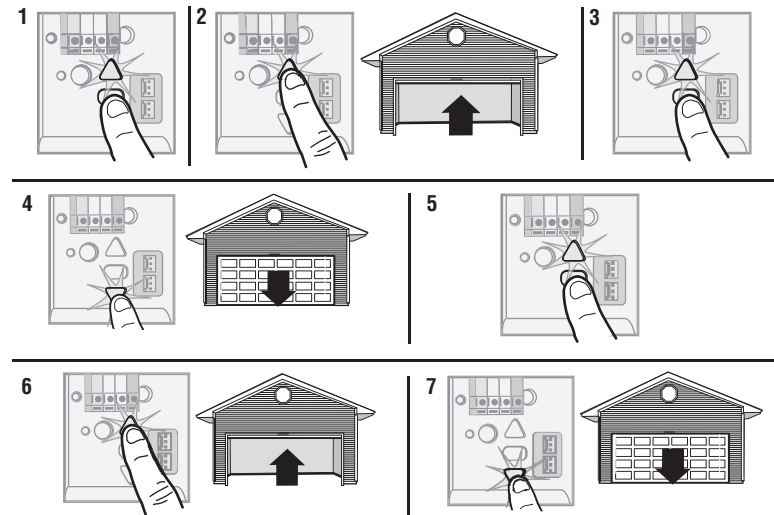
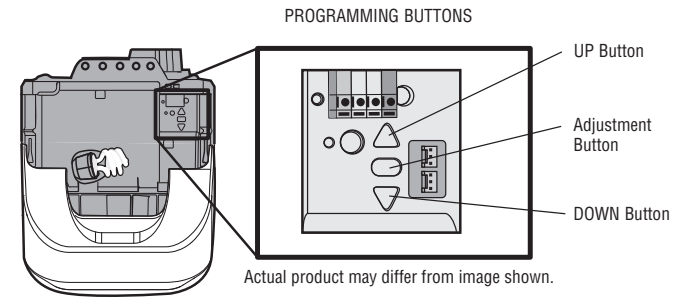

# Adjustments

## 2 Test the Safety Reversal System

### **WARNING**

Without a properly installed safety reversal system, persons (particularly small children) could be **SERIOUSLY INJURED** or **KILLED** by a closing garage door.

- Safety reversal system **MUST** be tested every month.
- After **ANY** adjustments are made, the safety reversal system **MUST** be tested. Door **MUST** reverse on contact with 1-1/2" (3.8 cm) high object (or 2x4 laid flat) on the floor.

1. With the door fully open, place a 1-1/2 inch (3.8 cm) board (or a 2x4 laid flat) on the floor, centered under the garage door.
2. Press the remote control push button to close the door. The door **MUST** reverse when it makes contact with the board.

If the door stops and does not reverse on the obstruction, increase the down travel (refer to Adjustment Step 1). Repeat the test. When the door reverses upon contact with the 1-1/2 inch board, remove the board and open/close the door 3 or 4 times to test the adjustment. If the garage door opener continues to fail the safety reversal test, call a trained door systems technician.

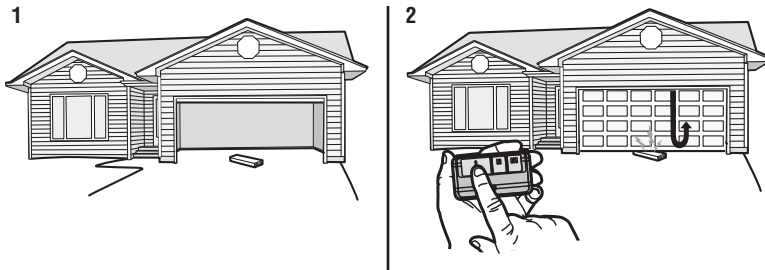

## 3 Test the Protector System®

### **WARNING**

Without a properly installed safety reversing sensor, persons (particularly small children) could be **SERIOUSLY INJURED** or **KILLED** by a closing garage door.

1. Open the door. Place the garage door opener carton in the path of the door.
2. Press the remote control push button to close the door. The door will not move more than an inch (2.5 cm), and the garage door opener lights will flash 10 times.

The garage door opener will not close from a remote control if the LED in either safety reversing sensor is off (alerting you to the fact that the sensor is misaligned or obstructed). If the garage door opener closes the door when the safety reversing sensor is obstructed (and the sensors are no more than 6 inches [15 cm] above the floor), call for a trained door systems technician.

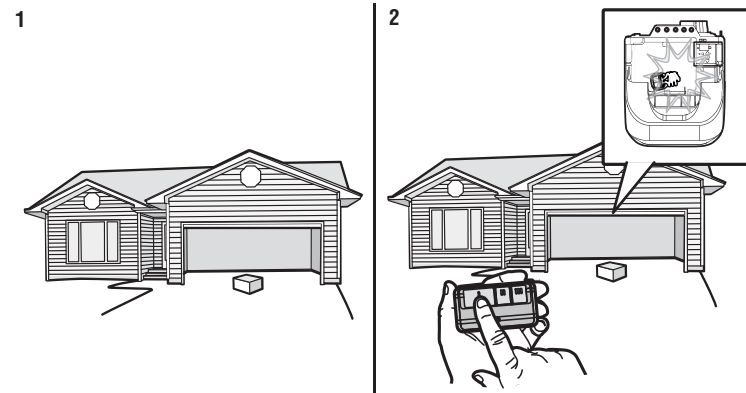

### IMPORTANT SAFETY INSTRUCTIONS

#### **WARNING**

#### **To reduce the risk of SEVERE INJURY or DEATH:**

1. READ AND FOLLOW ALL WARNINGS AND INSTRUCTIONS.
2. ALWAYS keep remote controls out of reach of children. NEVER permit children to operate or play with garage door control push buttons or remote controls.
3. ONLY activate garage door when it can be seen clearly, it is properly adjusted, and there are no obstructions to door travel.
4. ALWAYS keep garage door in sight and away from people and objects until completely closed. NO ONE SHOULD CROSS THE PATH OF THE MOVING DOOR.
5. NO ONE SHOULD GO UNDER A STOPPED, PARTIALLY OPENED DOOR.
6. If possible, use emergency release handle to disengage trolley ONLY when garage door is CLOSED. Use caution when using this release with the door open. Weak or broken springs or unbalanced door could result in an open door falling rapidly and/or unexpectedly and increasing the risk of SEVERE INJURY or DEATH.
7. NEVER use emergency release handle unless garage doorway is clear of persons and obstructions.
8. NEVER use handle to pull garage door open or closed. If rope knot becomes untied, you could fall.
9. After ANY adjustments are made, the safety reversal system MUST be tested.
10. Safety reversal system MUST be tested every month. Garage door MUST reverse on contact with 1-1/2" (3.8 cm) high object (or a 2x4 laid flat) on the floor. Failure to adjust the garage door opener properly increases the risk of SEVERE INJURY or DEATH.
11. ALWAYS KEEP GARAGE DOOR PROPERLY BALANCED (see page 4). An improperly balanced door may NOT reverse when required and could result in SEVERE INJURY or DEATH.
12. ALL repairs to cables, spring assemblies and other hardware, ALL of which are under EXTREME tension, MUST be made by a trained door systems technician.
13. To avoid SERIOUS PERSONAL INJURY or DEATH from electrocution, disconnect ALL electric power BEFORE performing ANY service or maintenance.
14. This operator system is equipped with an unattended operation feature. The door could move unexpectedly. NO ONE SHOULD CROSS THE PATH OF THE MOVING DOOR.
15. DO NOT install on a one-piece door if using devices or features providing unattended close. Unattended devices and features are to be used ONLY with sectional doors.

#### **16. SAVE THESE INSTRUCTIONS.**

# Operation

## Features

Your garage door opener is equipped with features to provide you with greater control over your garage door operation.

### Alert2Close

The Alert2Close feature provides a visual and an audible alert that an unattended door is closing.

### TIMER-TO-CLOSE (TTC)

The TTC feature automatically closes the door after a specified time period that can be adjusted using a TTC enabled door control (Models 881LMW or 880LMW). Prior to and during the door closing the garage door opener lights will flash and the garage door opener will beep.

### MyQ®

MyQ allows you to control your garage door opener from your mobile device or computer from anywhere. MyQ technology uses a 900Mhz signal to provide two way communication between the garage door opener and MyQ enabled accessories. The garage door opener has an internal gateway that allows the garage door opener to communicate directly with a home Wi-Fi® network and access your MyQ account.

### THE PROTECTOR SYSTEM® (SAFETY REVERSING SENSORS)

When properly connected and aligned, the safety reversing sensors will detect an obstruction in the path of the infrared beam. If an obstruction breaks the infrared beam while the door is closing, the door will stop and reverse to full open position, and the opener lights will flash 10 times. If the door is fully open, and the safety reversing sensors are not installed, or are misaligned, the door will not close from a remote control. However, you can close the door if you hold the button on the door control or keyless entry until the door is fully closed. The safety reversing sensors do not affect the opening cycle. For more information see page 19.

### ENERGY CONSERVATION

For energy efficiency the garage door opener will enter sleep mode when the door is fully closed. The sleep mode shuts the garage door opener down until activated. The sleep mode is sequenced with the garage door opener light bulb; as the light bulb turns off the sensor LEDs will turn off and whenever the garage door opener lights turn on the sensor LEDs will light. The garage door opener will not go into the sleep mode until the garage door opener has completed 5 cycles upon power up.

## LIGHTS

The garage door opener light bulbs will turn on when the opener is initially plugged in; power is restored after interruption, or when the garage door opener is activated. The lights will turn off automatically after 4-1/2 minutes. An incandescent A19 light bulb (100 watt maximum) or for maximum energy efficiency a 26W (100W equivalent) compact fluorescent light (CFL) bulb may be used.

### Light Feature

The garage door opener is equipped with an added feature; the lights will turn on when someone enters through the open garage door and the safety reversing sensor infrared beam is broken. For added control over the light bulbs on your garage door opener, see page 32.

## USING YOUR GARAGE DOOR OPENER

The garage door opener can be activated through a wall-mounted door control, remote control, wireless keyless entry or MyQ® accessory. When the door is closed and the garage door opener is activated the door will open. If the door senses an obstruction or is interrupted while opening the door will stop. When the door is in any position other than closed and the garage door opener is activated the door will close. If the garage door opener senses an obstruction while closing, the door will reverse. If the obstruction interrupts the sensor beam the garage door opener lights will blink 10 times. However, you can close the door if you hold the button on the door control or keyless entry until the door is fully closed. The safety reversing sensors do not affect the opening cycle. The safety reversing sensor must be connected and aligned correctly before the garage door opener will move in the down direction.

## AUTOMATIC GARAGE DOOR LOCK\*



Garage door opener models featuring the Security Shield are compatible with the LiftMaster Automatic Garage Door Lock (Model 841LM). See Accessories, page 38.

\* If applicable.

# Operation

## Connect With Your Smartphone

The Wi-Fi® Garage Door Opener is compatible with up to 16 MyQ enabled accessories. Up to 10 devices can be paired to the Wi-Fi garage door opener's internal gateway. These devices can be controlled with the MyQ app. These devices include any combination of MyQ garage door openers, Wi-Fi garage door openers, MyQ light controls, MyQ gate operators or MyQ commercial door operators. A LiftMaster Internet Gateway (828LM) can be added if you need to control more than 10 devices using the MyQ app. Up to 6 devices can be paired to garage door opener itself (controlled by garage door opener through 900MHz). These devices include any combination of MyQ light controls or a garage door and gate monitor.

### You will need:

- Wi-Fi enabled smartphone, tablet or laptop
- Broadband Internet Connection
- Wi-Fi signal in the garage (**2.4 Ghz, 802.11b/g/n required**), see page 4
- Password for your home network (router's main account, not guest network)
- MyQ® serial number located on the garage door opener

## Connect Your Garage Door Opener to Your Home Wi-Fi Network

1. Use the Smart Control Panel®, go to Menu > Program > Wi-Fi Setup **OR** press and release the yellow LEARN button on the garage door opener 3 times. The garage door opener will beep once. You have 20 minutes to complete the connection process.
2. On your mobile device, go to Settings > Wi-Fi and select the network with the "MyQ-" prefix.
3. Launch the web browser on your smartphone or tablet. Enter **setup.myqdevice.com** into the browser address bar. Follow the on screen prompts to connect the garage door opener to your Wi-Fi network. The MyQ serial number will display on screen. Write the serial number in the space below.

4. Download the MyQ app from the App Store® or Google Play™ store. Sign up for your MyQ account and add the MyQ serial number to your account.

To add a second Wi-Fi garage door opener, repeat steps 1-3. Add the second MyQ serial number to your account in the MyQ app.

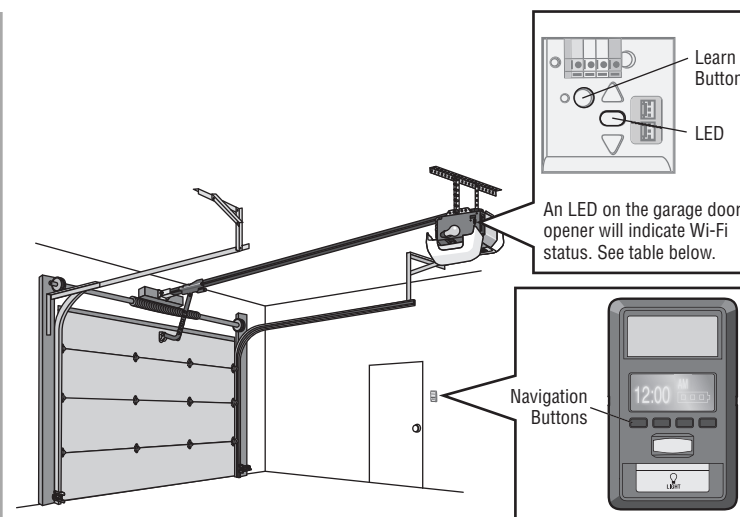

LED	Definition
Blue	<b>Off</b> - Wi-Fi is not turned on. <b>Blinking</b> - Garage door opener is in Wi-Fi learn mode. <b>Solid</b> - Mobile device connected to the garage door opener.
Blue and Green	<b>Blinking</b> - Attempting to connect to router.
Green	<b>Blinking</b> - Attempting to connect to the Internet server. <b>Solid</b> - Wi-Fi has been set up and garage door opener is connected to the internet.

### NOTES:

To erase the Wi-Fi settings, see page 33.

**If you need help adding devices to your MyQ account, or to learn more go to [WiFiHelp.LiftMaster.com](http://WiFiHelp.LiftMaster.com).**

# Operation

## Using the Door Control

### SYNCHRONIZE THE DOOR CONTROL

To synchronize the door control to the garage door opener, press the push bar until the garage door opener activates (it may take up to 3 presses). Test the door control by pressing the push bar, each press of the push bar will activate the garage door opener.

Up to 2 Smart Control Panels® or 4 of any other Security+ 2.0® door controls can be connected to the garage door opener.

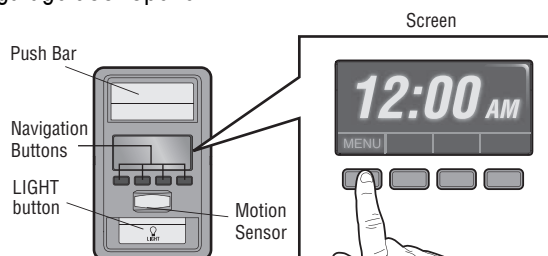

### PUSH BAR

Press the push bar to open or close the door.

### NAVIGATION BUTTONS

Use the navigation buttons to make selections and program features.

### LIGHT BUTTON

Press the LIGHT button to turn the garage door opener lights on or off. When the lights are turned on they will stay on until the LIGHT button is pressed again, or until the garage door opener is activated. Once the garage door opener is activated the lights will turn off after the specified period of time (the factory setting is 4-1/2 minutes). The LIGHT button will not control the lights when the door is in motion.

### SCREEN

The screen will display the time and temperature until the menu button is pressed, and then it will display the menu options. If there is a problem with the garage door opener the screen will display the Diagnostic Code. Refer to the Troubleshooting section.

The following features are accessible through the screen using the navigation buttons:

### LEARN A DEVICE

Any compatible remote controls, wireless keyless entry, Wi-Fi garage door openers, or MyQ® accessories can be programmed to the garage door opener by accessing the menu and using the navigation buttons.

### LOCK

The LOCK feature is designed to prevent activation of the garage door opener from remote controls while still allowing activation from the door control and keyless entry. This feature is useful for added peace of mind when the home is empty (i.e. vacation).

### TIMER-TO-CLOSE (TTC)

DO NOT enable TTC if operating a one-piece door. TTC is to be used ONLY with sectional doors. Factory default is set to off. TTC can be set to automatically close your garage door from the fully open position after a specified period of time (1, 5, 10 minute intervals or a custom setting up to 99 minutes). The garage door opener will *Beep* and the lights will *Flash* before closing the door. The screen on the door control can display the status of the TTC. TTC WILL NOT work if the garage door opener is operating by battery power or if the safety reversing sensors are misaligned. This feature is NOT intended to be the primary method of closing the door. **A keyless entry should be installed in the event of an accidental lock out when using this feature.**

Before enabling the TTC for the first time, or if you experience a power outage, cycle the garage door opener open and closed to allow the TTC to set.

### AUTOMATIC LIGHT

#### Motion Sensor

Factory default is set to on. This feature automatically turns on the garage door opener lights when motion is sensed. The lights will come on for the set period of time, then shut off. If using the garage door opener light as a work light disable the motion sensor, otherwise the light will turn off automatically if you are beyond the range of the sensor.

#### Light Feature

The lights will turn on when someone enters through the open garage door and the safety reversing sensor infrared beam is broken.

### MAINTENANCE ALERT (MAS)

This feature assists the homeowner in ensuring the garage door opener system stays in good working condition. When the garage door opener needs to be serviced (approximately 4500 garage door opener cycles) the command (yellow) and service (red) LEDs will begin to alternately flash back and forth. The factory setting for the MAS feature is off and can be activated at time of installation. Contact your installing dealer for service.

# Operation

## Using the Door Control

### Setup

The features on the door control can be programmed through a series of menus on the screen and the navigation buttons. Refer to the descriptions below.

### SCREEN

The main screen displays the time, temperature, and current battery charge (if applicable)

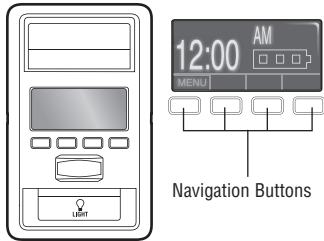

### FEATURES

Press the navigation button below "MENU" to view the Features menu.

The screenshot shows the Features menu with the following options: CLOCK SETUP, TTC OFF, LOCK DISABLED, PROGRAM, and EXIT. Below the menu are four navigation buttons: a left arrow, a right arrow, a left arrow, and a right arrow.

- Set the time, choose 12 or 24 hour clock and show/hide clock.
- For sectional doors ONLY. Set the Timer-to-Close feature off/on and set the time interval before door closes. **NOTE: DO NOT enable TTC if operating a one-piece door. TTC is to be used ONLY with sectional doors.**
- Enable/disable lock.
- Set up Wi-Fi\*, add remote controls, MyQ® devices, an extra remote button to control your garage door opener lights, or a keyless entry.
- \* The garage door opener must run through a complete cycle before it will activate Wi-Fi® programming. For help related to Wi-Fi, visit [WiFiHelp.LiftMaster.com](http://WiFiHelp.LiftMaster.com).

### SETTINGS

Press the navigation button below the down arrow till you see TEMPERATURE to view the Settings menu.

The screenshot shows the Settings menu with the following options: TEMPERATURE, LANGUAGE ENGLISH, LIGHT SETTINGS, CONTRAST ADJUST 50, and EXIT. Below the menu are four navigation buttons: a left arrow, a right arrow, a left arrow, and a right arrow.

- Display the temperature in Fahrenheit or Celsius and show/hide the temperature.
- Select a language.
- Set duration for garage door opener light to stay on after operation, selectable range of 1-1/2 to 4-1/2 minutes. Turn the Motion sensor off/on, and turn the entry light feature off/on.
- Adjust the contrast of the screen.

### SERVICE

Press and hold the LIGHT button, then press the second navigation button to view the Service menu.

The screenshot shows the Service menu with the following options: SOFTWARE REVISION, CYCLE COUNT, TRANSMITTERS, DISPLAY ERROR, and EXIT. Below the menu are four navigation buttons: a left arrow, a right arrow, a left arrow, and a right arrow.

- Displays software version information.
- Turn the Maintenance Alert (MAS) on/off.
- Displays the number of remote controls, MyQ® devices, door controls and keyless entries currently programmed to operate the garage door opener.
- Displays any errors that have occurred.

To program a remote control or keyless entry to the garage door opener using the door control, see page 33.

# Operation

## Remote Control

Your remote control has been programmed at the factory to operate with your garage door opener.

Up to 40 Security+ 2.0® remote controls can be programmed to the garage door opener. Older LiftMaster remote controls are NOT compatible, see page 38 for compatible accessories. To program additional accessories refer to the instructions provided with the accessory or visit LiftMaster.com. If your vehicle is equipped with a Homelink®, you may require an external adapter depending on the make, model, and year of your vehicle. Visit [www.homelink.com](http://www.homelink.com) for additional information.

### TO ADD, REPROGRAM, OR CHANGE A REMOTE CONTROL/KEYLESS ENTRY PIN USING THE DOOR CONTROL

1. Press the navigation button below "MENU" to view the Features menu.
2. Use the navigation buttons to scroll to "PROGRAM".
3. Select "REMOTE" or "KEYPAD" to program from the program menu.
4. **Remote Control:** Press the button on the remote control that you wish to operate your garage door.

**Keyless Entry:** Enter a 4-digit personal identification number (PIN) of your choice on the keyless entry keypad. Then press the ENTER button.

The garage door opener lights will flash (or two clicks will be heard) when the code has been programmed. Repeat the steps above for programming additional remote controls or keyless entry devices. If programming is unsuccessful, program the remote using the learn button.

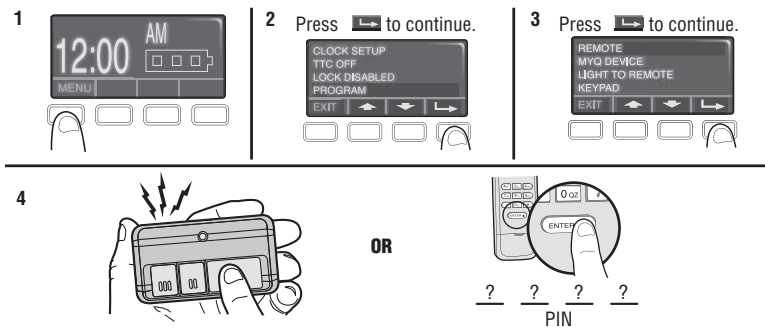

### TO ADD, REPROGRAM, OR CHANGE A REMOTE CONTROL USING THE LEARN BUTTON

1. Press and release the LEARN Button on the garage door opener.
2. Press and hold the button on the remote control that you wish to use. Release the button when the garage door opener lights blink or two clicks are heard.

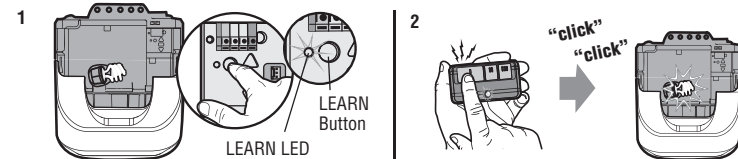

### To Erase the Memory

#### ERASE ALL REMOTE CONTROLS AND KEYLESS ENTRIES

1. Press and hold the LEARN button on garage door opener until the learn LED goes out (approximately 6 seconds). All remote control and keyless entry codes are now erased. Reprogram any accessory you wish to use.

#### ERASE ALL DEVICES (Including MyQ® enabled accessories)

1. Press and hold the LEARN button on garage door opener until the learn LED goes out (approximately 6 seconds).
2. Immediately press and hold the LEARN button again until the learn LED goes out. All codes are now erased. Reprogram any accessory you wish to use.

#### ERASE THE Wi-Fi NETWORK FROM THE GARAGE DOOR OPENER

1. Press and hold the black adjustment button on the garage door opener until 3 beeps are heard (Approximately 6 seconds).

#### ERASE A MyQ® ACCOUNT

Go to [myLiftMaster.com](http://myLiftMaster.com) to delete your MyQ account.

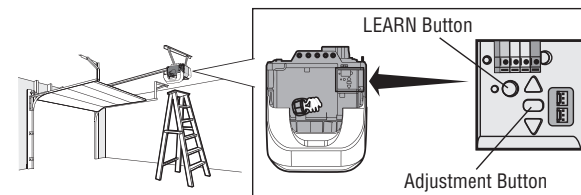



# Operation

## To Open the Door Manually

### **WARNING**

To prevent possible **SERIOUS INJURY** or **DEATH** from a falling garage door:

- If possible, use emergency release handle to disengage trolley **ONLY** when garage door is **CLOSED**. Weak or broken springs or unbalanced door could result in an open door falling rapidly and/or unexpectedly.
- **NEVER** use emergency release handle unless garage doorway is clear of persons and obstructions.
- **NEVER** use handle to pull door open or closed. If rope knot becomes untied, you could fall.

**NOTE:** *Disengage any door locks before proceeding.*

### **DISCONNECT THE TROLLEY**

1. The door should be fully closed if possible.
2. Pull down on the emergency release handle.

### **RECONNECT THE TROLLEY**

The lockout feature prevents the trolley from reconnecting automatically.

1. Pull the emergency release handle down and back (toward the opener). The door can then be raised and lowered manually as often as necessary.
2. To disengage the lockout feature, pull the handle straight down. The trolley will reconnect on the next UP or DOWN operation, either manually or by using the door control or remote control.

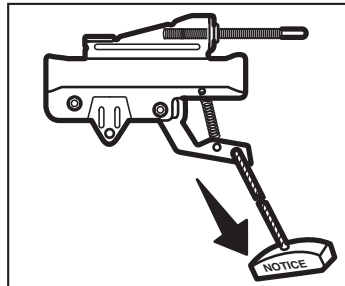
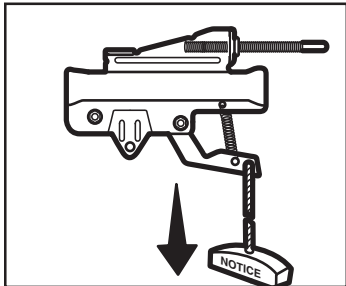

## **TO MANUALLY DISENGAGE AUTOMATIC GARAGE DOOR LOCK (MODEL 841LM)\***

1. The door should be fully closed if possible.
2. Disengage the automatic garage door lock by sliding the manual release to the open position.
3. Pull the emergency release handle down and back (toward the garage door opener). The garage door can then be raised and lowered manually as necessary.
4. To reconnect the trolley, pull the emergency release handle straight down. The trolley will reconnect on the next UP or DOWN operation.

**NOTE:** *The automatic garage door lock will re-engage when garage door opener operation resumes.*

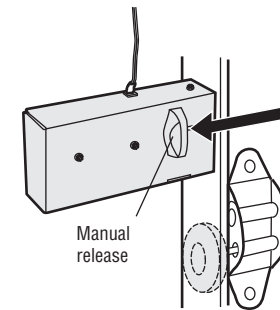

\* If applicable.

# Maintenance

## Maintenance Schedule

### EVERY MONTH

- Manually operate door. If it is unbalanced or binding, call a trained door systems technician.
- Check to be sure door opens and closes fully. Adjust if necessary, see page 26.
- Test the safety reversal system. Adjust if necessary, see page 27.

### EVERY YEAR

- Oil door rollers, bearings and hinges. The garage door opener does not require additional lubrication. Do not grease the door tracks.

### EVERY TWO TO THREE YEARS

- Use a rag to wipe away the existing grease from the garage door opener rail. Reapply a small layer of white lithium grease to the top and underside of the rail surface where the trolley slides.

## The Remote Control Battery

### WARNING

To prevent possible SERIOUS INJURY or DEATH:

- NEVER allow small children near batteries.
- If battery is swallowed, immediately notify doctor.

To reduce risk of fire, explosion or chemical burn:

- Replace ONLY with 3V CR2032 coin batteries.
- DO NOT recharge, disassemble, heat above 212°F (100°C) or incinerate.

To replace the battery, pry open the case in the middle, then at each side with the visor clip. Insert replacement battery positive side up (+). Replace the batteries with only 3V CR2032 coin cell batteries. Dispose of old batteries properly.

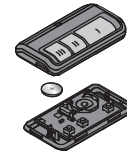

NOTICE: To comply with FCC and/or Industry Canada (IC) rules, adjustment or modifications of this transceiver are prohibited. THERE ARE NO USER SERVICEABLE PARTS.  
This device complies with Part 15 of the FCC rules and IC RSS-210. Operation is subject to the following two conditions: (1) this device may not cause harmful interference, and (2) this device must accept any interference received, including interference that may cause undesired operation.  
This Class B digital apparatus complies with Canadian ICES-003.

AVIS: Les règles de la FCC et/ou d'Industrie Canada (IC) interdisent tout ajustement ou toute modification de ce récepteur. IL N'EXISTE AUCUNE PIÈCE SUSCEPTIBLE D'ÊTRE ENTRETENUE PAR L'UTILISATEUR.  
Cet appareil est conforme aux dispositions de la partie 15 du règlement de la FCC et de l'norme IC RSS-210. Son utilisation est assujettie aux deux conditions suivantes: (1) ce dispositif ne peut causer des interférences nuisibles, et (2) ce dispositif doit accepter toute interférence reçue, y compris une interférence pouvant causer un fonctionnement non souhaité.  
Cet appareil numérique de la classe B est conforme à la norme NMB-003 du Canada.

This Device must be installed to ensure a minimum 20cm distance is maintained between users/bystanders and device.

# Troubleshooting

## Diagnostic Chart

Your garage door opener is programmed with self-diagnostic capabilities. The UP and DOWN arrows on the garage door opener flash the diagnostic codes.

DIAGNOSTIC CODE		SYMPTOM	SOLUTION
Up Arrow Flash(es)	Down Arrow Flash(es)		
1	1	The garage door opener will not close and the light bulbs flash.	Safety reversing sensors are not installed, connected, or wires may be cut. Inspect sensor wires for a disconnected or cut wire.
1	2	The garage door opener will not close and the light bulbs flash.	There is a short or reversed wire for the safety reversing sensors. Inspect safety sensor wire at all staple and connection points, replace wire or correct as needed.
1	3	The door control will not function.	The wires for the door control are shorted or the door control is faulty. Inspect door control wires at all staple and connection points, replace wire or correct as needed.
1	4	The garage door opener will not close and the light bulbs flash.	Safety reversing sensors are misaligned or were momentarily obstructed. Realign both sensors to ensure both LEDs are steady and not flickering. Make sure nothing is hanging or mounted on the door that would interrupt the sensor's path while closing.
1	5	Door moves 6-8" (15-20 cm) stops or reverses.	Manually open and close the door. Check for binding or obstructions, such as a broken spring or door lock, correct as needed. Check wiring connections at travel module and at the logic board. Replace travel module if necessary.
		No movement, only a single click.	Manually open and close the door. Check for binding or obstructions, such as a broken spring or door lock, correct as needed. Replace logic board if necessary.
		Opener hums for 1-2 seconds no movement.	Manually open and close the door. Check for binding or obstructions, such as a broken spring or door lock, correct as needed. Replace motor if necessary.
1	6	Door coasts after it has come to a complete stop.	Program travel to coasting position or have door balanced by a trained door systems technician.
2	1-5	No movement, or sound.	Replace logic board.
3	2	Unable to set the travel or retain position.	Check travel module for proper assembly, replace if necessary.

# Troubleshooting

DIAGNOSTIC CODE		SYMPTOM	SOLUTION
Up Arrow Flash(es)	Down Arrow Flash(es)		
4	1-4	Door is moving stops or reverses.	Manually open and close the door. Check for binding or obstructions, such as a broken spring or door lock, correct as needed. If the door is binding or sticking contact a trained door systems technician. If door is not binding or sticking attempt to reprogram travel (refer to page 26).
4	5	Opener runs approximately 6-8" (15-20 cm), stops and reverses.	Communication error to travel module. Check travel module connections, replace travel module if necessary.
4	6	The garage door opener will not close and the light bulbs flash.	Safety reversing sensors are misaligned or were momentarily obstructed. Realign both sensors to ensure both LEDs are steady and not flickering. Make sure nothing is hanging or mounted on the door that would interrupt the sensor's path while closing.

### The garage door opener will NOT enter Wi-Fi LEARN mode:

- After the initial installation of the garage door opener, the garage door opener must complete a full cycle (open and closed) before the Wi-Fi LEARN mode can be activated.
- If there has been a recent power outage, the garage door opener must complete a full cycle before the Wi-Fi LEARN mode can be activated.

See page 30 to activate Wi-Fi LEARN mode.

### Cannot connect garage door opener to home Wi-Fi network:

- Ensure the MyQ Serial number was entered correctly and try again. The MyQ characters are between A-F and 0-9 only.
- Weak Wi-Fi signal in the garage. Ensure the Wi-Fi signal is reaching the garage, see page 4 or visit [WiFiHelp.LiftMaster.com](http://WiFiHelp.LiftMaster.com) for more information.

### My door will not close and the light bulbs blink on my motor unit:

The safety reversing sensor must be connected and aligned correctly before the garage door opener will move in the down direction.

- Verify the safety reversing sensors are properly installed, aligned and free of any obstructions.

### My garage door opener light(s) will not turn off when the door is open:

The garage door opener is equipped with a feature that turns the light on when the safety reversing sensors have been obstructed or when the motion sensor on the door control detects movement in the garage. This feature can be disabled using the door control, see page 32.

### My neighbor's remote control opens my garage door:

Erase the memory from your garage door opener and reprogram the remote control(s).

### My vehicle's Homelink® is not programming to my garage door opener:

Depending on the make, model, and year of your vehicle an external adapter may be required. Visit [www.homelink.com](http://www.homelink.com) for additional information.

**To troubleshoot the optional automatic garage door lock model 841LM, see the instructions provided with it.**

# Accessories

**823LM Remote Light Switch:**



Automatically control your lights using your garage door opener, a Security+ 2.0® remote control or a LiftMaster® Internet Gateway. Simply replaces your current wired wall switch.

**829LM Garage and Gate Monitor:**



Monitor open/closed status for up to 4 MyQ® compatible garage door openers or gate operators and close them from anywhere in the home.

**893MAX 3-Button MAX Remote Control:**



Compatible with LiftMaster® garage door openers manufactured since 1993. Includes visor clip.

**880LMW Smart Control Panel®:**



Displays temperature, time and system diagnostics; includes a push bar to open and close the door and a lock feature for extra security. Security+ 2.0® and Wi-Fi® compatible.

**825LM Remote Light Control:**



Automatically control your lights using your garage door opener, a Security+ 2.0® remote control or a LiftMaster® Internet Gateway. Plugs into any interior outlet.

**877MAX MAX Wireless Keyless Entry:**



For use outside of the home to enable access to the garage using a 4-digit PIN. Works with ALL LiftMaster® openers from 1993- present.

**374UT Mini Universal Remote Control:**



The Mini Universal Remote Control can be programmed to activate up to two products, such as a garage door opener, MyQ® light controls, gate operator, or commercial door operator.

**881LMW Motion Detecting Control Panel with Timer-to-Close Control:**



Multi-function door control with motion sensor that automatically turns opener lights on when it detects a person entering the garage. Security+ 2.0® and Wi-Fi® compatible.

**975LM Laser Garage Parking Assist:**



Laser enables homeowners to precisely park vehicles in the garage.

**841LM Automatic Garage Door Lock:**



Compatible with Security Shield garage door openers. Provides added security by automatically locking garage door travel at the garage door track.

**892LT/894LT 2 & 4 Button Learning Remote Controls:**

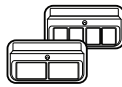

Compatible with LiftMaster® garage door openers manufactured since 1997. Also compatible with Encrypted DIP for gate applications.

**886LMW Motion Detecting Control Panel:**



Multi-function door control with motion sensor that automatically turns opener lights on when it detects a person entering the garage. Security+ 2.0® and Wi-Fi® compatible.

# Warranty

## LIFTMASTER® LIMITED WARRANTY

LiftMaster® (“Seller”) warrants to the first retail purchaser of this product, for the residence in which this product is originally installed, that it is free from defects in materials and/or workmanship for a specific period of time as defined below (the “Warranty Period”). The warranty period commences from the date of purchase.

WARRANTY PERIOD		
Parts	Motor	Accessories
5 years	Lifetime	1 year

The proper operation of this product is dependent on your compliance with the instructions regarding installation, operation, and maintenance and testing. Failure to comply strictly with those instructions will void this limited warranty in its entirety.

If, during the limited warranty period, this product appears to contain a defect covered by this limited warranty, call 1-800-528-9131, toll free, before dismantling this product. You will be advised of disassembly and shipping instructions when you call. Then send the product or component, pre-paid and insured, as directed to our service center for warranty repair. Please include a brief description of the problem and a dated proof-of-purchase receipt with any product returned for warranty repair. Products returned to Seller for warranty repair, which upon receipt by Seller are confirmed to be defective and covered by this limited warranty, will be repaired or replaced (at Seller’s sole option) at no cost to you and returned pre-paid. Defective parts will be repaired or replaced with new or factory-rebuilt parts at Seller’s sole option. [You are responsible for any costs incurred in removing and/or reinstalling the product or any component].

**ALL IMPLIED WARRANTIES FOR THE PRODUCT, INCLUDING BUT NOT LIMITED TO ANY IMPLIED WARRANTIES OF MERCHANTABILITY AND FITNESS FOR A PARTICULAR PURPOSE, ARE LIMITED IN DURATION TO THE APPLICABLE LIMITED WARRANTY PERIOD SET FORTH ABOVE FOR THE RELATED COMPONENT(S), AND NO IMPLIED WARRANTIES WILL EXIST OR APPLY AFTER SUCH PERIOD. Some States and Provinces do not allow limitations on how long an implied warranty lasts, so the above limitation may not apply to you. THIS LIMITED WARRANTY DOES NOT COVER NON-DEFECT DAMAGE, DAMAGE CAUSED BY IMPROPER INSTALLATION, OPERATION OR CARE (INCLUDING, BUT NOT LIMITED TO ABUSE, MISUSE, FAILURE TO PROVIDE REASONABLE AND NECESSARY MAINTENANCE, UNAUTHORIZED REPAIRS OR ANY ALTERATIONS TO THIS PRODUCT), LABOR CHARGES FOR REINSTALLING A REPAIRED OR REPLACED UNIT, REPLACEMENT OF CONSUMABLE ITEMS (E.G., BATTERIES IN REMOTE CONTROL TRANSMITTERS AND LIGHT BULBS), OR UNITS INSTALLED FOR NON-RESIDENTIAL USE. THIS LIMITED WARRANTY DOES NOT COVER ANY PROBLEMS WITH, OR RELATING TO, THE GARAGE DOOR OR GARAGE DOOR HARDWARE, INCLUDING BUT NOT LIMITED TO THE DOOR SPRINGS, DOOR ROLLERS, DOOR ALIGNMENT OR HINGES. THIS LIMITED WARRANTY ALSO DOES NOT COVER ANY PROBLEMS CAUSED BY INTERFERENCE. UNDER NO CIRCUMSTANCES SHALL SELLER BE LIABLE FOR CONSEQUENTIAL, INCIDENTAL OR SPECIAL DAMAGES ARISING IN CONNECTION WITH USE, OR INABILITY TO USE, THIS PRODUCT. IN NO EVENT SHALL SELLER’S LIABILITY FOR BREACH OF WARRANTY, BREACH OF CONTRACT, NEGLIGENCE OR STRICT LIABILITY EXCEED THE COST OF THE PRODUCT COVERED HEREBY. NO PERSON IS AUTHORIZED TO ASSUME FOR US ANY OTHER LIABILITY IN CONNECTION WITH THE SALE OF THIS PRODUCT.**

Some states and provinces do not allow the exclusion or limitation of consequential, incidental or special damages, so the above limitation or exclusion may not apply to you. This limited warranty gives you specific legal rights, and you may also have other rights, which vary from state to state and province to province.

# Repair Parts

## Rail Assembly Parts

Description	Part Number
1 Chain - for 7 foot door	41D3484
Chain - for 8 foot door	41D3483
Chain - for 10 foot door	41D3485
2 Chain Pulley Bracket	41A2780
3 Master Link	4A1008
4 One-Piece Rail 7 feet (2.1 m)	3707CH
One-Piece Rail 8 feet (2.4 m)	3708CH
One-Piece Rail 10 feet (3 m)	3710CH
5 Trolley Assembly	41A3489
6 Trolley Threaded Shaft	109B48
<b>Not Shown</b>	
Rail Grease	83A11-2

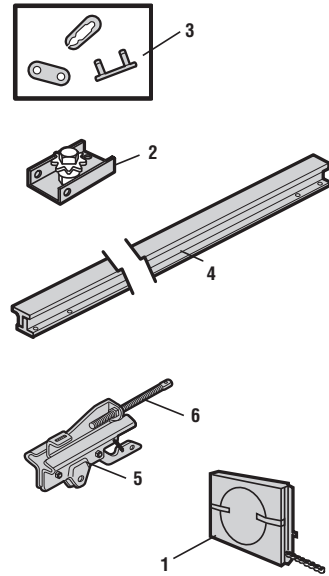

## Installation Parts

Description	Part Number
1 Curved Door Arm	178B35
2 Door Bracket with Clevis Pin and Fastener	41A5047-1
3 Emergency Release Rope and Handle	41A2828
4 Header Bracket with Clevis Pin and Fastener	41A4353-1
5 Remote Control Visor Clip	29C151
6 Safety Sensor Bracket	41A5266-1
7 Safety Sensor Kit with receiving and sending sensors with 3 feet (.9 m) 2-conductor wire	041A5034
8 Straight Door Arm	178B34
9 White and Red/White Wire	41B4494-1
10 3V CR2032 Lithium Battery	10A20
11 Extension Brackets	041A5281-1
<b>Not Shown</b>	
User's Guide	114A5013

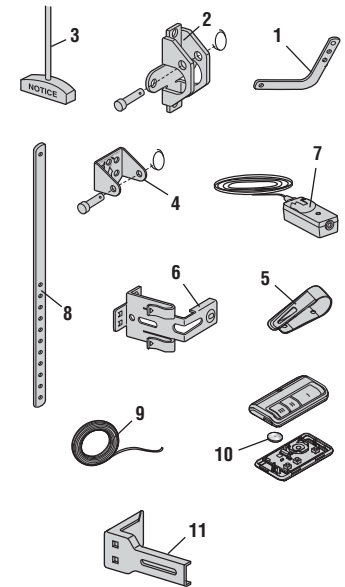

## Accessories

Description	Part Number
1 Smart Control Panel®	880LMW
2 Remote Control	893MAX

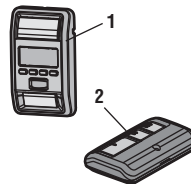

# Repair Parts

## Garage Door Opener Parts

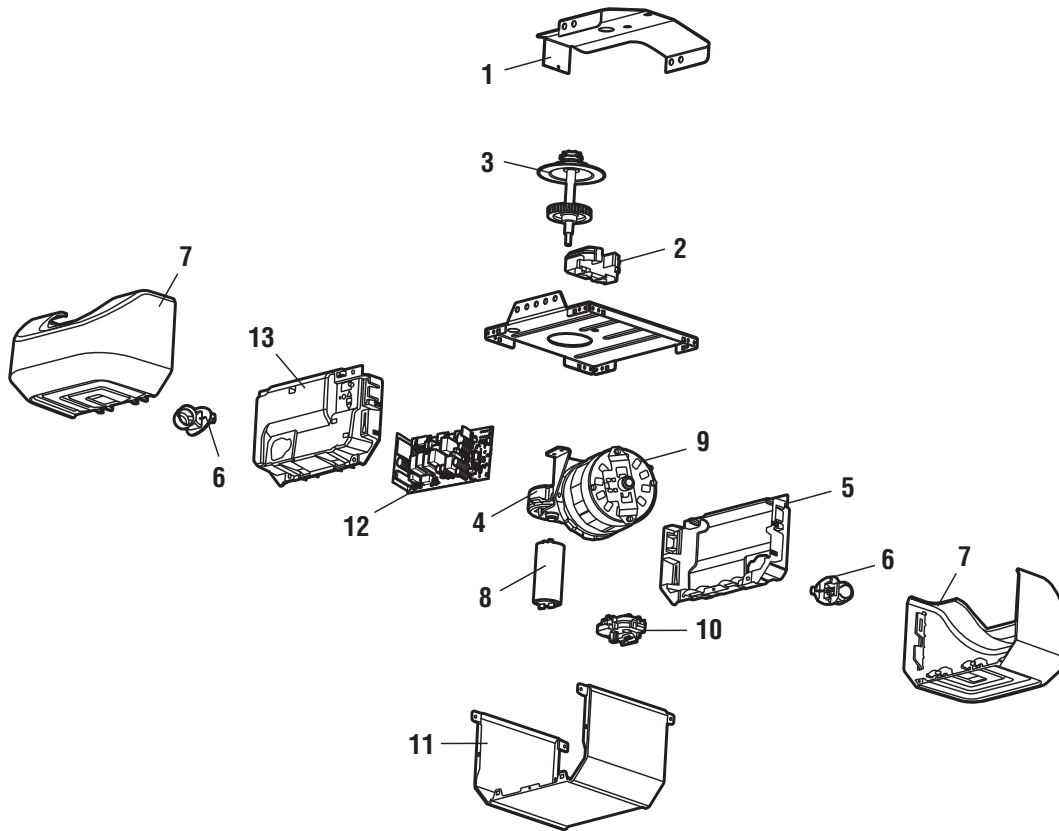

	DESCRIPTION	Part Number
1	Chassis Support Bracket	041C5069
2	Chain spreader	041A4208-2
3	Gear and Sprocket	041A5658-1
4	Gear Case	041A5532
5	Front End Panel	041A7756-1
6	Light Socket	041C0279
7	Light Lens	041A7562
8	Capacitor	030B0652
9	Motor with Travel Module	041A7767
10	Travel Module	041D7742-5
	Cover	
11	8587W	041D8258
	8587WL	041D8856
	Receiver Logic Board	
12	8587W	050ACTWF
	8587WL	050ACTWFLK
	Logic Board End Panel	
13	8587W	041D8198
	8587WL	041D0216-2
	<b>Not Shown</b>	
	Wire Harness	041A7814

### Contact Information

Address repair parts order to:

**LiftMaster**  
**6050 S. Country Club Rd.**  
**Tucson, AZ 85706**

For installation and service information call:

**1-800-528-9131**

Or visit us online at:

**LiftMaster.com**

or

**myLiftMaster.com**

*Before calling, please have the model number of the garage door opener. If you are calling about a troubleshooting issue, it is recommended that you have access to your garage door opener while calling. If you are ordering a repair part please have the following information: part number, part name, and model number.*

Wi-Fi® is a registered trademark of Wi-Fi Alliance.  
 App Store is a service mark of Apple Inc.  
 Google Play is a trademark of Google Inc.  
 © 2017, LiftMaster  
 All Rights Reserved