

For use with Chamberlain 315 MHz or 390 MHz garage door openers manufactured after January 1, 1993. The garage door opener activates when the programmed button on the remote control is pressed. The remote control can activate up to three garage door openers.

Make sure the garage door opener has a working light bulb because it is a programming indicator.

GARAGE ACCESS SYSTEM REMOTE

MODELS 953EV AND 953EVC

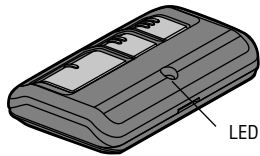

GARAGE ACCESS SYSTEM KEYCHAIN REMOTE

MODELS 956EV AND 956EVC

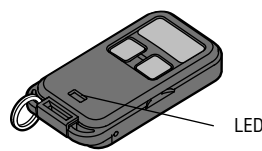

⚠ WARNING

To prevent possible **SERIOUS INJURY** or **DEATH** from a moving gate or garage door:

- ALWAYS keep remote controls out of reach of children. NEVER permit children to operate or play with remote controls.
- Activate gate or door **ONLY** when it can be seen clearly, is properly adjusted and there are no obstructions to door travel.
- ALWAYS keep gate or garage door in sight until completely closed. NEVER permit anyone to cross path of moving gate or door.

PREPARE

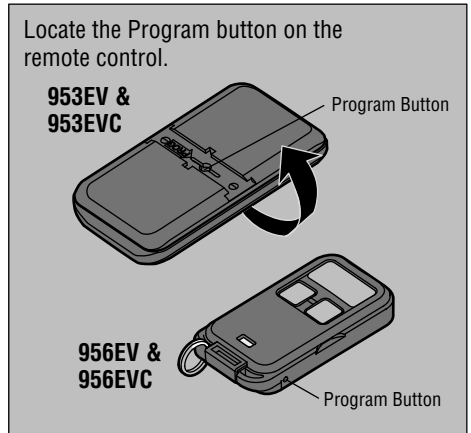
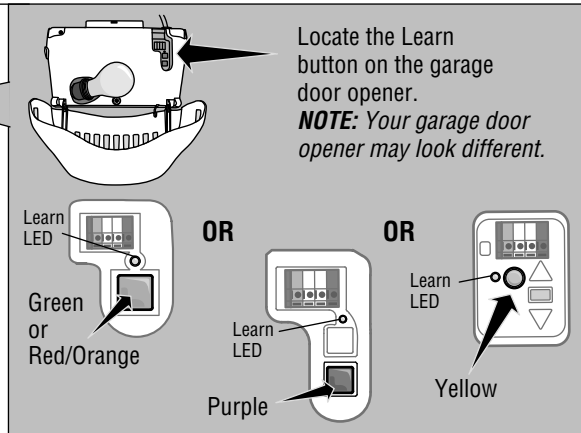
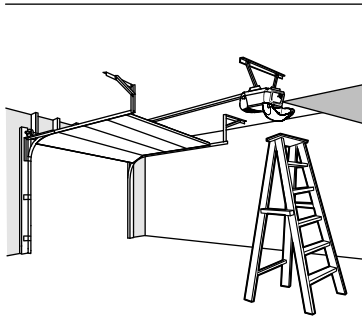

PROGRAM THE REMOTE CONTROL (953EV & 953EVC)

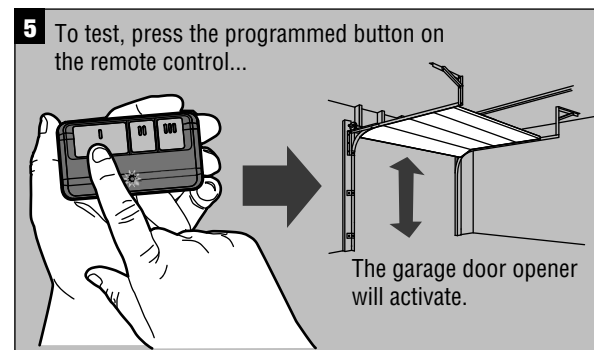
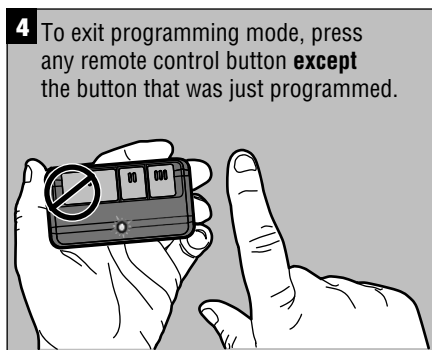
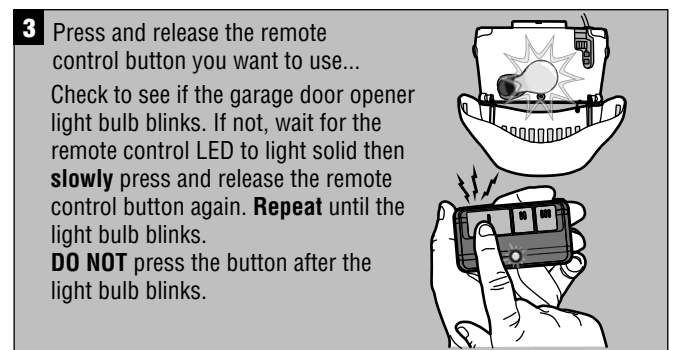
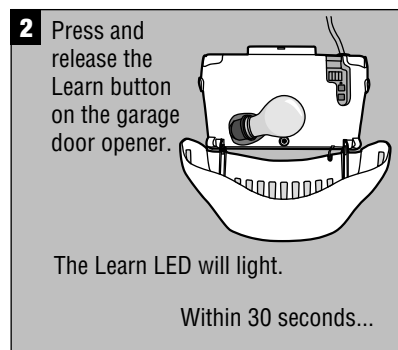
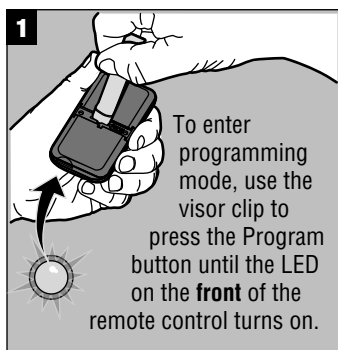

PROGRAM THE REMOTE CONTROL (956EV & 956EVC)

1 Using a safety pin or paper clip, press the Program button until the LED on the **front** of the remote control turns on.

2 Press and release the Learn button on the garage door opener.

The Learn LED will light.

Within 30 seconds...

3 Press and release the remote control button you want to use... Check to see if the garage door opener light bulb blinks. If not, wait for the remote control LED to light solid then **slowly** press and release the remote control button again. **Repeat** until the light bulb blinks. **DO NOT** press the button after the light bulb blinks.

4 To exit programming mode, press any remote control button **except** the button that was just programmed.

5 To test, press the programmed button on the remote control...

The garage door opener will activate.

BATTERY

The LED on your remote will stop flashing when the battery is low and needs to be replaced. To replace battery, open the case as shown. Insert battery positive side up (+). Replace the battery with only 3V2032 coin cell batteries. Dispose of old battery properly.

953EV & 953EVC

Pry open the case first in the middle (1), then at each side (2 and 3) with the visor clip.

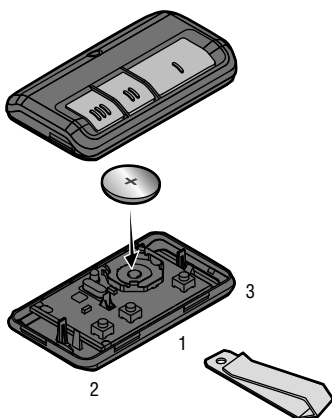

956EV & 956EVC

Pry open the case with a screwdriver blade.

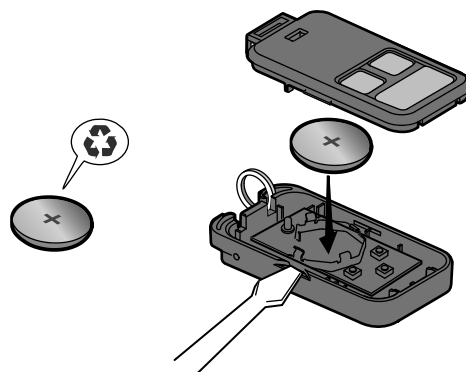

WARNING

To prevent possible **SERIOUS INJURY** or **DEATH**:

- NEVER allow small children near batteries.
- If battery is swallowed, immediately notify doctor.

To reduce risk of fire, explosion or chemical burn:

- Replace **ONLY** with 3V2032 coin batteries.
- **DO NOT** recharge, disassemble, heat above 212° F (100° C) or incinerate.

NOTICE: To comply with FCC and or Industry Canada rules (IC), adjustment or modifications of this receiver and/or transmitter are prohibited, except for changing the code setting or replacing the battery. **THERE ARE NO OTHER USER SERVICEABLE PARTS.**

Tested to Comply with FCC Standards for Home or office use. Operation is subject to the following two conditions: (1) this device may not cause harmful interference, and (2) this device must accept any interference received, including interference that may cause undesired operation.

WARRANTY

ONE YEAR LIMITED WARRANTY

The Chamberlain Group, Inc. warrants to the first retail purchaser of this product that is free from defect in materials and/or workmanship for a period of 1 year from the date of purchase.

1-800-528-9131

114A3924

REPLACEMENT PARTS

Battery 10A20
Visor Clip
(Models 953EV & 953EVC ONLY) 20B137