

# SUPPORT

## SERIAL NUMBER RECORD

Record the serial numbers and date of purchase of your Ditch Witch components in the spaces below.

<b>Date of purchase:</b>	
<b>Tracker serial number:</b>	

# SUPPORT

## SERIAL NUMBER RECORD

Record the serial numbers and date of purchase of your Ditch Witch components in the spaces below.

<b>Date of purchase:</b>	
<b>Tracker serial number:</b>	

## SERVICE PROCEDURE

Notify your authorized Ditch Witch dealer immediately of any malfunction of Ditch Witch equipment.

Always give model, serial number, and approximate date of purchase. This information should be recorded and placed on file by owner at time of purchase. Give detailed explanation of malfunction.

Return damaged parts to an authorized Ditch Witch dealer for inspection and warranty consideration.

Order genuine Ditch Witch replacement or repair parts from your Ditch Witch dealer. Use of another manufacturer's parts may void warranty.

## SERVICE PROCEDURE

Notify your authorized Ditch Witch dealer immediately of any malfunction of Ditch Witch equipment.

Always give model, serial number, and approximate date of purchase. This information should be recorded and placed on file by owner at time of purchase. Give detailed explanation of malfunction.

Return damaged parts to an authorized Ditch Witch dealer for inspection and warranty consideration.

Order genuine Ditch Witch replacement or repair parts from your Ditch Witch dealer. Use of another manufacturer's parts may void warranty.

## FOREWORD

This manual is an important part of your equipment. It provides safety information and operation instructions to help you use and maintain your Ditch Witch equipment.

Read this manual before using your equipment. Keep it with the equipment at all times for future reference. If you sell your equipment, be sure to give this manual to the new owner.

If you need a replacement copy, contact your Ditch Witch dealer.

The descriptions and specifications in this manual are subject to change. The Charles Machine Works, Inc. reserves the right to improve equipment. Some product improvements may have taken place after this manual was published.

Thank you for buying and using Ditch Witch equipment.

### FCC Statement -- Internal Transmitter

FCC ID: ITQ-752TKR0408  
FCC ID: ITQ-750TKR0408  
IC: 3598A-750TKR0408

This device complies with Part 15 of the FCC rules. Operation is subject to the following two conditions: (1) this device may not cause harmful interference, and (2) this device must accept any interference received, including interference that may cause undesired operation.

To reduce potential radio interference to other users, the antenna type and its gain should be so chosen that the equivalent isotropically radiated power (e.i.r.p.) is not more than that permitted for successful communication

Changes or modifications to the device not expressly approved by **The Charles Machine Works, Inc.** could void the user's authority to operate the equipment.

## FOREWORD

This manual is an important part of your equipment. It provides safety information and operation instructions to help you use and maintain your Ditch Witch equipment.

Read this manual before using your equipment. Keep it with the equipment at all times for future reference. If you sell your equipment, be sure to give this manual to the new owner.

If you need a replacement copy, contact your Ditch Witch dealer.

The descriptions and specifications in this manual are subject to change. The Charles Machine Works, Inc. reserves the right to improve equipment. Some product improvements may have taken place after this manual was published.

Thank you for buying and using Ditch Witch equipment.

### FCC Statement -- Internal Transmitter

FCC ID: ITQ-752TKR0408  
FCC ID: ITQ-750TKR0408  
IC: 3598A-750TKR0408

This device complies with Part 15 of the FCC rules. Operation is subject to the following two conditions: (1) this device may not cause harmful interference, and (2) this device must accept any interference received, including interference that may cause undesired operation.

To reduce potential radio interference to other users, the antenna type and its gain should be so chosen that the equivalent isotropically radiated power (e.i.r.p.) is not more than that permitted for successful communication

Changes or modifications to the device not expressly approved by **The Charles Machine Works, Inc.** could void the user's authority to operate the equipment.

**Operator's Manual  
750 Tracker/752 Tracker**

Issue No. 3.3/OP-5/2008  
Part Number 054-080

Copyright 1999, 2000, 2001, 2005, 2007, 2008  
by The Charles Machine Works, Inc.,  
Perry, Oklahoma



, Ditch Witch, CMW, AutoCrowd,  
Jet Trac, Roto Witch, Subsite, Fluid Miser, Power Pipe,  
Super Witch, Pierce Arrow, The Underground, The Underground  
Authority Worldwide and Zahn are registered trademarks of  
The Charles Machine Works, Inc.

U.S. Patent No. 5,065,098; 4,881,083. Other U.S. and foreign patents  
pending.

**Operator's Manual  
750 Tracker/752 Tracker**

Issue No. 3.3/OP-5/2008  
Part Number 054-080

Copyright 1999, 2000, 2001, 2005, 2007, 2008  
by The Charles Machine Works, Inc.,  
Perry, Oklahoma



, Ditch Witch, CMW, AutoCrowd,  
Jet Trac, Roto Witch, Subsite, Fluid Miser, Power Pipe,  
Super Witch, Pierce Arrow, The Underground, The Underground  
Authority Worldwide and Zahn are registered trademarks of  
The Charles Machine Works, Inc.

U.S. Patent No. 5,065,098; 4,881,083. Other U.S. and foreign patents  
pending.

# CONTENTS

<b>SUPPORT</b> .....	<b>1</b>
Serial Number Record .....	1
Service Procedure .....	2
<b>FOREWORD</b> .....	<b>3</b>
<b>CONTROLS</b> .....	<b>7</b>
Overview .....	7
Controls .....	8
Setup .....	11
Display .....	12
<b>SAFETY</b> .....	<b>17</b>
Classifications .....	18
Alerts .....	19
<b>OPERATION</b> .....	<b>21</b>
Beacon Tracking Modes .....	21
Line Locating Mode .....	32
<b>MAINTENANCE</b> .....	<b>35</b>
General Care .....	35
<b>SPECIFICATIONS</b> .....	<b>37</b>
<b>WARRANTY</b> .....	<b>39</b>

# CONTENTS

<b>SUPPORT</b> .....	<b>1</b>
Serial Number Record .....	1
Service Procedure .....	2
<b>FOREWORD</b> .....	<b>3</b>
<b>CONTROLS</b> .....	<b>7</b>
Overview .....	7
Controls .....	8
Setup .....	11
Display .....	12
<b>SAFETY</b> .....	<b>17</b>
Classifications .....	18
Alerts .....	19
<b>OPERATION</b> .....	<b>21</b>
Beacon Tracking Modes .....	21
Line Locating Mode .....	32
<b>MAINTENANCE</b> .....	<b>35</b>
General Care .....	35
<b>SPECIFICATIONS</b> .....	<b>37</b>
<b>WARRANTY</b> .....	<b>39</b>



## CONTROLS

### OVERVIEW

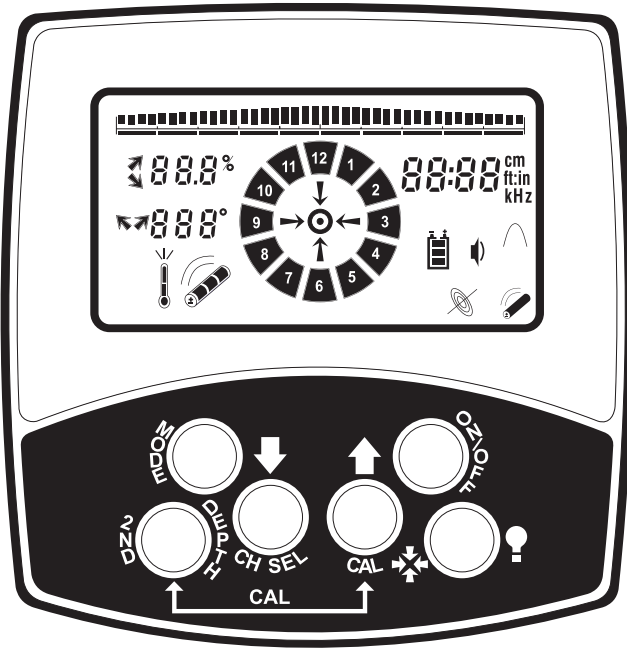

ss0002h.cdr

The 750/752 Tracker performs well with a variety of beacons and can track shallow or deep bores. It can track both 12K and 29K beacons and send beacon information to a display mounted on the drilling unit operator's station. The 750/752 Tracker can also locate lines and cables. Available modes are 8 kHz active (when used with transmitter) and 60 or 50 Hz passive (for locating power cables).

A brief description of the buttons and display on the 750/752 Tracker follows.

## CONTROLS

### OVERVIEW

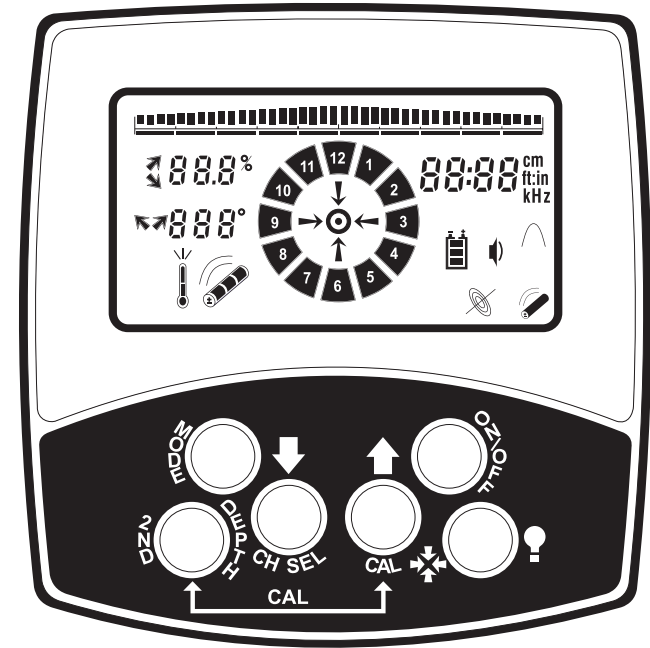

ss0002h.cdr

The 750/752 Tracker performs well with a variety of beacons and can track shallow or deep bores. It can track both 12K and 29K beacons and send beacon information to a display mounted on the drilling unit operator's station. The 750/752 Tracker can also locate lines and cables. Available modes are 8 kHz active (when used with transmitter) and 60 or 50 Hz passive (for locating power cables).

A brief description of the buttons and display on the 750/752 Tracker follows.

## CONTROLS

### On/Off

Pressing this button turns unit on and off.

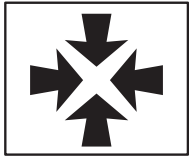

si0001h.cdr

### Fore/Aft/Left/Right

Pressing this button while in walkover tracking mode switches from fore/aft to left/right arrows. Only one set of arrows will show at a time. See **OPERATION** for further information.



### Up

Pressing this button raises gain (increases signal).

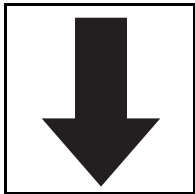

### Down

Pressing this button reduces gain (decreases signal).

### Depth

This button estimates depth of properly located signal source when pressed. See **OPERATION** for information on locating signals.

### Mode

Pressing this button changes location mode and operating frequency.

## CONTROLS

### On/Off

Pressing this button turns unit on and off.

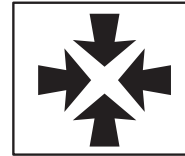

si0001h.cdr

### Fore/Aft/Left/Right

Pressing this button while in walkover tracking mode switches from fore/aft to left/right arrows. Only one set of arrows will show at a time. See **OPERATION** for further information.

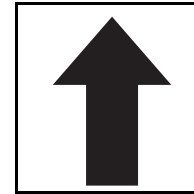

### Up

Pressing this button raises gain (increases signal).

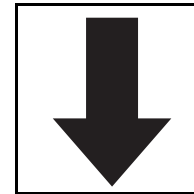

### Down

Pressing this button reduces gain (decreases signal).

### Depth

This button estimates depth of properly located signal source when pressed. See **OPERATION** for information on locating signals.

### Mode

Pressing this button changes location mode and operating frequency.



### **Depth + On/Off**

Pressing these buttons when tracker is on cycles volume from low to high to off. Pressing and holding depth button before turning tracker on changes signal strength display. See “Signal Strength” section later in this chapter for more information.

### **Depth + Fore/Aft/Left/Right**

Pressing these buttons switches LCD backlight off and on.

### **Depth + Up**

Pressing these buttons enters tracker into calibration mode. See **OPERATION** for further information.

### **Depth + Down**

Pressing these buttons selects radio channel. 750 - Off, CH1, CH2 will appear in display. 752 - Off, CH1, CH2, CH3, CH4, CH5, CH6, CH7, CH8, CH9 will appear in display.

### **Depth + Mode**

Pressing these buttons changes depth units from default setting of feet•inches to inches, centimeters, or meters.

### **Down + On**

Holding down button while turning unit on toggles gain control from auto to manual. Display will show “Auto” if in automatic gain mode, and will be blank if in manual gain mode.

### **Depth + On/Off**

Pressing these buttons when tracker is on cycles volume from low to high to off. Pressing and holding depth button before turning tracker on changes signal strength display. See “Signal Strength” section later in this chapter for more information.

### **Depth + Fore/Aft/Left/Right**

Pressing these buttons switches LCD backlight off and on.

### **Depth + Up**

Pressing these buttons enters tracker into calibration mode. See **OPERATION** for further information.

### **Depth + Down**

Pressing these buttons selects radio channel. 750 - Off, CH1, CH2 will appear in display. 752 - Off, CH1, CH2, CH3, CH4, CH5, CH6, CH7, CH8, CH9 will appear in display.

### **Depth + Mode**

Pressing these buttons changes depth units from default setting of feet•inches to inches, centimeters, or meters.

### **Down + On**

Holding down button while turning unit on toggles gain control from auto to manual. Display will show “Auto” if in automatic gain mode, and will be blank if in manual gain mode.

**Fore/Aft/Left/Right + Mode**

Pressing these buttons enters tracker control mode and starts tracker control code transmission (see **OPERATION**).

**Fore/Aft/Left/Right + Depth**

Pressing and holding these buttons for three seconds calibrates roll (see **OPERATION**).

**Fore/Aft/Left/Right + Up**

Pressing and holding these buttons calibrates pitch (see **OPERATION**).

**Fore/Aft/Left/Right + Mode**

Pressing these buttons enters tracker control mode and starts tracker control code transmission (see **OPERATION**).

**Fore/Aft/Left/Right + Depth**

Pressing and holding these buttons for three seconds calibrates roll (see **OPERATION**).

**Fore/Aft/Left/Right + Up**

Pressing and holding these buttons calibrates pitch (see **OPERATION**).

## SETUP

### Install batteries

Use 6 C-cell alkaline batteries in tracker. To install:

- unscrew battery cover
- insert batteries as indicated
- close cover and tighten screw
- check operation

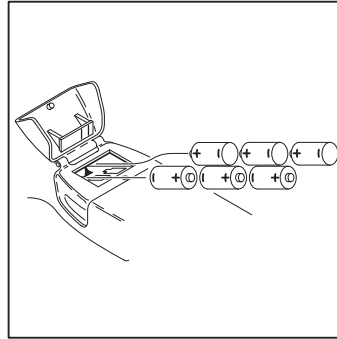

ss0028h.cdr

### Check Operation

Always check that tracker operates before leaving for jobsite and after every battery change. To check operation:

- turn on tracker
- entire display will light briefly
- battery level will be shown graphically
- unit defaults to most recently used tracking mode

## SETUP

### Install batteries

Use 6 C-cell alkaline batteries in tracker. To install:

- unscrew battery cover
- insert batteries as indicated
- close cover and tighten screw
- check operation

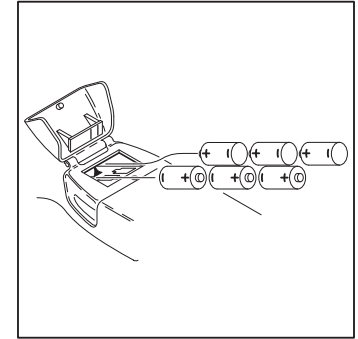

ss0028h.cdr

### Check Operation

Always check that tracker operates before leaving for jobsite and after every battery change. To check operation:

- turn on tracker
- entire display will light briefly
- battery level will be shown graphically
- unit defaults to most recently used tracking mode

## DISPLAY

### Mode

Tracker can track beacons and locate lines. Switch between modes by pressing mode button.

#### Beacon Mode Indicator

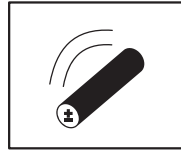

si0005h.cdr

#### Line Mode Indicator

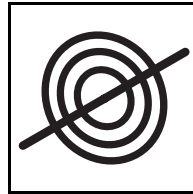

## DISPLAY

### Mode

Tracker can track beacons and locate lines. Switch between modes by pressing mode button.

#### Beacon Mode Indicator

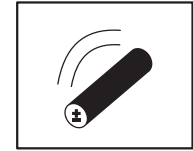

si0005h.cdr

#### Line Mode Indicator

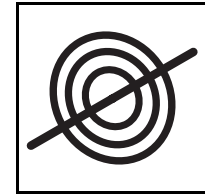

## Tracker Information

A variety of tracker information can be monitored in the display window. Additionally, several tracker display settings can be changed.

### Battery Level

Tracker battery level is shown graphically. Display shows battery status in 33% steps. When tracker battery drops below 10%, tracker battery symbol outline flashes. Replace batteries immediately.

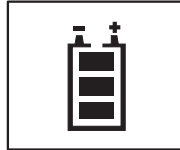

si0003h.cdr

### Volume Level

Speaker volume can be adjusted by pressing the depth and on/off buttons. Available settings are low, high and off.

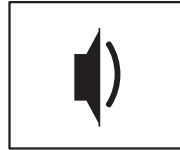

si0004h.cdr

### Depth Units

Depth estimates can be displayed in four ways: feet•inches, inches, centimeters, or meters. To change depth units, press depth and mode buttons.



ss0011h.cdr

## Tracker Information

A variety of tracker information can be monitored in the display window. Additionally, several tracker display settings can be changed.

### Battery Level

Tracker battery level is shown graphically. Display shows battery status in 33% steps. When tracker battery drops below 10%, tracker battery symbol outline flashes. Replace batteries immediately.

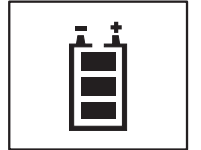

si0003h.cdr

### Volume Level

Speaker volume can be adjusted by pressing the depth and on/off buttons. Available settings are low, high and off.

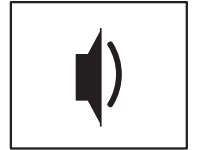

si0004h.cdr

### Depth Units

Depth estimates can be displayed in four ways: feet•inches, inches, centimeters, or meters. To change depth units, press depth and mode buttons.



ss0011h.cdr

**Signal Strength**

Signal strength is shown graphically on bars at top of display and in numeric display. It can be displayed two ways: building from both sides into the middle (a) or building from left to right (b). To change signal strength display, turn unit off. Then press and hold depth button while turning unit on.

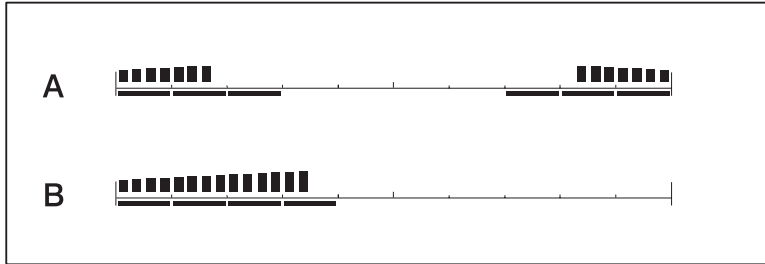

ss0016h.eps

**Gain**

Gain (amount of signal amplification) is shown on bars below signal strength indicator. Gain increases to the right.

**Signal Strength**

Signal strength is shown graphically on bars at top of display and in numeric display. It can be displayed two ways: building from both sides into the middle (a) or building from left to right (b). To change signal strength display, turn unit off. Then press and hold depth button while turning unit on.

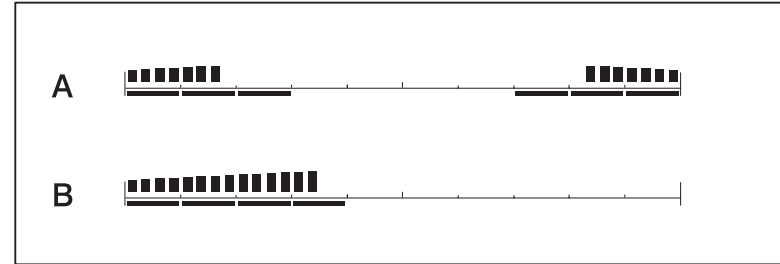

ss0016h.eps

**Gain**

Gain (amount of signal amplification) is shown on bars below signal strength indicator. Gain increases to the right.

## Beacon Information

Tracker displays a variety of information sent from the beacon. Actual information sent depends on beacon used.

### Temperature

Beacon temperature is continuously displayed numerically in °C and °F, as well as in 33% segments on the temperature icon (shown). Operator should monitor beacon temperature throughout bore. Temperature icon will flash after third segment is lit, or when temperature reads 156°F (69°C), and an audible alert will sound. Watch for rapid changes in beacon temperature and cool beacon by pulling back a few inches and pumping fluid downhole.

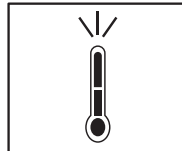

ss0004h.cdr

### Battery Level

Beacon battery level is continuously shown. When beacon battery is below 10%, beacon battery outline will flash. Replace battery as soon as possible. Each segment represents 33% of battery life.



ss0005h.cdr

### Roll

Beacon roll is shown in a twelve segment roll indicator for all beacons. The sections of the roll indicator light to indicate beacon roll position.

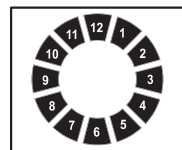

ss0012h.cdr

## Beacon Information

Tracker displays a variety of information sent from the beacon. Actual information sent depends on beacon used.

### Temperature

Beacon temperature is continuously displayed numerically in °C and °F, as well as in 33% segments on the temperature icon (shown). Operator should monitor beacon temperature throughout bore. Temperature icon will flash after third segment is lit, or when temperature reads 156°F (69°C), and an audible alert will sound. Watch for rapid changes in beacon temperature and cool beacon by pulling back a few inches and pumping fluid downhole.

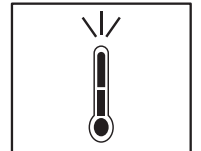

ss0004h.cdr

### Battery Level

Beacon battery level is continuously shown. When beacon battery is below 10%, beacon battery outline will flash. Replace battery as soon as possible. Each segment represents 33% of battery life.



ss0005h.cdr

### Roll

Beacon roll is shown in a twelve segment roll indicator for all beacons. The sections of the roll indicator light to indicate beacon roll position.

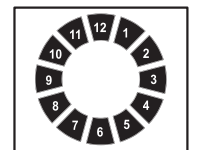

ss0012h.cdr

**Depth**

In walkover tracking and line locating modes, estimated depth is shown in numeric display when depth button is pressed after beacon has been properly located.

In remote guidance mode, approximate distance from beacon to tracker is shown in numeric display every 5 seconds.

**Depth**

In walkover tracking and line locating modes, estimated depth is shown in numeric display when depth button is pressed after beacon has been properly located.

In remote guidance mode, approximate distance from beacon to tracker is shown in numeric display every 5 seconds.



---

## SAFETY

Follow these guidelines before operating any jobsite equipment:

- Read and follow all safety precautions.
- Do not operate equipment unless you have completed proper training and read the operator's manual.
- Use equipment only as directed.
- Wear personal protective gear.
- Check that equipment is clean and in good condition.

Contact your Ditch Witch dealer if you have any question about operation, maintenance, or equipment use.

---

## SAFETY

Follow these guidelines before operating any jobsite equipment:

- Read and follow all safety precautions.
- Do not operate equipment unless you have completed proper training and read the operator's manual.
- Use equipment only as directed.
- Wear personal protective gear.
- Check that equipment is clean and in good condition.

Contact your Ditch Witch dealer if you have any question about operation, maintenance, or equipment use.

## CLASSIFICATIONS

Watch for the three safety alert levels: **DANGER**, **WARNING** and **CAUTION**. Learn what each level means.

 **DANGER** indicates an imminently hazardous situation which, if not avoided, will result in death or serious injury.

 **WARNING** indicates a potentially hazardous situation which, if not avoided, could result in death or serious injury.

 **CAUTION** indicates a potentially hazardous situation which, if not avoided, may result in minor or moderate injury.

Watch for two other words: **NOTICE** and **IMPORTANT**.

**NOTICE** can keep you from doing something that might damage the machine or someone's property. It can also alert you against unsafe practices.

**IMPORTANT** can help you do a better job or make your job easier in some way.

## CLASSIFICATIONS

Watch for the three safety alert levels: **DANGER**, **WARNING** and **CAUTION**. Learn what each level means.

 **DANGER** indicates an imminently hazardous situation which, if not avoided, will result in death or serious injury.

 **WARNING** indicates a potentially hazardous situation which, if not avoided, could result in death or serious injury.

 **CAUTION** indicates a potentially hazardous situation which, if not avoided, may result in minor or moderate injury.

Watch for two other words: **NOTICE** and **IMPORTANT**.

**NOTICE** can keep you from doing something that might damage the machine or someone's property. It can also alert you against unsafe practices.

**IMPORTANT** can help you do a better job or make your job easier in some way.

## ALERTS



**⚠ WARNING** Incorrect procedures could result in death, injury, or property damage. Learn to use equipment correctly.



**⚠ WARNING** Moving traffic - hazardous situation. Death or serious injury could result. Avoid moving vehicles, wear high visibility clothing, post appropriate warning signs.

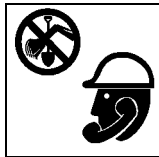

**⚠ WARNING** Jobsite hazards could cause death or serious injury. Use correct equipment and work methods. Use and maintain proper safety equipment.



**⚠ WARNING** Explosion possible. Do not operate transmitter near explosive devices or blasting operations.



**⚠ CAUTION** Potential radio frequency (RF) hazard. Operating this device within 4 in (10 cm) of your body may cause RF exposure levels to exceed FCC RF exposure limits and should be avoided.

## ALERTS

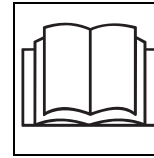

**⚠ WARNING** Incorrect procedures could result in death, injury, or property damage. Learn to use equipment correctly.



**⚠ WARNING** Moving traffic - hazardous situation. Death or serious injury could result. Avoid moving vehicles, wear high visibility clothing, post appropriate warning signs.

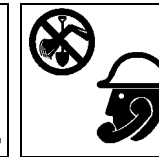
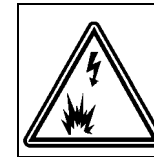

**⚠ WARNING** Jobsite hazards could cause death or serious injury. Use correct equipment and work methods. Use and maintain proper safety equipment.



**⚠ WARNING** Explosion possible. Do not operate transmitter near explosive devices or blasting operations.



**⚠ CAUTION** Potential radio frequency (RF) hazard. Operating this device within 4 in (10 cm) of your body may cause RF exposure levels to exceed FCC RF exposure limits and should be avoided.



## OPERATION

The 750/752 tracker has four operation modes: tracker control, walkover beacon tracking, remote guidance, and line locating. Tracker control, walkover beacon tracking and remote guidance work with 12K and 29K beacons.



**CAUTION** Potential radio frequency (RF) hazard. Operating this device within 8" (20 cm) of your body may cause RF exposure levels to exceed FCC RF exposure limits and should be avoided. This device must not be co-located with any other radio transmitter. The maximum antenna gain is 8 dBI.

**IMPORTANT:** Large metal objects, rebar, power lines and any other kinds of interference can adversely affect depth estimates.

## BEACON TRACKING MODES

### Set-up

You must calibrate tracker to each beacon frequency before beginning a beacon tracking job. After calibration, tracker can estimate depths from approximately 9" (0.2 m) to 100' (30.5 m) depending on beacon used. Keep the following in mind when calibrating system:

- Beacon and tracker should not be moved or rotated until calibration is complete.
- Only depth estimation is affected by calibration. Roll, pitch, left/right deviation, temperature, and battery status are not affected.
- Large metal objects, rebar, power lines, and any other kinds of interference will adversely affect calibration.

## OPERATION

The 750/752 tracker has four operation modes: tracker control, walkover beacon tracking, remote guidance, and line locating. Tracker control, walkover beacon tracking and remote guidance work with 12K and 29K beacons.



**CAUTION** Potential radio frequency (RF) hazard. Operating this device within 8" (20 cm) of your body may cause RF exposure levels to exceed FCC RF exposure limits and should be avoided. This device must not be co-located with any other radio transmitter. The maximum antenna gain is 8 dBI.

**IMPORTANT:** Large metal objects, rebar, power lines and any other kinds of interference can adversely affect depth estimates.

## BEACON TRACKING MODES

### Set-up

You must calibrate tracker to each beacon frequency before beginning a beacon tracking job. After calibration, tracker can estimate depths from approximately 9" (0.2 m) to 100' (30.5 m) depending on beacon used. Keep the following in mind when calibrating system:

- Beacon and tracker should not be moved or rotated until calibration is complete.
- Only depth estimation is affected by calibration. Roll, pitch, left/right deviation, temperature, and battery status are not affected.
- Large metal objects, rebar, power lines, and any other kinds of interference will adversely affect calibration.

**Calibration Procedure**

1. Select beacon frequency, if necessary.
2. Install beacon into drill head and place on ground exactly 10' (3 m) away from tracker. Make sure no metal objects including drilling unit and drill pipe are within 20' (6 m) of tracker and toolhead.
3. Position tracker parallel to center of drill head.
4. Turn tracker on and press and hold depth and up arrow keys until calibration mode is entered. Release keys.
5. Verify calibration by moving tracker 15' (4.5 m) away from toolhead. Check depth. If reading is not 15' (4.5 m), recalibrate tracker.
6. Repeat for other frequency, if needed.

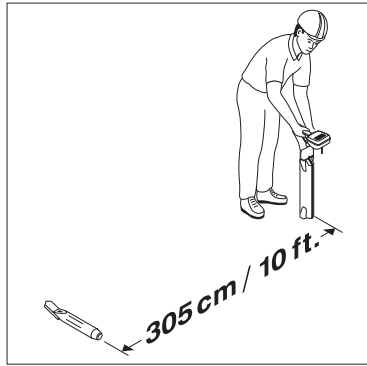

**IMPORTANT:** Some beacons transmit more than one frequency. Calibrate tracker for each frequency separately.

**Calibration Procedure**

1. Select beacon frequency, if necessary.
2. Install beacon into drill head and place on ground exactly 10' (3 m) away from tracker. Make sure no metal objects including drilling unit and drill pipe are within 20' (6 m) of tracker and toolhead.
3. Position tracker parallel to center of drill head.
4. Turn tracker on and press and hold depth and up arrow keys until calibration mode is entered. Release keys.
5. Verify calibration by moving tracker 15' (4.5 m) away from toolhead. Check depth. If reading is not 15' (4.5 m), recalibrate tracker.
6. Repeat for other frequency, if needed.

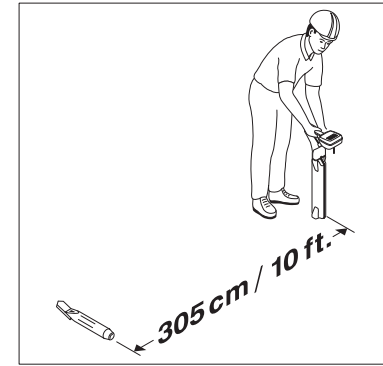

**IMPORTANT:** Some beacons transmit more than one frequency. Calibrate tracker for each frequency separately.

### Grade Beacon Pitch Calibration

1. Place 86BG beacon into the housing and put the lid on the housing.
2. Use the Smart tool according to the instructions included with the level.
3. Use the Smart tool to level the housing to 0.
4. Using the tracker, check the pitch of the 86BG and make sure that it is  $\pm 1\%$  or lower. If the pitch is more than  $\pm 1\%$ , remove housing lid and adjust the beacon inside the housing to  $\pm 1\%$  or less and repeat steps 3 and 4.

**IMPORTANT:** If the 86GB is not within  $\pm 1\%$  of zero, the tracker pitch will not calibrate.

5. Once the housing is level and the 86BG is within  $\pm 1\%$ , push and hold the F/A/L/R button and press the down arrow key. This will reset the pitch shown on the tracker to zero.
6. To revert to actual/pitch display, press and hold the F/A/L/R button and press the down arrow key, then press the up arrow key. This will reset the pitch display to show actual pitch rather than calibrated pitch.

### Grade Beacon Pitch Calibration

1. Place 86BG beacon into the housing and put the lid on the housing.
2. Use the Smart tool according to the instructions included with the level.
3. Use the Smart tool to level the housing to 0.
4. Using the tracker, check the pitch of the 86BG and make sure that it is  $\pm 1\%$  or lower. If the pitch is more than  $\pm 1\%$ , remove housing lid and adjust the beacon inside the housing to  $\pm 1\%$  or less and repeat steps 3 and 4.

**IMPORTANT:** If the 86GB is not within  $\pm 1\%$  of zero, the tracker pitch will not calibrate.

5. Once the housing is level and the 86BG is within  $\pm 1\%$ , push and hold the F/A/L/R button and press the down arrow key. This will reset the pitch shown on the tracker to zero.
6. To revert to actual/pitch display, press and hold the F/A/L/R button and press the down arrow key, then press the up arrow key. This will reset the pitch display to show actual pitch rather than calibrated pitch.

### Roll Calibration

Calibrate roll display to 12:00 for use with mud motors or similar tools:

1. Place beacon in housing. Place housing at the 12:00 position.

**IMPORTANT:** Depending on beacon insertion, tracker may not show 12:00 roll.

2. Push and hold F/A/L/R key and press depth key for 3 seconds.
3. Continue pressing F/A/L/R key and roll will set to 12:00.

Reset to actual roll:

1. Push and hold F/A/L/R key and press depth key for 3 seconds.
2. Continue pressing F/A/L/R key and press down arrow key once.

### Roll Calibration

Calibrate roll display to 12:00 for use with mud motors or similar tools:

1. Place beacon in housing. Place housing at the 12:00 position.

**IMPORTANT:** Depending on beacon insertion, tracker may not show 12:00 roll.

2. Push and hold F/A/L/R key and press depth key for 3 seconds.
3. Continue pressing F/A/L/R key and roll will set to 12:00.

Reset to actual roll:

1. Push and hold F/A/L/R key and press depth key for 3 seconds.
2. Continue pressing F/A/L/R key and press down arrow key once.



## Troubleshooting

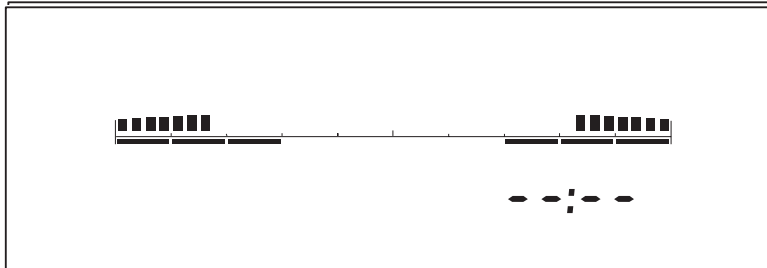

ss0013h.cdr

If four dashes appear in the display, unit has not been calibrated or has been calibrated incorrectly, beacon is too close for depth estimate, or beacon is too far away for depth estimate.

## Troubleshooting

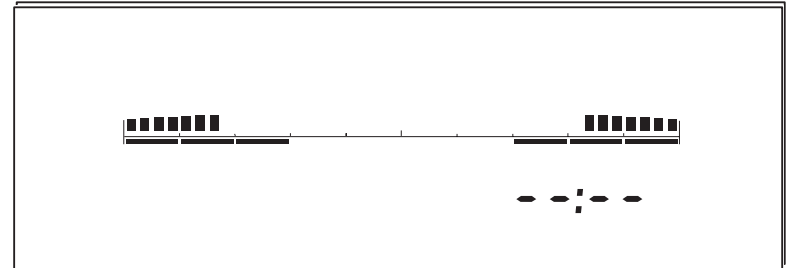

ss0013h.cdr

If four dashes appear in the display, unit has not been calibrated or has been calibrated incorrectly, beacon is too close for depth estimate, or beacon is too far away for depth estimate.

## Tracker Control Mode

### Overview



#### ⚠ WARNING

Incorrect procedures could result in death, injury, or property damage. Learn to use equipment correctly.

This mode allows 750/752 Tracker operator to disable hydraulic power to drilling unit thrust and rotation within 16 seconds. **This mode will not stop thrust and rotation immediately.**

When tracker and display communications cease, green tracker control light on drilling unit will come on and thrust and rotation will be disabled.

**Troubleshooting tip:** If thrust and rotation do not work, check whether tracker control light on drilling unit is on. If it is, communication has probably stopped between tracker and display or tracker is set to incorrect code. If communication cannot be restored, install tracker control key on drilling unit. Tracker control light will go off and thrust and rotation will function.

#### IMPORTANT:

- Tracker operator cannot stop thrust and rotation from tracker with tracker control key installed in drilling unit and turned to disable position.
- Tracker control mode is available on units with “TC” or “DF” at the end of their model descriptions.

## Tracker Control Mode

### Overview

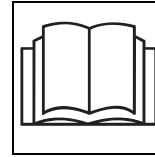

#### ⚠ WARNING

Incorrect procedures could result in death, injury, or property damage. Learn to use equipment correctly.

This mode allows 750/752 Tracker operator to disable hydraulic power to drilling unit thrust and rotation within 16 seconds. **This mode will not stop thrust and rotation immediately.**

When tracker and display communications cease, green tracker control light on drilling unit will come on and thrust and rotation will be disabled.

**Troubleshooting tip:** If thrust and rotation do not work, check whether tracker control light on drilling unit is on. If it is, communication has probably stopped between tracker and display or tracker is set to incorrect code. If communication cannot be restored, install tracker control key on drilling unit. Tracker control light will go off and thrust and rotation will function.

#### IMPORTANT:

- Tracker operator cannot stop thrust and rotation from tracker with tracker control key installed in drilling unit and turned to disable position.
- Tracker control mode is available on units with “TC” or “DF” at the end of their model descriptions.

### Operation

1. Turn on drilling unit. Press and hold download button to display serial number on 750/752 Display.

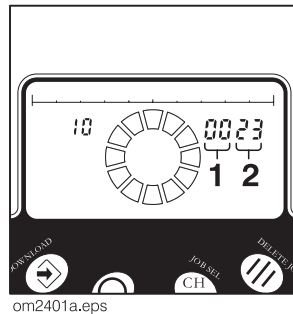

2. Turn on 750/752 Tracker and check four-digit display code.
  - Hold fore/aft/left/right button and press mode to review and start sending code.

**IMPORTANT:** Continue to hold down fore/aft/left/right button to adjust code.

- Use on/off button to advance first two digits (1) and use depth button to lower first two digits.
- Use up arrow button to advance last two digits (2) and use down arrow to lower last two digits.
- Press and hold button to advance or lower value quickly.

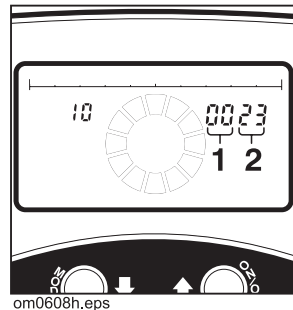

### Operation

1. Turn on drilling unit. Press and hold download button to display serial number on 750/752 Display.

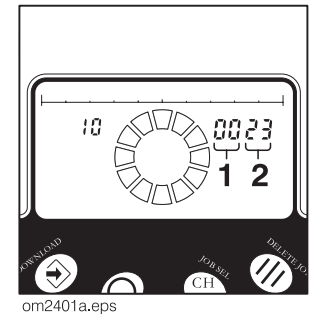

2. Turn on 750/752 Tracker and check four-digit display code.
  - Hold fore/aft/left/right button and press mode to review and start sending code.

**IMPORTANT:** Continue to hold down fore/aft/left/right button to adjust code.

- Use on/off button to advance first two digits (1) and use depth button to lower first two digits.
- Use up arrow button to advance last two digits (2) and use down arrow to lower last two digits.
- Press and hold button to advance or lower value quickly.

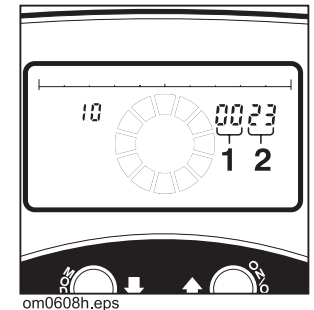

3. Remove tracker control key from drilling unit and keep in tracker operator's possession.
4. Drill and track bore until drill head enters target pit or exits ground.
5. Turn off tracker. After 8-16 seconds, tracker control light on drilling unit will come on and hydraulic power to thrust and rotation will be disabled.
6. Change downhole tools.
7. **If you are tracking backreamer's path**, turn on tracker and enable code transmission. After 8-16 seconds, tracker control light on drilling unit will go off and thrust and rotation will function.

**If you are not tracking backreamer's path**, install tracker control key on drilling unit. Tracker control light on drilling unit will go off and thrust and rotation will function.

3. Remove tracker control key from drilling unit and keep in tracker operator's possession.
4. Drill and track bore until drill head enters target pit or exits ground.
5. Turn off tracker. After 8-16 seconds, tracker control light on drilling unit will come on and hydraulic power to thrust and rotation will be disabled.
6. Change downhole tools.
7. **If you are tracking backreamer's path**, turn on tracker and enable code transmission. After 8-16 seconds, tracker control light on drilling unit will go off and thrust and rotation will function.

**If you are not tracking backreamer's path**, install tracker control key on drilling unit. Tracker control light on drilling unit will go off and thrust and rotation will function.

## Walkover Tracking Mode

### Location

1. Turn on tracker. Make sure you can see fore/aft arrows in center of display. If you see left/right arrows, press fore/aft/left/right key.
2. Walk bore path with bottom of tracker parallel to beacon. Do not hold tracker at right angle to beacon.

**IMPORTANT:** A common problem when locating a beacon is secondary or ghost signals. A typical beacon signal pattern shows a main signal and two weaker secondary signals. Track beacon at main signal. Familiarity with beacon signal pattern will lessen the effect of secondary signals. Also, the beacon tracking arrows will disappear when tracker is over secondary signal.

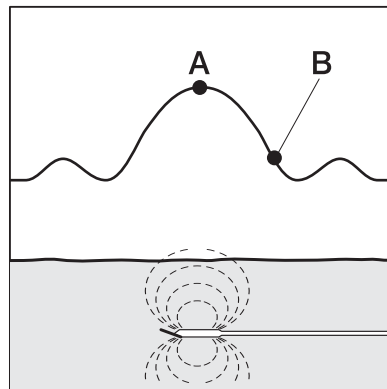

ss0027h.cdr

3. When both fore/aft arrows are on, sweep tracker from side to side and use signal strength display to find lateral location of beacon (point A).
4. Step back until ghost is located (no arrows in center of clock face and low signal strength) and then move slightly forward until only one arrow is lit

(point B).

5. Press fore/aft/left/right button to switch to left/right arrows and sweep tracker back and forth until both left/right arrows are on.
6. Switch back to fore/aft arrows and move forward until both fore/aft arrows and target is lit.
7. Take depth estimate and mark spot.

## Walkover Tracking Mode

### Location

1. Turn on tracker. Make sure you can see fore/aft arrows in center of display. If you see left/right arrows, press fore/aft/left/right key.
2. Walk bore path with bottom of tracker parallel to beacon. Do not hold tracker at right angle to beacon.

**IMPORTANT:** A common problem when locating a beacon is secondary or ghost signals. A typical beacon signal pattern shows a main signal and two weaker secondary signals. Track beacon at main signal. Familiarity with beacon signal pattern will lessen the effect of secondary signals. Also, the beacon tracking arrows will disappear when tracker is over secondary signal.

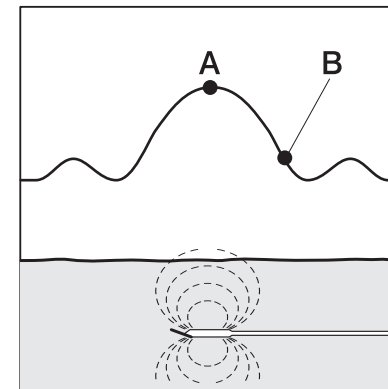

ss0027h.cdr

3. When both fore/aft arrows are on, sweep tracker from side to side and use signal strength display to find lateral location of beacon (point A).
4. Step back until ghost is located (no arrows in center of clock face and low signal strength) and then move slightly forward until only one arrow is lit

(point B).

5. Press fore/aft/left/right button to switch to left/right arrows and sweep tracker back and forth until both left/right arrows are on.
6. Switch back to fore/aft arrows and move forward until both fore/aft arrows and target is lit.
7. Take depth estimate and mark spot.

## Remote Guidance Mode

Information is transmitted directly to display at drilling unit when tracker is in remote guidance mode. Approximate distance from tracker to beacon (not the estimated depth of the drill head) is shown every 5 seconds.

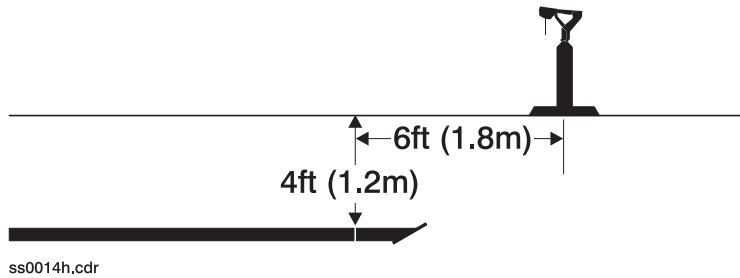

Distance will not be correct within one and a half times the drill head depth. For example, if you are drilling at 4' (1.2 m), you will be able to drill within 6' (1.8 m) of tracker.

To operate in remote guidance mode, place unit in stand while it is turned off. Press and hold mode button while pressing on/off button.

Tracker and drill head can be up to 60' (18.3 m) apart when in remote guidance mode. **IMPORTANT:** Do not drill past tracker.

## Remote Guidance Mode

Information is transmitted directly to display at drilling unit when tracker is in remote guidance mode. Approximate distance from tracker to beacon (not the estimated depth of the drill head) is shown every 5 seconds.

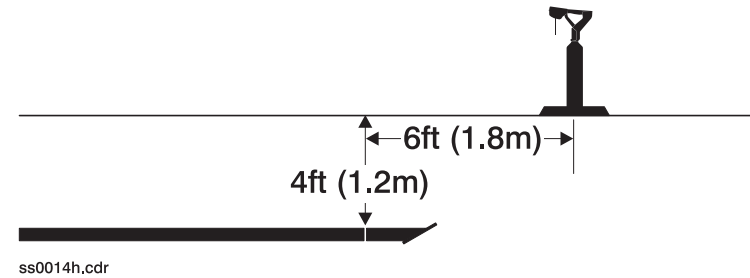

Distance will not be correct within one and a half times the drill head depth. For example, if you are drilling at 4' (1.2 m), you will be able to drill within 6' (1.8 m) of tracker.

To operate in remote guidance mode, place unit in stand while it is turned off. Press and hold mode button while pressing on/off button.

Tracker and drill head can be up to 60' (18.3 m) apart when in remote guidance mode. **IMPORTANT:** Do not drill past tracker.

## Displayed Information

Beacons send a variety of information to tracker. All Ditch Witch beacons send pitch, roll, temperature and battery information.

### Roll

Beacon roll information is useful in determining the direction that the drilling tool will tend to travel when pushed without rotation. The following chart shows typical tool face roll indications for directional drilling.

When beacon roll shows . . .	Drilling tool will move . . .
1 or 2 o'clock	up and right
3 o'clock	right
4 or 5 o'clock	down and right
6 o'clock	down
7 or 8 o'clock	down and left
9 o'clock	left
10 or 11 o'clock	up and left
12 o'clock	up

### Depth

To estimate beacon depth, press depth button. Estimated depth to beacon will be displayed. To change depth units, press depth and mode buttons.

All tracking and locating systems are subject to interference. To quickly check for interference, raise tracker 1' (0.3 m) and make second depth estimate. If the difference between the two estimates is not 1' (0.3 m), there is interference.

## Displayed Information

Beacons send a variety of information to tracker. All Ditch Witch beacons send pitch, roll, temperature and battery information.

### Roll

Beacon roll information is useful in determining the direction that the drilling tool will tend to travel when pushed without rotation. The following chart shows typical tool face roll indications for directional drilling.

When beacon roll shows . . .	Drilling tool will move . . .
1 or 2 o'clock	up and right
3 o'clock	right
4 or 5 o'clock	down and right
6 o'clock	down
7 or 8 o'clock	down and left
9 o'clock	left
10 or 11 o'clock	up and left
12 o'clock	up

### Depth

To estimate beacon depth, press depth button. Estimated depth to beacon will be displayed. To change depth units, press depth and mode buttons.

All tracking and locating systems are subject to interference. To quickly check for interference, raise tracker 1' (0.3 m) and make second depth estimate. If the difference between the two estimates is not 1' (0.3 m), there is interference.

**Pitch**

Tracker shows pitch (% grade) when used with beacons that provide this information (see specific beacon literature).

Pitch shows beacon grade in percentages from down arrow 99% (45 degrees down) to up arrow 99% (45 degrees up). Tracker displays this information to the left of roll display.

Grade beacons will send pitch in 0.1% increments from 1-45% and in 1% increments from 45-90%.

% of grade	Rise/drop US (metric)	% of grade	Rise/drop US (metric)	% of grade	Rise/drop US (metric)
1	1" (25 mm)	12	1' 2" (356 mm)	45	4' 1" (1.24 m)
2	2" (51 mm)	14	1' 5" (432 mm)	50	4' 6" (1.37 m)
3	4" (102 mm)	16	1' 7" (483 mm)	55	4' 10" (1.47 m)
4	5" (127 mm)	18	1' 9" (533 mm)	60	5' 2" (1.57 m)
5	6" (152 mm)	20	2' (610 mm)	65	5' 5" (1.65 m)
6	7" (178 mm)	24	2' 4" (711 mm)	70	5' 9" (1.75 m)
7	8" (203 mm)	28	2' 8" (813 mm)	75	6' (1.83 m)
8	10" (254 mm)	32	3' 1" (940 mm)	80	6' 3" (1.91 m)
9	11" (279 mm)	36	3' 5" (1.04 m)	90	6' 8" (2.03 m)
10	1' (305 mm)	40	3' 9" (1.14 m)	99	7' (2.13 m)

**Pitch**

Tracker shows pitch (% grade) when used with beacons that provide this information (see specific beacon literature).

Pitch shows beacon grade in percentages from down arrow 99% (45 degrees down) to up arrow 99% (45 degrees up). Tracker displays this information to the left of roll display.

Grade beacons will send pitch in 0.1% increments from 1-45% and in 1% increments from 45-90%.

% of grade	Rise/drop US (metric)	% of grade	Rise/drop US (metric)	% of grade	Rise/drop US (metric)
1	1" (25 mm)	12	1' 2" (356 mm)	45	4' 1" (1.24 m)
2	2" (51 mm)	14	1' 5" (432 mm)	50	4' 6" (1.37 m)
3	4" (102 mm)	16	1' 7" (483 mm)	55	4' 10" (1.47 m)
4	5" (127 mm)	18	1' 9" (533 mm)	60	5' 2" (1.57 m)
5	6" (152 mm)	20	2' (610 mm)	65	5' 5" (1.65 m)
6	7" (178 mm)	24	2' 4" (711 mm)	70	5' 9" (1.75 m)
7	8" (203 mm)	28	2' 8" (813 mm)	75	6' (1.83 m)
8	10" (254 mm)	32	3' 1" (940 mm)	80	6' 3" (1.91 m)
9	11" (279 mm)	36	3' 5" (1.04 m)	90	6' 8" (2.03 m)
10	1' (305 mm)	40	3' 9" (1.14 m)	99	7' (2.13 m)



## LINE LOCATING MODE

To locate power lines, select the following:

- line locating mode
- frequency (50 Hz power, 60 Hz power, or 8 kHz active)

**IMPORTANT:** Transmitter is required to locate 8 kHz.

### Setup

If you are locating a line with the help of a transmitter, connect transmitter as directed in transmitter operator's manual. Select frequency at transmitter to match tracker frequency.

### Location

To locate a line:

1. Sweep suspected area of line location.
2. Strongest signal indicates location of line.
3. Take depth reading.

## LINE LOCATING MODE

To locate power lines, select the following:

- line locating mode
- frequency (50 Hz power, 60 Hz power, or 8 kHz active)

**IMPORTANT:** Transmitter is required to locate 8 kHz.

### Setup

If you are locating a line with the help of a transmitter, connect transmitter as directed in transmitter operator's manual. Select frequency at transmitter to match tracker frequency.

### Location

To locate a line:

1. Sweep suspected area of line location.
2. Strongest signal indicates location of line.
3. Take depth reading.

## Troubleshooting

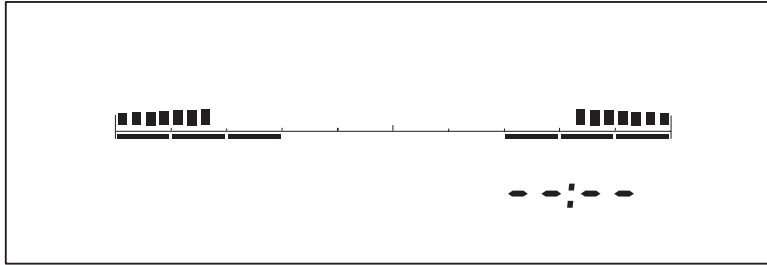

ss0013h.cdr

If four dashes appear in the display, signal appears to be above receiver and unit cannot estimate depth. This message is usually caused by interfering signals. Try relocating target signal.

## Troubleshooting

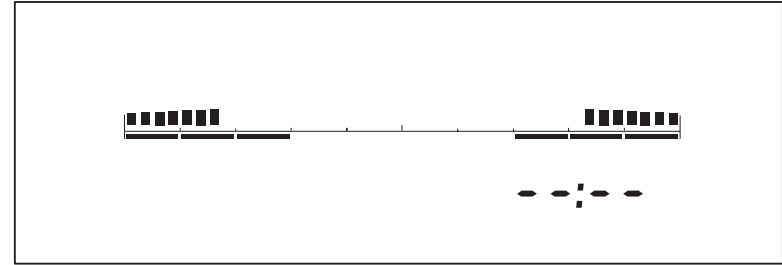

ss0013h.cdr

If four dashes appear in the display, signal appears to be above receiver and unit cannot estimate depth. This message is usually caused by interfering signals. Try relocating target signal.

## MAINTENANCE

### GENERAL CARE

The 750/752 tracker needs only minor maintenance under normal operating conditions. Following these care instructions can ensure longer equipment life.

- Do not drop the equipment.
- Do not expose the equipment to high heat (such as in the rear window of a car).
- Clean equipment with a damp cloth and mild soap. Never use scouring powder.
- Do not immerse in any liquid.
- Inspect housing daily for cracks or other damage. If housing is damaged, contact your Ditch Witch dealer for replacement.
- Protect LCD from sharp blows from hard objects.

## MAINTENANCE

### GENERAL CARE

The 750/752 tracker needs only minor maintenance under normal operating conditions. Following these care instructions can ensure longer equipment life.

- Do not drop the equipment.
- Do not expose the equipment to high heat (such as in the rear window of a car).
- Clean equipment with a damp cloth and mild soap. Never use scouring powder.
- Do not immerse in any liquid.
- Inspect housing daily for cracks or other damage. If housing is damaged, contact your Ditch Witch dealer for replacement.
- Protect LCD from sharp blows from hard objects.



## SPECIFICATIONS

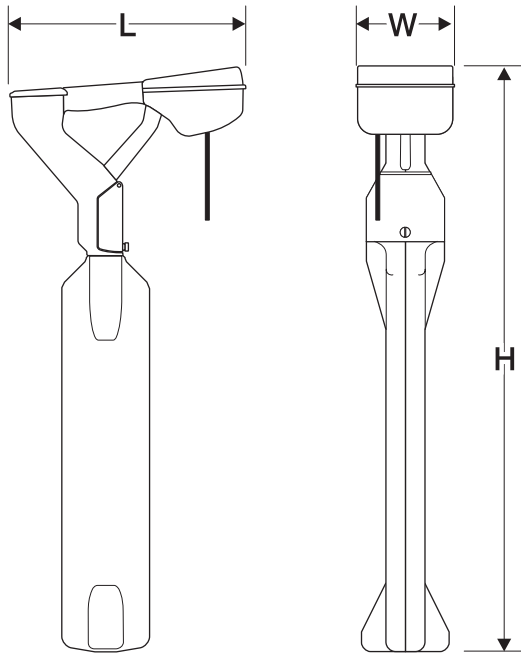

ss0008h.cdr

**Dimensions:**

Length: 12.75 in (32.4 cm)

Height: 31.5 in (80 cm)

Width: 6 in (15.2 cm)

**Operating Weight:** 5.5 lb (2.5 kg)**Operating Temperature Range:** -4°F to 122°F (-20°C to 50°C)

## SPECIFICATIONS

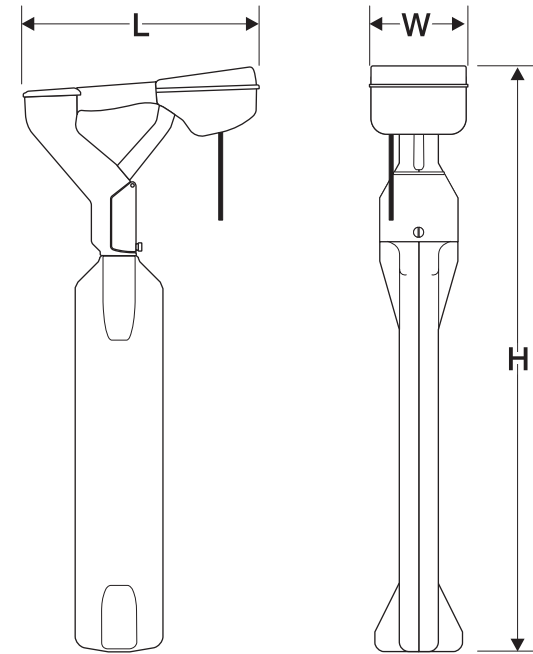

ss0008h.cdr

**Dimensions:**

Length: 12.75 in (32.4 cm)

Height: 31.5 in (80 cm)

Width: 6 in (15.2 cm)

**Operating Weight:** 5.5 lb (2.5 kg)**Operating Temperature Range:** -4°F to 122°F (-20°C to 50°C)

**Antenna Configuration:** peak

**Operating Modes:**

12K beacon  
 29K beacon  
 60 Hz power  
 50 Hz power  
 8 kHz line (active)

**Radio Frequencies**

750 - 2  
 752 - 9

**Maximum Locating Range:**

Beacon: 0.75 ft - 99 ft 11 in (22.9 cm - 30 m)  
 Line: 0-10 ft (0-3 m)

**Depth Calibration Tolerances \* :**

±4 in (10 cm) at 10 ft (3 m)  
 ±5% from 10-20 ft (3-6.1 m)  
 ±10% beyond 20 ft (6.1 m)

**Line Location Tolerances:**

Active mode: ±3% at 10 ft (3 m)  
 Passive mode: ±5% at 6 ft (1.8 m); ±10% at 10 ft (3 m)

**Batteries:** 6 C cell alkaline

**Battery Life \*\* :** approximately 20 hours

**Battery Saver:** unit shuts off after 5 minutes if no key is pressed

\* Units are calibrated to these tolerances under test field conditions. Actual field conditions may cause signal distortions or may contain noise sources which result in depth estimates that vary from these figures.

\*\* continuous use at 70°F (21°C)

**Antenna Configuration:** peak

**Operating Modes:**

12K beacon  
 29K beacon  
 60 Hz power  
 50 Hz power  
 8 kHz line (active)

**Radio Frequencies**

750 - 2  
 752 - 9

**Maximum Locating Range:**

Beacon: 0.75 ft - 99 ft 11 in (22.9 cm - 30 m)  
 Line: 0-10 ft (0-3 m)

**Depth Calibration Tolerances \* :**

±4 in (10 cm) at 10 ft (3 m)  
 ±5% from 10-20 ft (3-6.1 m)  
 ±10% beyond 20 ft (6.1 m)

**Line Location Tolerances:**

Active mode: ±3% at 10 ft (3 m)  
 Passive mode: ±5% at 6 ft (1.8 m); ±10% at 10 ft (3 m)

**Batteries:** 6 C cell alkaline

**Battery Life \*\* :** approximately 20 hours

**Battery Saver:** unit shuts off after 5 minutes if no key is pressed

\* Units are calibrated to these tolerances under test field conditions. Actual field conditions may cause signal distortions or may contain noise sources which result in depth estimates that vary from these figures.

\*\* continuous use at 70°F (21°C)

---

# WARRANTY

## Limited Product Warranty Policy

### Warranty Periods

#### New Product

A twelve-month period starts on the date of delivery to the end user:  
trackers, remote displays, receivers, transmitters, radars, fault finders

A six-month period starts on the date of delivery to the end user:  
directional and locate beacons

A three-month period starts on the date of delivery to the end user:  
accessories: cables, clamps, canoes, bags, and adapters

#### Used Product (Cosmetics)

A three-month warranty starts on the date of delivery to the end user on used and refurbished products sold from Ditch Witch dealers. Used products are non-returnable.

#### Service and Repair

A one-month warranty on **labor** starts on the date the unit is repaired, and a three-month warranty on **parts** starts on the date the unit is repaired for all products.

#### Extended Warranty

The extended warranty may be purchased at the time the equipment is sold or anytime within the original warranty period. The extension is for an additional twelve or twenty-four months, for a total coverage of twenty-four to thirty-six months. Exclusions: All beacons and accessories.

---

# WARRANTY

## Limited Product Warranty Policy

### Warranty Periods

#### New Product

A twelve-month period starts on the date of delivery to the end user:  
trackers, remote displays, receivers, transmitters, radars, fault finders

A six-month period starts on the date of delivery to the end user:  
directional and locate beacons

A three-month period starts on the date of delivery to the end user:  
accessories: cables, clamps, canoes, bags, and adapters

#### Used Product (Cosmetics)

A three-month warranty starts on the date of delivery to the end user on used and refurbished products sold from Ditch Witch dealers. Used products are non-returnable.

#### Service and Repair

A one-month warranty on **labor** starts on the date the unit is repaired, and a three-month warranty on **parts** starts on the date the unit is repaired for all products.

#### Extended Warranty

The extended warranty may be purchased at the time the equipment is sold or anytime within the original warranty period. The extension is for an additional twelve or twenty-four months, for a total coverage of twenty-four to thirty-six months. Exclusions: All beacons and accessories.

## Details and Exclusions

- The warranty includes only Ditch Witch products and accessories that are manufactured and distributed by Ditch Witch. The warranty compensates on defects in material or workmanship.
- Defects will be determined through inspection by Ditch Witch or authorized repair centers. Original purchaser must make the defective item available for inspection within 30 days of the date the part fails.
- The warranty is limited to replacement of the defective part. The replacement part may be new or remanufactured. Repair and installation of defective part will be at no charge when product or item is delivered to Ditch Witch or an authorized repair center. The product or item will be returned at no charge for return freight.
- The warranty periods do not represent the useful life of Ditch Witch products and accessories.
- If Ditch Witch products are purchased for commercial purposes, as defined by the Commercial Code, no warranties extend beyond the specific terms set forth in this limited warranty. All other provisions of this limited warranty apply, including duties imposed.
- Ditch Witch products have been tested to deliver acceptable performance in most conditions.
- This limited warranty applies to the original purchaser only. Some states or jurisdictions do not allow exclusion or limitation of incidental or consequential damages, so above limitation may not apply. This limited warranty gives original purchaser specific rights that vary from state to state or jurisdiction to jurisdiction.
- Each serial numbered piece of equipment must be registered by the selling dealer to establish the warranty start date.

## Details and Exclusions

- The warranty includes only Ditch Witch products and accessories that are manufactured and distributed by Ditch Witch. The warranty compensates on defects in material or workmanship.
- Defects will be determined through inspection by Ditch Witch or authorized repair centers. Original purchaser must make the defective item available for inspection within 30 days of the date the part fails.
- The warranty is limited to replacement of the defective part. The replacement part may be new or remanufactured. Repair and installation of defective part will be at no charge when product or item is delivered to Ditch Witch or an authorized repair center. The product or item will be returned at no charge for return freight.
- The warranty periods do not represent the useful life of Ditch Witch products and accessories.
- If Ditch Witch products are purchased for commercial purposes, as defined by the Commercial Code, no warranties extend beyond the specific terms set forth in this limited warranty. All other provisions of this limited warranty apply, including duties imposed.
- Ditch Witch products have been tested to deliver acceptable performance in most conditions.
- This limited warranty applies to the original purchaser only. Some states or jurisdictions do not allow exclusion or limitation of incidental or consequential damages, so above limitation may not apply. This limited warranty gives original purchaser specific rights that vary from state to state or jurisdiction to jurisdiction.
- Each serial numbered piece of equipment must be registered by the selling dealer to establish the warranty start date.



- 
- When a registration is not received, the Ditch Witch shipping date is used to establish the warranty period start date.
  - Product inspection and estimates may require that the unit be disassembled and tested.
  - Out-of-warranty inspection costs include labor accrued at the full labor rate plus return freight.
  - Approved out-of-warranty repair costs include parts, labor accrued at full labor rate, plus return freight.

Revision F, September 2006

- 
- When a registration is not received, the Ditch Witch shipping date is used to establish the warranty period start date.
  - Product inspection and estimates may require that the unit be disassembled and tested.
  - Out-of-warranty inspection costs include labor accrued at the full labor rate plus return freight.
  - Approved out-of-warranty repair costs include parts, labor accrued at full labor rate, plus return freight.

Revision F, September 2006