

TABLE OF CONTENTS

1.0 INTRODUCTION	3
2.0 SYSTEM DESCRIPTION	3
3.0 SWITCH SETTINGS	4
4.0 LED DEFINITIONS	10
5.0 POTENTIOMETER ADJUSTMENT.....	11
6.0 AUXILIARY CONNECTOR	12
7.0 SCREENS	13
7.1 Frame Field Display Area.....	14
8.0 TUNING.....	19
8.1 Jumper Setup	19
8.2 Group Addressing (VERY IMPORTANT).....	19
8.3 Slaving	19

1.0 INTRODUCTION

This document describes the procedures required to properly tune a Strata System with the TR4022 board. Many of the adjustments for the Strata are pre-tuned during the manufacturing test process therefore adjustments required in the field have been minimized.

Adjustments such as center frequency and sweep are preset for 8.2 Mhz operation. If the system is required to detect a different frequency tag the sweep range will need to be readjusted by the installer.

Once properly configured, if poor performance results, the CSE should direct their efforts toward finding the source of the interference in the environment. Several test signals are provided by the TR4022 board, which may be viewed on an oscilloscope. These signals allow the CSE to identify and measure ambient noise levels, resonances and other sources of environmental interference.

The DSP (digital signal processor) system automatically subtracts stationary resonances seen by the antennas. The system offers flexibility to adjust for these circumstances. However, the solution for environmental problems, is to determine the environmental problems and resolve them. The options for adjusting to environmental problems are performed both in the analog and digital realm by the technician. The analog solutions are reducing power on the transmit antennas (2-loop and/or 3-loop), reduce the baseband gain, and adjust the sweep. In the digital toolbox there are four user selectable filter parameters. These tools should be used only after the CSE has attempted to correct the environment.

The Strata system is powered by a +24Vdc power supply, P/N 121878. This power supply can power up to a maximum of three antennas.

2.0 SYSTEM DESCRIPTION

The Strata system is a transceiver design using both a 3-loop, 2-loop, and a 1-loop antenna design. The Strata alternates between using the 2-loop antenna and the 3-loop antenna. The 1-loop antenna is used as a shield that is tied to ground. This technique provides the system with different views of the detection field allowing the system to improve detection by minimizing the holes typically found at the crossbars of typical swept antennas.

During an antenna's cycle, the system performs two "blasts" which are called a "bin". There are sixteen bins per frame. A bin consists of two "noise" cycles and two blast cycles, a blast is a transmit cycle and then a receive cycle. During the noise cycle, the system is not transmitting, only receiving ambient noise. This allows the system to establish the baseline noise level of the environment for later comparison. The system then transmits or "pulses" the field and then receives or "listens" for an echo of a tag signal. This frame is repeated on the other antenna. A tag response need only be present on one of the antennas to cause an alarm. In effect the system provides the best of both worlds, a 2-loop and 3-loop design.

The switching between antenna loops minimizes the size of detection holes at the null points of the RF field.

3.0 SWITCH SETTINGS

Table 1 explains each of the jumpers on the TR4022 board and 4.0 explains the switches on the TR4022 board that must be configured before the system will operate. The illustrations on the next pages shows the position of the jumpers, switches, and potentiometers on the TR4022 board used during configuration. The top of the shield is held with 4 thumb turn screws. With the top of the shield removed all the switches can be set without removing the electronics from the antenna.

If for some reason the circuit board needs to be removed from the antenna housing, remove the three mounting screws from the backside of the board housing. Removing the rear cover of the antenna assembly can access them. Before completely removing the electronics package from the antenna loosen the screw near the TX1 and TX2 antenna connector and remove the spade lug. **MAKE SURE WHEN REINSTALLING THE ELECTRONICS PACKAGE THAT THE SPADE LUG FROM THE SHORTED TURN IS REINSTALLED IN THE SAME PLACE.**

Thumb screws for top cover

Spade lug for shorted turn attaches here

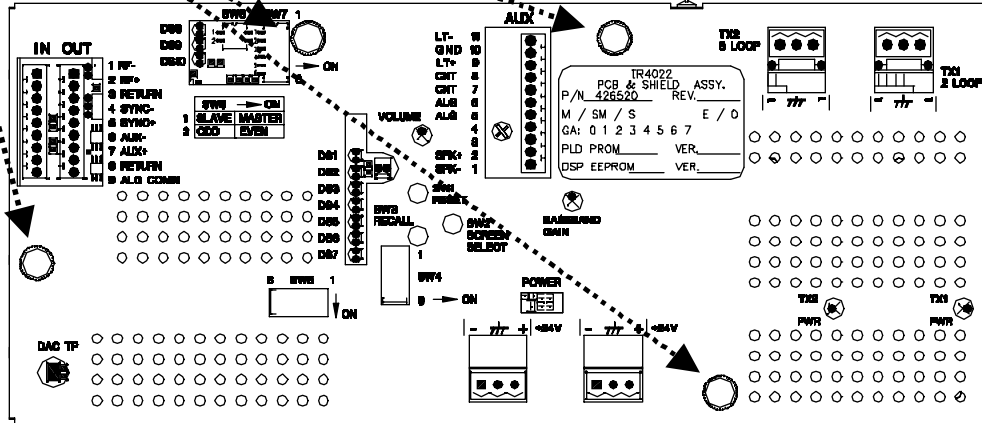

Slave In/Out Connections

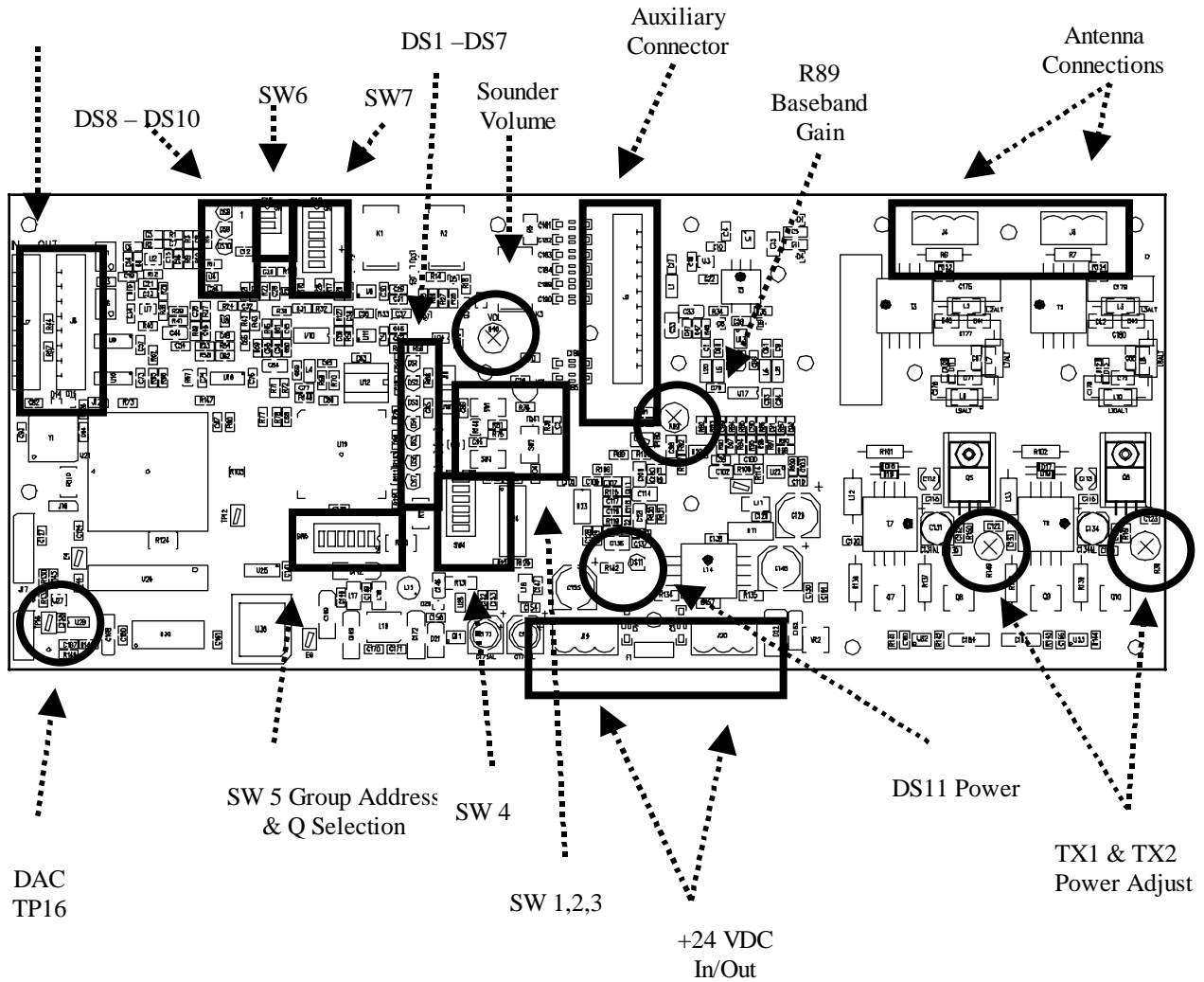

Table 1: Jumper Definitions

Jumper	Label	Function
J12	Alarm Group	On: Will allow all the alarm group relays to close when any pedestal within the group alarms. Off: Will not allow the alarm group signal to pass to the next pedestal.
J16	(NO LABEL)	Engineering Jumper.

The access panel must be removed to set all of the above jumpers

Table 2: Pushbutton Switch Definitions

Switch	Function
SW-1	Reset software
SW-2	Screen select.
SW-3	Screen recall.

Depressing SW2 repeatedly will allow you to toggle from Screen 1 thru Screen 7. The second pulse of the display found at the DAC test point TP16 identifies the screen being observed. See Screen 1 on page 11.

Depressing and holding SW3 will cause the display at the DAC test point TP16 to show the results of the last alarm for the screen being viewed.

Switch 4 – Bin Elimination, Filters, Transmitter setting and Alarm Cycle Select

Switch 4-1	OFF	ON	OFF	ON
Switch 4-2	OFF Band Edge Bins Eliminated	OFF High Band Bins Eliminated	ON Low Band Bins Eliminated	ON Full Band Detect No Bin Elimination
Switch 4-3	OFF	ON	OFF	ON
Switch 4-4	OFF A FILTER	OFF B FILTER	ON C FILTER	ON D FILTER
Switch 4-5	OFF – Software controlled transmitter feature disabled		ON - Software controlled transmitter feature enabled	
Switch 4-6	OFF - Short Alarm cycle		ON – Long alarm Cycle	

Switch 5 – System transmit address, Merchandise/Access Card Rejection

SW 5-3	SW 5-2	SW 5-1	Group Addressing	
OFF	OFF	OFF	Address 0	Strata '98 Compatible (200hz, sweep down)
OFF	OFF	ON	Address 1	100 Hz, jitter enabled, random sweep
OFF	ON	OFF	Address 2	100 Hz, jitter enabled, random sweep
OFF	ON	ON	Address 3	100 Hz, jitter enabled, random sweep
ON	OFF	OFF	Address 4	100 Hz, jitter enabled, random sweep
ON	OFF	ON	Address 5	100 Hz, jitter enabled, random sweep
ON	ON	OFF	Address 6	100 Hz, jitter enabled, random sweep
ON	ON	ON	Address 7	100 Hz, jitter disabled, linear sweep down (Reserved, Engineering mode)

Systems that are 'slaved' together **MUST** have the group addressing switches set to the same address. Conversely systems that are 'unslaved' but in close proximity must have unique addresses. Address 0 is reserved for compatibility with older (Strata '98) Strata systems and should not be used in other installations. Address 7 is reserved for observing the analog input signal.

SW 5-6	SW 5-5	SW 5-4	'Q' Band
OFF	OFF	OFF	All Tags - No M/A Rejection
OFF	OFF	ON	410/710 Tags (Merchandise Rejection)
OFF	ON	OFF	310/Access Card Rejection (Merchandise Rejection)
ON	OFF	OFF	Hard Tags (Merchandise Rejection)
ON	ON	ON	All Tags – (Merchandise Rejection)

Switch 6 – Master/Slave configuration

	ON	OFF
Switch 6-1	Master (generates and distributes RF and Sync)	Slave (system must receive Sync signal)

The Master/Slave switch controls how the system will handle the sync and rf signals in and out. A system **MUST** be in slave mode to use these input signals. In Master mode these signals must be absent (refer to ‘Sync and RF indicators’ section).

	ON	OFF
Switch 6-2	‘EVEN’ pedestal	‘ODD’ pedestal

The Even/Odd switch controls the transmit signal phase. This allows for a improved received signal in the weaker carries. For rf slaved systems this switch is alternately set even-odd-even-oddetc. For compatibility with older Strata systems ‘On’ is the same as having the Even/Odd link installed.

Switch 7 – Sweep range select

The Strata 99-4022 board introduces the digital synthesis of the sweep frequencies from a DDS chip. Without any test equipment the system can be setup without tuning for specific sweep ranges.

SW 7-1	SW 7-2	Upper Band Edge
Off	Off	No shift
Off	On	Shift down 200 kHz
On	Off	No shift
On	On	Shift up 200 kHz

SW 7-3	SW 7-4	Lower Band Edge
Off	Off	No shift
Off	On	Shift down 200 kHz
On	Off	No shift
On	On	Shift up 200 kHz

SW 7-5	SW 7-6	Center Frequency Range Select	Target
Off	Off	8.2 MHz (nominal 7.6-8.7 MHz)	8.2 tags
Off	On	8.6 MHz (nominal 7.8-9.4 MHz)	8.2 and 9.0 tags
On	Off	9.0 MHz (nominal 8.5-9.5 MHz)	9.0 tags
On	On	9.5 MHz (nominal 8.9-9.8MHz)	9.5 tags

4.0 LED DEFINITIONS

System Status Indicators

DS1 – Inhibit Indicator

This LED indicates that a condition exists that would prevent normal detection of a tag, typically excessive environmental noise. (At the end of an alarm cycle the inhibit LED will light momentarily)

DS2 – Alarm

This LED indicates the system is alarming (useful for when the sounder and lights are disconnected).

DS3 - Heartbeat

This LED indicates the system is operating normally. This LED blinks at an approximate 1 Hz rate. If the led is not blinking, it is a catastrophic failure and the board should be replaced.

DS4 – Transmitter Status

This LED indicates the ‘power’ level of the transmitter, this led is normally on. When the system detects an event above the alarm threshold it reduces the transmitter power output and extinguishes the led.

DS5, DS 6 – Spare

(During development DS5 indicates the status of the external sync on power up)

(During development DS6 indicates the status of the external rf on power up)

DS7 – Q Disqualification Indicator

This LED indicates the system has detected a resonance however the ‘Q’ of the resonance is either above or below the limits selected by the ‘Q’ qualification switches.

Internal and external Sync and RF indicators – DS8, DS9, and DS10

On power up or reset the system ‘reads’ the sync, rf, and switch status and configures the board appropriately. The configuration algorithm is as follows.

M/S Switch (SW 6-1)	External RF Source	External Sync Source	Condition	DS10 (Master) Green	DS9 (Sub-master) yellow	DS8 (Slave) Red
Master	Absent	Absent	OK – self generating sync and RF (system is a master)	On	Off	Off
Master	Absent	Present	ERROR	Off	Blink	Off
Master	Present	Absent	ERROR	Blink	Off	Off
Master	Present	Present	ERROR	Off	Off	Blink
Slave	Absent	Absent	ERROR	Blink	Blink	Blink
Slave	Absent	Present	OK – External sync and Self generating RF (system is a sub-master)	Off	On	Off
Slave	Present	Absent	ERROR	Blink	Blink	Blink
Slave	Present	Present	OK – External sync and External RF (system is a slave)	Off	Off	On

The system will not operate in any of the above ‘ERROR’ conditions. If an error condition is indicated the transmitter will be shut down and the system will not ‘pass through’ the sync pulse.

5.0 POTENTIOMETER ADJUSTMENT

The table below provides all of the adjustment pots on the TR4022 board along with their function and how to adjust each pot. The factory should set all of these pots and field adjustment should not be necessary.

Table 6: Definition of Adjustment Potentiometers

Label	Function	Proper Adjustment
TX1 PWR (R38)	2-loop Antenna Power (TX1)	DO NOT ADJUST HIGHER, SET BY FACTORY (to decrease power turn R38 clockwise)
TX2 PWR (R149)	3-loop Antenna Power (TX2)	DO NOT ADJUST HIGHER, SET BY FACTORY (to decrease power turn R149 clockwise)
BASEBAND GAIN (R89)	Baseband Gain	Usually set fully CW (maximum gain) Adjust for a maximum of 1.5V on screen 1
VOLUME (R46)	Sonalert Volume	Adjust to desired level (CW-increases volume)

6.0 AUXILIARY CONNECTOR

LABEL	PIN NUMBER	FUNCTION
LT- 11	11	Negative of lights
GND 10	10	Board ground (be very careful what is connected to this pin, so as not to create ground loops)
LT+ 9	9	Positive of lights
CNT 8 *	8	Relay normally open contact (closure upon alarm, same duration as lights)
CNT 7 *	7	Relay common contact
ALG 6 *	6	Relay normally open contact (triggered by alarm group, momentary closure)
ALG 5 *	5	Relay common contact
SPK+ 2	2	Positive of speaker
SPK- 1	1	Negative of speaker

7.0 SCREENS

Screen 1

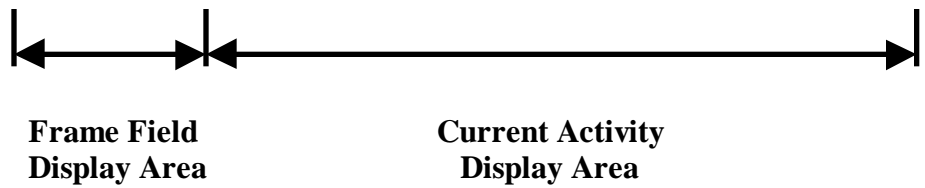
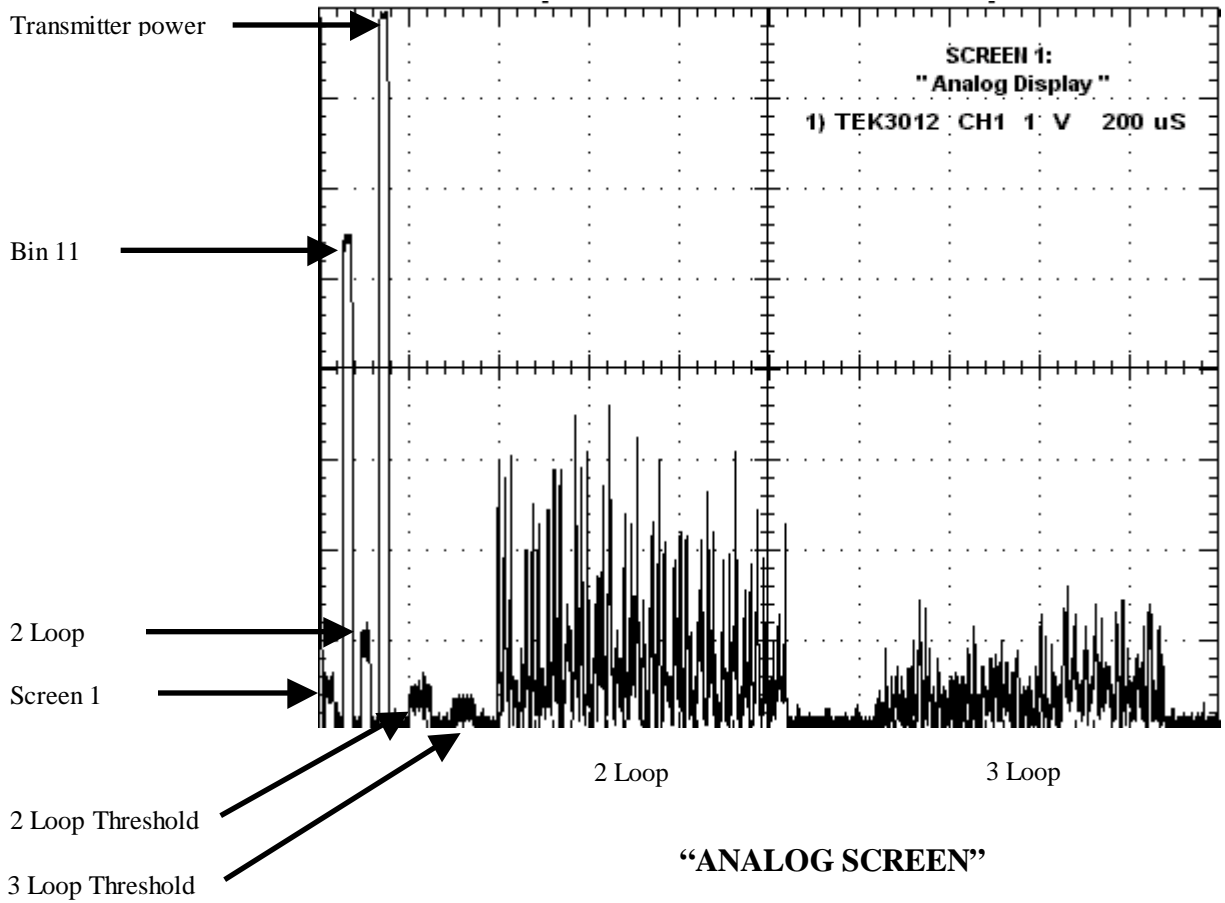

7.1 Frame Field Display Area

The first two horizontal divisions of **ALL** screen displays contains the following information:

(each vertical division has a value of 2 units)

Pulse 1 – Scope Trigger

Pulse 2 – Screen currently displayed (Previous page shows screen 1 being displayed)

Pulse 3 – Bin Number (Displays in which Bin the last alarm occurred)

Pulse 4 – Antenna (2 loop or 3 loop)

Pulse 5 – Transmitter Power Output (pulse at top of screen shows transmitter at full Power)

The remaining display is the **Current Activity Display Area** for that screen.

Screen 2

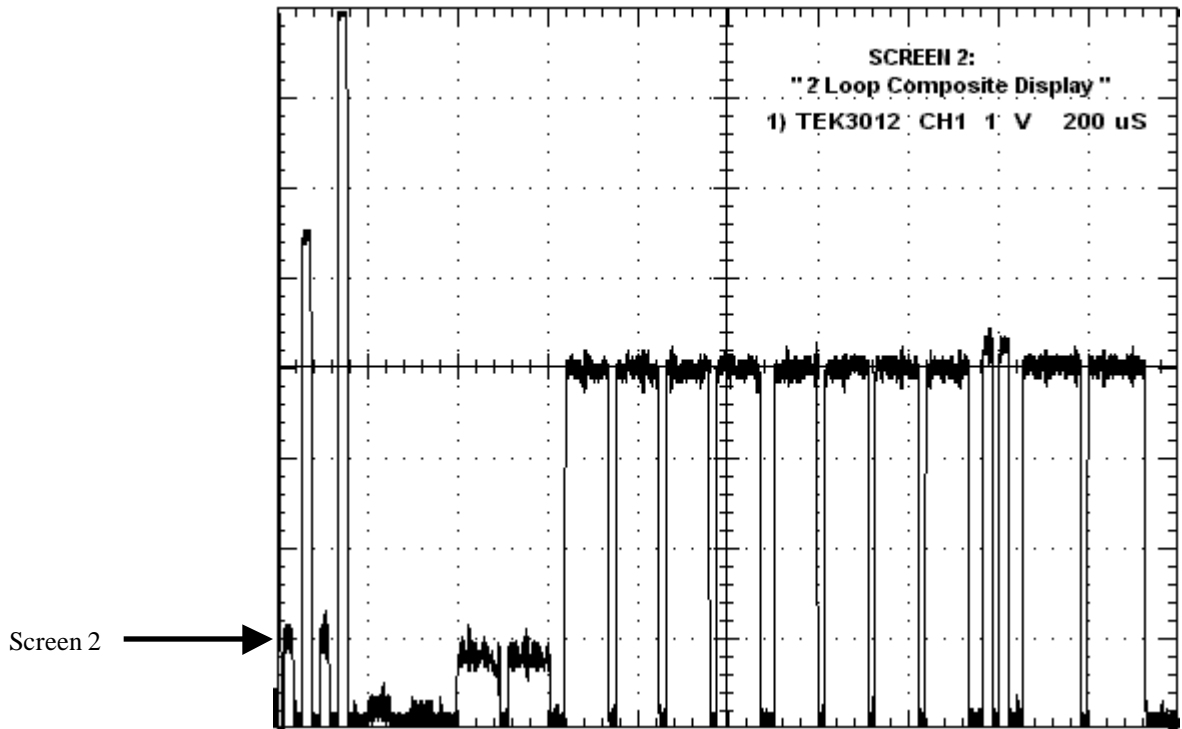

Similar to early Strata DAC output for the 2 loop

Screen 3

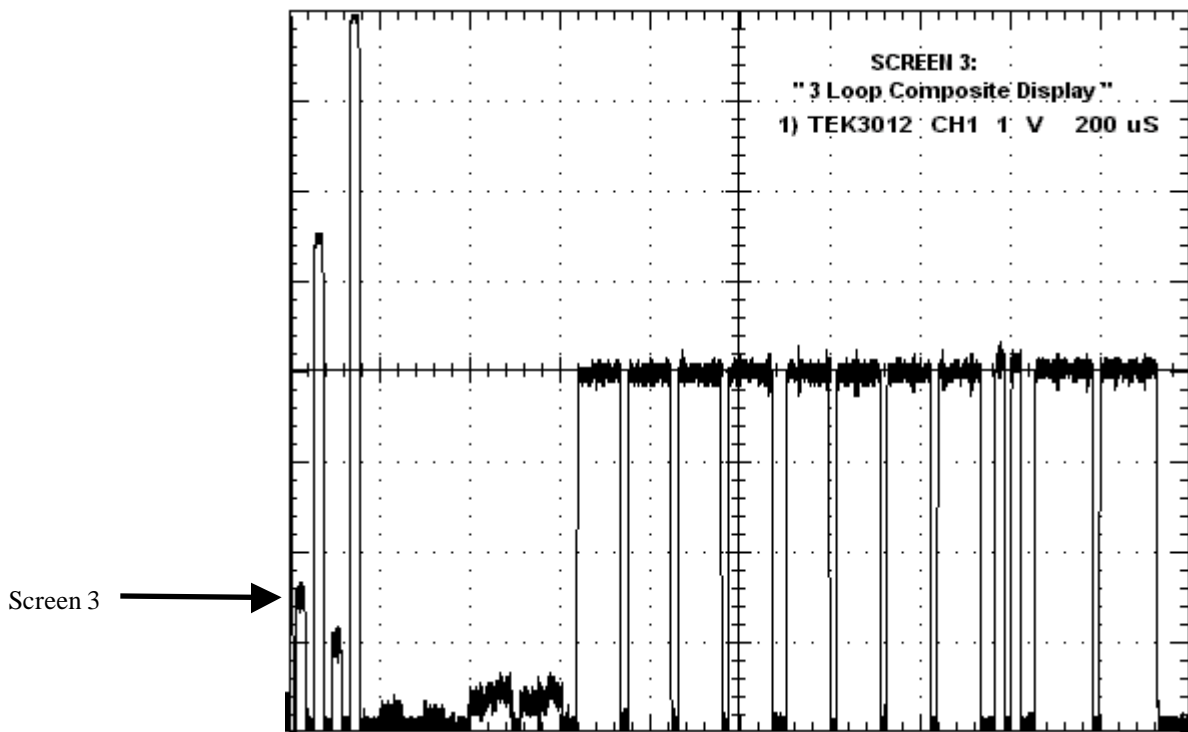

Similar to early Strata DAC output for the 3 loop

SCREEN 2 AND SCREEN 3 (DETAILED FORMAT)

Screen 2 and Screen 3 have similar formats providing further detail on their respective 2 Loop and 3 Loop DAC signals. Using Screen 2 as an example, the individual 2 Loop DAC signals are detailed below. The same format would apply for the 3 Loop DAC signals found on Screen 3.

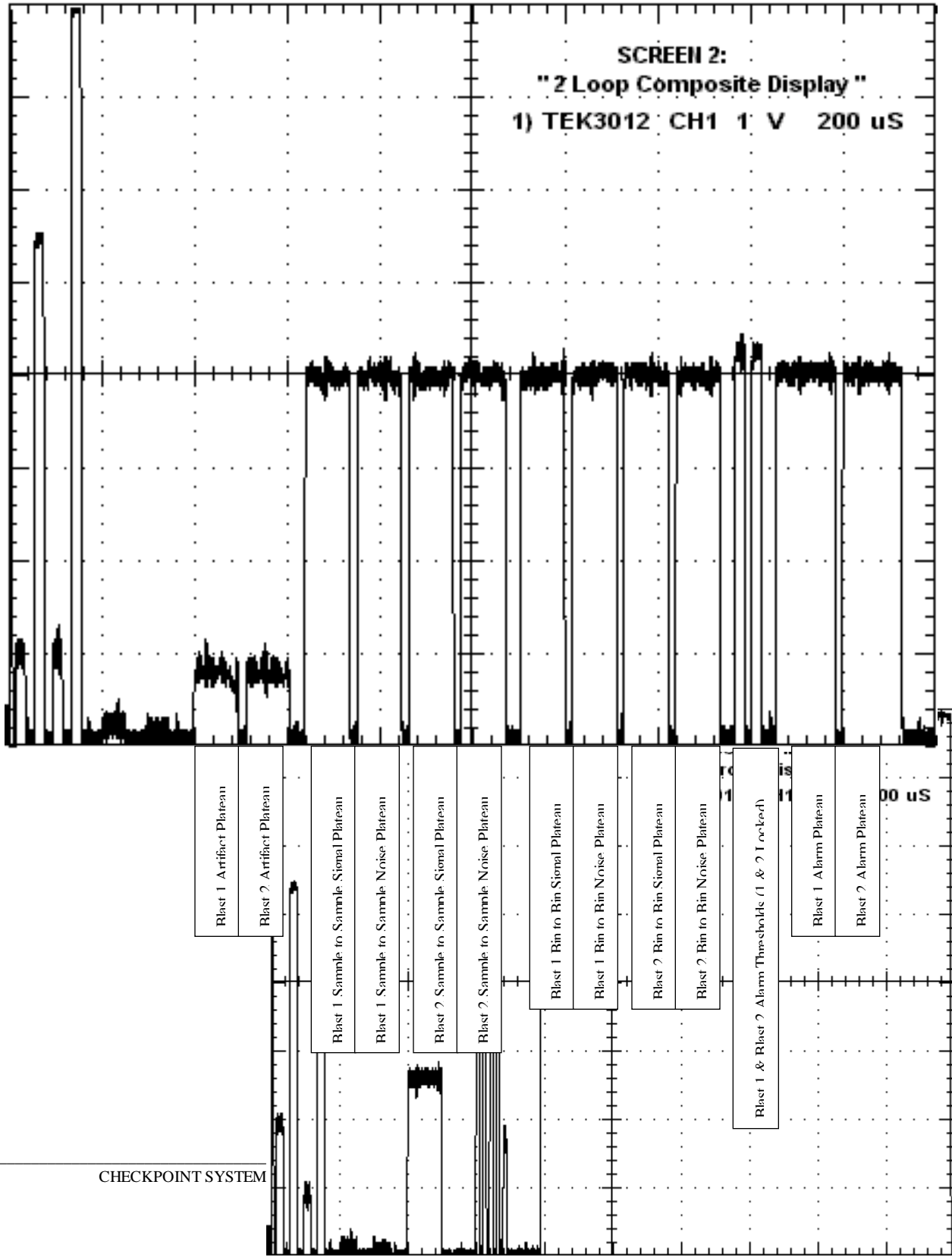

“Q” of last alarm event

“Q” Shape of last event

Screen 5 (Engineering Use)

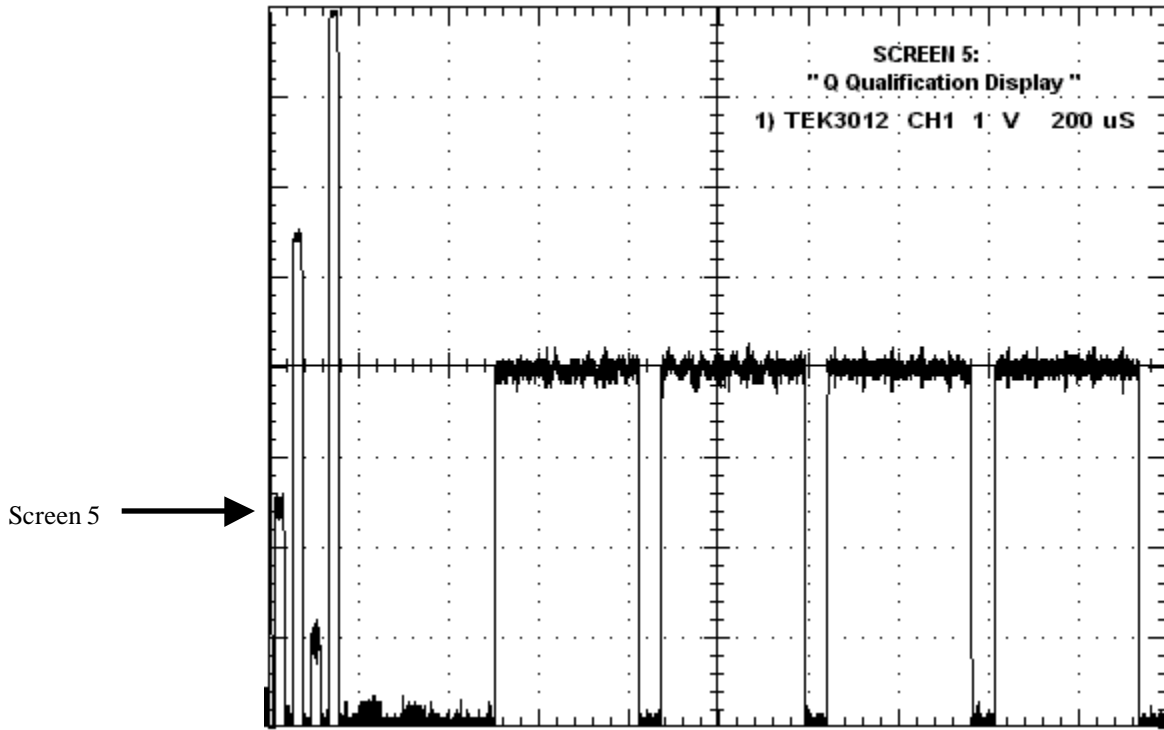

Live “Q” Qualification Display

Screen 6

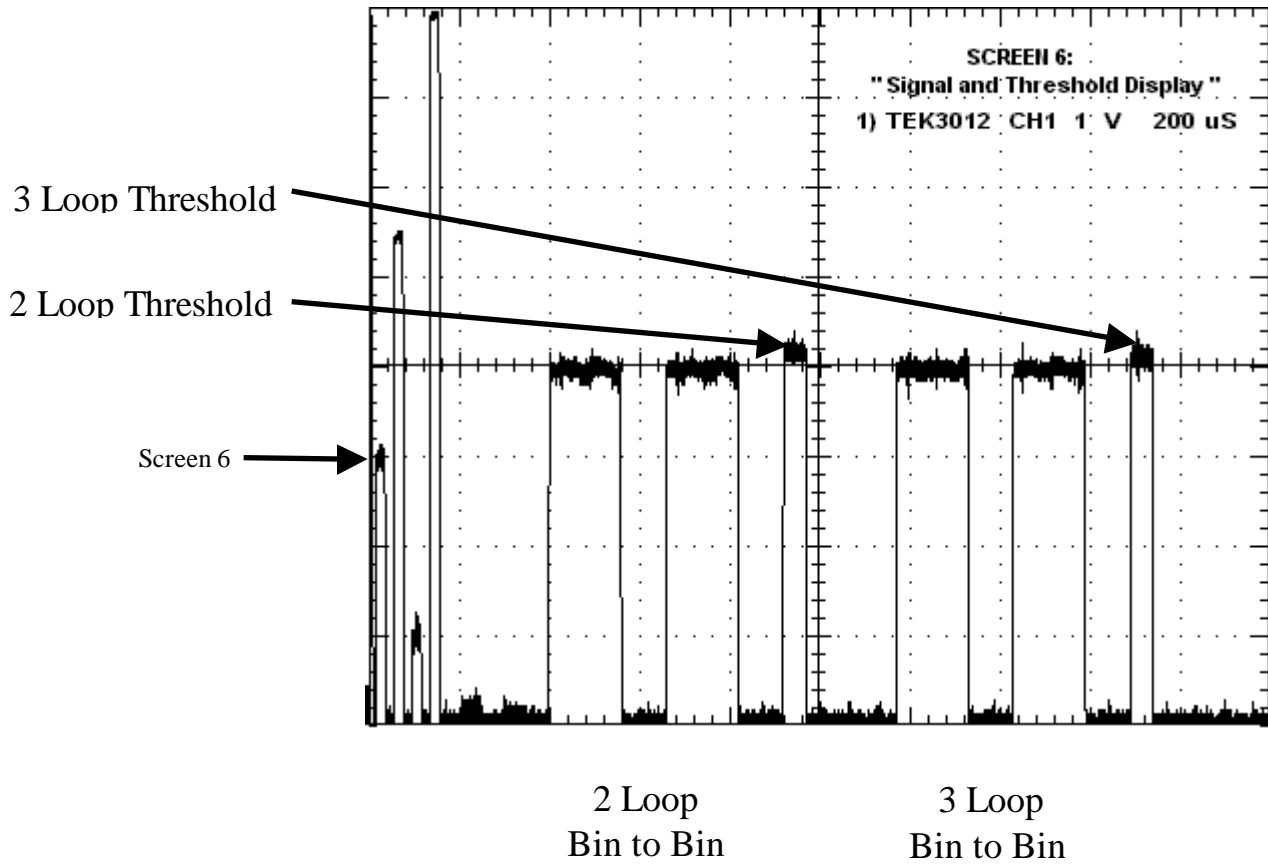

Screen 7

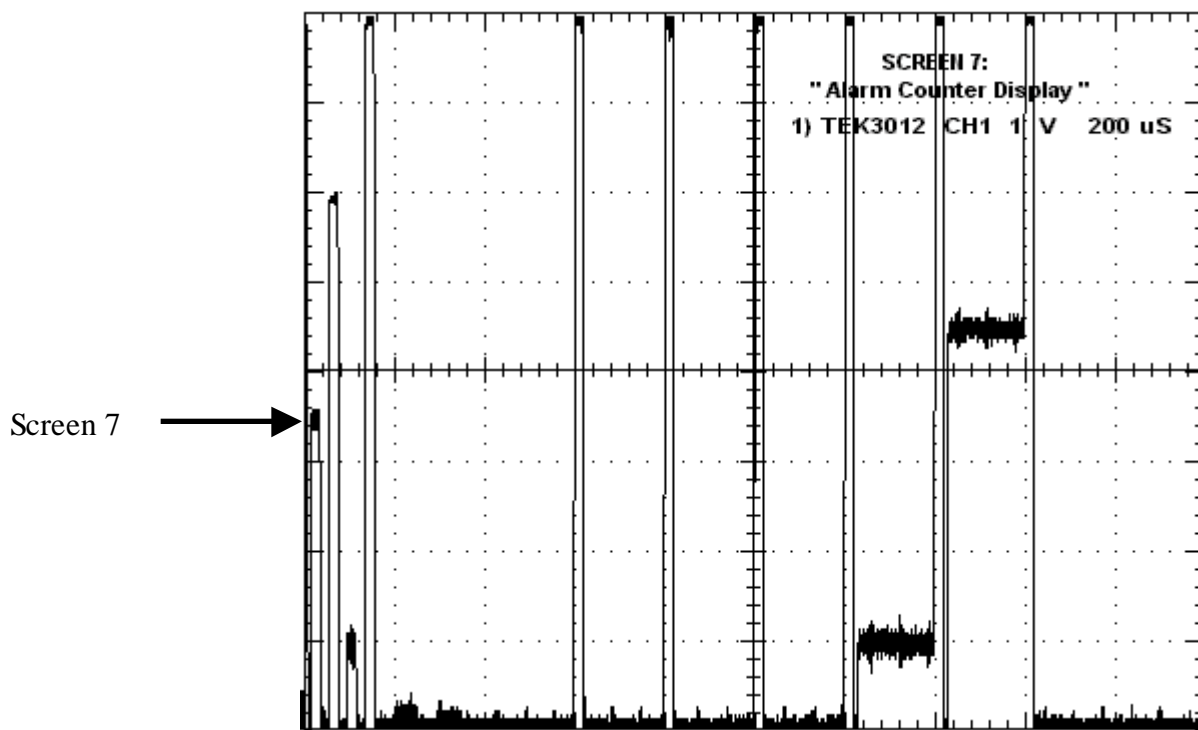

Alarm Counter Display (above shows 29)

8.0 TUNING

8.1 Master / Slave Setup

The first step in the process for tuning a Strata pedestal with the TR4022 board is to configure SW 6-1 according to how the pedestal is used in conjunction with other pedestals. Configure either as a Master (ON) , or Slave (OFF). See Switch 6 – Master/Slave configuration

8.2 Group Addressing (VERY IMPORTANT)

If the pedestal is working as part of a group of pedestals and connected together by the interpedestal cable, set the group address at SW5-1, 2, 3 the same for all the pedestals in the group. See Table 4. If a pedestal or group of pedestals is installed within 40’ of one another then they may have to be slaved. When slaving is required the group address for all the pedestals must be set the same.

8.3 Slaving

Slaving can be accomplished by attaching a two wire shielded cable with a drain wire to the OUT connector J8 terminals 4 & 5 (drain wire to terminal 3) on the last pedestal in the group to the IN connector J7 terminals 4 & 5 (drain wire to terminal 3) on the first pedestal of the next group. **NOTE: Polarity of the wires is important.**

Apply 24 VDC power and check that DS11 is illuminated. DS3 should also be flashing intermittently.

The transmitter output is preset at the factory and should not require adjustment.

Adjust the baseband gain potentiometer R89 for a noise level of less than 1.5V at Screen 1. This can be viewed by attaching an oscilloscope to the DAC test point TP16 and selecting Screen 1 by depressing SW2. Scope setting: 1V/DIV; 200uS/DIV.

While viewing Screen 1 check the sweep setting of the transmitter for the frequency of the tags being used. Standard retail systems are set to sweep from 7.6 – 8.7 Mhz. Using a Grid Dip Meter placed flat on the floor approximately 1.5 to 2 feet from the antenna check the sweep range by varying the frequency dial on the meter. The following illustrations will give you an idea of what the induced signal from the Dip Meter will look like at Screen 1.

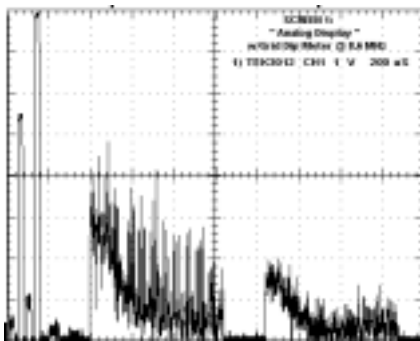

8.7 Mhz

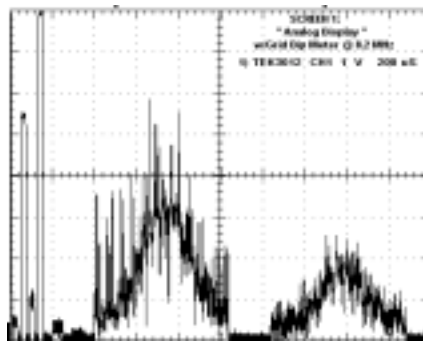

8.2 Mhz

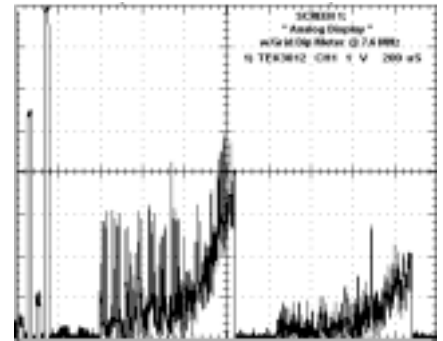

7.6 Mhz

Set the detection parameters at SW4-3 & 4 to OFF/OFF. This is the same as the ‘C’ filter on earlier Strata. If more filtering is required because of environmental influences see Table 3.

Set SW5-4, 5, 6 for the type of tags being used. See Table 4. All OFF has no ‘Q’ qualification and thereby will not defeat alarms caused by merchandise.

Set the volume of the Sonalert by adjusting potentiometer R46.

No other adjustments are required. Test the system with several of the customers’ tags to insure that the system is detecting properly. The sensitivity of the system may vary due to environmental influences and the selection of the filtering set by SW4-3 & 4.