

**Versatile Terminal for E-money systems**  
**VRW-06**

**User's Manual**

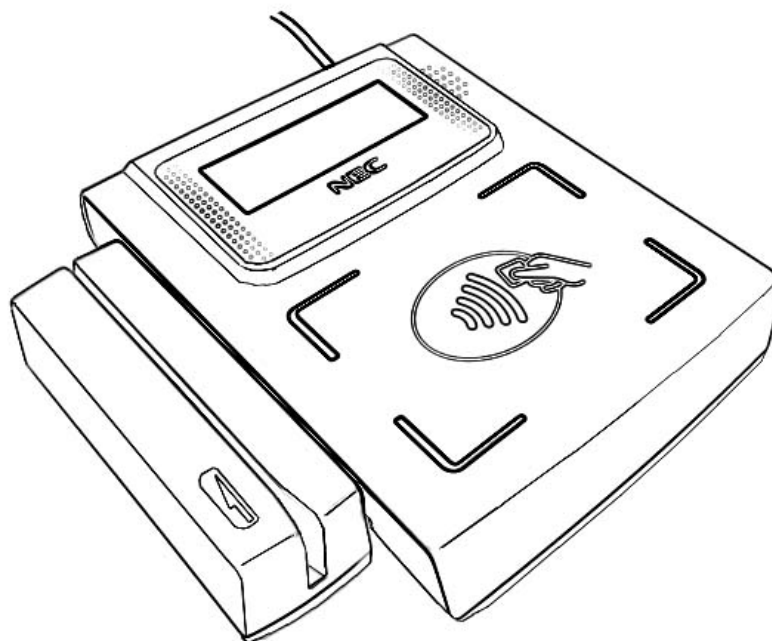
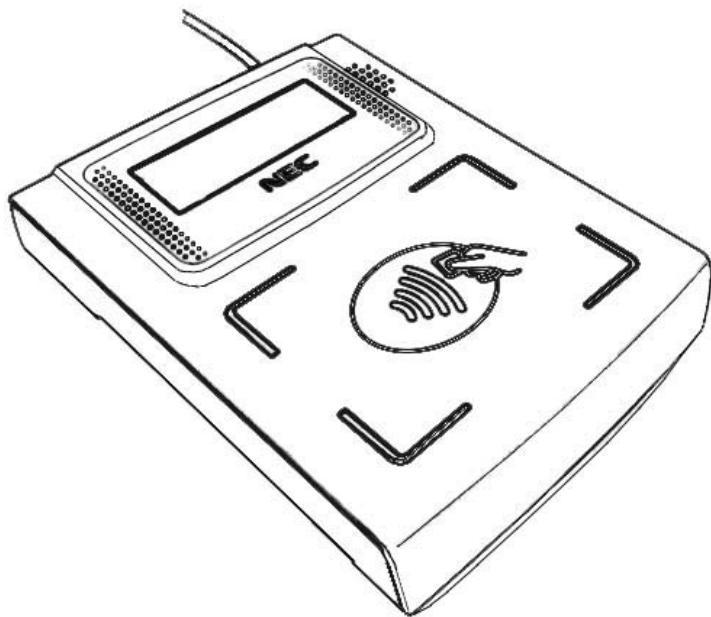

Thank you for purchasing "Versatile Terminal for E-money systems VRW-06"  
Read this manual carefully before using to confirm correct performance.

# Table of Contents

Introduction .....	2
Read This First .....	4
For Your Safety.....	5
1. Before Use.....	8
Accompanying Items.....	8
Parts and Functions Overview .....	9
2. How to use.....	10
How to connect with Host Terminal via USB.....	10
How to supply Power.....	10
How to use Contactless IC Card.....	11
How to use IC Card Reader .....	10
How to Use Magnetic Stripe Card Reader .....	13
3. Cleaning .....	14
Cleaning Product.....	14
4. How to insert/remove SAM card .....	15
How to insert/remove SAM card.....	15
5. Troubleshooting .....	17
6. Specification and Regulation.....	18

# Introduction

This manual explains basic functions and operations of Versatile Terminal for E-money systems VRW-06. Store this manual in a place where it can be referenced to whenever needed.

## **Copyright and Publishing Statements**

- This manual must not be reprinted in part or whole without permission.
- The contents of this manual are subject to change without notice.

## **Trademarks**

- Company names and product names, written in this manual, are registered trademarks of each said company.

## Federal Communication Commission Interference Statement

This device complies with Part 15 of the FCC Rules. Operation is subject to the following two conditions:

- (1) This device should not cause harmful interference,
- (2) It may receive interference from outside. Outside interference may cause undesired operation.

This equipment has been tested and found to comply with the limits of a Class B digital device, pursuant to Part 15 of the FCC Rules. These limits are designed to provide reasonable protection against harmful interference in a residential installation. This equipment generates, uses and can radiate radio frequency energy. If not installed and used in accordance with the instructions, may cause harmful interference to radio communications. There is no guarantee that interference will not occur in a particular installation. Interference can be determined by turning the equipment off and on. If this equipment causes harmful interference to radio or television reception, the user is encouraged to try to correct the interference by one of the following measures:

Reorient or relocate the receiving antenna.

- Increase the separation between the equipment and receiver.
- Connect the equipment into an outlet on a circuit different from that to which the receiver is connected.
- Consult the dealer or an experienced radio/TV technician for help.

### FCC Caution

Changes or modifications not expressly approved by the party responsible for compliance could void the user's authority to operate this equipment.

This transmitter must not be co-located or operating in conjunction with any other antenna or transmitter.

# Read This First

[About the Symbols]

The symbols and the equipment illustrations in this manual are for safe usage of the equipment. To prevent any harm to the customers, please note the symbols carefully. The symbols and their meanings are described below. Please make sure you are aware of the meanings of the symbols when reading this manual.

## Symbols in This Manual



**Warning**

Ignoring this symbol or mishandling this equipment may cause death or serious injury.



**Caution**

Ignoring this symbol or mishandling this equipment may cause injury or damage to the equipment.

**Reminder**

Ignoring this symbol or the mishandling of this equipment may cause malfunction or disable the equipment entirely.



**Prohibition**

Indicates prohibition.



**Do not Bring Close to Flames**

Indicates that the machine is too close to flames and it will catch fire.



**Caution**

Indicates danger.



**Electric Shock Risk**

Indicates the possibility of electric shock when being misused.



**Smoke and Fire Risk**

Indicates the probability of smoke or fire when it is handled incorrectly.



**Overheating Risk**

Indicates the possibility of failure caused by heat inside the equipment when handled incorrectly.



**Compulsory Action**

Indicates actions that must be taken

# For Your Safety

## Warning

---

### Away from Pacemaker

-  Persons with implanted cardiac pacemakers should be at least 22cm away from this equipment.

---

### Do Not Use in Prohibited Areas

-  Do not use this product near person using medical equipments such as cardiac pacemakers or hearing aids.

Electrical waves from this equipment are much lower than that of mobile phones. Effects on medical electric equipments are extremely low, but please follow the instructions of each medical institution when using this product. Do not use this product when it is forbidden by medical institutions. Even where it is allowed by medical institutions turn the power off if there is any medical electric equipment in use nearby. For more details, please contact medical institutions.



---

### Do Not Use in Airplane

-  Each airline company prohibits using radio and electric equipment according to flight conditions. This product belongs to a list of products that are restricted. For more details, please contact airline companies.



---

### Do Not Disassemble, Repair or Modify

-   Do not disassemble or modify this equipment. It may cause fire or electric shock. Ask your nearest retailer or maintenance service for internal inspection or repair.
- 



---

### Do Not Use When There is Smoke, Unusual Smell or Unusual Sound

-  When using this equipment, if you see smoke or smell an unusual odor, turn the power off immediately. These are signs of potential fire or electrical shock. Turn the power off immediately, and ask your nearest retailer or maintenance service for assistance. To avoid danger, do not repair the equipment by yourself.
- 

---

### Do Not Insert Wire or Metal

-   Do not insert foreign objects such as wire or metal into opening, such as the connector pins of the equipment. It may cause electric shock.

# For Your Safety

## Warning

### Keep Away from Fire



Do not use this equipment near gas or other flammable materials. It may cause fire or explosion.

### Do Not Touch with Wet Hands



Do not unplug the cable with wet hands. It may cause electric shock.

### Regarding Disposal



When disposing of this product, do not incinerate it or throw it into the fire. This may cause intense burning. Please contact your retailer when disposing of this product as it must be disposed of in a regulated manner.

## Caution

### Do Not Put any Liquid or Foreign Objects into the Equipment



Do not put any type of liquid or foreign objects, such as pins or paper clips, into the equipment. This may cause fire, electric shock, or breakdown. If this occurs, you must turn the machine off and contact your retailer immediately. Do not disassemble the equipment yourself.



### Do Not Place the Equipment in Dusty/Humid Area



Do not use the equipment in dusty or highly humid places. It may cause fire.

### Do Not Bend or Twist the Cables



Do not bend or twist the cables. A broken cable can cause fire or electric shock. Do not try to repair the cable even if it is damaged.



### Do Not Expose to Direct Sunlight



Do not leave the equipment or the power cable under direct sunlight or near appliances that generate heat. When the internal temperature of the equipment rises, it may not work correctly, and may cause fire.



### Do Not Place Near Appliances that Generate Radio Waves



Do not place the equipment near appliances that generate radio waves, such as security equipment. It may cause malfunction.

# For Your Safety

---

## Avoid Strong Shock



Avoid banging or dropping items such as canned goods or bottles on the reading surface of Contactless IC card reader. This action may cause damage to the equipment.

---

## Do Not Pour any Type of Liquid.



Do not pour any type of liquid such as water on the equipment. This action may cause electric shock or breakdown.

## Reminder

### Safety Precautions

- **Do not use the equipment in a place where the temperature change is extreme**

Temperature range of this product is 0-35 °C with a humidity level of 20-80% RH, non-bedewing condition. Do not place this equipment where temperatures or humidity exceed these levels.

- **Do not drop or apply shock**

This equipment can endure normal vibration and movements, however, please do not subject it to banging, dropping or violent vibrations.

- **Never disassemble or modify**

This equipment has high precision components that have been carefully adjusted, therefore, please avoid opening the main unit yourself unless you are simply inserting or removing the SAM card.

- **Cleaning**

Lightly wipe parts with a dry, lint-free cloth. Unplug the USB cable from the host machine. Unplug the AC Adapter from the main unit when in use. Malfunction or breakdown may occur if cleaned with the power on.

### Notes for Disposal

When disposing of this equipment, please follow your local regulations. For details, ask your retailer or contact your local government.



# 1. Before Use

## Accompanying Items

The following items are included with your Versatile Terminal for E-money systems kit. Please confirm all the items are in the package.

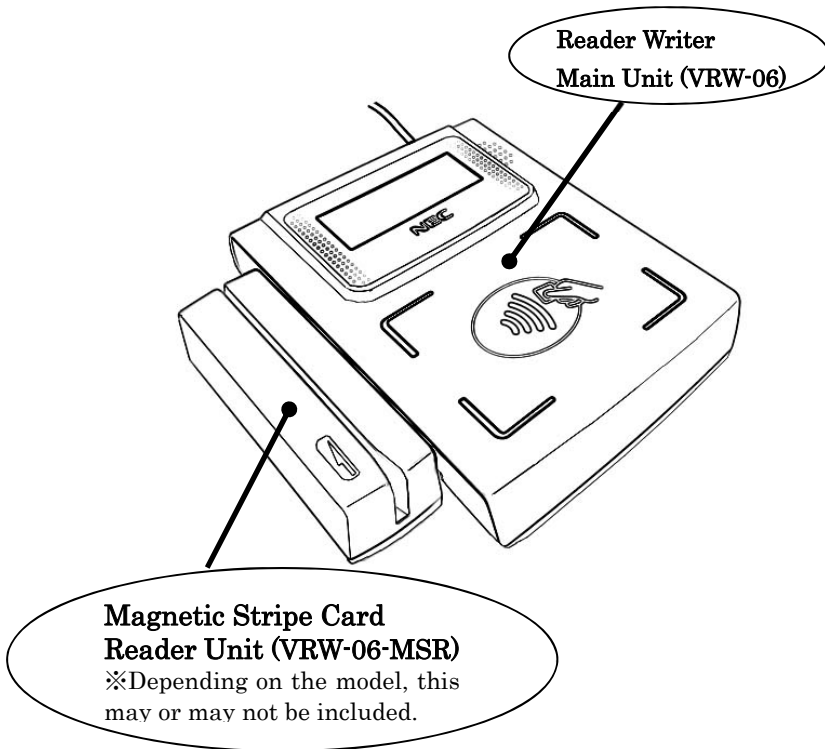

Main Unit

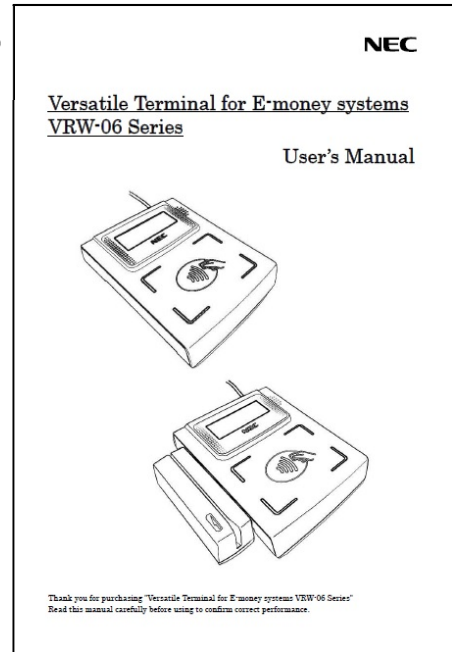

User's Manual (This book)

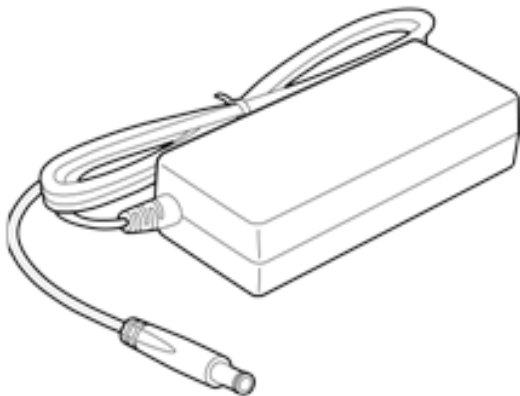

AC Adapter

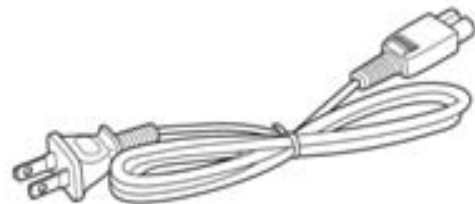

※The plug type may change due to the country of destination.

AC Cable

Please contact your retailer if there are any items missing or damaged.

## Parts and Functions Overview

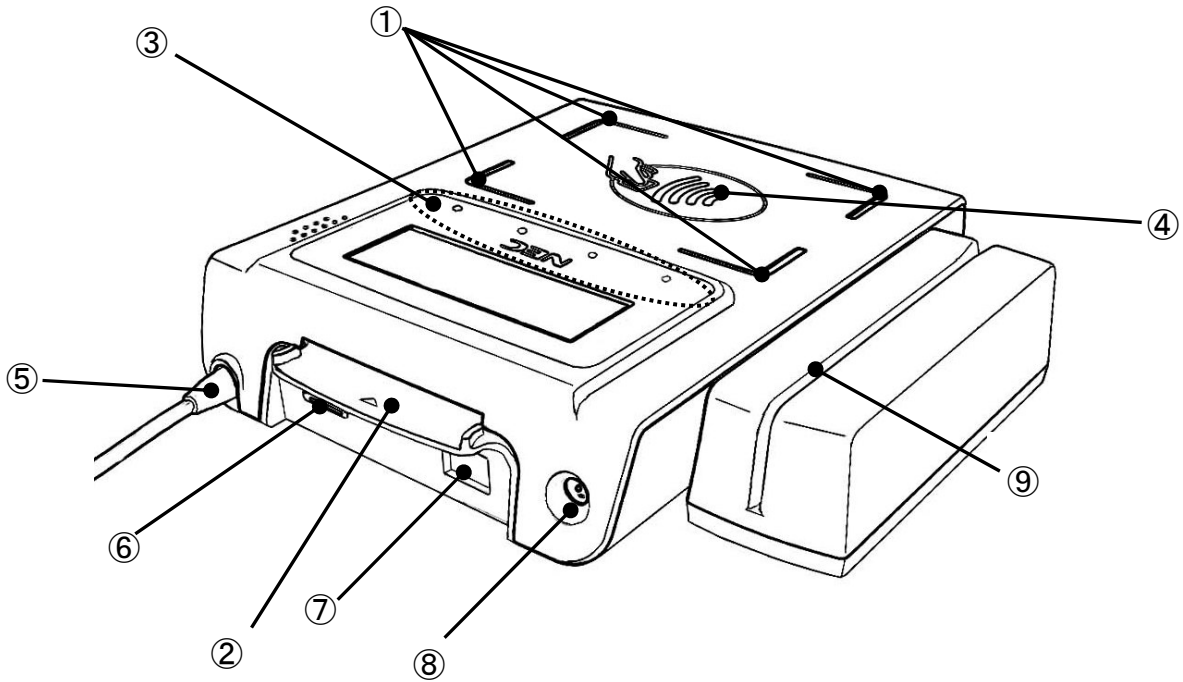

No.	Contents	Remarks
①	The four LED lights indicate the R/W conditions.	
②	The contact IC card is ready when it is inserted into this slot.	
③	The four LED lights indicate the R/W conditions.	The LED lights should be on.
④	The contactless IC card and the mobile phone are ready by tapping on this symbol.	
⑤	Use this part for interface with host equipment.	
⑥	Use this part when connecting to PINPAD.	
⑦	Use this part when connecting to host equipment and LAN cable.	
⑧	Connect the AC adapter here	
⑨	Swiping the magnetic stripe card through this part, reads the card.	Attached to VRW-06-02

## 2. How to use

### How to connect with a Host Terminal via USB

Please install and set up the driver on a host terminal before connecting.  
Please contact your retailer for more details.

Confirm the directions of the USB cable and connect it to the USB port of the host terminal. It is recommended to close all other applications when connecting to the host terminal.

This equipment has a branched USB cable. Please connect both cables to the USB ports of the host equipment. (Note1)

Note1) Please connect the USB cable to the host terminal after connecting to AC adapter.

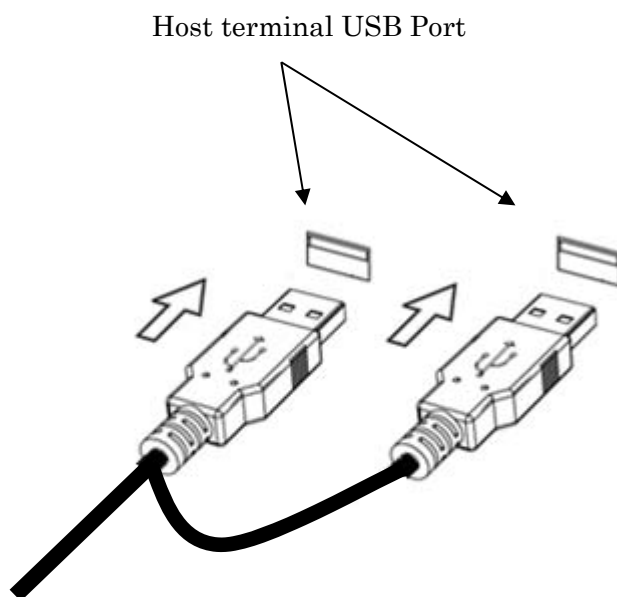

※ Please Confirm the direction of the top and bottom of the USB port.

### How to supply Power

Supply power from the AC adapter.

## How to use Contactless IC Card

You may use Contactless IC Cards and mobile phones that are equipped with the Contactless IC Card Function with this terminal.

### - How to read the Contactless IC Card

Cover and tap the Contactless IC symbol in the center of the card reader with the IC card.

### - How to read a mobile phone equipped with the Contactless IC Card Function

Cover and tap the Contactless IC symbol in the center of the card reader with the mobile phone.

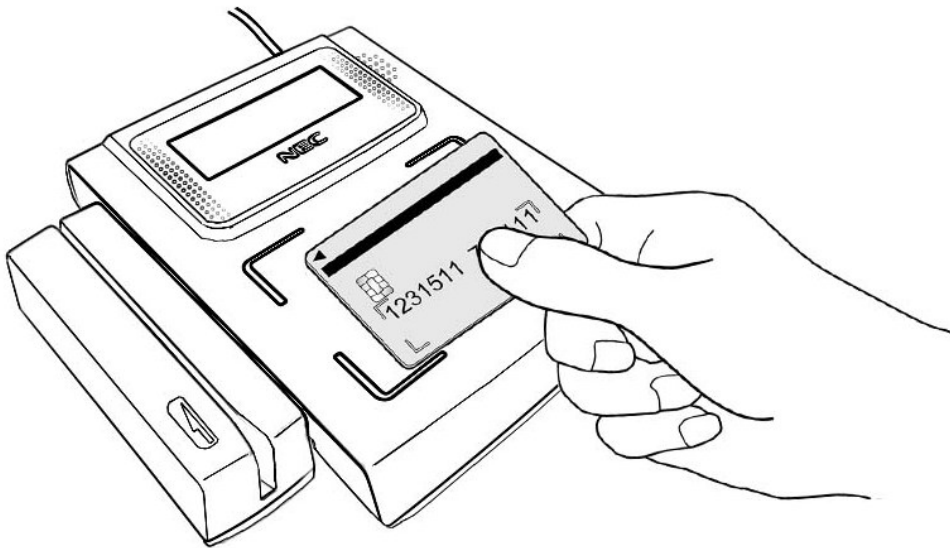

#### Reminder

- If the Contactless IC Card is in a wallet, take it out when in use.
- The Contactless IC Card cannot be read when placed upright.
- Do not put the IC Card on the top of another IC Card when using.
- Keep the card on the equipment until the transaction is completed.
- Do not press the Contactless IC Card down hard on the equipment.

## How to use IC Card Reader

You may use your Contact IC Card with this equipment.

### - How to insert the Contact IC Card.

Insert the Contact IC Card into the slot with the gold chip facing upward and pointing toward the insert direction until it is fully inserted.

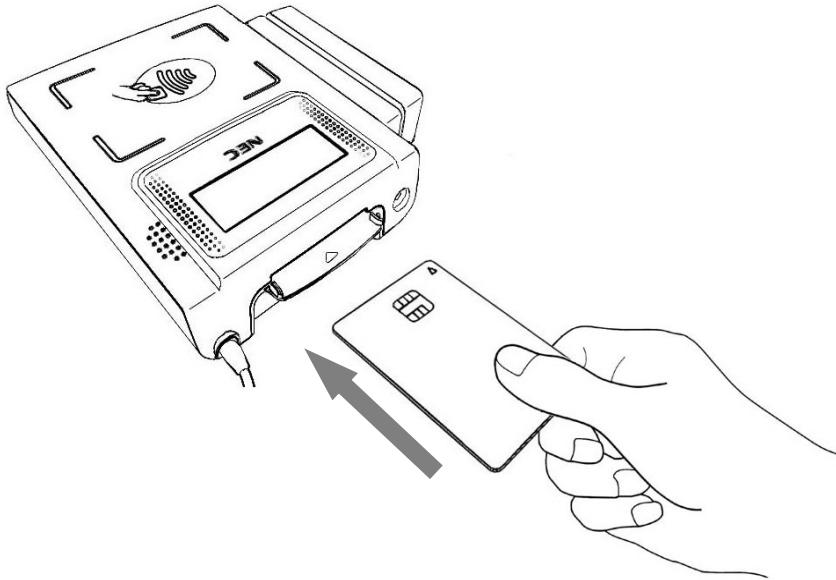

### - How to remove the Contact IC Card.

Remove the Contact IC card from the slot, horizontally.

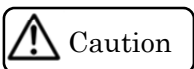
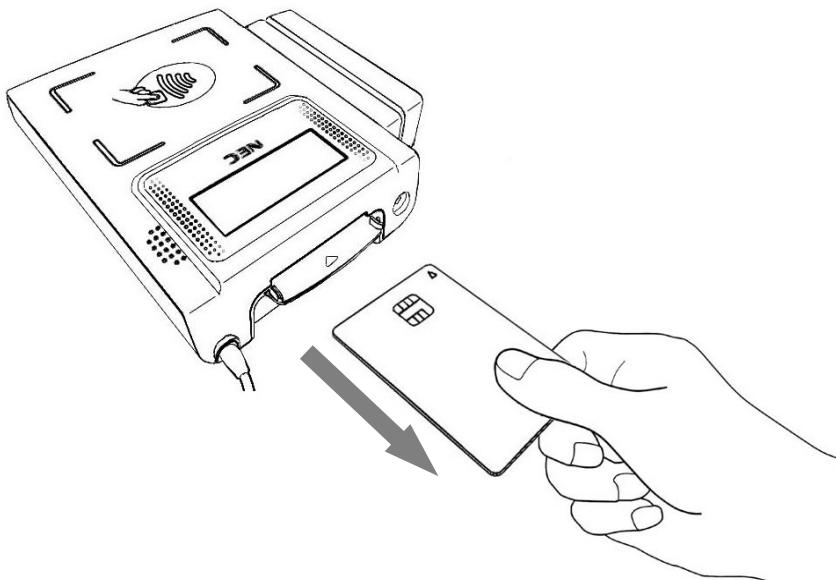

Caution

- When the card is not inserted fully, it is not possible to read properly.

## How to Use Magnetic Stripe Card Reader

With this equipment, you may use magnetic stripe card on the model which accompanies the magnetic stripe card reader unit.

### - How to Read the Magnetic Stripe Card Reader

Position the magnetic stripe card down and facing toward the main unit<sup>(Note1)</sup> and insert it into the end of the card reader slot then swipe it completely from one end to the other, as shown in the diagram below. Make sure to keep the swipe speed constant. Do not stop in the middle of the card or insert the Magnetic Strip Card in the middle of the slot. The card scanning standard speed range is 15-150cm/s.

Note 1) How to identify front side and back side of the Magnetic Stripe Card

The front surface of the card has embossed characters (stand out characters) and the characters can be read correctly from the front side.

If there are no embossed characters on the card, the front side has an arrow pointing left on the top left of the card.

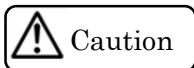

- If the card is not inserted fully when swiping, the reading will fail.
- If the card is swiped too fast or too slow, the reading will fail.
- Swipe the card thoroughly and do not stop in the middle.
- Customer information is registered on the Magnetic Stripe Card by magnetic recording process.
- The information may be lost if a magnet gets near the card.

# 3. Cleaning

## Cleaning the Product

Cleaning methods of the main unit and important notes.

### - Main Unit

For daily cleaning, use a soft, dry and clean cloth to wipe stains off.

For stubborn stains, use a soft, well squeezed wet cloth to wipe stains off.

#### Reminder

- Do not use volatile organic cleaners such as benzene, thinners etc. These products may cause deformation, discoloration or even breakdown of equipment.
- Unplug the USB cable from the host machine and the AC Adapter from the main unit before cleaning.

### - Contact Reader Writer

Periodically, clean the contact reader writer by using the specified cleaning card. (Note1)

### - Magnetic Stripe Card Reader

Periodically, clean the magnetic contact reader writer by using the specified cleaning card. (Note1)

Note 1) At the shop where you purchased this equipment you should be able to obtain a specified cleaning card.

# 4. How to insert/remove SAM card

## How to insert/remove SAM card

1. Turn your terminal over and take out the two screws with a screwdriver, as shown in the diagram below. You need a special screwdriver so please refer to the retailer with whom you purchased your terminal.

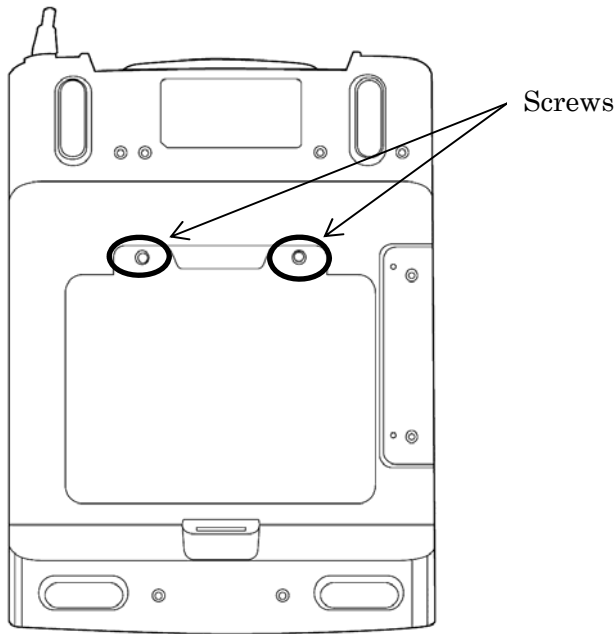

2. Remove the back panel.
3. Slide the SAM slot in the direction shown below and open it up.

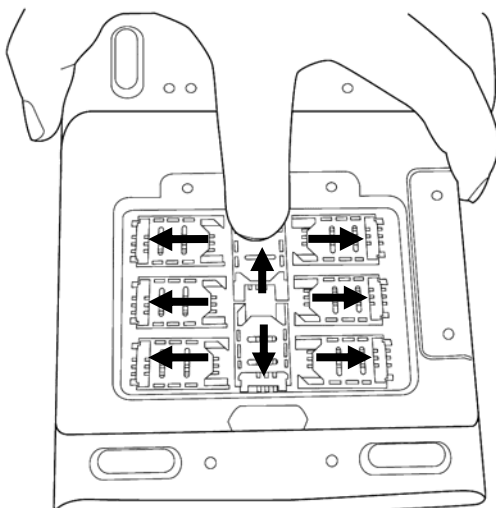



4. Insert the SAM card as shown below.  
(Position the notches and indentations in the correct direction.)

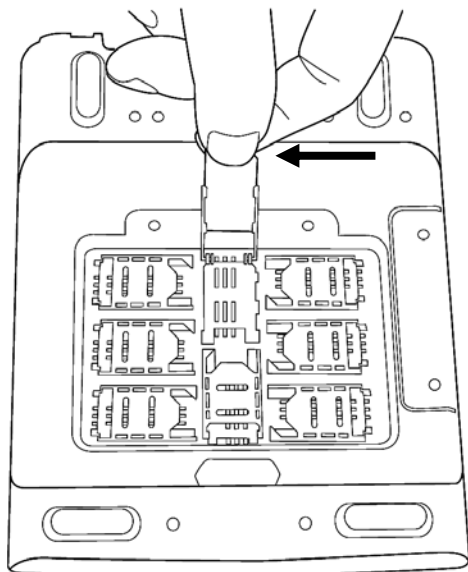

5. Close the SAM slot and slide it into place as shown below.

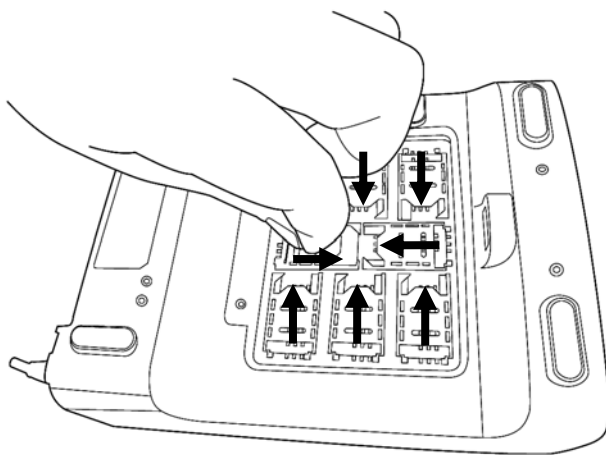

6. Return the back panel with the screws that were removed in step 1.  
That is all there is to inserting the SAM card.

※When removing a SAM card, always follow this procedure.

Reminder

• Do not open the back panel unless it is necessary.

# 5. Troubleshooting

If you have any trouble, refer to the solutions below.

<b>Troubles</b>	<b>Check point</b>	<b>Page</b>
The power does not turn on.	Check the AC Adapter connection.	P.11
Contactless IC Cards or mobile phones equipped with the Contactless IC Card Function cannot be read.	Please make sure you are placing the card or the mobile phone in the right spot.	P.12
The Contact IC Card cannot be read.	Please make sure the direction of insertion is correct, with the gold chip side of the card facing upward.	P.13
The Magnetic Stripe Card cannot be read.	Please make sure the direction of the Magnetic Stripe Card is correct.	P.14

# 6. Specification and Regulation

Item		Specifications	
Model name		VRW-06	VRW-06-MSR
Host Interface		USB2.0(Standard A)x2	—
		LAN	—
Contactless IC Card R/W module		ISO14443 Type A/Type B conformity	—
Contact IC Card R/W module		ISO 7816 EMV Level 1,2 conformity	—
LCD		9 Characters(18Bytes)x3 lines with backlight	—
Speaker		1W monaural	—
Indicator		LED × 4	—
Power Supply		AC Adapter	—
Dimensions		129.8(W) × 173.9(D) × 37.4(H) mm	164.9(W) × 173.9(D) × 37.4(H) mm (Include VRW-06)
Weight		About      g	About      g (Include VRW-06)
Operation Environment	Temperature	From 0 to 35 [°C]	—
	Humidity	From 20 to 80 [%]	—
Storage Environment	Temperature	From -20 to 40 [°C]	—
	Humidity	From 10 to 90 [%]	—
Magnetic Stripe Card Reader Unit		—	ISO 1,2,3 and JIS-2 conformity

Versatile Terminal for E-money systems VRW-06

User's Manual

1st edition, published in May, 2013

NEC Corporation

5-7-1, Shiba, Minato-Ku, Tokyo, Japan

Zip code: 108-0014

(81)3-3454-0011 (Representative)

NN-UBQ-QMSR13-0001