



成都亿佰特电子科技有限公司
Chengdu Ebyte Electronic Technology Co.,Ltd.

E32-TTL-100 Datasheet V1.0

1 . Introduction

E32-TTL-100

1.1 Feature

E32-TTL-100



E32-TTL-100 is a wireless transceiver module with LoRa spread-spectrum technology, operates at 434MHz, based on original imported RFIC SX1278 from SEMTECH, transparent transmission is available, TTL level. The module adopts LoRa spread-spectrum technology, which means the transmitting distance is much longer than before. The advantages of this module is more concentrated power density and better anti-interference performance.

The module features FEC (Forward Error Correction) algorithm, which ensure its high coding efficiency & good correction performance. In the case of sudden interference, it can correct the interfered data packets automatically, so that the reliability & transmission range are improved correspondingly. But without FEC, those date packets can only be dropped.

The module has the function of data encryption & compression. The data of the module transmit in the air features randomness. And with the rigorous encryption & decryption, data interception becomes pointless. The function of data compression can decrease the transmission time & probability of being interference, while improving the reliability & transmission efficiency.

1.2 Basic usage

E32-TTL-100

No.	Usage	Description
1	Transparent transmission	Default Module A transmits 01 02 03 to module B, then module B receives 01 02 03.
2	Fixed transmission	Module can communicate with other modules in different channels, easy for networking and repeater. Module A transmits AA BB CC to module B (address: 0x00 01, channel: 0x80), HEX format is 00 01 80 AA BB CC (00 01 refers to the address of module B, 80 refers to the channel of module B), then module B receives AA BB CC (only module B).
3	Broadcast transmission	Set the module address as 0xFFFF, then the module can communicate with other modules in same channel.
4	Power-saving	In power-saving mode, the module' s maximum receiving response time is 2000ms, which the average current is below 50uA.
5	Sleep	When the module works in sleep mode, transmitting & receiving is not available, while the configuration is available. The typical current is 2.0uA in this mode.
See more details in related manual about fixed transmission and broadcast transmission.		

1.3 Electrical parameter**E32-TTL-100**

No.	Parameter item	Parameter details & Description
1	Size	21 * 36mm, Without antenna and SMA
2	Frequency Band	434MHz
3	Connector	1*7*2.54mm Plug-in
4	Supply voltage	2.3 - 5.5V DC Note: the voltage higher than 5.5V is forbidden
5	Communication level	UART, USART
6	Operation Range	About 3000m Test condition : clear and open area& maximum power , height:> 2m , air date rate: 2.4kbps
7	Transmitting power	Four optional level (0-3) , step by 3dB
8	Air data rate	Default 2.4kbps Can be configured to 0.3、 1.2、 2.4、 4.8、 9.6、 19.2kbps
9	Standby current	2.0uA M1=1,M0=1 (Mode 3)
10	Transmitting current	110mA
11	Receiving current	14.5mA (Mode 0 or Mode 1) Minimum 30uA (Mode 2 + 2s wake-up time)
12	Communication interface	UART , 8N1、 8E1、 8O1 , Eight kinds of UART baud Rate, from 1200 to 115200 bps
13	Driving mode	UART can be configured to push-pull/high pull, open-drain
14	Transmitting length	512 bytes buffer , 58 bytes per package
15	Receiving length	512 bytes buffer , 58 bytes per package
16	Address	65536 configurable addresses Easy for network, broadcast and fixed transmission
17	RSSI support	Built-in intelligent processing
18	Sensitivity	-130dbm@0.3kbps Sensitivity has nothing to do with serial baud rate and timing
19	Antenna type	SMA-K External thread hole, 50 ohm impedance
20	Operating temperature	-40 ~ +85°C
21	Operating temperature	10% ~ 90%
22	Storage temperature	-40 ~ +125°C

2 . Functional description

E32-TTL-100

2.1 Pin definition

E32-TTL-100

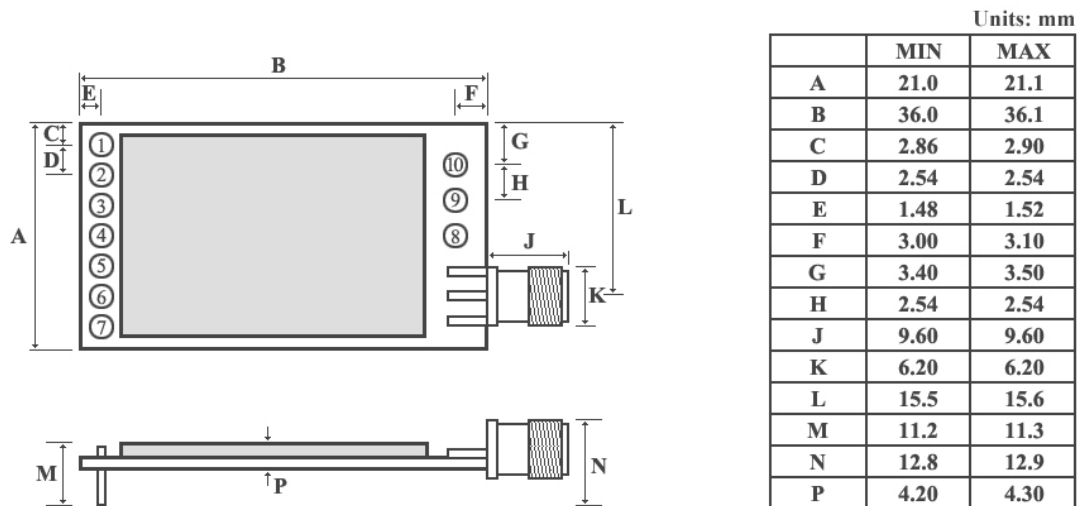

Pin No.	Pin item	Pin direction	Pin application
1	M0	Input (weak pull-up)	Work with M1 & decide the four operating modes. Floating is not allowed, can be ground.
2	M1	Input (weak pull-up)	Work with M0 & decide the four operating modes. Floating is not allowed, can be ground.
3	RXD	Input	TTL UART inputs, connects to external (MCU, PC) TXD output pin. Can be configured as open-drain or pull-up input.
4	TXD	Output	TTL UART outputs, connects to external RXD (MCU, PC) input pin. Can be configured as open-drain or push-pull output
5	AUX	Output	To indicate module' s working status & wakes up the external MCU. During the procedure of self-check initialization, the pin outputs low level. Can be configured as open-drain output or push-pull output (floating is allowed).
6	VCC		Power supply 2.3V-5.5V DC
7	GND		Ground
8	Fixing hole		Fixing hole
9	Fixing hole		Fixing hole
10	Fixing hole		Fixing hole
★★★ E32-TTL-100 can be compatible with other E32 series. ★★★			

2.2 Connect to MCU

E32-TTL-100

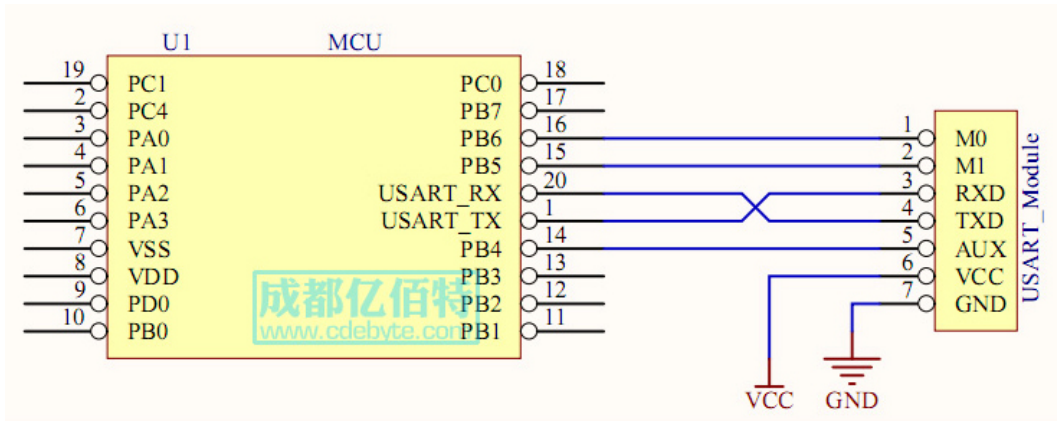

No.	Description (STM8L MCU)
1	The UART module is TTL level.
2	For some MCU works at 5VDC, it may need to add 4-10K pull-up resistor for the TXD & AUX pin.

2.3 Reset

E32-TTL-100

No.	Description
1	When the module is powered, AUX outputs low level immediately, conducts hardware self-check and set the operating mode on the basis of the user parameters. During the process, the AUX keeps low level. After the process completes, the AUX outputs high level and starts to work as per the operating mode combined by M1 and A0. Therefore, the user needs to wait the AUX rising edge as the starting point of module' s normal work.

2.4 AUX description

E32-TTL-100

AUX Pin can be used as indication for wireless send & receive buffer and self-check. It can indicate whether there are data that are yet to send through wireless, or whether all wireless data has sent through UART, or whether the module is still in the process of self-check initialization.

No.	Description
1	<p>[Indication of UART output] can be used to wake up external MCU.</p> <p>Timing Sequence Diagram of AUX when TXD pin transmits</p> <p>0- RXD</p> <p>1- TXD</p> <p>2- AUX</p> <p>I1: -5.1733ms</p> <p>I2: -3.1434ms</p> <p>[T1-T2]: 2.0299ms</p>

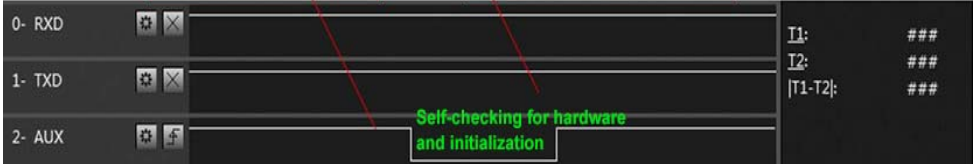
<p>2</p>	<p>【Indication of wireless transmitting】</p> <p>Buffer (empty): the internal 512 bytes data in the buffer are written to the RFIC (Auto subpackage). When AUX=1, the user can input data less than 512 bytes continuously without overflow.</p> <p>Buffer (not empty): when AUX=0, the internal 512 bytes data in the buffer have not written to the RFIC completely. If the user starts to transmit data at this circumstance, it may cause overtime when the module is waiting for the user date, or transmitting wireless subpackage.</p> <p>Notes: When AUX = 1, it does not mean that all the UART data of the module have been transmitted already, perhaps the last packet of data is still in transmission.</p> <div style="border: 1px solid black; padding: 5px; margin: 10px auto; width: fit-content;"> <p>Subpackage transmitting : the last package of data have been written to the RFIC. When transmission is on, user can continue to input 512 new bytes. (The buffer is actually empty.)</p> </div>  <p style="text-align: center;">Timing Sequence Diagram of AUX when RXD pin receives</p>
<p>3</p>	<p>【Configuration procedure of module】</p> <p>Only happened in the process of power-on and exit sleep mode.</p> <div style="border: 1px solid black; padding: 5px; margin: 10px auto; width: fit-content;"> <p>The self-check procedure happens when the procedure of power-on reset, instruction reset and exit mode 3.</p> </div> <div style="border: 1px solid black; padding: 5px; margin: 10px auto; width: fit-content;"> <p>Normal operation after self-check</p> </div>  <p style="text-align: center;">Timing Sequence Diagram of AUX when self-check</p>

No.	Notes for AUX
1	For function 1 & function 2 mentioned above, the priority should be given to the one with low level output, which means if it meets each of any low level output condition, AUX outputs low level, if none of the low level condition is meet, AUX outputs high level.
2	When AUX outputs low level, it means the module is busy & cannot conduct operating mode checking. After AUX outputs high level 1ms later, it will complete the mode-switch task.
3	After switching to new operating mode, it won' t be work in the new mode immediately until AUX rising edge 2ms later. If AUX is on the high level, the operating mode switch can be effect immediately.
4	When the user switches to other operating modes from mode 3 (sleep mode) or it' s still in reset process, the module will reset user parameters, during which AUX outputs low level.

3 . Operating mode

E32-TTL-100

Contents in below table are the introduction of input status of M1 & M0 and their corresponding mode:

Mode (0-3)	M1	M0	Mode introduction	Remark
Mode 0 Normal	0	0	UART and wireless channel is opened, transparent transmission is on.	The receiver must works in mode 0 or mode 1
Mode 1 Wake-up	0	1	UART and wireless channel is opened. The difference between normal mode and wake-up mode is it will add preamble code automatically before data packet transmission so that it can awaken the receiver works in mode 2.	The receiver can works in mode 0, mode 1 or mode 2.
Mode 2 Power-savin g	1	0	UART is disabled. Wireless module works at WOR mode (wake on radio). It will open the UART and transmit data after receive the wireless data.	1,the transmitter must works in mode 1 2,transmitting is not allowed in this mode
Mode 3 Sleep	1	1	Parameter setting.	

3.1 Mode switch

E32-TTL-100

No.	Remarks
1	The user can decide the operating mode by the combination of M1 and M0. The two GPIO of MCU can be used to control the mode-switch. After modifying M1 or M0, it will start to work in new mode 1 ms later if the module is free. If there are any serial data that is yet to finish wireless transmitting, it will start to work in new mode after the UART transmitting finishing. After the module receives the wireless data & transmits the data through serial port, it will start to work in new mode after the transmitting finishing. Therefore, the mode-switch is only workable when AUX outputs 1, otherwise it will delay.
2	For example, in mode 0 or mode 1, if the user inputs massive data consecutively and switches operating mode at the same time, the mode-switch operation is invalid. New mode checking can only be started after all the user' s data process completing. It is recommended that after check AUX pinout status and wait 2ms after AUX outputs high level, then switch the mode.
3	If the module switches from other modes to stand-by mode, it will be work in stand-by mode only after all the remained data process completing. The feature can be used to save power consumption. For example, the transmitter works in mode 0, after the external MCU transmits data "12345". It can switch to sleep mode immediately but not wait the rising edge of the AUX pin, also the user' s main MCU will go dormancy immediately. Then the module will transmit all the data through wireless transmission & go dormancy 1ms later automatically. Which reduce MCU working time & save power.
4	Likewise, this feature can be used in any mode-switch. The module will start to work in new mode within 1ms after completing present mode task, which enable the user to omit the procedure of AUX inquiry and switch mode swiftly. For example, when switch from transmitting mode to receiving mode, the user MCU can go dormancy in advance of mode-switch, using external interrupt function to get AUX change so that the mode-switch can be done.
5	This operation is very flexible and efficient. It is totally designed on the basis of the user MCU' s convenience, at the same time reduce the whole system work load as much as possible, increase the efficiency of system work and reduce power consumption.

3.2 Normal mode (Mode 0)**E32-TTL-100**

When M1 = 0 & M0 = 0, module works in mode 0	
Transmitting	<p>The module can receive the user data from serial port, and transmit wireless data package which length is 58 bytes. When the data inputted by user is up to 58 byte, the module will start wireless transmission. During which the user can input data continuously for transmission.</p> <p>When the required transmission bytes is less than 58 byte, the module will wait 3-byte time and treat it as data termination unless continuous data inputted by user. Then the module will transmit all the data through wireless channel.</p> <p>When the module receives the first data packet from user, the AUX outputs low level. After the module transmit all the data into RF chip & start transmission, AUX outputs high level.</p> <p>At this time, it means that the last wireless data package transmission has started, which enable the user to input another 512 bytes continuously. The data package transmitted from the module works in mode 0 can only be received by the module works in mode 0 or 1.</p>
Receiving	<p>The module keeps the wireless receive function on, it can receive the data packet transmitted from the module works in mode 0 & mode 1. After receiving the data packet, the AUX outputs low level, 5ms later the module starts to transmit wireless data through serial port TXD pin. After all the wireless data have been transmitted via serial port, the module AUX outputs high level.</p>

3.3 Wake-up mode (Mode 1)**E32-TTL-100**

When M1 = 0 & M0 = 1, module works in mode 1.	
Transmitting	<p>The condition of data packet transmission & AUX function is the same as mode 0. The only difference is that the module will add preamble code before each data packet automatically. The preamble code length depends on the wake-up time set in the user parameters. The purpose of the preamble code is waking up the receiving module works in mode 2. Therefore, the data package transmitted from mode 1 can be received by mode 0, mode1 and mode 2.</p>
Receiving	<p>The same as that in mode 0.</p>

3.4 Power-saving mode (Mode 2)**E32-TTL-100**

When M1 = 1 & M0 = 0, module works in mode 2.	
Transmitting	<p>UART is closed, the module cannot receive any serial port data from outside MCU. Hence the module works in this mode does not have the function of wireless transmission.</p>
Receiving	<p>In mode 2, it is required the date transmitter works in mode 1.</p> <p>The wireless module monitors the preamble code at regular time. Once it gets the preamble code, it will remain as receive status and wait for the completion of the entire valid date package receives. Then the module lets the AUX outputs low level, 5ms later opens the serial port to transmit received wireless data through TXD. Finally AUX outputs high level after process completing.</p>

	The wireless module stays in “power-saving – monitoring” working status (polling). By setting different wake-up time, the module can have different receive response delay (2s maximum) and average power consumption (30uA minimum). The user needs to achieve a balance between communication delay time & average power consumption.
--	---

3.5 Sleep mode (Mode 3) E32-TTL-100

When M1=1,M0=1,module works in mode 3	
Transmitting	N/A
Receiving	N/A
Parameter setting	This mode can be used for parameter setting. It uses serial port 9600 & 8N1 to set module working parameters through specific instruction format. (pls refer to parameters setting for details)
Notes	When the mode changes from stand-by mode to others, the module will reset its parameters, during which the AUX keeps low level and then outputs high level after reset completing. It is recommended to check the AUX rising edge for user.

3.6 Quick communication test E32-TTL-100

Steps	Operation
1	Plug the USB test board (E15-USB-T2) into computer, make sure the driver is installed correctly. Plug mode-select jumper in the USB test board (M1 = 0 , M0 = 0), make the module work in mode 0.
2	Optional power supply, 3.3V or 5V.
3	Operate AccessPort software and select the correct serial port code. See figure 7.

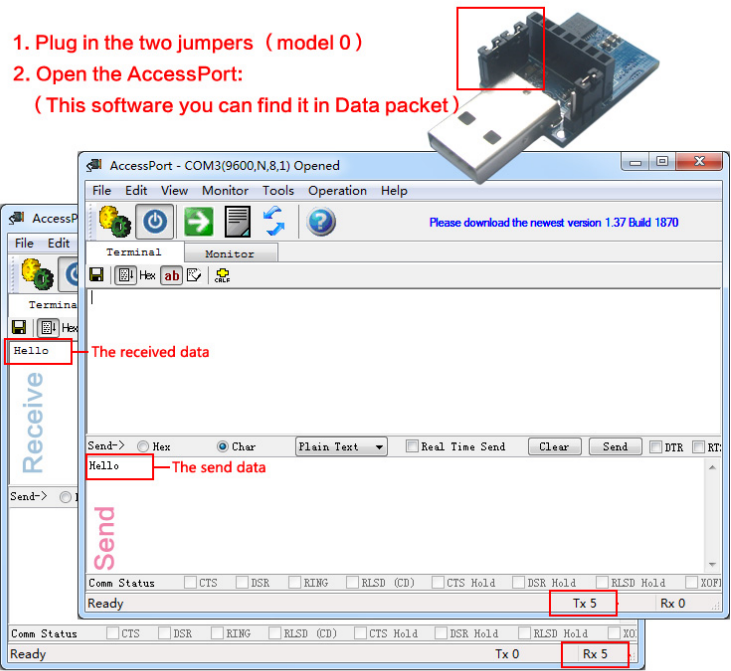

4 . Instruction format

E32-TTL-100

In sleep mode (mode 3 : M1=1, M0=1) , it supports below instructions on list.

(Only support 9600 and 8N1 format when setting)

No.	Instruction format	Illustration
1	C0 + working parameters	C0 + 5 bytes working parameters are sent in hexadecimal format. 6 bytes in total and must send in succession. (Save the parameters when power-down)
2	C1 C1 C1	Three C1 are sent in hexadecimal format. The module returns the saved parameters and must send in succession.
3	C2 + working parameters	C2 + 5 bytes working parameters are sent in hexadecimal format. 6 bytes in total and must send in succession. (Not save the parameters when power-down)
4	C3 C3 C3	Three C3 are sent in hexadecimal format. The module returns the version information and must send in succession.
5	C4 C4 C4	Three C4 are sent in hexadecimal format. The module will reset one time and must send in succession.

4.1 Default parameter

E32-TTL-100

Default parameter values : C0 00 00 1A 17 44							
Model	Frequency	Address	Channel	Air data rate	Baud rate	Parity	
E32-TTL-100	434MHz	0x0000	0x17	2.4kbps	9600	8N1	

4.2 Parameter setting instruction

E32-TTL-100

The difference between C0 command and C2 command is that C0 command will write parameters into the internal flash memory and can be saved when power down, while C2 command cannot be saved when power down, because C2 command is temporarily mend instruction.

C2 is recommended for the occasion that need to change the operating parameters frequently,

Like C2 00 00 1A 17 44.

No.	Item	Description	Remark
0	HEAD	Fix 0xC0 or 0xC2, it means this frame data is control command	Must be 0xC0 or 0xC2 C0: Save the parameters when power-down C2: Not save the parameters when power-down
1	ADDH	High address byte of module (the default 00H)	00H-FFH
2	ADDL	Low address byte of module (the default 00H)	00H-FFH

3	SPED	<p>Rate parameter , including UART baud rate and air date rate</p> <p>7 , 6 UART parity bit</p> <p> 00 : 8N1 (default)</p> <p> 01 : 8O1</p> <p> 10 : 8E1</p> <p> 11 : 8N1 (equal to 00)</p> <p>-----</p> <p>5 , 4 , 3 TTL UART baud rate (bps)</p> <p> 000 : 1200bps</p> <p> 001 : 2400bps</p> <p> 010 : 4800bps</p> <p> 011 : 9600bps (default)</p> <p> 100 : 19200bps</p> <p> 101 : 38400bps</p> <p> 110 : 57600bps</p> <p> 111 : 115200bps</p> <p>-----</p> <p>2 , 1 , 0 Air date rate (bps)</p> <p> 000 : 0.3Kbps</p> <p> 001 : 1.2Kbps</p> <p> 010 : 2.4Kbps (default)</p> <p> 011 : 4.8Kbps</p> <p> 100 : 9.6Kbps</p> <p> 101 : 19.2Kbps</p> <p> 110 : 19.2Kbps</p> <p> 111 : 19.2Kbps</p>	<ul style="list-style-type: none"> ● UART mode can be different between communication parties <p>-----</p> <ul style="list-style-type: none"> ● UART baud rate can be different between communication parties ● The UART baud rate has nothing to do with wireless transmission parameters & won' t affect the wireless transmit / receive features. <p>-----</p> <ul style="list-style-type: none"> ● The lower the air date rate, the longer the transmitting distance, better anti-interference performance and longer transmitting time ● The air date rate must keep the same for both communication parties.
4	CHAN	<p>7 , 6 , 5 : N/A</p> <p>-----</p> <p>4-0 : Communication channel, default 17H (434MHz)</p>	<ul style="list-style-type: none"> ● 0(recommended) <p>-----</p> <p>00H-1FH</p>
5	OPTION	<p>7 , Fixed transmission (similar to MODBUS)</p> <p> 0 : Transparent transmission mode (default)</p> <p> 1 : Fixed transmission mode</p> <p>-----</p> <p>6 IO drive mode(the default 1)</p> <p> 1 : TXD and AUX push-pull outputs,</p> <p> RXD pull-up inputs</p> <p> 0 : TXD、AUX open-collector</p>	<ul style="list-style-type: none"> ● In fixed transmission mode, the first three bytes of each user's data frame can be used as high/low address and channel. The module changes its address and channel when transmit. And it will revert to original setting after complete the process. <p>-----</p> <p>This bit is used to the module internal pull-up resistor. It also increases the level' s adaptability in case of open drain. But in some cases, it may need external pull-up resistor.</p>

		<p>outputs, RXD open-collector inputs</p> <p>-----</p> <p>5 , 4 , 3 wireless wake-up time (for the receiver, it means the monitor interval time ,while for the transmitter it means continuously sending preamble code time.)</p> <p>000 : 250ms (default) 001 : 500ms 010 : 750ms 011 : 1000ms 100 : 1250ms 101 : 1500ms 110 : 1750ms 111 : 2000ms</p> <p>-----</p> <p>2 , FEC switch 0 : Turn off FEC 1 : Turn on FEC (Default)</p> <p>-----</p> <p>1, 0 transmission power (approximation)</p>	<p>-----</p> <ul style="list-style-type: none"> ● The transmit & receive module work in mode 0, whose delay time is invalid & can be arbitrary value. ● The transmitter works in mode 1 can transmit the preamble code of the corresponding time continuously. ● When the receiver works in mode 2, the time means the monitor interval time (wireless wake-up). Only the data from transmitter that works in mode 1 can be received. ● The wake-up time set by transmitter cannot be less than the monitor interval time of receiver; otherwise, it may lead to data loss. In case of two-way communication, both parties should keep the wake-up time the same. ● The longer the wake-up time, the lower the average receive current consumption. <p>-----</p> <ul style="list-style-type: none"> ● After turn off FEC, the actual data transmission rate increases while anti-interference ability decreases. Also the transmission distance is relatively short. Both communication parties must keep on the same pages about turn-on or turn-off FEC. <p>-----</p> <ul style="list-style-type: none"> ● The external power must make sure the ability of current output more than 200mA and ensure the power supply ripple within 100mV. Low power transmission is not recommended due to its low power supply efficiency.
--	--	---	--

For example: The meaning of No.3 "SPED" byte :

The binary bit of the byte	7	6	5	4	3	2	1	0
The specific value (user configures)	0	0	0	1	1	0	1	0
Meaning	UART parity bit 8N1		UART baud rate is 9600			Air data rate is 2.4k		
Corresponding hexadecimal	1				A			

4.3 Reading operating parameters**E32-TTL-100**

Instruction format	Description
C1+C1+C1	In sleep mode (M0=1 , M1=1) , User gives the module instruction (HEX format): C1 C1 C1, Module returns the present configuration parameters. For example, C2 00 00 1A 17 44.

4.4 Reading version number**E32-TTL-100**

Instruction format	Description
C3+C3+C3	In sleep mode (M0=1 , M1=1) , User gives the module instruction (HEX format): C3 C3 C3, Module returns its present version number, for example C3 32 xx yy. 32 here means the module model (E32 series); xx is the version number and yy refers to the other module features.

4.5 Reset instruction**E32-TTL-100**

Instruction format	Description
C4+C4+C4	In sleep mode (M0=1 , M1=1) , User gives the module instruction (HEX format): C4 C4 C4, the module resets for one time. During the reset process, the module will conduct self-check, AUX outputs low level. After reset completing, the AUX outputs high level, then the module starts to work regularly which the working mode can be switched or be given another instruction.

5 . Parameter setting

E32-TTL-100

Step	Operation	Description
1	Install Driver	Please install the USB adapter driver (CP2102).
2	Pull out the jumper	Pull the M0、 M1 jumper out, see figure 9 3.3V or 5V are available for jumper.
3	Connect to module	Connect the module with USB adapter. Connect to the USB interface of PC.
4	Open serial port	Operate the parameter setting software, choose corresponding serial number and press the "Open CommPort" button. Please choose other serial numbers until open successfully.
5	Interface	Press "Press to Read" button , the interface will be as figure 9 If failed, please check if the module is in mode 3, or the driver has been installed or not.
6	Input parameter	Please adjust the parameter as your request according to the corresponding setting, then click "Write" button, write the new parameter to the module
7	Complete the operation.	Please operate the "Fifth step" if you need to reconfigure, if the configuration is completed, Please click "close UART" and then take off the module.
8	Commands Configuration	Parameter configuration is also available for MCU (in mode 3).

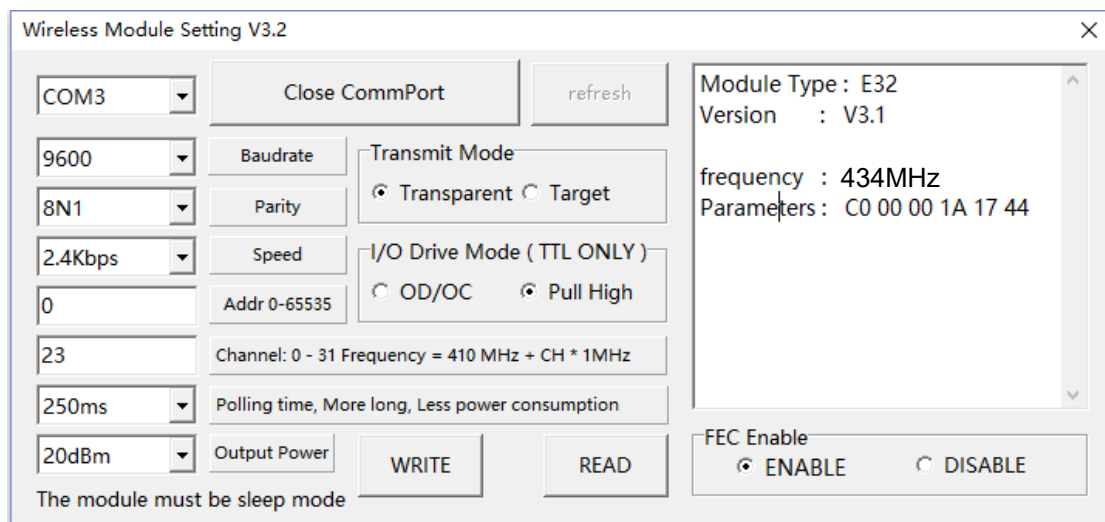
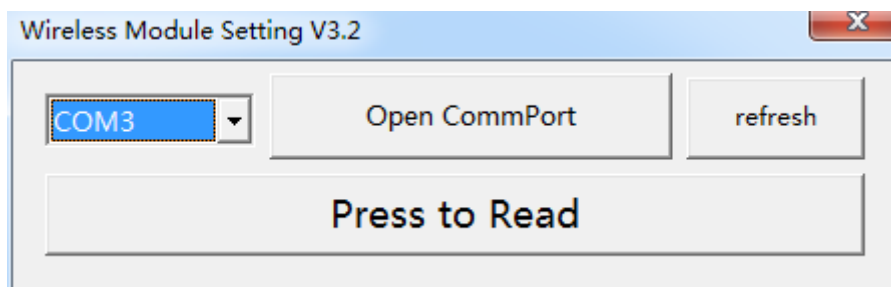

FCC Statement

This device complies with part 15 of the FCC Rules. Operation is subject to the following two conditions: (1) This device may not cause harmful interference, and (2) this device must accept any interference received, including interference that may cause undesired operation.

Changes or modifications not expressly approved by the party responsible for compliance could void the user's authority to operate the equipment.

NOTE: This equipment has been tested and found to comply with the limits for a Class B digital device, pursuant to Part 15 of the FCC Rules. These limits are designed to provide reasonable protection against harmful interference in a residential installation. This equipment generates, uses and can radiate radio frequency energy and, if not installed and used in accordance with the instructions, may cause harmful interference to radio communications. However, there is no guarantee that interference will not occur in a particular installation. If this equipment does cause harmful interference to radio or television reception, which can be determined by turning the equipment off and on, the user is encouraged to try to correct the interference by one or more of the following

measures:

- Reorient or relocate the receiving antenna.
- Increase the separation between the equipment and receiver.
- Connect the equipment into an outlet on a circuit different from that to which the receiver is connected.
- Consult the dealer or an experienced radio/TV technician for help.

FCC Radiation Exposure Statement

This modular complies with FCC RF radiation exposure limits set forth for an uncontrolled environment. This transmitter must not be co-located or operating in conjunction with any other antenna or transmitter.

If the FCC identification number is not visible when the module is installed inside another device, then the outside of the device into which the module is installed must also display a label referring to the enclosed module. This exterior label can use wording such as the following:

"Contains Transmitter Module FCC ID: 2ALPH-E32-TTL-100 Or Contains FCC ID: 2ALPH-E32-TTL-100"

when the module is installed inside another device, the user manual of this device must contain below warning statements;

1. This device complies with Part 15 of the FCC Rules. Operation is subject to the following two conditions:

- (1) This device may not cause harmful interference.
- (2) This device must accept any interference received, including interference that may cause undesired operation.

2. Changes or modifications not expressly approved by the party responsible for compliance could void the user's authority to operate the equipment.

The devices must be installed and used in strict accordance with the manufacturer's instructions as described in the user documentation that comes with the product

6 . About us**E32-TTL-100**

Chengdu Ebyte Electronic Technology Co., Ltd is a high-tech company, focus on wireless transmission. Our company owns a number of independent research & development products and obtain unanimously approved customers. With powerful R&D team, our company can provide customers with perfect After-sales service and technical assistance.



成都亿佰特电子科技有限公司
Chengdu Ebyte Electronic Technology Co.,Ltd.

【Website】 : www.cdebyte.com

【Aliexpress】 : <http://www.aliexpress.com/store/2077046>

【Address】 : Innovation Center D347,4# XI-XIN road, High-tech district(West),Chengdu, Sichuan, China

【Contact person】 : chenfang@cdebyte.com Elaine

【Contact person】 : fanjuan@cdebyte.com Maggie

【Technical support】 : support@cdebyte.com