

VT-M2M-BTA-DE-PKR User's Manual

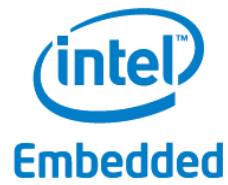

Chengdu Vantron Technology, Ltd.
www.vantrontech.com

All Rights Reserved

Table of Contents

Part I	Hardware	6
1	Foreword	7
1.1	Copyright Notice	7
1.2	Notes.....	8
1.3	Statement.....	8
1.4	Disclaimer.....	8
1.5	Limitation of Liability/Non-warranty	8
1.6	Safety Instructions	9
1.7	Precautions.....	9
1.8	Safety Instructions for Power Cables and Accessories	10
1.9	Cleaning Instructions	10
2	Overview	11
2.1	Introduction.....	11
2.2	Product Series.....	12
2.2.1	Product Order Coding Rule.....	12
2.2.2	Ordering Information	13
3	VT-M2M-BTA-DE-PKR Hardware Instructions	14
3.1	Product Appearance	14
3.2	Specifications.....	17
3.3	Interface Instructions	19
3.3.1	Front View	19
3.3.2	Back View	19
3.4	Dimension.....	20
3.5	Interface Description	21
3.5.1	Wide-Range Power Interface	21

3.5.2	Ethernet Interface	21
3.5.3	D Sub-9 RS232 Connector.....	22
3.5.4	RS232/485, CAN, External IO Connector	23
3.5.5	VGA Interface	24
3.5.6	USB Host Connector	25
3.6	Operation Notice.....	26
3.6.1	Change SIM Card	26
3.6.2	Power Supply.....	26
4	Tips.....	27
Part II	Software	32
5	Introduction	33
5.1.1	About This Manual.....	33
5.1.2	Linux OS Support.....	33
5.1.3	Sample Programs.....	33
5.1.4	Functionalities layout	35
6	Features Description	37
6.1.1	Power Control	37
6.1.2	Serial COM	37
6.1.3	Audio And Video.....	37
6.1.4	GPIO Operation.....	39
6.1.5	Watchdog.....	39
6.1.6	TPM.....	41
6.1.7	mCard(QX-008-490)	42
6.1.8	Bluetooth	42
6.1.9	WIFI Control	44
6.1.10	3G or 4G Control.....	46

- 7 Update System52**
 - 7.1.1 Make USB boot Stick and Copy Image to USB stick
52
 - 7.1.2 Update steps 55

Part I Hardware

1 Foreword

1.1 Copyright Notice

While all information contained herein have been carefully checked to assure its accuracy in technical details and printing, Vantron assumes no responsibility resulting from any error or features of this manual, or from improper uses of this manual or the software. Please contact our technical department for relevant operation solutions if there is any problem that cannot be solved according to this manual.

Vantron reserves all rights of this manual, including the right to change the content, form, product features, and specifications contained herein at any time without prior notice. The latest version of this manual is at www.vantrontech.com.cn. Please contact Vantron for further information:

Vantron Technology (Vantron)



E-mail: sales@vantrontech.com

The trademarks and registered trademarks in this manual are properties of their respective owners. No part of this manual may be copied, reproduced, translated or sold. No changes or other purposes are permitted without the prior written consent of Vantron.

Vantron reserves the right of all publicly-released copies of this manual.

1.2 Notes

Applicable notes are listed in the following table:

Sign	Notice Type	Description
	Notice	Important information and regulations
	Caution	Caution for latent damage to system or harm to personnel

1.3 Statement

It is recommended to read and comply with this manual before operating VT-M2M-BTA-DE-PKR which provides important guidance and helps decreasing the danger of injury, electric shock, fire, or any damage to the device.

1.4 Disclaimer

Vantron assumes no legal liability of accidents resulting from failure of conforming to the safety instructions.

1.5 Limitation of Liability/Non-warranty

For direct or indirect damage to this device or other devices of Vantron caused by failure of conforming to this manual or the safety instructions on device label, Vantron assumes neither warranty nor legal liability even if the device is still under warranty.

The VT-M2M-BTA-DE-PKR should be installed, debugged and maintained by professional people.

The outside antennas are not permitted to be installed or to be changed by non-professional people. To run the device normally, only

specify antennas are approved to be assembled together by professional people.

Unit shall be used with indoor-use antenna only. No antenna for this unit can be installed outdoor.

1.6 Safety Instructions

- ✧ Keep and comply with all operation instructions, warnings, and information.
- ✧ Pay attention to warnings on this device.
- ✧ Read the following precautions so as to decrease the danger of injury, electric shock, fire, or any damage to the device.
- ✧ Operations and Service instructions are provided with the equipment.
- ✧ Unit shall be used with indoor-use antenna only. No antenna for this unit can be installed outdoor.
- ✧ The maximum operation temperature is 61°C.

1.7 Precautions

- ✧ Pay attention to the product labels/safety instructions printed on silk screens.
- ✧ Do not try repairing this product unless declared in this manual.
- ✧ Keep away from heat source, such as heater, heat dissipater, or engine casing.
- ✧ Do not insert other items into the slot (if any) of this device.
 - Keep the ventilation slot ventilated for cooling.
 - System fault may arise if other items are inserted into this device.
- ✧ Installation: ensure correct installation according to instructions from the manufacturer with recommended installation tools.
- ✧ Ensure ventilation and smoothness according to relevant ventilation standard.

1.8 Safety Instructions for Power Cables and Accessories



Proper power source only. Start only with power source that satisfies voltage label and the voltage necessary according to this manual. Please contact technical support personnel of Vantron for any uncertainty about the requirements of necessary power source.



Use tested power source. This product still contains a button lithium battery as a real-time clock after its external power source is removed and therefore should not be short-circuited during transportation or placed under high temperature.



Place cables properly: Do not place cables at any place with extrusion danger.



1.9 Cleaning Instructions

- ✧ Please power off before cleaning the device.
- ✧ Do not use spray detergent.
- ✧ Clean with a damp cloth.
- ✧ Do not try cleaning exposed electronic components unless with a dust collector.
- ✧ Support for special fault: Power off and contact technical support personnel of Vantron in case of the following faults:
 - The device is damaged.
 - The temperature is excessively high.
 - Fault is still not solved after the operation according to the manual.

2 Overview

2.1 Introduction

Thank you for choosing Vantron. It is our commitment to provide our valued customers with the embedded devices equipped with the state-of-the-art technology and the best product services.

Vantron's M2M products are based on the most advanced ARM and Intel Atom processors and have low-power consumption and high integration. The products are designed for applications of M2M in industrials, retail, vehicle, and transportations etc.

2.2 Product Series

2.2.1 Product Order Coding Rule

Order Code

VT-M2M-BTA-DE-PKR-S-1GM-16GF-GWM-V

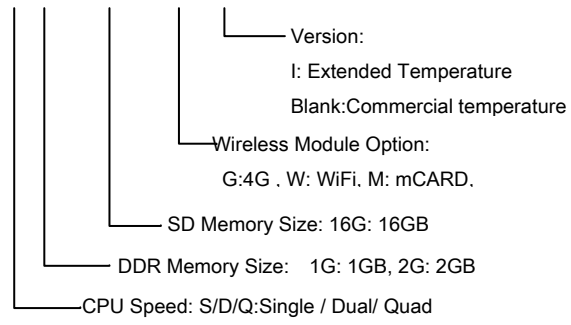

2.2.2 Ordering Information

Order Examples:

VT-M2M-BTA-DE-PKR-S-2GM-16GF-GWM-I	ATOM Baytrail single Processor, 2GB DDR3L, 16GB SSD, 4G, WiFi, mCARD, extended temperature
---	--

Accessories:

Install Mechanical tools, 1pc
Power Adapter with locked connector, 1pc
IO Terminal (12x3.81mm), 1pc
LTE Antenna: Main(1pcs);Diversity(1pcs)
Wi-Fi Antenna, 1pcs;BT Antenna, 1pc
SRD Antenna, 1pc

3 VT-M2M-BTA-DE-PKR Hardware Instructions

3.1 Product Appearance



Front Side View



Back Side View



[View for all embedded modules and antennas](#)



Bottom View for embedded modules
(1xHalf PCIe slot under the 1xPCIe slot)



Top View for thermal module

3.2 Specifications

Specifications		
CPU	Processor	Intel® ATOM™, E3815/1.46GHz, 512KB L2 cache per core
Memory	On Board RAM	On Board DDRIII 1066MT/s , up to 2GB
	SSD Internal	Half-Slim SSD Module Internal (16GB)
Display	Resolution	Up to 2560x1600@60Hz for VGA
	Interface	1xVGA (DB15)
Wireless Communication	WLAN	802.11 b/g/n Wireless Module, external antenna , Support 1x Half PCIe Wireless card
	4G Module	1xPCIe 4G/LTE Cellular Module with SIM slot
	RF Module	mCard Module with external antenna Support 900MHz
	Bluetooth	Bluetooth module, external antenna
Peripheral Interfaces	Ethernet	2x10/100/1000-BaseT(RJ45)
	USB	2xUSB2.0 Host (Type A)
	Audio	HD Audio, 1xMIC in 3.5mm, 1xline Out 3.5mm
	COM Port	1xRS232/485/422(DB9 full function), 1xRS232/485(2 wires on Green Terminal)
	Alarm	Buzzer Out
	SD card	1xSD card Slot
	RTC	Supported
	Control	Reset Button on the top
	GPIO	Reserved GPIO (Terminal)
	Accelerometer	On Board Accelerometer, 3-Axis

Security	security	On board Registration Serial Number, and SHA-1 Encrypt/Decrypt Chip DS28E01(Optional) Optional TPM module
Software	OS	Ubuntu 16.04 Desktop 64bit
	Applications	SDK Available
Power	Input	DC9-36V(Typical:12V), Locked Power Jack
	Consumption	6W (Pulse 8W), Sleep 2W. (without 4G, mCard, WLAN, Bluetooth)
Mechanical	Dimensions	176x101x52mm (Box)
	Install Brackets	198x101x52mm
	Weight	0.6Kg (1.2Kg package Kit)
	Enclosure	Aluminum Alloy with Black Color
Environment Condition	Temperature	Operating:-20°C ~ +60°C (ETR:-40°C ~ +80°C Optional)
		Storage:-40°C ~ +85°C
	Humidity	5-95%RH at 25-35 (Non-Condensation)
	Cooling Mode	Fan less, Heat Sink
	Approvals	FCC, ISED, CE, RoHS, and PTCRB Compliance

3.3 Interface Instructions

3.3.1 Front View



3.3.2 Back View



3.4 Dimension

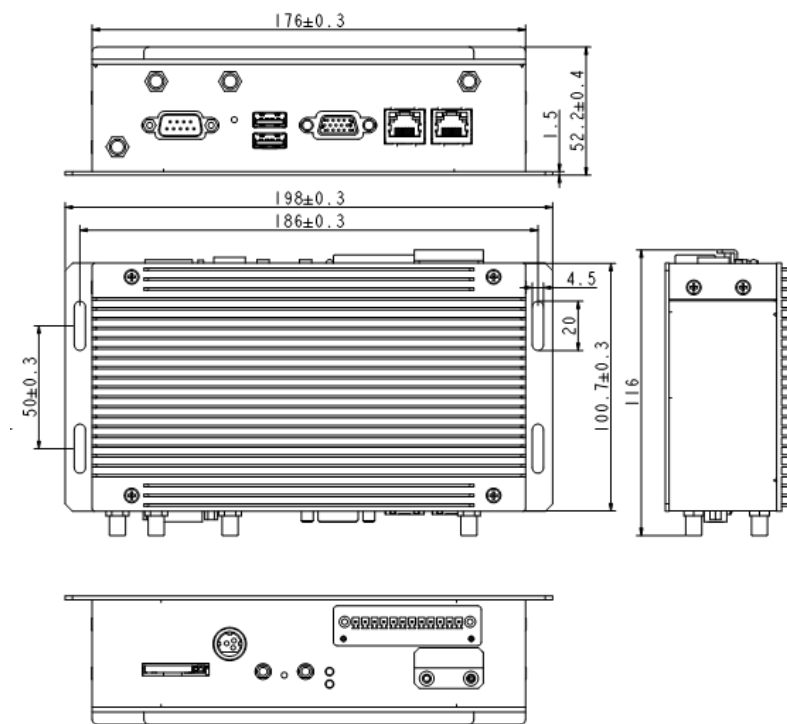

3.5 Interface Description

3.5.1 Wide-Range Power Interface

Power JACK with lock



Pin	Description
1,3	DGND (ground pin)
2	Power (+12 DC, UP to 36V)

3.5.2 Ethernet Interface

Standard RJ45 interface, supporting 10M/100M/1000M self-adaptation, this is a standard RJ45 ethernet port

3.5.3 D Sub-9 RS232 Connector

Standard vertical DB-9 male connector

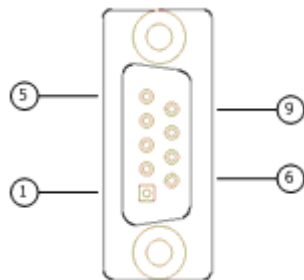

Pin	Description	Remarks
1	DCD1/422TX+/485_A	BIOS set
2	RXD1/422TX-/485_B	BIOS set
3	TXD1/422RX+	BIOS set
4	DTR1/422RX-	BIOS set
5	DGND (ground pin)	
6	DSR1	
7	RTS1	
8	CTS1	
9	RI1	

3.5.4 RS232/485, CAN, External IO Connector

12pins 3.81 pitch terminal with screw lock

Load capacity: more than 128 nodes/RS485 channel



Pin	Description	Remarks
1	TXD2/485_2_A	BIOS set
2	RXD2/485_2_B	BIOS set
3	DGND	
4	CANH	
5	CANL	
6	DGND	
7	EXTIO0	3.3V Level
8	EXTIO1	3.3V Level
9	EXTIO2	3.3V Level
10	EXTIO3	3.3V Level
11	EXTIO4	3.3V Level
12	EXTIO5	3.3V Level

3.5.5 VGA Interface

Standard vertical DB-15 Female VGA connector

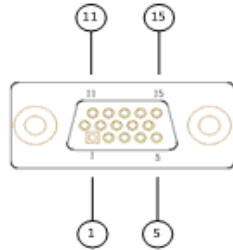

Pin	Description
1	RED
2	GREEN
3	BLUE
4	N.C.
5	GND
6	GND
7	GND
8	GND
9	+5VDC
10	GND
11	N.C.
12	SD_DDC
13	HSYNC
14	VHYNC
15	SC_DDC

3.5.6 USB Host Connector

Dual vertical USB A type interface, USB2.0

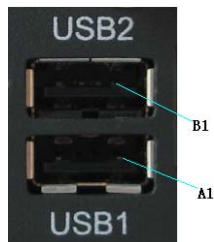

Pin	Description
A1	USB1_VCC(+5VDC)
A2	USB1_D-
A3	USB1_D+
A4	USB1_DGND(ground pin)
B1	USB2_VCC(+5VDC)
B2	USB2_D-
B3	USB2_D+
B4	USB2_DGND(ground pin)

Notes: Insert external device in USB1 connector should before powering up.

3.6 Operation Notice

3.6.1 Change SIM Card

Push the small button on the left of SIM Card Holder, and install the SIM card to the holder. Then push the holder into the Slot.

3.6.2 Antenna installation

Each antenna for this device must be provided by the manufacturer Chengdu Vantron Technology, Ltd. and the end user should not install and use any other antennas.

All antennas need be correspond to connectors one to one, do not be mixed, do not replace undeclared antenna.

3.6.3 Power Supply

Please make sure using adapter in the accessory, or the power is not reversed when powered by other adapter.

4 Tips



Waste Disposal

It is recommended to disassemble the device before abandoning it in conformity with local regulations. Please ensure that the abandoned batteries are disposed according to local regulations on waste disposal. Do not throw batteries into fire (explosive) or put in common waste canister. Products or product packages with the sign of “explosive” should not be disposed like household waste but delivered to specialized electrical & electronic waste recycling/disposal center. Proper disposal of this sort of waste helps avoiding harm and adverse effect upon surroundings and people’s health. Please contact local organizations or recycling/disposal center for more recycling/disposal methods of related products.

Comply with the following safety tips:



Do not use in combustible and explosive environment

Keep away from combustible and explosive environment for fear of danger.



Keep away from all energized circuits.

Operators should not remove enclosure from the device. Only the group or person with factory certification is permitted to open the enclosure to adjust and replace the structure and components of the device. Do not change components unless the power cord is removed. In some cases, the device may still have residual voltage even if the power cord is removed. Therefore, it is a must to remove and fully discharge the device before contact so as to avoid injury.



Unauthorized changes to this product or its components are prohibited.

In the aim of avoiding accidents as far as possible, it is not allowed to replace the system or change components unless with permission and certification. Please contact the technical department of Vantron or local branches for help.



Pay attention to caution signs.

Caution signs in this manual remind of possible danger. Please comply with relevant safety tips below each sign. Meanwhile, you should strictly conform to all safety tips for operation environment.



Notice

Considering that reasonable efforts have been made to assure accuracy of this manual, Vantron assumes no responsibility of possible missing contents and information, errors in contents, citations, examples, and source programs.

Vantron reserves the right to make necessary changes to this manual without prior notice. No part of this manual may be reprinted or publicly released in forms of photocopy, tape, broadcast, e-document, etc.



FCC Warning

This device complies with FCC class B Rules. Operation is subject to the following conditions.

This device may not cause harmful interference.

This device must accept any interference received, including interference that may cause undesired operation.

Note: This equipment has been tested and found to comply with the limits for a Class B digital device, pursuant to part 15 of the FCC Rules. These limits are designed to provide reasonable protection against harmful interference in a residential installation. This equipment generates, uses and can radiate radio frequency energy and, if not installed and used in accordance with the instructions, may cause harmful interference to radio communications. However, there is no guarantee that interference will not occur in a particular installation. If this equipment does cause harmful interference to radio or television reception, which can be determined by turning the equipment off and on, the user is encouraged to try to correct the interference by one or more of the following measures:

- Reorient or relocate the receiving antenna.
- Connect the equipment into an outlet on a circuit different from

that to which the receiver is connected.

—Consult the dealer or an experienced radio/TV technician for help.

Any modification to the product is not permitted unless authorized by Vantron. It's not allowed to disassemble the product, it is not allowed to replace the system or change components unless with permission and certification. Please contact the technical support department of Vantron or local branches for help.



ISED statement

Disclaimer:

Operation is subject to the following two conditions:

(1) This device may not cause interference, and

(2) This device must accept any interference, including interference that may cause undesired operation of the device.

Warning!

This class B digital apparatus complies with Canadian ICES-003.

Industry Canada ICES-003 Compliance Label:

CAN ICES-3 (B)/NMB-3(B)

Le présent appareil est conforme aux CNR d' Innovation Science et Développement économique Canada applicables aux appareils radio exempts.

L'exploitation est autorisée aux deux conditions suivantes :

(1) l'appareil ne doit pas produire de brouillage, et

(2) l'utilisateur de l'appareil doit accepter tout brouillage

radioélectrique subi, même si le brouillage est

susceptible d'en compromettre le fonctionnement.

**RF exposure warning**

This equipment must be installed and operated in accordance with provide instructions and the antenna used for this transmitter must be installed to provide a separation distance of at least 20 cm from all persons and must not be co-located or operation in conjunction with any other antenna or transmitter. End-users and installers must be provide with antenna installation instructions and transmitter operating conditions for satisfying RF exposure compliance.

Part II Software

5 Introduction

Thank you for choosing Vantron. It is our commitment to provide our valued customers with the embedded devices equipped with the state of the art technology and the best product services.

Vantron's M2M products are based on the most advanced ARM and Intel Atom processors and have low power consumption and high integration.

5.1.1 About This Manual

This manual is for user how to use sample programs in Linux system and how to use device in Linux system.

5.1.2 Linux OS Support

The VT-M2M-BTA-DE-PKR supports the following Linux operating systems.

- Ubuntu 16.04

The default normal user is **vantron**, password is **vantron**.

5.1.3 Sample Programs

Vantron supports many sample programs for VT-M2M-BTA-DE-PKR. You can test device modules through these sample programs, and can be the reference that you develop.

- power Power control for modules in the set
- gpio GPIO control

5.1.4 Functionalities layout

The below table lists VT-M2M-BTA-DE-PKR features.

Chips or Interfaces	Details
UART	VT-M2M-BTA-DE-PKR has 4 UART ports: /dev/ttyS1:RS232/422/485 DB9 COM Port /dev/ttyS2: Green Terminal Pin 1,2 RS232/485
USB Host portx2	
1xEthernet 2xEthernet (VT-M2M-BTA-DE-PKR-DE)	\$sudo ifconfig eth0 192.168.16.143
Audio MIC IN	ALSA audio device \$ arecord -t wav test.wav
Audio Out	ALSA audio device \$aplay test.wav
Green Terminal	1 :TXD2 2 :RXD2 3 :GND 4 :CANH 5 :CANL 6 :GND

	7:EXTIO0
	8:EXTIO1
	9:EXTIO2
	10:EXTIO3
	11:EXTIO4
	12 EXTIO5

6 Features Description

This chapter describes some of the features of the software operation.

Open the terminal (CTRL+ALT+T), use the testing command.

6.1.1 Power Control

power [3g] [on|off]

3g: Power control of 3G Module

6.1.2 Serial COM

115200,38400 and 9600 bps are valid.

Test the RS232/485, we need two devices.

Select the serial protocol through the BIOS.

a. One side send data:

```
$sudo minicom -D /dev/ttyS1 -b 115200
```

Then input "hello"

will print "hello"s on your output device

b. The other side accept data:

```
$sudo minicom -D /dev/ttyS2 -b 115200
```

6.1.3 Audio And Video

a. Audio record:

```
$sudo arecord -t wav test.wav
```

b. Audio play:

```
$sudo aplay test.wav
```

6.1.4 GPIO Operation

There are 6 extern GPIO on VT-M2M-BTA-DE-PKR, you can use this command:

```
gpio [ set | clear | read | dirout | dirin ] [ 1-6 | all ]
```

ex 1: Set gpio 1 low

```
$sudo gpio clear 1
```

ex2: Set gpio 1 high

```
$sudo gpio set 1
```

ex3: Get gpio 1 value

```
$sudo gpio read 1
```

ex4: Set gpio 1 input

```
$sudo gpio dirin 1
```

6.1.5 Watchdog

a. Configure watchdog driver:

```
$sudo vim /etc/default/watchdog
#Start watchdog at boot time? 0 or 1
run_watchdog=1
#Load module before starting watchdog
watchdog_module="sch311x_wdt"
#Specify additional watchdog options here (see manpage).
```

b. Configure watchdog:

```
$sudo vim /etc/watchdog.conf
```

c. Start watchdog or reboot system:

```
$sudo watchdog
```

d. Disable the watchdog

```
$sudo killall watchdog
```

```
$sudo echo 1 > /dev/watchdog
```

One minute after the system restart.

6.1.6 TPM

The TPM security setting refer to **bios/doc/VT-M2M-BTA-DE-PKR BIOS Guide V1.0.pdf** configure the security menu.

The TPM manager

```
$sudo tpmmanager
```

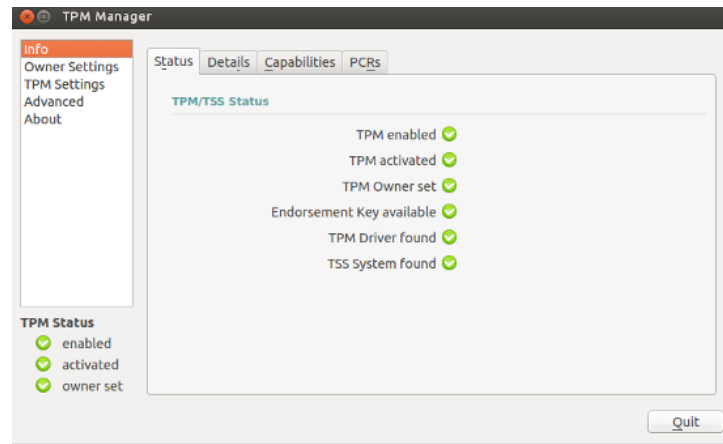

6.1.7 mCard(QX-008-490)

Insert the mCard ,using the follow command to get mCard data:

```
$sudo minicom -D /dev/ttyMcard -b 115200
```

The mCard QX-008-490 installed into the gateway

VT-M2M-BTA-DE-PKR is designed to be able to communicate with the other devices which also integrated a mCard QX-008-490 such as another VT-M2M-BTA-DE-PKR gateway.

6.1.8 Bluetooth

Connect the Bluetooth:

- a. Double-click the launcher Bluetooth icon to open the management interface.

- b. Turn on the Bluetooth and set it to visible, then click “+” in the lower left corner to search for Bluetooth devices.

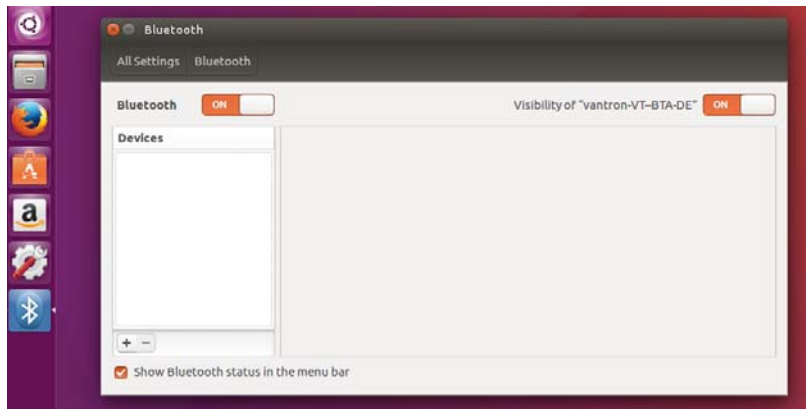

- c. Select the bluetooth device to connect to in the device list.



- d. Click on “Next”, then click “Matches” to connect.

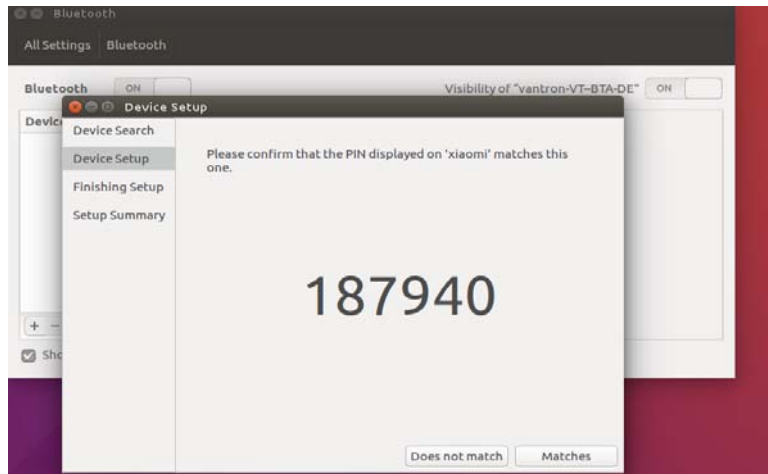

3 Network Module

The network be managed by the network connections, can use network connections tool from system tools.

6.1.9 WIFI Control

6.1.9.1 WIFI Client Control

Connect the WIFI hotspot:

- a. Left click on the Network Indicator applet, located in the right-hand corner of the top panel, and ensure that both "Enable Networking" and "Enable Wireless" have check marks next to them in the drop-down

list.

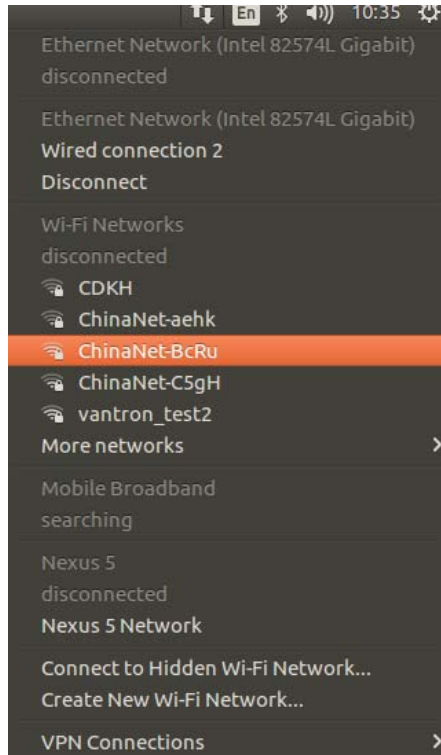

b. Select your wireless network from the list or if it is not shown select "More Networks" to see all the available networks. You also can select "Connect to Hidden Wireless Network" from the list to connect to a hidden network.

Type your WIFI password and press "Connect" to connect the WIFI.

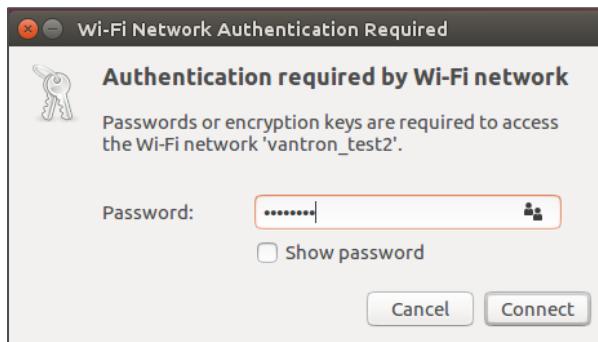

The Network Indicator applet will change to show that it is attempting to connect to a network, and will display the network strength once it has connected.

Other method

Follow these steps for changing to new WiFi network

- 1 .Click on WiFi Symbol which is beside the battery symbol.
- 2 .Click on Edit Connection which is at the bottom of the drop down.
- 3 .Select the network on which you want to connect, and then click edit button.
- 4 .Click on WiFi-security tab over there and enter the pass word of that network, save and close.

Now if you connect to this, everything will work fine.

6.1.1 4G Control

Note: When you disconnected the 4G or connected error, you may need to restart the 4G module:

```
$sudo power 3g off
```

```
$sudo power 3g on
```

- a. Click 4G network connection mark on the top side.



- b. Click the Edit Connections:



c. Select country, and then click Next.

d. Select provider from list:



e. Apply the config:

Choose your Billing Plan

Set up a Mobile Broadband Connection

Choose your Provider's Country or Region

Choose your Provider

Choose your Billing Plan

Confirm Mobile Broadband Settings

Select your plan:

Default

Selected plan APN (Access Point Name):

3gnet

 Warning: Selecting an incorrect plan may result in billing issues for your broadband account or may prevent connectivity.

If you are unsure of your plan please ask your provider for your plan's APN.

Cancel Back Next

Confirm Mobile Broadband Settings

Set up a Mobile Broadband Connection

Choose your Provider's Country or Region

Choose your Provider

Choose your Billing Plan

Confirm Mobile Broadband Settings

Your mobile broadband connection is configured with the following settings:

Your Provider:
China Unicom, China

Your Plan:
Default
APN: 3gnet

Cancel Back Apply

h. Edit it:



i. Clear the Username and Save

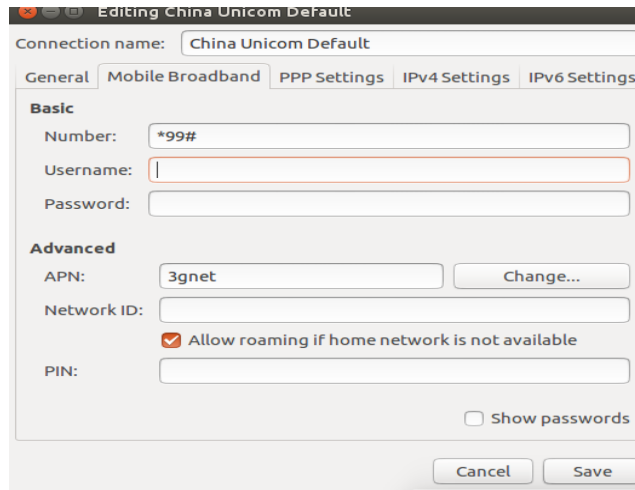

j. Connect the internet:



7 Update System

7.1.1 Make USB boot Stick and Copy Image to USB stick

Create PC condition:

Create a bootable USB stick on Windows XP/ Win7, the first thing you need to do is insert a USB stick with at least 2GB of free space into your PC.

Here use an USB installer tool to write the image ISO to USB stick. Please copy the file **SW/tools/Universal-USB-Installer-1.9xx.exe** to your PC anywhere.

USB stick making steps in detail as follows:

- a. Copy **SW/image/xxx.iso** image into your PC.
- b. Select the “Try Unlisted Linux ISO” from the dropdown list.

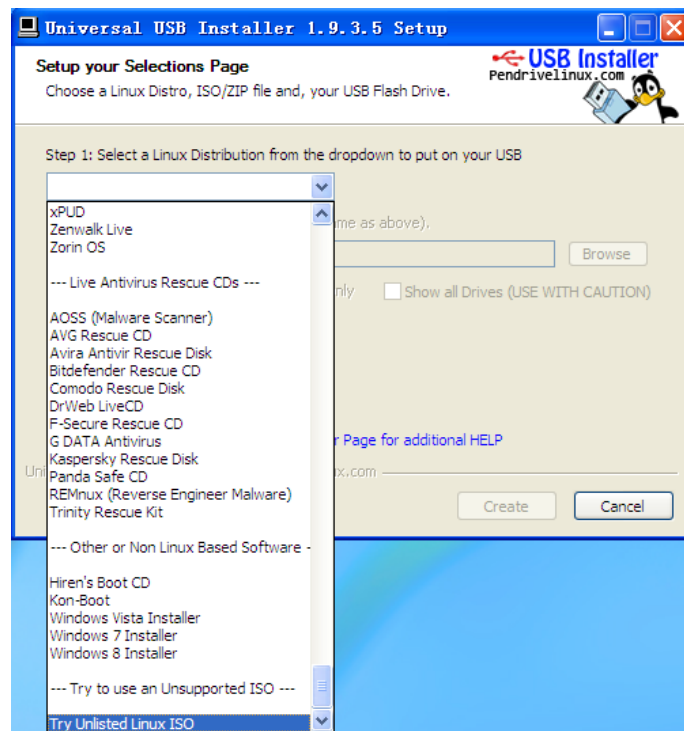

c. Click '**Browse**' and select the image ISO file.

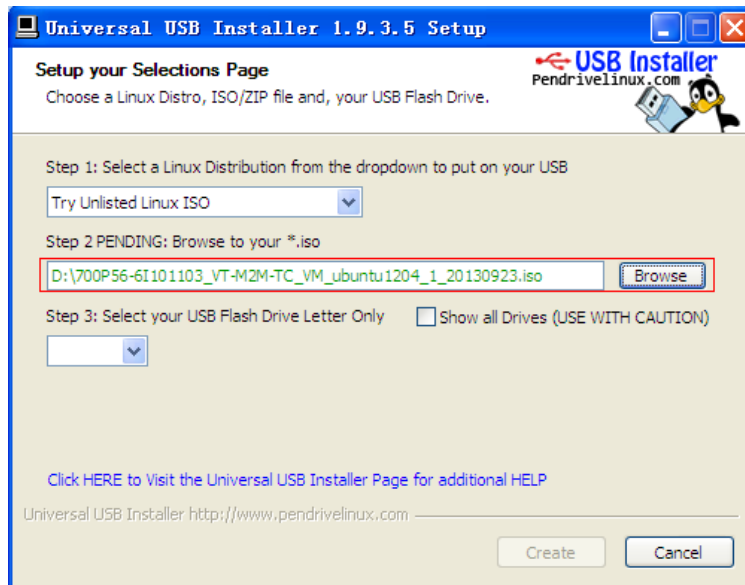

d. Choose the USB drive and click '**Create**'.

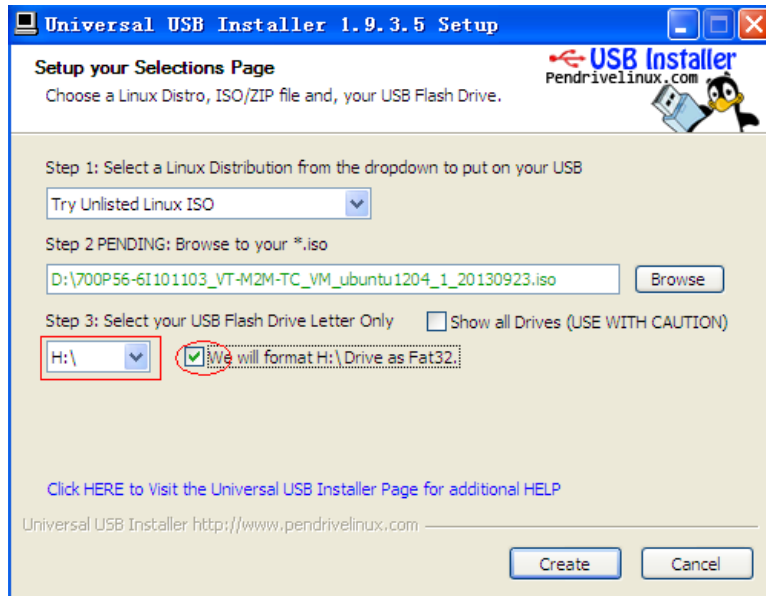

7.1.2 Update steps

- a. When the bootable USB stick create over, insert the USB stick into VT-M2M-BTA-DE-PKR. And connect a USB keyboard on the VT-M2M-BTA-DE-PKR.
- b. Power ON the VT-M2M-BTA-DE-PKR, and step into BIOS by press the “Esc” key on the keyboard.

In the BIOS, set the first boot option for boot up by USB stick. Power off the 3G module(SCU->Advanced->Onboard Devices Configuration).

The user guidance of the BIOS is in the package of **SW/bios/xxx.ZIP**.

- c. Select the first option “clonezilla live with img 700Pxxxxxx”.

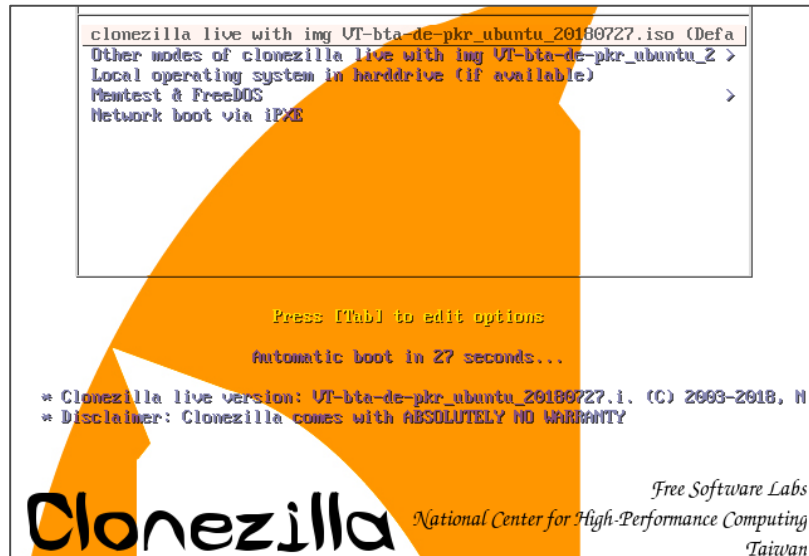

- f. When update over, the system will reboot.

Notes: If display "Will now halt", you can direct power off then power on.

- g. Re-power VT-M2M-BTA-DE-PKR, and step into the BIOS, and restore the first boot option to hard disk.

Vantron

China Office: Chengdu Vantron Technology, Ltd.

Address: No.5 Gaopeng Road, Hi-Tech Zone, Chengdu, Sichuan, P.R.China 610045

Tel: 86-28-8512-3930/3931, 8515-7572/6320

Email: sales@vantrontech.com.cn

US Office: Vantron Technology, Inc.

Address: 440 Boulder Court, Suite 300,
Pleasanton, CA 94566

Tel: +1 916-202-7042

Email: sales@vantrontech.com