CHERRY B.UNLIMITED AES

Wireless Rechargeable Desktop



OPERATING MANUAL

DRAFT!



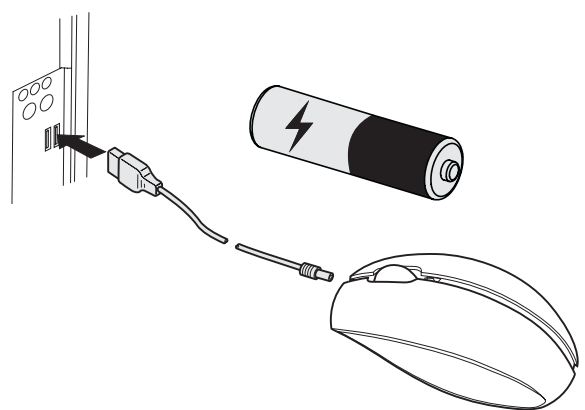
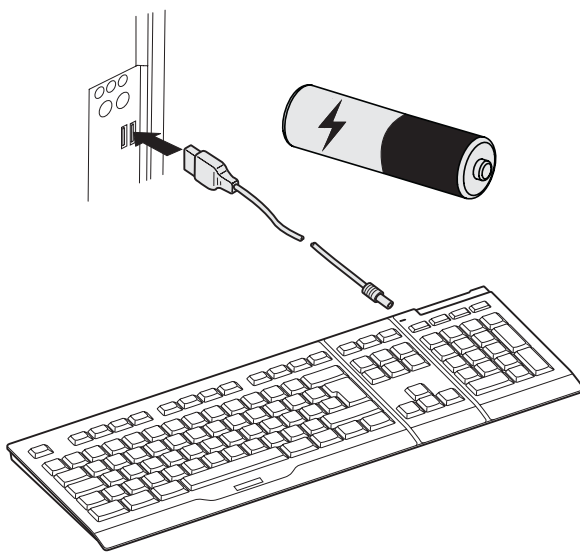
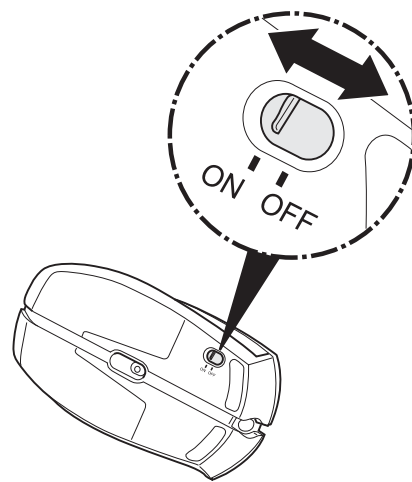
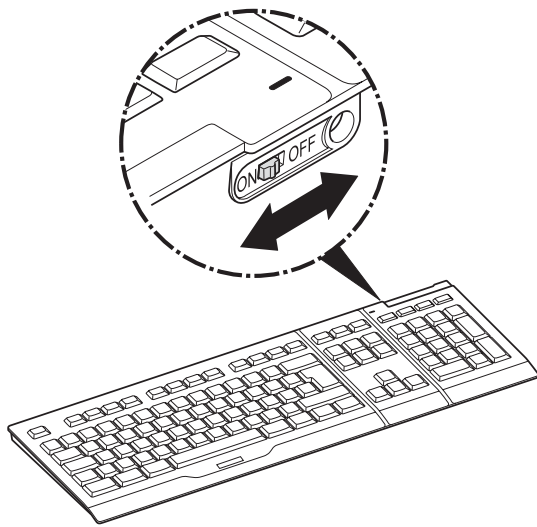
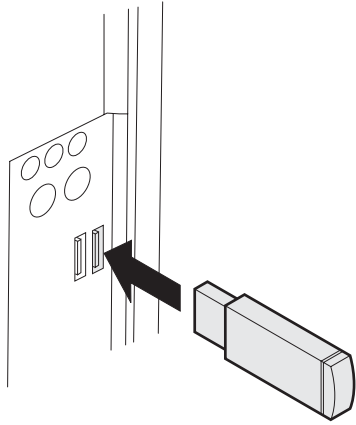

OPERATING MANUAL

CHERRY B.UNLIMITED AES // Wireless Rechargeable Desktop

Congratulations ...

CHERRY has been developing and producing innovative input systems for computers since 1967. You will now be able to feel the difference in quality, reliability and design with your new favorite piece of equipment.

Always order original CHERRY equipment.

For information on additional products, downloads, and much more, please visit www.cherry.de

The following features in particular set your **CHERRY B.UNLIMITED AES** apart:

- Chargeable keyboard and mouse
- Infrared sensor with changeable resolution for fine-detail work (1000/2000 dpi)
- **KeyM@n** software enables you to program the buttons on your mouse and the hotkeys of your keyboard (except standby) however you like (free download at: www.cherry.de/english/service/download.php)

1 Charging the batteries



CAUTION: Damage to batteries or devices

- The batteries must only be charged in the devices. Do not use any external charging unit.
- Charge only rechargeable NiMH batteries.

Charge the batteries of the corresponding device when the LED for the keyboard/mouse is flashing red. You can continue to work during the charging process.

2 Tips

2.1 Surface under the mouse

A bright, structured surface under the mouse increases the efficiency of the mouse and ensures optimum detection of movement.

A reflective surface is not suitable for use under the mouse.

2.2 Cleaning the devices



CAUTION: Damage may be caused by harsh cleaning agents or liquids in the devices

- Do not use solvents such as gasoline or alcohol and scouring agents or scouring sponges for cleaning.
- Prevent liquids from entering the devices.
- Do not remove the keycaps of the keyboard.

- 1 Clean the devices with a slightly damp cloth and some mild cleaning agent (e.g. dishwashing liquid).
- 2 Dry off the devices with a soft, lint-free cloth.

2.3 RSI syndrome



RSI stands for "Repetitive Strain Injury". RSI arises due to small movements continuously repeated over a long period of time.

Typical symptoms are discomfort in the fingers or neck. For further information see: www.cherry.de/english/service/servicedownload_rsi.htm

OPERATING MANUAL

CHERRY B.UNLIMITED AES // Wireless Rechargeable Desktop

- Set up your workspace ergonomically.
- Position the keyboard and mouse in such a manner that your upper arms and wrists are outstretched and to the sides of your body.
- Take several short breaks, with stretching exercises if necessary.
- Change your posture often.

2.4 Troubleshooting

- 1 Check whether the batteries are inserted correctly and supply sufficient voltage.
- 2 Connect the receiver to another USB port on the PC.

3 Disposal

3.1 Disposal of the old unit



Dispose of the old unit via a collecting point for electronic scrap or via your dealer.

3.2 Disposal of the batteries



The devices are containing rechargeable nickel metal hydride batteries.

If the batteries can no longer be charged at the end of their service life, do not dispose of them with household waste. Batteries may contain pollutants that can pose a danger to the environment and public health. Please return the batteries together with the device to the specialist dealer or hand it in at your community recycling center. Returning the batteries is mandatory under law and free of charge.

All standard and rechargeable batteries are recycled, which enables valuable raw materials, such as iron, zinc and nickel to be recovered. Recycling batteries is the easiest way to contribute toward protecting the environment.

Thank you for your cooperation.

4 Technical data

Designation	Value
Supply voltage	Keyboard: 1.9 ... 3.0 V SELV Mouse: 1,9 ... 3.0 V ±5 % SELV Receiver: 5.0 V/DC ±5 % SELV
Current consumption	Keyboard: typ. 5 mA (during the charging process: 180 mA) Mouse: typ. 10 mA (during the charging process: 180 mA) Receiver: typ. 30 mA
Battery type keyboard	2 NiMH batteries, type HR03 (AAA), 850 mAh
Battery type mouse	2 NiMH batteries, type HR6 (AA), 2050 mAh
Storage temperature	-20 °C ... +65 °C
Operating temperature	0 °C ... +40 °C

5 Contact

ZF Friedrichshafen AG
Electronic Systems
Cherrystraße
91275 Auerbach
Germany

Internet: www.cherry.de

E-mail: info@cherry.de

Please have the following information on hand when contacting technical support:

- Item and serial no. of the product
- Name and manufacturer of your system
- Operating system and, if applicable, installed service pack version

6 General advice

CHERRY, a brand of ZF Friedrichshafen AG, continuously optimizes its products as new technologies are developed. For this reason we reserve the right to make technical alterations. The evaluation of product reliability and the definition of the product's technical performance are carried out according to our own requirements in order to meet internationally recognized regulations and standards. Requirements in addition to these can be met through mutual cooperation. Improper usage, handling, storage and external influences could lead to faults and defects during use.

We do not accept warranty for defects caused by alterations to our product by the user and shall not be held liable for unauthorized modifications. All repairs must be made by us or an officially appointed organization or person.

Possible compensation claims against ZF Friedrichshafen AG or its nominated officers – whatever the legal justification including physical or stress related injuries – are excluded. Exceptions to this exist in the case of intent or gross negligence on the part of ZF Friedrichshafen AG infringements of Product Liability Law or in cases of injury, bodily harm or risk to health.

These operating instructions only apply to the accompanying product.

Full details can be obtained from your distributor or direct from us.

7 Warranty

The statutory warranty applies. Please contact your specialist dealer or contractual partner. You can find more information on the warranty under www.cherry.de.

8 Certifications

8.1 CE Declaration of Conformity



Hereby, ZF Friedrichshafen AG, Electronic Systems business area, Auerbach/Opf., Germany, declares that this Radio-Frequency peripheral is in compliance with the essential requirements and other relevant provisions of Directive 1999/5/EC. The CE Declaration of Conformity can be retrieved by accessing the following internet address:

www.cherry.de/compliance

Once accessed, click on the relevant product name to retrieve the CE Declaration of Conformity.

8.2 Federal Communications Commission (FCC) Radio Frequency Interference Statement

Information to the user: This equipment has been tested and found to comply with the limits for Class B digital device, pursuant to Part 15 of the FCC Rules. These limits are designed to provide reasonable protection against harmful interference in a residential installation. This equipment generates, uses and can radiate radio frequency energy and, if not installed and used in accordance with the instructions, may cause harmful interference to radio communications. However, there is no guarantee that interference will not occur in a particular installation. If this equipment does cause harmful interference to radio or television reception, which can be determined by turning the equipment off and on, the user is encouraged to try to correct the interference by one or more of the following measures:

- Reorientate or relocate the receiving antenna.

OPERATING MANUAL

CHERRY B.UNLIMITED AES // Wireless Rechargeable Desktop

- Increase the separation between the equipment and receiver.
- Connect the equipment into an outlet on a circuit different from that to which the receiver is connected.
- Consult the dealer or an experienced radio/TV technician for help.

Caution: Any changes or modifications not expressly approved by the party responsible for compliance could void the user's authority to operate the equipment.

8.3 For UL

For use with Listed Personal Computers only!

The recharging cable is only connecting to USB 1.x or 2.x for power supplying and charging the mouse.



CAUTION: Risk of explosion if batteries are replaced by an incorrect type.

- Dispose of used batteries according to these instructions.