













CORVETTE



1994 CORVETTE OWNER'S MANUAL

Corvette

| | | | |
|--------------|---|------------------|---|
| Introduction | How to Use This Manual | 7 |  |
| Part 1 | Seats & Restraint Systems | 11 |  |
| Part 2 | Features & Controls | 35 |  |
| Part 3 | Comfort Controls & Audio Systems | 105 |  |
| Part 4 | Your Driving and the Road | 121 |  |
| Part 5 | Problems on the Road | 141 |  |
| Part 6 | Service & Appearance Care | 171 |  |
| Part 7 | Maintenance Schedule | 229 |  |
| Part 8 | Customer Assistance Information | 251 |  |
| | Including "Reporting Safety Defects" on page 254. | | |
| Part 9 | Index | 261 |  |
| | Service Station Information | Last Page | |

Important Notes about This Manual

Please keep this manual in your Corvette, so it will be there if you ever need it when you're on the road. If you sell the vehicle, please leave this manual in it so the new owner can use it.

This manual includes the latest information at the time it was printed. We reserve the right to make changes in the product after that time without further notice. For vehicles first sold in Canada, substitute the name "General Motors of Canada Limited" for Chevrolet Motor Division wherever it appears in this manual.

For Canadian Owners Who Prefer a French Language Manual

Aux propriétaires canadiens: Vous pouvez vous procurer un exemplaire de ce guide en français chez votre concessionnaire ou au DGN Marketing Services Ltd., 1500 Bonhill Rd., Mississauga, Ontario L5T 1C7.

Published by:

**Chevrolet Motor Division
General Motors Corporation**

General Motors, GM and the GM emblem, **Chevrolet** and the Chevrolet emblem, and **Corvette** and the Corvette emblem are registered trademarks of General Motors Corporation.

© Copyright 1993 General Motors Corporation, Chevrolet Motor Division. All Rights Reserved.

Corvette: The American Dream Machine



In the early '50s, it was only a designer's dream. Today, the Corvette stands alone as America's dream car – a testament to its unmistakable charisma and the excitement it inspires. Unique styling, powerful performance and an undeniable panache have made Corvette one of the most celebrated sports cars in the world.

In 1953, Chevrolet produced 300 new lightweight fiberglass roadsters. A handful went to project engineers, General Motors managers, and a select group of movie stars and celebrities. With a two-speed Powerglide automatic transmission, Blue Flame six-cylinder engine, and gleaming Polo White exterior, Corvette began its drive into the heart of America.

Designers freshened up the 'Vette in 1956 by adding a removable hardtop and the famous Corvette "coves." The sculptured body enhanced its sporty look, and a standard 210-horsepower Chevy V8 engine solidified Corvette's reputation as a production race car.

In 1963, Corvette hit the road with an eye-catching new look – the Sting Ray coupe. An instant success, the now-classic Sting Ray featured concealed headlamps and a unique split rear window. The split window would only be offered in 1963, making this model among the most prized Corvettes ever built.

Restyled inside and out for 1968, this 'Vette sported a lean and hungry shape, creating a sense of motion even when standing still. And for the first time, Corvette offered removable roof panels,

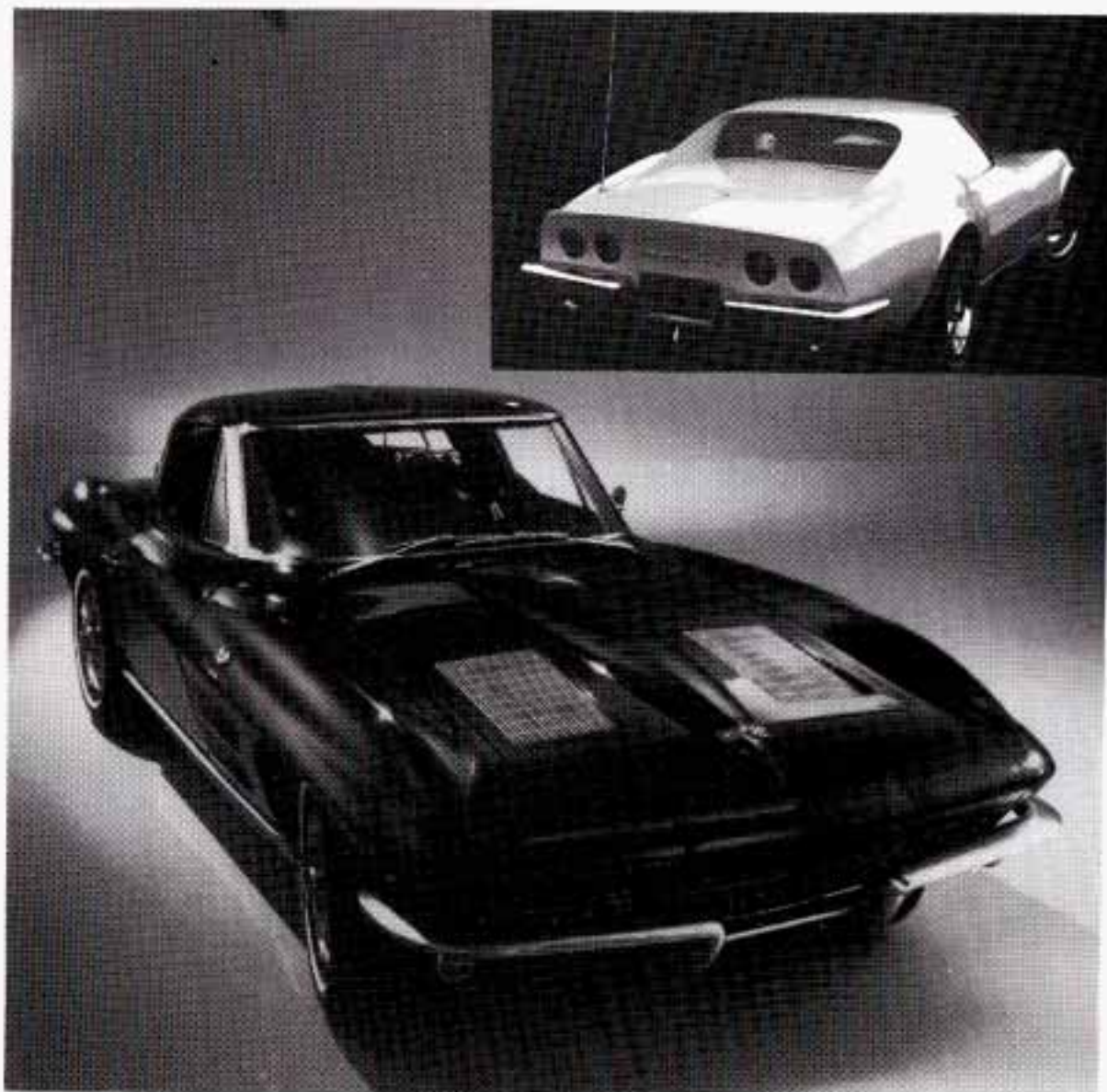



For its 25th anniversary, the 1978 Corvette received a new fastback roofline with a wide expanse of glass that wrapped around the sides. Emblems front and rear identified the '78 'Vette as a Silver Anniversary model.

In 1984, the sixth generation of America's favorite sports car anticipated the future with a sleek look and advanced technology that provided superior handling and performance. Windshield angle was the sheerest of any domestic vehicle, cornering ability the tightest of any production car. In short, the 1984 redesign enhanced the Corvette's reputation as a leader in the world sports car market.

With 41 years of experience and technology under its belt, Corvette only gets better. From the 32-valve, 16 fuel injector, twin double-overhead cam V8 engine in the ZR-1 Special Performance Coupe to state-of-the-art refinements standard on all Corvettes, today's Corvette is a premier driving machine.



The Corvette Assembly Plant in Bowling Green, Kentucky, is one of the most sophisticated and computerized automobile assembly facilities in the world. To build your 1994 Corvette, over 1,200 employees teamed up with the 70 high-tech robots that assist in a variety of processes, from welding to painting.

The Bowling Green facility, which consistently ranks as one of the General Motors' highest quality-producing plants, is Corvette's third home since 1953. Since beginning production in June of 1981, it has become one of Kentucky's most popular tourist attractions.

Corvette Assembly Plant tours are conducted Monday through Friday. Reservations are required for groups of ten or more. For more information, call (502) 745-8228.



■ *How to Use This Manual*

Many people read their owner's manual from beginning to end when they first receive their new vehicle. This will help you learn about the features and controls for your vehicle. In this manual, you'll find that pictures and words work together to explain things quickly.

Index: A good place to look for what you need is the Index in back of the manual. It's an alphabetical list of all that's in the manual, and the page number where you'll find it.

Parts 1-8: Each part of this manual begins with a brief list of its contents, so you can often find at a glance if a part contains the information you want.

How to Use This Manual: This part tells you how to use your manual and includes safety and vehicle damage warnings and symbols.

Part 1 – Seats & Restraint Systems: This part tells you how to use your seats and safety belts properly. It also explains the air bag system.

Part 2 – Features & Controls: This part explains how to start and operate your Corvette.

Part 3 – Comfort Controls & Audio Systems: This part tells you how to adjust the comfort controls and how to operate your sound system.

Part 4 – Your Driving and the Road: Here you'll find helpful information and tips about the road and how to drive under different conditions.

Part 5 – Problems on the Road: This part tells you what to do if you have a problem while driving, such as a flat tire or engine overheating, etc.

Part 6 – Service & Appearance Care: Here the manual tells you how to keep your Corvette running properly and looking good.

Part 7 – Maintenance Schedule: This part tells when to perform vehicle maintenance and what fluids and lubricants to use.

Part 8 – Customer Assistance Information: This part includes important information about reporting safety defects and gives you details about the "Roadside Assistance" program. You will also find customer satisfaction phone numbers (including customer satisfaction numbers for the hearing and speech impaired), as well as the mediation/arbitration procedure. We've also included ordering information for service publications in this part.

Service Station Information: This is a quick reference of service information. You can find it on the last page of this manual.

How to Use This Manual



CAUTION:

These mean there is something that could hurt you or other people.

Safety Warnings and Symbols

You will find a number of safety cautions in this book. We use a box with a gray background and the word **CAUTION** to tell you about things that could hurt you if you were to ignore the warning.

In the gray caution area, we tell you what the hazard is. Then we tell you what to do to help avoid or reduce the hazard. Please read these cautions. If you don't, you or others could be hurt.



You will also find a circle with a slash through it in this book. This safety symbol means "Don't," "Don't do this," or "Don't let this happen."

NOTICE:

These mean there is something that could damage your vehicle.

Vehicle Damage Warnings

Also, in this book you will find these notices.

In the notice area, we tell you about something that can damage your vehicle. Many times, this damage would not be covered by your warranty, and it could be costly. But the notice will tell you what to do to help avoid the damage.

When you read other manuals, you might see **CAUTION** and **NOTICE** warnings in different colors or in different words.

You'll also see warning labels on your vehicle. They use yellow for cautions, blue for notices and the words **CAUTION** or **NOTICE**.

Vehicle Symbols

These are some of the symbols you will find on your vehicle. For example, these symbols are used on an original battery:

Caution Possible Injury 

Protect Eyes by Shielding 

Caustic Battery Acid
Could Cause Burns 

Avoid Sparks or Flames 

Sparks or Flame Could
Explode Battery 

These symbols are important for you and your passengers whenever your vehicle is driven:

Fasten Safety Belts 

These symbols have to do with your lights:

Master Lighting Switch 

Turn Signal Direction 

Hazard Warning Flashers 

Headlight High Beam 

Parking Lights 

Fog Lamps 

These symbols are on some of your controls:

Windshield Wiper 

Windshield Washer 

Windshield Defroster 

Rear Window Defogger 

Ventilating Fan 

Maximum
Air Conditioning 

Windows 

How to Use This Manual

*Normal Air
Conditioning*



Bi-Level



Vent



Heater



These symbols are used on warning and indicator lights:

*Engine Coolant
Temperature*



Battery Charging System



Fuel



Engine Oil Pressure



*Engine Oil
Temperature*



Brake



Anti-Lock Brake System



Engine



Here are some other symbols you may see:

Hatch Release



Hood Release



Lighter



Horn



Speaker



*Acceleration Slip
Regulation*





Here you'll find information about the seats in your Corvette and how to use your safety belts properly. You can also learn about some things you should not do with safety belts.

Part 1

Seats & Restraint Systems

| | |
|--|----|
| Seats and Seat Controls | 12 |
| Safety Belts: They're for Everyone | 14 |
| Why Safety Belts Work | 15 |
| Here Are Questions Many People Ask about | |
| Safety Belts — and the Answers | 18 |
| Safety Belt Reminder Light | 19 |
| How to Wear Safety Belts Properly | 19 |
| Children | 28 |
| Child Restraints | 29 |
| Larger Children | 31 |
| Safety Belt Extender | 33 |
| Checking Your Restraint Systems | 33 |
| Replacing Safety Belts after a Crash | 33 |

Seats and Restraint Systems

■ Seats and Seat Controls

This section tells you about the seats — how to adjust them, and also about reclining front seatbacks, seatback latches and the folding rear seatback.

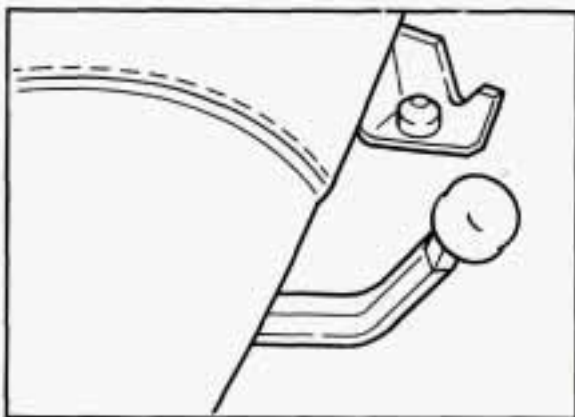

Manual Front Seat



CAUTION:

You can lose control of the vehicle if you try to adjust a manual driver's seat while the vehicle is moving. The sudden movement could startle and confuse you, or make you push a pedal when you don't want to. Adjust the driver's seat only when the vehicle is not moving.

Move the lever under the front of the seat to unlock it. Slide the seat to where you want it. Then release the lever and try to move the seat with your body, to make sure the seat is locked into place.

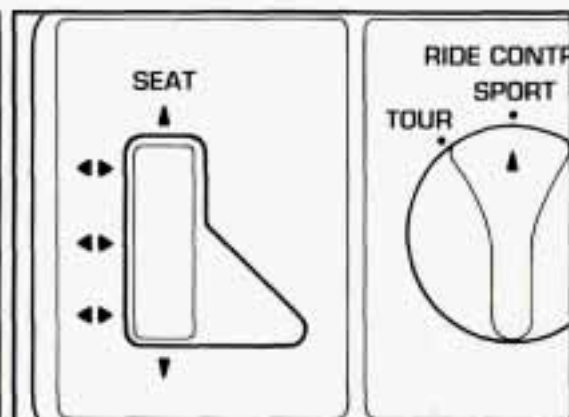

Power Seat (OPTION)

Different parts of this control move different parts of your seat. If you move the whole control, the whole seat will move. The back of the control will move the back of the seat, and the front of the control will move the front of the seat.

If you have the Sport Seat, you must move the switch next to the lumbar controls to "DR" (driver) or "PS" (passenger) before adjusting your seat.

Move the control forward or back to move the seat forward or back. Move the control toward the center of the vehicle to raise the seat and away from the center of the vehicle to lower it.

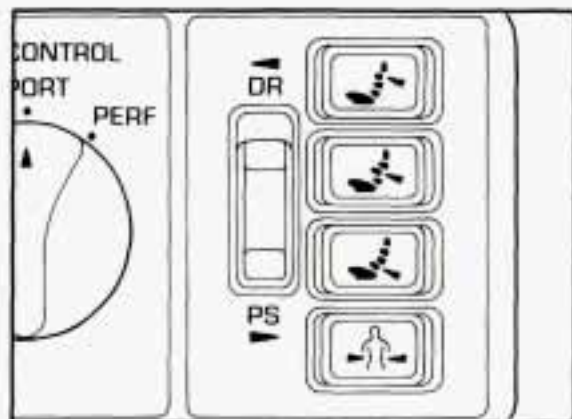

Sport Seat (OPTION)

These switches let you change the shape of your seat. The pictures show you which lumbar support the switch controls.

First move the selector switch to "DR" (driver) or "PS" (passenger). Then move the shaping switches until your seat is comfortable. Move each switch left to inflate or right to deflate.

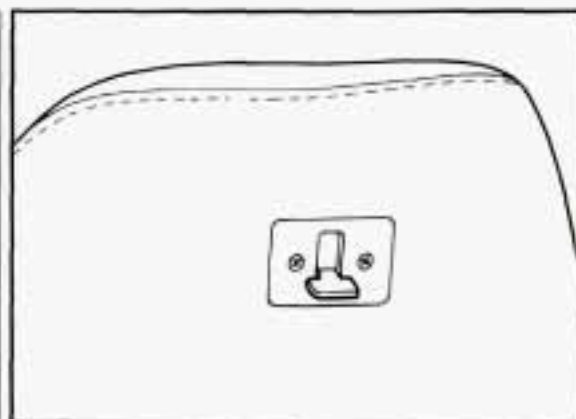

Seatback Latches

Both seatbacks fold forward to give you access to the rear area. To fold a seatback forward, lift this latch and push the seatback forward. When you return the seatback to its original position, make sure the seatback is locked.

⚠ CAUTION:

If the seatback isn't locked, it could move forward in a sudden stop or crash. That could cause injury to the person sitting there. Always press rearward on the seatback to be sure it is locked.

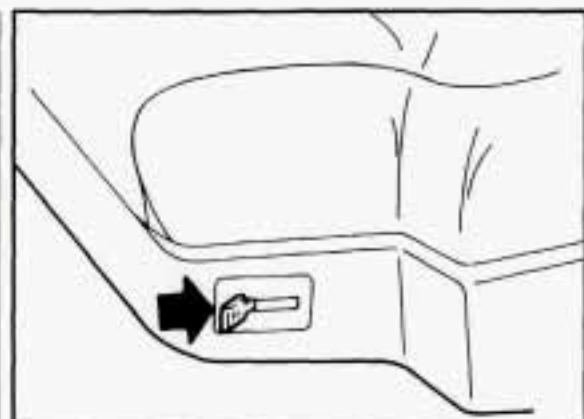

Manual Reclining Seatbacks

To adjust the seatback, push the lever back and move the seatback to where you want it. Release the lever to lock the seatback in place.

Don't have the seatback reclined if your vehicle is moving.

Seats and Restraint Systems



CAUTION:

Sitting in a reclined position when your vehicle is in motion can be dangerous. Even if you buckle up, your safety belts can't do their job when you're reclined like this.

The shoulder belt can't do its job because it won't be against your body. Instead, it will be in front of you. In a crash you could go into it, receiving neck or other injuries.

The lap belt can't do its job either. In a crash the belt could go up over your abdomen. The belt forces would be there, not at your pelvic bones. This could cause serious internal injuries.

For proper protection when the vehicle is in motion, have the seatback upright. Then sit well back in the seat and wear your safety belt properly.

■ *Safety Belts: They're for Everyone*

This part of the manual tells you how to use safety belts properly. It also tells you some things you should not do with safety belts.

And it explains the Supplemental Inflatable Restraint, or "air bag" system.

CAUTION:

Don't let anyone ride where they can't wear a safety belt properly. If you are in a crash and you're not wearing a safety belt, your injuries can be much worse. You can hit things inside the vehicle or be ejected from it. You can be seriously injured or killed. In the same crash, you might not be if you are buckled up. Always fasten your safety belt, and check that your passenger's belt is fastened properly too.



This figure lights up as a reminder to buckle up. (See "Safety Belt Reminder Light" in the Index.)

In many states and Canadian provinces, the law says to wear safety belts. Here's why: They work.



You never know if you'll be in a crash. If you do have a crash, you don't know if it will be a bad one.

A few crashes are mild, and some crashes can be so serious that even buckled up a person wouldn't survive. But most crashes are in between. In many of them, people who buckle up can survive and sometimes walk away. Without belts they could have been badly hurt or killed.

After more than 25 years of safety belts in vehicles, the facts are clear. In most crashes buckling up does matter ... a lot!



■ *Why Safety Belts Work*

When you ride in or on anything, you go as fast as it goes.

For example, if the bike is going 10 mph (16 km/h), so is the child.

Seats and Restraint Systems

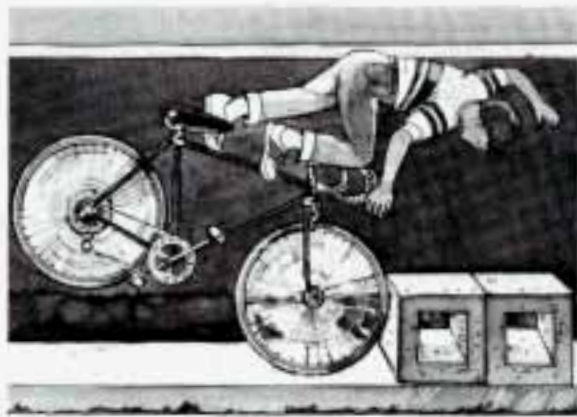

When the bike hits the block, it stops. But the child keeps going!

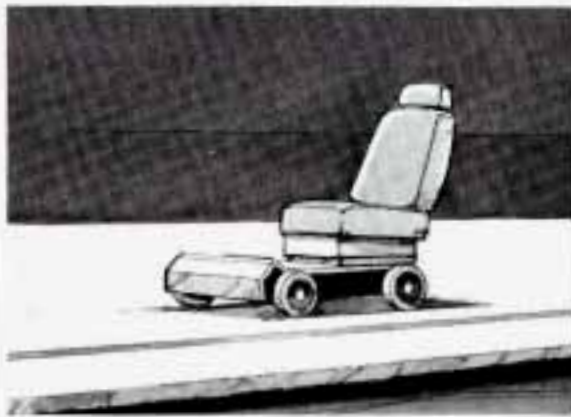

Take the simplest vehicle. Suppose it's just a seat on wheels.

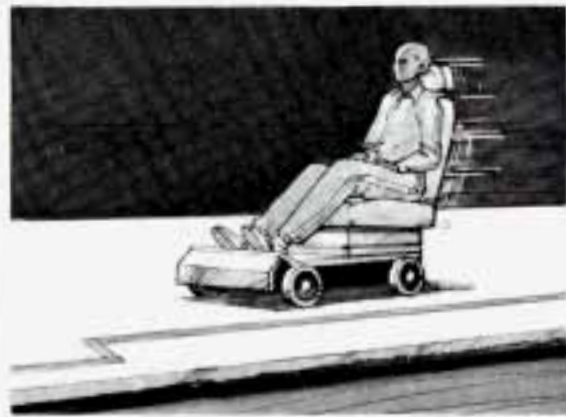

Put someone on it.



Get it up to speed. Then stop the vehicle.
The rider doesn't stop.



The person keeps going until stopped by
something.

In a real vehicle, it could be the
windshield ...

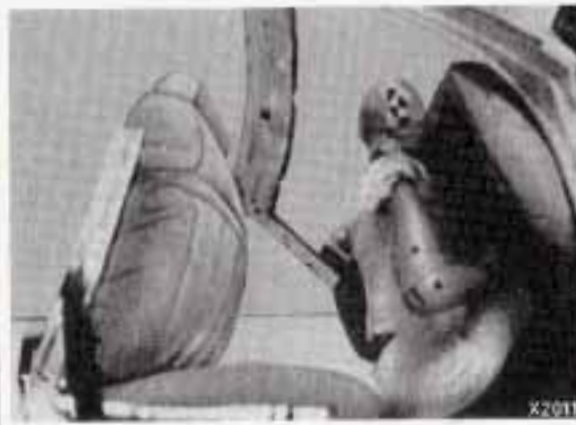

or the instrument panel ...

Seats and Restraint Systems



or the safety belts!

With safety belts, you slow down as the vehicle does. You get more time to stop. You stop over more distance, and your strongest bones take the forces. That's why safety belts make such good sense.

■ *Here Are Questions Many People Ask about Safety Belts — and the Answers*

Q: Won't I be trapped in the vehicle after an accident if I'm wearing a safety belt?

A: You could be — whether you're wearing a safety belt or not. But you can easily unbuckle a safety belt, even if you're upside down. And your chance of being conscious during and after an accident, so you can unbuckle and get out, is much greater if you are belted.

Q: Why don't they just put in air bags so people won't have to wear safety belts?

A: Air bags, or Supplemental Inflatable Restraint systems, are in some vehicles today and will be in more of them in the future. But they are supplemental systems only — so they work with safety belts, not instead of them. Every air bag system ever offered for sale has required the use of

safety belts. Even if you're in a vehicle that has air bags, you still have to buckle up to get the most protection. That's true not only in frontal collisions, but especially in side and other collisions.

Q: If I'm a good driver, and I never drive far from home, why should I wear safety belts?

A: You may be an excellent driver, but if you're in an accident — even one that isn't your fault — you and your passenger can be hurt. Being a good driver doesn't protect you from things beyond your control, such as bad drivers.

Most accidents occur within 25 miles (40 km) of home. And the greatest number of serious injuries and deaths occur at speeds of less than 40 mph (65 km/h).

Safety belts are for everyone.



■ *Safety Belt Reminder Light*

When the key is turned to "Run" or "Start," a chime will come on for about eight seconds to remind people to fasten their safety belts, unless the driver's safety belt is already buckled. The safety belt light will also come on and stay on until the driver's belt is buckled.

■ *How to Wear Safety Belts Properly*

Adults

This section is only for people of adult size.

Be aware that there are special things to know about safety belts and children. And there are different rules for smaller children and babies. If a child will be riding in your Corvette, see the section after this one, called "Children." Follow those rules for everyone's protection.

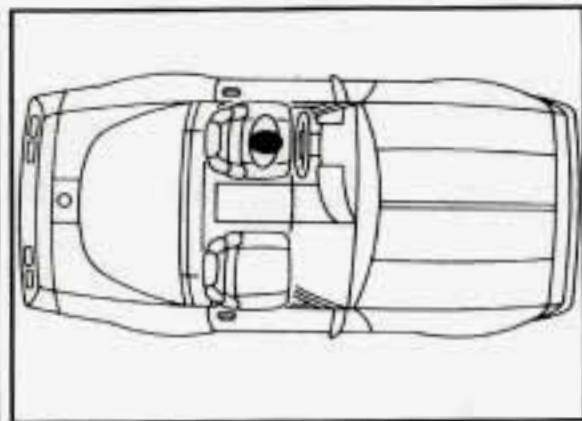

First, you'll want to know which restraint systems your vehicle has.

We'll start with the driver position.

Driver Position

This section describes the driver's restraint system.

Seats and Restraint Systems



Lap-Shoulder Belt

The driver has a lap-shoulder belt. Here's how to wear it properly.

1. Close and lock the door.
2. Adjust the seat (to see how, see "Seats" in the Index) so you can sit up straight.



3. Pick up the latch plate and pull the belt across you. Don't let it get twisted.
4. Push the latch plate into the buckle until it clicks.
Pull up on the latch plate to make sure it is secure. If the belt isn't long enough, see "Safety Belt Extender" at the end of this section.

Make sure the release button on the buckle is positioned so you would be able to unbuckle the safety belt quickly if you ever had to.

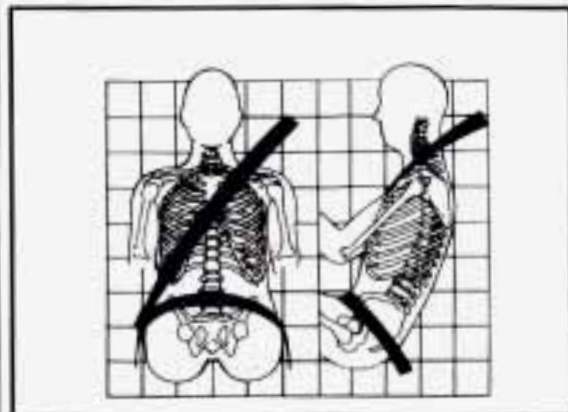

The lap part of the belt should be worn low and snug on the hips, just touching the thighs. In a crash, this applies force to the strong pelvic bones. And you'd be less likely to slide under the lap belt. If you slid under it, the belt would apply force at your abdomen. This could cause serious or even fatal injuries. The shoulder belt should go over the shoulder and across the chest. These parts of the body are best able to take belt restraining forces.

The safety belt locks if there's a sudden stop or crash.



Lap Belt Cinch Feature

If you do not want the lap belt to move freely, push the "cinch" button. To loosen the belt, unbuckle it, let it retract, and buckle up again.

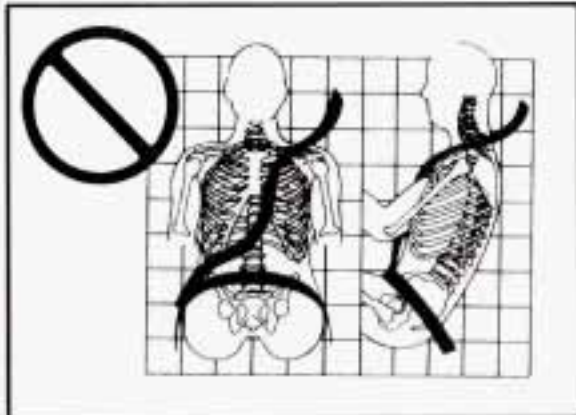

Q: What's wrong with this?

A: The shoulder belt is too loose. It won't give nearly as much protection this way.



CAUTION:

You can be seriously hurt if your shoulder belt is too loose. In a crash you would move forward too much, which could increase injury. The shoulder belt should fit against your body.

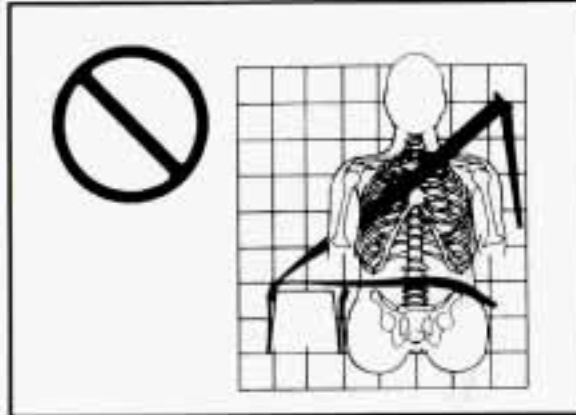

Q: What's wrong with this?

A: The belt is buckled in the wrong place.



CAUTION:

You can be seriously injured if your belt is buckled in the wrong place like this. In a crash, the belt would go up over your abdomen. The belt forces would be there, not at the pelvic bones. This could cause serious internal injuries. Always buckle your belt into the buckle nearest you.

Seats and Restraint Systems

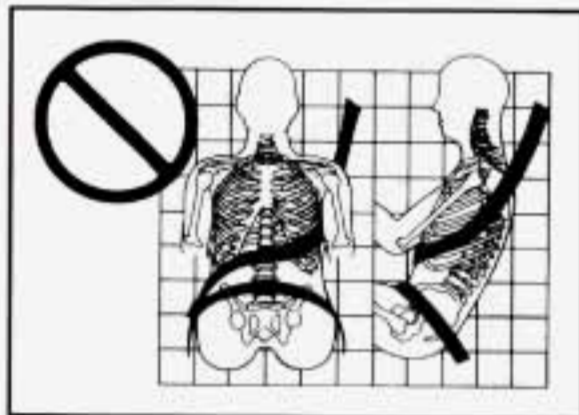

Q: What's wrong with this?

A: The shoulder belt is worn under the arm. It should be worn over the shoulder at all times.

CAUTION:

You can be seriously injured if you wear the shoulder belt under your arm. In a crash, your body would move too far forward, which would increase the chance of head and neck injury. Also, the belt would apply too much force to the ribs, which aren't as strong as shoulder bones. You could also severely injure internal organs like your liver or spleen.

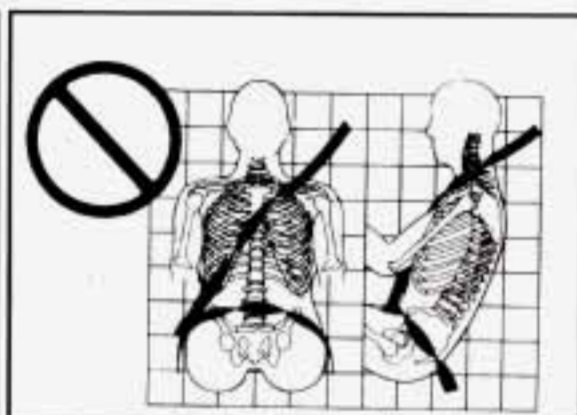

Q: What's wrong with this?

A: The belt is twisted across the body.

CAUTION:

You can be seriously injured by a twisted belt. In a crash, you wouldn't have the full width of the belt to spread impact forces. If a belt is twisted, make it straight so it can work properly, or ask your dealer to fix it.



To unlatch the belt, just push the button on the buckle. The belt should go back out of the way.

Before you close the door, be sure the belt is out of the way. If you slam the door on it, you can damage both the belt and your vehicle.

This vehicle has **AIR BAGS** for front occupants.

 **CAUTION: YOU NEED YOUR SAFETY BELT, EVEN WITH AN AIR BAG. AND HERE'S WHY:**

- Air bags are not designed to inflate in rollovers or in rear, side or low-speed frontal crashes.
- Air bags inflate with great force, faster than the blink of an eye. If you're too close to an inflating air bag, it could seriously injure you. Safety belts help keep you in position for air bag inflation in a crash.
- An inflating air bag can seriously injure small children. Follow the instructions on the passenger safety belt Caution label.

REGULAR MAINTENANCE OF THE AIR BAG SYSTEM IS NOT REQUIRED. If the air bag readiness light comes on while you are driving, or doesn't come on when you first start your vehicle, see your Dealer for service.

Printed in U.S.A.

See your Owner's Manual for more information.

PT. NO. 1823987



CAUTION:

Air bags inflate with great force, faster than the blink of an eye. If you're too close to an inflating air bag, it could seriously injure you. Safety belts help keep you in position for an air bag inflation in a crash. Always wear your safety belt, even with an air bag, and the driver should sit as far back as possible while still maintaining control of the vehicle.

Air Bag System

This section explains the air bag system. Your Corvette has an air bag for the driver and the passenger.

Here are the most important things to know:



CAUTION:

Even with an air bag, if you're not wearing a safety belt and you're in a crash, your injuries may be much worse. Air bags are not designed to inflate in rollovers or in rear, side or low-speed frontal crashes. You need to wear your safety belt to reduce the chance of hitting things inside the vehicle or being ejected from it. Always wear your safety belt, even with an air bag.



CAUTION:

An inflating air bag can seriously injure small children. Always secure children properly in your vehicle. To read how, see the "Children and Safety Belts" section of this manual, and read the caution label on the front-passenger's safety belt.

Seats and Restraint Systems



CAUTION:

When an air bag inflates, there is dust in the air. This dust could cause breathing problems for people with a history of asthma or other breathing trouble. To avoid this, everyone in the vehicle should get out as soon as it is safe to do so. If you have breathing problems but can't get out of the vehicle after an air bag inflates, then get fresh air by opening a window or door.



CAUTION:

Don't put anything on, or attach anything to, the driver air bag or instrument panel. Also, don't put anything (such as pets, or objects) between any occupant and the driver air bag or instrument panel. If something is between an occupant and an air bag, it could affect the performance of the air bag, or, worse, it could cause injury.

AIR BAG

Air Bag Readiness Light

There is an air bag readiness light on the instrument panel, which shows "AIR BAG." The system checks for electrical malfunctions, and the light tells you if there is a problem.

You will see this light flash for a few seconds when you turn your ignition to "Run" or "Start." Then the light should go out, which means the system is ready.

Remember, if the air bag readiness light doesn't come on when you start your vehicle, or stays on, or comes on when you are driving, your air bag system may not work properly. Have your vehicle serviced right away.



How the Air Bag System Works

Where is the air bag?

The driver's air bag is in the middle of the steering wheel.



The right-front passenger's air bag is located in the instrument panel on the passenger's side.

When is an air bag expected to inflate?

The air bag is designed to inflate in moderate to severe frontal or near-frontal crashes. The air bag will only inflate if the velocity of the impact is above the designed threshold level. When impacting straight into a wall that does not move or deform, the threshold level for most GM vehicles is between 9 and 15 mph (14 and 23 km/h). However, this velocity threshold depends on the vehicle design and may be several miles-per-hour faster or slower. In addition, this threshold velocity will be considerably higher if the vehicle strikes an object such as a parked

car which will move and deform on impact. The air bag is also not designed to inflate in rollovers, side impacts, or rear impacts where the inflation would provide no occupant protection benefit.

It is possible that in a crash, only one of the two air bags in your Corvette will deploy. This is rare, but can happen in a crash just severe enough to make an air bag inflate.

In any particular crash, the determination of whether the air bag should have inflated cannot be based solely on the level of damage on the vehicle(s). Inflation is determined by the angle of the impact and the vehicle's deceleration, of which vehicle damage is only one indication. Repair cost is not a good indicator of whether an air bag should have deployed.

What makes an air bag inflate?

In a frontal or near-frontal impact of sufficient severity, the air bag sensing system detects that the vehicle is suddenly stopping as a result of a crash. The sensing system triggers a chemical reaction of the sodium azide sealed in the inflator. The reaction produces nitrogen gas, which inflates a cloth bag. The

inflator, cloth bag, and related hardware are all part of the air bag inflator modules packed inside the steering wheel and in the instrument panel in front of the passenger.

How does an air bag restrain?

In moderate to severe frontal or near-frontal collisions, even belted occupants can contact the steering wheel or the instrument panel. The air bag supplements the protection provided by safety belts. Air bags distribute the force of the impact more evenly over the occupant's upper body, stopping the occupant more gradually. But air bags would not provide protection in many types of collisions, including rollovers and rear and side impacts, primarily because an occupant's motion is not toward the air bag. Air bags should never be regarded as anything more than a supplement to safety belt protection in moderate to severe frontal and near-frontal collisions.

What will you see after an air bag inflation?

After the air bag has inflated, it will then quickly deflate. This occurs so quickly that some people may not even realize

Seats and Restraint Systems

that the air bag inflated. Some components of the air bag module in the steering wheel hub for the driver's air bag or the instrument panel for the passenger's bag may be hot for a short time, but the portion of the bag that comes into contact with you will not be hot to the touch. There will be small amounts of smoke and dust coming from vents in the deflated air bags. The air bag will not impede the driver's vision or ability to steer the vehicle, nor will it hinder the occupants from exiting the vehicle.

In many crashes severe enough to inflate an air bag, windshields are broken by vehicle deformation. Additional windshield breakage may occur in vehicles with passenger air bags because the windshield acts as a reaction surface for the inflating air bag.

- The air bags are designed to inflate only once. After they inflate, you'll need some new parts for your air bag system. If you don't get them, the air bag system won't be there to help protect you in another crash. A new system will include air bag modules and possibly other parts. The service

manual has information about the need to replace other parts.

- Your vehicle is equipped with a diagnostic module, which records information about the air bag system if the air bag deploys in a crash. The module records information about the readiness of the system, which sensors activated the deployment, and whether the driver's safety belt was in use.
- Let only qualified technicians work on your air bag system. Improper service can mean that your air bag system won't work properly. See your dealer for service.

NOTICE:

If you damage the cover for the driver's or the right-front passenger's air bag, they may not work properly. You may have to replace the air bag on the steering wheel or both the air bag and the instrument panel for the passenger's air bag. Do not open or break the air bag covers.

Is the smoke from an air bag inflation harmful?

The particles emitted during air bag inflation are not harmful to most people. Some people with respiratory ailments may experience difficulty breathing if they stay in the vehicle with the windows closed after air bag inflation. So, if your air bag inflates, you and any passengers should exit the vehicle if and when it is safe to do so. If you or your passengers can't get out of the vehicle, try to get fresh air by opening a window, turning on the fan, or opening a door.

Servicing Your Air Bag-Equipped Corvette

Air bags affect how your Corvette should be serviced. There are parts of the air bag system in several places around your vehicle. You don't want the system to inflate while someone is working on your vehicle. Your Chevrolet dealer and the 1994 Corvette Service Manual have information about servicing your vehicle and the air bag system. The air bag system does not need regular maintenance.

 **CAUTION:**

For up to 2 minutes after the ignition key is turned off and the battery is disconnected, an air bag can still inflate during improper service. You can be injured if you are close to an air bag when it inflates. Avoid yellow wires, wires wrapped with yellow tape, or yellow connectors. They are probably part of the air bag system. Be sure to follow proper service procedures, and make sure the person performing work for you is qualified to do so.

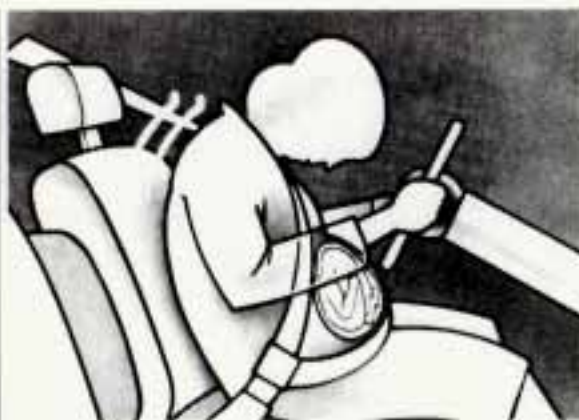

Safety Belt Use during Pregnancy

Safety belts work for everyone, including pregnant women. Like all occupants, they are more likely to be seriously injured if they don't wear safety belts.

A pregnant woman should wear a lap-shoulder belt, and the lap portion should be worn as low as possible throughout the pregnancy.

The best way to protect the fetus is to protect the mother. When a safety belt is worn properly, it's more likely that the fetus won't be hurt in a crash. For pregnant women, as for anyone, the key to making safety belts effective is wearing them properly.

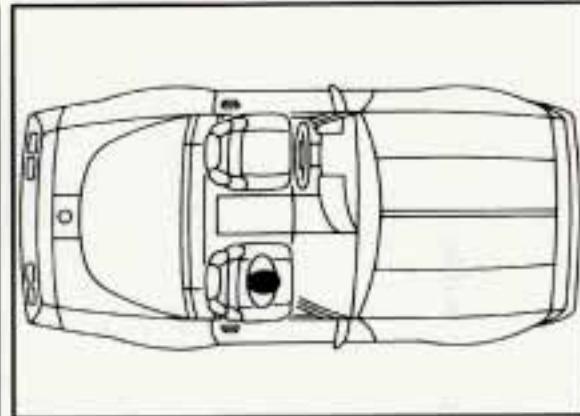

Passenger Position

The passenger's safety belt works the same way as the driver's safety belt. See "Driver Position," earlier in this part.

Seats and Restraint Systems



■ *Children*

Everyone in a vehicle needs protection! That includes infants and all children smaller than adult size. In fact, the law in every state in the United States and in every Canadian province says children up to some age must be restrained while in a vehicle.

Smaller Children and Babies

CAUTION:

Smaller children and babies should always be restrained in a child restraint. However, infants who should be restrained in a rear-facing child restraint cannot ride safely in this vehicle. The instructions for the restraint will say whether it is the right type and size for your child. A very young child's hip bones are so small that a regular belt might not stay low on the hips, as it should. Instead, the belt will likely be over the child's abdomen. In a crash the belt would apply force right on the child's abdomen, which could cause serious or fatal injuries. So if a forward-facing child restraint is suitable for your child, be sure the child is always properly restrained.



CAUTION:

Never hold a baby in your arms while riding in a vehicle. A baby doesn't weigh much — until a crash. During a crash a baby will become so heavy you can't hold it. For example, in a crash at only 25 mph (40 km/h), a 12-pound (5.5 kg) baby will suddenly become a 240-pound (110 kg) force on your arms. The baby would be almost impossible to hold.

■ *Child Restraints*

Be sure to follow the instructions for the restraint. You may find these instructions on the restraint itself or in a booklet, or both. These restraints use the belt system in your vehicle, but the child also has to be secured within the restraint to help reduce the chance of personal injury.

The instructions that come with the child restraint will show you how to do that. The child restraint must be secured properly in the passenger seat.

Keep in mind that an unsecured child restraint can move around in a collision or sudden stop and injure people in the vehicle. Be sure to properly secure any child restraint in your vehicle – even when no child is in it.



Top Strap

If your child restraint has a top strap, it should be anchored.

If you have a convertible, don't use a restraint like that in your vehicle because the top strap anchor cannot be installed properly. You shouldn't use this type of restraint without anchoring the top strap.

If your vehicle is not a convertible and you need to have an anchor installed, you can ask your Chevrolet dealer to put one in for you. If you want to install an anchor yourself, your dealer can tell you how to do it.

For cars first sold in Canada, child restraints with a top strap must be anchored according to Canadian Law.

Your dealer can obtain the hardware kit and install it for you, or you may install it yourself using the instructions provided in the kit.

Use the tether hardware kit available from the dealer. The hardware and installation instructions were specifically designed for this vehicle.

Seats and Restraint Systems

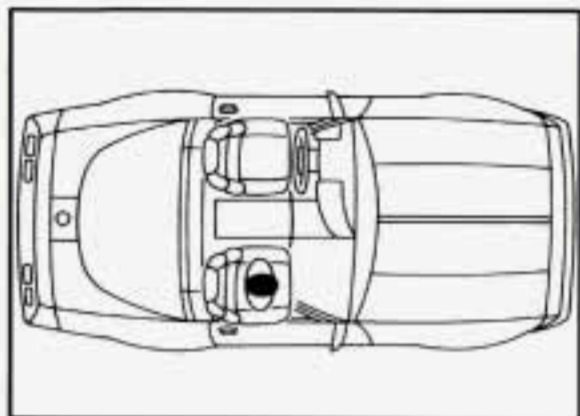

Securing a Child Restraint in the Passenger Seat

Your vehicle has a right-front passenger's air bag. NEVER put a rear-facing child restraint in this vehicle. Here's why:

CAUTION:

A child in a rear-facing child restraint can be seriously injured if the passenger's air bag inflates. This is because the back of a rear-facing child restraint would be very close to the inflating air bag. Do not use a rear-facing child restraint in this vehicle.

If a forward-facing child restraint is suitable for your child, ALWAYS move the passenger seat as far back as it will go.

You'll be using the lap-shoulder belt. See the earlier section about the top strap if the child restraint has one.

1. Because your vehicle has a right-front passenger's air bag, always move the seat as far back as it will go before securing a front-facing child restraint.
2. Put the restraint on the seat. Follow the instructions for the child restraint.
3. Secure the child in the child restraint as the instructions say.



4. Pick up the latch plate, and run the lap and shoulder portions of the vehicle's safety belt through or around the restraint. The child restraint instructions will show you how.

If the shoulder belt goes in front of the child's face or neck, put it behind the child restraint.

5. Buckle the belt.

Make sure the release button is positioned so you would be able to unbuckle the safety belt quickly if you ever had to.



6. Push the "cinch" button. See "Lap-Shoulder Belt" in the Index, where we describe the cinch feature.
7. To tighten the belt, feed the lap belt back into the retractor while you push down on the child restraint.



8. Push and pull the child restraint in different directions to be sure it is secure.

To remove the child restraint, just unbuckle the vehicle's safety belt and let it go back all the way.

The safety belt will move freely again and be ready to work for an adult or larger child passenger.



■ *Larger Children*

Children who have outgrown child restraints should wear the vehicle's safety belts.

- Children who aren't buckled up can be thrown out in a crash.
- Children who aren't buckled up can strike other people who are.

Seats and Restraint Systems



CAUTION:

Never do this.

Here two children are wearing the same belt. The belt can't properly spread the impact forces. In a crash, the two children can be crushed together and seriously injured. A belt must be used by only one person at a time.

Q. What if a child is wearing a lap-shoulder belt, but the child is so small that the shoulder belt is very close to the child's face or neck?

A: Move the child toward the center of the vehicle, but be sure that the shoulder belt still is on the child's shoulder, so that in a crash the child's upper body would have the restraint that belts provide.



CAUTION:

Never do this.

Here a child is sitting in a seat that has a lap-shoulder belt, but the shoulder part is behind the child. If the child wears the belt in this way, in a crash the child might slide under the belt. The belt's force would then be applied right on the child's abdomen. That could cause serious or fatal injuries.

The lap portion of the belt should be worn low and snug on the hips, just touching the child's thighs. This applies belt force to the child's pelvic bones in a crash.

■ *Safety Belt Extender*

If the vehicle's safety belt will fasten around you, you should use it.

But if a safety belt isn't long enough to fasten, your dealer will order you an extender. It's free. When you go in to order it, take the heaviest coat you will wear, so the extender will be long enough for you. The extender will be just for you, and just for the seat in your vehicle that you choose. Don't let someone else use it, and use it only for the seat it is made to fit. To wear it, just attach it to the regular safety belt.

■ *Checking Your Restraint Systems*

Now and then, make sure all your belts, buckles, latch plates, retractors, anchorages and reminder systems are working properly. Look for any loose parts or damage. If you see anything that might keep a restraint system from doing its job, have it repaired.

■ *Replacing Safety Belts after a Crash*

If you've had a crash, do you need new belts?

After a very minor collision, nothing may be necessary. But if the belts were stretched, as they would be if worn during a more severe crash, then you need new belts.



If you ever see a label on the passenger's safety belt that says to replace the belt, be sure to do so. Then the new belt will be there to help protect you in an accident. You will see this label on the belt near the latch plate.

If belts are cut or damaged, replace them. Collision damage also may mean you will need to have safety belt or seat parts repaired or replaced. New parts and repairs may be necessary even if the belt wasn't being used at the time of the collision.

Seats and Restraint Systems

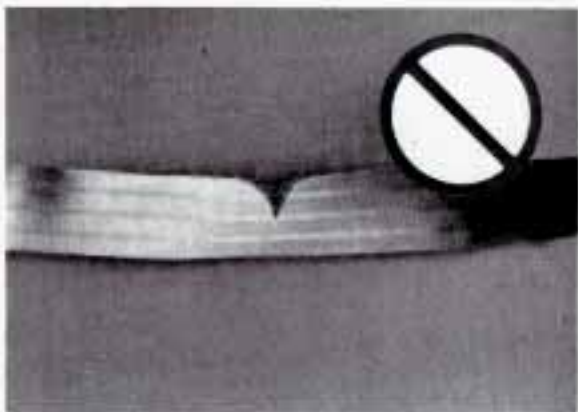

Q: What's wrong with this?

A: The belt is torn. Torn or frayed belts may not protect you in a crash. They can rip apart under impact forces. If a belt is torn or frayed, get a new one right away.



Here you can learn about the many standard and optional features on your Corvette, and information on starting, shifting and braking. Also explained are the instrument panel and the warning systems that tell you if everything is working properly — and what to do if you have a problem.

Part 2

Features & Controls

| | |
|--|----|
| Keys | 36 |
| Door Locks | 37 |
| Theft and Theft Deterrents | 43 |
| New Vehicle "Break-In" | 46 |
| Ignition Switch | 46 |
| Starting Your Engine | 47 |
| Automatic Transmission | 51 |
| Manual Transmission | 53 |
| Selective Ride Control | 56 |
| Limited-Slip Rear Axle | 56 |
| Parking | 56 |
| Engine Exhaust | 59 |
| Windows | 60 |
| Horn | 60 |
| Tilt Wheel | 61 |
| The Turn Signal/Headlight Beam Lever | 61 |
| Operation of Lights | 66 |
| Mirrors | 69 |
| Roof Panel | 70 |
| Storage and Compartments | 72 |
| Sun Visors | 74 |
| Ashtray and Lighter | 75 |
| Accessory Plug | 76 |
| Instrument Panel and Cluster | 78 |
| Convertible Top | 96 |

Features and Controls

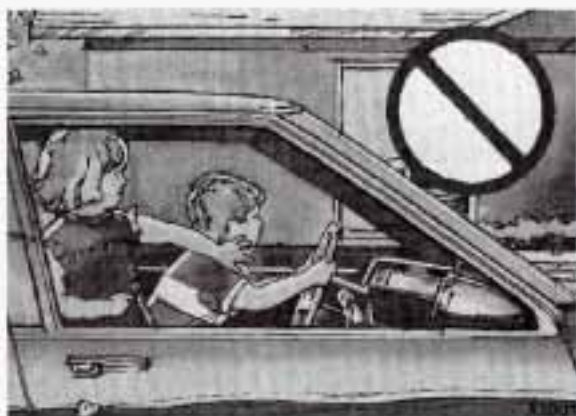

■ Keys



CAUTION:

Leaving young children in a vehicle with the ignition key is dangerous for many reasons. A child or others could be badly injured or even killed.

They could operate power windows or other controls or even make the vehicle move. Don't leave the keys in a vehicle with young children.

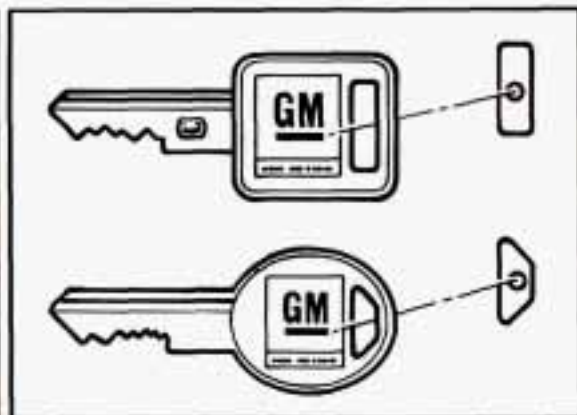

The square ignition keys are for the ignition only, and the oval door keys are for the doors and all other locks.

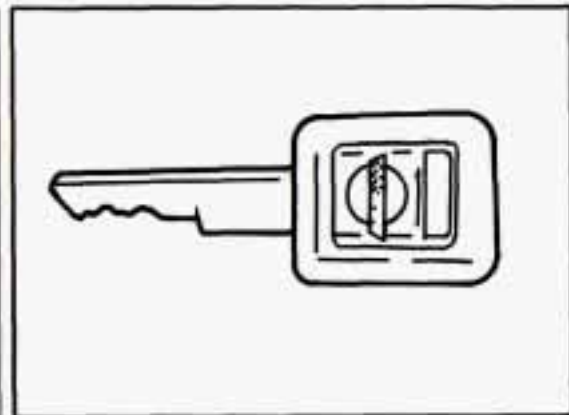

If you have a ZR-1, your vehicle has an engine power switch, which uses a third key.

When a new Corvette is delivered, the dealer removes the plugs from the keys, and gives them to the first owner. However, the ignition key may not have a plug.

If the ignition key doesn't have a plug, there will be a bar-coded key tag instead. Each plug or tag has a code on it that tells your dealer or a qualified locksmith how to make extra keys. Keep the plugs in a safe place. If you lose your keys, you'll be able to have new ones made easily using these plugs. If your ignition keys don't have plugs, go to your Chevrolet dealer for the correct key code if you need a new ignition key.

NOTICE:

Your Corvette has a number of new features that can help prevent theft. But you can have a lot of trouble getting into your vehicle if you ever lock your keys inside. You may even have to damage your vehicle to get in. So be sure you have extra keys.

■ Door Locks

CAUTION:

Unlocked doors can be dangerous. Passengers — especially children — can easily open the doors and fall out. When a door is locked, the inside handle won't open it.

Outsiders can easily enter through an unlocked door when you slow down or stop your vehicle.

This may not be so obvious: You increase the chance of being thrown out of the vehicle in a crash if the doors aren't locked. Wear safety belts properly, lock your doors, and you will be far better off whenever you drive your vehicle.



There are several ways to lock and unlock your vehicle:

From the outside, use your door key or the passive keyless entry transmitter.

If your theft deterrent system is armed, unlock the doors only with the key or the transmitter to avoid setting off the alarm. Refer to "Universal Theft Deterrent" in the Index.

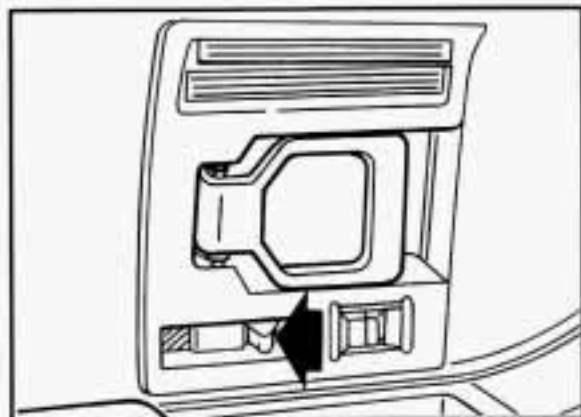

To lock the door from the inside, move the lock control on the door back. To unlock it, move the lock control on the door forward.

Features and Controls

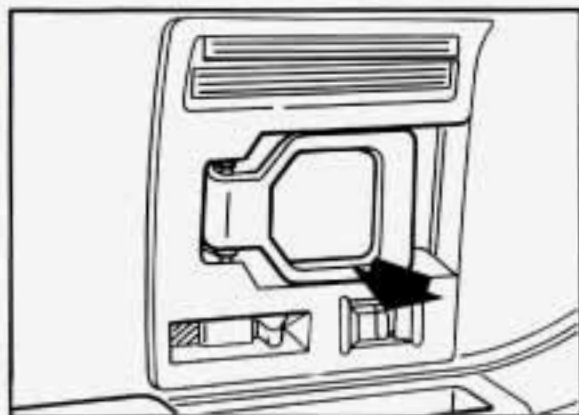

Power Door Locks

Push the power door lock switch on either door back to lock or unlock both doors at once.

Leaving Your Vehicle

If you are leaving the vehicle, take your keys, open your door and set the locks from inside. Then get out and close the door.

Your vehicle has a theft deterrent system. See "Universal Theft Deterrent" in the Index.



Passive Keyless Entry System

With Passive Keyless Entry (PKE), your vehicle will disarm or arm your theft deterrent system and lock or unlock your doors when you are about three to seven feet (one to two meters) away, if you are carrying the PKE transmitter. Your Corvette was shipped with one PKE transmitter, but up to three can be matched to your vehicle. See "Matching Transmitters to Your Vehicle" later in this section.

Your Passive Keyless Entry system operates on a radio frequency subject to Federal Communications Commission (FCC) Rules.

This device complies with Part 15 of the FCC Rules. Operation is subject to the following two conditions: (1) This device may not cause harmful interference, and (2) This device must accept any interference received, including interference that may cause undesired operation.

Should interference to this system occur, try this:

- Check to determine if battery replacement is necessary. See the instructions on battery replacement.
- Check the distance. You may be too far from your vehicle. This product has a maximum range.
- Check the location. Other vehicles or objects may be blocking the signal.
- See your Chevrolet dealer or a qualified technician for service.

Changes or modifications to this system by other than an authorized service facility could void authorization to use this equipment.

Operation

You don't have to do anything for PKE to work when the passive feature is on. Just walk toward your vehicle with the PKE

transmitter, and the system will automatically disarm your theft deterrent system and unlock the doors. If it's dark enough outside, your interior lights will come on.

If you move out of range, the PKE system will:

1. Lock the doors after five seconds.
2. Arm the theft deterrent system.
3. Sound the horn to let you know the doors are locked.
4. Turn off the interior lights.

You can also use the buttons on the transmitter. Press "DOOR" to open the passenger's door or "HATCH" to open the hatch. The "HATCH" button will only work when the ignition is off.

The system has a feature that makes it difficult for you to lock your keys in your vehicle. If you leave your keys in the ignition and lock the doors, the system will unlock the doors as soon as they are closed. If you leave the keys in the ignition and move away with the transmitter, the doors still will not lock. You should notice that the horn doesn't sound and return to get your keys.

If you shake the transmitter, you may hear a slight rattle. This sound is from the motion sensor inside the transmitter. It does not indicate that anything is wrong with your transmitter.

The system will allow you to lock your keys in the vehicle if you didn't leave them in the ignition. You should, however, be able to use the transmitter to get them out. After 26 seconds of no motion, the transmitter shuts down to save the battery. Wait about 30 seconds, then rock the vehicle. The transmitter should "wake up" and unlock the doors.

This system can't guarantee that you'll never be locked out of your vehicle. If the battery is low or if the transmitter is in a place where the signal can't get to the antenna, it won't unlock the doors. Always remember to take your keys with you.

PKE Settings

You can use the system for both doors or just the driver's door, or you can turn the system off.

To change door settings:

1. Put the ignition key in the ignition, but don't turn it on.

2. Press "DOOR" on the transmitter until the door locks cycle (about two seconds).

To turn the system off:

1. Take the ignition key out of the ignition.
2. Press "DOOR" on the transmitter until the door locks cycle (about two seconds).

To turn the system back on, just repeat the steps.

To check that the system is off, turn on the ignition. The "PASSIVE KEYLESS ENTRY" light on the Driver Information Center should not come on. If the light does come on for a second or two, then the PKE system is still on.

You can also check whether the system is on or off by closing the door and walking away with the keys and transmitter. If the doors lock, the system is on.

If you are working around your vehicle and keeping your keys with you, you might want to turn the PKE system off. If you don't, the transmitter will keep locking and unlocking your doors.

Features and Controls

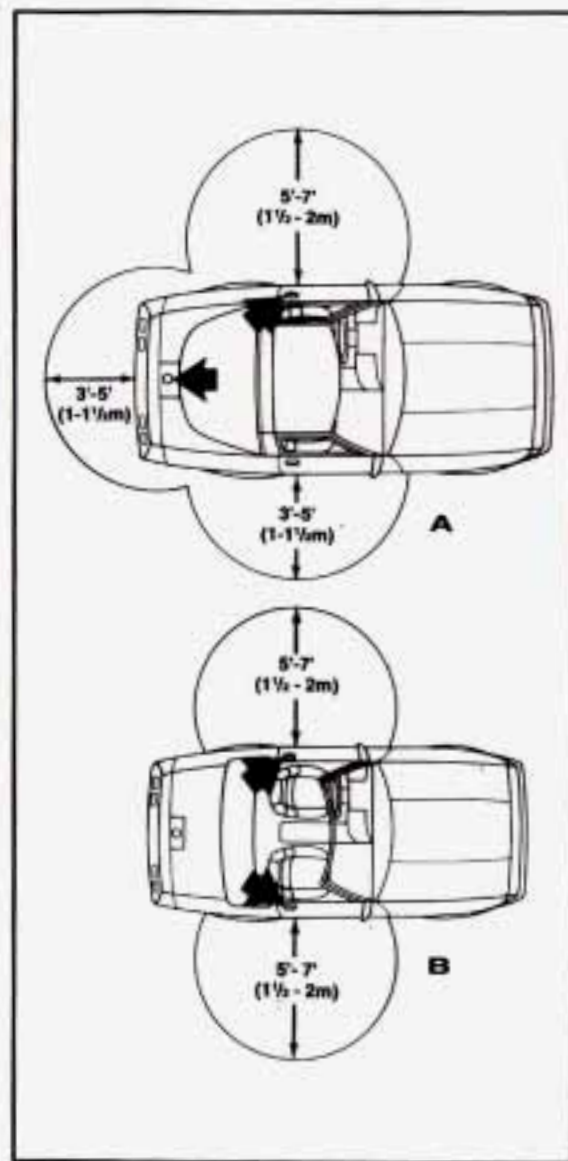

Transmitter Range

The transmitter range depends on your vehicle and where you are standing. The coupe (A) has an antenna in the driver's door and one in the rear area. The convertible (B) has one antenna in each door. The antennas do not require any maintenance.

Range also depends on how you hold the transmitter. For best performance, when you come near your vehicle, hold the transmitter straight up and down, so the keys hang down.

If the range seems to be decreasing, check the battery in the transmitter. Range will decrease if the battery is low. It will also decrease if more than one transmitter is in the area. Don't put the transmitter in a metal container because the transmitter won't work.

Matching Transmitter(s) to Your Vehicle

Each key chain transmitter is coded to prevent another transmitter from unlocking your vehicle. If a transmitter is lost or stolen, a replacement can be purchased through your dealer. Remember to bring any remaining transmitters with you when you go to

your dealer. When the dealer matches the replacement transmitter to your vehicle, the remaining transmitters must also be matched. Once the new transmitter is coded, the lost transmitter will not unlock your vehicle.

You can match a transmitter to as many different vehicles as you own, provided they are equipped with exactly the same model system. (General Motors offers several different models of these systems on their vehicles.) Each vehicle can have only three transmitters matched to it.

To match transmitters to your vehicle:

1. Move all transmitters out of range.
2. Turn the ignition on.
3. Push "TRIP ODO" on the Driver Information Center twice.
4. Within five seconds press and hold "FUEL INFO" until the "PASSIVE KEYLESS ENTRY" light comes on.
5. Turn the ignition off, but leave the key in the ignition. The "PASSIVE KEYLESS ENTRY" light should begin to flash to show the system is in programming mode.

6. Bring one transmitter into range. The light will stop flashing and stay on to show that the code is stored.
7. Move the transmitter out of range. The light should start flashing again.
8. Repeat steps 6 and 7 with each additional transmitter.

The programming mode will shut off if:

- You don't program any transmitters for two minutes.
- You take the key out of the ignition or turn the ignition on.
- You have programmed three transmitters.

Battery Replacement

Under normal use, the battery in your key chain transmitter should last about 18 months.

You can tell the battery is weak if the transmitter won't work at the normal range in any location. If you have to get close to your vehicle before the transmitter works, it's probably time to change the battery.

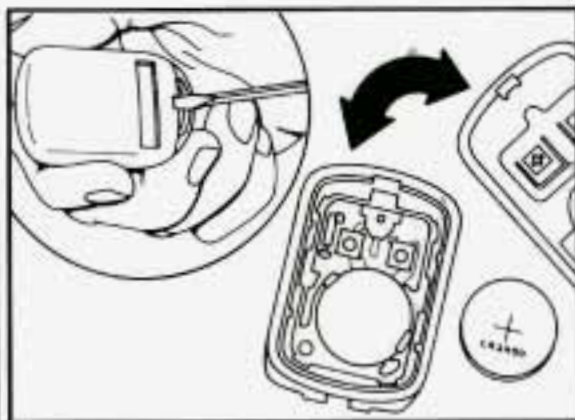

To replace your battery:

1. Insert a screwdriver in the slot on the back of the transmitter and gently pry apart the front and back.
2. Gently pry the battery out of the transmitter using the screwdriver.
3. Put the new battery in the transmitter, positive (+) side up. Use a Duracell® battery, type DL2450, or equivalent.
4. Put the two halves back together. Make sure the halves are together tightly so water won't get in.
5. Test the transmitter.

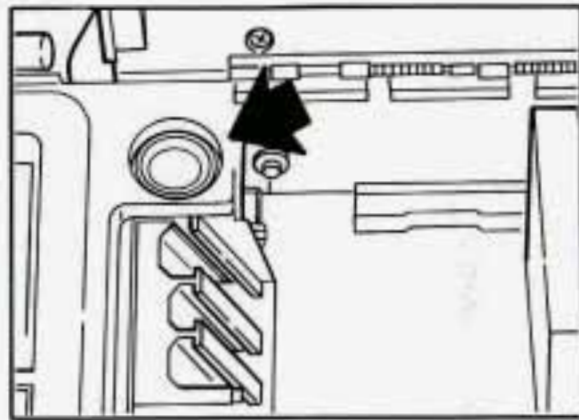

Remote Hatch Release

Press the switch in your center console to unlock the hatch from inside your vehicle. If you have an automatic transmission, your shift lever must be in "P" (Park) or "N" (Neutral) to use the switch. If you have a manual transmission, you must set the parking brake before you can use the switch.

Features and Controls



If you have a coupe, this switch is on the rear of the driver's door. It works with the door open and the transmission in any gear. Push it down to release the hatch.

The PKE transmitter will also release the hatch. See "Passive Keyless Entry System" in the Index.

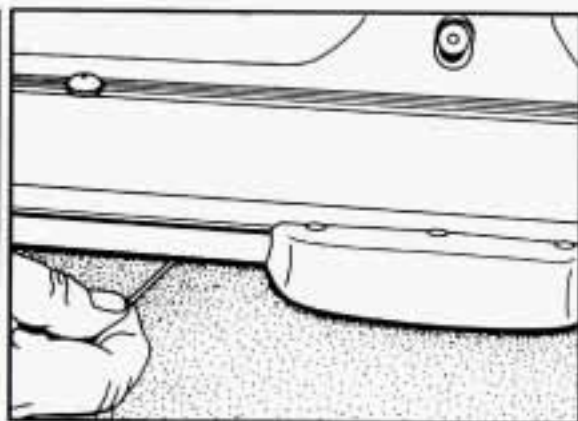

If you don't have battery power, use the manual release cable to open the hatch. The cable is near the security shade handle, between the carpet and the shade.



CAUTION:

It can be dangerous to drive with the hatch open because carbon monoxide (CO) gas can come into your vehicle. You can't see or smell CO. It can cause unconsciousness and even death.

If you must drive with the hatch open or if electrical wiring or other cable connections must pass through the seal between the body and the hatch:

- Make sure all windows are shut.
- Turn the fan on your heating or cooling system to its highest speed with the setting on bi-level or vent. That will force outside air into your vehicle. See "Comfort Controls" in the Index.
- If you have air vents on or under the instrument panel, open them all the way.

NOTICE:

If you put things in the hatchback area, be sure they won't break the glass when you close it.

Never slam the hatch down. You could break the glass or damage the defogger grid.

When you close the hatch, make sure you pull down from the center, not the sides. If you pull the hatch down from the side too often, the weather-strip can be damaged.

■ *Theft*

Vehicle theft is big business, especially in some cities. Although your Corvette has a number of theft-deterrent features, we know that nothing we put on it can make it impossible to steal. However, there are ways you can help.

Key in the Ignition

If you walk away from your vehicle with the keys inside, it's an easy target for joy riders or professional thieves — so don't do it.

When you park your Corvette and open the driver's door, you'll hear a tone reminding you to remove your key from the ignition and take it with you. Always do this. Your steering wheel will be locked, and so will your ignition. If you have an automatic transmission, taking your key out also locks your transmission. And remember to lock the doors.

Parking at Night

Park in a lighted spot, close all windows and lock your vehicle. Remember to keep your valuables out of sight. Put them in a storage area, or take them with you.

Parking Lots

If you park in a lot where someone will be watching your vehicle, it's best to lock it up and take your keys. But what if you have to leave your ignition key? What if you have to leave something valuable in your vehicle?

- Put your valuables in a storage area, like the rear area or center console.
- Lock the storage area.
- Lock all the doors except the driver's.
- Then take the door key with you.

Features and Controls

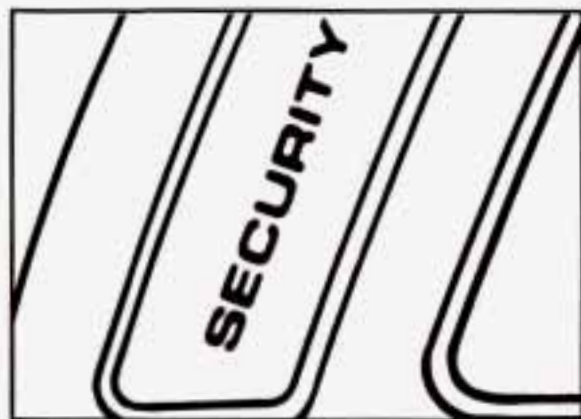

■ *Universal Theft Deterrent*

Your Corvette has a theft deterrent alarm system. With this system, the "SECURITY" light will flash as you open the door (if your ignition is off). This light reminds you to arm the theft deterrent system. Here's how to do it:

1. Open the door.
2. Lock the door with the power door lock switch or the Passive Keyless Entry system. The "SECURITY" light will come on.
3. Close all the doors. The "SECURITY" light should go off.

Now, if a door or the hatch is opened without the key or Passive Keyless Entry system, the alarm will go off. Your horn will sound for three minutes, then it will go off to save battery power.

The theft deterrent system won't arm if you lock the doors with a key or manual door lock, or if you lock the vehicle after the doors are closed.

If your passenger stays in the vehicle when you leave with the keys, have the passenger lock the vehicle after the doors are closed. This way the alarm won't arm, and your passenger won't set it off.

Always use your key or the Passive Keyless Entry system to unlock a door. Unlocking a door any other way will set off the alarm. If you do set off the alarm accidentally, there are three ways to stop it:

- Unlock any door with your key.
- Put the ignition key in the ignition.
- Use the Passive Keyless Entry system.

How to Test the Alarm

1. Make sure the rear hatch is latched.
2. Lower a window.
3. Arm the system.

4. Close the doors and wait five seconds.
5. Reach through the open window and unlock the door from inside. The alarm should sound.
6. Turn off the alarm.

If the alarm doesn't go off, check to see if the horn works. If not, check the horn fuse. See "Fuses and Circuit Breakers" in the Index. If the horn does work, but the alarm doesn't go off, see your dealer.

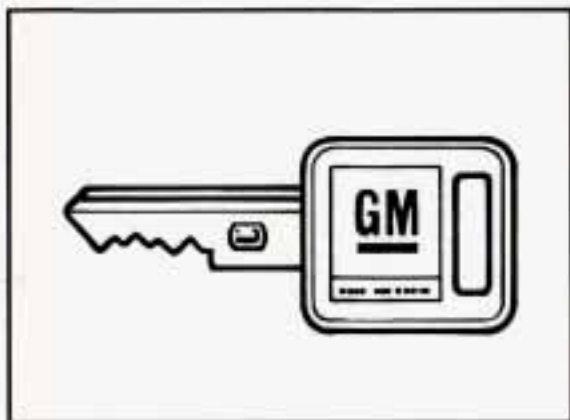

■ **PASS-Key**[®]

Your vehicle is equipped with the PASS-Key[®] (Personalized Automotive Security System) theft deterrent system. PASS-Key[®] is a passive theft deterrent system. This means you don't have to do anything different to arm or disarm the system. It works when you insert or remove the key from the ignition. PASS-Key[®] uses a resistor pellet in the ignition key that matches a decoder in your vehicle.

When the PASS-Key[®] system senses that someone is using the wrong key, it shuts down the vehicle's starter and fuel systems. For about three minutes, the starter won't work and fuel won't go to the engine. If someone tries to start your vehicle again or uses another key during this time, the shutdown period will start over again. This discourages someone from randomly trying different keys with different resistor pellets in an attempt to make a match.

The ignition key must be clean and dry before it's inserted in the ignition or the engine may not start. If the "SECURITY" light comes on, the key may be dirty or wet.

If this happens and the starter won't work, turn the ignition off. Clean and dry the key, wait three minutes and try again. If the starter still won't work, wait three minutes and try the other ignition key. At this time, you may also want to check the fuses (see "Fuses and Circuit Breakers" in the Index). If the starter won't work with

the other key, your vehicle needs service. If your vehicle does start, the first ignition key may be faulty. See your Chevrolet dealer or a locksmith who can service the PASS-Key[®].

However, if you accidentally use a key that has a damaged or missing resistor pellet, you will see no "SECURITY" light. You don't have to wait three minutes before trying the proper key.

If the resistor pellet is damaged or missing, the starter won't work. Use the other ignition key, and see your Chevrolet dealer or a locksmith who can service the PASS-Key[®] to have a new key made.

If the "SECURITY" light comes on while driving, have your vehicle serviced as soon as possible.

If you lose or damage a PASS-Key[®] ignition key, see your Chevrolet dealer or a locksmith who can service PASS-Key[®]. In an emergency, call the Chevrolet Roadside Assistance Program at 1-800-CHEV USA (1-800-243-8872).

Features and Controls

■ *New Vehicle “Break-In”*

NOTICE:

Your modern Corvette doesn't need an elaborate “break-in.” But it will perform better in the long run if you follow these guidelines:

- Keep your speed at 55 mph (88 km/h) or less for the first 500 miles (804 km).
- Don't drive at any one speed — fast or slow — for the first 500 miles (804 km). Don't make full-throttle starts.
- Avoid making hard stops for the first 200 miles (322 km) or so. During this time your new brake linings aren't yet broken in. Hard stops with new linings can mean premature wear and earlier replacement. Follow this “breaking-in” guideline every time you get new brake linings.

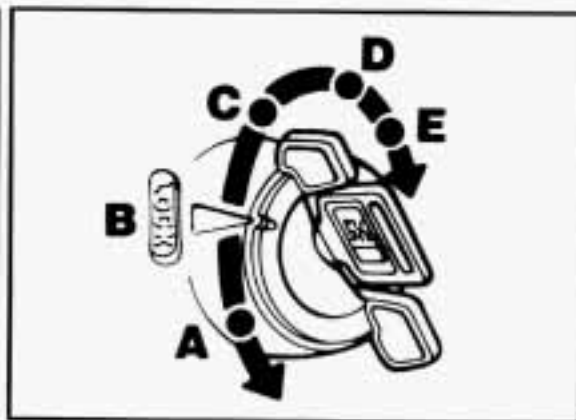

■ *Ignition Switch*

With the ignition key in the ignition switch, you can turn the switch to five positions:

Acc (A): Position in which you can operate your electrical power accessories. Press in the ignition switch as you turn the top of it toward you.

Lock (B): The only position in which you can remove the key. This locks your steering wheel, ignition and automatic transmission.

If you have an automatic transmission, the ignition switch can't be turned to “Lock” unless the shift lever is in the “P” (Park) position.

Off (C): Unlocks the steering wheel, ignition and automatic transmission, but does not send electrical power to any accessories. Use this position if your vehicle must be pushed or towed.

Run (D): Position to which the switch returns after you start your engine and release the switch. The switch stays in the “Run” position when the engine is running. But even when the engine is not running, you can use “Run” to operate your electrical power accessories and to display some instrument panel warning and indicator lights.

Start (E): Starts the engine. When the engine starts, release the key. The ignition switch will return to “Run” for normal driving.

When the engine is not running, “Acc” and “Run” allow you to operate your electrical accessories, such as the radio.

A warning tone will sound if you open the driver's door when the ignition is in “Off,” “Lock” or “Acc” and the key is in the ignition.

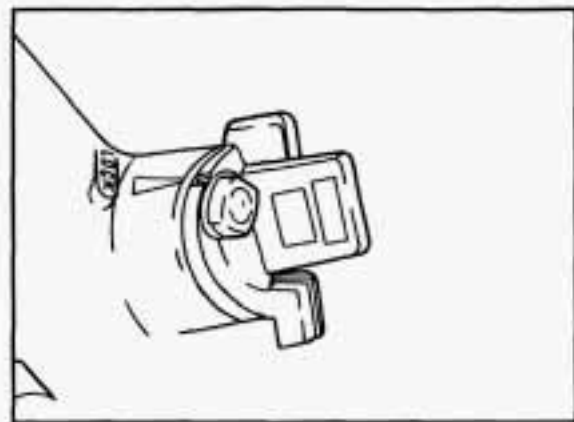

Key Release Button: If you have a manual transmission, your ignition lock has a key release button. You must press the button before you can take your key out of the ignition lock.



CAUTION:

On manual transmission vehicles, turning the key to "Lock" will lock the steering column and result in a loss of ability to steer the vehicle. This could cause a collision. If you need to turn the engine off while the vehicle is moving, turn the key only to "Off." Don't press the key release button while the vehicle is moving.

NOTICE:

If your key seems stuck in "Lock" and you can't turn it, be sure it is all the way in. If it is, then turn the steering wheel left and right while you turn the key hard. But turn the key only with your hand. Using a tool to force it could break the key or the ignition switch. If none of this works, then your vehicle needs service.

Delayed Accessory Bus (DAB)

With DAB your power windows and the audio system will continue to work up to 15 minutes after the ignition key is turned to "Off" and neither door is opened. If a door is opened, the audio system and power windows will shut off.

■ Starting Your Engine

Automatic Transmission: Move your shift lever to "P" (Park) or "N" (Neutral). Your engine won't start in any other position — that's a safety feature. To restart when you're already moving, use "N" (Neutral) only.

NOTICE:

Don't try to shift to "P" (Park) if your Corvette is moving. If you do, you could damage the transmission. Shift to "P" (Park) only when your vehicle is stopped.

Manual Transmission: The gear selector should be in neutral. Hold the clutch pedal to the floor and start the engine. Your vehicle won't start if the clutch pedal is not all the way down — that's a safety feature.

To start your 5.7 Liter LT1 engine:

1. Without pushing the accelerator pedal, turn the ignition key to "Start." When the engine starts, let go of the key. The idle speed will go down as your engine gets warm.

NOTICE:

Holding your key in "Start" for longer than 15 seconds at a time will cause your battery to be drained much sooner. And the excessive heat can damage your starter motor.

Features and Controls

2. If it doesn't start within 10 seconds, push the accelerator pedal all the way to the floor, while you hold the ignition key in "Start." When the engine starts, let go of the key and let up on the accelerator pedal. Wait about 15 seconds between each try to help avoid draining your battery.

When starting your engine in very cold weather (below 0°F or -18°C), do this:

1. With your foot off the accelerator pedal, turn the ignition key to "Start" and hold it there. When the engine starts, let go of the key. Use the accelerator pedal to maintain engine speed, if you have to, until your engine has run for a while.
2. If your engine still won't start (or starts but then stops), it could be flooded with too much gasoline. Try pushing your accelerator pedal all the way to the floor and holding it there as you hold the key in "Start" for about three seconds. If the vehicle starts briefly but then stops again, do the same thing, but this time keep the pedal down for five or six seconds. This clears the extra gasoline from the engine.

NOTICE:

Your engine is designed to work with the electronics in your vehicle. If you add electrical parts or accessories, you could change the way the fuel injection system operates. Before adding electrical equipment, check with your dealer. If you don't, your engine might not perform properly.

If you ever have to have your vehicle towed, see the part of this manual that tells how to do it without damaging your vehicle. See "Towing Your Vehicle" in the Index.

To start your 5.7 Liter LT5 engine:

1. Without pushing the accelerator pedal, turn your ignition key to "Start." When the engine starts, let go of the key. The idle speed will go down as your engine gets warm.

NOTICE:

Holding your key in "Start" for longer than 15 seconds at a time will cause your battery to be drained much sooner. And the excessive heat can damage your starter motor.

2. If it doesn't start within 3 seconds, push the accelerator pedal about one-third of the way down, while you hold the ignition key in "Start." When the engine starts, let go of the key and let up on the accelerator pedal. Wait about 15 seconds between each try to help avoid draining your battery.

When starting your engine in very cold weather (below 0°F or -18°C), do this:

1. With your foot off the accelerator pedal, turn the ignition key to "Start" and hold it there. After two seconds, push the accelerator pedal down just a little. When the engine starts, let go of the key. Use the accelerator pedal to maintain engine speed, if you have to, until your engine has run for a while.
2. If your engine still won't start (or starts but then stops), it could be flooded with too much gasoline. Try pushing your accelerator pedal all the way to the floor and holding it there as you hold the key in "Start" for about three seconds. If the vehicle starts briefly but then stops again, do the same thing, but this time keep the pedal down for five or six seconds. This clears the extra gasoline from the engine.

NOTICE:

Your engine is designed to work with the electronics in your vehicle. If you add electrical parts or accessories, you could change the way the fuel injection system operates. Before adding electrical equipment, check with your dealer. If you don't, your engine might not perform properly.

If you ever have to have your vehicle towed, see the part of this manual that tells how to do it without damaging your vehicle. See "Towing Your Vehicle" in the Index.

Engine Power Switch (ZR-1)

The LT5 engine in your ZR-1 has two sets of intake runners and fuel injectors. The primary set can be run alone for normal engine power, or both sets can be used for full engine power.

Full power gives you extra power for highway touring and off-road sports use and reserve power for passing. With normal power, you'll notice less engine and exhaust noise.



To change the power setting, put your engine power key into the switch. Turn the key to the setting you want and let go. The key will return to the center position.

Your ZR-1 is able to run at full power under the following conditions:

- The engine coolant and oil temperatures are greater than 68°F (20°C) but less than 302°F (150°C).
- System voltage is greater than ten volts.
- The "SERVICE ENGINE SOON" light is not on.

You can switch the setting at engine speeds up to 4,000 rpm. When you select the "FULL" setting, a light near the switch will come on. It should go out when you change back to the "NORMAL" setting. When you turn the ignition off, the setting will go back to normal power.

Off-Road Track Use

See your Warranty Book before using your Corvette for off-road track use.

NOTICE:

If you use your Corvette for off-road track use, your engine may use more oil than it would with normal use. Low oil levels can damage the engine. Be sure to check the oil level often during off-road track use. You may need to add additional oil. See "Engine Oil" in the Index.

Features and Controls

Driving through Deep Standing Water

NOTICE:

If you drive too quickly through deep puddles or standing water, water can come in through your engine's air intake and badly damage your engine. If you can't avoid deep puddles or standing water, drive through them very slowly.

Rough Idling

If you notice rough idling or surging, especially after long periods of idling or during slow city driving, the oxygen sensors may be clogged. If this happens, follow these steps to clear the oxygen sensors:

1. Set the parking brake.
2. Shift an automatic transmission to "P" (Park) or a manual transmission to "N" (Neutral).
3. Press the accelerator until your tachometer reads 2,000 rpm and hold for two minutes.

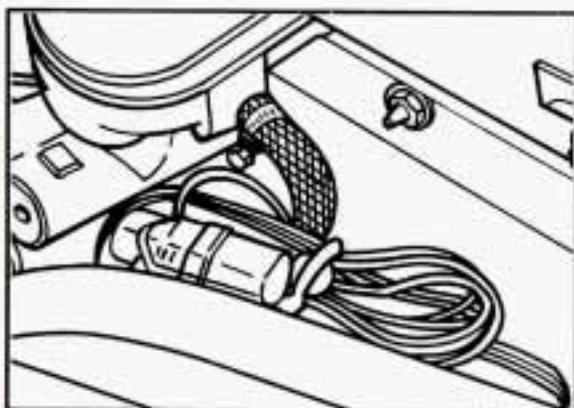

Engine Coolant Heater (Engine Block Heater) (LT1 ENGINE, CANADA)

In very cold weather, 0°F (-18°C) or colder, the engine coolant heater can help. You'll get easier starting and better fuel economy during engine warm-up. Usually, the coolant heater should be plugged in a minimum of four hours prior to starting your vehicle.

To use the coolant heater:

1. Turn off the engine.
2. Open the hood and unwrap the electrical cord.
3. Plug it into a normal, grounded 110-volt outlet.



CAUTION:

Plugging the cord into an ungrounded outlet could cause an electrical shock. Also, the wrong kind of extension cord could overheat and cause a fire. You could be seriously injured. Plug the cord into a properly grounded three-prong 110-volt outlet. If the cord won't reach, use a heavy-duty three-prong extension cord rated for at least 15 amps.

NOTICE:

After you've used the coolant heater, be sure to store the cord as it was before to keep it away from moving engine parts. If you don't, it could be damaged.

How long should you keep the coolant heater plugged in? The answer depends on the weather, the kind of oil you have, and some other things. Instead of trying to list everything here, we ask that you contact your Chevrolet dealer in the area where you'll be parking your vehicle. The dealer can give you the best advice for that particular area.



■ *Automatic Transmission*

There are several different positions for your shift lever.

● **P (Park)**

This locks your rear wheels. It's the best position to use when you start your engine because your vehicle can't move easily.



CAUTION:

It is dangerous to get out of your vehicle if the shift lever is not fully in "P" (Park) with the parking brake firmly set. Your vehicle can roll.

Don't leave your vehicle when the engine is running unless you have to. If you have left the engine running, the vehicle can move suddenly. You or others could be injured. To be sure your vehicle won't move, even when you're on fairly level ground, always set your parking brake and move the shift lever to "P" (Park).

See "Shifting into 'P' (Park)" in the Index.

Ensure the shift lever is fully in "P" (Park) range before starting the engine. Your Corvette has a brake-transmission shift interlock. You have to fully apply your regular brakes before you can shift from "P" (Park) when the ignition key is in the "Run" position. If you cannot shift out of "P" (Park), ease pressure on the shift lever — push the shift lever all the

Features and Controls

way into "P" (Park) and release the shift lever button as you maintain brake application. Then press the shift lever button and move the shift lever into the gear you wish. See "Shifting out of 'P' (Park)" in the Index.

● R (Reverse)

Use this gear to back up.

NOTICE:

Shifting to "R" (Reverse) while your vehicle is moving forward could damage your transmission. Shift to "R" only after your vehicle is stopped.

To rock your vehicle back and forth to get out of snow, ice or sand without damaging your transmission, see "Stuck: In Sand, Mud, Ice or Snow" in the Index.

● N (Neutral)

In this position, your engine doesn't connect with the wheels. To restart when you're already moving, use "N" (Neutral) only. Also, use "N" when your vehicle is being towed.



CAUTION:

Shifting out of "P" (Park) or "N" (Neutral) while your engine is "racing" (running at high speed) is dangerous. Unless your foot is firmly on the brake pedal, your vehicle could move very rapidly. You could lose control and hit people or objects. Don't shift out of "P" (Park) or "N" (Neutral) while your engine is racing.

NOTICE:

Damage to your transmission caused by shifting out of "P" (Park) or "N" (Neutral) with the engine racing isn't covered by your warranty.

● D Automatic Overdrive

This position is for normal driving. If you need more power for passing, and you're:

- Going less than about 35 mph (56 km/h), push your accelerator pedal about halfway down.
- Going about 35 mph (56 km/h) or more, push the accelerator all the way down.

You'll shift down to the next gear and have more power.

● D (Third Gear)

This is like , but you never go into Overdrive.

Here are some times you might choose "D" instead of :

- When driving on hilly, winding roads
- When going down a steep hill

● 2 (Second Gear)

This position gives you more power but lower fuel economy. You can use "2" on hills. It can help control your speed as you go down steep mountain roads, but then you would also want to use your brakes off and on.

NOTICE:

Don't drive in "2" (Second Gear) for more than 5 miles (8 km), or at speeds over 55 mph (88 km/h), or you can damage your transmission. Use **D** or "D" as much as possible. Don't shift into "2" unless you are going slower than 65 mph (105 km/h), or you can damage your engine.

● 1 (First Gear)

This position gives you even more power (but lower fuel economy) than "2." You can use it on very steep hills, or in deep snow or mud. If the selector lever is put in "1," the transmission won't shift into first gear until the vehicle is going slowly enough.

NOTICE:

If your rear wheels can't rotate, don't try to drive. This might happen if you were stuck in very deep sand or mud or were up against a solid object. You could damage your transmission.

Also, if you stop when going uphill, don't hold your vehicle there with only the accelerator pedal. This could overheat and damage the transmission. Use your brakes or shift into "P" (Park) to hold your vehicle in position on a hill.

Maximum engine speed is limited to protect driveline components from improper operation.

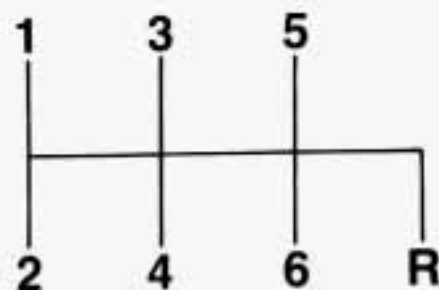

■ Manual Transmission

Six-Speed

This is your shift pattern. Here's how to operate your transmission:

- **1 (First Gear)** — Press the clutch pedal and shift into "1." Then, slowly let up on the clutch pedal as you press the accelerator pedal.

You can shift into "1" when you're going less than 40 mph (64 km/h). If you've come to a complete stop and it's hard to shift into "1," put the shift lever in "Neutral" and let up on the clutch. Press the clutch pedal back down. Then shift into "1."

Features and Controls

- **2 (Second Gear)** — Press the clutch pedal as you let up on the accelerator pedal and shift into “2.” Then, slowly let up on the clutch pedal as you press the accelerator pedal.
- **3, 4, 5 and 6 (Third, Fourth, Fifth and Sixth Gears)** — Shift into “3,” “4,” “5” and “6” the same way you do for “2.” Slowly let up on the clutch pedal as you press the accelerator pedal.
- **To Stop** — Let up on the accelerator pedal and press the brake pedal. Just before the vehicle stops, press the clutch pedal and the brake pedal, and shift to “Neutral.”
- **Neutral** — Use this position when you start or idle your engine.
- **R (Reverse)** — To back up, press down the clutch pedal, and shift into “R.” If the shift lever has a ring on it, you have to lift the ring before you can shift into “R” (Reverse). If you don’t have the ring, just apply pressure to get the lever past “5” and “6” into “R” (Reverse). Let up on the clutch pedal slowly while pressing the accelerator pedal.

Shift Speeds (MANUAL TRANSMISSION)

This chart shows when to shift to the next higher gear for best fuel economy.

MANUAL TRANSMISSION RECOMMENDED SHIFT SPEEDS, IN MPH (km/h)

| Engine | Acceleration Shift Speed | | | | |
|-------------|--------------------------|------------|------------|------------|------------|
| | 1 to 2 | 2 to 3 | 3 to 4 | 4 to 5 | 5 to 6 |
| All Engines | 15 (24) | 25 (40) | 40 (64) | 45 (72) | 50 (80) |

If your speed drops below 20 mph (30 km/h), or if the engine is not running smoothly, you should downshift to the next lower gear. You may have to downshift two or more gears to keep the engine running smoothly or for good performance.

NOTICE:

When you are shifting gears, don't move the gear shift lever around needlessly. This can damage parts of the transmission and may require costly repair. Just shift directly into the next appropriate gear.



One to Four Light **(MANUAL TRANSMISSION)**

When this light comes on, you can only shift from “1” to “4” instead of “1” to “2.” This helps you get the best possible fuel economy.

This light will come on when:

- The engine coolant temperature is higher than 170°F (77°C),
- You are going 15-19 mph (24-29 km/h), and
- You are at 21% throttle or less.

When this light is on, the shift lever will only let you shift from “1” to “4.” After you are in “4,” you can press the clutch again and shift into another gear. Use the

following shift speeds when the “ONE TO FOUR” light is on:

| | |
|----------------------|------------------|
| 1st to 4th | 15 mph (24 km/h) |
| 4th to 5th | 25 mph (40 km/h) |
| 5th to 6th | 40 mph (64 km/h) |

Each time you come to a stop, your vehicle’s Engine Control Module (ECM) determines when to activate the One-to-Four upshift system.

Use “2” only when you accelerate very quickly from a stop. You can then follow the full gear shift pattern.

Downshifting **(MANUAL TRANSMISSION)**

When you downshift, don’t skip more than one gear. For example, you can shift from “6” to “5” or from “6” to “4.” But don’t shift from “6” to “3.”

Be careful not to drive faster than the speeds shown for each gear:

| | |
|---------------|--------------------|
| 1st | 40 mph (64 km/h) |
| 2nd | 60 mph (97 km/h) |
| 3rd | 80 mph (129 km/h) |
| 4th | 105 mph (169 km/h) |



CAUTION:

If you skip more than one gear when you downshift, you could lose control of your vehicle. And you could injure yourself or others. Don’t shift from “6” to “3,” “5” to “2” or “4” to “1.”

NOTICE:

If you skip more than one gear when you downshift, or if you race the engine when you downshift, you can damage the clutch or transmission.

The six-speed transmission has springs that center the shift lever near “3” and “4.” These springs help you know which gear you are in when you are shifting. Be careful when shifting from “1” to “2” or downshifting from “6” to “5.” The springs will try to pull the gear shift lever toward “3” and “4.” Make sure you move the lever into “2” or “5.” If you let the lever move in the direction of the pulling, you may end up shifting from “1” to “4” or from “6” to “3.”

Features and Controls

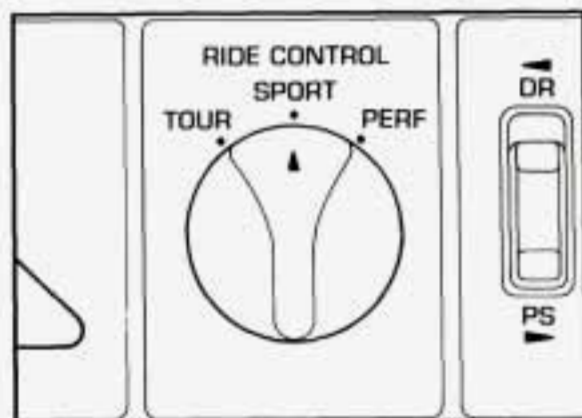

■ *Selective Ride Control* (OPTION)

This knob is on the center console. Turn it to select the ride control of your choice:

TOUR: Use for city and highway driving. Provides a smooth, soft ride.

SPORT: Use where road conditions or personal preference demand more control. Provides more "feel," or response to the road conditions.

PERF: Use for performance driving. Provides tight, firm ride and precise response to road conditions.

"TOUR" and "SPORT" will provide a similar ride at low speeds around town, and both settings will increase control and firmness at higher speeds. "SPORT," however, will adjust more at higher speeds than "TOUR" will.

"PERF" will provide much more control and a firmer ride at all speeds.

You can select a setting at any time. Based on your speed, the system automatically adjusts to provide the best ride and handling. Select a new setting whenever driving conditions change.

The "SERVICE RIDE CONTROL" light monitors the system. Refer to "Service Ride Control Light" in the Index.

■ *Limited-Slip Rear Axle*

Your rear axle can give you additional traction on snow, mud, ice, sand or gravel. It works like a standard axle most of the time, but when one of the rear wheels has no traction and the other does, the limited-slip feature will allow the wheel with traction to move the vehicle.

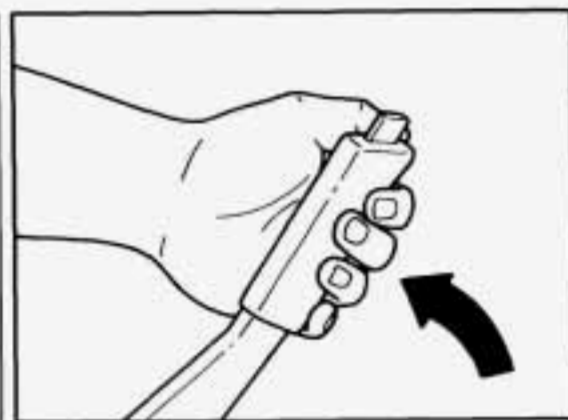

■ *Parking*

Parking Brake

To set the parking brake: Hold the brake pedal down. Pull the parking brake lever up, then move it back down. This sets your parking brake, even though the lever is down. If the ignition is on, the parking brake indicator light will come on.



To release the parking brake: Hold the brake pedal down. Pull the parking brake lever up until you can push in the release button. Hold the release button in as you move the lever all the way down.

NOTICE:

Driving with the parking brake on can cause your rear brakes to overheat. You may have to replace them, and you could also damage other parts of your vehicle.

Shifting into "P" (Park) (AUTOMATIC TRANSMISSION)



CAUTION:

It can be dangerous to get out of your vehicle if the shift lever is not fully in "P" (Park) with the parking brake firmly set. Your vehicle can roll.

If you have left the engine running, the vehicle can move suddenly. You or others could be injured. To be sure your vehicle won't move, even when you're on fairly level ground, use the steps that follow.



1. Hold the brake pedal down with your right foot and set the parking brake.
2. Move the shift lever into "P" (Park) position like this:
 - Hold in the button on the lever, and push the lever all the way toward the front of your vehicle.
3. Move the ignition key to "LOCK."
4. Remove the key and take it with you. If you can walk away from your vehicle with the ignition key in your hand, your vehicle is in "P" (Park).

Features and Controls

Leaving Your Vehicle with the Engine Running

(AUTOMATIC TRANSMISSION)



CAUTION:

It can be dangerous to leave your vehicle with the engine running. Your vehicle could move suddenly if the shift lever is not fully in "P" (Park) with the parking brake firmly set. And, if you leave the vehicle with the engine running, it could overheat and even catch fire. You or others could be injured. Don't leave your vehicle with the engine running unless you have to.

Torque Lock

(AUTOMATIC TRANSMISSION)

If you are parking on a hill and you don't shift your transmission into "P" (Park) properly, the weight of the vehicle may put too much force on the parking pawl in the transmission. You may find it difficult to pull the shift lever out of "P" (Park). This is called "torque lock." To prevent

torque lock, set the parking brake and then shift into "P" (Park) properly before you leave the driver's seat. To find out how, see "Shifting into 'P' (Park)" in the Index.

When you are ready to drive, move the shift lever out of "P" (Park) BEFORE you release the parking brake.

If "torque lock" does occur, you may need to have another vehicle push yours a little uphill to take some of the pressure from the transmission, so you can pull the shift lever out of "P" (Park).

Shifting out of P (Park)

(AUTOMATIC TRANSMISSION)

Your Corvette has a brake-transmission shift interlock. You have to fully apply your regular brake before you can shift from "P" (Park) when the ignition is in the "Run" position. See "Automatic Transmission" in the Index.

If you cannot shift out of "P" (Park), ease pressure on the shift lever — push the shift lever all the way into "P" (Park) and release the shift lever button as you maintain brake application. Then press the shift lever button and move the shift lever into the gear you wish.

If you ever hold the brake pedal down but still can't shift out of "P" (Park), try this:

1. Turn the key to "Off."
2. Apply and hold the brake until the end of Step 4.
3. Shift to "N" (Neutral).
4. Start the vehicle and then shift to the drive gear you want.
5. Have the vehicle fixed as soon as you can.

Parking Your Vehicle

(MANUAL TRANSMISSION)

Before you get out of your vehicle, put your manual transmission in "R" (Reverse) and firmly apply the parking brake.



Parking over Things That Burn

CAUTION:

Things that can burn could touch hot exhaust parts under your vehicle and ignite. Don't park over papers, leaves, dry grass or other things that can burn.

■ ***Engine Exhaust***

CAUTION:

Engine exhaust can kill. It contains the gas carbon monoxide (CO), which you can't see or smell. It can cause unconsciousness and death.

You might have exhaust coming in if:

- Your exhaust system sounds strange or different.
- Your vehicle gets rusty underneath.
- Your vehicle was damaged in a collision.
- Your vehicle was damaged when driving over high points on the road or over road debris.
- Repairs weren't done correctly.
- Your vehicle or exhaust system had been modified improperly.

If you ever suspect exhaust is coming into your vehicle:

- Drive it only with all the windows down to blow out any CO; and
- Have your vehicle fixed immediately.

Running Your Engine While You're Parked (AUTOMATIC TRANSMISSION)

It's better not to park with the engine running. But if you ever have to, here are some things to know.

CAUTION:

Idling the engine with the air system control off could allow dangerous exhaust into your vehicle. (See the earlier caution under "Engine Exhaust.")

Also, idling in a closed-in place can let deadly carbon monoxide (CO) into your vehicle even if the fan switch is at the highest setting. One place this can happen is a garage. Exhaust — with CO — can come in easily. NEVER park in a garage with the engine running.

Another closed-in place can be a blizzard. (See "Blizzard" in the Index.)

Features and Controls

CAUTION:

It can be dangerous to get out of your vehicle if the shift lever is not fully in "P" (Park) with the parking brake firmly set. Your vehicle can roll. Don't leave your vehicle when the engine is running unless you have to. If you've left the engine running, the vehicle can move suddenly. You or others could be injured. To be sure your vehicle won't move, even when you're on fairly level ground, always set your parking brake and move the shift lever to "P" (Park).

Follow the proper steps to be sure your vehicle won't move. See "Shifting into 'P' (Park)" in the Index.

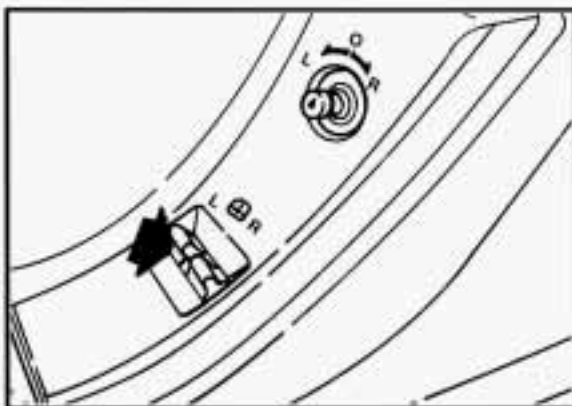

■ *Windows*

Power Windows

With power windows, switches on the door control each window when the ignition is on or when DAB is present. (See "Delayed Accessory Bus" in the Index.)

The switch for the driver's window has an Express Down feature. Press the switch for at least one third of a second, and the window will lower completely. To stop Express Down, press the switch again.

You can also open this window any amount by quickly pressing and releasing the switch.

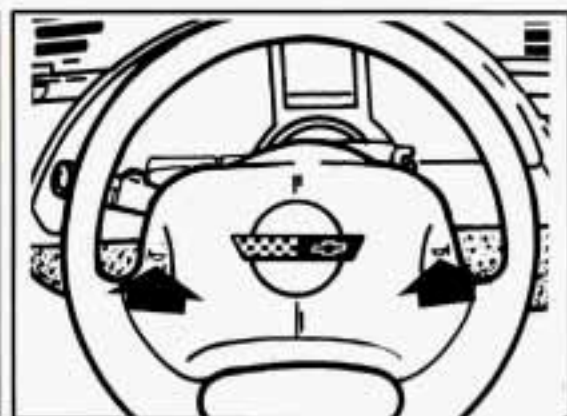

■ *Horn*

To sound the horn, press either horn symbol on your steering wheel.



■ *Tilt Wheel*

A tilt steering wheel allows you to adjust the steering wheel before you drive.

You can also raise it to the highest level to give your legs more room when you exit and enter the vehicle.

To tilt the wheel, hold the steering wheel and pull the lever. Move the steering wheel to a comfortable level, then release the lever to lock the wheel in place.

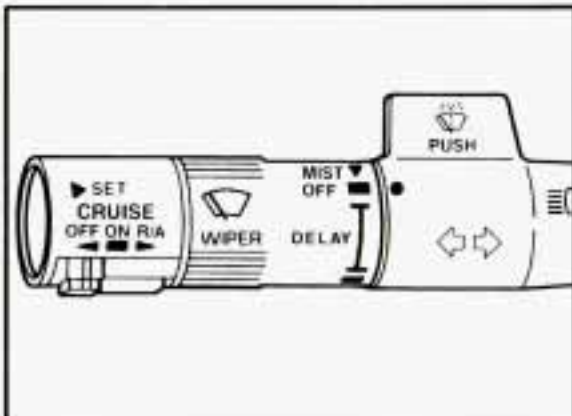

■ *The Turn Signal/Headlight Beam Lever*

The lever on the left side of the steering column includes your:

- Turn Signal and Lane Change Indicator
- Headlight High/Low Beam
- Windshield Wipers
- Windshield Washer
- Cruise Control

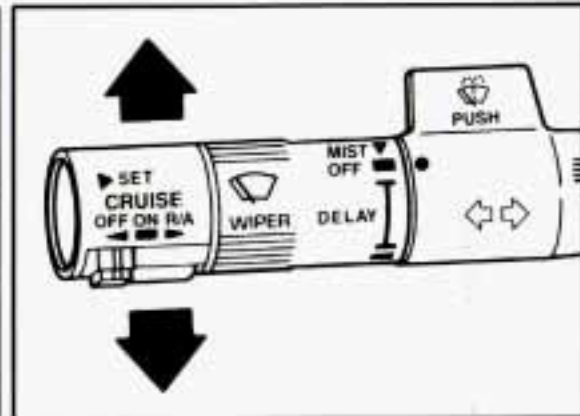

Turn Signal and Lane Change Indicator

The turn signal has two upward (for Right) and two downward (for Left) positions. These positions allow you to signal a turn or a lane change.

To signal a turn, move the lever all the way up or down. When the turn is finished, the lever will return automatically.

A chime will remind you if you leave your turn signal on for more than one mile (1.6 km) of driving.

Features and Controls



A green arrow on the instrument panel will flash in the direction of the turn or lane change.

To signal a lane change, just raise or lower the lever until the green arrow starts to flash. Hold it there until you complete your lane change. The lever will return by itself when you release it.

As you signal a turn or a lane change, if the arrows don't flash but just stay on, a signal bulb may be burned out and other drivers won't see your turn signal.

If a bulb is burned out, replace it to help avoid an accident. If the green arrows don't go on at all when you signal a turn, check the fuse (see "Fuses" in the Index) and for burned-out bulbs.



Headlight High/Low Beam

To change the headlights from low beam to high or high to low, pull the turn signal lever all the way toward you. Then release it. When the high beams are on, this blue light on the instrument panel also will be on.

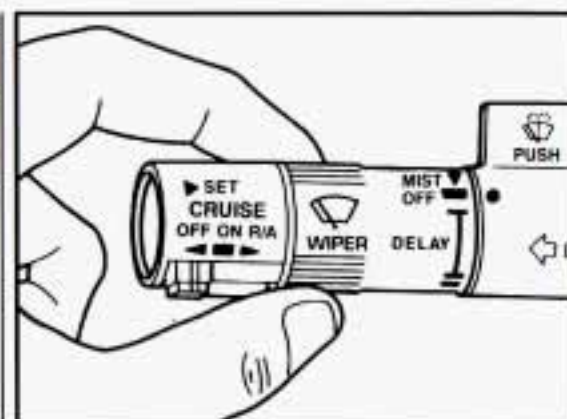

Windshield Wipers

You control the windshield wipers by turning the band with the wiper symbol on it.

For a single wiping cycle, turn the band to "MIST." Hold it there until the wipers start, then let go. The wipers will stop after one cycle. If you want more cycles, hold the band on "MIST" longer.

You can set the wiper speed for a long or short delay between wipes. This can be very useful in light rain or snow. Turn the band to choose the delay time. The closer to "LO," the shorter the delay.

For steady wiping at low speed, turn the band away from you to the "LO" position. For high speed wiping, turn the band further, to "HL." To stop the wipers, move the band to "OFF."

Damaged wiper blades may prevent you from seeing well enough to drive safely. To avoid damage, be sure to clear ice and snow from the wiper blades before using them. If they're frozen to the windshield, carefully loosen or thaw them. If your blades do become damaged, get new blades or blade inserts.

Heavy snow or ice can overload your wipers. A circuit breaker will stop them until the motor cools. Clear away snow or ice to prevent an overload.

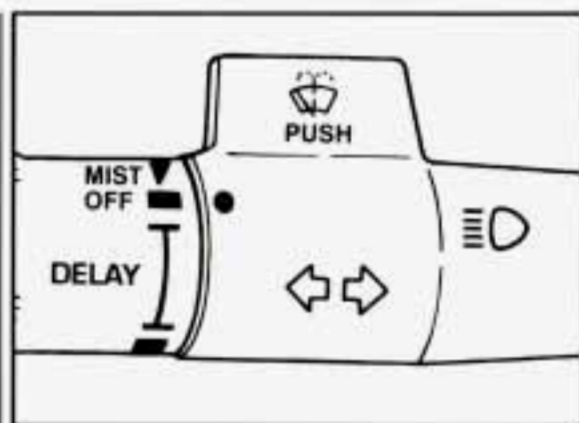

Windshield Washer

At the top of the turn signal lever there's a paddle with the word "PUSH" on it. To spray washer fluid on the windshield, just push the paddle for less than a second. The washer will continue to spray until you release the paddle. The wipers will clear the window and stop or return to the previous setting. If you hold the paddle for more than a second, the washer will spray until you release the paddle.



CAUTION:

In freezing weather, don't use your washer until the windshield is warmed. Otherwise the washer fluid can form ice on the windshield, blocking your vision.

Features and Controls

NOTICE:

- When using concentrated washer fluid, follow the manufacturer's instructions for adding water.
- Don't mix water with ready-to-use washer fluid. Water can cause the solution to freeze and damage your washer fluid tank and other parts of the washer system. Also, water doesn't clean as well as washer fluid.
- Fill your washer fluid tank only 3/4 full when it's very cold. This allows for expansion, which could damage the tank if it is completely full.
- Don't use radiator antifreeze in your windshield washer. It can damage your washer system and paint.

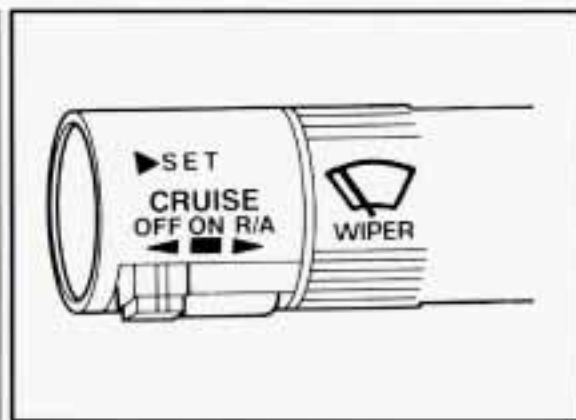

Cruise Control

With Cruise Control, you can maintain a speed of about 25 mph (40 km/h) or more without keeping your foot on the accelerator. This can really help on long trips. Cruise Control does not work at speeds below about 25 mph (40 km/h).

When you apply your brakes or push the clutch pedal, or if ASR is active, the Cruise Control shuts off.



CAUTION:

- Cruise Control can be dangerous where you can't drive safely at a steady speed. So, don't use your Cruise Control on winding roads or in heavy traffic.
- Cruise Control can be dangerous on slippery roads. On such roads, fast changes in tire traction can cause needless wheel spinning, and you could lose control. Don't use Cruise Control on slippery roads.

To Set Cruise Control

1. Turn the Cruise Control switch on.



CAUTION:

If you leave your Cruise Control switch on when you're not using Cruise, you might hit a button and go into Cruise when you don't want to. You could be startled and even lose control. Keep the Cruise Control switch "OFF" until you want to use it.

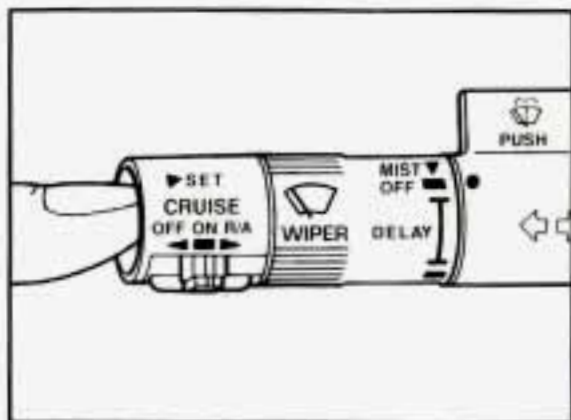

2. Get up to the speed you want.
3. Push in the set button at the end of the lever and release it.
4. Take your foot off the accelerator pedal.

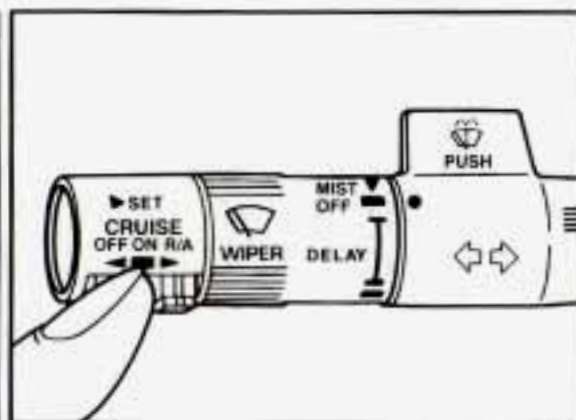

To Resume a Set Speed

Suppose you set your Cruise Control at a desired speed and then you apply the brake or clutch pedal. This, of course, shuts off the Cruise Control. But you don't need to reset it. Once you're going about 25 mph (40 km/h) or more, you can move the Cruise Control switch to "R/A" (Resume/Accelerate) for about half a second.

You'll go right back up to your chosen speed and stay there.

To Increase Speed While Using Cruise Control

There are two ways to go to a higher speed. Here's the first:

1. Use the accelerator pedal to get to the higher speed.

2. Push the button at the end of the lever, then release the button and the accelerator pedal. You'll now cruise at the higher speed.

Here's the second way to go to a higher speed:

1. Move the Cruise switch to "R/A." Hold it there until you get up to the speed you want, and then release the switch.
- To increase your speed in very small amounts, move the switch to "R/A" for less than half a second and then release it. Each time you do this, your vehicle will go about one mph (1.6 km/h) faster.

To Reduce Speed While Using Cruise Control

There are two ways to reduce your speed while using cruise control:

1. Push in the button at the end of the lever until you reach the lower speed you want, then release it.
2. To slow down in very small amounts, push the button for less than half a second. Each time you do this, you'll go one mph (1.6 km/h) slower.

Features and Controls

Passing Another Vehicle While Using Cruise Control

Use the accelerator pedal to increase your speed. When you take your foot off the pedal, your vehicle will slow down to the Cruise Control speed you set earlier.

Using Cruise Control on Hills

How well your Cruise Control will work on hills depends upon your speed, load, and the steepness of the hills. When going up steep hills, you may have to step on the accelerator pedal to maintain your speed. When going downhill, you may have to brake or shift to a lower gear to keep your speed down. Of course, applying the brake takes you out of Cruise Control. Many drivers find this to be too much trouble and don't use Cruise Control on steep hills.

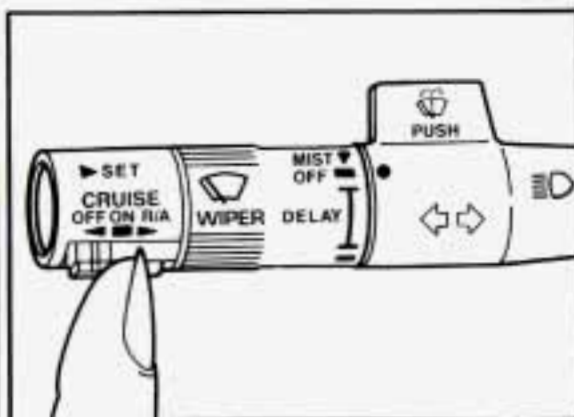

To Get Out of Cruise Control

There are several ways to turn off the Cruise Control:

1. Step lightly on the brake pedal or push the clutch pedal, if you have a manual transmission; OR
2. Move the Cruise switch to "OFF."

To Erase Speed Memory

When you turn off the Cruise Control or the ignition, your Cruise Control set speed memory is erased.

■ Operation of Lights

Although your vehicle's lighting system (headlights, parking lights, fog lamps, sidemarker lights and taillights) meets all applicable federal lighting requirements, certain states and provinces may apply their own lighting regulations that may require special attention before you operate these lights.

For example, some jurisdictions may require that you operate your fog lamps only when your lower beam headlights are also on, or that headlights be turned on whenever you must use your windshield wipers. In addition, most jurisdictions prohibit driving solely with parking lights, especially at dawn or dusk. It is recommended that you check with your own state or provincial highway authority for applicable lighting regulations.

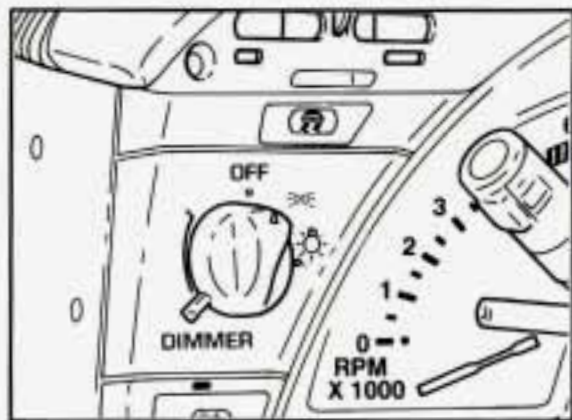

Headlights

The headlight knob controls these lights:

- Headlights
- Taillights
- Parking lights
- Sidemarkers lights

Turn the knob to ☀ to turn on your headlights and other operating lights.

Turn the knob to 🚗 to turn on your parking and other operating lights without your headlights.

Turn the knob to "OFF" to turn off the lights.

Your digital display will dim at dusk to remind you to turn on your headlights.

To read your odometer and fuel level with the ignition off, turn on your parking lights.

Lights On Reminder

If you turn the ignition "Off" and leave the lights on, you will hear a chime.

Brightness Control

The "DIMMER" switch controls the brightness of your instrument panel lights when your headlights or parking lights are on. Move the switch up or down to brighten or dim the lights. If you turn the switch all the way up, your courtesy, reading, map and cargo area lights will come on. Be sure to turn off the lights when you leave your vehicle.

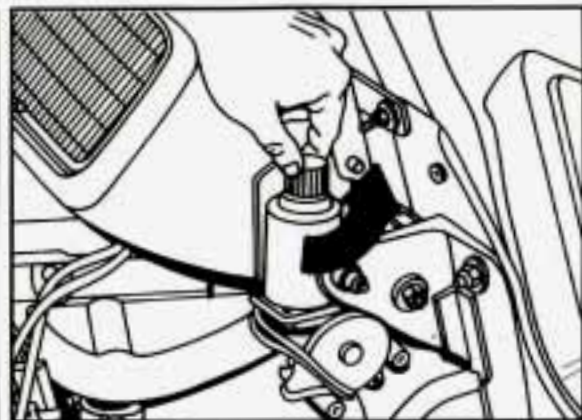

Headlight Doors

The headlight doors are designed to open when you turn the headlights on and close when you turn the headlights and parking lights off. If you turn the headlights on, then turn the headlight switch back to the parking lights setting, the headlight doors will stay open.

You can open the doors manually using the knob next to the headlight assembly. Turn the knob counterclockwise until the doors are open.

The headlight doors should be open when driving in icy or snowy conditions to prevent the doors from freezing closed and when washing the vehicle to help clean the headlights.

Features and Controls

Daytime Running Lights (Canada)

The Canadian Federal Government has decided that "Daytime Running Lights" (DRL) are a useful feature, in that DRL can make your vehicle more visible to pedestrians and other drivers during daylight hours. DRL are required on new vehicles sold in Canada.

Your DRL work with a light sensor on top of the instrument panel. Don't cover it up.

The front turn signal lights will come on in daylight when:

- The ignition is on
- The headlight switch is off, and
- The parking brake is released.

At dusk, the exterior lights will come on automatically and the front turn signal lights will go out. At dawn, the exterior lights will go out and the front turn signal lights will come on (if the headlight switch is off).

Of course, you may still turn on the headlights any time you need to.

To idle your vehicle with the DRL off, set the parking brake while the ignition is in the "Off" or "LOCK" position. Then start the vehicle. The DRL will stay off until you release the parking brake.



Fog Lights

Use your fog lights for better vision in foggy or misty conditions. Your parking lights or low beam headlights must be on or your fog lights won't work.

To turn the fog lights on, push the button. Push the button again to turn the fog lights off. A light above the button will come on when the fog lights are on.

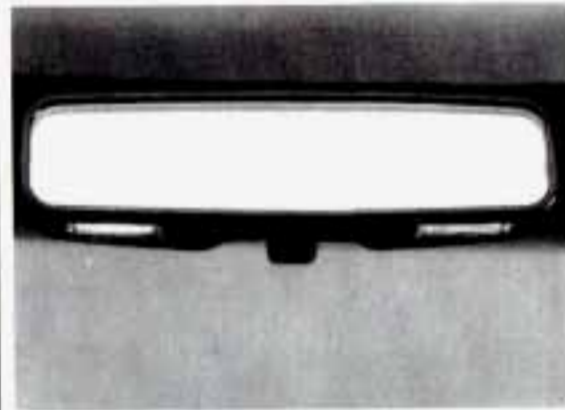

Interior Lights

Courtesy Lights

When any door is opened, the interior lights will go on (unless it's bright outside). The lights will stay on for about 30 seconds or until you turn on the ignition.

Front Map Lights

Your inside rearview mirror includes two map lights. The lights will go on when a door is opened. When the doors are closed and the ignition is on, press the switch to turn on the lights.

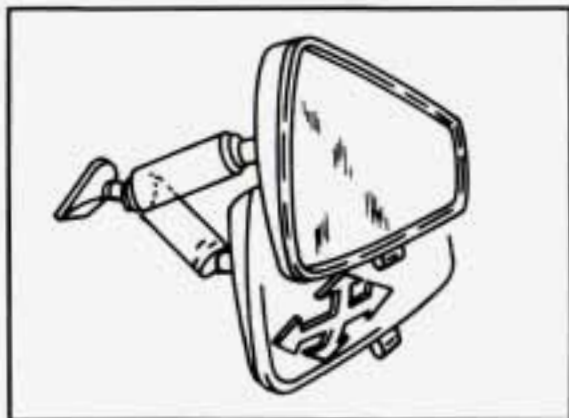

■ *Mirrors*

Inside Day/Night Rearview Mirror

An inside rearview mirror is attached above your windshield. The mirror has pivots so that you can adjust it.

You can adjust the mirror for day or night driving. Pull the tab for night driving to reduce glare. Push the tab for daytime driving.

Convex Outside Mirror

Your right side mirror is convex.

A convex mirror's surface is curved so you can see more from the driver's seat.

CAUTION:

If you aren't used to a convex mirror, you can hit another vehicle. A convex mirror can make things (like other vehicles) look farther away than they really are. If you cut too sharply into the right lane, you could hit a vehicle on your right. Check your inside mirror or glance over your shoulder before changing lanes.



Power Remote Control Mirrors

The electric mirror control is on the driver's door. To adjust either mirror, turn the switch to "L" (left) or "R" (right). Then use the joystick to adjust the mirror. When you are done adjusting the mirrors, move the control back to the center.

Features and Controls

■ *Roof Panel (COUPE)*

Until you are sure you can remove the panel alone, have someone help you.

Removing the Roof Panel



CAUTION:

Don't try to remove the roof panel while the vehicle is moving. Trying to remove the roof panel while the vehicle is moving could cause an accident. The panel could fall into the vehicle and cause you to lose control, or it could fly off and strike another vehicle. You or others could be injured. Remove the roof panel only when the vehicle is parked.

1. Park on a level surface, set the parking brake firmly and shift an automatic transmission into "P" (Park). Shift a manual transmission into "R" (Reverse). Lower both windows, turn the ignition key to "LOCK" and move both sunshades to the side.

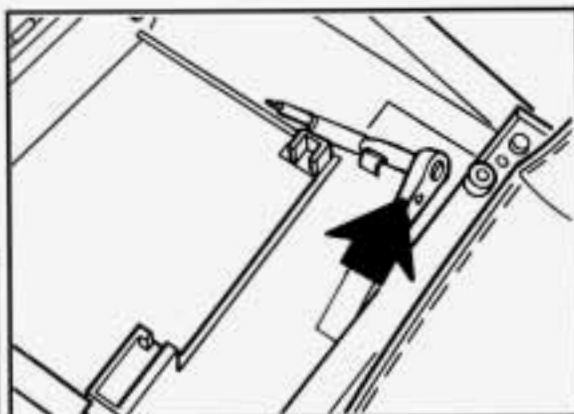

2. Remove the ratchet from the console.

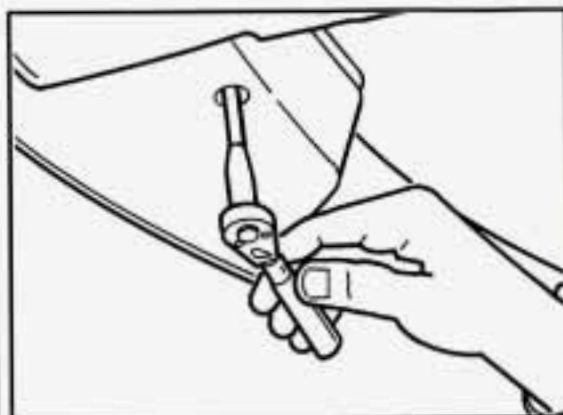

3. Use the ratchet to loosen the front bolts. Don't remove them. They'll stay in place when loose.

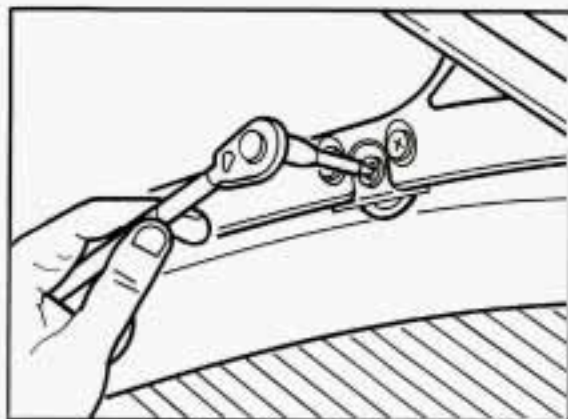

4. The two rear bolts are on the roof, one above each seat. You'll see three bolts on each side. Loosen the middle one. (The ratchet won't work for the other two.) The bolts will stay in the roof panel.
5. Stand on one side of the vehicle and have your helper stand on the other side. Together, lift the front of the panel up. Then move forward and lift the panel off the vehicle.

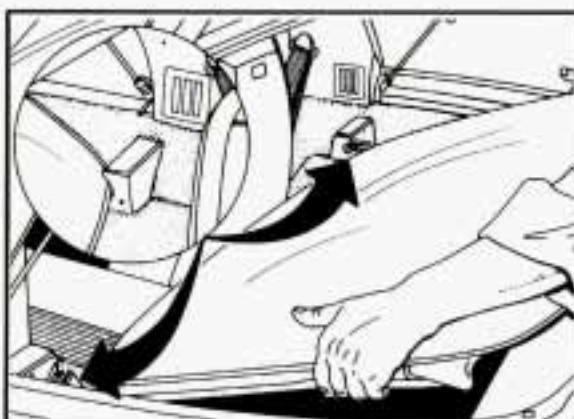

Storing the Roof Panel

CAUTION:

If the roof panel is not stored properly, it could be thrown about the vehicle in a crash or sudden maneuver. People in the vehicle could be injured. Whenever you store the roof panel in the vehicle, always be sure that it is stored securely in the rear area using the storage brackets and latch pin.

1. Open the rear hatch and look for the two brackets in the rear area. The brackets are below the courtesy lights.

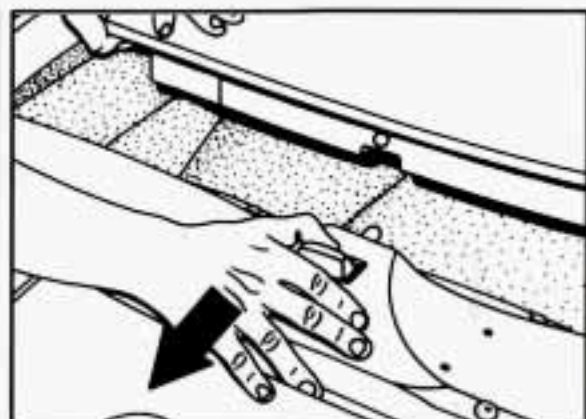

2. Store the roof panel with its top up and its rear pointing forward. Slide the rear corners of the roof panel into the brackets and push forward.

NOTICE:

Don't lift the front edge of the roof panel higher than eight inches (200 mm) when the corners are in the brackets. If you do, you could damage the roof panel.

3. Lower the front of the roof panel, centering it over the latch pin.
4. Pull the release toward you and press down on the roof panel.
5. Push the release forward until it latches.

Features and Controls

6. Gently lift up on the roof panel to be sure it is locked in place.

Installing the Roof Panel



CAUTION:

An improperly attached roof panel may fall into or fly off the vehicle. You or others could be injured. After installing the roof panel, always check that it is firmly attached by pushing up on the underside of the panel near the bolts. Check now and then to be sure the roof panel is firmly in place.

1. Park on a level surface, set the parking brake firmly and shift an automatic transmission into "P" (Park). Shift a manual transmission into "R" (Reverse). Lower both windows, turn the ignition key to "LOCK" and move both sunshades to the side.
2. If the roof panel is stored in the rear area, remove it by reversing the steps under "Storing the Roof Panel" above.

3. Lower the roof panel onto the vehicle, rear edge first, and place the rear guide pins into the holes in the roof opening.
4. Lower the front of the roof panel, and align the front guide pins.
5. Tighten the rear bolts part way.

NOTICE:

If you tighten bolts that are improperly started, the threads can become stripped. Be sure all bolts are properly started before you tighten them.

6. Use the ratchet to start the front bolts. If the bolts are hard to start, tighten the rear bolts some more. Holding down the panel on the outside will also help.
7. Fully tighten the rear bolts, then the front bolts.

If you hear a popping noise when you drive, the bolts may not be tight enough. Be sure to tighten them securely.



■ Storage and Compartments

Center Console

To use the storage area, push the button on the front end of the console and lift.

You can use the door key to lock and unlock the console. Don't leave the key in the lock, or it could be damaged when the driver sits down.



Your roof panel or hardtop wrench is stored here.



Rear Storage Compartment

This compartment is in the floor behind the passenger seat. To use it, push the button and lift the lid. Use the door key to lock it.

The top tray can be removed. The jack, wheel lock key and wheel nut socket are stored below the tray.

NOTICE:

Your Corvette's radio receiver is in the rear storage compartment. To help avoid damage to the receiver:

- Securely store jack in foam container after use.
- Store any other objects under the storage tray carefully.
- Do not store items such as liquids or sharp objects that could puncture or cut the radio receiver or wiring.

Also, to reduce the potential for radio receiver interference, do not install any other electronic module under the storage tray.

Door Storage Compartment

Each door has a storage compartment below the armrest.

Features and Controls



Security Shade (Coupe)

The security shade can provide hidden storage in the rear area of your vehicle.

To use the security shade:

- 1.** Pull the security shade by the center handle.

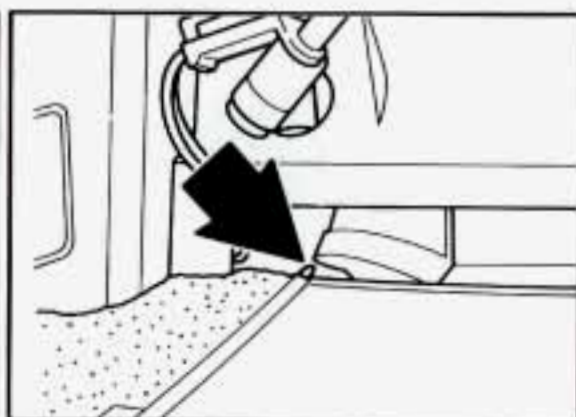

- 2.** Put the ends of the shade into the slots behind the seats.

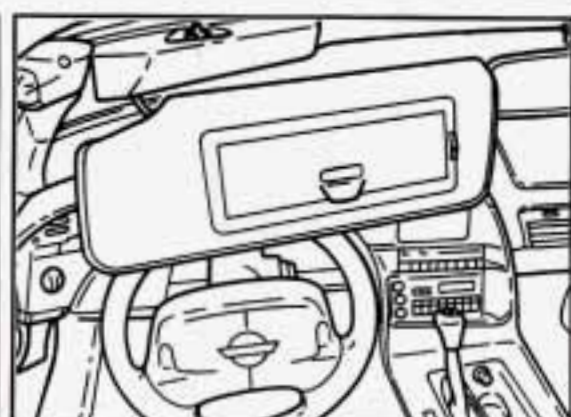

■ Sun Visors

To block out glare, you can swing down the visors. You can also swing them to the side.

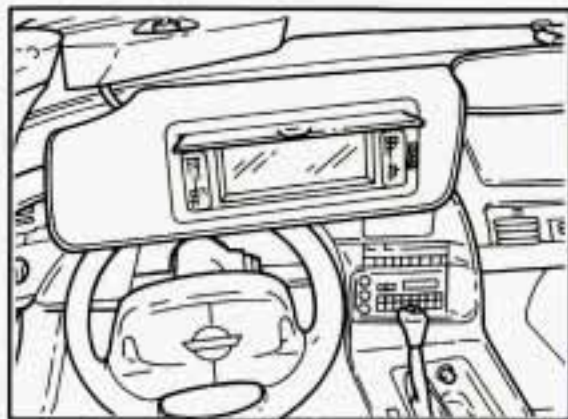

Covered Visor Vanity Mirror

Pull down the sun visor and lift the cover to expose the vanity mirror. When the ignition is on, slide the switch next to the mirror up to turn the lights on. Be sure to turn the lights off before closing the cover.

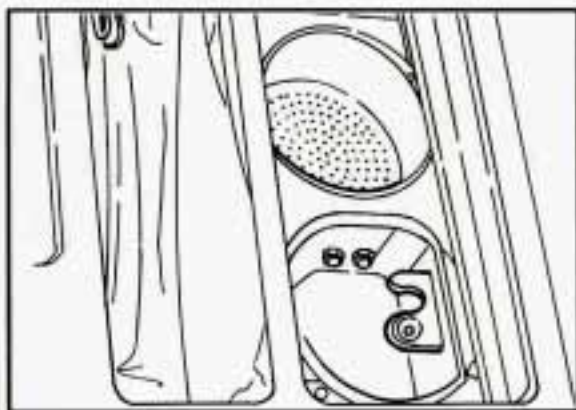

■ ***Ashtray and Lighter***

Ashtray

To use the ashtray, push on the right side of the door. To remove it, lift up on the snuffer.

NOTICE:

Don't put papers and other things that burn into your ashtray. If you do, cigarettes or other smoking materials could set them on fire, causing damage.

You can remove the ashtray and use the space as a second cupholder. When you put the ashtray back, be sure to use the rear opening.

NOTICE:

Loose objects (such as paper clips) can lodge behind and beneath the ashtray lid and prevent movement of the lid. Avoid putting small loose objects near the ashtray.

Features and Controls

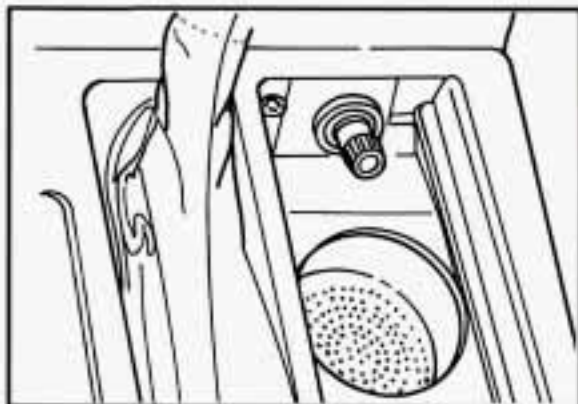

Cigarette Lighter

To use the lighter, push it in all the way and let go. When it's ready, it will pop back by itself.

NOTICE:

Don't hold a cigarette lighter in with your hand while it is heating. If you do, it won't be able to back away from the heating element when it's ready. That can make it overheat, damaging the lighter and the heating element.

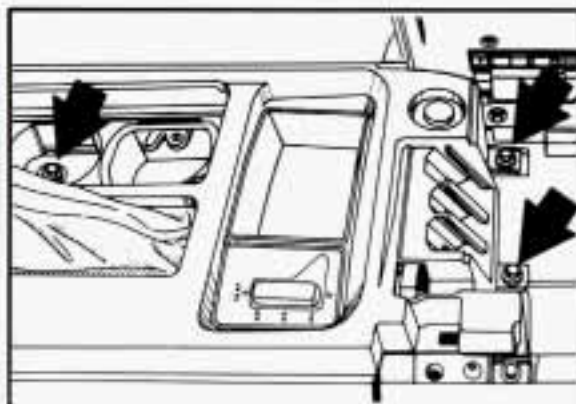

■ Accessory Plug

This plug is under the trim panel in front of the center console. The plug can be used to connect electrical equipment such as a cellular phone or CB radio. Be sure to follow the installation instructions included with the equipment.

To use the accessory plug:

1. Open the center console and carefully pull the carpet away from the coinholder to uncover the screws on either side.
2. Remove the screws.
3. Open the ashtray, pull out the rubber insert from the front cupholder and remove the screw inside the cupholder.

4. Remove the four screws that attach the console door.
5. Remove the console door.
6. Remove the trim plate by pulling up and back.
7. Disconnect the plug by pulling forward on the plastic locking tab and pull the plug into the console.

The plug has three separate wires:

- The orange wire connects to the battery.
- The pink wire connects to the ignition. Power is only available in "Run."
- The black wire connects to the ground.

NOTICE:

When using the accessory plug:

- Don't splice wires directly into the accessory plug wire. If done incorrectly, splicing might cause damage to your electrical system.
- The maximum load of any electrical equipment should not exceed 10 amps.
- Be sure to turn off any electrical equipment when not in use. Leaving electrical equipment on for extended periods can drain your battery.
- Do not use this plug if the electrical equipment requires frequent connecting and disconnecting. This may cause excessive wear on the accessory plug and damage your electrical system.

After you've installed the electrical equipment, put the trim panel and console lid back in place and install the screws.

Features and Controls

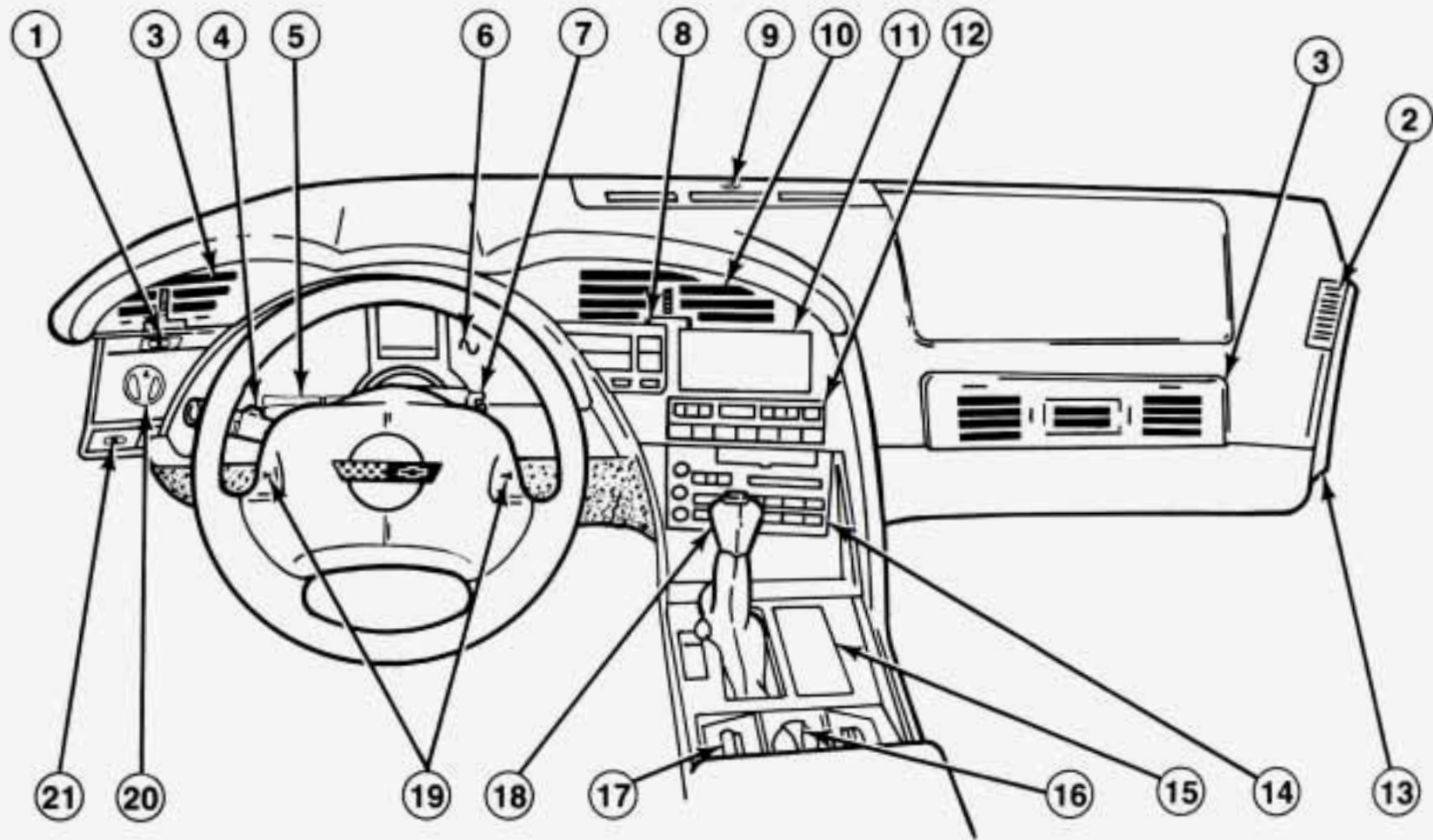

Instrument Panel

- 1.** Acceleration Slip Regulation Switch
- 2.** Side Window Defogger Vent
- 3.** Side Air Vent
- 4.** Turn Signal/Headlight Beam Lever
- 5.** Tilt Lever
- 6.** Instrument Cluster
- 7.** Ignition Switch
- 8.** Trip Monitor Controls
- 9.** Solar Sensor
- 10.** Center Air Vent
- 11.** Driver Information Center
- 12.** Comfort Controls
- 13.** Fuse Panel
- 14.** Audio System
- 15.** Ashtray/Lighter/Cupholder
- 16.** Selective Ride Control (if equipped)
- 17.** Power Seat Control (if equipped)
- 18.** Shift Lever
- 19.** Horn
- 20.** Main Light Control
- 21.** Fog Lamp Switch

Features and Controls



LT1 Engine

■ *Instrument Cluster*

Your instrument cluster and Driver Information Center are designed to let you know at a glance how your vehicle is running. You'll know how fast you're going, about how much fuel you have left and many other things you'll need to know to drive safely and economically.

The center display in the cluster is controlled by the Trip Monitor.

Speedometer and Odometer

Your speedometer lets you see your speed in either miles per hour (mph) or kilometers per hour (km/h). Your odometer shows how far your vehicle has been driven, in either miles or kilometers.

Press the "ENG MET" button on the Trip Monitor to switch the display between English units (miles) and metric units (kilometers).

Your Corvette's odometer is tamper-resistant. It will read "ODO ERR" if someone has tampered with it.



LT5 Engine

If a new odometer is installed, it will automatically reset to the correct reading. If an electrical or other problem makes setting the odometer correctly impossible, then it's set at zero, but a label on the driver's door must show the old reading and when the new one was installed.

Trip Odometer

The trip odometer can tell you how far your Corvette has been driven since you last set the trip odometer to zero.

To display the trip odometer, press "TRIP ODO" on the Trip Monitor. To reset it, press and hold "RESET TRIP" for two seconds.

Tachometer

The tachometer displays the engine speed in thousands of revolutions per minute (rpm).

Fuel will shut off at 7200 rpm for the LT5 (Code J) engine and at 5850 rpm for the LT1 (Code P) engine.

Features and Controls

■ *Warning Lights, Gauges and Indicators*

This section describes the warning lights and gauges that may be on your vehicle. The pictures will help you locate them.

Warning lights and gauges can signal that something is wrong before it becomes serious enough to cause an expensive repair or replacement. Paying attention to your warning lights and gauges could also save you or others from injury.

Warning lights go on when there may be or is a problem with one of your vehicle's functions. As you will see in the details on the next few pages, some warning lights come on briefly when you turn the ignition key just to let you know they're working. If you are familiar with this section, you should not be alarmed when this happens.

Gauges can indicate when there may be or is a problem with one of your vehicle's functions. Often gauges and warning lights work together to let you know when there's a problem with your vehicle.

When one of the warning lights comes on and stays on when you are driving, or when one of the gauges shows there may be a problem, check the section that tells you what to do about it. Please follow the manual's advice. Waiting to do repairs can be costly — and even dangerous. So please get to know your warning lights and gauges. They're a big help.

Your vehicle also has a driver information center that works along with the warning lights and gauges. See "Driver Information Center" in the Index.

System Problems

If "SYS" flashes on the display near your fuel gauge, there may be a problem with your Corvette's electrical system. If the "SECURITY" light flashes at the same time, there is a problem with your theft deterrent system. Have your vehicle checked by your dealer if "SYS" keeps appearing.

Gauge Markings

The analog gauges provide a quick visual reference to the actual measurement of these gauges. However, you must keep in mind that the gauges aren't linear. This means that the middle mark is not a temperature halfway between the top and bottom temperatures on the gauge. For example, the middle mark on the coolant gauge represents 210°F, not 180°F as you might expect.

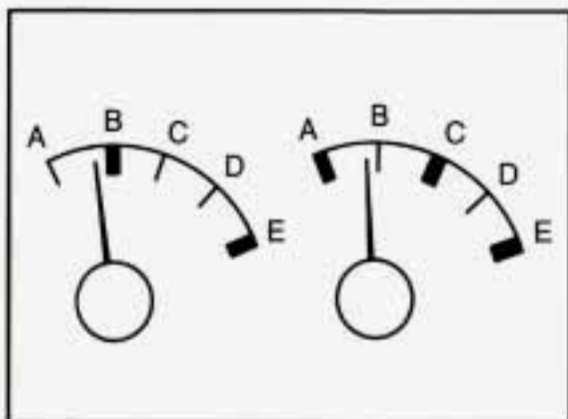

For your convenience, the following table gives the reading for each mark.

For numeric gauge measurements, refer to the digital readings by pressing "GAUGES" on the Trip Monitor.

NUMERIC GAUGE READINGS (°F)

| Gauge | Marking | | | | |
|---------------------|---------|-----|-----|-----|-----|
| | A | B | C | D | E |
| LT1 Oil Temperature | 100 | 215 | 250 | 285 | 320 |
| LT5 Oil Temperature | 100 | 190 | 220 | 250 | 280 |
| Coolant Temperature | 100 | 185 | 210 | 235 | 260 |

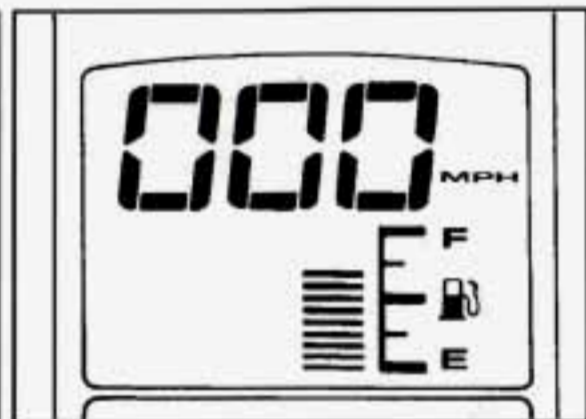

Fuel Gauge

Your fuel gauge shows about how much fuel is in your tank. The bars light up when the ignition is on or, if the ignition is off, when you turn on your parking lights.

When the display is down to the last two bars, "RESERVE" will appear next to the gauge.

Here are three concerns some owners have had about the fuel gauge. All these situations are normal and do not indicate that anything is wrong with the fuel gauge.

- At the gas station, the fuel pump shuts off before the gauge reads "F."

Features and Controls

- It takes more (or less) fuel to fill up than the gauge reads. For example, the gauge reads half full, but it took more (or less) than half of the tank's capacity to fill it.
- The gauge moves a little when you turn, stop or speed up.

You can use the Trip Monitor to display more detailed fuel information. Each time you press "FUEL INFO," one of the following will appear next to the fuel gauge.

- **INST:** The fuel economy calculated for your current driving conditions.
- **AVERAGE:** The fuel economy calculated for the current tank of fuel, or since you last reset the display.
- **RANGE:** The distance you can drive before refueling.
- **Blank:** The fuel gauge is displayed alone.

You should reset the fuel information display every time you refuel. Press "RESET FUEL" on the Trip Monitor.



Brake System Warning Light

Your Corvette's hydraulic brake system is divided into two parts. If one part isn't working, the other part can still work and stop you. For good braking, though, you need both parts working well.

This light should come on as you start the vehicle. If it doesn't come on then, have it fixed so it will be ready to warn you if there's a problem. If this warning light stays on, there could be a brake problem. Have your brake system inspected right away.

If the light comes on while you are driving, pull off the road and stop carefully. You may notice that the pedal is harder to push. Or, the pedal may go

closer to the floor. It may take longer to stop. If the light is still on, have the vehicle towed for service. (See "Towing Your Vehicle" in the Index.)



CAUTION:

Your brake system may not be working properly if the brake warning light is on. Driving with the brake warning light on can lead to an accident. If the light is still on after you've pulled off the road and stopped carefully, have the vehicle towed for service.



Parking Brake Indicator Light

This light will come on when you set your parking brake, and it will stay on if your parking brake doesn't release fully.

This light should also come on as you start the vehicle. If it doesn't come on then, have it fixed so it will be ready to remind you if the parking brake hasn't released fully.

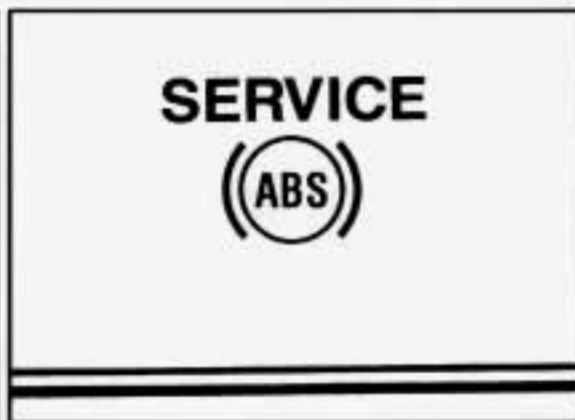

Anti-Lock Brake System Warning Light

With anti-lock, this light will come on when you start your engine and may stay on for about two seconds. That's normal. If the light doesn't come on, have it fixed so it will be ready to warn you if there is a problem.

If the light stays on, turn the ignition off. Or, if the light comes on when you're driving, stop as soon as possible and turn the ignition off. Then start the engine again to reset the system. If the light still stays on, or comes on again while you're driving, your Corvette needs service. If the regular brake system warning light isn't on, you still have brakes, but you don't have anti-lock brakes. If the regular brake system warning light is also on, you don't have anti-lock brakes and there's a problem with your regular brakes. See "Brake System Warning Light" earlier in this part.

Features and Controls

**ABS
ACTIVE**

Anti-Lock Brake System Active Light

When your anti-lock system is adjusting brake pressure to help avoid a braking skid, the "ABS ACTIVE" light will come on. Slippery road conditions may exist if this light comes on, so adjust your driving accordingly. The light will stay on for a few seconds after the system stops adjusting brake pressure. The "ABS ACTIVE" light also comes on briefly, as a bulb check, when the engine is started.

**SERVICE
ASR**

ASR System Warning Light

This light will come on for a few seconds when you turn the ignition on. If it stays on, there may be a problem with the ASR system. See your dealer.

When this warning light is on, the system will not limit wheel spin. Adjust your driving accordingly.

**ASR
OFF**

ASR Off Light

This light will come on for a few seconds when you turn the ignition on. It also comes on and stays on when the ASR button is pressed to turn the system off. See "Acceleration Slip Regulation System" in the Index.

ASR ACTIVE

ASR Active Light

When your ASR system is limiting wheel spin, the “ASR ACTIVE” light will come on. Slippery road conditions may exist if this light comes on, so adjust your driving accordingly. The light will stay on for a few seconds after the ASR system stops limiting wheel spin. The “ASR ACTIVE” light also comes on briefly, as a bulb check, when the engine is started.

Low Tire Pressure Warning Light (Option)

The LTPWS has a sensor on each road wheel that transmits to a receiver on the instrument panel. The system operates on a radio frequency subject to Federal Communications Commission (FCC) Rules.

This device complies with Part 15 of the FCC Rules. Operation is subject to the following two conditions:

1. This device may not cause harmful interference, and
2. This device must accept any interference received, including interference that may cause undesired operation.

Changes or modifications to this system by other than an authorized service facility could void authorization to use this equipment.

LOW/FLAT TIRE

The Low Tire Pressure Warning System (LTPWS) monitors air pressure in each road tire while you're driving your Corvette. The “LOW/FLAT TIRE” light will come on whenever tire pressure in any road tire goes below 25 psi (175 kPa), and it will stay on until you turn off the ignition. The light may come on if any LTPWS parts aren't working properly.

Features and Controls

For LTPWS to work properly, you must drive your Corvette faster than 25 mph (40 km/h) and for more than 2 miles (4 km). The system will not warn you before you begin to drive that a tire is flat. When the "LOW/FLAT TIRE" light comes on, check the tire pressure in all four road tires as soon as you can. Adjust the tire pressure as needed to those shown on the Tire-Loading Information label on the driver's door. If the light stays on after the tire pressure is adjusted, see your dealer.



CAUTION:

When the "LOW/FLAT TIRE" warning light is on, your vehicle's handling capabilities will be reduced during severe maneuvers. If you drive too fast, you could lose control of your vehicle. You or others could be injured. Don't drive over 55 mph (90 km/h) when the "LOW/FLAT TIRE" warning light is on.

NOTICE:

Driving with a flat tire may damage the tire, the wheel or the tire pressure sensor installed inside the tire on the wheel rim. Using tire sealants may also damage the sensor.

If you have EMTs, see "Extended Mobility Tires" in the Index.

The LTPWS sensor is directly opposite the valve stem on the tire. Take care when servicing or having your tires serviced. The sensors may not work properly if damaged. To prevent damage to the sensors, see the 1994 Corvette Service Manual for correct tire mounting and dismounting procedures.

The "LOW/FLAT TIRE" light may come on if your vehicle is close to another vehicle that has LTPWS and has a tire with low pressure.

LTPWS can warn you about a low tire, but it does not replace normal tire maintenance. See "Tires" in the Index.

SERVICE LTPWS

Service LTPWS Light (Option)

The "SERVICE LTPWS" light comes on whenever a LTPWS part is not working properly. It may also come on when you're going less than 25 mph (40 km/h) or in stop-and-go traffic. The light will go out when the electronic receiver gets a signal from each sensor.

Check the system by turning the ignition on. The light should come on and then go out. See your dealer if the light stays on or doesn't come on.

Here are two situations that cause the "SERVICE LTPWS" light to come on and stay on. Both of these situations are normal and do not indicate that anything is wrong with your Corvette.

- You turn the ignition on three times in a row for half an hour without moving your Corvette. The light will then come on every time you turn the ignition on until you move your Corvette.
- You run your Corvette three times in a row for half an hour while all four sensors are missing. (All the sensors would be missing, for example, if you put different wheels on your Corvette without transferring the sensors.)

If you would like to clear the "SERVICE LTPWS" light from your driver information center permanently, see your dealer.

If the light comes on and stays on, even when the vehicle is driven, there may be a problem with LTPWS. See your dealer.

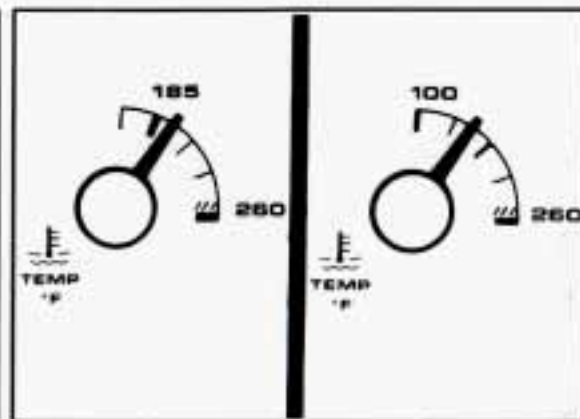

LT1 Engine

LT5 Engine

Engine Coolant Temperature Gauge

This gauge shows the engine coolant temperature. If the gauge pointer moves into the shaded area, your engine is too hot!

It means that your engine coolant has overheated. If you have been operating your vehicle under normal driving conditions, you should pull off the road, stop your vehicle and turn off the engine as soon as possible.

HOT COOLANT CAN BURN YOU BADLY!

In "Problems on the Road," this manual shows what to do. See "Engine Overheating" in the Index.

Features and Controls

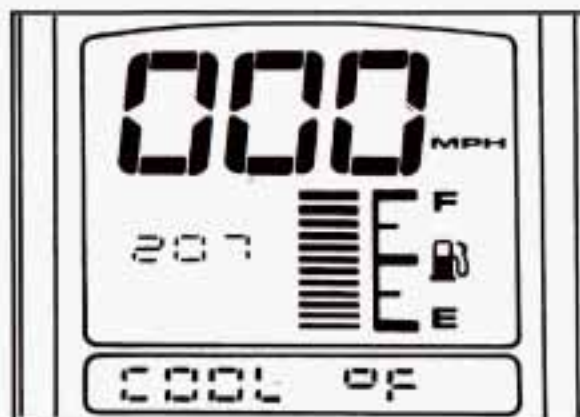

For numeric gauge measurements, press the "GAUGES" button on the Trip Monitor until "COOL" appears. The number that appears next to the fuel gauge is the coolant temperature. If "LO" appears, the temperature is below 32°F (0°C).

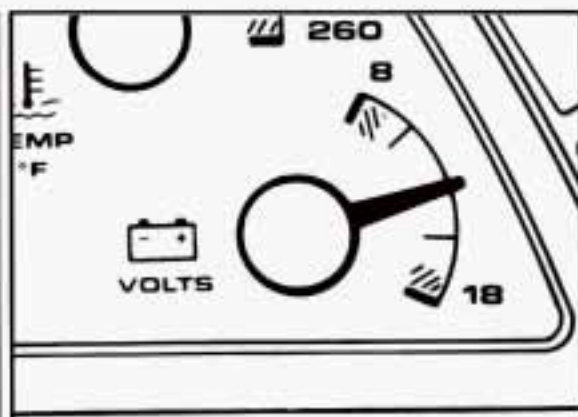

Voltmeter

You can read the charging system's rate of charge on your voltmeter when your engine is running. When the engine is not running, the voltmeter shows the voltage output of your battery.

Readings between the shaded areas show the normal operating range. The reading will change as the rate of charge changes (with engine speed, for example), but if the voltmeter reads in either shaded area, and it stays there, you may have a problem with the charging system. Have it checked right away. Driving with the voltmeter reading in a shaded area could drain your battery.

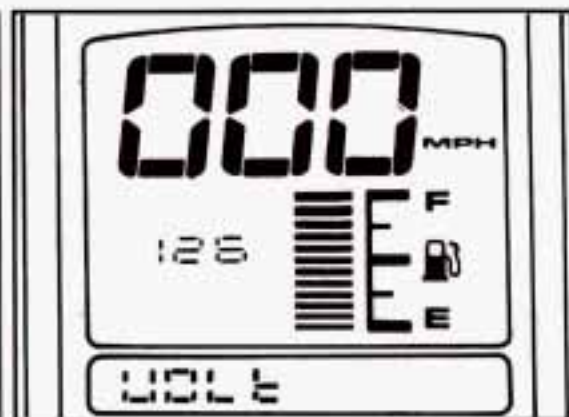

If you must drive a short distance with the voltmeter reading in a shaded area, turn off all your accessories, including your comfort controls and audio systems.

For numeric gauge measurements, press the "GAUGES" button on the Trip Monitor until "VOLT" appears. The number that appears next to the fuel gauge is the battery voltage.

SERVICE

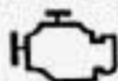

SOON

Malfunction Indicator Lamp (Service Engine Soon Light)

A computer monitors operation of your fuel, ignition and emission control systems. This light should come on when the ignition is on, but the engine is not running, as a check to show you it is working. If it does not come on at all, have it fixed right away. If it stays on, or it comes on while you are driving, the computer is indicating that you have a problem. You should take your vehicle in for service soon.

NOTICE:

If you keep driving your vehicle with this light on, after a while the emission controls won't work as well, your fuel economy won't be as good and your engine may not run as smoothly. This could lead to costly repairs not covered by your warranty.

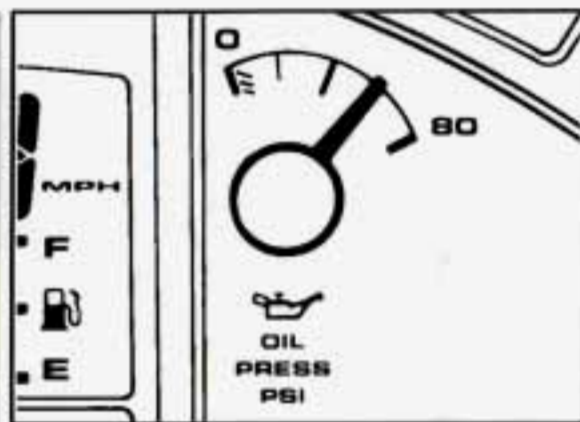

Engine Oil Pressure Gauge

This gauge tells you if there could be a problem with your engine oil pressure.

The engine oil pressure gauge shows the engine oil pressure in psi (pounds per square inch) or kPa (kilopascals) when the engine is running. Oil pressure should be 20 to 80 psi (140 to 550 kPa). It may vary with engine speed, outside temperature and oil viscosity, but readings above the shaded area show the normal operating range. Readings in the shaded area tell you that the engine is low on oil, or that you might have some other oil problem. See "Engine Oil" in the Index.

Features and Controls



CAUTION:

Don't keep driving if the oil pressure is low. If you do, your engine can become so hot that it catches fire. You or others could be burned. Check your oil as soon as possible and have your vehicle serviced.

NOTICE:

Damage to your engine from neglected oil problems can be costly and is not covered by your warranty.

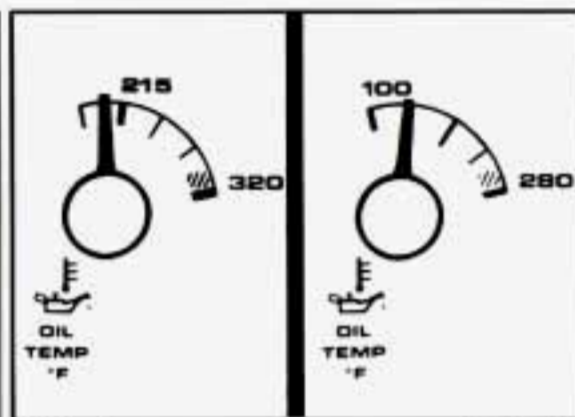

LT1 Engine

LT5 Engine

Engine Oil Temperature Gauge

This gauge shows your engine oil temperature. Oil temperature may vary with the type of driving you do and weather conditions, but readings above the shaded area show the normal operating range. If your oil temperature is close to the shaded area and it stays there, your oil temperature is too high. Check the engine coolant temperature and engine oil level. If your engine is too hot, see "Engine Overheating" in the Index. Your vehicle may need service; see your dealer.

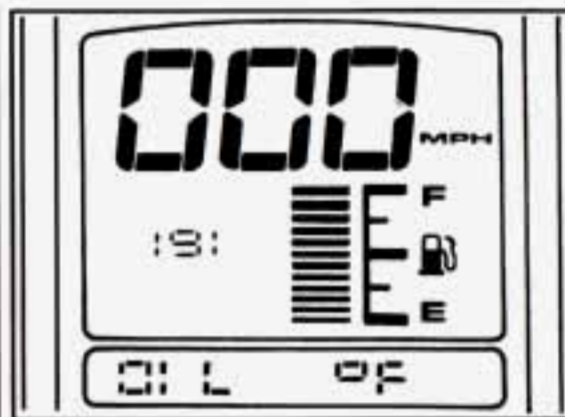

For numeric gauge measurements, press the "GAUGES" button on the Trip Monitor until "OIL" appears. The number that appears next to the fuel gauge is the oil temperature. If "LO" appears, the temperature is below 32°F (0°C).

A rectangular icon with rounded corners, tilted at an angle. It contains the text "CHECK GAUGES" in a bold, sans-serif font.

Check Gauges Light

This light will come on briefly when you are starting the engine. If the light comes on and stays on while you are driving, check your gauges to see if they are in the warning areas.

This light can come on for:

- high oil temperature or low oil pressure
- high coolant temperature
- high or low battery voltage
- low fuel level

A rectangular icon with rounded corners, containing the text "LOW OIL" in a bold, sans-serif font.

Low Oil Light

This light should come on while you are starting your engine. If the light doesn't come on, have it repaired. If the light comes on while starting your engine and stays on, your engine oil level may be too low. You may need to add oil. See "Engine Oil" in the Index.

A rectangular icon with rounded corners, containing the text "LOW COOLANT" in a bold, sans-serif font.

Low Coolant Light

This light comes on when the coolant in the system is low. You may need to add coolant. See "Engine Coolant" in the Index.

NOTICE:

Driving with the "LOW COOLANT" light on could cause your Corvette to overheat. See "Engine Overheating" in the Index. Your Corvette could be damaged, and it wouldn't be covered by your warranty.

Features and Controls

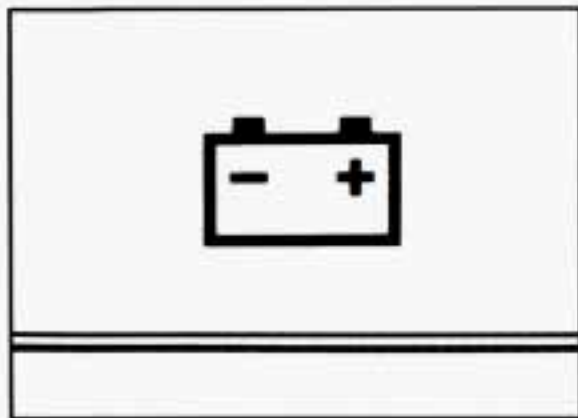

Charging System Light

This light will come on when you turn on the ignition, but the engine is not running, as a check to show you it is working. It should go out when the engine starts. If it stays on or comes on while you are driving, you may have a problem with the electrical charging system. It could indicate that you have a loose or broken drive belt or another electrical problem. Have it checked right away. Driving while this light is on could drain your battery.

If you must drive a short distance with the light on, be certain to turn off all your accessories, such as the radio and air conditioner.



Door Ajar Light

This light comes on when you open one of the doors with the ignition on. It stays on until you fully close the door. Have your vehicle serviced if the light comes on and stays on even when the doors are fully closed.



Engine Oil Life Monitor

The "CHANGE OIL" light comes on for a few seconds when you turn the ignition on. It will come on and stay on when it's time to change your oil.

The monitor uses oil temperature and engine revolutions to decide when the oil is nearly worn out. The light is only a reminder, though. You should change your oil at the intervals recommended in your Maintenance Schedule, even if the "CHANGE OIL" light hasn't come on.

Be sure to reset the monitor when your oil is changed, even if the "CHANGE OIL" light didn't come on. If you don't reset the monitor, it won't work correctly. Follow these steps:

1. Turn the key to "Run," but don't start the engine.
2. Press "ENG MET" on the Trip Monitor. Then, within five seconds, press it again.
3. Within five seconds, press and hold "GAUGES" on the Trip Monitor. The "CHANGE OIL" light should flash.
4. Hold the "GAUGES" button until the "CHANGE OIL" light stops flashing and goes out. This should take about ten seconds.

When the light goes out, the monitor is reset. If the monitor doesn't reset, turn the ignition off, then try again.

SERVICE RIDE CONTROL

Service Ride Control Light

This light should come on for a few seconds when you start your vehicle. If the light stays on or comes on while you're driving, there may be a problem with your Selective Ride Control system. You can still drive, but you should see your dealer soon.

The Selective Ride Control system is designed to sense vehicle speed in the first minute after the vehicle is started. If the vehicle is not moved in that first minute, the system records a fault. The "SERVICE RIDE CONTROL" light comes on after three faults are recorded. If the light comes on for this reason, move your Corvette and the light should go out.

PASSIVE KEYLESS ENTRY

Passive Keyless Entry Light

This light will come on for about two seconds when you turn the ignition on, unless your keyless entry system is off. The light also comes on and flashes when you are programming transmitters. See "Passive Keyless Entry System" in the Index.

Features and Controls

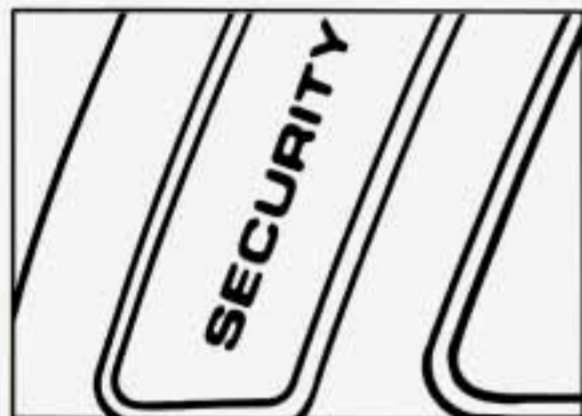

Security Light

This light comes on to remind you to arm your theft deterrent system. If it comes on and stays on when your ignition is on, there may be a problem with your theft deterrent system. See "Universal Theft Deterrent" and "PASS-Key" in the Index.



■ *Convertible Top (OPTION)*

The following procedures explain the proper operation of your convertible top.

To Lower Your Convertible Top

NOTICE:

Don't leave your convertible out with the top down for any long periods of time. The sun and the rain can damage your seat material and other things inside your vehicle.

1. Park on a level surface, set the parking brake firmly and shift an automatic transmission into "P" (Park). Shift a manual transmission into "R" (Reverse). Lower both windows and sunshades and turn the ignition key to "LOCK."

NOTICE:

Before lowering the convertible top into the storage area, be sure there are no objects in the way of the folded, stored top. The weight of a stored top on items in the storage area may cause the convertible top back glass to break.

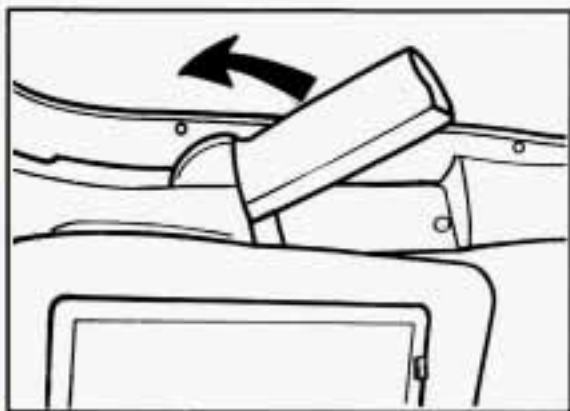

- 2.** Unlock the front of the convertible top by turning the latch handles outward. Then lift the top off the windshield slightly.

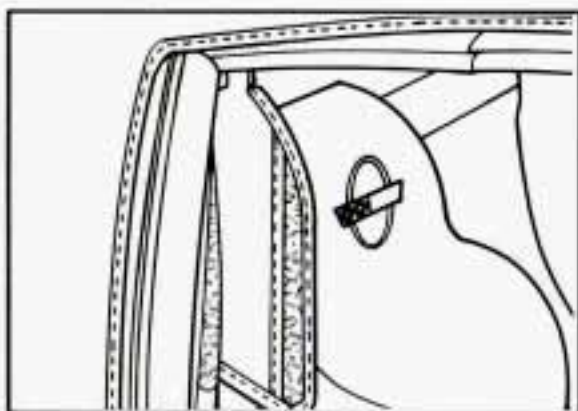

- 3.** Unfasten the strips at the rear of each window opening.



- 4.** Tilt the driver's seatback forward. The convertible top release handle is behind the driver's seat beneath the storage compartment lid. Pull the inside edge of the handle forward.

Features and Controls

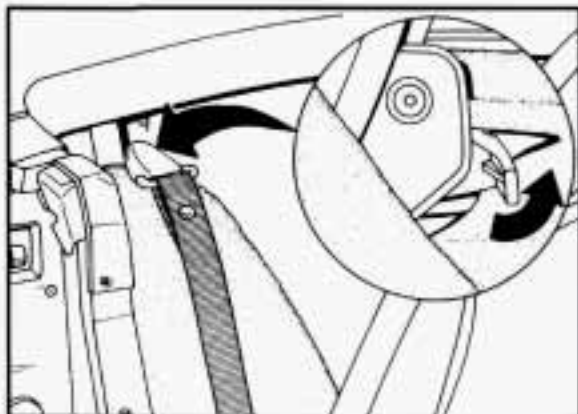

If your Corvette has lost power (dead battery, for example), you can still open the storage compartment using the manual release handles. The handles are near the sidewall behind the safety belt anchors on each side of your vehicle. Move the handles toward the rear of the vehicle and upward.



5. From the driver's side, lift and hold the rear of the top with one hand. With your other hand, press the storage compartment lid release button behind the driver's seat on the lid. (The release switch in the center console will also work.) Then raise the lid.

NOTICE:

Do not leave the convertible top on the closed lid when lowering the top. This may result in paint damage.

6. Lower the rear of the top. Then lift the front with a slow, smooth motion. Fold the top into the storage compartment, making sure the fabric is folded between bows.

NOTICE:

Do not lift the rear of the convertible top when lowering the top into the storage compartment or damage to the top may occur.

7. After the top is completely folded into the compartment, turn the latch handles toward the center of the vehicle. Close the storage compartment lid by pushing the front edge down on each side. Try to lift the lid to make sure it's latched.

NOTICE:

When closing the storage compartment lid, make sure the latch handles are turned back toward the center of the vehicle. If they aren't, you may damage the paint on the lid inner panel.

To Raise Your Convertible Top

1. Park on a level surface, set the parking brake firmly and shift an automatic transmission into "P" (Park). Shift a manual transmission into "R" (Reverse). Lower both windows and sunshades and turn the ignition key to "LOCK."
2. Press either the storage compartment lid release button behind the driver's seat or in the center console.

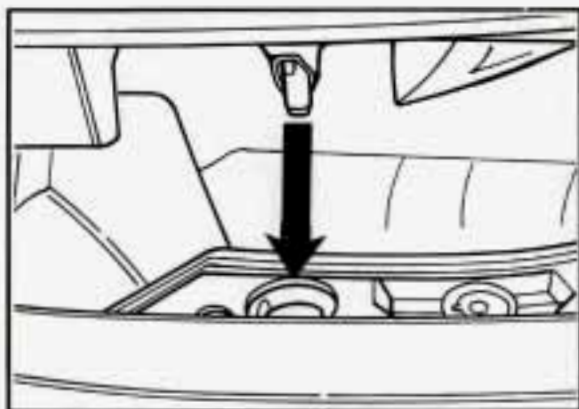

3. Turn the latch handles outward. Pull the top up and forward until it lines up with the windshield.
4. Latch the top by turning the handles toward the center of the vehicle. If needed, push down on the outside corners.
5. Lift the rear of the top and close the compartment lid firmly.

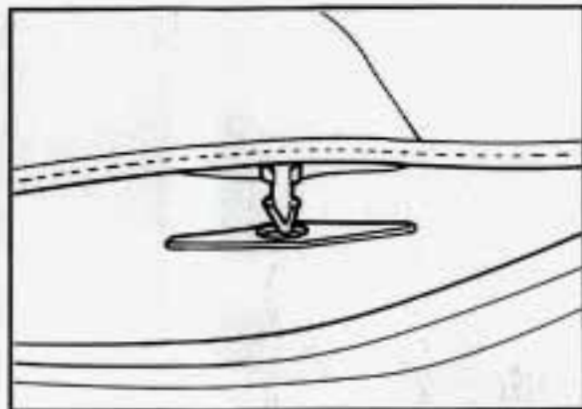

6. Lower the rear of the top so the latch pins align with the holes in the lid. To secure the rear of the top, push down firmly on both corners.

Features and Controls



7. Fasten the strips for the headliner at the rear of each window opening.

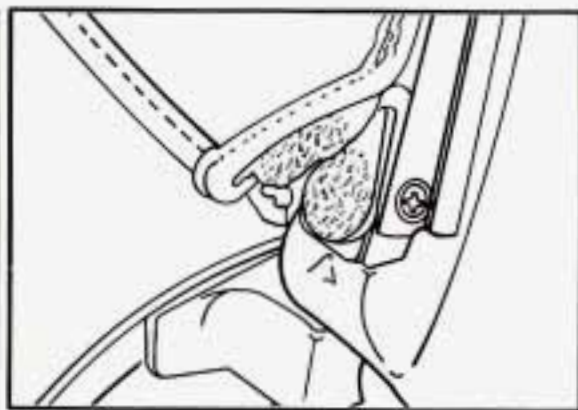

8. Then fasten the lower front corner of the top.

NOTICE:

Certain automatic vehicle washes may cause damage to your vehicle. The top fabric can be damaged by top cleaning brushes.

For care and cleaning of your convertible top, see "Cleaning Your Convertible Top" in the Index.

■ ***Convertible Hardtop*** **(OPTION)**

The convertible hardtop is designed for extended use in both warm and cold weather. The installation and removal of this top requires two people and takes about 30 minutes. You will need the wrench and ratchet stored in the center console.

To Remove Your Convertible Hardtop

1. Park on a level surface, set the parking brake firmly and shift an automatic transmission into "P" (Park). Shift a manual transmission into "R" (Reverse). Lower both windows and sunshades and turn the ignition key off.

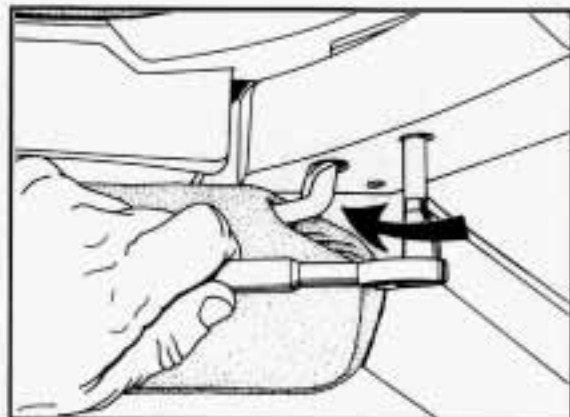

- 2.** Loosen the front bolts with the wrench.

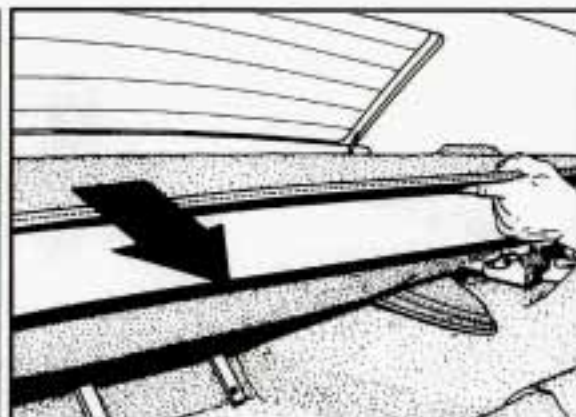

- 3.** Move both seatbacks forward and remove the rear trim panel.

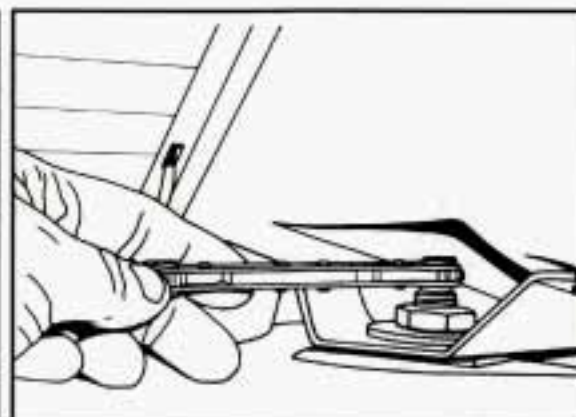

- 4.** Loosen the rear corner bracket bolts with the ratchet.

Features and Controls

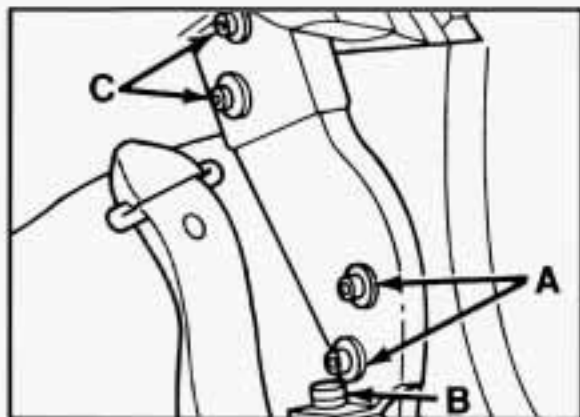

5. Using the wrench, remove the two lower bolts (A) from the lock pillar bracket on each side.
6. Remove the bolt (B) from the bottom flange of each lock pillar bracket.
7. Then remove the two upper bolts (C) from the receiver bracket on each side.

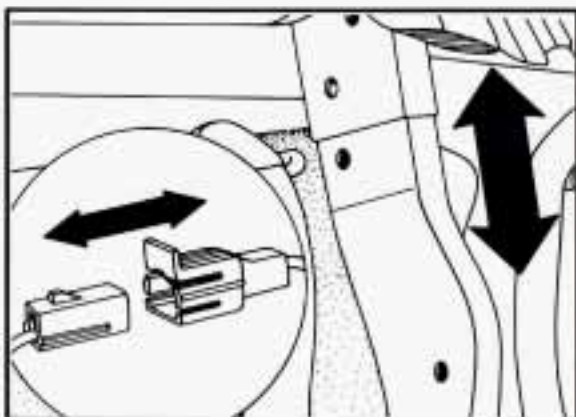

8. Slide both lock pillar brackets down and forward from the receiver brackets. You may need to lift the hardtop slightly to remove the brackets.
9. Disconnect both wire connectors behind the lock pillar brackets. These are the rear window defogger wires.



10. With one person on each side, gently lift the hardtop about eight inches (200 mm) straight up. Remove the hardtop over the rear of the vehicle.

NOTICE:

To help avoid damaging the hardtop when not in use:

- Store the hardtop in its normal position, resting on its mounting brackets.
- Store hardware and trim panel with the hardtop.

11. Connect the rear window defogger electrical connectors to the convertible top rear window. Make sure they are inside the vehicle.

To Install Your Convertible Hardtop

1. Park on a level surface, set the parking brake firmly and shift an automatic transmission into "P" (Park). Shift a manual transmission into "R" (Reverse). Lower both windows and sunshades. Turn off the radio to lower the power antenna and turn the ignition key to "LOCK."
2. Disconnect both rear window defogger electrical connectors behind the lock pillar.
3. Lower the convertible top. Refer to "Convertible Top" in the Index.
4. With one person on each side, carefully position the hardtop over the vehicle. Lower the hardtop slowly, aligning the rear bolt spacers onto the bezels, and front conical nuts into the tapered receivers. Realign the hardtop, if necessary.

NOTICE:

To help avoid damage, don't force the rear of the hardtop down. The hardtop may rest slightly above the storage compartment lid until the release lever is pulled. See step 8 in this procedure.

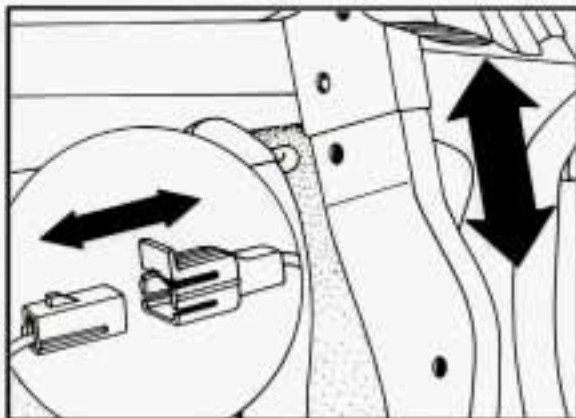

5. Move both seatbacks forward. Slide the lock pillar bracket into the receiver bracket until the scribed line is even with the lower edge of the receiver bracket.
6. Connect the electrical connectors to the hardtop rear window. Make sure they are inside the vehicle.

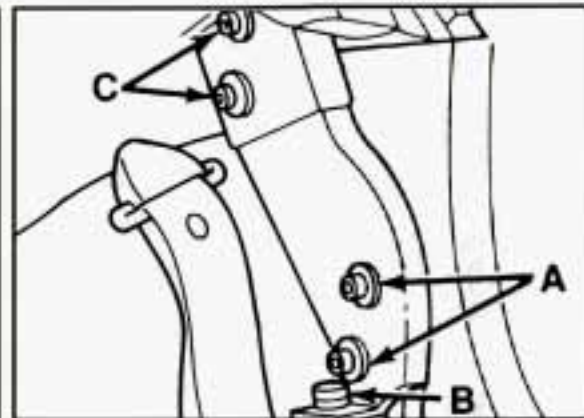

7. Insert the two upper bolts (C) into both receiver brackets. You may have to lift the hardtop slightly to install the lock pillar bracket.
8. If the hardtop hasn't lowered into position, pull the release lever behind the driver's seat under the storage compartment lid.

Features and Controls

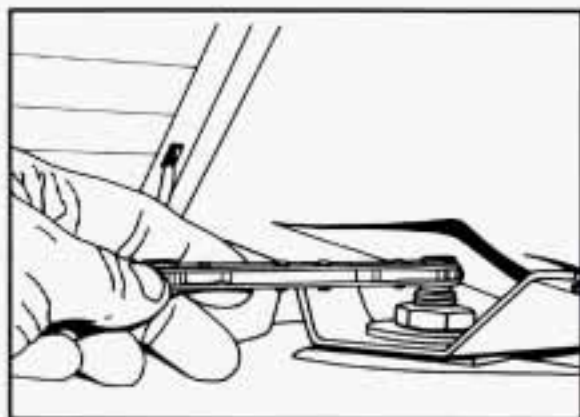

9. Secure but don't tighten the rear corner bracket bolts using the ratchet.

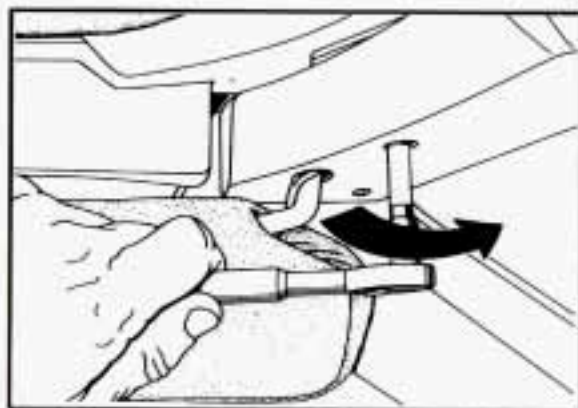

10. Tighten the front bolts using the wrench.
11. Insert the lower bolt into the bottom flange of the lock pillar brackets and tighten. Install and tighten the remaining bolts into the lock pillar brackets.
12. Using the ratchet, tighten the rear corner bracket bolts. Do not over-tighten these bolts.
13. Slide the rear trim panel in place.

CAUTION:

If the hardtop isn't secure, it can't give as much protection in a crash. A loose hardtop could fly off the vehicle in an accident or sudden maneuver. You or others could be injured. Don't drive your vehicle until all the hardtop fasteners are tight.



In this part you'll find out how to operate the comfort control systems and audio systems offered with your Corvette. Be sure to read about the particular system supplied with your vehicle.

Part 3 Comfort Controls & Audio Systems

| | |
|---|-----|
| Comfort Controls | 106 |
| Air Conditioner Controls | 106 |
| Automatic Electronic Climate Control | 108 |
| Rear Window Defogger | 111 |
| Treated Windshield | 111 |
| Flow-Through Ventilation System | 111 |
| Audio Systems | 112 |
| Setting the Clock | 113 |
| Noise Reduction | 113 |
| AM/FM Stereo with Cassette Tape Player | 113 |
| Delco/Bose AM/FM Stereo with Cassette Tape and Compact Disc Player | 115 |
| Understanding Radio Reception | 117 |
| Care of Your Cassette Tape Player | 117 |
| Care of Your Compact Discs | 118 |
| Power Antenna Mast Care | 118 |

Comfort Controls and Audio Systems

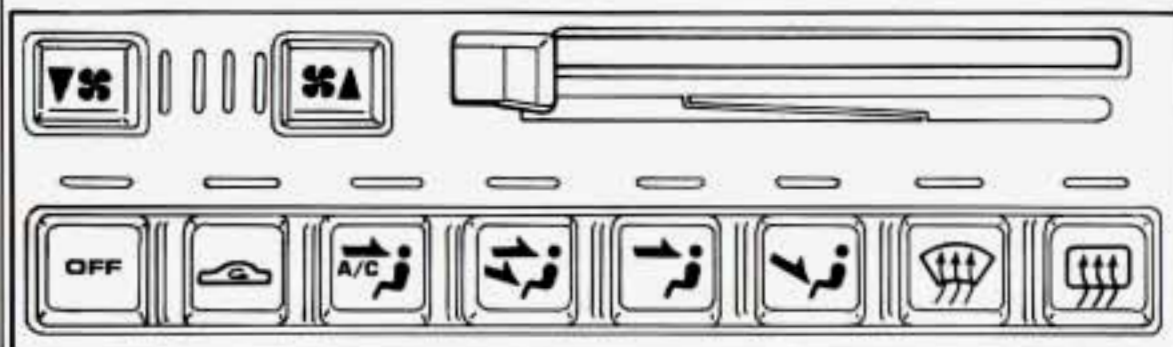

■ *Comfort Controls*

With these systems, you can control the heating, cooling and ventilation in your Corvette.

Your vehicle also has the flow-through ventilation system described later in this section.

Air Conditioner Controls

Fan Control Buttons

Press the arrows on the fan switch to select the force of air you want.

Temperature Control Lever



Move the lever to change the temperature of the air flowing from the system. Move it to the right for warmer air and to the left for cooler air.

Air Control Buttons

OFF: The system is off.

 : Provides maximum cooling or quick cool-down on very hot days. This setting recirculates most of the air inside your vehicle. If it is used for long periods of time, the air may become dry. This setting directs air through the upper air vents. It will not work when outside temperatures are below 40°F (5°C).

 : Use for normal cooling on hot days. This setting cools outside air and directs it through the instrument panel vents.

The air conditioner compressor also operates in  and . It only works when the outside temperature is above freezing. When the air conditioner is on, you may sometimes notice slight changes in your vehicle's engine speed and power. This is normal because the system is designed to cycle the compressor on and off to keep the desired cooling and help fuel economy.

 : This setting cools outside air and directs it through the instrument panel vents and the heater ducts.



 : Air flows through the instrument panel vents.

 : This setting directs most of the air through the heater ducts and some of the air through the defroster vents.

 : This setting directs most of the air through the windshield defroster and side window defogger vents and some of the air through the heater ducts.

Heating



The heater works best if you keep your windows closed while using it.

1. Press .
2. Press .
3. Slide the temperature control lever to a comfortable setting.

If your vehicle has an engine coolant heater and you use it in cold weather, 0°F (-18°C) or lower, your heating system can provide heat more quickly because the engine coolant is already warmed. See “Engine Coolant Heater” in the Index.



Bi-Level

You may want to use bi-level on cool, but sunny days. This setting directs outside air through the instrument panel vents and the heater ducts.

1. Press .
2. Press .
3. Slide the temperature control lever to a comfortable setting.

Ventilation



For mild outside temperatures, when little heating or cooling is needed, you can still direct outside air through your vehicle.

1. Press .
2. Press .
3. Slide the temperature control lever to a comfortable setting.



Defogging and Defrosting Windows

Your vehicle has several settings for clearing your windows. The air conditioner compressor will run to help remove moisture from the air.



To defrost the windshield quickly:

1. Press .
2. Press .
3. Slide the temperature control lever all the way to the right.

To warm passengers while keeping the windshield clear:



1. Press  and  at the same time.
2. Press .
3. Slide the temperature control lever to a comfortable setting.

To defrost the side windows quickly:

1. Press .
2. Press .
3. Slide the temperature control lever all the way to the right.

Cooling

The air conditioner works best if you keep your windows closed. On very hot days, open the windows just long enough for the hot air to escape.

1. Press .
2. Press .
3. Slide the temperature control lever to a comfortable setting.

Comfort Controls and Audio Systems

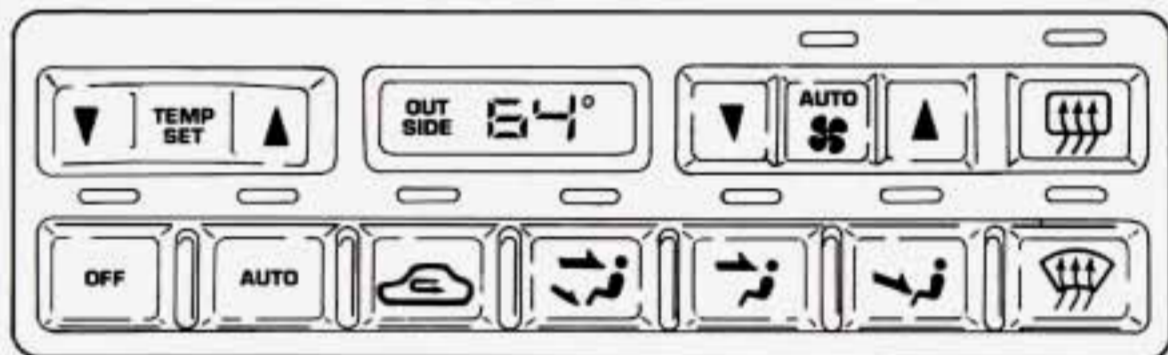

Automatic Electronic Climate Control (OPTION)

With this system you set a temperature and then either let the system adjust air flow and force to maintain the temperature, or you can manually adjust flow and force.

Fan Control Buttons

Press the arrows on the fan switch to select the force of air you want. Press "AUTO" to let the system select the force of air.

Temperature Control Switch

Press the arrows on the "TEMP SET" switch to set the temperature you want in your vehicle. The temperature you

select will show on the display for a few seconds, then the outside temperature will show.

Air Control Buttons

OFF: The system is off.

AUTO: The system controls air flow.

: Provides maximum cooling or quick cool-down on very hot days. This setting recirculates most of the air inside your vehicle. If it is used for long periods of time, the air may become dry. This setting directs air through the upper air vents. It will not work when outside temperatures are below 40°F (5°C).

: This setting directs outside air through the instrument panel and side window defogger vents and the heater ducts.

: Outside air flows through the instrument panel vents.

: This setting directs all of the air through the heater ducts.

: This setting directs most of the air through the windshield defroster and side window defogger vents and some of the air through the heater ducts.

Temperature Sensors

Sunload: This sensor is on top of the instrument panel. When the inside temperature is increased by sunlight, the system will lower the inside temperature up to 5°F (3°C) below the setting on the display.

Outside Temperature: This sensor is on the right side of the upper radiator support in the grille opening. This is what you usually see on the display.

If the outside temperature goes up, the displayed temperature will not change until:

- Vehicle speed is above 25 mph (40 km/h) for at least 3 minutes, or
- Vehicle speed is above 45 mph (72 km/h) for 1 1/2 minutes.

This delay helps prevent a false reading. If vehicle speed remains above 25 mph (40 km/h) or the temperature goes down, the display is updated immediately.

If your vehicle has been off for more than three hours, the current outside temperature will be stored in the system when you start the vehicle.

Inside Temperature: This sensor is in the center air outlet on the passenger side.

If you block or cover either interior sensor, the system will give a false reading.

Automatic Control



The system will adjust to maintain the temperature you set. It will select the best fan speed and air flow setting to keep you comfortable with the least amount of noise.

1. Press the arrows on the "TEMP SET" switch to set a comfortable temperature.
2. Press "AUTO."

The fan speed will adjust automatically unless you press the arrows on the switch.

Manual Heating

The heater works best if you keep your windows closed while using it.

1. Press the arrows on the "TEMP SET" switch to set a comfortable temperature.
2. Press .
3. Press the arrows on the fan speed switch if you don't like the automatic setting. In "AUTO 

If your vehicle has an engine coolant heater and you use it in cold weather, 0°F (-18°C) or lower, your heating system can provide heat more quickly because the engine coolant is already warmed. See "Engine Coolant Heater" in the Index.

Manual Bi-Level

Bi-level can heat or cool outside air and direct it in two directions.

1. Press the arrows on the "TEMP SET" switch to set a comfortable temperature.
2. Press .

3. Press the arrows on the fan speed switch if you don't like the automatic setting.

Manual Ventilation

For mild outside temperatures, when little heating or cooling is needed, you can still direct outside air through your vehicle.



1. Press the arrows on the "TEMP SET" switch to set a comfortable temperature. For ventilation, the system can't cool the vehicle below the outside temperature.
2. Press .
3. Press the arrows on the fan speed switch if you don't like the automatic setting.

Manual Cooling

The air conditioner works best if you keep your windows closed. On very hot days, open the windows just long enough for the hot air to escape.

1. Press the arrows on the "TEMP SET" switch to set a comfortable temperature.
2. Press . After cool-down, adjust the air flow to another setting. The compressor works in all settings

Comfort Controls and Audio Systems

except  and  and at all temperatures above freezing.

3. Press the arrows on the fan speed switch if you don't like the automatic setting. In "AUTO " on hot days, the fan speed will be low at first to help get rid of the hot inside air.



When the air conditioner is on, you may notice slight changes in your vehicle's engine speed and power. This is normal because the system is designed to cycle the compressor on and off to keep the desired temperature and help fuel economy.

Defogging and Defrosting Windows



Your vehicle has several settings for clearing your windows. The air conditioner compressor will run to help remove moisture from the air.

To defrost the windshield quickly:

1. Press the arrows on the "TEMP SET" switch to set a comfortable temperature.
2. Press .
3. The fan will go to high speed. After the windows are clear, you can lower

the speed using  or "AUTO .

To warm passengers while keeping the windshield clear:

1. Press the arrows on the "TEMP SET" switch to set a comfortable temperature.
2. Press  and  at the same time.
3. Press the arrows on the fan speed switch if you don't like the automatic setting.

To defrost the side windows quickly:

1. Press the arrows on the "TEMP SET" switch to set a comfortable temperature.
2. Press .
3. Press the arrows on the fan speed switch if you don't like the automatic setting.

System Problems

If the light above a button flashes when you turn on the ignition, your system may have an electrical problem. The flashing will continue for one minute, then stop.

The flashing light could also mean the refrigerant level is too low in your system. The light will continue to flash,

even if refrigerant is added, until the system is reset. Have your system checked and serviced if needed.

To reset your system:

1. Turn your ignition key to "Off" or "LOCK."
2. Remove the courtesy lights and radio fuses from the main fuse panel and wait one minute. See "Fuses and Circuit Breakers" in the Index.
3. Put the fuses back in and start your vehicle.

The light shouldn't come on and your system should be working properly. If you still have a problem, see your dealer.

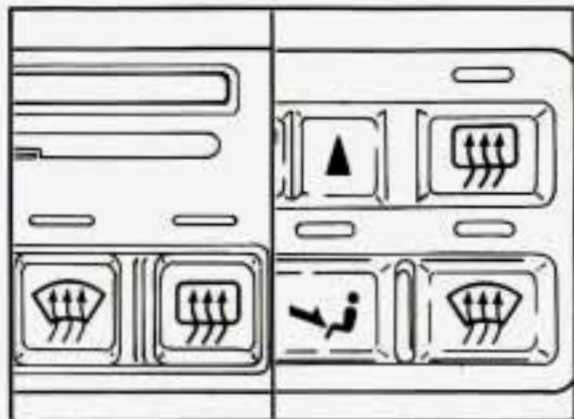

Rear Window Defogger

The rear window defogger uses a warming grid to remove fog from the rear window. The power mirrors are also warmed when the rear window defogger is on.

Press  to turn on the defogger. An indicator light will come on to remind you that the defogger is on. The defogger will turn off automatically after about ten minutes of use. You can also turn the defogger off by pressing the switch again or by turning off the ignition.

Do not attach anything like a temporary vehicle license or a decal across the defogger grid on the rear window.

NOTICE:

Don't use a razor blade or something else sharp on the inside of the rear window. If you do, you could cut or damage the warming grid, and the repairs wouldn't be covered by your warranty.

Specially Treated Windshield (ZR-1)

Your ZR-1 windshield is treated to reduce the amount of solar heat entering your vehicle. It makes it easier for your air conditioning system to keep you comfortable.

The windshield treatment reduces the effectiveness of some carry-on electrical equipment. There is an opening in the windshield treatment at the bottom center of the windshield.

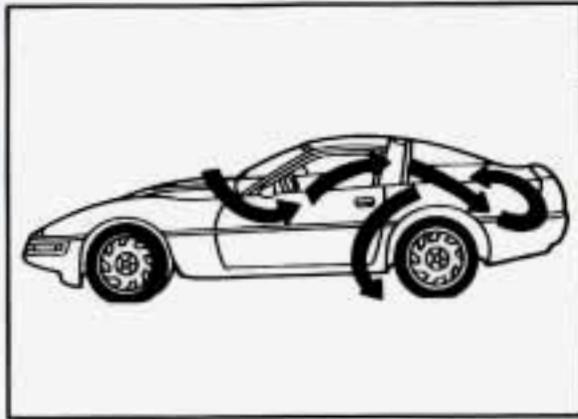

Flow-Through Ventilation System

Your Corvette's flow-through ventilation system supplies outside air into the vehicle when it is moving. Outside air will also enter the vehicle when the heater or the air conditioning fan is running.

Comfort Controls and Audio Systems

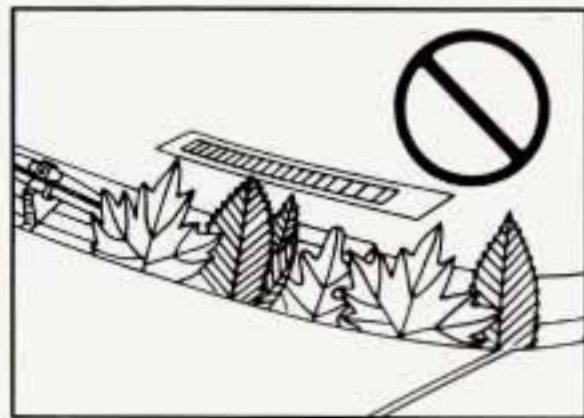

Ventilation Tips

- Keep the hood and front air inlet free of ice, snow, or any other obstruction (such as leaves). The heater and defroster will work far better, reducing the chance of fogging the inside of your windows.
- When you enter a vehicle in cold weather, adjust the fan to the highest speed for a few moments before driving off. This helps clear the intake ducts of snow and moisture, and reduces the chance of fogging the inside of your windows.
- Keep the air path under the front seats clear of objects. This helps air to circulate throughout your vehicle.

■ Audio Systems

Your Delco® audio system has been designed to operate easily and give years of listening pleasure. But you will get the most enjoyment out of it if you acquaint yourself with it first. Find out what your Delco® system can do and how to operate all its controls, to be sure you're getting the most out of the advanced engineering that went into it.

NOTICE:

Before you add any sound equipment to your vehicle — like a tape player, CB radio, mobile telephone or two-way radio — be sure you can add what you want. If you can, it's very important to do it properly. Added sound equipment may interfere with the operation of your vehicle's engine, Delco® radio or other systems, and even damage them. And, your vehicle's systems may interfere with the operation of sound equipment that has been added improperly.

So, before adding sound equipment, check with your dealer and be sure to check Federal rules covering mobile radio and telephone units.

Setting the Clock

1. Press "SET."
2. Within five seconds, press and hold "TUNE ▼" until the correct hour appears.
3. Press and hold "TUNE ▲" until the correct minute appears.

Noise Reduction

Your audio system has automatic Dolby® B Noise Reduction.

Dolby and the  are trademarks of Dolby Laboratories Licensing Corporation.

Noise reduction system manufactured under license from Dolby Laboratories Licensing Corporation.

AM/FM Stereo with Cassette Tape Player

To Play the Radio

Turn the upper knob to turn the system on or off.

Volume: Turn the upper knob to adjust the volume.

Recall: Press the upper knob to recall the station being played or the clock display.

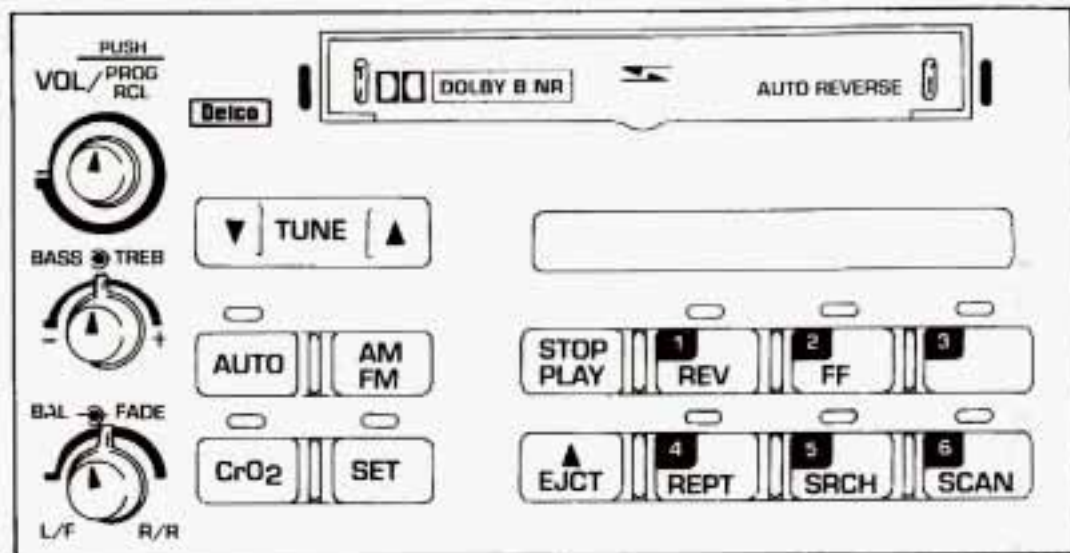

Finding a Station

Band: Press the "AM-FM" button to get AM or FM. The lighted display shows your selection.

Tune: Press "TUNE ▼ or ▲" to choose radio stations. For fast tuning, press and hold one side of the button, then press the other side.

Seek: Press "AUTO" then "TUNE ▼ or ▲" and the radio will tune to the next lower or higher station and stay there.

Pushbuttons: The six pushbuttons let you return to your favorite stations.

To set up to 12 stations (6 AM and 6 FM), just:

1. Tune in the station.
2. Press "SET."
3. Within five seconds, press one of the six pushbuttons. Whenever you press that button, the preset station will return.

Repeat these steps for each pushbutton.

Setting the Tone

Bass: Turn the "BASS" knob to the right to hear more bass.

Treble: Turn the "TREB" control behind the "BASS" knob to the right to hear more treble.

Comfort Controls and Audio Systems

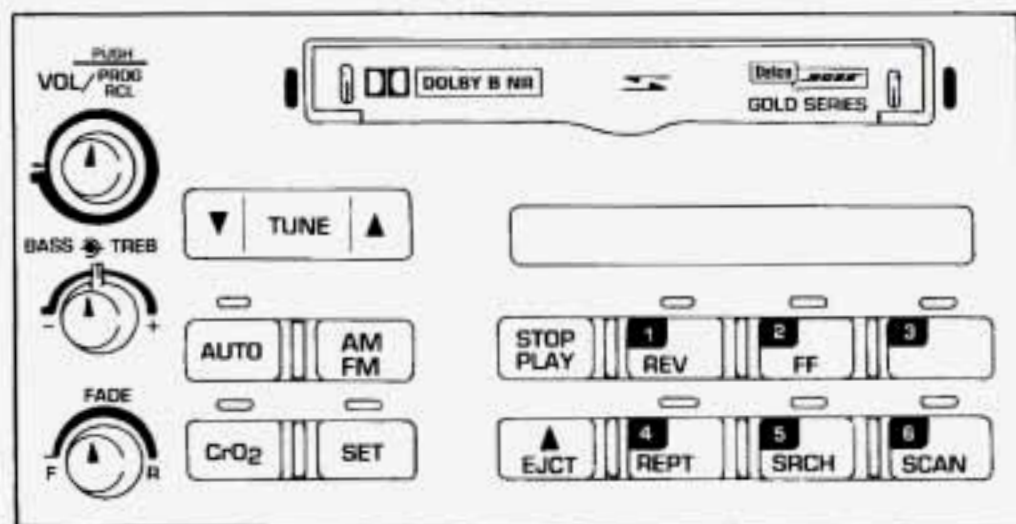

Adjusting the Speakers

Balance: Turn the "BAL" control behind the "FADE" knob to move the sound between the right and left speakers if you do not have the Delco/Bose system. With the Delco/Bose system, your speakers are electronically balanced.

Fade: Turn the "FADE" knob to move the sound between the front and rear speakers. Note that, with the Delco/Bose system, if you turn the knob all the way to "F" or "R," you may still get some sound from the opposite speakers.

To Play a Cassette Tape

Your tape player is built to work best with tapes that are 30 to 45 minutes long on each side. Tapes longer than that are so thin they may not work well in this player.

The longer side with the tape visible goes in first. If you hear nothing or hear just a garbled sound, it may not be in squarely. Press "EJCT" to remove the tape and start over.

Once the tape is playing, use the knobs for volume, fade and balance, just as you do for radio.

Reverse: Press "REV" to return to a favorite passage rapidly. Press it again to play the passage. The radio will play while the tape is rewinding.

Fast Forward: Press "FF" to advance the tape rapidly. Press it again to play. The radio will play while the tape is advancing.

Repeat: Press "REPT" to go to the beginning of the current selection after ten seconds or more of play. After five seconds or less of play, the player will return to the beginning of the previous selection.

Search: Press "SRCH" to go to the beginning of the next selection.

Scan: Press "SCAN" to listen to the first eight seconds of each passage. Press it again to stop scanning.

Program: Press the upper knob to change the side of the tape that is playing. The lighted arrows show which side is currently playing.

Eject: Press "EJCT" to remove the tape.

Stop: Press "STOP-PLAY" to listen to the radio without ejecting the cassette tape. Press it again to go back to the tape.

Metal Tapes: Press "CrO₂" when playing high bias chrome or metal tapes.

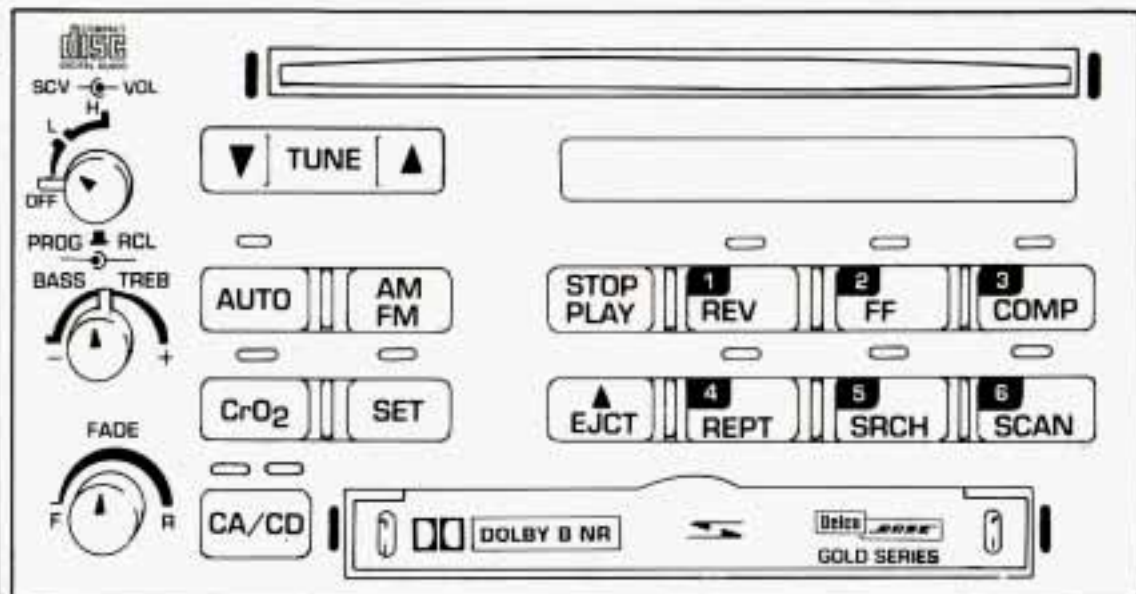

Delco/Bose AM/FM Stereo with Cassette Tape and Compact Disc Player

To Play the Radio

Turn the upper knob to turn the system on or off.

Volume: Turn the upper knob to adjust the volume. Your system also has a feature called speed-compensated volume (SCV). With SCV, your audio system makes up for road noise by getting louder as you drive faster. The control behind the upper knob has

three SCV positions. "H" has a higher maximum volume and gets louder faster than "L." Use "H" when you are driving with the roof panel off, the convertible top down or the windows open. If you don't want to use SCV, turn the control to "OFF."

Recall: Press the upper knob to recall the station being played or the clock display.

Finding a Station

Band: Press the "AM-FM" button to get AM or FM. The lighted display shows your selection.

Tune: Press "TUNE ▲ or ▼" to choose radio stations. For fast tuning, press and hold one side of the button, then press the other side.

Seek: Press "AUTO" then "TUNE ▼ or ▲" and the radio will tune to the next lower or higher station and stay there.

Pushbuttons: The six pushbuttons let you return to your favorite stations. To set up to 12 stations (6 AM and 6 FM), just:

1. Tune in the station.
2. Press "SET."
3. Within five seconds, press one of the six pushbuttons. Whenever you press that button, the preset station will return.

Setting the Tone

Bass: Turn the "BASS" knob to the right to hear more bass.

Treble: Turn the "TREB" control behind the "BASS" knob to the right to hear more treble.

Adjusting the Speakers

Balance: With the Delco/Bose system, your speakers are electronically balanced.

Comfort Controls and Audio Systems

Fade: Turn the "FADE" knob to move the sound between the front and rear speakers. Note that if you turn the knob all the way to "F" or "R," you may still get some sound from the opposite speakers.

To Play a Cassette Tape

Your tape player is built to work best with tapes that are 30 to 45 minutes long on each side. Tapes longer than that are so thin they may not work well in this player.

The longer side with the tape visible goes in first. If you hear nothing or hear just a garbled sound, it may not be in squarely. Press "EJECT" to remove the tape and start over.

Once the tape is playing, use the knobs for volume and fade, just as you do for radio. If both a tape and a compact disc are loaded into the system, press "CA/CD" to select the one you want.

Reverse: Press "REV" to return to a favorite passage rapidly. Press it again to play the passage. The radio will play while the tape is rewinding.

Fast Forward: Press "FF" to advance the tape rapidly. Press it again to play. The radio will play while the tape is advancing.

Repeat: Press "REPT" to go to the beginning of the current selection after ten seconds or more of play. After five seconds or less of play, the player will return to the beginning of the previous selection.

Search: Press "SRCH" to go to the beginning of the next selection.

Scan: Press "SCAN" to listen to the first eight seconds of each passage. Press it again to stop scanning.

Program: Press the upper knob to change the side of the tape that is playing. The lighted arrows show which side is currently playing.

Eject: Press "EJECT" to remove the tape.

Stop: Press "STOP-PLAY" to listen to the radio without ejecting the cassette tape. Press it again to go back to the tape.

Metal Tapes: Press "CrO₂" when playing high bias chrome or metal tapes.

To Play a Compact Disc

Don't use the mini-discs (3" singles). They will eject, but they won't play. Use only full-size compact discs.

With the audio system on, insert a disc into the slot with the label side up. "CD" will appear on the display and track 1 will begin to play. If both a tape and a compact disc are loaded into the system, press "CA/CD" to select the one you want.

If the disc comes back out and "ERR" appears on the display, it could be that:

- The disc is upside down.
- It is dirty, scratched, or wet.
- There's too much moisture in the air. (Wait about an hour and try again.)
- You are driving on a very rough road.
- The temperature is too hot or too cold.

Recall: Press "RCL" to see what track is playing. Press it again within five seconds to see how long it has been playing, the elapsed time ("EL TIME").

Reverse: Press and hold "REV" to return to a favorite passage rapidly. The decreasing elapsed time will show on the display.

Fast Forward: Press and hold "FF" to advance through passages. The increasing elapsed time will show on the display.

Repeat: Press "REPT" to go to the beginning of the current track after eight seconds or more of play. After eight seconds or less of play, the player will return to the beginning of the previous track.

Search: Press "SRCH" to go to the beginning of the next track.

Scan: Press "SCAN" to listen to the first eight seconds of each track. Press it again to stop scanning.

Compression: Press "COMP" to make loud and soft passages more nearly equal in volume. Press it again for normal play.

To Stop the Disc Player

- Turn the power off or turn the ignition key off. The disc stays in the player and will resume playing at the point where it stopped.
- Press "STOP-PLAY" to stop playing the disc and switch to radio. Press it again to restart the disc at the point where it stopped.
- Press "EJCT" to eject the disc and switch to radio. If the ignition or audio system is turned off, the player will pull the disc back in if you don't remove it from the opening within 30 seconds.

Understanding Radio Reception

FM Stereo

FM stereo will give you the best sound. But FM signals will reach only about 10 to 40 miles (16 to 65 km). And, tall buildings or hills can interfere with FM signals, causing the sound to come and go.

AM

The range for most AM stations is greater than for FM, especially at night. The longer range, however, can cause stations to interfere with each other. AM can pick up noise from things like storms and power lines. Try reducing the treble to reduce this noise if you ever get it.



Care of Your Cassette Tape Player

A tape player that is not cleaned regularly can cause reduced sound quality, ruined cassettes, or a damaged mechanism. Cassette tapes should be stored in their cases away from contaminants, direct sunlight, and extreme heat. If they aren't, they may not operate properly or cause failure of the tape player.

Your tape player should be cleaned regularly each month or after every 15 hours of use. If you notice a reduction in sound quality, try a known good cassette to see if the tape or the tape player is at fault. If this other cassette has no improvement in sound quality, clean the tape player.

Comfort Controls and Audio Systems

Clean your tape player with a wiping-action, non-abrasive cleaning cassette (GM Part No. 12344600), and follow the directions provided with it.

Cassettes are subject to wear and the sound quality may degrade over time. Always make sure that the cassette tape is in good condition before you have your tape player serviced.

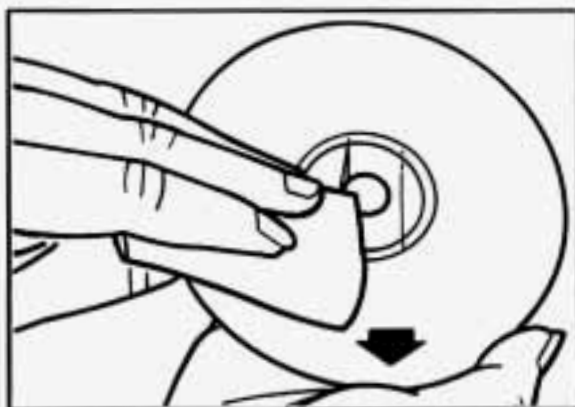

Care of Your Compact Discs

Handle discs carefully. Store them in their original cases or other protective cases and away from direct sunlight and dust. If the surface of a disc is soiled, dampen a clean, soft cloth in a mild, neutral detergent solution and clean it, wiping from the center to the edge.

Be sure never to touch the signal surface when handling discs. Pick up discs by grasping the outer edges or the edge of the hole and the outer edge.

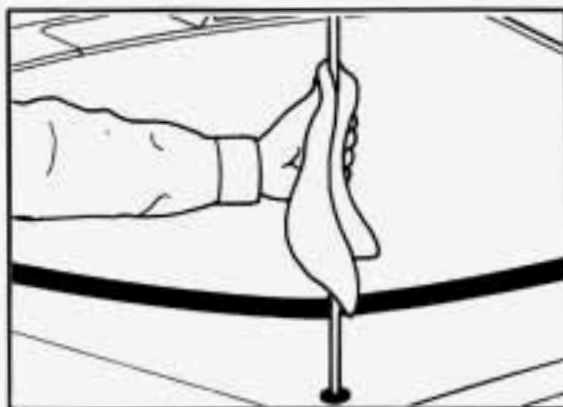

Power Antenna Mast Care

Your power antenna will look its best and work well if it's cleaned from time to time.

To clean the antenna mast:

1. Turn on the radio to raise the antenna.
2. Dampen a clean cloth with mineral spirits or an equivalent solvent.
3. Wipe the cloth over the mast, removing any dirt.
4. Wipe the mast dry with a clean cloth.
5. Turn the radio off and on to make the antenna go down and up.

If the antenna is still dirty, repeat the steps.

NOTICE:

Don't lubricate the power antenna. Lubrication could damage it.

NOTICE:

Before entering an automatic car wash, turn off your radio to make the power antenna go down. This will prevent the mast from possibly getting damaged. If the antenna does not go down when you turn the radio off, it may be damaged or need to be cleaned. In either case, lower the antenna by hand by carefully pressing the antenna down.

If the antenna mast is damaged, you can replace it. See your dealer for a replacement kit and follow the instructions in the kit. The antenna mast can be replaced without removing the entire antenna from the vehicle.



Here you'll find information about driving on different kinds of roads and in varying weather conditions. We've also included many other useful tips on driving.

Part 4 Your Driving and the Road

| | |
|-------------------------------|-----|
| Defensive Driving | 122 |
| Drunken Driving | 122 |
| Control of a Vehicle | 124 |
| Driving at Night | 131 |
| Driving in the Rain | 132 |
| City Driving | 134 |
| Freeway Driving | 134 |
| Hill and Mountain Roads | 136 |
| Winter Driving | 137 |
| Towing a Trailer | 139 |

Your Driving and the Road

■ *Defensive Driving*

The best advice anyone can give about driving is: Drive defensively.

Please start with a very important safety device in your Corvette: Buckle up. (See "Safety Belts" in the Index.)

Defensive driving really means "be ready for anything." On city streets, rural roads, or freeways, it means "always expect the unexpected."

Assume that pedestrians or other drivers are going to be careless and make mistakes. Anticipate what they might do. Be ready for their mistakes.

Rear-end collisions are about the most preventable of accidents. Yet they are common. Allow enough following distance. It's the best defensive driving maneuver, in both city and rural driving. You never know when the vehicle in front of you is going to brake or turn suddenly.

■ *Drunken Driving*

Death and injury associated with drinking and driving is a national tragedy. It's the number one contributor to the highway death toll, claiming thousands of victims every year. Alcohol takes away three

things that anyone needs to drive a vehicle:

- Judgment
- Muscular Coordination
- Vision

Police records show that half of all motor vehicle-related deaths involve alcohol – a driver, a passenger or someone else, such as a pedestrian, had been drinking. In most cases, these deaths are the result of someone who was drinking and driving. About 20,000 motor vehicle-related deaths occur each year because of alcohol, and thousands of people are injured.

Just how much alcohol is too much if a person plans to drive? Ideally, no one should drink alcohol and then drive. But if one does, then what's "too much"? It can be a lot less than many might think. Although it depends on each person and situation, here is some general information on the problem.

The Blood Alcohol Content (BAC) of someone who is drinking depends upon four things:

- How much alcohol is in the drink.
- The drinker's body weight.

- The amount of food that is consumed before and during drinking.
- The length of time it has taken the drinker to consume the alcohol.



According to the American Medical Association, a 180-pound (82 kg) person who drinks three 12-ounce (355 ml) bottles of beer in an hour will end up with a BAC of about 0.06 percent. The person would reach the same BAC by drinking three 4-ounce (120 ml) glasses of wine or three mixed drinks if each had 1-1/2 ounces (45 ml) of a liquor like whiskey, gin or vodka.

It's the amount of alcohol that counts. For example, if the same person drank three double martinis (3 ounces or 90 ml of liquor each) within an hour, the person's BAC would be close to 0.12 percent. A person who consumes food just before or during drinking will have a slightly lower BAC level.

DRINKING THAT WILL RESULT IN A BAC OF .05% IN THE TIME SHOWN

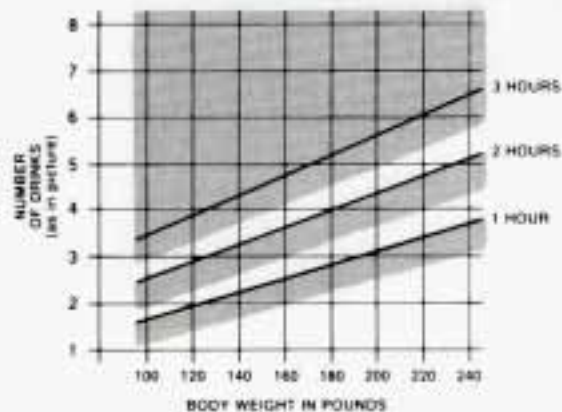

The law in most U.S. states sets the legal limit at a BAC of 0.10 percent. In Canada the limit is 0.08 percent, and in some other countries it's lower than that. The BAC will be over 0.10 percent after three to six drinks (in one hour). Of course, as we've seen, it depends on how much alcohol is in the drinks, and how quickly the person drinks them.

But it's very important to keep in mind that the ability to drive is affected well below a BAC of 0.10 percent. Research shows that the driving skills of many people are impaired at a BAC approaching 0.05 percent, and that the effects are worse at night. All drivers are impaired at BAC levels above 0.05 percent. Statistics show that the chance of being in an accident increases sharply for drivers who have a BAC of 0.05 percent or above. A driver with a BAC level of 0.06 percent (three beers in one hour for a 180-pound or 82 kg person) has doubled his or her chance of having an accident. At a BAC level of 0.10 percent, the chance of that driver having an accident is six times greater; at a level of 0.15 percent, the chances are twenty-five times greater! And, the body takes about an hour to rid itself of the alcohol in one drink. No amount of coffee or number of cold showers will speed that up.

"I'll be careful" isn't the right answer. What if there's an emergency, a need to take sudden action, as when a child darts into the street? A person with a higher BAC might not be able to react quickly enough to avoid the collision.

Your Driving and the Road

There's something else about drinking and driving that many people don't know. Medical research shows that alcohol in a person's system can make crash injuries worse. That's especially true for brain, spinal cord and heart injuries. That means that if anyone who has been drinking — driver or passenger — is in a crash, the chance of being killed or permanently disabled is higher than if that person had not been drinking. And we've already seen that the chance of a crash itself is higher for drinking drivers.



CAUTION:

Drinking and then driving is very dangerous. Your reflexes, perceptions, and judgment will be affected by even a small amount of alcohol. You could have a serious — or even fatal — accident if you drive after drinking. Please don't drink and drive or ride with a driver who has been drinking. Ride home in a cab; or if you're with a group, designate a driver who will not drink.

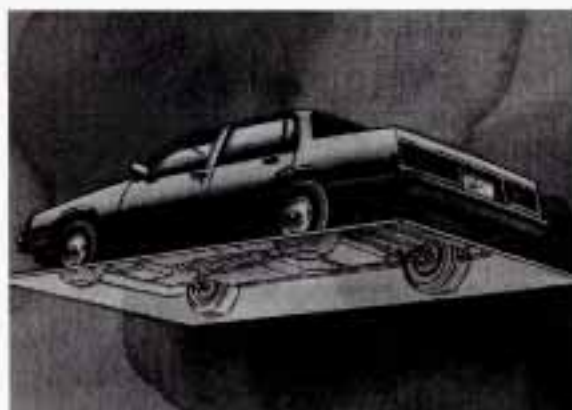

■ *Control of a Vehicle*

You have three systems that make your vehicle go where you want it to go. They are the brakes, the steering and the accelerator. All three systems have to do their work at the places where the tires meet the road.

Sometimes, as when you're driving on snow or ice, it's easy to ask more of those control systems than the tires and road can provide. That means you can lose control of your vehicle.

Braking

Braking action involves perception time and reaction time.

First, you have to decide to push on the brake pedal. That's perception time. Then you have to bring up your foot and do it. That's reaction time.

Average reaction time is about 3/4 of a second. But that's only an average. It might be less with one driver and as long as two or three seconds or more with another. Age, physical condition, alertness, coordination, and eyesight all play a part. So do alcohol, drugs and frustration. But even in 3/4 of a second, a vehicle moving at 60 mph (100 km/h) travels 66 feet (20 m). That could be a lot of distance in an emergency, so keeping enough space between your vehicle and others is important.

And, of course, actual stopping distances vary greatly with the surface of the road (whether it's pavement or gravel); the condition of the road (wet, dry, icy); tire tread; and the condition of your brakes.

Avoid needless heavy braking. Some people drive in spurts — heavy acceleration followed by heavy braking — rather than keeping pace with traffic.

This is a mistake. Your brakes may not have time to cool between hard stops. Your brakes will wear out much faster if you do a lot of heavy braking. If you keep pace with the traffic and allow realistic following distances, you will eliminate a lot of unnecessary braking. That means better braking and longer brake life.

If your engine ever stops while you're driving, brake normally but don't pump your brakes. If you do, the pedal may get harder to push down. If your engine stops, you will still have some power brake assist. But you will use it when you brake. Once the power assist is used up, it may take longer to stop and the brake pedal will be harder to push.

SERVICE



Anti-Lock Brakes (ABS)

Your Corvette has an advanced electronic braking system that will help prevent skidding.

This light on the instrument panel will go on when you start your vehicle.

When you start your vehicle and begin to drive away, you may hear a momentary motor or clicking noise. And you may even notice that your brake pedal moves a little while this is going on. This is the ABS system testing itself. If there's a problem with the anti-lock brake system, the anti-lock brake system warning light will stay on.

See "Anti-lock Brake System Warning Light" in the Index.



Here's how anti-lock works. Let's say the road is wet. You're driving safely. Suddenly an animal jumps out in front of you.

You slam on the brakes. Here's what happens with ABS.

A computer senses that wheels are slowing down. If one of the wheels is about to stop rolling, the computer will separately work the brakes at each front wheel and at the rear wheels.

The anti-lock system can change the brake pressure faster than any driver could. The computer is programmed to make the most of available tire and road conditions.

Your Driving and the Road



You can steer around the obstacle while braking hard.

As you brake, your computer keeps receiving updates on wheel speed and controls braking pressure accordingly.

Remember: Anti-lock doesn't change the time you need to get your foot up to the brake pedal. If you get too close to the vehicle in front of you, you won't have time to apply your brakes if that vehicle suddenly slows or stops. Always leave enough room up ahead to stop, even though you have anti-lock brakes.

To Use Anti-Lock

Don't pump the brakes. Just hold the brake pedal down and let anti-lock work for you. You may hear a motor or clicking

noise and feel the brake pedal move a little during a hard stop, but this is normal. When your anti-lock system is adjusting brake pressure to help avoid a braking skid, the "ABS ACTIVE" light will come on. See "Anti-Lock Brake System Active Light" in the Index.

ASR (Accelerated Slip Regulation) System

Your vehicle has an ASR system that limits wheel spin. This is especially useful in slippery road conditions. The system operates only if it senses that the rear wheels are spinning too much or are beginning to lose traction. When this happens, the system works the rear brakes and reduces engine power (by closing the throttle and managing spark) to limit wheel spin.

The "ASR ACTIVE" light will come on when the ASR system is limiting wheel spin. See "ASR Active Light" in the Index. You may feel the system working, or you may notice some noise, but this is normal.

If your vehicle is in cruise control when the ASR system begins to limit wheel spin, the cruise control will automatically

disengage. When road conditions allow you to safely use it again, you may re-engage cruise control. (See "Cruise Control" in the Index.)



The "SERVICE ASR" warning light will come on to let you know if there's a problem with the ASR system. See "ASR System Warning Light" in the Index. When this warning light is on, the system will not limit wheel spin. Adjust your driving accordingly.

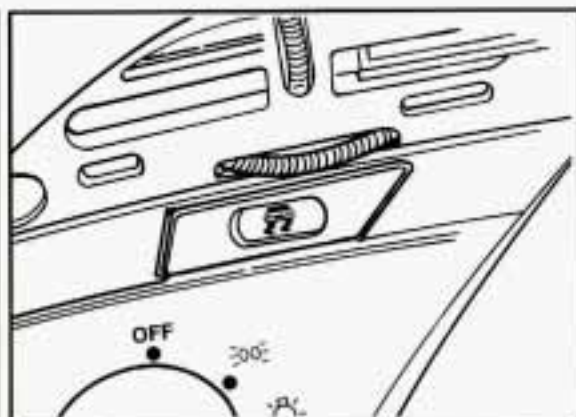

The ASR system automatically comes on whenever you start your vehicle. To limit wheel spin, especially in slippery road conditions, you should always leave the system on. But you can turn the ASR system off if you ever need to. (You should turn the system off if your vehicle ever gets stuck in sand, mud, ice or snow. See "Rocking Your Vehicle" in the Index.)

To turn the system off, press the button located above the headlight switch. The "ASR OFF" light will come on and stay on. If the ASR system is limiting wheel spin when you press the button, the system won't turn off right away. It will wait until there's no longer a current need to limit wheel spin.

You can turn the system back on at any time by pressing the button again. The "ASR OFF" light should go off.

Braking in Emergencies

Use your anti-lock braking system when you need to. With anti-lock, you can steer and brake at the same time. In many emergencies, steering can help you more than even the very best braking.

Steering

Power Steering

If you lose power steering assist because the engine stops or the system is not functioning, you can steer but it will take much more effort.

Steering Tips

Driving on Curves

It's important to take curves at a reasonable speed.

A lot of the "driver lost control" accidents mentioned on the news happen on curves. Here's why:

Experienced driver or beginner, each of us is subject to the same laws of physics when driving on curves. The traction of

Your Driving and the Road

the tires against the road surface makes it possible for the vehicle to change its path when you turn the front wheels. If there's no traction, inertia will keep the vehicle going in the same direction. If you've ever tried to steer a vehicle on wet ice, you'll understand this.

The traction you can get in a curve depends on the condition of your tires and the road surface, the angle at which the curve is banked, and your speed. While you're in a curve, speed is the one factor you can control.

Suppose you're steering through a sharp curve. Then you suddenly accelerate. Both control systems — steering and acceleration — have to do their work where the tires meet the road. Unless your ASR system is on, adding the sudden acceleration can demand too much of those places. You can lose control.

What should you do if this ever happens? Ease up on the accelerator pedal, steer the vehicle the way you want it to go, and slow down.

Speed limit signs near curves warn that you should adjust your speed. Of course, the posted speeds are based on good weather and road conditions. Under less

favorable conditions you'll want to go slower.

If you need to reduce your speed as you approach a curve, do it before you enter the curve, while your front wheels are straight ahead.

Try to adjust your speed so you can "drive" through the curve. Maintain a reasonable, steady speed. Wait to accelerate until you are out of the curve, and then accelerate gently into the straightaway.

Steering in Emergencies

There are times when steering can be more effective than braking. For example, you come over a hill and find a truck stopped in your lane, or a car suddenly pulls out from nowhere, or a child darts out from between parked cars and stops right in front of you. You can avoid these problems by braking — if you can stop in time. But sometimes you can't; there isn't room. That's the time for evasive action — steering around the problem.

Your Corvette can perform very well in emergencies like these. First apply your brakes. It is better to remove as much speed as you can from a possible collision. Then steer around the problem, to the left or right depending on the space available.



An emergency like this requires close attention and a quick decision. If you are holding the steering wheel at the recommended 9 and 3 o'clock positions, you can turn it a full 180 degrees very quickly without removing either hand. But you have to act fast, steer quickly, and just as quickly straighten the wheel once you have avoided the object.

The fact that such emergency situations are always possible is a good reason to practice defensive driving at all times and wear safety belts properly.

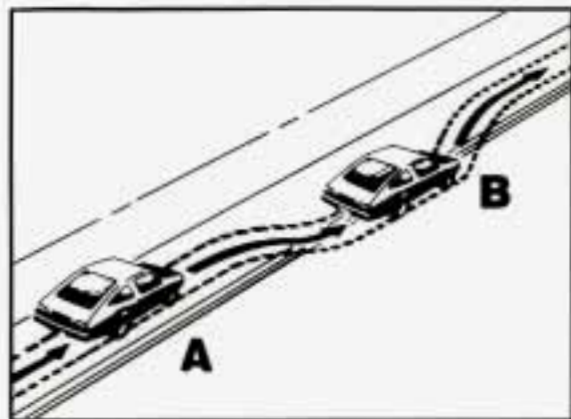

Off-Road Recovery

You may find sometime that your right wheels have dropped off the edge of a road onto the shoulder (A) while you're driving.

If the level of the shoulder is only slightly below the pavement, recovery should be fairly easy. Ease off the accelerator and then, if there is nothing in the way, steer so that your vehicle straddles the edge of the pavement. You can turn the steering wheel up to 1/4 turn (B) until the right front tire contacts the pavement edge. Then turn your steering wheel to go straight down the roadway.

Passing

The driver of a vehicle about to pass another on a two-lane highway waits for just the right moment, accelerates, moves around the vehicle ahead, then goes back into the right lane again. A simple maneuver?

Not necessarily! Passing another vehicle on a two-lane highway is a potentially dangerous move, since the passing vehicle occupies the same lane as oncoming traffic for several seconds. A miscalculation, an error in judgment, or a brief surrender to frustration or anger can suddenly put the passing driver face to face with the worst of all traffic accidents — the head-on collision.

So here are some tips for passing:

- "Drive ahead." Look down the road, to the sides, and to crossroads for situations that might affect your passing patterns. If you have any doubt whatsoever about making a successful pass, wait for a better time.
- Watch for traffic signs, pavement markings, and lines. If you can see a sign up ahead that might indicate a turn or an intersection, delay your pass. A broken center line usually

indicates it's all right to pass (providing the road ahead is clear). Never cross a solid line on your side of the lane or a double solid line, even if the road seems empty of approaching traffic.

- Do not get too close to the vehicle you want to pass while you're awaiting an opportunity. For one thing, following too closely reduces your area of vision, especially if you're following a larger vehicle. Also, you won't have adequate space if the vehicle ahead suddenly slows or stops. Keep back a reasonable distance.
- When it looks like a chance to pass is coming up, start to accelerate but stay in the right lane and don't get too close. Time your move so you will be increasing speed as the time comes to move into the other lane. If the way is clear to pass, you will have a "running start" that more than makes up for the distance you would lose by dropping back. And if something happens to cause you to cancel your pass, you need only slow down and drop back again and wait for another opportunity.

Your Driving and the Road

- If other cars are lined up to pass a slow vehicle, wait your turn. But take care that someone isn't trying to pass you as you pull out to pass the slow vehicle. Remember to glance over your shoulder and check the blind spot.
- Check your mirrors, glance over your shoulder, and start your left lane change signal before moving out of the right lane to pass. When you are far enough ahead of the passed vehicle to see its front in your inside mirror, activate your right lane change signal and move back into the right lane. (Remember that your right outside mirror is convex. The vehicle you just passed may seem to be farther away from you than it really is.)
- Try not to pass more than one vehicle at a time on two-lane roads. Reconsider before passing the next vehicle.
- Don't overtake a slowly moving vehicle too rapidly. Even though the brake lights are not flashing, it may be slowing down or starting to turn.
- If you're being passed, make it easy for the following driver to get ahead of you. Perhaps you can ease a little to the right.

Loss of Control

Let's review what driving experts say about what happens when the three control systems (brakes, steering and acceleration) don't have enough friction where the tires meet the road to do what the driver has asked.

In any emergency, don't give up. Keep trying to steer and constantly seek an escape route or area of less danger.

Skidding

In a skid, a driver can lose control of the vehicle. Defensive drivers avoid most skids by taking reasonable care suited to existing conditions, and by not "overdriving" those conditions. But skids are always possible.

The three types of skids correspond to your Corvette's three control systems. In the braking skid your wheels aren't rolling. In the steering or cornering skid, too much speed or steering in a curve causes tires to slip and lose cornering force. And in the acceleration skid too much throttle causes the driving wheels to spin.

A cornering skid is best handled by easing your foot off the accelerator pedal.

Remember: Any ASR system helps avoid only the acceleration skid. If your ASR system is off, then an acceleration skid is also best handled by easing your foot off the accelerator pedal.

If your vehicle starts to slide, ease your foot off the accelerator pedal and quickly steer the way you want the vehicle to go. If you start steering quickly enough, your vehicle may straighten out. Always be ready for a second skid if it occurs.

Of course, traction is reduced when water, snow, ice, gravel, or other material is on the road. For safety, you'll want to slow down and adjust your driving to these conditions. It is important to slow down on slippery surfaces because stopping distance will be longer and vehicle control more limited.

While driving on a surface with reduced traction, try your best to avoid sudden steering, acceleration, or braking (including engine braking by shifting to a lower gear). Any sudden changes could cause the tires to slide. You may not realize the surface is slippery until your vehicle is skidding. Learn to recognize warning clues — such as enough water, ice or packed snow on the road to make a “mirrored surface” — and slow down when you have any doubt.

Remember: Any anti-lock braking system (ABS) helps avoid only the braking skid.



■ *Driving at Night*

Night driving is more dangerous than day driving. One reason is that some drivers are likely to be impaired — by alcohol or drugs, with night vision problems, or by fatigue.

Here are some tips on night driving.

- Drive defensively.
- Don't drink and drive.
- Adjust your inside rearview mirror to reduce the glare from headlights behind you.
- Since you can't see as well, you may need to slow down and keep more space between you and other vehicles.

- Slow down, especially on higher speed roads. Your headlights can light up only so much road ahead.
- In remote areas, watch for animals.
- If you're tired, pull off the road in a safe place and rest.

Night Vision

No one can see as well at night as in the daytime. But as we get older these differences increase. A 50-year-old driver may require at least twice as much light to see the same thing at night as a 20-year-old.

What you do in the daytime can also affect your night vision. For example, if you spend the day in bright sunshine you are wise to wear sunglasses. Your eyes will have less trouble adjusting to night. But if you're driving, don't wear sunglasses at night. They may cut down on glare from headlights, but they also make a lot of things invisible.

You can be temporarily blinded by approaching lights. It can take a second or two, or even several seconds, for your eyes to readjust to the dark. When you are faced with severe glare (as from a driver who doesn't lower the high beams, or a

Your Driving and the Road

vehicle with misaimed headlights), slow down a little. Avoid staring directly into the approaching lights.

Keep your windshield and all the glass on your vehicle clean — inside and out. Glare at night is made much worse by dirt on the glass. Even the inside of the glass can build up a film caused by dust. Dirty glass makes lights dazzle and flash more than clean glass would, making the pupils of your eyes contract repeatedly.

Remember that your headlights light up far less of a roadway when you are in a turn or curve. Keep your eyes moving; that way, it's easier to pick out dimly lighted objects. Just as your headlights should be checked regularly for proper aim, so should your eyes be examined regularly. Some drivers suffer from night blindness — the inability to see in dim light — and aren't even aware of it.



■ *Driving in the Rain*

Rain and wet roads can mean driving trouble. On a wet road you can't stop, accelerate or turn as well because your tire-to-road traction isn't as good as on dry roads. And, if your tires don't have much tread left, you'll get even less traction. It's always wise to go slower and be cautious if rain starts to fall while you are driving. The surface may get wet suddenly when your reflexes are tuned for driving on dry pavement.

The heavier the rain, the harder it is to see. Even if your windshield wiper blades are in good shape, a heavy rain can make it harder to see road signs and traffic signals, pavement markings, the edge of the road, and even people walking.

It's wise to keep your wiping equipment in good shape and keep your windshield washer tank filled. Replace your windshield wiper inserts when they show signs of streaking or missing areas on the windshield, or when strips of rubber start to separate from the inserts.



Driving too fast through large water puddles or even going through some car washes can cause problems, too. The water may affect your brakes. Try to avoid puddles. But if you can't, try to slow down before you hit them.



CAUTION:

Wet brakes can cause accidents. They won't work well in a quick stop and may cause pulling to one side. You could lose control of the vehicle.

After driving through a large puddle of water or a car wash, apply your brake pedal lightly until your brakes work normally.

Hydroplaning

Hydroplaning is dangerous. So much water can build up under your tires that they can actually ride on the water. This can happen if the road is wet enough and you're going fast enough. When your vehicle is hydroplaning, it has little or no contact with the road.

Hydroplaning doesn't happen often. But it can if your tires haven't much tread or if the pressure in one or more is low. It can happen if a lot of water is standing on the road. If you can see reflections from trees, telephone poles, or other vehicles, and raindrops "dimple" the water's surface, there could be hydroplaning.

Hydroplaning usually happens at higher speeds. There just isn't a hard and fast rule about hydroplaning. The best advice is to slow down when it is raining.

Some Other Rainy Weather Tips

- Turn on your low-beam headlights — not just your parking lights — to help make you more visible to others.
- Besides slowing down, allow some extra following distance. And be especially careful when you pass another vehicle. Allow yourself more clear room ahead, and be prepared to have your view restricted by road spray.
- Have good tires with proper tread depth. (See "Tires" in the Index.)

Your Driving and the Road



■ *City Driving*

One of the biggest problems with city streets is the amount of traffic on them. You'll want to watch out for what the other drivers are doing and pay attention to traffic signals.

Here are ways to increase your safety in city driving:

- Know the best way to get to where you are going. Get a city map and plan your trip into an unknown part of the city just as you would for a cross-country trip.
- Try to use the freeways that rim and crisscross most large cities. You'll save time and energy. (See the next section, "Freeway Driving.")

- Treat a green light as a warning signal. A traffic light is there because the corner is busy enough to need it. When a light turns green, and just before you start to move, check both ways for vehicles that have not cleared the intersection or may be running the red light.

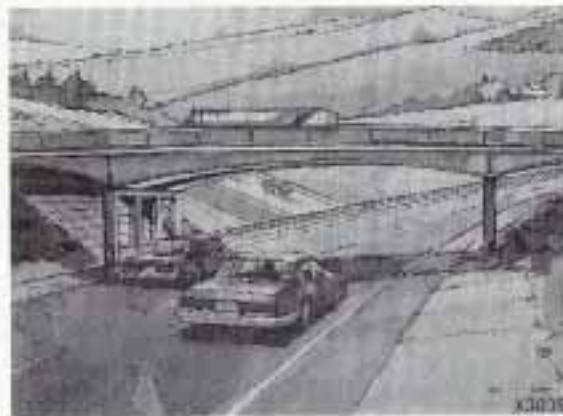

■ *Freeway Driving*

Mile for mile, freeways (also called thruways, parkways, expressways, turnpikes, or superhighways) are the safest of all roads. But they have their own special rules.

The most important advice on freeway driving is: Keep up with traffic and keep to the right. Drive at the same speed most of the other drivers are driving. Too-fast or too-slow driving breaks a smooth traffic flow. Treat the left lane on a freeway as a passing lane.

At the entrance there is usually a ramp that leads to the freeway. If you have a clear view of the freeway as you drive along the entrance ramp, you should

begin to check traffic. Try to determine where you expect to blend with the flow. Try to merge into the gap at close to the prevailing speed. Switch on your turn signal, check your mirrors and glance over your shoulder as often as necessary. Try to blend smoothly with the traffic flow.

Once you are on the freeway, adjust your speed to the posted limit or to the prevailing rate if it's slower. Stay in the right lane unless you want to pass.

Before changing lanes, check your mirrors. Then use your turn signal. Just before you leave the lane, glance quickly over your shoulder to make sure there isn't another vehicle in your "blind" spot.

Once you are moving on the freeway, make certain you allow a reasonable following distance. Expect to move slightly slower at night.

When you want to leave the freeway, move to the proper lane well in advance. If you miss your exit do not, under any circumstances, stop and back up. Drive on to the next exit.

The exit ramp can be curved, sometimes quite sharply. The exit speed is usually posted. Reduce your speed according to

your speedometer, not to your sense of motion. After driving for any distance at higher speeds, you may tend to think you are going slower than you actually are.

Before Leaving on a Long Trip

Make sure you're ready. Try to be well rested. If you must start when you're not fresh — such as after a day's work — don't plan to make too many miles that first part of the journey. Wear comfortable clothing and shoes you can easily drive in.

Is your vehicle ready for a long trip? If you keep it serviced and maintained, it's ready to go. If it needs service, have it done before starting out. Of course, you'll find experienced and able service experts in Chevrolet dealerships all across North America. They'll be ready and willing to help if you need it.

Here are some things you can check before a trip:

- **Windshield Washer Fluid:** Is the reservoir full? Are all windows clean inside and outside?
- **Wiper Blades:** Are they in good shape?

- **Fuel, Engine Oil, Other Fluids:** Have you checked all levels?
- **Lights:** Are they all working? Are the lenses clean?
- **Tires:** They are vitally important to a safe, trouble-free trip. Is the tread good enough for long-distance driving? Are the tires all inflated to the recommended pressure?
- **Weather Forecasts:** What's the weather outlook along your route? Should you delay your trip a short time to avoid a major storm system?
- **Maps:** Do you have up-to-date maps?

Highway Hypnosis

Is there actually such a condition as "highway hypnosis"? Or is it just plain falling asleep at the wheel? Call it highway hypnosis, lack of awareness, or whatever.

There is something about an easy stretch of road with the same scenery, along with the hum of the tires on the road, the drone of the engine, and the rush of the wind against the vehicle that can make you sleepy. Don't let it happen to you! If it does, your vehicle can leave the road in less than a second, and you could crash and be injured.

Your Driving and the Road

What can you do about highway hypnosis? First, be aware that it can happen.

Then here are some tips:

- Make sure your vehicle is well ventilated, with a comfortably cool interior.
- Keep your eyes moving. Scan the road ahead and to the sides. Check your rearview mirrors and your instruments frequently.
- If you get sleepy, pull off the road into a rest, service, or parking area and take a nap, get some exercise, or both. For safety, treat drowsiness on the highway as an emergency.



■ *Hill and Mountain Roads*

Driving on steep hills or mountains is different from driving in flat or rolling terrain. If you drive regularly in steep country, or if you're planning to visit there, here are some tips that can make your trips safer and more enjoyable.

- Keep your vehicle in good shape. Check all fluid levels and also the brakes, tires, cooling system and transmission. These parts can work hard on mountain roads.
- Know how to go down hills. The most important thing to know is this: let your engine do some of the slowing down. Shift to a lower gear when you go down a steep or long hill.



CAUTION:

If you don't shift down, your brakes could get so hot that they wouldn't work well. You would then have poor braking or even none going down a hill. You could crash. Shift down to let your engine assist your brakes on a steep downhill slope.



CAUTION:

Coasting downhill in "N" (Neutral) or with the ignition off is dangerous. Your brakes will have to do all the work of slowing down. They could get so hot that they wouldn't work well. You could crash. Always have your engine running and your vehicle in gear when you go downhill.

- Know how to go uphill. You may want to shift down to a lower gear. The lower gears help cool your engine and transmission, and you can climb the hill better.

- Stay in your own lane when driving on two-lane roads in hills or mountains. Don't swing wide or cut across the center of the road. Drive at speeds that let you stay in your own lane.
- As you go over the top of a hill, be alert. There could be something in your lane, like a stalled car or an accident.
- You may see highway signs on mountains that warn of special problems. Examples are long grades, passing or no-passing zones, a falling rocks area, or winding roads. Be alert to these and take appropriate action.



■ *Winter Driving*

Here are some tips for winter driving:

- Have your Corvette in good shape for winter. Be sure your engine coolant mix is correct.
- You may want to put winter emergency supplies in your vehicle.



Include an ice scraper, a small brush or broom, a supply of windshield washer fluid, a rag, some winter outer clothing, a small shovel, a flashlight, a red cloth, and a couple of reflective warning triangles. And, if you will be driving under severe conditions, include a small bag of sand, a piece of old carpet or a couple of burlap bags to help provide traction. Be sure you properly secure these items in your vehicle.

Your Driving and the Road



Driving on Snow or Ice

Most of the time, those places where your tires meet the road probably have good traction.

However, if there is snow or ice between your tires and the road, you can have a very slippery situation. You'll have a lot less traction or "grip" and will need to be very careful.

What's the worst time for this? "Wet ice." Very cold snow or ice can be slick and hard to drive on. But wet ice can be even more trouble because it may offer the least traction of all. You can get "wet ice" when it's about freezing (32°F; 0°C) and freezing rain begins to fall. Try to avoid driving on wet ice until salt and sand crews can get there.

Whatever the condition — smooth ice, packed, blowing or loose snow — drive with caution. Keep your ASR system on. It improves your ability to accelerate when driving on a slippery road. Even though your vehicle has the ASR system, you'll want to slow down and adjust your driving to the road conditions. See "ASR System" in the Index.

Your anti-lock brakes improve your ability to make a hard stop on a slippery road. Even though you have the anti-lock braking system, you'll want to begin stopping sooner than you would on dry pavement. See "Anti-lock" in the Index.

- Allow greater following distance on any slippery road.
- Watch for slippery spots. The road might be fine until you hit a spot that's covered with ice. On an otherwise clear road, ice patches may appear in shaded areas where the sun can't reach: around clumps of trees, behind buildings, or under bridges. Sometimes the surface of a curve or an overpass may remain icy when the surrounding roads are clear. If you see a patch of ice ahead of you, brake before you are on it. Try not to brake while you're actually on the ice, and avoid sudden steering maneuvers.



If You're Caught in a Blizzard

If you are stopped by heavy snow, you could be in a serious situation. You should probably stay with your vehicle unless you know for sure that you are near help and you can hike through the snow. Here are some things to do to summon help and keep yourself and your passengers safe: Turn on your hazard flashers. Tie a red cloth to your vehicle to alert police that you've been stopped by the snow. Put on extra clothing or wrap a blanket around you. If you have no blankets or extra clothing, make body insulators from newspapers, burlap bags, rags, floor mats — anything you can wrap around yourself or tuck under your clothing to keep warm. You can run the engine to keep warm, but be careful.



CAUTION:

Snow can trap exhaust gases under your vehicle. This can cause deadly CO (carbon monoxide) gas to get inside. CO could overcome you and kill you. You can't see it or smell it, so you might not know it is in your vehicle. Clear away snow from around the base of your vehicle, especially any that is blocking your exhaust pipe. And check around again from time to time to be sure snow doesn't collect there.

Open a window just a little on the side of the vehicle that's away from the wind. This will help keep CO out.

Run your engine only as long as you must. This saves fuel. When you run the engine, make it go a little faster than just idle. That is, push the accelerator slightly. This uses less fuel for the heat that you get and it keeps the battery charged. You will need a well-charged battery to restart the vehicle, and possibly for signaling later on with your headlights. Let the heater run for awhile.

Then, shut the engine off and close the window almost all the way to preserve the heat. Start the engine again and repeat this only when you feel really uncomfortable from the cold. But do it as little as possible. Preserve the fuel as long as you can. To help keep warm, you can get out of the vehicle and do some fairly vigorous exercises every half hour or so until help comes.

■ *Towing a Trailer*

Your Corvette is neither designed nor intended to tow a trailer.

Notes



Here you'll find what to do about some problems that can occur on the road.

Part **5** Problems on the Road

| | |
|--|-----|
| Hazard Warning Flashers | 142 |
| Jump Starting | 143 |
| Towing Your Vehicle | 146 |
| Engine Overheating | 150 |
| If a Tire Goes Flat | 159 |
| If You're Stuck: In Sand, Mud, Ice or Snow | 169 |

Problems on the Road



■ *Hazard Warning Flashers*

Your hazard warning flashers let you warn others. They also let police know you have a problem. Your front and rear turn signal lights will flash on and off.

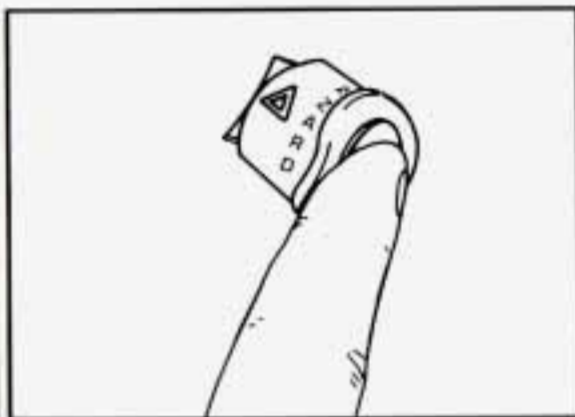

Press the button in to make your front and rear turn signal lights flash on and off.

Your hazard warning flashers work no matter what position your key is in, and even if the key isn't in.

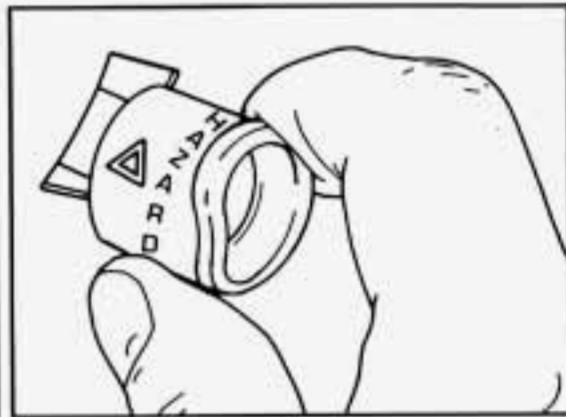

To turn off the flashers, pull out on the collar.

When the hazard warning flashers are on, your turn signals won't work.

Other Warning Devices

If you carry reflective triangles, you can set one up at the side of the road about 300 feet (100 m) behind your vehicle.

■ *Jump Starting*

If your battery has run down, you may want to use another vehicle and some jumper cables to start your Corvette. But please follow the steps below to do it safely.



CAUTION:

Batteries can hurt you. They can be dangerous because:

- They contain acid that can burn you.
- They contain gas that can explode or ignite.
- They contain enough electricity to burn you.

If you don't follow these steps exactly, some or all of these things can hurt you.

NOTICE:

Ignoring these steps could result in costly damage to your vehicle that wouldn't be covered by your warranty.

Trying to start your Corvette by pushing or pulling it could damage your vehicle, even if you have a manual transmission. And if you have an automatic transmission, it won't start that way.

To Jump Start Your Corvette:

1. Check the other vehicle. It must have a 12-volt battery with a negative ground system.

NOTICE:

If the other system isn't a 12-volt system with a negative ground, both vehicles can be damaged.

2. Get the vehicles close enough so the jumper cables can reach, but be sure the vehicles aren't touching each other. If they are, it could cause a

ground connection you don't want. You wouldn't be able to start your Corvette, and the bad grounding could damage the electrical systems.

3. Turn off the ignition on both vehicles. Turn off all lights that aren't needed, and radios. This will avoid sparks and help save both batteries. And it could save your radio!

NOTICE:

If you leave your radio on, it could be badly damaged. The repairs wouldn't be covered by your warranty.

4. Open the hoods and locate the batteries. Find the positive (+) and negative (-) terminals on each.



CAUTION:

An electric fan can start up even when the engine is not running and can injure you. Keep hands, clothing and tools away from any underhood electric fan.

Problems on the Road



CAUTION:

Using a match near a battery can cause battery gas to explode. People have been hurt doing this, and some have been blinded. Use a flashlight if you need more light.

Be sure the battery has enough water. You don't need to add water to the Delco Freedom[®] battery installed in every new GM vehicle. But if a battery has filler caps, be sure the right amount of fluid is there. If it is low, add water to take care of that first. If you don't, explosive gas could be present.

Battery fluid contains acid that can burn you. Don't get it on you. If you accidentally get it in your eyes or on your skin, flush the place with water and get medical help immediately.

5. Check that the jumper cables don't have loose or missing insulation. If they do, you could get a shock. The vehicles could be damaged, too.



CAUTION:

Fans or other moving engine parts can injure you badly. Keep your hands away from moving parts once the engines are running.

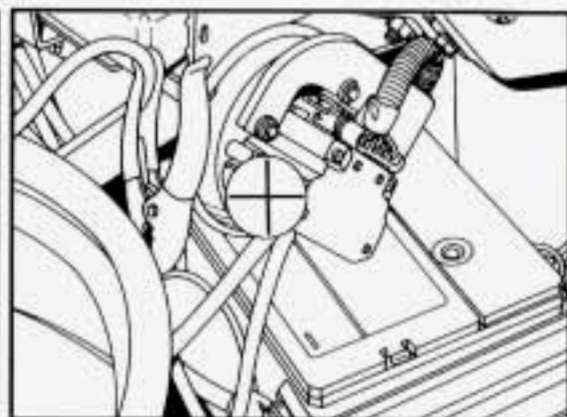

6. Positive (+) goes to positive (+) and negative (-) goes to negative (-) or a metal engine part. Connect the red positive (+) cable to the positive (+) terminal of the vehicle with the dead battery. Use a remote positive (+) terminal if the vehicle has one.

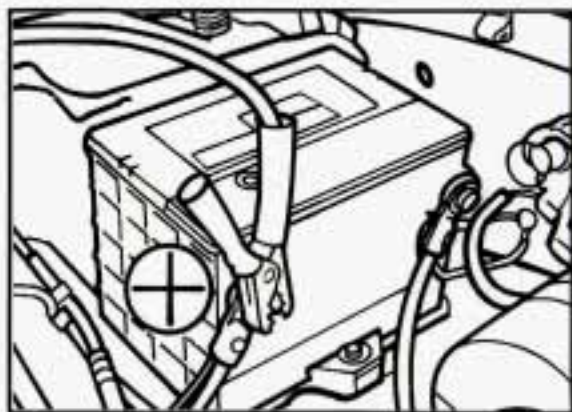

7. Don't let the other end touch metal. Connect it to the positive (+) terminal of the good battery. Use a remote positive (+) terminal if the vehicle has one.

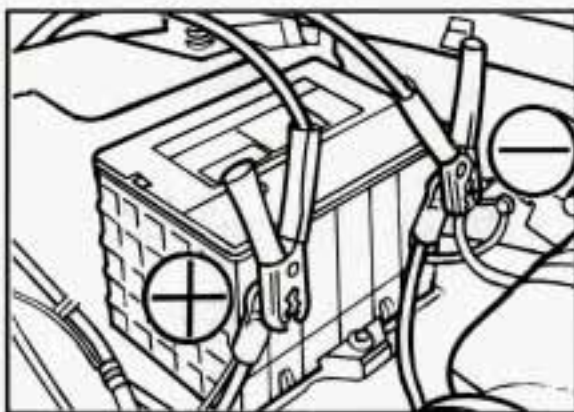

8. Now connect the black negative (-) cable to the good battery's negative (-) terminal. Don't let the other end touch anything until the next step.

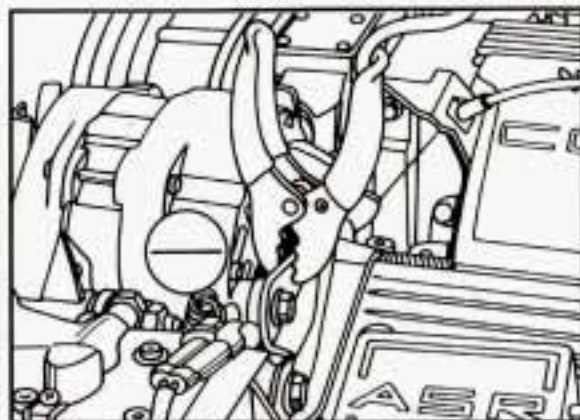

9. The other end of the negative cable doesn't go to the dead battery. It goes to a heavy, unpainted metal part on the engine of the vehicle with the dead battery. Attach the cable at least 18 inches (45 cm) away from the dead battery, but not near engine parts that move. The electrical connection is just as good there, but the chance of sparks getting back to the battery is much less.
10. Now start the vehicle with the good battery and run the engine for a while.
11. Try to start the vehicle with the dead battery. If it won't start after a few tries, it probably needs service.

Problems on the Road

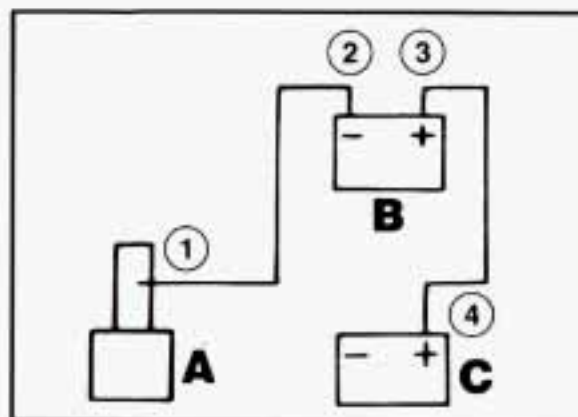

12. Remove the cables in reverse order to prevent electrical shorting. Take care that they don't touch each other or any other metal.

- A. Heavy Metal Engine Part
- B. Good Battery
- C. Dead Battery

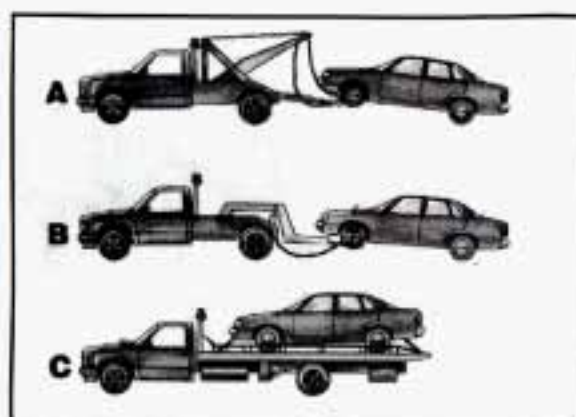

■ Towing Your Vehicle

Try to have a GM dealer or a professional towing service tow your Corvette. The usual towing equipment is a sling-type (A) or a wheel-lift (B) or car carrier (C) tow truck.

If your vehicle has been changed or modified since it was factory-new by adding aftermarket items like fog lamps, aero skirting, or special tires and wheels, these instructions and illustrations may not be correct.

Before you do anything, turn on the hazard warning flashers.

When you call, tell the towing service:

- That your vehicle cannot be towed from the rear with sling-type equipment.
- That your vehicle has rear-wheel drive.
- The make, model, and year of your vehicle.
- Whether you can still move the shift lever.
- If there was an accident, what was damaged.

When the towing service arrives, let the tow operator know that this manual contains detailed towing instructions and illustrations. The operator may want to see them.



 **CAUTION:**

To help avoid injury to you or others:

- Never let passengers ride in a vehicle that is being towed.
- Never tow faster than safe or posted speeds.
- Never tow with damaged parts not fully secured.
- Never get under your vehicle after it has been lifted by the tow truck.
- Always secure the vehicle on each side with separate safety chains when towing it.
- Never use "J" hooks. Use T-hooks instead.

When your vehicle is being towed, have the ignition key off. The steering wheel should be clamped in a straight-ahead position, with a clamping device designed for towing service. Do not use the vehicle's steering column lock for this. The transmission should be in "Neutral" and the parking brake released.

Don't have your vehicle towed on the rear wheels unless you must. If the vehicle must be towed on the rear wheels, don't go more than 35 mph (55 km/h) or farther than 50 miles (80 km) or your transmission will be damaged. Go slow over rough ground, and position one wheel at a time (angled 45°) if you have to go over curbs and rises. Wheels at the lifted end should be at least four inches (100 mm) above the ground. If these limits must be exceeded, then the rear wheels have to be supported on a dolly.



CAUTION:

A vehicle can fall from a car carrier if it isn't adequately secured. This can cause a collision, serious personal injury and vehicle damage. The vehicle should be tightly secured with chains or steel cables before it is transported.

Don't use substitutes (ropes, leather straps, canvas webbing, etc.) that can be cut by sharp edges underneath the towed vehicle. Always use T-hooks inserted in the T-hook slots. Never use J-hooks. They will damage drive-train and suspension components.

Problems on the Road



Front Towing Hook-Ups

Attach T-hook chains on both sides in slotted holes behind and just inboard of front wheels.

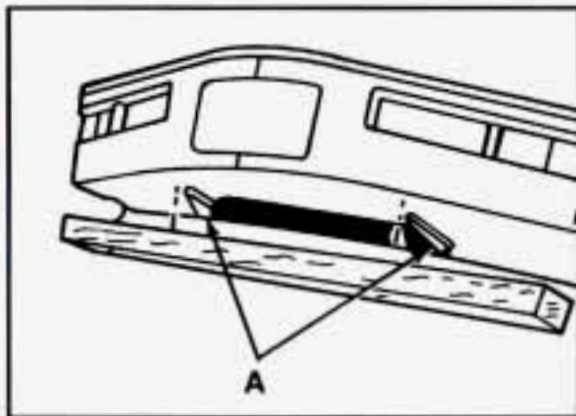

Position 4x4 wood beam across sling chains contacting under fascia just ahead of curb protect brackets (A).

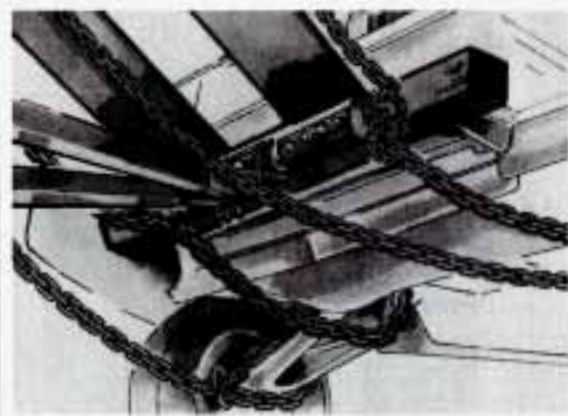

Position sling crossbar against front of 4x4 beam.

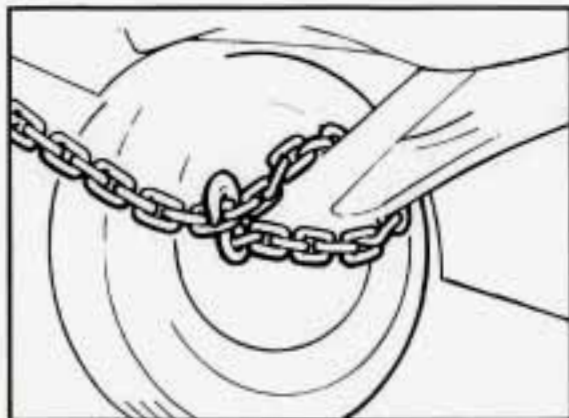

Attach a separate safety chain around outboard end of each lower control arm.

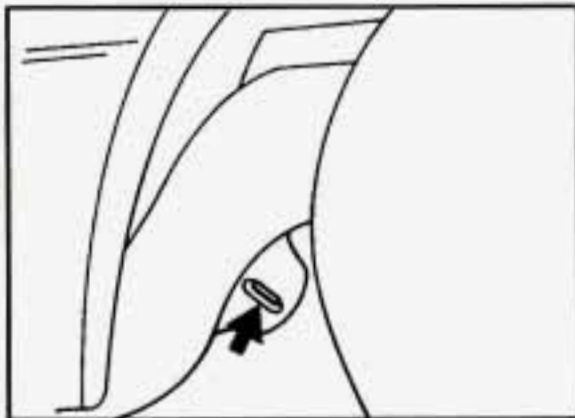

Rear Towing Hook-Ups

Attach T-hook chains in slots forward and just inboard of rear wheels on both sides.

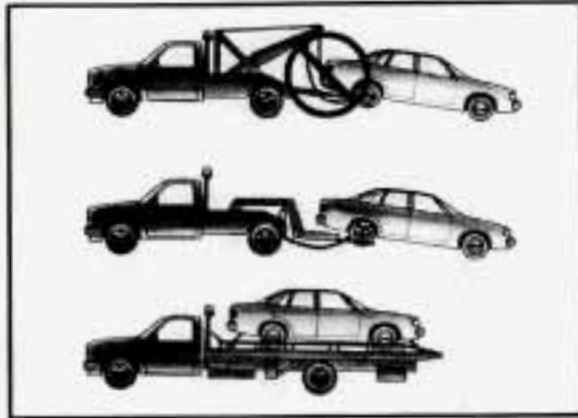

NOTICE:

Do not tow with sling-type equipment or rear bumper valance will be damaged.

Use wheel lift or car carrier equipment. Additional ramping may be required for car carrier equipment.

Use safety chains and wheel straps.

Problems on the Road

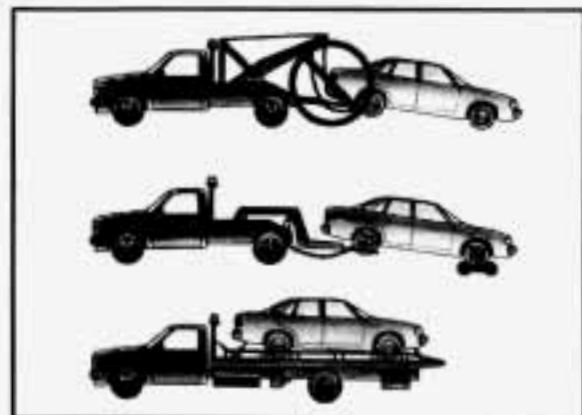

NOTICE:

Towing a vehicle over rough surfaces could damage a vehicle. Damage can occur from vehicle-to-ground or vehicle-to-wheel-lift-equipment. To help avoid damage, install a towing dolly and raise vehicle until adequate clearance is obtained between the ground and/or wheel-lift equipment.



Attach a separate safety chain around the outboard end of each lower control arm.

NOTICE:

Do not allow chains to contact spring, as damage to spring could result.

■ *Engine Overheating*

You will find a engine coolant temperature gauge on the instrument cluster and a low coolant light on the Driver Information Center.



If Steam Is Coming from Your Engine:

CAUTION:

Steam from an overheated engine can burn you badly, even if you just open the hood. Stay away from the engine if you see or hear steam coming from it. Just turn it off and get everyone away from the vehicle until it cools down. Wait until there is no sign of steam or coolant before opening the hood.

If you keep driving when your engine is overheated, the liquids in it can catch fire. You or others could be badly burned. Stop your engine if it overheats, and get out of the vehicle until the engine is cool.

NOTICE:

If your engine catches fire because you keep driving with no coolant, your vehicle can be badly damaged. The costly repairs would not be covered by your warranty.

If No Steam Is Coming from Your Engine:

If you get the overheat warning but see or hear no steam, the problem may not be too serious. Sometimes the engine can get a little too hot when you:

- Climb a long hill on a hot day.
- Stop after high speed driving.
- Idle for long periods in traffic.

If you get the overheat warning with no sign of steam, try this for a minute or so:

1. Turn off your air conditioner.
2. Turn on your heater to full hot at the highest fan speed and open the window as necessary.
3. If you're in a traffic jam, shift to "N" (Neutral).

If you no longer have the overheat warning, you can drive. Just to be safe, drive slower for about ten minutes. If the warning doesn't come back on, you can drive normally.

If the warning continues, pull over, stop, and park your vehicle right away.

If there's still no sign of steam, you can idle the engine for two or three minutes while you're parked, to see if the warning stops. But then, if you still have the warning, **TURN OFF THE ENGINE AND GET EVERYONE OUT OF THE VEHICLE** until it cools down.

You may decide not to lift the hood but to get service help right away.



Cooling System

When you decide it's safe to lift the hood, here's what you'll see on the LT1 engine:

1. Coolant recovery tank
2. Coolant high fill reservoir with pressure cap
3. Electric engine fans



CAUTION:

An electric fan under the hood can start up even when the engine is not running and can injure you. Keep hands, clothing and tools away from any underhood electric fan.

Problems on the Road



Cooling System

When you decide it's safe to lift the hood, here's what you'll see on the LT5 engine:

1. Coolant recovery tank
2. Coolant high fill reservoir with pressure cap
3. Electric engine fans



CAUTION:

An electric fan under the hood can start up even when the engine is not running and can injure you. Keep hands, clothing and tools away from any underhood electric fan.

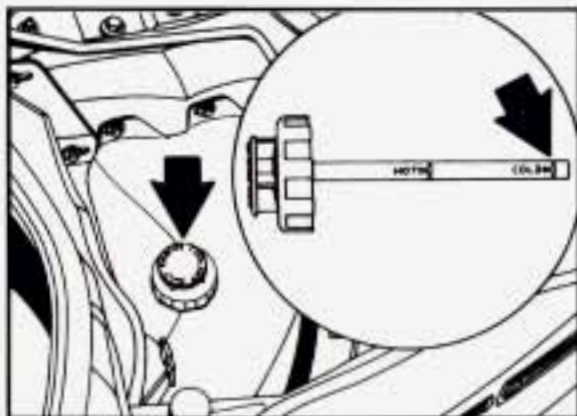

If the coolant inside the coolant recovery tank is boiling, don't do anything else until it cools down.

When it is cool, remove the coolant recovery tank cap and look at the dipstick. The coolant level should be at or above "COLD." If it isn't, you may have a leak in the radiator hoses, heater hoses, radiator, water pump or somewhere else in the cooling system.



CAUTION:

Heater and radiator hoses, and other engine parts, can be very hot. Don't touch them. If you do, you can be burned.

Don't run the engine if there is a leak. If you run the engine, it could lose all coolant. That could cause an engine fire, and you could be burned. Get any leak fixed before you drive the vehicle.

NOTICE:

Engine damage from running your engine without coolant isn't covered by your warranty.

If there seems to be no leak, check to see if the electric engine fans are running. If the engine is overheating, both fans should be running. If they aren't, your vehicle needs service.

How to Add Coolant to the Coolant Recovery Tank

If you haven't found a problem yet, but the coolant level isn't at or above the "COLD" mark, add a 50/50 mixture of clean water (preferably distilled) and a proper antifreeze at the coolant recovery tank. (See "Engine Coolant" in the Index for more information about the proper coolant mix.)



CAUTION:

Adding only plain water to your cooling system can be dangerous. Plain water, or some other liquid like alcohol, can boil before the proper coolant mix will. Your vehicle's coolant warning system is set for the proper coolant mix. With plain water or the wrong mix, your engine could get too hot but you wouldn't get the overheat warning. Your engine could catch fire and you or others could be burned. Use a 50/50 mix of clean water and a proper antifreeze.

NOTICE:

In cold weather, water can freeze and crack the engine, radiator, heater core and other parts. Use the recommended coolant.

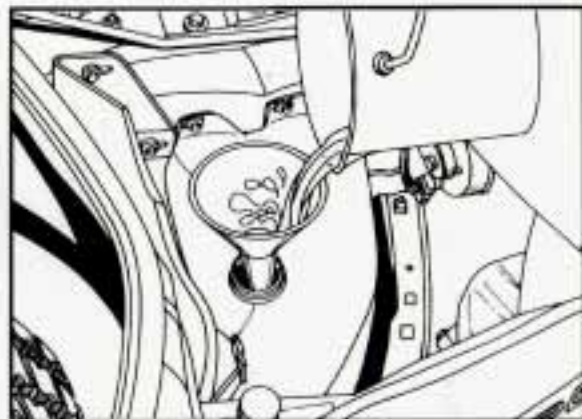

CAUTION:

You can be burned if you spill coolant on hot engine parts. Coolant contains ethylene glycol and it will burn if the engine parts are hot enough. Don't spill coolant on a hot engine.

When the coolant in the coolant recovery tank is at or above the "COLD" mark, start your vehicle.

If the overheat warning continues, there's one more thing you can try. You can add the proper coolant mix directly to the coolant high fill reservoir, but be sure the cooling system is cool before you do it.

Problems on the Road



CAUTION:

Steam and scalding liquids from a hot cooling system can blow out and burn you badly. They are under pressure, and if you turn the coolant high fill reservoir pressure cap — even a little — they can come out at high speed. Never turn the cap when the cooling system, including the coolant high fill reservoir pressure cap, is hot. Wait for the cooling system and coolant high fill reservoir pressure cap to cool if you ever have to turn the pressure cap.

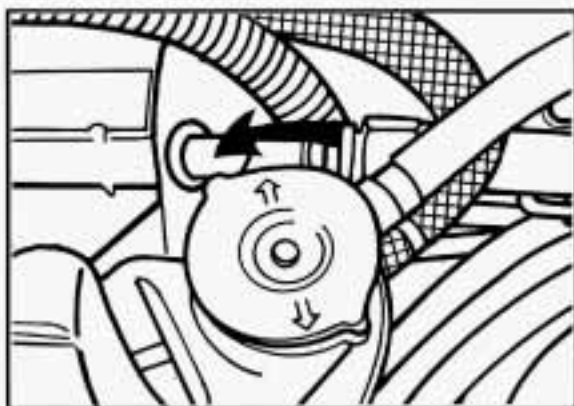

How to Add Coolant to the Coolant High Fill Reservoir – LT1 Only

NOTICE:

The LT1 engine (Code P) has a specific coolant high fill reservoir fill procedure. Failure to follow this procedure could cause your engine to overheat and be severely damaged.

1. You can remove the coolant high fill reservoir pressure cap when the cooling system, including the coolant high fill reservoir pressure cap and upper radiator hose, is no longer hot.

Turn the pressure cap slowly to the left until it first stops. (Don't press down while turning the pressure cap.)

If you hear a hiss, wait for that to stop. A hiss means there is still some pressure left.

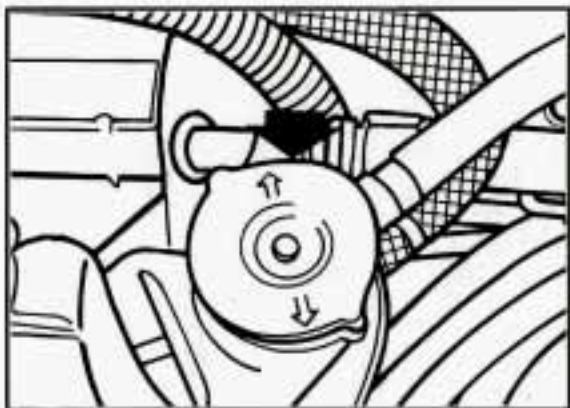

2. Then keep turning the pressure cap, but now push down as you turn it. Remove the pressure cap.

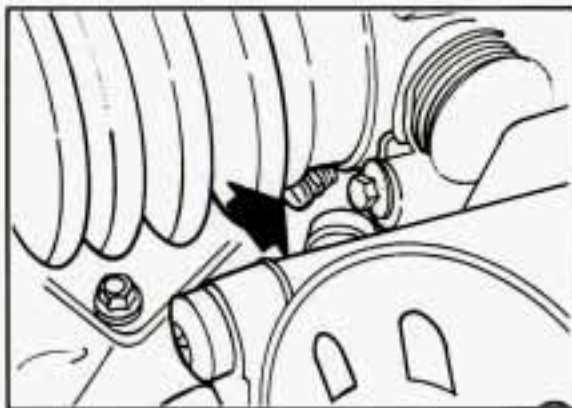

3. After the engine cools, open the air bleed valves on the throttle body. . .

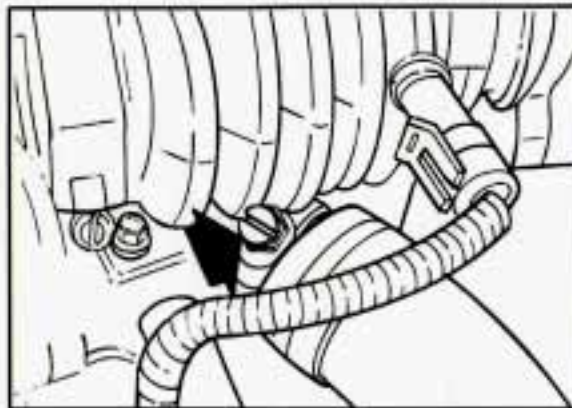

. . . and water pump inlet.



CAUTION:

You can be burned if you spill coolant on hot engine parts. Coolant contains ethylene glycol, and it will burn if the engine parts are hot enough. Don't spill coolant on a hot engine.

Problems on the Road

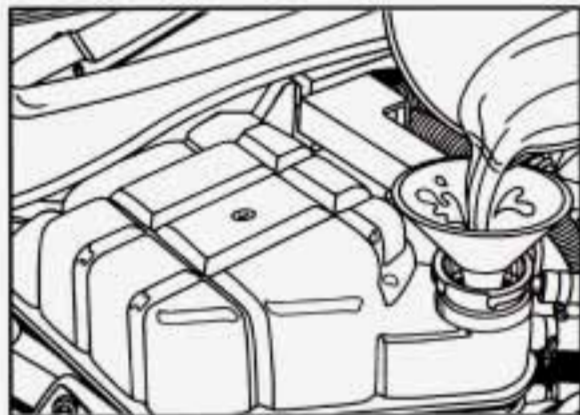

4. Fill with the proper mix. Add coolant until you see a steady stream of coolant coming from the bleed valves.
5. Close the bleed valves.
6. Continue to fill the coolant high fill reservoir up to the base of the filler neck.
7. Rinse or wipe the spilled coolant from the engine and compartment.
8. Start the engine and allow it to run in idle for approximately four minutes. By this time, the coolant level inside the coolant high fill reservoir will be lower. Add more of the proper mix through the filler neck until the level reaches the base of the filler neck.

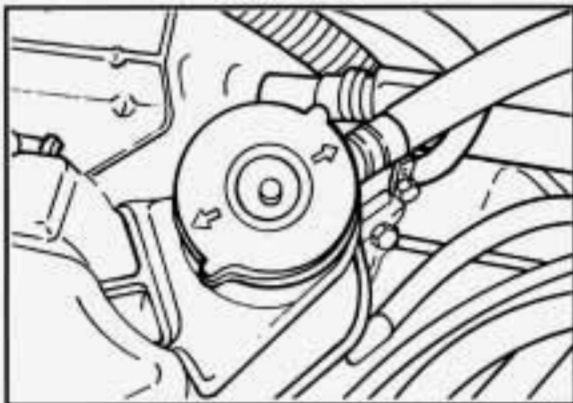

9. Shut the engine off and replace the pressure cap. Be sure the arrows on the pressure cap line up like this.

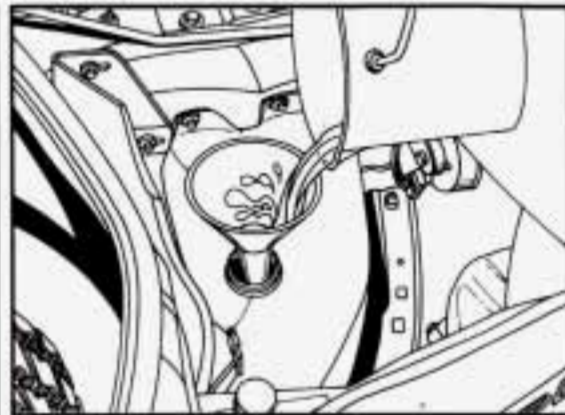

10. Then fill the coolant recovery tank to the proper level.

For a complete drain, flush and refill, see your Chevrolet dealer or a Chevrolet Corvette Service Manual. To purchase a service manual, see "Service Publications" in the Index.

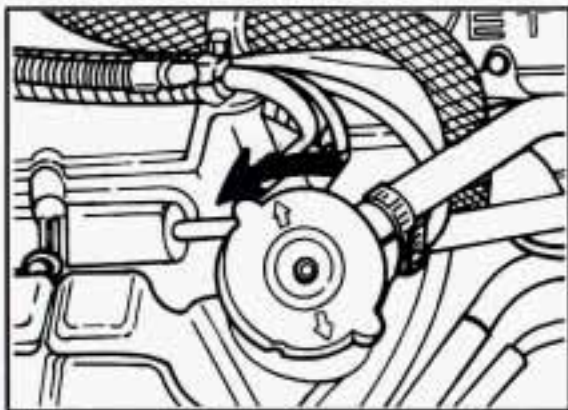

How to Add Coolant to the Coolant High Fill Reservoir (5.7L LT5 (Code J) Engine)

1. You can remove the coolant high fill reservoir pressure cap when the cooling system, including the coolant high fill reservoir pressure cap and upper radiator hose, is no longer hot. Turn the pressure cap slowly to the left until it first stops. (Don't press down while turning the pressure cap.)

If you hear a hiss, wait for that to stop. A hiss means there is still some pressure left.

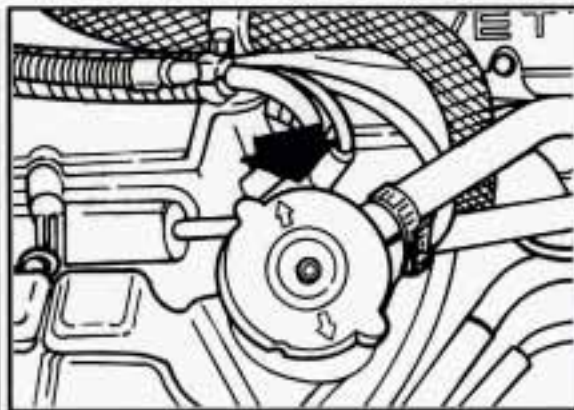

2. Then keep turning the pressure cap, but now push down as you turn it. Remove the pressure cap.

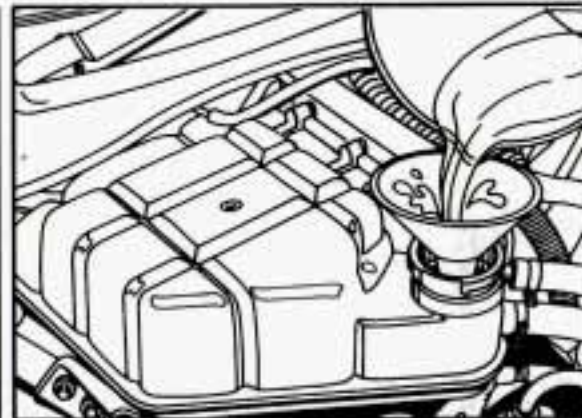

3. Fill the coolant high fill reservoir with the proper mix, up to the base of the filler neck.

Problems on the Road

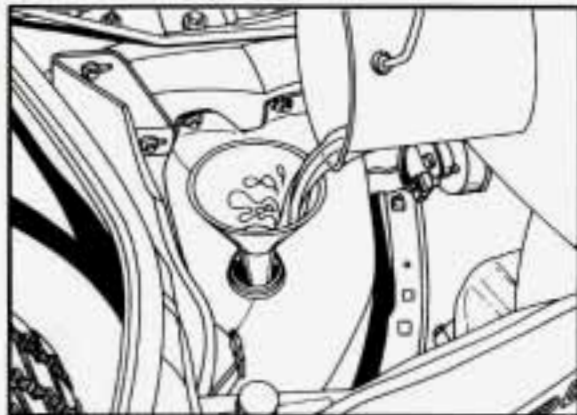

4. Then fill the coolant recovery tank to the "HOT" mark on the dipstick.

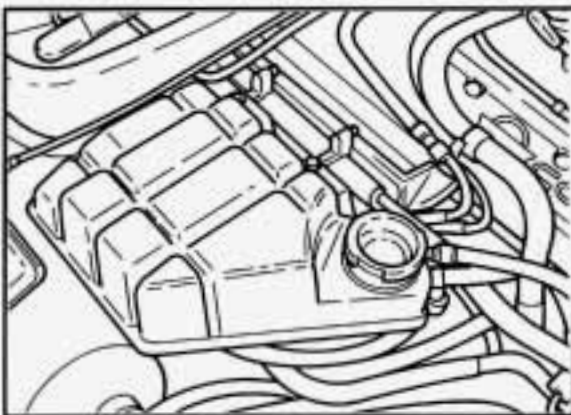

5. Put the cap back on the coolant recovery tank, but leave the coolant high fill reservoir pressure cap off.

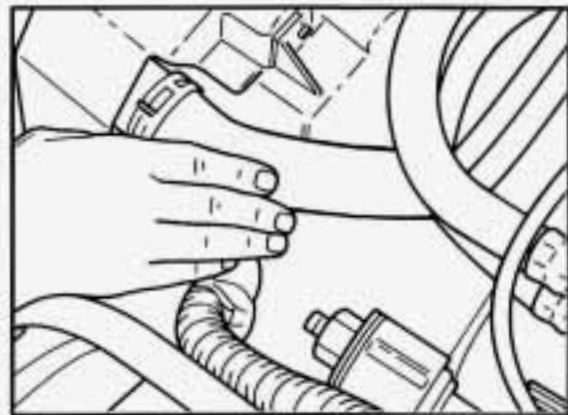

6. Start the engine and let it run until you can feel the upper radiator hose getting hot. Watch out for the engine fans.
7. By this time the coolant level inside the coolant high fill reservoir filler neck may be lower. If the level is lower, add more of the proper mix through the filler neck until the level reaches the base of the filler neck.

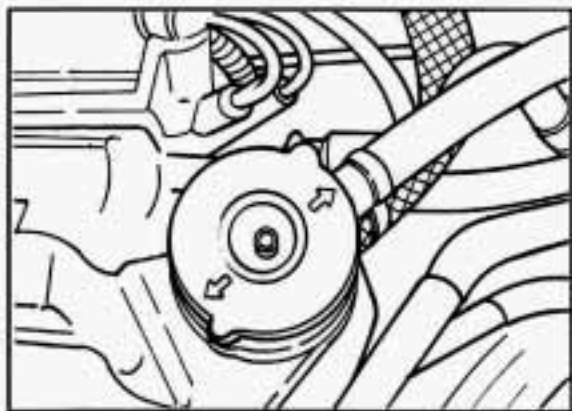

8. Shut the engine off and replace the pressure cap. At any time during this procedure if coolant begins to flow out of the filler neck, reinstall the pressure cap. Be sure the arrows on the cap line up like this.

■ *If a Tire Goes Flat*

It's unusual for a tire to "blow out" while you're driving, especially if you maintain your tires properly. If air goes out of a tire, it's much more likely to leak out slowly. But if you should ever have a "blowout," here are a few tips about what to expect and what to do:

If a front tire fails, the flat tire will create a drag that pulls the vehicle toward that side. Take your foot off the accelerator pedal and grip the steering wheel firmly. Steer to maintain lane position, then gently brake to a stop well out of the traffic lane.

A rear blowout, particularly on a curve, acts much like a skid and may require the same correction you'd use in a skid. In any rear blowout, remove your foot from the accelerator pedal. Get the vehicle under control by steering the way you want the vehicle to go. It may be very bumpy and noisy, but you can still steer. Gently brake to a stop, well off the road if possible.

If a tire goes flat, the next section shows how to use your jacking equipment to change a flat tire safely. If your vehicle has Extended Mobility Tires (tires with "EMT" molded on the sidewalls), see "Extended Mobility Tires" in the Index.

Changing a Flat Tire

If a tire goes flat, avoid further tire damage by driving slowly to a level place. Turn on your hazard warning flashers.

Problems on the Road



CAUTION:

Changing a tire can cause an injury. The vehicle can slip off the jack and roll over you or other people. You and they could be badly injured. Find a level place to change your tire. To help prevent the vehicle from moving:

1. Set the parking brake firmly.
2. Put an automatic transmission shift lever in "P" (Park), or shift a manual transmission to "1" (First) or "R" (Reverse).
3. Turn off the engine.

To be even more certain the vehicle won't move, you can put chocks at the front and rear of the tire farthest away from the one being changed. That would be the tire on the other side of the vehicle, at the opposite end.

The following steps will tell you how to use the jack and change a tire.

Your Corvette wheel lock key has a unique registration number. The registration number is printed on a card included in your locknut package. Also on this card is lost key replacement information. This number is NOT recorded by GM or your dealer, so be sure not to lose this card. You will need the information if you ever lose your wheel lock key.

If you have someone else remove your wheels, make sure you give them the special wheel nut socket and wheel lock key. They are under the jack in the rear storage compartment behind the passenger's seat. The socket can be used with an air or torque wrench.

NOTICE:

Your wheels could be damaged if the wheel nut socket is not used to remove your Corvette's wheels.

Always use the wheel nut socket when you use the wheel wrench provided with your Corvette.

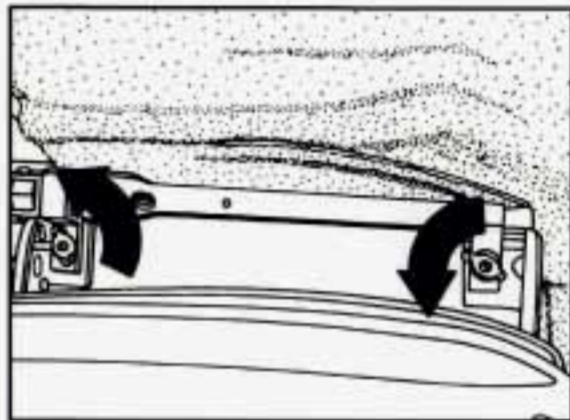

The equipment you'll need is behind the driver's seat and in the rear storage compartment behind the passenger's seat. Move the driver's seat all the way forward and fold the seatback forward. The wheel wrench is on the floor behind the seat. Loosen the wingnuts and slide the wheel wrench out of the clamps.



The jack, wheel nut socket and wheel lock key are in the rear storage compartment behind the passenger's seat. Open the compartment door and remove the plastic tray. Lift the jack, wheel nut socket and wheel lock key out of the foam container. You should have a jack, wheel wrench, socket and a wheel lock key.

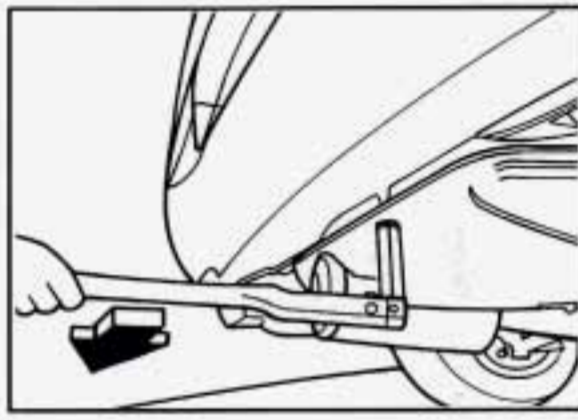

The spare tire is on a tire carrier tray under the rear end of your vehicle. To lower the tray, use the socket end of the wheel wrench to turn the latch bolt counterclockwise. Lower the tray about an inch. Don't loosen the latch bolt too much, or the tray could fall.

Problems on the Road

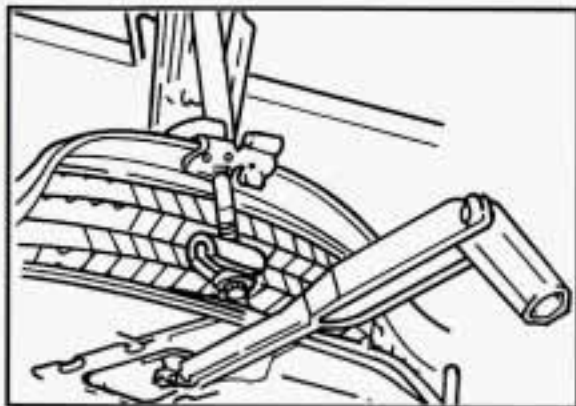

Put the hooked end of the wheel wrench into the slot in the tray. Insert the wheel wrench a little from the side so it isn't over the latch bolt. Pull up on the wheel wrench to lift the tray.

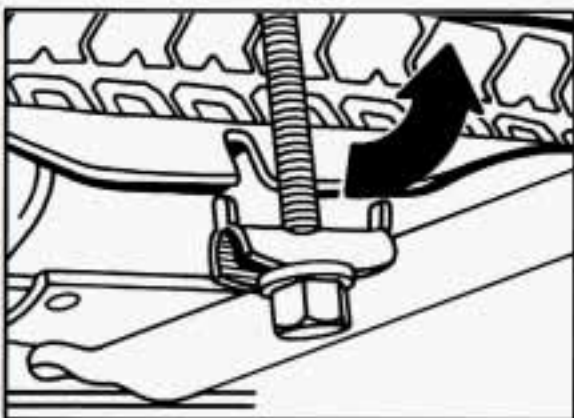

While holding the tray up with the wheel wrench, pull the latch bolt to release it from the tray. If it won't come free, loosen it a little more.

Carefully lower the tray using the wheel wrench and remove the spare tire.

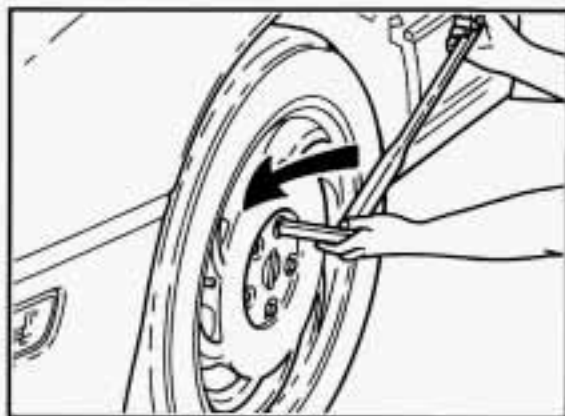

Remove the plastic wheel nut caps using the socket end of the wheel wrench. Store the caps somewhere until you have the flat tire repaired or replaced.

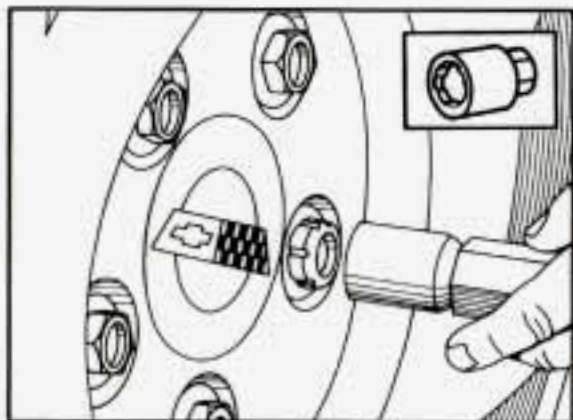

Each wheel will have one locknut. A special wheel lock key (removal tool) and instructions are provided. Attach the wheel lock key to the wheel wrench. Remove the locking wheel nut by turning counterclockwise.

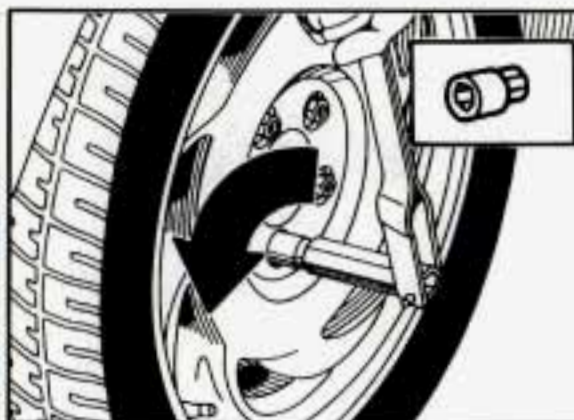

Attach the wheel nut socket to the wheel wrench and loosen all the wheel nuts. Don't remove them yet.

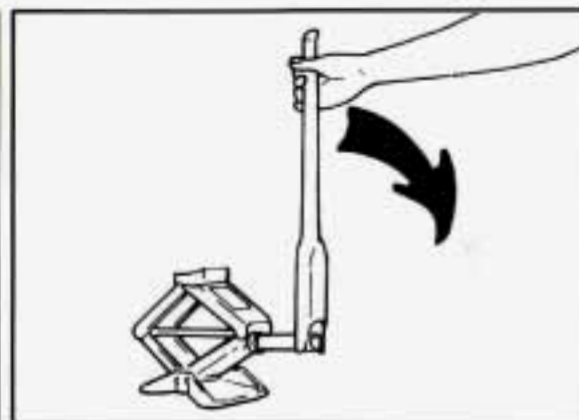

Attach the wheel wrench to the jack. Hold the wheel wrench handle so it forms a right angle with the jack, then turn it clockwise.

Problems on the Road

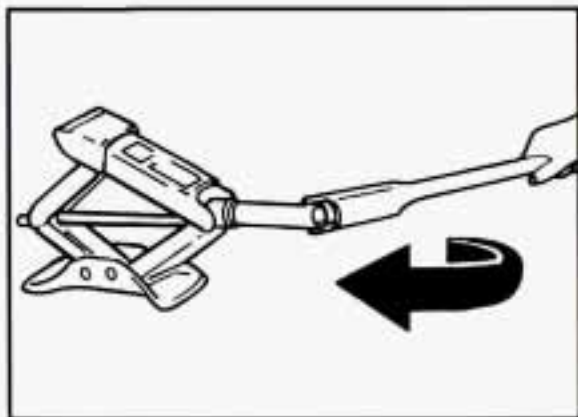

When you've turned the wrench almost as far as it will go, swing it around to the other side. Keep turning to raise the jack lift head a few inches.

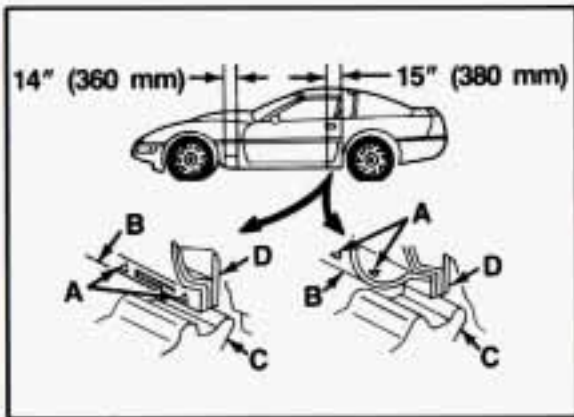

Position the jack under the vehicle. There are two locator triangles (A) on the panels (B) near each wheel. Raise the lift head (C) until it fits firmly under the steel rocker flange (D) between the triangles nearest the flat tire.

If you have a ZR-1, the triangles are on the underside of the molding. The flange is inboard of the triangles.



CAUTION:

Getting under a vehicle when it is jacked up is dangerous. If the vehicle slips off the jack, you could be badly injured or killed. Never get under a vehicle when it is supported only by a jack.

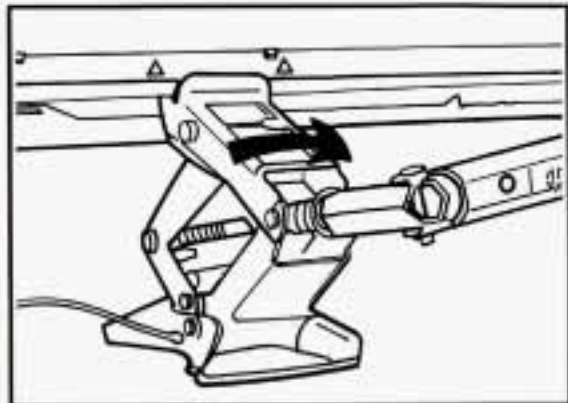

Stay away from the moldings or fender flanges to avoid damaging them.

NOTICE:

Raising your vehicle with the jack improperly positioned will damage the vehicle or may allow the vehicle to fall off the jack. Be sure to fit the jack lift head into the proper location before raising your vehicle.

Raise the vehicle by turning the wheel wrench clockwise. Raise the vehicle far enough off the ground so there is enough room for the spare tire to fit. Remove all the wheel nuts and take off the flat tire.

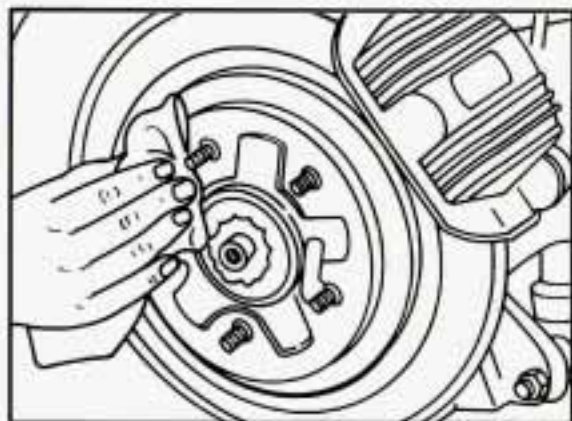

⚠ CAUTION:

Rust or dirt on the wheel, or on the parts to which it is fastened, can make the wheel nuts become loose after a time. The wheel could come off and cause an accident. When you change a wheel, remove any rust or dirt from the places where the wheel attaches to the vehicle. In an emergency, you can use a cloth or a paper towel to do this; but be sure to use a scraper or wire brush later, if you need to, to get all the rust or dirt off.

Remove any rust or dirt from the wheel bolts, mounting surfaces and spare wheel. Place the spare on the wheel mounting surface.

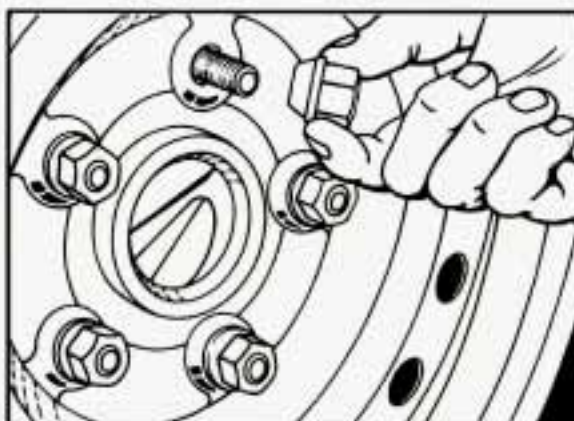

⚠ CAUTION:

Never use oil or grease on studs or nuts. If you do, the nuts might come loose. Your wheel could fall off, causing a serious accident.

Replace the wheel nuts with the rounded end of the nuts toward the wheel. Tighten each nut by hand until the wheel is held against the hub.

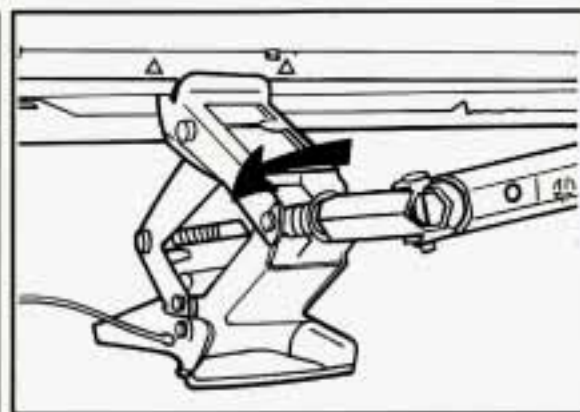

Lower the vehicle by rotating the wheel wrench counterclockwise. Lower the jack completely.

Problems on the Road

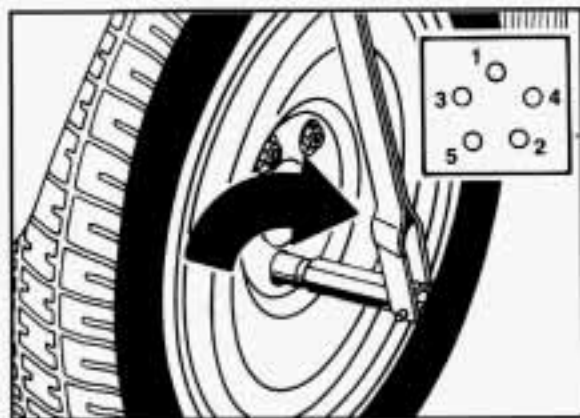

Tighten the wheel nuts firmly in a criss-cross sequence as shown.



CAUTION:

Incorrect wheel nuts or improperly tightened wheel nuts can cause the wheel to become loose and even come off. This could lead to an accident. Be sure to use the correct wheel nuts. If you have to replace them, be sure to get the right kind.

Stop somewhere as soon as you can and have the nuts tightened with a torque wrench to 100 pound-feet (140 N•m).

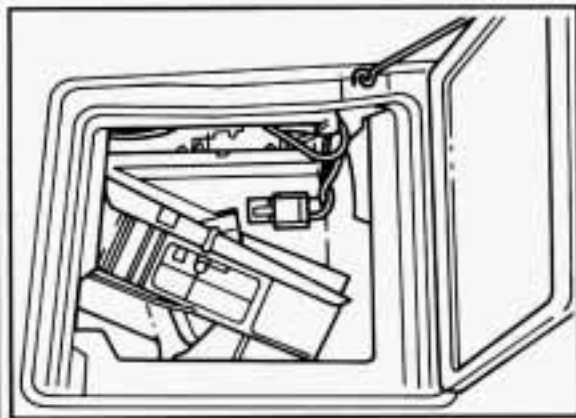

The "LOW/FLAT TIRE" or "SERVICE LTPWS" light will stay on as long as you are using the compact spare tire. It should go out when the original tire is replaced.

After you have the flat tire repaired or replaced, install the plastic nut caps and tighten them to 22 pound-inches (2.5 N•m).

Put the jack, wheel nut socket and wheel lock key in the rear storage compartment behind the passenger's seat. Make sure the parts are stored properly in the foam container. Position the jack in the container so that you can read the yellow CAUTION label from the driver's seat. Replace the plastic tray and close the storage compartment.



CAUTION:

Storing a jack, a tire or other equipment in the passenger compartment of the vehicle could cause injury. In a sudden stop or collision, loose equipment could strike someone. Store all these in the proper place.

NOTICE:

Your Corvette's radio receiver box is in the rear storage compartment. To help avoid damage, carefully place the jack, socket and wheel lock key into the foam container in the compartment. Do not toss or place the items against the radio receiver box or any wiring.

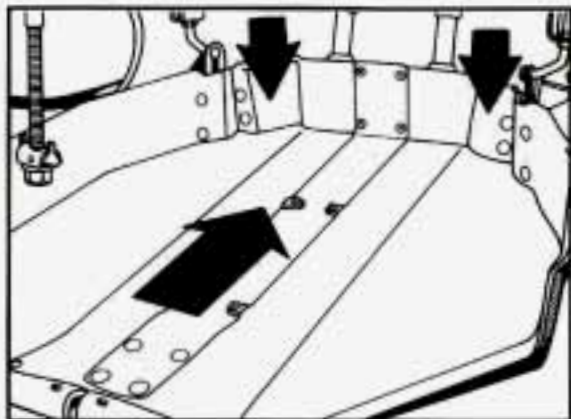

Storing a Flat Tire (Except ZR-1 Rear Tires)

The road tire is larger than the spare, so you must adjust the tray to its lower position. Lift and push the tire carrier tray toward the front of the vehicle. The tray will drop to its lower position.

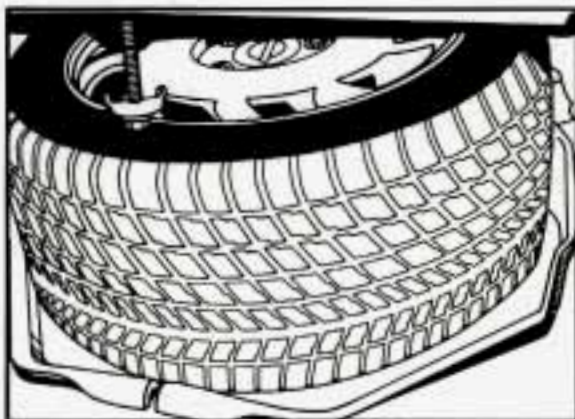

Put the flat road tire on the tray. Lift the latch bolt, push it toward the front of the vehicle, and the bolt will drop down to the lower position.

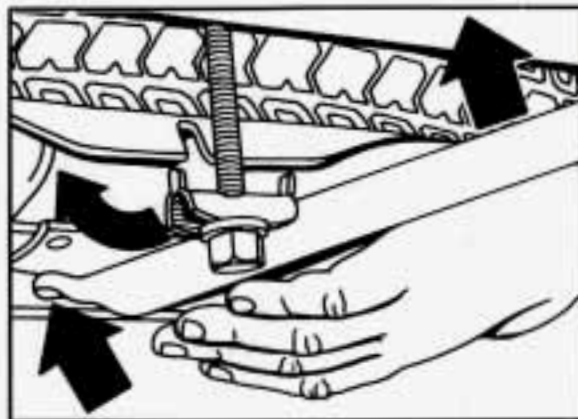

Put the hooked end of the wheel wrench into the slot in the tray. Lift the tray using the wheel wrench and insert the latch bolt into the notch in the tray. To raise the tray, use the socket end of the wheel wrench to turn the latch bolt clockwise. Turn the latch bolt until it is snug.

Put the wheel wrench back in its place under the driver's seat. Be sure to tighten the wingnuts.

Problems on the Road



Storing a Flat Tire (ZR-1 Rear Tires)

A ZR-1 rear tire will not fit in the tray, so you must put it on the floor of the rear area. Put the flat tire in the storage bag provided. Place the tire on the rear area floor.

Use the luggage straps to hold the tire in place. Loosen the straps, then attach each end of the longer strap to the rear cargo hooks.

Attach the other strap to the hook behind the console.

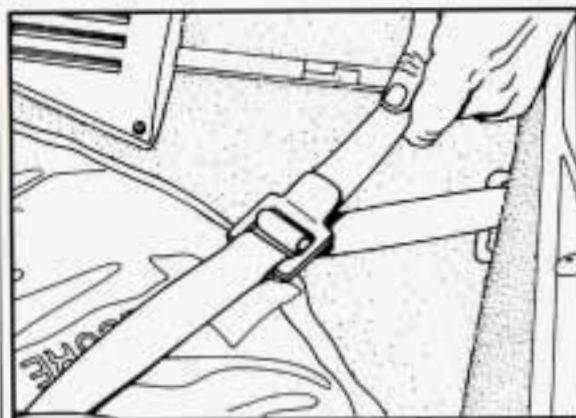

Tighten the straps by pulling on the loose ends.

When the tire is stored in the rear cargo area, you can't store a removable roof panel. It will not fit into the latches properly.

Put the wheel wrench back in its place under the driver's seat. Be sure to tighten the wingnuts.



CAUTION:

Do not place anything on top of the flat road tire when it is stored in the rear area. If you stop quickly, these things could fly forward into the passenger area and hurt someone. Secure any loose articles in the rear area.

Raise the tire carrier tray to its upper position and tighten the latch bolt until it is snug.

Compact Spare Tire

Although the compact spare was fully inflated when your vehicle was new, it can lose air after a time. Check the inflation pressure regularly. It should be 60 psi (420 kPa). After installing the compact spare on your vehicle, you should stop as soon as possible and make sure your spare tire is correctly inflated. The compact spare is made to perform well at posted speed limits for distances up to 3,000 miles (5 000 km), so you can finish your trip and have your full-size tire repaired or replaced where you want. Of course, it's best to replace your spare with a full-size tire as soon as you can. Your spare will last longer and be in good shape in case you need it again.



CAUTION:

When the compact spare is installed, your vehicle's handling capabilities will be reduced during severe maneuvers. If you drive too fast, you could lose control of your vehicle. You or others could be injured. Don't drive over 55 mph (90 km/h) when the compact spare is installed.

NOTICE:

Don't take your compact spare through an automatic car wash with guide rails. The compact spare can get caught on the rails. That can damage the tire and wheel, and maybe other parts of your vehicle.

Don't use your compact spare on some other vehicle.

And don't mix your compact spare or wheel with other wheels or tires. They won't fit. Keep your spare and its wheel together.

NOTICE:

Tire chains won't fit your compact spare. Using them will damage your vehicle and destroy the chains too. Don't use tire chains on your compact spare.

■ *If You're Stuck: In Sand, Mud, Ice or Snow*

What you don't want to do when your vehicle is stuck is to spin your wheels. The method known as "rocking" can help you get out when you're stuck, but you must use caution.

Problems on the Road



CAUTION:

If you let your tires spin at high speed, they can explode and you or others could be injured. And, the transmission or other parts of the vehicle can overheat. That could cause an engine compartment fire or other damage. When you're stuck, spin the wheels as little as possible. Don't spin the wheels above 35 mph (55 km/h) as shown on the speedometer.

NOTICE:

Spinning your wheels can destroy parts of your vehicle as well as the tires. If you spin the wheels too fast while shifting your transmission back and forth, you can destroy your transmission.

Rocking your vehicle to get it out:

First, turn your steering wheel left and right. That will clear the area around your front wheels. You should turn your ASR system off. (See "ASR System" in the Index.) Then shift back and forth between "R" (Reverse) and a forward gear (or with a manual transmission, between First or Second gear and Reverse), spinning the wheels as little as possible. Release the accelerator pedal while you shift, and press lightly on the accelerator pedal when the transmission is in gear. If that doesn't get you out after a few tries, you may need to be towed out. If you do need to be towed out, see "Towing Your Vehicle" in the Index.

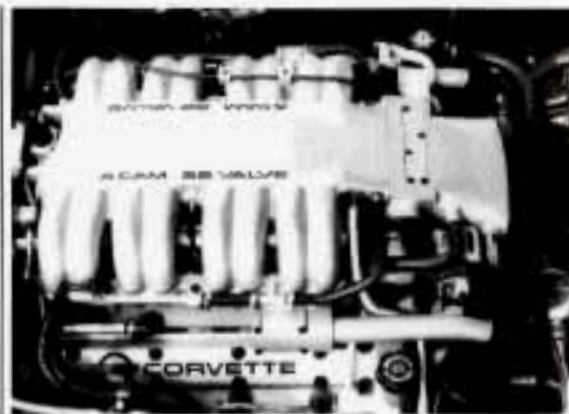

Here you will find information about the care of your Corvette. This part begins with service and fuel information, and then it shows how to check important fluid and lubricant levels. There is also technical information about your vehicle, and a section devoted to its appearance care.

Part 6

Service & Appearance Care

| | |
|---|-----|
| Service | 172 |
| Fuel | 173 |
| Checking Things under the Hood | 175 |
| Hood Release | 175 |
| Engine Oil | 178 |
| Air Cleaner | 182 |
| Automatic Transmission Fluid | 184 |
| Manual Transmission Fluid | 186 |
| Hydraulic Clutch | 187 |
| Rear Axle | 188 |
| Engine Coolant | 188 |
| Power Steering Fluid | 191 |
| Windshield Washer Fluid | 192 |
| Brake Master Cylinder | 193 |
| Battery | 195 |
| Bulb Replacement | 195 |
| Windshield Wiper Blades | 202 |
| Loading Your Vehicle | 202 |
| Tires | 204 |
| Appearance Care | 210 |
| Appearance Care Materials Chart | 217 |
| Vehicle Identification Number (VIN) | 218 |
| Service Parts Identification Label | 218 |
| Add-On Electrical Equipment | 218 |
| Fuses and Circuit Breakers | 219 |
| Replacement Bulbs | 223 |
| Capacities and Specifications | 224 |

Service and Appearance Care



■ *Service*

Your Chevrolet dealer knows your vehicle best and wants you to be happy with it. We hope you'll go to your dealer for all your service needs. You'll get genuine GM parts and GM-trained and supported service people.

We hope you'll want to keep your GM vehicle all GM. Genuine GM parts have one of these marks.

Doing Your Own Service Work

If you want to do some of your own service work, you'll want to get the proper Chevrolet Service Manual. It tells you much more about how to service your Corvette than this manual can. To order the proper service manual, see "Service Publications" in the Index.

Your vehicle has an air bag system. Before attempting to do your own service work, see "Servicing Your Air Bag-Equipped Corvette" in the Index.

You should keep a record with all parts receipts and list the mileage and the date of any service work you perform. See "Maintenance Record" in the Index.



CAUTION:

You can be injured if you try to do service work on a vehicle without knowing enough about it.

- Be sure you have sufficient knowledge, experience, and the proper replacement parts and tools before you attempt any vehicle maintenance task.
- Be sure to use the proper nuts, bolts and other fasteners. "English" and "metric" fasteners can be easily confused. If you use the wrong fasteners, parts can later break or fall off. You could be hurt.

NOTICE:

If you try to do your own service work without knowing enough about it, your vehicle could be damaged.

■ Fuel

Use premium unleaded gasoline rated at 91 octane or higher. You may use middle grade or regular unleaded gasolines, but your vehicle may not accelerate as well. The gasoline you use should meet specifications ASTM D4814 in the U.S. and CGSB 3.5-92 in Canada. These fuels should have the proper additives, so you should not have to add anything to the fuel.

In the U.S. and Canada, it's easy to be sure you get the right kind of gasoline (unleaded). You'll see "UNLEADED" right on the pump. And only unleaded nozzles will fit into your vehicle's filler neck.

Be sure the posted octane for premium is at least 91 (at least 89 for middle grade and 87 for regular). If the octane is less than 87, you may get a heavy knocking noise when you drive. If it's bad enough, it can damage your engine.

If you're using fuel rated at 91 octane or higher and you still hear heavy knocking, your engine needs service. But don't worry if you hear a little pinging noise when you're accelerating or driving up a hill. That's normal and you don't have to

buy a higher octane fuel to get rid of pinging. It's the heavy, constant knock that means you have a problem.

What about gasoline with blending materials that contain oxygen (oxygenates), such as MTBE or alcohol?

MTBE is "methyl tertiary-butyl ether." Fuel that is no more than 15% MTBE is fine for your vehicle.

Ethanol is ethyl or grain alcohol. Properly-blended fuel that is no more than 10% ethanol is fine for your vehicle.

Methanol is methyl or wood alcohol.

NOTICE:

Fuel that is more than 5% methanol is bad for your vehicle. Don't use it. It can corrode metal parts in your fuel system and also damage plastic and rubber parts. That damage wouldn't be covered under your warranty. And even at 5% or less, there must be "cosolvents" and corrosion preventers in this fuel to help avoid these problems.

Gasolines for Cleaner Air

Your use of gasoline with deposit control additives will help prevent deposits from forming in your engine and fuel system. That helps keep your engine in tune and your emission control system working properly. It's good for your vehicle, and you'll be doing your part for cleaner air.

Many gasolines are now blended with oxygenates. General Motors recommends that you use gasolines with these blending materials, such as MTBE and ethanol. By doing so, you can help clean the air, especially in those parts of the country that have high carbon monoxide levels.

In addition, some gasoline suppliers are now producing reformulated gasolines. These gasolines are specially designed to reduce vehicle emissions. General Motors recommends that you use reformulated gasoline. By doing so, you can help clean the air, especially in those parts of the country that have high ozone levels.

You should ask your service station operators if their gasolines contain deposit control additives and oxygenates, and if they have been reformulated to reduce vehicle emissions.

Service and Appearance Care

Fuels in Foreign Countries

If you plan on driving in another country outside the U.S. or Canada, unleaded fuel may be hard to find. Do not use leaded gasoline. If you use even one tankful, your emission controls won't work well or at all. With continuous use, spark plugs can get fouled, the exhaust system can corrode, and your engine oil can deteriorate quickly. Your vehicle's oxygen sensor will be damaged. All of that means costly repairs that wouldn't be covered by your warranty.

To check on fuel availability, ask an auto club, or contact a major oil company that does business in the country where you'll be driving.

You can also write us at the following address for advice. Just tell us where you're going and give your Vehicle Identification Number (VIN).

General Motors Overseas Distribution Corporation
North American Export Sales (NAES)
1908 Colonel Sam Drive
Oshawa, Ontario L1H 8P7



Filling Your Tank



CAUTION:

Gasoline vapor is highly flammable. It burns violently, and that can cause very bad injuries. Don't smoke if you're near gasoline or refueling your vehicle. Keep sparks, flames, and smoking materials away from gasoline.

The cap is under a hinged door on the rear of your vehicle.

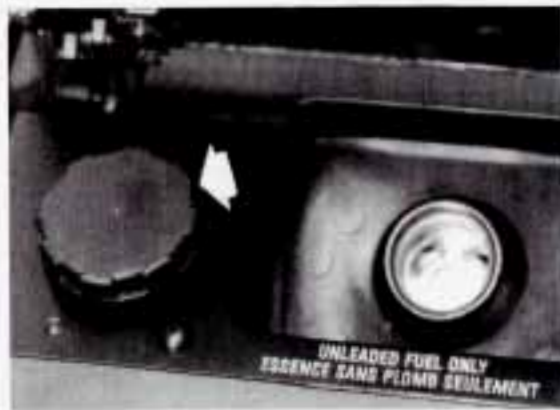

While refueling, place the cap in the indent to the left of the filler neck.

To take off the cap, turn it slowly to the left (counterclockwise).



CAUTION:

If you get gasoline on you and then something ignites it, you could be badly burned. Gasoline can spray out on you if you open the fuel filler cap too quickly. This spray can happen if your tank is nearly full, and is more likely in hot weather. Open the fuel filler cap slowly and wait for any "hiss" noise to stop. Then unscrew the cap all the way.

Be careful not to spill gasoline. Clean gasoline from painted surfaces as soon as possible. See "Cleaning the Outside of Your Corvette" in the Index.

When you put the cap back on, turn it to the right until you hear at least three clicks.

NOTICE:

If you need a new cap, be sure to get the right type. Your dealer can get one for you. If you get the wrong type, it may not fit or have proper venting, and your fuel tank and emissions system might be damaged.

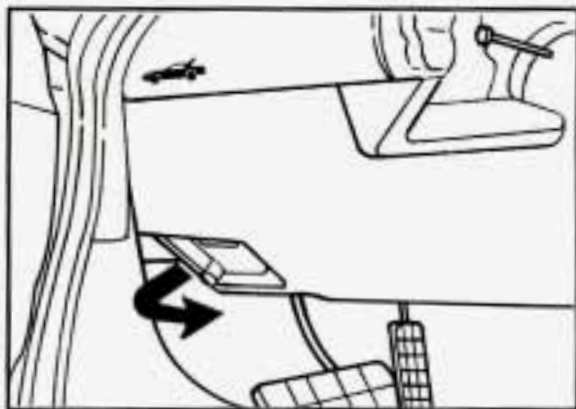

■ *Checking Things under the Hood*

Hood Release

To open the hood, first pull the handle inside the vehicle.

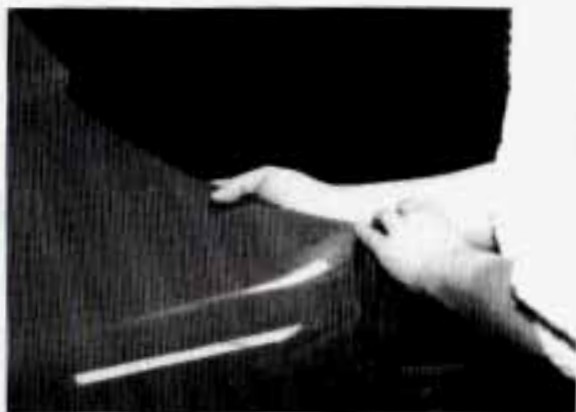

Then go to the side of the vehicle and pull up on the rear edge of the hood, near the windshield.



CAUTION:

An electric fan under the hood can start up and injure you even when the engine is not running. Keep hands, clothing and tools away from any underhood electric fan.

Service and Appearance Care

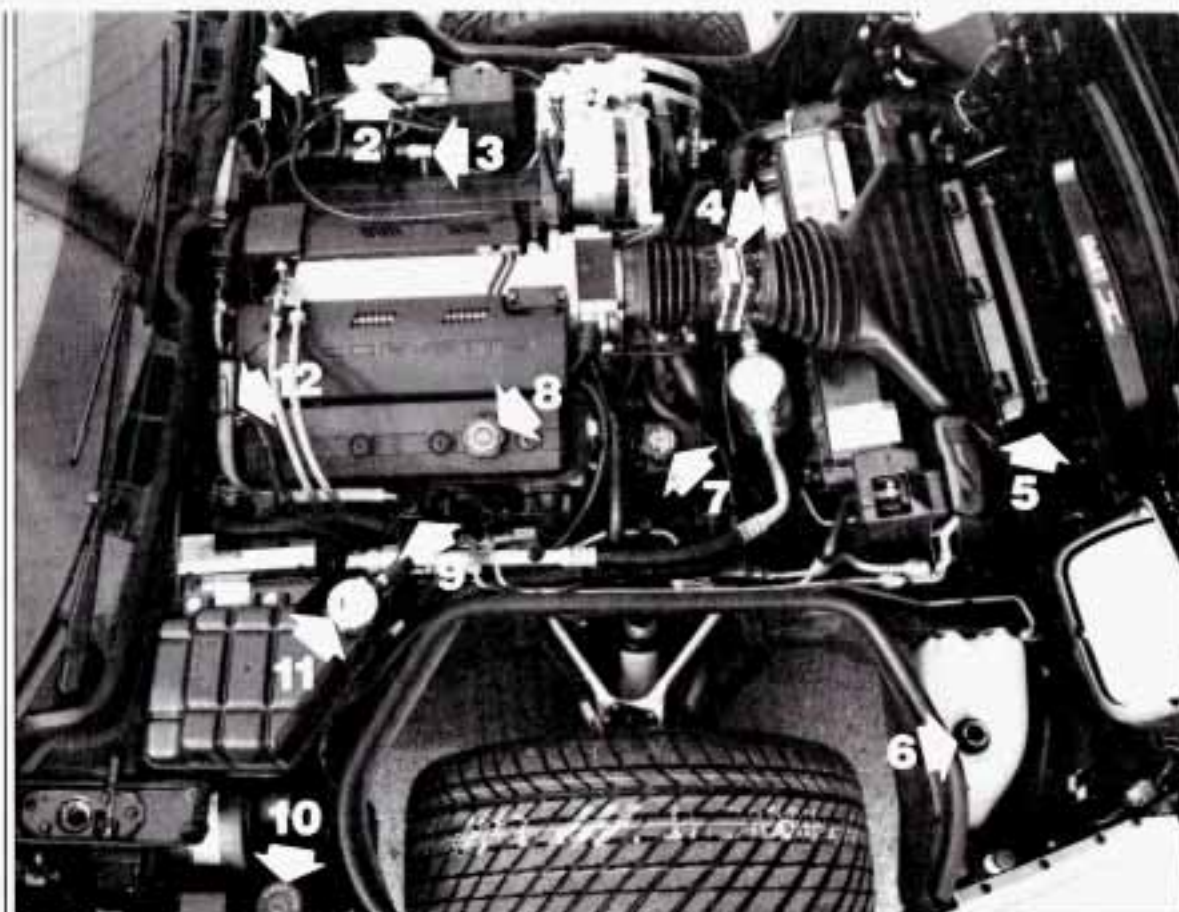

5.7L I4 (Code P)

When you open the hood, you'll see:

- | | |
|---|--------------------------|
| 1. Hydraulic Clutch Fluid Reservoir (if equipped) | 3. Battery |
| 2. Brake Fluid Reservoir | 4. Electrical Engine Fan |
| | 5. Air Cleaner |



CAUTION:

Things that burn can get on hot engine parts and start a fire. These include liquids like gasoline, oil, coolant, brake fluid, windshield washer and other fluids, and plastic or rubber. You or others could be burned. Be careful not to drop or spill things that will burn onto a hot engine.

Before closing the hood, be sure all the filler caps are on.

- | |
|---|
| 6. Coolant Recovery Tank |
| 7. Power Steering Fluid Reservoir |
| 8. Engine Oil Fill Cap |
| 9. Engine Oil Dipstick |
| 10. Windshield Washer Fluid Reservoir |
| 11. Coolant High Fill Reservoir |
| 12. Automatic Transmission Dipstick (if equipped) |

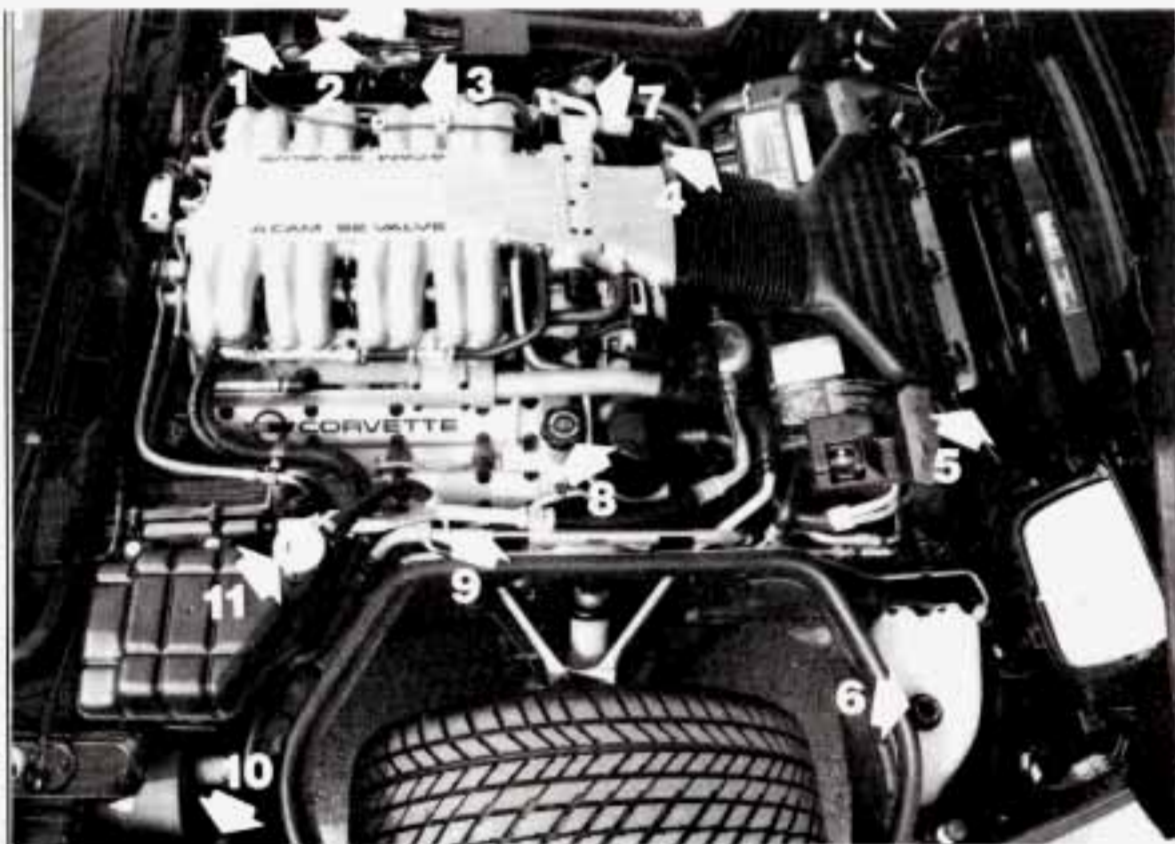

5.7L LT5 (Code J)

When you open the hood, you'll see:

- | | |
|-------------------------------------|-----------------------------------|
| 1. Hydraulic Clutch Fluid Reservoir | 5. Air Cleaner |
| 2. Brake Fluid Reservoir | 6. Coolant Recovery Tank |
| 3. Battery | 7. Power Steering Fluid Reservoir |
| 4. Electric Engine Fan | 8. Engine Oil Fill Cap |



CAUTION:

Things that burn can get on hot engine parts and start a fire. These include liquids like gasoline, oil, coolant, brake fluid, windshield washer and other fluids, and plastic or rubber. You or others could be burned. Be careful not to drop or spill things that will burn onto a hot engine.

Before closing the hood, be sure all the filler caps are on.

- | |
|---------------------------------------|
| 9. Engine Oil Dipstick |
| 10. Windshield Washer Fluid Reservoir |
| 11. Coolant High Fill Reservoir |

Service and Appearance Care

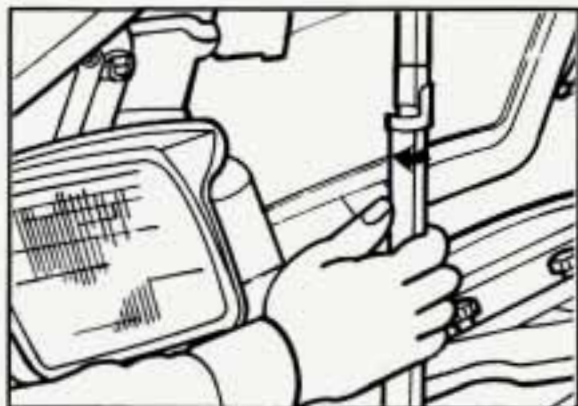

Then release the hood strut by moving it to the centered position and lowering the hood. Lower the hood until it is about 12 inches (300 mm) above the engine, then release it.

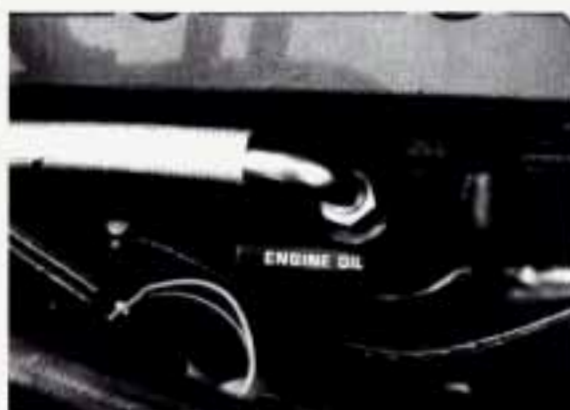

5.7L LT1 (Code P)

Engine Oil

If you have the LT1 engine, it's a good idea to check your engine oil level every time you get fuel. In order to get an accurate reading, the oil must be warm and the vehicle must be on level ground. Turn off the engine and give the oil a few minutes to drain back into the oil pan. If you don't, the oil dipstick might not show the actual level.



5.7L LT5 (Code J)

If you have the LT5 engine, the best time to check your engine oil is when the engine is cold. If you run the engine, the engine oil won't drain back into the pan fast enough. Give the oil two hours to drain back into the oil pan. If you don't, the oil dipstick might not show the actual level.

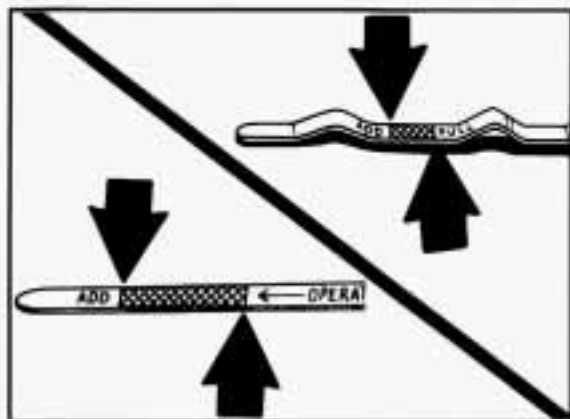

To Check Engine Oil

Pull out the dipstick and clean it with a paper towel or cloth, then push it back in all the way. Remove it again, keeping the tip lower.



5.7L LT1 (Code P)

When to Add Oil:

If the oil is at or below the “ADD” mark, you’ll need to add some oil. But you must use the right kind. This section explains what kind of oil to use. For crankcase capacity, see “Capacities and Specifications” in the Index.

NOTICE:

Don't add too much oil. If your engine has so much oil that the oil level gets above the upper mark that shows the proper operating range, your engine could be damaged.



5.7L LT5 (Code J)

Just fill it enough to put the level somewhere in the proper operating range. Push the dipstick all the way back in when you're through.

What Kind of Oil to Use

Look for two things:

- GM4718M

The Corvette engine requires a special oil meeting GM Standard GM4718M. Oils meeting this Standard may be identified as synthetic. However, not all SYNTHETIC oils will meet this GM Standard. You should look for and use only an oil that meets GM Standard GM4718M.

Service and Appearance Care

NOTICE:

If you use oils that don't have the GM4718M Standard designation, you can cause engine damage not covered by your warranty.

- SAE 5W-30

As shown in the viscosity chart, SAE 5W-30 is best for your vehicle. However, you can use SAE 10W-30 if it's going to be 0°F (-18°C) or above.

These numbers on an oil container show its viscosity, or thickness. Do not use other viscosity oils such as SAE 20W-50.

Recommended SAE Viscosity Grade Engine Oils

For best fuel economy and cold starting, select the lowest SAE viscosity grade oil for the expected temperature range.

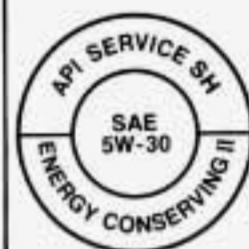
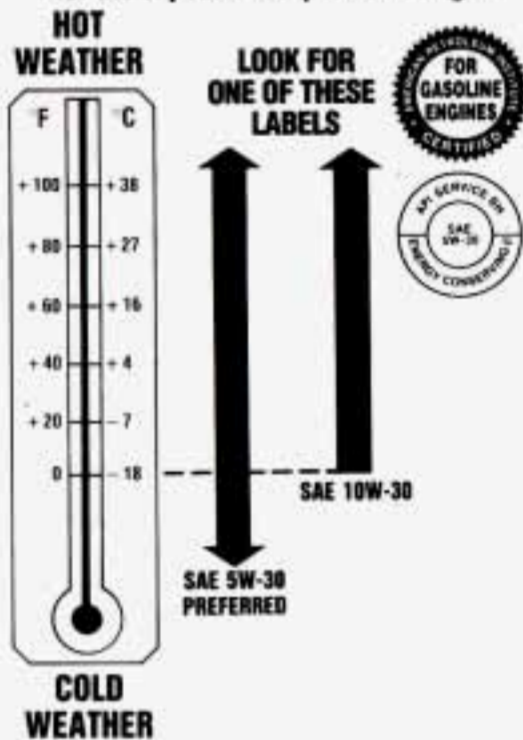

Oils meeting these requirements should also have either one or both of these symbols on the container.

You should look for these on the oil container, and use only those oils that are identified as meeting GM Standard 4718M and have either the “starburst” symbol or the API doughnut symbol with either the SH or the SG designation.

Your Corvette engine is filled at the factory with a Mobil 1[®] synthetic oil, which meets all requirements for your vehicle.

Substitute Oil (LT1 Only): When adding oil to maintain engine oil level, if an oil meeting GM Standard GM4718M is not available, you can use oil designated either SAE 5W-30 API Service SH or SG at all temperatures, or SAE 10W-30 API Service SH or SG at temperatures above 0°F (-18°C). This oil should not be used for an oil change.

Substitute Oil (LT5 Only): When adding oil to maintain engine oil level, if an oil meeting GM Standard GM4718M is not available, you can use oil designated SAE 10W-30 API Service SH or SG at all temperatures. This oil should not be used for an oil change.

Engine Oil Additives

Don't add anything to your oil. Your Chevrolet dealer is ready to advise if you think something should be added.

When to Change Engine Oil

See if any one of these is true for you:

- Most trips are less than 4 miles (6 km).
- It's below freezing outside and most trips are less than 10 miles (16 km).

- The engine is at low speed most of the time (as in stop-and-go traffic).
- Most trips are through dusty places.

If any one of these is true for your vehicle, you need to change your oil and filter every 3,000 miles (5 000 km) or 3 months — whichever comes first. (See "Engine Oil Life Monitor" in the Index.)

If none of them is true, change the oil every 7,500 miles (12 500 km) or 12 months — whichever comes first. Change the filter at the first oil change and at every other oil change after that. (See "Engine Oil Life Monitor" in the Index.)

Engine Coolant Heater (Engine Block Heater)

An engine coolant heater can be a big help if you have to park outside in very cold weather, 0°F (-18°C) or colder. If your vehicle has this feature, see "Engine Coolant Heater" in the Index.

What to Do with Used Oil

Did you know that used engine oil contains certain elements that may be unhealthy for your skin and could even cause cancer? Don't let used oil stay on

your skin for very long. Clean your skin and nails with soap and water, or a good hand cleaner. Wash or throw away clothing or rags containing used engine oil. (See the manufacturer's warnings about the use and disposal of oil products.)

Used oil can be a real threat to the environment. If you change your own oil, be sure to drain all free-flowing oil from the filter before disposal. Don't ever dispose of oil by putting it in the trash, pouring it on the ground, into sewers, or into streams or bodies of water. Instead, recycle it by taking it to a place that collects used oil. If you have a problem properly disposing of your used oil, ask your dealer, a service station or a local recycling center for help.

Service and Appearance Care

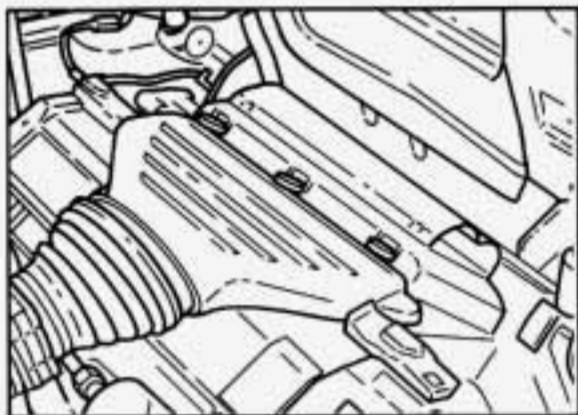

5.7L I/T1 (Code P)

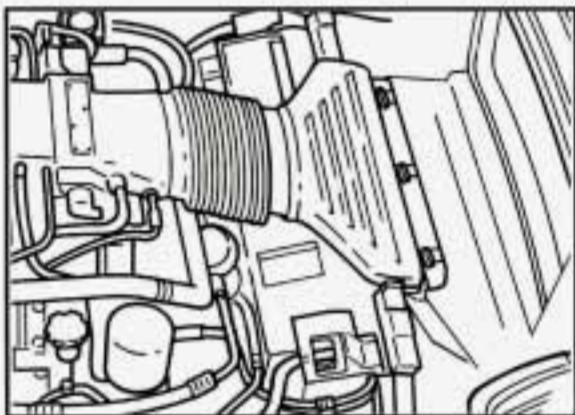

5.7L I/T5 (Code J)

Air Cleaner

Refer to the Maintenance Schedule to determine when to replace the air filter. See "Scheduled Maintenance Services" in the Index.



CAUTION:

Operating the engine with the air cleaner off can cause you or others to be burned. The air cleaner not only cleans the air, it stops flame if the engine backfires. If it isn't there, and the engine backfires, you could be burned. Don't drive with it off, and be careful working on the engine with the air cleaner off.

NOTICE:

If the air cleaner is off, a backfire can cause a damaging engine fire. And, dirt can easily get into your engine, which will damage it. Always have the air cleaner in place when you're driving.

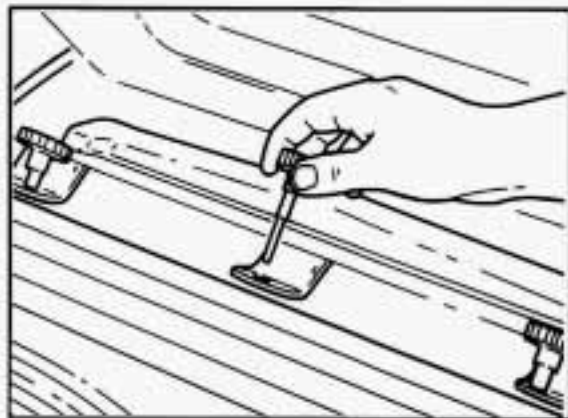

Air Filter Replacement

To remove the air filter:

1. Unscrew the three knobs.

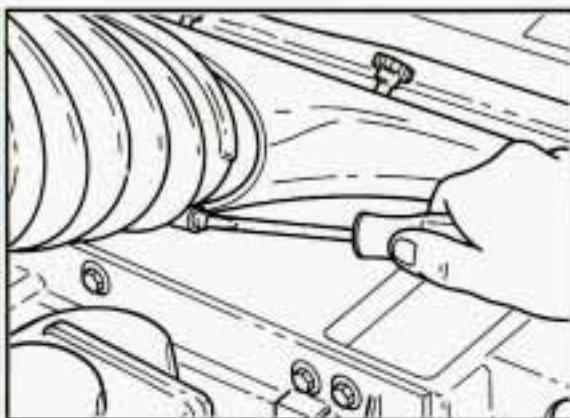

2. Disconnect the clamp from the manifold.



3. Pull the air cleaner straight up.
4. Open the air cleaner and remove the filter.

Service and Appearance Care

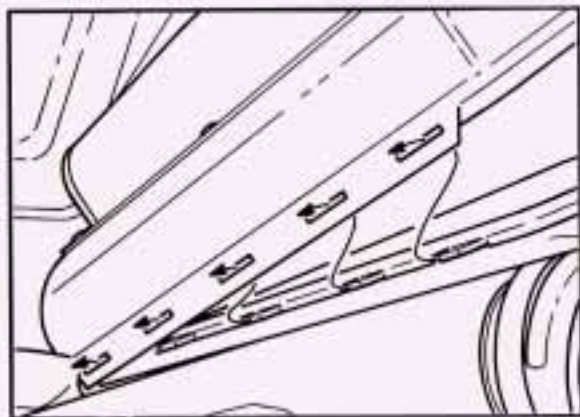

- Reverse the steps.
 - Align the tabs to the slots in the bottom of the assembly before you replace it.
 - Install the short knob into the middle hole first. Then install the longer knobs into the outer holes.

Automatic Transmission Fluid

When to Check and Change

A good time to check your automatic transmission fluid level is when the engine oil is changed. Refer to the Maintenance Schedule to determine when to change your fluid. See "Scheduled Maintenance Services" in the Index.

How to Check

Because this operation can be a little difficult, you may choose to have this done at a Chevrolet dealership Service Department.

If you do it yourself, be sure to follow all the instructions here, or you could get a false reading on the dipstick.

NOTICE:

Too much or too little fluid can damage your transmission. Too much can mean that some of the fluid could come out and fall on hot engine parts or exhaust system, starting a fire. Be sure to get an accurate reading if you check your transmission fluid.

Wait at least 30 minutes before checking the transmission fluid level if you have been driving:

- When outside temperatures are above 90°F (32°C).
- At high speed for quite a while.
- In heavy traffic — especially in hot weather.

To get the right reading, the fluid should be at normal operating temperature, which is 180°F to 200°F (82°C to 93°C).

To check transmission fluid hot: Get the vehicle warmed up by driving about 15 miles (24 km) when outside temperatures are above 50°F (10°C). If it's colder than 50°F (10°C), drive the vehicle in "D" (Third Gear) until the engine temperature gage moves and then remains steady for ten minutes. Then follow the hot check procedures.

To check transmission fluid cold: A cold check is made after the vehicle has been sitting for eight hours or more with the engine off and is used only as a reference. Let the engine run at idle for five minutes if outside temperatures are 50°F (10°C) or more. If it's colder than 50°F (10°C), you may have to idle the engine longer. Should the fluid level be low during a

cold check, you must perform a hot check before adding fluid. This will give you a more accurate reading of the fluid level.

To check the fluid hot or cold

- Park your vehicle on a level place.
- With the parking brake applied, place the shift lever in "P" (Park).
- With your foot on the brake pedal, move the shift lever through each gear range, pausing for about three seconds in each range. Then, position the shift lever in "P" (Park).
- Let the engine run at idle for three minutes or more.



Then, without shutting off the engine, follow these steps:

1. Pull out the dipstick and wipe it with a clean rag or paper towel.
2. Push it back in all the way, wait three seconds and then pull it back out again.

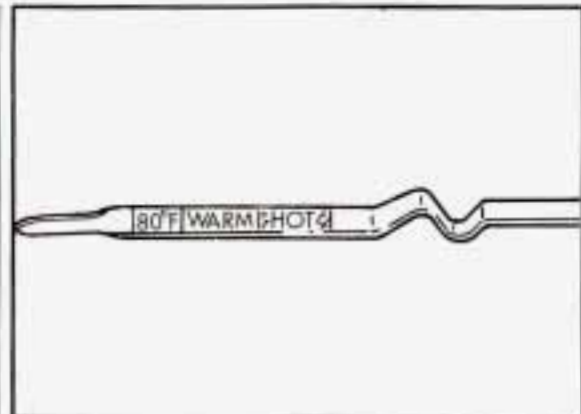

3. Check both sides of the dipstick, and read the lower level. The fluid level must be in the cold area for a cold check or in the "HOT" area or cross-hatched area for a hot check.
4. If the fluid level is in the acceptable range, push the dipstick back in all the way.

How to Add Fluid

Refer to the Maintenance Schedule to determine what kind of transmission fluid to use. See "Recommended Fluids and Lubricants" in the Index.

If the fluid level is low, add only enough of the proper fluid to bring the level up to the cold area for a cold check or the "HOT" area for a hot check. It doesn't

Service and Appearance Care

take much fluid, generally less than a pint. Don't overfill. We recommend you use only fluid labeled DEXRON®-III or DEXRON®-IIE, because fluids with that label are made especially for your automatic transmission. Damage caused by fluid other than DEXRON®-III or DEXRON®-IIE is not covered by your new vehicle warranty.

- After adding fluid, recheck the fluid level as described under "How to Check."
- When the correct fluid level is obtained, push the dipstick back in all the way.

Manual Transmission Fluid

How to Check:

Because this operation can be difficult, you may choose to have this done at a Chevrolet dealership Service Department. If you do it yourself, be sure to follow all the instructions here, or you could get a false reading.

NOTICE:

Too much or too little fluid can damage your transmission. Too much can mean that some of the fluid could come out and fall on hot engine parts or exhaust system, starting a fire. Be sure to get an accurate reading if you check your transmission fluid.

Check the fluid level only when your engine is off, the vehicle is parked on a level place and the transmission is cool enough for you to rest your fingers on the transmission case.



Then, follow these steps:

1. Remove the filler plug.
2. Check that the lubricant level is up to the bottom of the filler plug hole.
3. If the fluid level is good, install the plug and be sure it is fully seated. If the fluid level is low, add more fluid as described in the next steps.

How to Add Fluid:

Here's how to add fluid. Refer to the Maintenance Schedule to determine what kind of fluid to use. See "Recommended Fluids and Lubricants" in the Index.

1. Remove the filler plug.

2. Add fluid at the filler plug hole. Add only enough fluid to bring the fluid level up to the bottom of the filler plug hole.
3. Install the filler plug. Be sure the plug is fully seated.

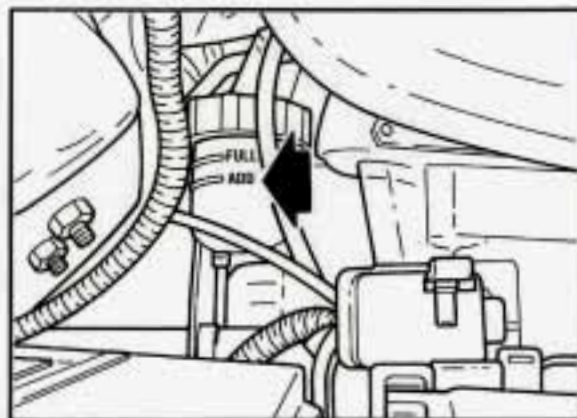

Hydraulic Clutch

The clutch linkage in your vehicle is self-adjusting. The clutch master cylinder reservoir is filled with hydraulic clutch fluid.

It isn't a good idea to "top off" your clutch fluid. Adding fluid won't correct a leak.

A fluid loss in this system could indicate a problem. Have the system inspected and repaired.

When to Check and What to Use

Refer to the Maintenance Schedule to determine how often you should check the fluid level in your clutch master cylinder reservoir and for the proper fluid.

See "Owner Checks and Services" and "Recommended Fluids and Lubricants" in the Index.

How to Check and Add Fluid

The clutch master cylinder is under the Engine Control Module (ECM) in the left rear area of the engine compartment.

To check the fluid, look at the area between the ECM and the battery.

To add fluid, remove the ECM unit.

Service and Appearance Care

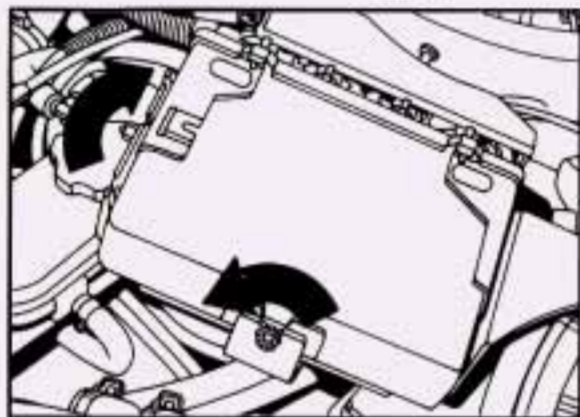

Remove the nut on the outboard side of the unit. Then loosen the front and inboard nuts. For the LT5 engine, loosen the two inboard nuts. Move the ECM unit to either side.

Fluid should be added if the fluid level is at or below the "ADD" mark on the reservoir. There are additional instructions on the reservoir cap.

When returning the ECM to its proper position, make sure the bolts are aligned with the slots in the bracket. Then gently push down on the unit. When replacing the unit, be careful not to over-tighten the nuts – just tighten them until they are snug.

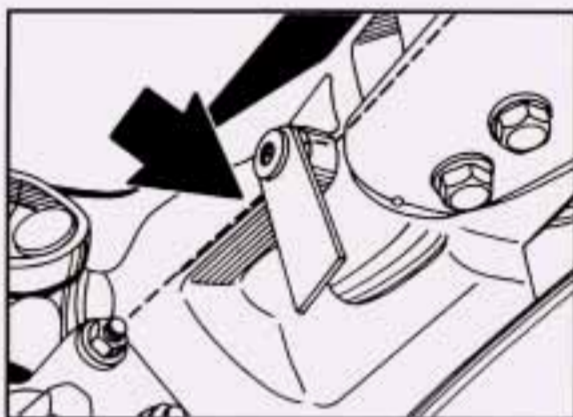

Rear Axle

When to Check Lubricant

Refer to the Maintenance Schedule to determine how often to check the lubricant. See "Periodic Maintenance Inspections" in the Index.

How to Check Lubricant

If the level is below the bottom of the filler plug hole, you'll need to add some lubricant. Add enough lubricant to raise the level to the bottom of the filler plug hole.

What to Use:

To add lubricant when the level is low, use Axle Lubricant (GM Part No. 12345977) or SAE 80W-90 GL-5 gear lubricant. To completely refill after draining, add 4 ounces (118 ml) of Limited-Slip Differential Lubricant Additive (GM Part No. 1052358). Then fill to the bottom of the filler plug hole with Axle Lubricant (GM Part No. 12345977) or SAE 80W-90 GL-5 gear lubricant.

Engine Coolant

The following explains your cooling system and how to add coolant when it is low. If you have a problem with engine overheating or if you need to add coolant to your high fill reservoir, see "Engine Overheating" in the Index.

The proper coolant for your Corvette will:

- Give freezing protection down to -34°F (-37°C).
- Give boiling protection up to 262°F (128°C).
- Protect against rust and corrosion.
- Help keep the proper engine temperature.
- Let the warning lights work as they should.

What to Use:

Use a mixture of one-half clean water (preferably distilled) and one-half antifreeze that meets "GM Specification 1825-M," which won't damage aluminum parts. You can also use a recycled coolant conforming to GM Specification 1825-M with a complete coolant flush and refill. If you use this mixture, you don't need to add anything else.

CAUTION:

Adding only plain water to your cooling system can be dangerous. Plain water, or some other liquid like alcohol, can boil before the proper coolant mix will. Your vehicle's coolant warning system is set for the proper coolant mix. With plain water or the wrong mix, your engine could get too hot but you wouldn't get the overheat warning. Your engine could catch fire and you or others could be burned. Use a 50/50 mix of clean water and a proper antifreeze.

NOTICE:

If you use an improper coolant mix, your engine could overheat and be badly damaged. The repair cost wouldn't be covered by your warranty. Too much water in the mix can freeze and crack the engine, radiator, heater core and other parts.

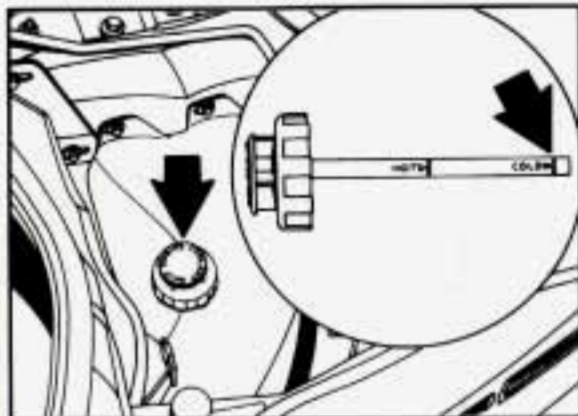

Adding Coolant

To Check Coolant When your engine is cold, check the dipstick on the cap of the coolant recovery tank. The coolant level should be at "COLD," or a little higher. When your engine is warm, the level on the dipstick should be up to "HOT," or a little higher.

Your Corvette also has a coolant high fill reservoir located at the right rear of the engine compartment.

Service and Appearance Care

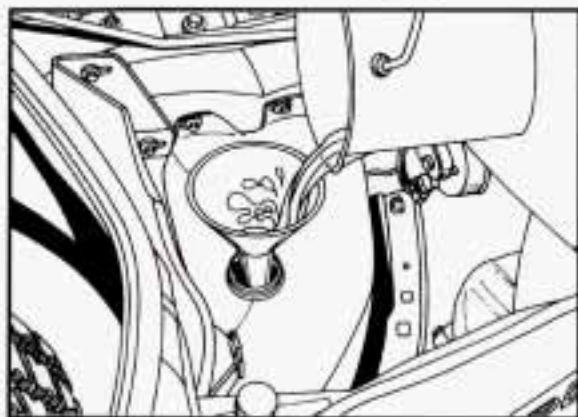

If you need to add more coolant, add the proper mix at the coolant recovery tank, but only when your engine is cool. If the tank is very low or empty, also add coolant to the coolant high fill reservoir. See "Engine Overheating" in the Index for information.



CAUTION:

Turning the coolant high fill reservoir pressure cap when the engine and radiator are hot can allow steam and scalding liquids to blow out and burn you badly. Never turn the pressure cap – even a little – when the engine and radiator are hot.

Add coolant mix at the recovery tank, but be careful not to spill it.

NOTICE:

You can be burned if you spill coolant on hot engine parts. Coolant contains ethylene glycol, and it will burn if the engine parts are hot enough. Don't spill coolant on a hot engine.

For complete drain, flush and refill of the engine, contact your Chevrolet dealer or the procedure may be found in a Chevrolet Corvette Service Manual. To purchase a service manual, see "Service Publications" in the Index.

Thermostat

Engine coolant temperature is controlled by a thermostat in the engine coolant system. The thermostat stops the flow of coolant through the radiator until the coolant reaches a preset temperature. When you replace your thermostat, an AC[®] thermostat is recommended.



5.7L LT1 (Code P)

Power Steering Fluid

How to Check Power Steering Fluid:

Unscrew the cap and wipe the dipstick with a clean rag. Replace the cap and completely tighten it.



5.7L LT5 (Code J)

Then remove the cap again and look at the fluid level on the dipstick.

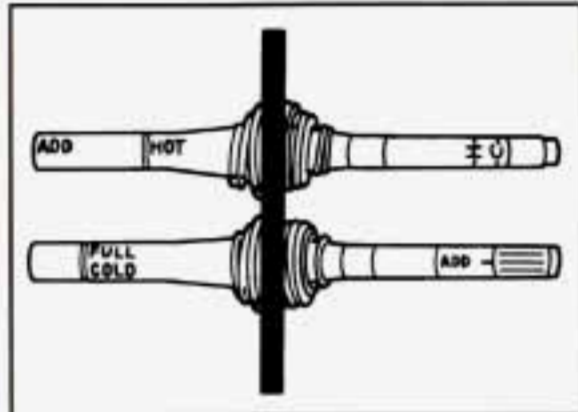

- When the engine compartment is hot, the level should be at the "HOT" or "H" mark.
- When the engine compartment is cool, the level should be at the "COLD" or "C" mark.

What to Add:

Refer to the Maintenance Schedule to determine what kind of fluid to use. See "Recommended Fluids and Lubricants" in the Index.

Service and Appearance Care

NOTICE:

When adding power steering fluid or making a complete fluid change, always use the proper fluid. Failure to use the proper fluid can cause leaks and damage hoses and seals.

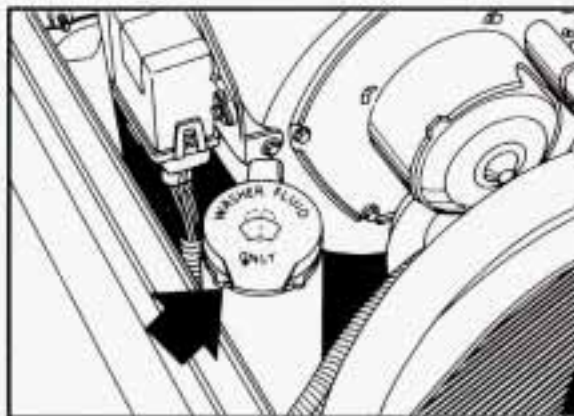

Windshield Washer Fluid

To Add:

Open the cap labeled "WASHER FLUID ONLY." Add washer fluid until the bottle is full.

NOTICE:

- When using concentrated washer fluid, follow the manufacturer's instructions for adding water.
- Don't mix water with ready-to-use washer fluid. Water can cause the solution to freeze and damage your washer fluid tank and other parts of the washer system. Also, water doesn't clean as well as washer fluid.
- Fill your washer fluid tank only 3/4 full when it's very cold. This allows for expansion, which could damage the tank if it is completely full.
- Don't use radiator antifreeze in your windshield washer. It can damage your washer system and paint.

Brake Master Cylinder

Your brake master cylinder is here. It is filled with DOT-3 brake fluid.

There are only two reasons why the brake fluid level in your master cylinder might go down. The first is that the brake fluid goes down to an acceptable level during normal brake lining wear. When new linings are put in, the fluid level goes back up. The other reason is that fluid is leaking out of the brake system. If it is, you should have your brake system fixed, since a leak means that sooner or later your brakes won't work well, or won't work at all.

So, it isn't a good idea to "top off" your brake fluid. Adding brake fluid won't correct a leak. If you add fluid when your linings are worn, then you'll have too much fluid when you get new brake linings. You should add (or remove) brake fluid, as necessary, only when work is done on the brake hydraulic system.



CAUTION:

If you have too much brake fluid, it can spill on the engine. The fluid will burn if the engine is hot enough. You or others could be burned, and your vehicle could be damaged. Add brake fluid only when work is done on the brake hydraulic system.

When your brake fluid falls to a low level, your brake warning light, "SERVICE ABS" light and "SERVICE ASR" light will come on. Also, the anti-lock brake and Acceleration Slip Regulation systems are disabled. See "Brake System Warning Light" in the Index.



What to Add:

When you do need brake fluid, use only DOT-3 brake fluid — such as Delco-Supreme 11® (GM Part No. 1052535). Use new brake fluid from a sealed container only, and always clean the brake fluid reservoir cap before removing it.

Service and Appearance Care

NOTICE:

- Don't let someone put in the wrong kind of fluid. For example, just a few drops of mineral-based oil, such as engine oil, in your brake system can damage brake system parts so badly that they'll have to be replaced.
- Brake fluid can damage paint, so be careful not to spill brake fluid on your vehicle. If you do, wash it off immediately. See "Appearance Care" in the Index.

Brake Wear

Your Corvette has four-wheel disc brakes. Disc brake pads have built-in wear indicators that make a high-pitched warning sound when the brake pads are worn and new pads are needed. The sound may come and go or be heard all the time your vehicle is moving (except when you are pushing on the brake pedal firmly).



CAUTION:

The brake wear warning sound means that sooner or later your brakes won't work well. That could lead to an accident. When you hear the brake wear warning sound, have your vehicle serviced.

NOTICE:

Continuing to drive with worn-out brake pads could result in costly brake repair.

Some driving conditions or climates may cause a brake squeal when the brakes are first applied or lightly applied. This does not mean something is wrong with your brakes. Brake linings should always be replaced as complete axle sets.

Brake Pedal Travel

See your dealer if the brake pedal does not return to normal height, or if there is a rapid increase in pedal travel. This could be a sign of brake trouble.

Brake Adjustment

As you make brake stops, your disc brakes automatically adjust for wear.

Replacing Brake System Parts

The braking system on a modern vehicle is complex. Its many parts have to be of top quality and work well together if the vehicle is to have really good braking. Vehicles we design and test have top-quality GM brake parts in them, as your Corvette does when it is new. When you replace parts of your braking system — for example, when your brake linings wear down and you have to have new ones put in — be sure you get new genuine GM replacement parts. If you don't, your brakes may no longer work properly. For example, if someone puts in brake linings that are wrong for your vehicle, the balance between your front and rear brakes can change, for the worse. The braking performance you've come to expect can change in many other ways if someone puts in the wrong replacement brake parts.

Battery

Every new Corvette has a Delco Freedom® battery. You never have to add water to one of these. When it's time for a new battery, we recommend a Delco Freedom® battery. Get one that has the catalog number shown on the original battery's label. For battery replacement, see your dealer or the Corvette Service Manual. To purchase a service manual, see "Service Publications" in the Index.

Vehicle Storage

If you're not going to drive your vehicle for 25 days or more, take off the black, negative (-) cable from the battery. This will help keep your battery from running down.

CAUTION:

Batteries have acid that can burn you and gas that can explode. You can be badly hurt if you aren't careful. See "Jump Starting" in the Index for tips on working around a battery without getting hurt.

Contact your dealer to learn how to prepare your vehicle for longer storage periods.

■ Bulb Replacement

For the proper type of replacement bulb, see "Replacement Bulbs" in the Index.

Halogen Bulbs

CAUTION:

Halogen bulbs have pressurized gas inside and can burst if you drop or scratch the bulb. You or others could be injured. Take special care when handling and disposing of halogen bulbs.

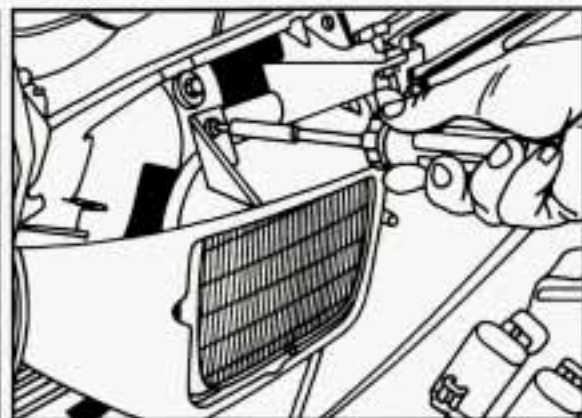

Headlight

1. Open the hood.
2. The headlights need to be halfway open. Turn the headlight switch on, then quickly back to the parking lights setting. You may have to do this a few times to get the half-open position. You can also open the headlights manually. See "Concealed Headlights" in the Index.
3. Remove the two screws on each side of the headlight.

Service and Appearance Care

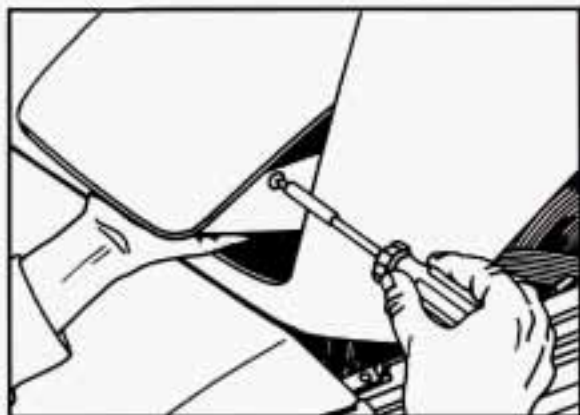

4. Remove the two screws from both sides of the cover. Before you remove the last screw, put your hand under the cover to hold it.
5. Reach around the hood and pull the cover straight out. Be careful not to scratch the paint.

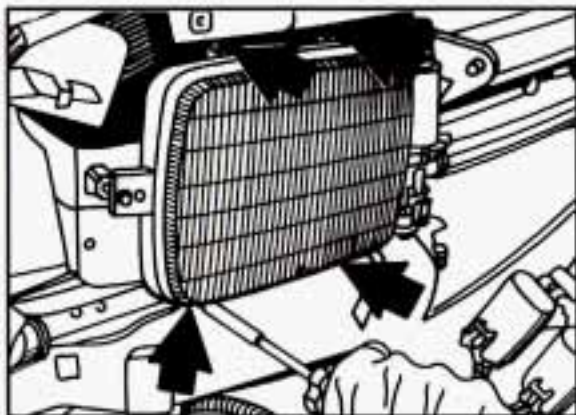

6. Remove the four screws from the retainer near each corner of the headlight. Don't move the large-head adjusting screws or your headlight will not be aimed properly.
7. Hold the headlight and remove the retainer.
8. Remove the headlight and unplug the electrical connector.
9. Reverse the steps with a new headlight.

Fog Lamp

You can reach the fog lamps from under the front bumper.

1. Remove the screw in the access door. Open the door.
2. Turn the bulb base counterclockwise 1/8 turn and pull it out.
3. Disconnect the bulb base from the wiring harness.
4. Reverse the steps with a new bulb.

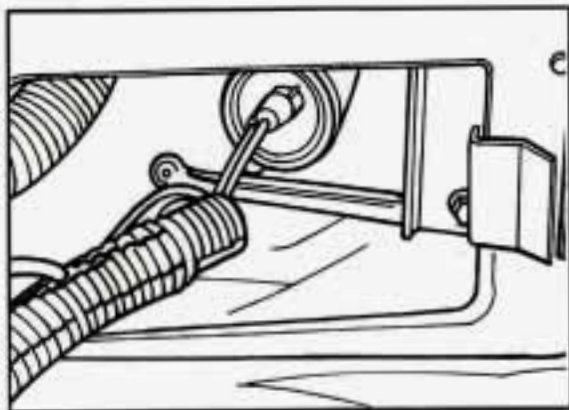

Front Turn Signal

1. Open the hood.
2. Find the socket at the front of the engine compartment.
3. Turn the socket counterclockwise 1/4 turn and pull it out.

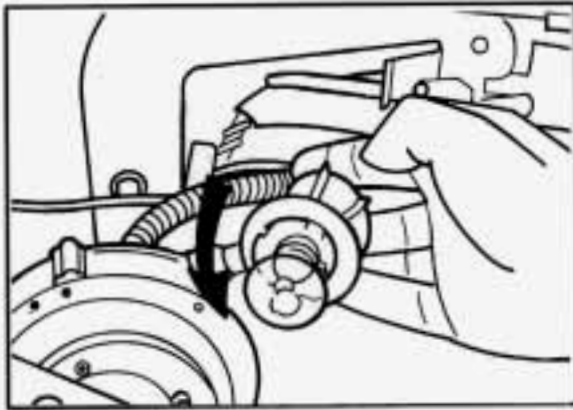

4. Push the bulb in, turn it counterclockwise, then pull it out.
5. Reverse the steps with a new bulb. The socket has three large tabs and one small tab. Be sure to line up the small tab with the small notch in the housing.

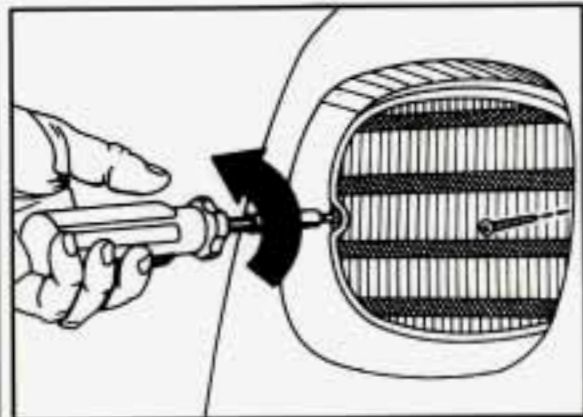

Rear Turn Signal and Taillight

1. Remove the screws.

Service and Appearance Care

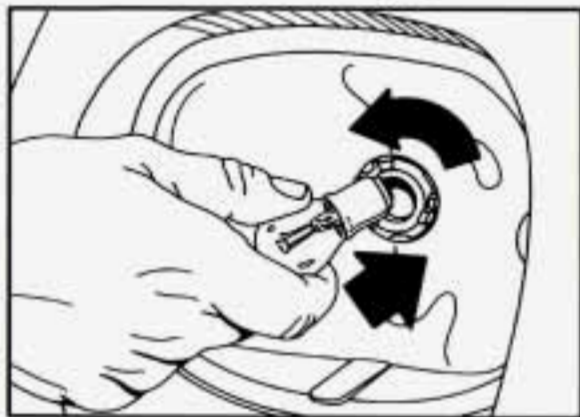

2. Pull the lens out.
3. Push the bulb in, turn it counterclockwise, then pull it out.
4. Reverse the steps with a new bulb. To prevent water from getting inside the lens, make sure the lens seal is properly positioned.



Back-up Light

You can reach the back-up lights by removing the license plate and reaching through the opening.

1. Push the tab on the socket and turn it counterclockwise.

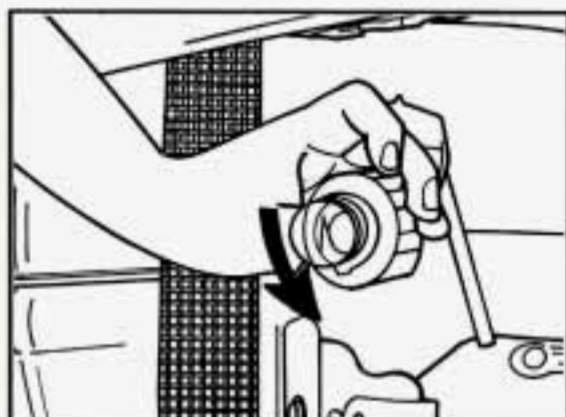

2. Push the bulb in, turn it counterclockwise, then pull it out.
3. Reverse the steps with a new bulb.

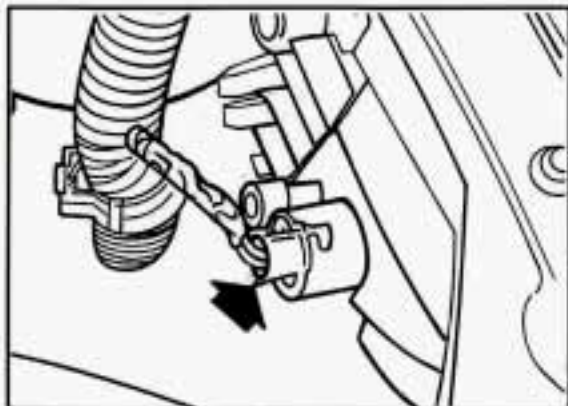

Sidemarker

You can reach the front sidemarker from inside the engine compartment.

Reach the rear sidemarker from under the vehicle.

1. Turn the socket counterclockwise 1/4 turn and pull it out.

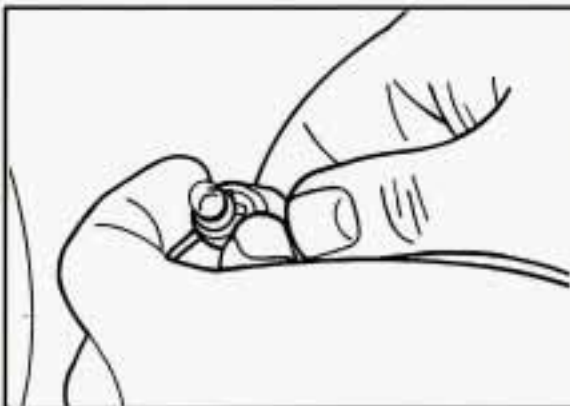

2. Pull the bulb straight out.
3. Reverse the steps with a new bulb.

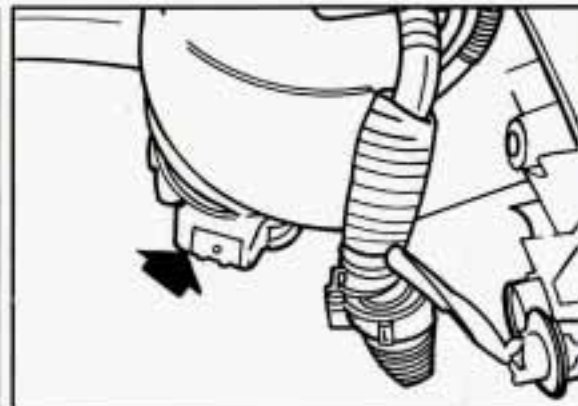

Cornering Light

You can reach the front cornering light from inside the engine compartment.

Reach the rear cornering light from under the vehicle.

1. Press the tab on the socket, turn it counterclockwise 1/4 turn and pull it out.

Service and Appearance Care

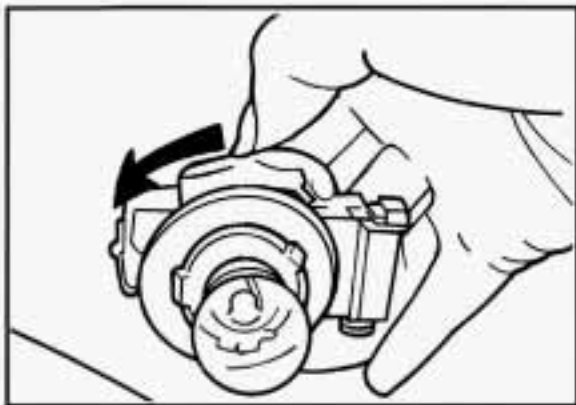

2. Push the bulb in, turn it counterclockwise, then pull it out.
3. Reverse the steps with a new bulb.

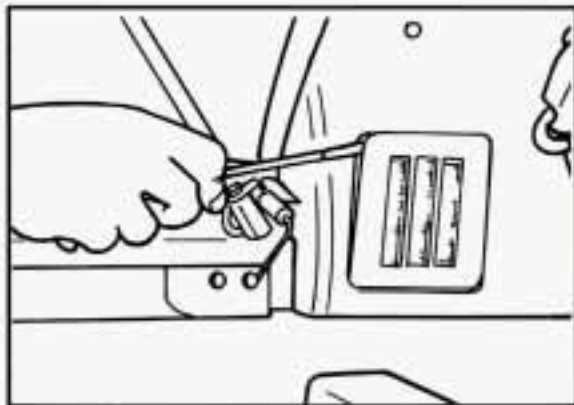

Rear Cargo Compartment Light (Coupe)

1. Pry the cover off with a screwdriver. Be sure to pry from the rear side, or you could break the tab on the cover.
2. Remove the bulb.
3. Reverse the steps with a new bulb.

Rear Cargo Compartment Light (Convertible)

1. Pry the cover off with a screwdriver.
2. Remove the bulb.
3. Reverse the steps with a new bulb.

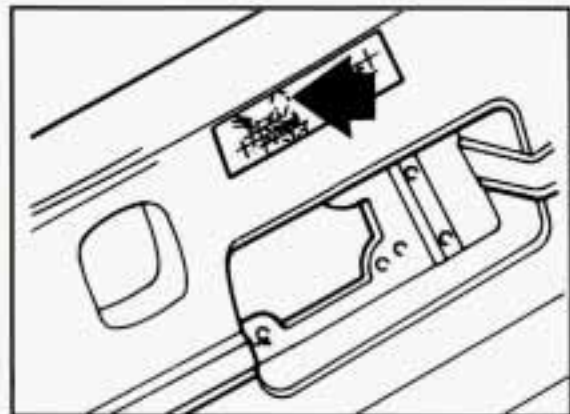

Center High-Mounted Stoplight (Except ZR-1)

You can reach the center high-mounted stoplight by removing the license plate and reaching through the opening.

1. Turn the socket counterclockwise 1/4 turn and pull it out.

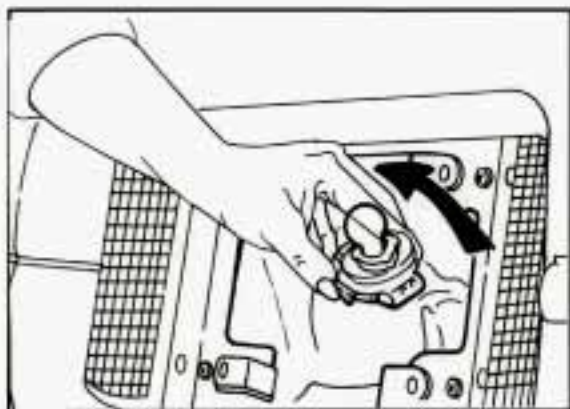

2. Push the bulb in, turn it counterclockwise, then pull it out.
3. Reverse the steps with a new bulb.

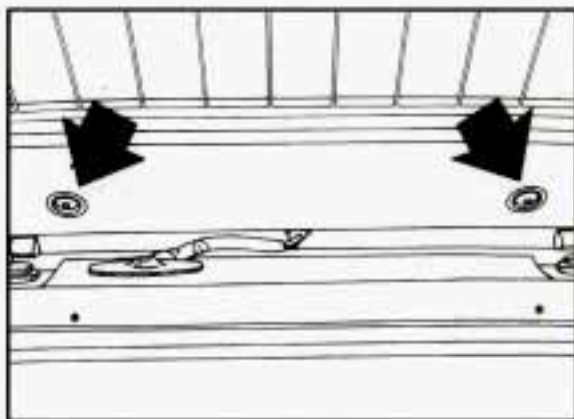

Center High-Mounted Stoplight (ZR-1)

1. Open the hatch.
2. Remove the two screws on the interior side of hatch, near the roof.
3. Gently pull the assembly away from the roof.

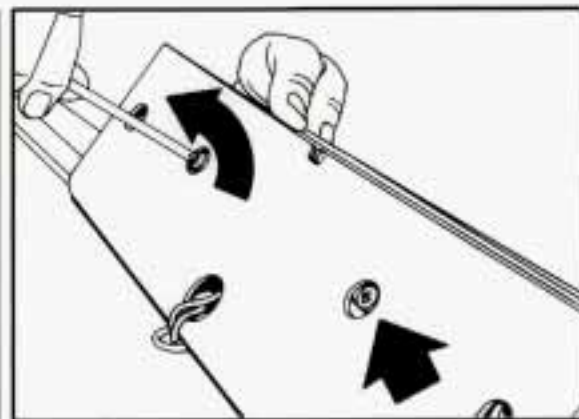

4. Remove the two screws on the underside of the assembly.
5. Remove the rubber backing and pry the lens from the assembly.

Service and Appearance Care

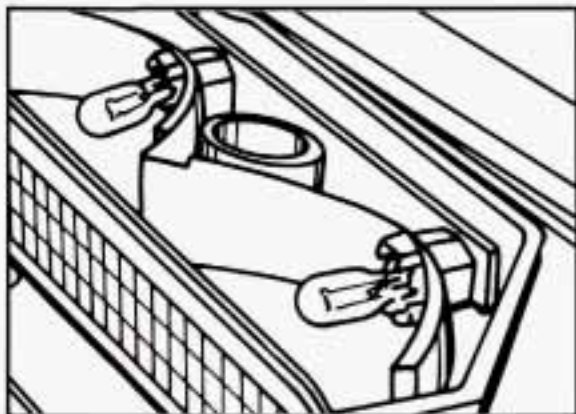

6. Rock the bulb back and forth while pulling up to remove it.
7. Reverse the steps with a new bulb.

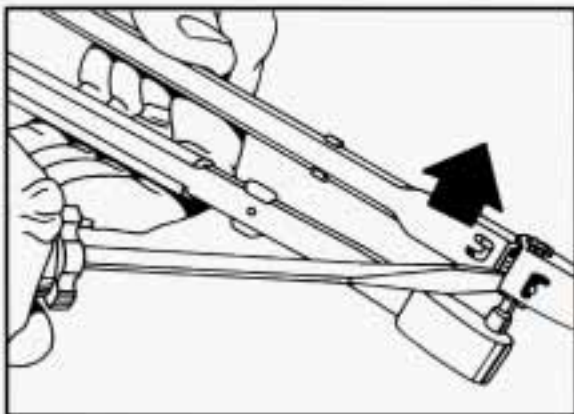

■ *Windshield Wiper Blades*

It's a good idea to rotate the wiper blade assembly 180° every six months. This changes the wear pattern and makes the wiper blade insert last longer. To rotate or replace the wipers:

1. Pull the wiper arm away from the windshield.
2. You should be able to see part of a spring near where the blade connects to the arm. Press down on the spring with a screwdriver and pull the wiper blade off.
3. Rotate the blade and push it back onto the arm.

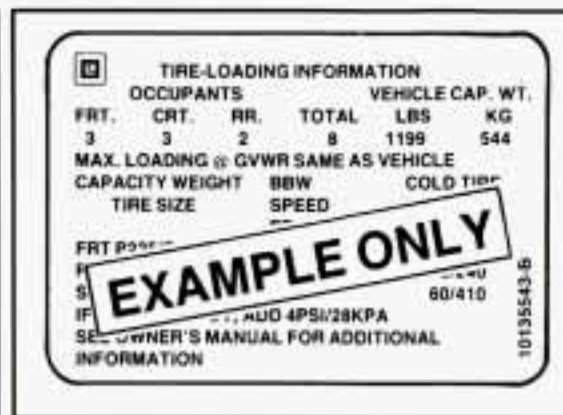

■ *Loading Your Vehicle*

Two labels on your vehicle show how much weight it may properly carry. The Tire-Loading Information label found on the driver's door tells you the proper size, speed rating and recommended inflation pressures for the tires on your vehicle. It also gives you important information about the number of people that can be in your vehicle and the total weight that you can carry. This weight is called the Vehicle Capacity Weight and includes the weight of all occupants, cargo, and all nonfactory-installed options.

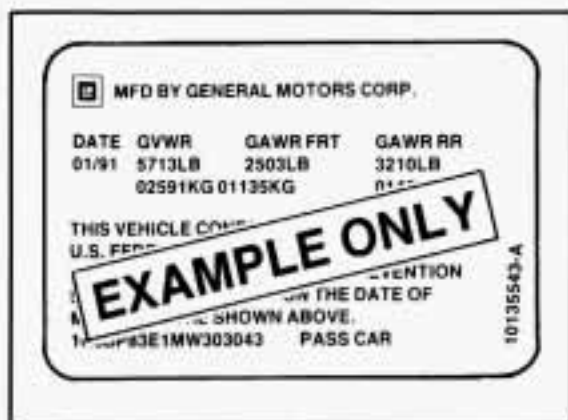

The other label is the Certification label, found on the rear edge of the driver's door. It tells you the gross weight capacity of your vehicle, called the GVWR (Gross Vehicle Weight Rating). The GVWR includes the weight of the vehicle, all occupants, fuel and cargo. Never exceed the GVWR for your vehicle, or the Gross Axle Weight Rating (GAWR) for either the front or rear axle.

And, if you do have a heavy load, you should spread it out. Don't carry more than 100 pounds (45 kg) in your rear area.



CAUTION:

Do not load your vehicle any heavier than the GVWR or the maximum front and rear GAWRs. If you do, parts on your vehicle can break, or it can change the way your vehicle handles. These could cause you to lose control. Also, overloading can shorten the life of your vehicle.

NOTICE:

Your warranty does not cover parts or components that fail because of overloading.

If you put things inside your vehicle — like suitcases, tools, packages, or anything else — they will go as fast as the vehicle goes. If you have to stop or turn quickly, or if there is a crash, they'll keep going.



CAUTION:

Things you put inside your vehicle can strike and injure people in a sudden stop or turn, or in a crash.

- Put things in the rear area of your vehicle. Try to spread the weight evenly.
- Never stack heavier things, like suitcases, inside the vehicle so that some of them are above the tops of the seats.
- Don't leave an unsecured child restraint in your vehicle.
- When you carry something inside the vehicle, secure it whenever you can.
- Don't leave a seat folded down unless you need to.

Service and Appearance Care

■ *Tires*

We don't make tires. Your new vehicle comes with high quality tires made by a leading tire manufacturer. These tires are warranted by the tire manufacturers and their warranties are delivered with every new Corvette. If your spare tire is a different brand than your road tires, you will have a tire warranty folder from each of these manufacturers.



CAUTION:

Poorly maintained and improperly used tires are dangerous.

- Overloading your tires can cause overheating as a result of too much friction. You could have an air-out and a serious accident. See "Loading Your Vehicle" in the Index.
- Underinflated tires pose the same danger as overloaded tires. The resulting accident could cause serious injury. Check all tires frequently to maintain the recommended pressure. Tire pressure should be checked when your tires are cold.
- Overinflated tires are more likely to be cut, punctured, or broken by a sudden impact, such as when you hit a pothole. Keep tires at the recommended pressure.
- Worn, old tires can cause accidents. If your tread is badly worn, or if your tires have been damaged, replace them.
- See "Inflation - Tire Pressure" in this section for the correct inflation pressure for competitive or high-speed driving.

Extended Mobility Tires (OPTION)

If your Corvette has optional Goodyear Extended Mobility Tires (EMT's), the tires will have "EMT" molded on the sidewalls. These tires perform so well without any air that a Low Tire Pressure Warning System (LTPWS) is used to alert you if a tire has lost pressure. A "LOW/FLAT TIRE" light will appear on your Driver Information Center if a tire's inflation pressure is less than 25 psi (170 kPa). If the "LOW/FLAT TIRE" light comes on, check your tire pressures as soon as you can. See "Low Tire Pressure Warning System" in the Index for additional information.

If a tire goes flat, you won't need to stop on the side of the road to change the tire. You can just keep on driving. The shorter the distance you drive and the slower the speed, the greater the chance that the tire will not have to be replaced. If you drive

on a deflated EMT for distances of 50 miles (80 km) or less and at speeds of 55 mph (90 km/h) or less, there is a good chance that the tire can be repaired. The tire can operate effectively with no air pressure for up to 200 miles (320 km) at speeds up to 55 mph (90 km/h), but the tire would then have to be replaced. Also remember: When a tire is filled with air, it provides a cushion between the road and the wheel. Because you do not have this cushion when driving on a deflated tire, try to avoid potholes that could damage your wheel and require replacement of it.

Some road hazards can damage a tire beyond repair. This damage could occur before you've driven on the tire in a deflated condition. Whenever a tire has been damaged, or if you've driven any distance on a deflated EMT, check with a Goodyear EMT Service Center to determine whether the tire can be repaired or should be replaced.



CAUTION:

When the "LOW/FLAT TIRE" warning light is on, your vehicle's handling capabilities will be reduced during severe maneuvers. If you drive too fast, you could lose control of your vehicle. You or others could be injured. Don't drive over 55 mph (90 km/h) when the "LOW/FLAT TIRE" warning light is on.

To maintain your vehicle's extended mobility feature, all replacement tires must be Extended Mobility Tires.

See the Goodyear Extended Mobility Tire Owner's Manual and Limited Warranty supplied with your Corvette for additional information.

Service and Appearance Care

Inflation — Tire Pressure

The Tire-Loading Information label which is on the driver's door shows the correct inflation pressures for your tires, when they're cold. "Cold" means your vehicle has been sitting for at least three hours or driven no more than a mile.

For competitive driving or high-speed driving (over 150 mph or 240 km/h), make sure your tires are inflated to 35 psi (240 kPa). When you end this type of driving, reduce the "cold" inflation pressures (if necessary) to those listed on the Tire-Loading Information label.

NOTICE:

Don't let anyone tell you that underinflation or overinflation is all right. It's not. If your tires don't have enough air (underinflation) you can get:

- Too much flexing
- Too much heat
- Tire overloading
- Bad wear
- Bad handling
- Bad fuel economy.

If your tires have too much air (overinflation), you can get:

- Unusual wear
- Bad handling
- Rough ride
- Needless damage from road hazards.

When to Check: Check your tires once a month or more. Don't forget your compact spare tire. It should be at 60 psi (420 kPa).

How to Check: Use a good quality pocket-type gauge to check tire pressure. Simply looking at the tires will not tell you the pressure, especially if you have radial tires — which may look properly inflated even if they're underinflated.

If your tires have valve caps, be sure to put them back on. They help prevent leaks by keeping out dirt and moisture.

Tire Rotation

The tires on your Corvette are directional, asymmetrical, and are different sizes front to rear. Due to this, your tires should not be rotated. Each tire and wheel should be used only in the position it is in.

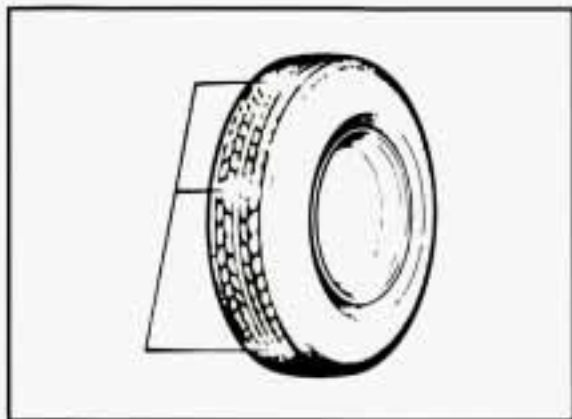

When It's Time for New Tires

One way to tell when it's time for new tires is to check the treadwear indicators, which will appear when your tires have only 2/32 inch (1.6 mm) or less of tread remaining.

You need a new tire if:

- You can see the indicators at three or more places around the tire.
- You can see cord or fabric showing through the tire's rubber.
- The tread or sidewall is cracked, cut or snagged deep enough to show cord or fabric.
- The tire has a bump, bulge or split.

- The tire has a puncture, cut, or other damage that can't be repaired well because of the size or location of the damage.

Buying New Tires

To find out what kind and size of tires you need, look at the Tire-Loading Information label.

The tires installed on your vehicle when it was new had a Tire Performance Criteria Specification (TPC Spec) number on each tire's sidewall. When you get new tires, get ones with that same TPC Spec number. That way, your vehicle will continue to have tires that are designed to give proper endurance, handling, speed rating, traction, ride and other things during normal service on your vehicle. If your tires have an all-season tread design, the TPC number will be followed by a "MS" (for mud and snow).

If you ever replace your tires with those not having a TPC Spec number, make sure they are the same size, load range, speed rating and construction type (bias, bias-belted or radial) as your original tires.



CAUTION:

Mixing tires could cause you to lose control while driving. If you mix tires of different sizes (other than those originally installed on your Corvette) or types (radial and bias-belted tires), the vehicle may not handle properly, and you could have a crash. Be sure to use the correct size and type tires on all four wheels. It's all right to drive with your compact spare, though. It was developed for use on your vehicle.

Uniform Tire Quality Grading

The following information relates to the system developed by the United States National Highway Traffic Safety Administration which grades tires by treadwear, traction and temperature performance. (This applies only to vehicles sold in the United States.)

Treadwear

The treadwear grade is a comparative rating based on the wear rate of the tire when tested under controlled conditions

Service and Appearance Care

on a specified government test course. For example, a tire graded 150 would wear one and a half (1 1/2) times as well on the government course as a tire graded 100. The relative performance of tires depends upon the actual conditions of their use, however, and may depart significantly from the norm due to variations in driving habits, service practices and differences in road characteristics and climate.

Traction — A, B, C

The traction grades, from highest to lowest are: A, B, and C. They represent the tire's ability to stop on wet pavement as measured under controlled conditions on specified government test surfaces of asphalt and concrete. A tire marked C may have poor traction performance.

Warning: The traction grade assigned to this tire is based on braking (straight-ahead) traction tests and does not include cornering (turning) traction.

Temperature — A, B, C

The temperature grades are A (the highest), B, and C, representing the tire's resistance to the generation of heat and its ability to dissipate heat when tested under controlled conditions on a specified

indoor laboratory test wheel. Sustained high temperature can cause the material of the tire to degenerate and reduce tire life, and excessive temperature can lead to sudden tire failure. The grade C corresponds to a level of performance which all passenger car tires must meet under the Federal Motor Vehicle Safety Standard No. 109. Grades B and A represent higher levels of performance on the laboratory test wheel than the minimum required by law.

Warning: The temperature grade for this tire is established for a tire that is properly inflated and not overloaded. Excessive speed, underinflation, or excessive loading, either separately or in combination, can cause heat buildup and possible tire failure.

These grades are molded on the sidewalls of passenger car tires.

While the tires available as standard or optional equipment on General Motors vehicles may vary with respect to these grades, all such tires meet General Motors performance standards and have been approved for use on General Motors vehicles. All passenger type (P Metric) tires must conform to Federal safety requirements in addition to these grades.

Wheel Alignment and Tire Balance

The wheels on your vehicle were aligned and balanced carefully at the factory to give you the longest tire life and best overall performance.

In most cases, you will not need to have your wheels aligned again. However, if you notice unusual tire wear or your vehicle pulling one way or the other, the alignment may need to be reset. If you notice your vehicle vibrating when driving on a smooth road, your wheels may need to be rebalanced.

Wheel Replacement

Replace any wheel that is bent, cracked or badly rusted. If wheel nuts keep coming loose, the wheel, wheel bolts, and wheel nuts should be replaced. If the wheel leaks air, replace it (except some aluminum wheels, which can sometimes be repaired). See your Chevrolet dealer if any of these conditions exist.

Your dealer will know the kind of wheel you need.

Each new wheel should have the same load carrying capacity, diameter, width, offset, and be mounted the same way as the one it replaces.

If you need to replace any of your wheels, wheel bolts, or wheel nuts, replace them only with new GM original equipment parts. This way, you will be sure to have the right wheel, wheel bolts, and wheel nuts for your Corvette.



CAUTION:

Using the wrong replacement wheels, wheel bolts, or wheel nuts on your vehicle can be dangerous. It could affect the braking and handling of your vehicle, make your tires lose air and make you lose control. You could have a collision in which you or others could be injured. Always use the correct wheel, wheel bolts, and wheel nuts for replacement.

NOTICE:

The wrong wheel can also cause problems with bearing life, brake cooling, speedometer/odometer calibration, headlight aim, bumper height, vehicle ground clearance, and tire clearance to the body and chassis.

Used Replacement Wheels



CAUTION:

Putting a used wheel on your vehicle is dangerous. You can't know how it's been used or how many miles it's been driven. It could fail suddenly and cause an accident. If you have to replace a wheel use a new GM original equipment wheel.

Tire Chains

NOTICE:

Don't use tire chains; they can damage your vehicle.

Service and Appearance Care



■ *Appearance Care*

Remember, cleaning products can be hazardous. Some are toxic. Others can burst into flame if you strike a match or get them on a hot part of the vehicle. Some are dangerous if you breathe their fumes in a closed space. When you use anything from a container to clean your Corvette, be sure to follow the manufacturer's warnings and instructions. And always open your doors or windows when you're cleaning the inside.

Never use these to clean your vehicle:

- Gasoline
- Benzene
- Naphtha
- Carbon Tetrachloride
- Acetone
- Paint Thinner
- Turpentine
- Lacquer Thinner
- Nail Polish Remover

They can all be hazardous – some more than others – and they can all damage your vehicle, too.

Don't use any of these unless this manual says you can. In many uses, these will damage your vehicle:

- Alcohol
- Laundry Soap
- Bleach
- Reducing Agents

Cleaning the Inside of Your Corvette

Use a vacuum cleaner often to get rid of dust and loose dirt. Wipe vinyl or leather with a clean, damp cloth.

Your Chevrolet dealer has two GM cleaners, a solvent-type spot lifter and a foam-type powdered cleaner. They will clean normal spots and stains very well. Do not use them on vinyl or leather.

Here are some cleaning tips:

- Always read the instructions on the cleaner label.
- Clean up stains as soon as you can — before they set.
- Use a clean cloth or sponge, and change to a clean area often. A soft brush may be used if stains are stubborn.

- Use solvent-type cleaners in a well-ventilated area only. If you use them, don't saturate the stained area.
- If a ring forms after spot cleaning, clean the entire area immediately or it will set.

Using Foam-Type Cleaner on Fabric

- Vacuum and brush the area to remove any loose dirt.
- Always clean a whole trim panel or section. Mask surrounding trim along stitch or welt lines.
- Mix Multi-Purpose Powdered Cleaner following the directions on the container label.
- Use suds only and apply with a clean sponge.
- Don't saturate the material.
- Don't rub it roughly.
- As soon as you've cleaned the section, use a sponge to remove the suds.
- Rinse the section with a clean, wet sponge.
- Wipe off what's left with a slightly damp paper towel or cloth.

- Then dry it immediately with a blow dryer or a heat lamp.

NOTICE:

Be careful with a hair dryer or heat lamp. You could scorch the fabric.

- Wipe with a clean cloth.

Using Solvent-Type Cleaner on Fabric

First, see if you have to use solvent-type cleaner at all. Some spots and stains will clean off better with just water and mild soap.

If you need to use a solvent:

- Gently scrape excess soil from the trim material with a clean, dull knife or scraper. Use very little cleaner, light pressure and clean cloths (preferably cheesecloth). Cleaning should start at the outside of the stain, "feathering" toward the center. Keep changing to a clean section of the cloth.
- When you clean a stain from fabric, immediately dry the area with an air hose, hair dryer, or heat lamp to help prevent a cleaning ring. (See the previous NOTICE.)

Fabric Protection

Your Corvette has upholstery and carpet that has been treated with Scotchgard™ Fabric Protector, a 3M product. Scotchgard™ protects fabrics by repelling oil and water, which are the carriers of most stains. Even with this protection, you still need to clean your upholstery often to keep it looking new.

Further information on cleaning is available by calling 1-800-433-3296 (in Minnesota, 1-800-642-6167).

Special Cleaning Problems

Greasy or oily stains: Such as grease, oil, butter, margarine, shoe polish, coffee with cream, chewing gum, cosmetic creams, vegetable oils, wax crayon, tar and asphalt.

- Carefully scrape off excess stain.
- Follow the solvent-type instructions described earlier.
- Shoe polish, wax crayon, tar and asphalt will stain if left on a vehicle seat fabric. They should be removed as soon as possible. Be careful, because the cleaner will dissolve them and may cause them to spread.

Service and Appearance Care

Non-greasy stains: Such as catsup, coffee (black), egg, fruit, fruit juice, milk, soft drinks, wine, vomit, urine and blood.

- Carefully scrape off excess stain, then sponge the soiled area with cool water.
- If a stain remains, follow the foam-type instructions described earlier.
- If an odor lingers after cleaning vomit or urine, treat the area with a water/baking soda solution: 1 teaspoon (5 ml) of baking soda to 1 cup (250 ml) of lukewarm water.
- If needed, clean lightly with solvent-type cleaner.

Combination stains: Such as candy, ice cream, mayonnaise, chili sauce and unknown stains.

- Carefully scrape off excess stain, then clean with cool water and allow to dry.
- If a stain remains, clean it with solvent-type cleaner.

Cleaning Vinyl

Use warm water and a clean cloth.

- Rub with a clean, damp cloth to remove dirt. You may have to do it more than once.

- Things like tar, asphalt and shoe polish will stain if you don't get them off quickly. Use a clean cloth and solvent-type vinyl cleaner.

Cleaning Leather

Use a soft cloth with lukewarm water and a mild soap or saddle soap.

- For stubborn stains, use a mild solution of 10% isopropyl alcohol (rubbing alcohol) and 90% water.
- Never use oils, varnishes, solvent-based or abrasive cleaners, furniture polish or shoe polish on leather.
- Soiled leather should be cleaned immediately. If dirt is allowed to work into finish, it can harm the leather.

Cleaning Soft-Touch Surfaces

Use only mild soap and water to clean the Soft-Touch paint surfaces in your Corvette. For protection, use ArmorAll® or equivalent.

Cleaning the Top of the Instrument Panel

Use only mild soap and water to clean the top surfaces of the instrument panel.

Sprays containing silicones or waxes may cause annoying reflections in the windshield and even make it difficult to see through the windshield under certain conditions.

Cleaning Speaker Covers

Vacuum around a speaker cover gently, so that the speaker won't be damaged. If something gets on one of them, follow the steps under "Using Solvent-Type Cleaner on Fabric." Use as little solvent as you can.

Care of Safety Belts

Keep belts clean and dry.



CAUTION:

Do not bleach or dye safety belts. If you do, it may severely weaken them. In a crash they might not be able to provide adequate protection. Clean safety belts only with mild soap and lukewarm water.

Glass

Glass should be cleaned often. GM Glass Cleaner (GM Part No. 1050427) or a liquid household glass cleaner will remove normal tobacco smoke and dust films.

Don't use abrasive cleaners on glass, because they may cause scratches. Avoid placing decals on the inside rear window, since they may have to be scraped off later. If abrasive cleaners are used on the inside of the rear window, an electric defogger element may be damaged. Any temporary license should not be attached across the defogger grid.

Cleaning Dulso-Coated Moldings

These moldings are around the hatch opening in your Corvette's rear area.

- When lightly soiled, wipe with a sponge or soft lint-free cloth dampened with water.
- When heavily soiled, use warm soapy water.

You can remove scratches from a Dulso-coated molding by wiping briskly with the solvent-type cleaner described earlier. If a ring forms, repeat the

procedure over a larger area, feathering toward the center of the ring. If the ring still remains, wipe the whole molding.

Cleaning the Outside of the Windshield and Wiper Blades

If the windshield is not clear after using the windshield washer, or if the wiper blade chatters when running, wax or other material may be on the blade or windshield.

Clean the outside of the windshield with GM Windshield Cleaner, Bon-Ami Powder[®] (GM Part No. 1050011). The windshield is clean if beads do not form when you rinse it with water.

If you use a glass treatment or conditioner containing ethyl alcohol or ethyl sulfate on your glass, be sure to remove the acrylic roof panel, if so equipped. These products may damage the panel.

Clean the blade by wiping vigorously with a cloth soaked in full strength windshield washer solvent. Then rinse the blade with water.

Wiper blades should be checked on a regular basis and replaced when worn.

Cleaning a Removable Roof Panel

Special care is necessary when cleaning, removing and/or storing the roof panel.

- Flush with water to remove dust and dirt, then dry the panel.
- Clean the panel with GM Glass Cleaner (GM Part No. 1050427) or a liquid household glass cleaner. Leave the cleaner on the panel for one minute, then wipe the panel with a soft, lint-free cloth.
- Don't use abrasive cleaning materials.

If water drops are frequently allowed to dry on the roof panel, impurities in the water will adhere to the top. These impurities may destroy the finish. When the panel gets wet, you should dry it off.

NOTICE:

Do not use a glass treatment or conditioner containing ethyl alcohol or ethyl sulfate on the roof panel. These products may damage the panel.

Service and Appearance Care

Cleaning the Outside of Your Corvette

The paint finish on your vehicle provides beauty, depth of color, gloss retention and durability.

Washing Your Vehicle

The best way to preserve your vehicle's finish is to keep it clean by washing it often with lukewarm or cold water.

Don't wash your vehicle in the direct rays of the sun. Don't use strong soaps or chemical detergents. Use liquid hand, dish or car washing (mild detergent) soaps. Don't use cleaning agents that are petroleum-based, or contain acid or abrasives. All cleaning agents should be flushed promptly and not allowed to dry on the surface, or they could stain. Dry the finish with a soft, clean chamois or a 100% cotton towel to avoid surface scratches and water spotting.

High pressure car washes may cause water to enter your vehicle.

NOTICE:

Conveyor systems on some automatic car washes may damage a Corvette. They may not have enough clearance for the undercarriage or for the extra wide rear tires on ZR-1 models. Check with the manager before using a car wash.

Finish Care

Occasional waxing or mild polishing of your Corvette may be necessary to remove residue from the paint finish. You can get GM approved cleaning products from your dealer. (See "Appearance Care and Materials" in the Index.)

Your Corvette has a "basecoat/clearcoat" paint finish. The clearcoat gives more depth and gloss to the colored basecoat. Always use waxes and polishes that are non-abrasive and made for a basecoat/clearcoat paint finish.

NOTICE:

Machine compounding or aggressive polishing on a basecoat/clearcoat paint finish may dull the finish or leave swirl marks.

Cleaning Your Convertible Top

Your convertible top should be cleaned often. If you use an automatic car wash, use one with water jets and hanging cloths.

When you hand wash the top, do it in partial shade. Vacuum away any dust and other material. Use a mild soap, lukewarm water and a soft sponge. A chamois or cloth may leave lint on the top, and a brush can chafe the threads in the top fabric. Don't use detergents, harsh cleaners, solvents or bleaching agents.

When you clean the top, put one hand under it to support it. Wet the entire vehicle and wash the top evenly to avoid spots or rings. Let the soap remain on the fabric for a few minutes. When the top is really dirty, use a mild foam-type cleaner. Thoroughly rinse the entire vehicle, then let the top dry in direct sunlight.

To protect the convertible top:

- After you wash the vehicle, make sure the top is completely dry before you lower it.
- Don't get any cleaner on the vehicle's painted finish; it could leave streaks.
- If you decide to go through an automatic car wash, ask the manager if the equipment could damage your top.

Cleaning and Storage of Your Hardtop

The optional hardtop has the same durable finish as the painted surfaces of your Corvette. You can wash, polish and wax it.

If you store the hardtop for a long time, keep it covered in a dry place. Apply silicone grease to all the weatherstrips.

Engine Cleaning

Use care when cleaning the LT5 engine. Do not direct water into the "V" area on the engine between the cylinder heads.

NOTICE:

Don't use a cleaner with a strong alkaline base. It will discolor the aluminum.

Aluminum Wheels

Your aluminum wheels have a protective coating similar to the painted surface of your vehicle. Don't use strong soaps, chemicals, chrome polish, or other abrasive cleaners on them because you could damage this coating. After rinsing thoroughly, a wax may be applied.

NOTICE:

Don't use an automatic car wash that has hard silicon carbide cleaning brushes. These brushes can take off the protective coating.

Tires

Your Chevrolet dealer has a GM White Sidewall Tire Cleaner. You can use a stiff brush with the cleaner.

When applying a tire dressing always take care to wipe off any overspray or splash from painted surfaces. Petroleum-based products may damage the paint finish.

Weatherstrips

Silicone grease on weatherstrips will make them last longer, seal better, and not stick or squeak. Apply silicone grease with a clean cloth at least every six months. During very cold, damp weather more frequent application may be required. (See "Recommended Fluids and Lubricants" in the Index.)

Foreign Material

Calcium chloride and other salts, ice melting agents, road oil and tar, tree sap, bird droppings, chemicals from industrial chimneys, and other foreign matter can damage your vehicle's finish if they remain on painted surfaces. Use cleaners that are marked safe for painted surfaces to remove foreign matter.

Service and Appearance Care

Finish Damage

Any stone chips, fractures or deep scratches in the finish should be repaired right away.

Minor chips and scratches can be repaired with touch-up materials available from your dealer or other service outlets. Larger areas of finish damage can be corrected in your dealer's body and paint shop.

Underbody Maintenance

Chemicals used for ice and snow removal and dust control can collect on the underbody. If these are not removed, accelerated corrosion (rust) can occur on the underbody parts such as fuel lines, frame, floor pan, and exhaust system even though they have corrosion protection.

At least every spring, flush these materials from the underbody with plain water. Clean any areas where mud and other debris can collect. Dirt packed in closed areas of the frame should be loosened before being flushed. Your dealer or an underbody vehicle washing system can do this for you.

Fiberglass Springs

NOTICE:

Don't use corrosive or acidic cleaning agents, engine degreasers, aluminum cleaning agents or other harsh solvents to clean fiberglass springs; they'll damage the springs.

Chemical Paint Spotting

Some weather and atmospheric conditions can create a chemical fallout. Airborne pollutants can fall upon and attack painted surfaces on your vehicle. This damage can take two forms: blotchy, ringlet-shaped discolorations, and small irregular dark spots etched into the paint surface.

Although no defect in the paint job causes this, Chevrolet will repair, at no charge to the owner, the surfaces of new vehicles damaged by this fallout condition within 12 months or 12,000 miles (20 000 km) of purchase, whichever comes first.

■ Appearance Care Materials Chart

| PART NUMBER | SIZE | DESCRIPTION | USAGE |
|-------------|-------------------|--------------------------------------|--|
| 1051516 | 32 oz. (0.946 L) | Washer Solvent and Gas Liner De-Icer | Windshield washing system and gas line |
| 1050172 | 16 oz. (0.473 L) | Tar and Road Oil Remover | Also old waxes, polishes |
| 1050173 | 16 oz. (0.473 L) | Cleaner and Polish | Removes rust and corrosion on chrome and steel |
| 1050174 | 16 oz. (0.473 L) | White Sidewall Tire Cleaner | Cleans white and black tires |
| 1050214 | 32 oz. (0.946 L) | Vinyl/Leather Cleaner* | Spot and stain removal on leather and vinyl |
| 1050244 | 16 oz. (0.473 L) | Fabric Cleaner* | Spot and stain removal on cloth and fabric |
| 1050427 | 24 oz. (0.680 L) | Glass Cleaner | Glass cleaning and spot cleaning on vinyls |
| 1050429 | 6 lb. (2.72 kg) | Multi-Purpose Powdered Cleaner | Vinyl, cloth, door trims, seats, carpet, tires, mats |
| 1052870 | 16 oz. (0.473 L) | Wash-Wax (Concentrated) | Exterior wash |
| 1051398 | 8 oz. (0.237 L) | Spot Lifter* | Spot and stain removal on cloth and fabric |
| 1050201 | 16 oz. (0.473 L) | Magic Mirror Cleaner-Polish | Exterior cleaner and polish |
| 1050011 | 12 oz. (0.340 kg) | Bon-Ami Powder* | Windshield cleaner |

*Not recommended for pigskin suede leather.

See your General Motors Dealer for these products. See the Index under "Recommended Fluids and Lubricants" for other products.

Service and Appearance Care

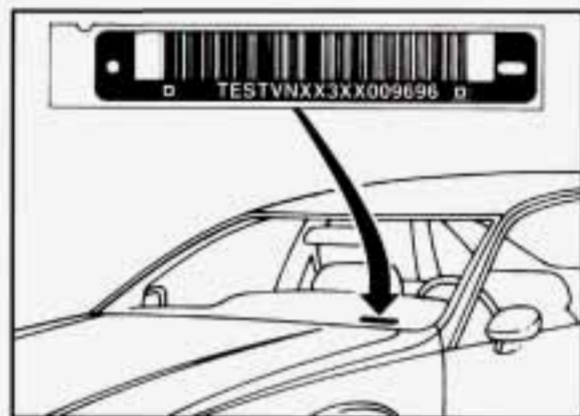

■ *Vehicle Identification Number (VIN)*

This is the legal identifier for your Corvette. It appears on a plate in the front corner of the instrument panel, on the driver's side. You can see it if you look through the windshield from outside your vehicle. The VIN also appears on the Vehicle Certification and Service Parts labels and the certificates of title and registration.

Engine Identification

The eighth character in your VIN is the engine code. This code will help you identify your engine, specifications, and replacement parts.

■ *Service Parts Identification Label*

You'll find this label on the underside of your console storage compartment. It's very helpful if you ever need to order parts. On this label is:

- your VIN,
- the model designation,
- paint information, and
- a list of all production options and special equipment.

Be sure that this label is not removed from the vehicle.

■ *Add-On Electrical Equipment*

NOTICE:

Don't add anything electrical to your Corvette unless you check with your dealer first. Some electrical equipment can damage your vehicle and the damage wouldn't be covered by your warranty. Some add-on electrical equipment can keep other components from working as they should.

Your vehicle has an air bag system. Before attempting to add anything electrical to your Corvette, see "Servicing Your Air Bag-Equipped Corvette" in the Index.



■ *Fuses and Circuit Breakers*

The wiring circuits in your vehicle are protected from short circuits by a combination of maxi-fuses, mini-fuses and circuit breakers. This greatly reduces the chance of fires caused by electrical problems.

There are three fuse centers on your vehicle. One is in the right side of your instrument panel. Turn the knob and pull the door to access the fuses.

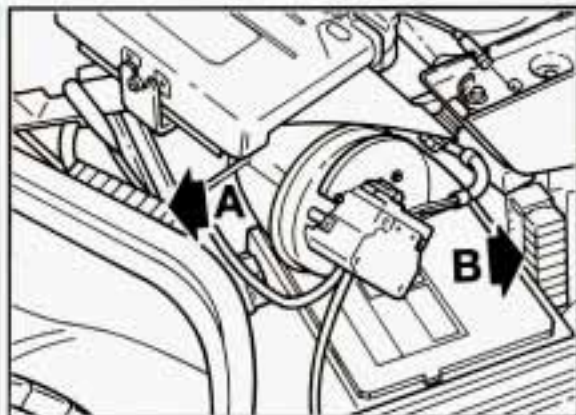

The other two fuse blocks are in the engine compartment. One is part of the Forward Lamp wiring harness (A), and the other is part of the ECM-Engine wiring harness (B).

Look at the silver-colored band inside the fuse. If the band is broken or melted, replace the fuse. Be sure you replace a bad fuse with a new one of the correct size.

If you ever have a problem on the road and don't have a spare fuse, you can borrow one of the correct value. Just pick some feature of your vehicle that you can get along without — like the radio or cigarette lighter — and use its fuse, if it is the size you need. Replace it as soon as you can.

Headlights

The headlight wiring is protected by a circuit breaker in the switch. An electrical overload will cause the lights to go on and off, or in some cases to remain off. If this happens, have your headlight wiring checked right away.

Windshield Wipers

The windshield wiper motor is protected by a circuit breaker and a fuse. If the motor overheats due to heavy snow, etc., the wiper will stop until the motor cools. If the overload is caused by some electrical problem and not snow, etc., be sure to get it fixed.

Power Windows and Other Power Options

Circuit breakers protect the power windows and other power accessories. When the current load is too heavy, the circuit breaker opens and closes, protecting the circuit until the problem is fixed or goes away.

Service and Appearance Care

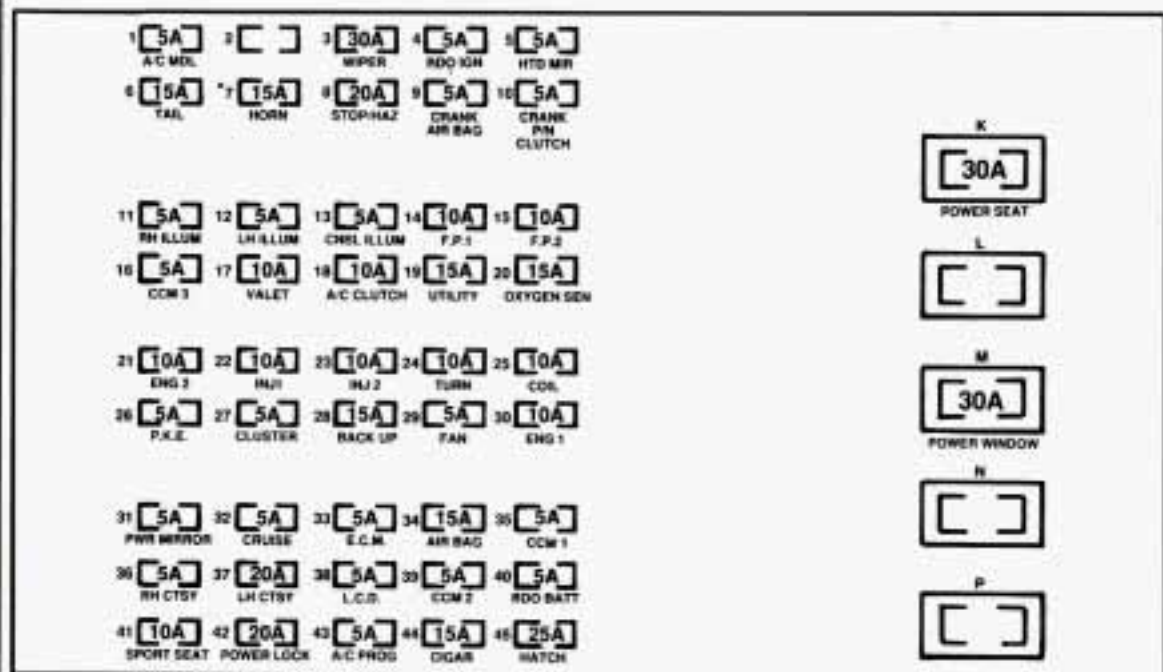

Instrument Panel Fuse Block

- 1 — A/C Module (5 Amp.)
- 2 — Blank
- 3 — Windshield Wiper/Washer Switch Assembly (30 Amp.)
- 4 — Radio Receiver Box (Ignition) (5 Amp.)
- 5 — Heated Mirrors (5 Amp.)
- 6 — Taillight, Daytime Running Lights Module (15 Amp.)

- 7 — Horn Relay (15 Amp.)
*Export Horn (20 Amp.)
- 8 — Hazard Flashers; Brake Switch (20 Amp.)
- 9 — Crank-Air Bag (5 Amp.)
- 10 — Crank-Park/Neutral Switch (Automatic); Clutch (Manual) (5 Amp.)
- 11 — RH Illumination (5 Amp.)
- 12 — LH Illumination (5 Amp.)

- 13 — Console Illumination (5 Amp.)
- 14 — Fuel Pump 1 (10 Amp.)
- 15 — Fuel Pump 2 (LT5) (10 Amp.)
- 16 — Central Control Module; Daytime Running Lights Module (5 Amp.)
- 17 — Generator; Vacuum Pump (LT5); Valet Mode (LT5); EGR Circuit (LT5); Oxygen Sensors (LT5) (10 Amp.)
- 18 — A/C Compressor Clutch; Heater and A/C Control Head; Heater and A/C Programmer; Rear Defog Relay (10 Amp.)
- 19 — Utility Plug (15 Amp.)
- 20 — Heated Oxygen Sensors (LT1) (15 Amp.)
- 21 — Fuel Pump Relay Coil #2 (LT5); Selective Ride Control Module; ABS Module; Transmission Clutch Control Switch (Automatic); Air Pump Relay; Diverter Valve; Secondary Bypass Valve (LT5) (10 Amp.)
- 22 — Injectors #1, 4, 6, 7 (LT1); Primary Injectors #1-8 (LT5); Ignition Coil Module (LT5); Ignition Coil Plate Connector (LT5) (10 Amp.)

- 23** — Injectors #2, 3, 5, 8 (LT1); Secondary Injector Relays (#1, 2 (LT5); Secondary SFI Control Modules (LT5) (10 Amp.)
- 24** — Turn Signal Flashers (10 Amp.)
- 25** — Ignition Coil and Ignition Coil Module (10 Amp.)
- 26** — Passive Keyless Entry Module (5 Amp.)
- 27** — Instrument Cluster; Driver Information Center; Air Bag Derm; Acceleration Slip Regulation Switch (15 Amp.)
- 28** — Backup Lights Switch; Transmission Position Switch; One to Four Shift Solenoid (10 Amp.)
- 29** — Primary Cooling Fan Relay Coil; Secondary Cooling Fan Relay Coil (5 Amp.)
- 30** — Direct Ignition Module; Camshaft Sensor; Canister Purge Solenoid; Throttle Position Sensor Buffer Module; EGR Circuit (LT1); Secondary Air Inlet Solenoid (LT5); Electronic Ignition Control Module (LT5); One to Four Shift Relay (10 Amp.)
- 31** — Power Mirror Adjuster Control; Lighted Rearview Mirror; Visor Vanity Mirrors (5 Amp.)
- 32** — Cruise Control Engage Switch; Daytime Running Lights Module; Low Tire Pressure Warning Module (5 Amp.)
- 33** — Engine Control Module (5 Amp.)
- 34** — Air Bag System (15 Amp.)
- 35** — Central Control Module (5 Amp.)
- 36** — Footwell Courtesy Lights; Door Courtesy Lights; Glove Compartment Lights; Lighted Rearview Mirror (5 Amp.)
- 37** — Bose Amplifier Relay; Power Antenna Relay; Cargo Compartment Lights (20 Amp.)
- 38** — LCD; Tone Generator; Dome Light Relay (5 Amp.)
- 39** — Central Control Module (5 Amp.)
- 40** — Radio Receiver Box (Battery); Radio Control Head; Passive Keyless Entry Module (5 Amp.)
- 41** — Sport Seat (10 Amp.)
- 42** — Power Door Lock Switches; Driver Information Center; Passive Keyless Entry Module (20 Amp.)
- 43** — A/C Programmer (5 Amp.)
- 44** — Cigar Lighter; Accessory Plug (15 Amp.)
- 45** — Hatch or Deck Lid Release Relay (25 Amp.)
- K** — Power Seats (30 Amp. Circuit Breaker)
- L** — Blank
- M** — Power Windows (30 Amp. Circuit Breaker)
- N** — Blank
- P** — Blank

Service and Appearance Care

| | |
|---|------------------------------|
| 1 | INTERIOR LIGHTING 20A |
| 2 | PRIMARY COOLING FAN 30A |
| 3 | LH HDLP MOTOR 30A |
| 4 | RH HDLP MOTOR 30A |
| 5 | SECONDARY COOLING FAN 40A |
| 6 | EXTERIOR LIGHTING 60A |
| 7 | POWER ACCSY 60A |
| 8 | AIR PUMP 20A |

Forward Lamp Fuse Block

- 1 — Interior Lighting (20 Amp.)
- 2 — Primary Cooling Fan (30 Amp.)
- 3 — LH Headlight Motor (30 Amp.)
- 4 — RH Headlight Motor (30 Amp.)
- 5 — Secondary Cooling Fan (40 Amp.)
- 6 — Exterior Lighting (60 Amp.)
- 7 — Power Accessory (Power Locks, Hatch, Lighter, Seats) (60 Amp.)
- 8 — Air Pump (20 Amp.)

ECM Engine Fuse Block

- 1 — Engine Control Module (20 Amp.)
- 2 — Fuel Pump (20 Amp.)
- 3 — Anti-lock Brakes; Acceleration Slip Regulation System (20 Amp.)
- 4 — A/C Blower (30 Amp.)
- 5 — Rear Defogger (40 Amp.)
- 6 — Ignition (60 Amp.)
- 7 — Ignition (60 Amp.)
- 8 — Brake Hydraulics (40 Amp.)

| | |
|---|-------------------------|
| 1 | ECM 20A |
| 2 | FUEL PUMP 20A |
| 3 | ABS/ASR ECU 20A |
| 4 | A/C BLOWER 30A |
| 5 | RR DEFOG 40A |
| 6 | IGNITION 60A |
| 7 | IGNITION 60A |
| 8 | BRAKE HYDRAULICS 40A |

■ **Replacement Bulbs**

| | |
|---|--------|
| Air Conditioning/Heater Control | 37 |
| Automatic Transmission Indicator | 194NA |
| Backup | 1156 |
| Center High-Mounted Stoplight (except ZR-1) | 1156 |
| Center High-Mounted Stoplight (ZR-1) | 891 |
| Console | 564 |
| Cornering | 1156 |
| Door Courtesy | 212-2 |
| Door Flood | 73 |
| Driver Information Center | * |
| Floor Courtesy | 562 |
| Fog | 896 |
| Front Parking/Turn Signal | 2057NA |
| Headlight | HP6054 |
| Instrument Cluster | * |
| License | 24 |
| Mirror Flood | 74 |
| Mirror Reading | 168 |
| Radio | * |
| Rear Courtesy (Convertible) | 562 |
| Rear Courtesy (except Convertible) | 906 |
| Sidemarkers | 24 |
| Tail/Stop/Turn | 2057 |
| Underhood | 212-2 |
| Visor Vanity Mirror | 74 |

**These bulbs are not owner-serviceable. See your dealer.*

Service and Appearance Care

■ *Capacities and Specifications*

Engine

| | |
|---------------------------|---|
| Type | V8 |
| Fuel Delivery | Sequential Multiport Fuel Injection (SFI) |
| Valve Arrangement | |
| VIN Engine Code J | Dual Overhead Cam |
| VIN Engine Code P | Overhead Valve |
| Piston Displacement | 350 CID (5.7L) |
| Bore | |
| VIN Engine Code J | 3.90" (99 mm) |
| VIN Engine Code P | 4.00" (101.6 mm) |
| Stroke | |
| VIN Engine Code J | 3.66" (93 mm) |
| VIN Engine Code P | 3.48" (88.39 mm) |
| Compression Ratio | |
| VIN Engine Code J | 11.0:1 |
| VIN Engine Code P | 10.5:1 |
| Firing Order | 1-8-4-3-6-5-7-2 |

Replacement Parts

| | |
|--|-----------------------|
| Air Cleaner Filter | A1097C |
| Battery | |
| VIN Engine Code J | 75Z-72 |
| VIN Engine Code P | 75B-72 |
| Coolant High Fill Reservoir Cap | RC36 |
| Crankcase Ventilation Valve | |
| VIN Engine Code J | CV746CB and CV913C |
| VIN Engine Code P | CV895C |
| Engine Oil Filter | |
| VIN Engine Code J | PF970C (black) |
| VIN Engine Code P | PF51 |
| Serpentine Belt | |
| VIN Engine Code J | GM Part No. 10067477 |
| VIN Engine Code P | GM Part No. 10230259 |
| Spark Plug | |
| VIN Engine Code J | 907 (0.050" Gap) |
| VIN Engine Code P | 906 (0.050" Gap) |
| Thermostat Temperature Specification | 180°F (82°C) |
| Wheel Nuts | |
| Wheel Nut Torque | 100 lb. ft. (140 N•m) |

Service and Appearance Care

Capacities (Approximate)

The following approximate capacities are given in U.S. and metric conversions.

| | | |
|--------------------------------|-------|---|
| Air Conditioning† | | See the refrigerant information label under the hood. |
| Automatic Transmission | | |
| Drain and Refill | | 10.0 pt. (4.7 L)* |
| Overhaul | | 21.6 pt. (10.2 L)* |
| Cooling System | | |
| VIN Engine Code J | | 14.7 qt. (13.9 L) |
| VIN Engine Code P | | 17.8 qt. (16.9 L) |
| Crankcase | | |
| VIN Engine Code J | | |
| Without Filter Change | | 7.6 qt. (7.2 L)* |
| With Filter Change | | 8.6 qt. (8.1 L)* |
| VIN Engine Code P | | |
| Without Filter Change | | 4.0 qt. (3.8 L)* |
| With Filter Change | | 4.5 qt. (4.3 L)* |
| Fuel Tank | | 20.0 gal. (75.7 L) |
| Manual Transmission (Overhaul) | | 4.4 pt. (2.1 L)* |
| Rear Axle | | |
| Lubricant | | 1.5 qt. (1.42 L)* |
| Limited-Slip Additive | | 4.0 oz. (118 ml) |

†Not all air conditioning refrigerants are the same. If the air conditioning system in your vehicle needs refrigerant, be sure the proper refrigerant is used. If you're not sure, ask your Chevrolet dealer.

*Recheck fluid level after filling. See Part 6 or the Index.

Vehicle Dimensions

| | |
|-----------------------------|-------------------|
| Wheelbase | 96.2" (2 443 mm) |
| Tread | |
| Front | 57.7" (1 466 mm) |
| Rear | |
| Coupe and Convertible | 59.1" (1 501 mm) |
| ZR-1 | 60.6" (1 539 mm) |
| Length | 178.5" (4 534 mm) |
| Width | |
| Coupe and Convertible | 70.7" (1 796 mm) |
| ZR-1 | 73.1" (1 857 mm) |
| Height | |
| Coupe and ZR-1 | 46.3" (1 176 mm) |
| Convertible | 47.3" (1 201 mm) |

Service and Appearance Care

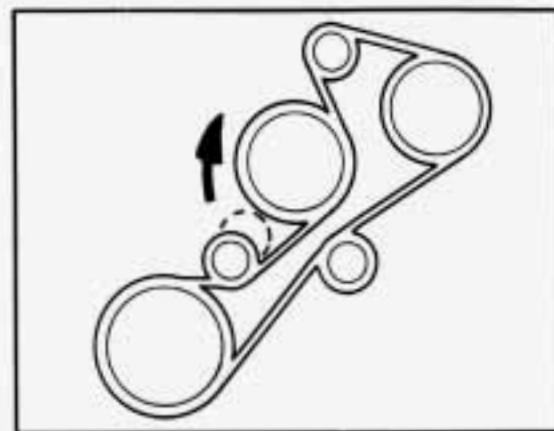
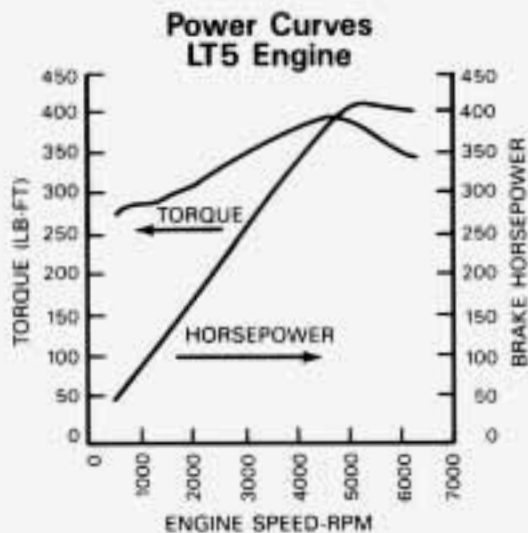
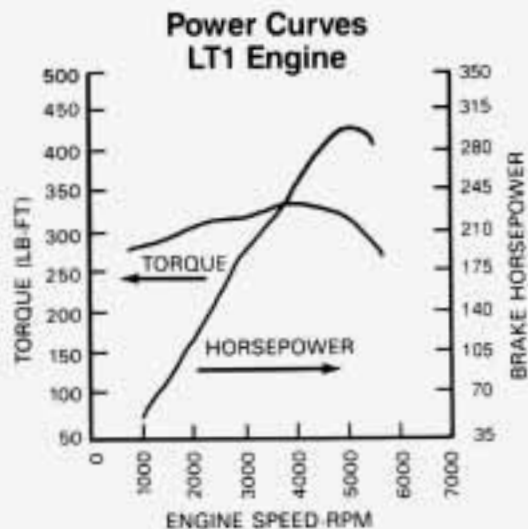

Belt Routing - LT1 (Code P) Engine

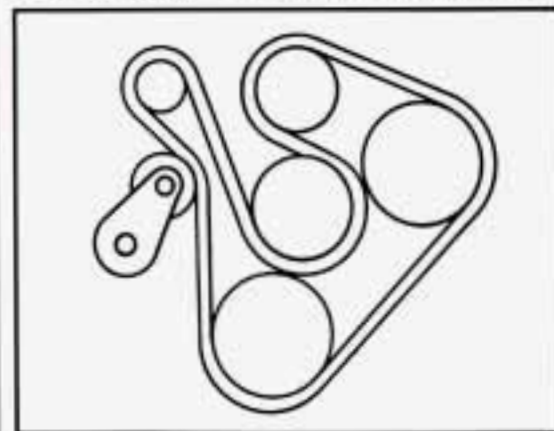

Belt Routing - LT5 (Code J) Engine

Part 7

Maintenance Schedule

Section

| | |
|---|-----|
| Introduction: A Word about Maintenance | 230 |
| Your Vehicle and the Environment | 230 |
| How This Part Is Organized | 230 |
| A. Scheduled Maintenance Services | 231 |
| Using Your Maintenance Schedule | 231 |
| Selecting the Right Schedule | 231 |
| Schedule I | 232 |
| Schedule II | 234 |
| Explanation of Scheduled Maintenance Services | 236 |
| B. Owner Checks and Services | 238 |
| At Each Fuel Fill | 238 |
| At Least Once a Month | 238 |
| At Least Once a Year | 239 |
| C. Periodic Maintenance Inspections | 242 |
| D. Recommended Fluids and Lubricants | 244 |
| E. Maintenance Record | 247 |

IMPORTANT:
KEEP THE ENGINE OIL
AT THE PROPER
LEVEL AND CHANGE AS
RECOMMENDED

This part covers the maintenance required for your Corvette. Your vehicle needs these services to retain its safety, dependability and emission control performance.



**Protection
Plan**

*Have you purchased the GM Protection Plan? The Plan
supplements your new car warranties.
See your GM dealer for details.*

Maintenance Schedule

Introduction: A Word about Maintenance

We at General Motors want to help you keep your vehicle in good working condition. But we don't know exactly how you'll drive it. You may drive very short distances only a few times a week. Or you may drive long distances all the time in very hot, dusty weather. You may use your vehicle in making deliveries. Or you may drive it to work, to do errands, or in many other ways.

Because of all the different ways people use their GM vehicles, maintenance needs vary. You may even need more frequent checks and replacements than you will find in the schedules in this part. So please read this part and note how you drive. If you have any questions on how to keep your vehicle in good condition, see your Chevrolet dealer, the place many GM owners choose to have their maintenance work done. Your dealer can be relied upon to use proper parts and practices.

Your Vehicle and the Environment

Proper vehicle maintenance not only keeps your vehicle in good working condition, but it also helps the environment. All recommended maintenance procedures are important. Improper vehicle maintenance or the removal of important components can significantly affect the quality of the air we breathe. Improper fluid levels or even the wrong tire inflation can increase the level of emissions from your vehicle. To help protect our environment, and to help keep your vehicle in good condition, please maintain your vehicle properly.

How This Part is Organized

The remainder of this part is divided into five sections:

“Section A: Scheduled Maintenance Services” shows what to have done, and how often. Some of these services can be complex, so unless you are technically qualified and have the necessary equipment, you should let your dealer's

service department or another qualified service center do these jobs.

CAUTION

Performing maintenance work on a vehicle can be dangerous. In trying to do some jobs, you can be seriously injured. Do your own maintenance work only if you have the required know-how and the proper tools and equipment for the job. If you have any doubt, have a qualified technician do the work.

If you are skilled enough to do some work on your vehicle, you will probably want to get the service information GM publishes. You will find a list of publications and how to get them in this manual. See “Service Publications” in the Index.

“Section B: Owner Checks and Services” tells you what should be checked whenever you stop for fuel. It also explains what you can easily do to help keep your vehicle in good condition.

“Section C: Periodic Maintenance Inspections” explains important inspections that your Chevrolet dealer’s service department or another qualified service center should perform.

“Section D: Recommended Fluids and Lubricants” lists some products GM recommends to help keep your vehicle properly maintained. These products, or their equivalents, should be used whether you do the work yourself or have it done.

“Section E: Maintenance Record” provides a place for you to record the maintenance performed on your vehicle. Whenever any maintenance is performed, be sure to write it down in this section. This will help you determine when your next maintenance should be done. In addition, it is a good idea to keep your maintenance receipts. They may be needed to qualify your vehicle for warranty repairs.

■ *Section A: Scheduled Maintenance Services*

Using Your Maintenance Schedule

This section tells you the maintenance services you should have done and when you should schedule them. Your Chevrolet dealer knows your vehicle best and wants you to be happy with it. If you go to your dealer for your service needs, you’ll know that GM-trained and supported service people will perform the work using genuine GM parts.

These schedules are for vehicles that:

- carry passengers and cargo within recommended limits. You will find these limits on your vehicle’s Tire-Loading Information label. See “Loading Your Vehicle” in the Index.
- are driven on reasonable road surfaces within legal driving limits.
- use the recommended unleaded fuel. See “Fuel” in the Index.

Selecting the Right Schedule

First you’ll need to decide which of the two schedules is right for your vehicle. Here’s how to decide which schedule to follow:

Schedule I

Is any one of these true for your vehicle?

- Most trips are less than 4 miles (6 km).
- Most trips are less than 10 miles (16 km) when outside temperatures are below freezing.
- The engine is at low speed most of the time (as in door-to-door delivery, or in stop-and-go traffic).
- You operate your vehicle in dusty areas.

If any one (or more) of these is true for your driving, follow Schedule I.

Schedule II

Follow Schedule II only if none of the above conditions is true.

Maintenance Schedule

Section A: Scheduled Maintenance Services (Cont.)

Schedule I

Follow Schedule I if your vehicle is MAINLY driven under one or more of the following conditions:

- When most trips are less than 4 miles (6 km).
- When most trips are less than 10 miles (16 km) and outside temperatures remain below freezing.
- When most trips include extended idling and/or frequent low-speed operation, as in stop-and-go traffic.
- When operating in dusty areas.

Schedule I should also be followed if the vehicle is used for delivery service, police, taxi or other commercial applications.

* *An Emission Control Service.*

† *The U.S. Environmental Protection Agency or the California Air Resources Board has determined that the failure to perform this maintenance item will not nullify the emission warranty or limit recall liability prior to the completion of vehicle useful life. General Motors, however, urges that all recommended maintenance services be performed at the indicated intervals and the maintenance be recorded in "Section E: Maintenance Record."*

| ITEM NO. | WHAT TO SERVICE <i>See "Explanation of Scheduled Maintenance Services" following Schedules I and II.</i> | WHEN TO PERFORM <i>Miles (kilometers) or Months (whichever occurs first).</i> |
|----------|---|---|
| 1 | Engine Oil and Filter Change* | Every 3,000 miles (5 000 km) or 3 months, |
| 2 | Chassis Lubrication | Every other oil change. |
| 3 | Engine Accessory Drive Belt Inspection | Every 30,000 miles (50 000 km) or 24 months. |
| 4 | Cooling System Service* | |
| 5 | Transmission Service | See "Explanation of Scheduled Maintenance Services" following Schedules I and II. |
| 6 | Spark Plug Replacement* | Every 100,000 miles (166 000 km). |
| 7 | Spark Plug Wire Inspection*† | Every 30,000 miles (50 000 km). |
| 8 | Air Cleaner Filter Replacement* | See "Explanation of Scheduled Maintenance Services" following Schedules I and II. |
| 9 | Fuel Tank, Cap and Lines Inspection*† | Every 30,000 miles (50 000 km). |

The services shown on this chart up to 48,000 miles (80 000 km) should be performed after 48,000 miles (80 000 km) at the same intervals.

MILES (000)

| | | | | | | | | | | | | | | | |
|---|---|---|----|----|----|----|----|----|----|----|----|----|----|----|----|
| 3 | 6 | 9 | 12 | 15 | 18 | 21 | 24 | 27 | 30 | 33 | 36 | 39 | 42 | 45 | 48 |
|---|---|---|----|----|----|----|----|----|----|----|----|----|----|----|----|

KILOMETERS (000)

| | | | | | | | | | | | | | | | |
|---|----|----|----|----|----|----|----|----|----|----|----|----|----|----|----|
| 5 | 10 | 15 | 20 | 25 | 30 | 35 | 40 | 45 | 50 | 55 | 60 | 65 | 70 | 75 | 80 |
| • | • | • | • | • | • | • | • | • | • | • | • | • | • | • | • |
| | • | | • | | • | | • | | • | | • | | • | | • |
| | | | | | | | | | • | | | | | | |
| | | | | | | | | | | | | | | | |
| | | | | | | | | | | | | | | | |
| | | | | | | | | | • | | | | | | |
| | | | | | | | | | | | | | | | |
| | | | | | | | | | • | | | | | | |

Maintenance Schedule

Section A: Scheduled Maintenance Services (Cont.)

Schedule II

Follow Schedule II ONLY if none of the driving conditions specified in Schedule I apply.

* An Emission Control Service.

† The U.S. Environmental Protection Agency or the California Air Resources Board has determined that the failure to perform this maintenance item will not nullify the emission warranty or limit recall liability prior to the completion of vehicle useful life. General Motors, however, urges that all recommended maintenance services be performed at the indicated intervals and the maintenance be recorded in "Section E: Maintenance Record."

| ITEM NO. | WHAT TO SERVICE <i>See "Explanation of Scheduled Maintenance Services" following Schedules I and II.</i> | WHEN TO PERFORM <i>Miles (kilometers) or Months (whichever occurs first).</i> |
|----------|---|---|
| 1 | Engine Oil Change* | Every 7,500 miles (12 500 km) or 12 months. |
| | Oil Filter Change* | At first and every other oil change. |
| 2 | Chassis Lubrication | Every 7,500 miles (12 500 km) or 12 months. |
| 3 | Engine Accessory Drive Belt Inspection | Every 30,000 miles (50 000 km) or 24 months. |
| 4 | Cooling System Service* | |
| 5 | Transmission Service | See "Explanation of Scheduled Maintenance Services" following Schedules I and II. |
| 6 | Spark Plug Replacement* | Every 100,000 miles (166 000 km). |
| 7 | Spark Plug Wire Inspection*† | Every 30,000 miles (50 000 km). |
| 8 | Air Cleaner Filter Replacement* | See "Explanation of Scheduled Maintenance Services" following Schedules I and II. |
| 9 | Fuel Tank, Cap and Lines Inspection*† | Every 30,000 miles (50 000 km). |

The services shown on this chart up to 45,000 miles (75 000 km) should be performed after 45,000 miles (75 000 km) at the same intervals.

MILES (000)

| 7.5 | 15 | 22.5 | 30 | 37.5 | 45 |
|-------------------------|----|------|----|------|----|
| KILOMETERS (000) | | | | | |
| 12.5 | 25 | 37.5 | 50 | 62.5 | 75 |
| • | • | • | • | • | • |
| • | | • | | • | |
| • | • | • | • | • | • |
| | | | • | | |
| | | | | | |
| | | | • | | |
| | | | | | |
| | | | • | | |

Maintenance Schedule

Section A: Scheduled Maintenance Services (Cont.)

Explanation of Scheduled Maintenance Services

Following are explanations of the services listed in Schedule I and Schedule II.

The proper fluids and lubricants to use are listed in Section D. Make sure whoever services your vehicle uses these. All parts should be replaced and all necessary repairs done before you or anyone else drives the vehicle.

NOTE: To determine your engine's displacement and code, see "Engine Identification" in the Index.

ITEM NO. SERVICE

- 1** Engine Oil and Filter Change* – Always use SH or SG Energy Conserving II oils of proper viscosity. The engine requires a special oil meeting GM Standard GM4718M. Oils meeting this Standard may be identified as synthetic, and should also be identified as API Service SH or SG. However, not all Synthetic API Service SH oils will meet

ITEM NO. SERVICE

this GM Standard. You should look for and use only an oil that meets GM Standard GM4718M. To determine the preferred viscosity for your vehicle's engine (e.g., SAE 5W-30 or SAE 10W-30), see "Engine Oil" in the Index.

Your vehicle has an Engine Oil Life Monitor. This monitor will show you when to change the oil – usually between 3,000 miles (5 000 km) and 7,500 miles (12 500 km) since your last oil change. Under severe conditions the indicator may come on before 3,000 miles (5 000 km). Never drive your vehicle more than 7,500 miles (12 500 km) or 12 months without an oil change.

The system won't detect dust in the oil. So if you drive in a dusty area be sure to change your oil every 3,000 miles (5 000 km) or sooner if the "Change Oil" light comes on.

ITEM NO. SERVICE

Remember to reset the Oil Life Monitor when the oil has been changed. For more information, see "Engine Oil Life Monitor" in the Index.

- 2** Chassis Lubrication – Lubricate suspension and steering linkage. Lubricate the transmission shift linkage, and parking brake cable guides, underbody contact points and linkage.
- 3** Engine Accessory Drive Belt(s) Inspection – Inspect the belt(s) for cracks, fraying, wear and proper tension. Replace as needed. (Belts can have many small cracks in individual ribs without affecting performance.)
- 4** Cooling System Service* – Drain, flush and refill the system with new or approved recycled coolant conforming to GM Specification 1825M. Keep coolant at the proper mixture as specified. See "Coolant" in the

* An Emission Control Service.

**ITEM
NO. SERVICE**

Index. This provides proper freeze and boil protection, corrosion inhibitor level and maintains proper engine operating temperature.

Inspect hoses and replace if they are cracked, swollen or deteriorated. Tighten screw-type hose clamps. Clean the outside of the radiator and air conditioning condenser. Wash the pressure cap and neck.

To help ensure proper operation, we recommend a pressure test of both the cooling system and the pressure cap.

- 5** Transmission Service – For manual transmissions, fluid doesn't require changing. See "Periodic Maintenance Inspection."

For automatic transmissions, change both the fluid and filter every 15,000 miles (25 000 km)

**ITEM
NO. SERVICE**

if the vehicle is mainly driven under one or more of these conditions:

- In heavy city traffic where the outside temperature regularly reaches 90°F (32°C) or higher.
- In hilly or mountainous terrain.
- Uses such as found in taxi, police car or delivery service.

If you do not use your vehicle under any of these conditions, change both the fluid and filter every 100,000 miles (166 000 km).

- 6** Spark Plug Replacement* – Replace spark plugs with the proper type. See "Replacement Parts" in the Index.
- 7** Spark Plug Wire Inspection*† – Inspect for burns, cracks or other damage. Check the boot fit at the coils and at the spark plugs. Replace wires as needed.

**ITEM
NO. SERVICE**

- 8** Air Cleaner Filter Replacement* – Replace every 30,000 miles (50 000 km) or more often under dusty conditions. Ask your dealer for the proper replacement intervals for your driving conditions.
- 9** Fuel Tank, Cap and Lines Inspection*† – Inspect fuel tank, cap and lines (including fuel rails and injection assembly) for damage or leaks. Inspect fuel cap gasket for an even filler neck imprint or any damage. Replace parts as needed. Periodic replacement of the fuel filter is not required.

* An Emission Control Service.

† The U.S. Environmental Protection Agency or the California Air Resources Board has determined that the failure to perform this maintenance item will not nullify the emission warranty or limit recall liability prior to the completion of vehicle useful life. General Motors, however, urges that all recommended maintenance services be performed at the indicated intervals and the maintenance be recorded in "Section E: Maintenance Record."

Maintenance Schedule

Section B: Owner Checks and Services

Listed below are owner checks and services which should be performed at the intervals specified to help ensure the safety, dependability and emission control performance of your vehicle. Be sure any necessary repairs are completed at once. Whenever any fluids or lubricants are added to your vehicle, make sure they are the proper ones, as shown in Section D.

At Each Fuel Fill *(It is important for you or a service station attendant to perform these underhood checks at each fuel fill.)*

| CHECK OR SERVICE | WHAT TO DO |
|-------------------------------|--|
| Engine Oil Level | Check the engine oil level and add the proper oil if necessary. See "Engine Oil" in the Index for further details. |
| Engine Coolant Level | Check the engine coolant level and add the proper coolant mix if necessary. See "Coolant" in the Index for further details. |
| Windshield Washer Fluid Level | Check the windshield washer fluid level in the windshield washer tank and add the proper fluid if necessary. See "Windshield Washer Fluid" in the Index for further details. |

At Least Once a Month

| CHECK OR SERVICE | WHAT TO DO |
|------------------|---|
| Tire Inflation | Check tire inflation. Make sure they are inflated to the pressures specified on the Tire-Loading Information label located on the rear edge of the driver's door. See "Tires" in the Index for further details. |
| Cassette Deck | Clean cassette deck. Cleaning should be done every 15 hours of tape play. See "Audio Systems" in the Index for further details. |

At Least Once a Year

| CHECK OR SERVICE | WHAT TO DO |
|--------------------|--|
| Key Lock Cylinders | Lubricate the key lock cylinders with the lubricant specified in Section D. |
| Body Lubrication | Lubricate all body door hinges. Also lubricate all hinges and latches, including those for the hood, rear compartment, glove box door, console door and any folding seat hardware. Section D tells you what to use. |
| Starter Switch |  CAUTION: When you are doing this check, the vehicle could move suddenly. If it does, you or others could be injured. Follow the steps below. |
| | <ol style="list-style-type: none">1. Before you start, be sure you have enough room around the vehicle.2. Firmly apply both the parking brake (see "Parking Brake" in the Index if necessary) and the regular brake. <p>NOTE: Do not use the accelerator pedal, and be ready to turn off the engine immediately if it starts.</p> <ol style="list-style-type: none">3. On automatic transmission vehicles, try to start the engine in each gear. The starter should work only in "P" (Park) or "N" (Neutral). If the starter works in any other position, your vehicle needs service. <p>On manual transmission vehicles, put the shift lever in "N" (Neutral), push the clutch down halfway and try to start the engine. The starter should work only when the clutch is pushed down all the way to the floor. If the starter works when the clutch isn't pushed all the way down, your vehicle needs service.</p> |

Maintenance Schedule

Section B: Owner Checks and Services (Cont.)

At Least Once a Year (CONT.)

| CHECK OR SERVICE | WHAT TO DO |
|--|--|
| Brake-Transmission Shift Interlock – BTSI (Automatic Transmission) | <p> CAUTION: When you are doing this check, the vehicle could move suddenly. If it does, you or others could be injured. Follow the steps below.</p> <ol style="list-style-type: none">1. Before you start, be sure you have enough room around the vehicle. It should be parked on a level surface.2. Firmly apply the parking brake (see “Parking Brake” in the Index if necessary). <p>NOTE: Be ready to apply the regular brake immediately if the vehicle begins to move.</p> <ol style="list-style-type: none">3. With the engine off, turn the key to the “RUN” position, but don’t start the engine. Without applying the regular brake, try to move the shift lever out of “P” (Park) with normal effort. If the shift lever moves out of “P” (Park), your vehicle’s BTSI needs service. |
| Steering Column Lock | <p>While parked, and with the parking brake set, try to turn the key to “LOCK” in each shift lever position.</p> <ul style="list-style-type: none">● With an automatic transmission, the key should turn to “LOCK” only when the shift lever is in “P” (Park).● With a manual transmission, the key should turn to “LOCK” only when the shift lever is in “R” (Reverse). <p>On vehicles with a key release button, try to turn the key to “LOCK” without pressing the button. The key should turn to “LOCK” only with the key button depressed. On all vehicles, the key should come out only in “LOCK.”</p> |

At Least Once a Year (CONT.)

| CHECK OR SERVICE | WHAT TO DO |
|---|---|
| Parking Brake and Automatic Transmission "P" (Park) Mechanism Check | <p> CAUTION: When you are doing this check, your vehicle could begin to move. You or others could be injured and property could be damaged. Make sure there is room in front of your vehicle in case it begins to roll. Be ready to apply the regular brake at once should the vehicle begin to move.</p> <p>Park on a fairly steep hill, with the vehicle facing downhill. Keeping your foot on the regular brake, set the parking brake.</p> <ul style="list-style-type: none">● To check the parking brake: With the engine running and transmission in "N" (Neutral), slowly remove foot pressure from the regular brake pedal. Do this until the vehicle is held by the parking brake only.● To check the "P" (Park) mechanism's holding ability: Shift to "P" (Park). Then release all brakes. |
| Underbody Flushing | At least every spring, use plain water to flush any corrosive materials from the underbody. Take care to clean thoroughly any areas where mud and other debris can collect. |

Maintenance Schedule

Section C: Periodic Maintenance Inspections

Listed below are inspections and services which should be performed at least twice a year (for instance, each spring and fall). You should let your GM dealer's service department or other qualified service center do these jobs. Make sure any necessary repairs are completed at once.

| INSPECTION OR SERVICE | WHAT SHOULD BE DONE |
|------------------------------------|---|
| Restraint Systems | Now and then, make sure all your belts, buckles, latch plates, retractors, anchorages and reminder systems are working properly. Look for any loose parts or damage. If you see anything that might keep a restraint system from doing its job, have it repaired. |
| Steering and Suspension Inspection | Inspect the front and rear suspension and steering system for damaged, loose or missing parts, signs of wear, or lack of lubrication. Inspect the power steering lines and hoses for proper hookup, binding, leaks, cracks, chafing, etc. |
| Tire and Wheel Inspection | Inspect the tires for uneven wear or damage. If there is irregular or premature wear, check the wheel alignment. Inspect for damaged wheels. |
| Exhaust System Inspection | Inspect the complete exhaust system. Inspect the body near the exhaust system. Look for broken, damaged, missing or out-of-position parts as well as open seams, holes, loose connections, or other conditions which could cause a heat build-up in the floor pan or could let exhaust fumes into the vehicle. See "Engine Exhaust" in the Index. |

| INSPECTION OR SERVICE | WHAT SHOULD BE DONE |
|------------------------------|--|
| Manual Transmission | Check the transmission fluid level; add if needed. See "Manual Transmission" in the Index. A fluid loss may indicate a problem. Check the system and repair if needed. |
| Rear Axle Service | Check the gear lubricant level in the rear axle and add if needed. See "Rear Axle" in the Index. A fluid loss may indicate a problem. Check the axle and repair it if needed. |
| Brake System Inspection | <p>Inspect the complete system. Inspect brake lines and hoses for proper hookup, binding, leaks, cracks, chafing, etc. Inspect disc brake pads for wear and rotors for surface condition. Inspect other brake parts, including calipers, parking brake, etc. You may need to have your brakes inspected more often if your driving habits or conditions result in frequent braking.</p> <p>NOTE: A low brake fluid level can indicate worn disc brake pads which may need to be serviced. Also, if the brake system warning light stays on or comes on, something may be wrong with the brake system. See "Brake System Warning Light" in the Index. If your anti-lock brake system warning light stays on or comes on, something may be wrong with the anti-lock brake system. See "Anti-Lock Brake System Warning Light" in the Index.</p> |

Maintenance Schedule

Section D: Recommended Fluids & Lubricants

NOTE: Fluids and lubricants identified below by name, part number or specification may be obtained from your GM Dealer.

| USAGE | FLUID/LUBRICANT |
|-------------------------|--|
| Engine Oil | API service SH or SG Energy Conserving II oils of the proper viscosity. To determine the preferred viscosity for your vehicle's engine, see "Engine Oil" in the Index. The engine requires a special oil meeting GM Standard GM4718M. Oils meeting this standard may be identified as synthetic, and should also be identified as API Service SH. However, not all Synthetic API Service SH oils will meet this GM Standard. You should look for and use only an oil that meets GM Standard GM4718M. |
| Engine Coolant | 50/50 mixture of water (preferably distilled) and good quality ethylene glycol base antifreeze (GM Part No. 1052753 or equivalent) conforming to GM Specification 1825M or approved recycled coolant conforming to GM Specification 1825M. |
| Hydraulic Brake System | Delco-Supreme 11 [®] Brake Fluid (GM Part No. 1052535 or equivalent DOT-3 brake fluid). |
| Hydraulic Clutch System | Hydraulic Clutch Fluid (GM Part No. 12345347 or equivalent). |
| Parking Brake Guides | Chassis lubricant (GM Part No. 1052497 or equivalent) or lubricant meeting requirements of NLGI Grade 2, Category LB or GC-LB. |
| Power Steering System | GM Synthetic Power Steering Fluid (GM Part No. 12345866 or 12345867 or equivalent). |
| Manual Transmission | Manual Transmission Fluid SAE 5W-30 (GM Part No. 1052931 or equivalent). |
| Automatic Transmission | DEXRON [®] -III or DEXRON [®] -IIE Automatic Transmission Fluid. |

| USAGE | FLUID/LUBRICANT |
|---------------------------------------|---|
| Key Lock Cylinders | Lubricate with Multi-Purpose Lubricant (GM Part No. 12345120) or synthetic SAE 5W-30 engine oil. |
| Manual Transmission Shift Linkage | Chassis lubricant (GM Part No. 1052497 or equivalent) or lubricant meeting requirements of NLGI Grade 2, Category LB or GC-LB. |
| Automatic Transmission Shift Linkage | Engine oil. |
| Clutch Linkage Pivot Points | Engine oil. |
| Floor Shift Linkage | Engine oil. |
| Chassis Lubrication | Chassis lubricant (GM Part No. 1052497 or equivalent) or lubricant meeting requirements of NLGI Grade 2, Category LB or GC-LB. |
| Rear Axle (Limited-Slip Differential) | Axle Lubricant (GM Part No. 12345977) or SAE 80W-90 GL-5 Gear Lubricant, and Limited-Slip Differential Lubricant Additive (GM Part No. 1052358 or equivalent) where required. See "Rear Axle" in the Index. |
| Windshield Washer Solvent | GM Optikleen [®] Washer Solvent (GM Part No. 1051515) or equivalent. |

Maintenance Schedule

Section D: Recommended Fluids & Lubricants (Cont.)

| USAGE | FLUID/LUBRICANT |
|---|---|
| Hood Latch Assembly a. Pivots and Spring Anchor b. Release Pawl | a. Engine oil. b. Chassis lubricant (GM Part No. 1052497 or equivalent) or lubricant meeting requirements of NLGI Grade 2, Category LB or GC-LB. |
| Hood and Door Hinges, Fuel Door Hinge, Rear Compartment Lid Hinges, Concealed Headlight Hinges, Hatch Hinges, Folding Front Seats | Engine oil or Lubriplate Lubricant (GM Part No. 1050109). |
| Weatherstrips | Dielectric Silicone Grease (GM Part No. 12345579 or equivalent). |

See "Replacement Parts" in the Index for recommended replacement filters, valves and spark plugs.

Section E: Maintenance Record

After the scheduled services are performed, record the date, odometer reading and who performed the service in the columns indicated. When completing the Maintenance Performed column, insert the numbers from the Schedule I or Schedule II maintenance charts which correspond to the maintenance performed. Also, you should retain all maintenance receipts. Your owner information portfolio is a convenient place to store them.

| DATE | ODOMETER READING | SERVICED BY | MAINTENANCE PERFORMED |
|------|------------------|-------------|-----------------------|
| | | | |
| | | | |
| | | | |
| | | | |
| | | | |
| | | | |
| | | | |
| | | | |
| | | | |
| | | | |

Maintenance Schedule

Section E: Maintenance Record (Cont.)

| DATE | ODOMETER READING | SERVICED BY | MAINTENANCE PERFORMED |
|------|---------------------|-------------|-----------------------|
| | | | |
| | | | |
| | | | |
| | | | |
| | | | |
| | | | |
| | | | |
| | | | |
| | | | |
| | | | |

| DATE | ODOMETER READING | SERVICED BY | MAINTENANCE PERFORMED |
|------|---------------------|-------------|-----------------------|
| | | | |
| | | | |
| | | | |
| | | | |
| | | | |
| | | | |
| | | | |
| | | | |
| | | | |
| | | | |

Maintenance Schedule

Section E: Maintenance Record (Cont.)

| DATE | ODOMETER READING | SERVICED BY | MAINTENANCE PERFORMED |
|------|---------------------|-------------|-----------------------|
| | | | |
| | | | |
| | | | |
| | | | |
| | | | |
| | | | |
| | | | |
| | | | |
| | | | |

Customer Assistance Information

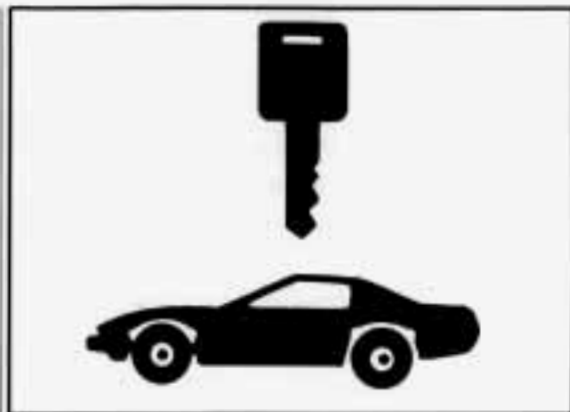

Here you will find out how to contact Chevrolet if you need assistance. This part also tells you how to obtain service publications and how to report any safety defects.

| | |
|---|-----|
| Customer Satisfaction Procedure | 252 |
| Customer Assistance for the Hearing or Speech Impaired | 252 |
| Corvette Action Center | 253 |
| GM Participation in BBB AUTO LINE – Alternative Dispute Resolution Program | 253 |
| Reporting Safety Defects | 254 |
| Chevrolet Roadside Assistance | 255 |
| Canadian Roadside Assistance | 255 |
| Courtesy Transportation | 255 |
| Service Publications. | 256 |

Customer Assistance Information

■ *Customer Satisfaction Procedure*

Your satisfaction and goodwill are important to your dealer and Chevrolet. Normally, any concern with the sales transaction or the operation of your vehicle will be resolved by your dealer's Sales or Service Departments. Sometimes, however, despite the best intentions of all concerned, misunderstandings can occur. If your concern has not been resolved to your satisfaction, the following steps should be taken:

STEP ONE: Discuss your concern with a member of dealership management. Normally, concerns can be quickly resolved at that level. If the matter has already been reviewed with the Sales, Service, or Parts Manager, contact the owner of the dealership or the General Manager.

STEP TWO: If after contacting a member of dealership management, it appears your concern cannot be resolved by the dealership without further help, contact the Chevrolet Customer Assistance Center by calling

1-800-222-1020. In Canada, contact GM of Canada Customer Assistance Center in Oshawa by calling 1-800-263-3777 (English) or 1-800-263-7854 (French). In Mexico, call (525) 254-3777. In Puerto Rico or U.S. Virgin Islands, call 1-809-763-1315. In all other overseas locations, contact GM North American Export Sales in Canada by calling 1-905-644-4112.

For prompt assistance, please have the following information available to give the Customer Assistance Representative:

- Your name, address, home and business telephone numbers
- Vehicle Identification Number (This is available from the vehicle registration or title, or the plate at the left top of the instrument panel and visible through the windshield.)
- Dealership name and location
- Vehicle delivery date and present mileage
- Nature of concern

We encourage you to call the toll-free number listed previously in order to give your inquiry prompt attention. However, if you wish to write Chevrolet, write to:

Chevrolet Customer Assistance Center
P.O. Box 7047
Troy, MI 48007-7047

Refer to your Warranty and Owner Assistance Information booklet for addresses of Canadian and GM Overseas offices.

When contacting Chevrolet, please remember that your concern will likely be resolved in the dealership, using the dealership's facilities, equipment and personnel. That is why we suggest you follow Step One first if you have a concern.

Customer Assistance for the Hearing or Speech Impaired (TDD)

To assist customers who have hearing difficulties, Chevrolet has installed special TDD (Telecommunication Devices for the Deaf) equipment at its Customer Assistance Center in Troy, Michigan. Any hearing or speech impaired customer who has access to a TDD or a conventional teletypewriter (TTY) can communicate with Chevrolet by dialing: 1-800-TDD-CHEV (1-800-833-2438). (TDD users in Canada can dial 1-800-263-3830.)

■ *Corvette Action Center*

If you have any questions, comments or problems regarding your Corvette, or Corvette in general, you can call the Corvette Action Center at 1-800-457-VETT. The Corvette Action Center is open between the hours of 6:00 a.m. to 2:30 p.m. CST, Monday through Friday.

■ *GM Participation in BBB AUTO LINE – Alternative Dispute Resolution Program* *

Both Chevrolet and your Chevrolet dealer are committed to making sure you are completely satisfied with your new vehicle. Our experience has shown that, if a situation arises where you feel your concern has not been adequately addressed, the Customer Satisfaction Procedure described earlier in this section is very successful.

There may be instances where an impartial third-party can assist in arriving at a solution to a disagreement regarding vehicle repairs or interpretation of the New Vehicle Limited Warranty. To assist

in resolving these disagreements Chevrolet voluntarily participates in BBB AUTO LINE.

BBB AUTO LINE is an out-of-court program administered by the Better Business Bureau system to settle disputes between customers and automobile manufacturers. This program is available free of charge to customers who currently own or lease a GM vehicle.

If you are not satisfied after following the Customer Satisfaction Procedure, you may contact the BBB using the toll-free telephone number, or write them at the following address:

BBB AUTO LINE
Council of Better Business Bureaus
4200 Wilson Boulevard
Suite 800
Arlington, VA 22203
Telephone: 1-800-955-5100

To file a claim, you will be asked to provide your name and address, your vehicle identification number (VIN), and a statement of the nature of your complaint. Eligibility is limited by vehicle age and mileage, and other factors.

We prefer you utilize the Customer Satisfaction Procedure before you resort

to AUTO LINE, but you may contact the BBB at any time. The BBB will attempt to resolve the complaint serving as an intermediary between you and Chevrolet. If this mediation is unsuccessful, an informal hearing will be scheduled where eligible customers may present their case to an impartial third-party arbitrator.

The arbitrator will make a decision which you may accept or reject. If you accept the decision, GM will be bound by that decision. The entire dispute resolution procedure should ordinarily take about forty days from the time you file a claim until a decision is made.

Some state laws may require you to use this program before filing a claim with a state-run arbitration program or in the courts. For further information, contact the BBB at 1-800-955-5100 or the Chevrolet Customer Assistance Center at 1-800-222-1020.

* This program may not be available in all states, depending on state law. Canadian owners refer to your Warranty and Owner Assistance information booklet. General Motors reserves the right to change eligibility limitations and/or to discontinue its participation in this program.

Customer Assistance Information

■ *Reporting Safety Defects to the United States Government*

If you believe that your vehicle has a defect which could cause a crash or could cause injury or death, you should immediately inform the National Highway Traffic Safety Administration (NHTSA), in addition to notifying General Motors.

If NHTSA receives similar complaints, it may open an investigation, and if it finds that a safety defect exists in a group of vehicles, it may order a recall and remedy campaign. However, NHTSA cannot become involved in individual problems between you, your dealer, or General Motors.

To contact NHTSA, you may either call the Auto Safety Hotline toll-free at 1-800-424-9393 (or 366-0123 in the Washington, D.C. area) or write to:

NHTSA
U.S. Department of Transportation
Washington, D.C. 20590

You can also obtain other information about motor vehicle safety from the Hotline.

■ *Reporting Safety Defects to the Canadian Government*

If you live in Canada, and you believe that your vehicle has a safety defect, you should immediately notify Transport Canada, in addition to notifying General Motors of Canada Limited. You may write to:

Transport Canada
Box 8880
Ottawa, Ontario K1G 3J2

■ *Reporting Safety Defects to General Motors*

In addition to notifying NHTSA (or Transport Canada) in a situation like this, we certainly hope you'll notify us. Please call us at 1-800-222-1020, or write:

Chevrolet Customer Assistance Center
P.O. Box 7047
Troy, MI 48007-7047

In Canada, please call us at
1-800-263-3777 (English) or
1-800-263-7854 (French).

Or, write:

General Motors of Canada Limited
Customer Assistance Center
1908 Colonel Sam Drive
Oshawa, Ontario L1H 8P7



■ ***Chevrolet Roadside Assistance***

To enhance Chevrolet's strong commitment to customer satisfaction, Chevrolet is excited to provide the services of the Chevrolet/Geo Roadside Assistance Center.

Roadside Assistance is available 24 hours a day, 365 days a year, by calling 1-800-CHEV USA (1-800-243-8872). This toll-free number will provide you over-the-phone roadside assistance with minor mechanical problems. If your problem cannot be resolved over the phone, our advisors have access to a nationwide network of dealer

recommended service providers. The following services are available:

- Towing
- Locksmith
- Tire Repair
- Rental car or taxi
- Additional services as necessary

The Roadside Assistance Center uses companies that will provide you with quality and priority service. When roadside services are required, our advisors will explain any payment obligations that may be incurred for utilizing outside services.

For prompt assistance when calling, please have the following available to give to the advisor:

- Vehicle Identification Number
- License plate number
- Vehicle color
- Vehicle location
- Telephone number where you can be reached
- Vehicle mileage
- Description of problem

■ ***Canadian Roadside Assistance***

Vehicles purchased in CANADA have an extensive ROADSIDE ASSISTANCE Program accessible from anywhere in Canada or the U.S.A. Please refer to the separate brochure provided by the dealer or call 1-800-268-6800 for emergency services.

■ ***Courtesy Transportation***

Chevrolet offers Courtesy Transportation for customers needing warranty service. Courtesy Transportation will be offered in conjunction with the coverage provided by the BUMPER TO BUMPER New Vehicle Limited Warranty to retail and retail lease purchasers of 1994 Chevrolet passenger cars and light-duty trucks.

Courtesy Transportation includes:

- One-way SHUTTLE RIDE for any warranty repair completed during the same day.
- Up to \$30 maximum daily VEHICLE RENTAL allowance for any overnight warranty repair up to 5 days.

OR

Customer Assistance Information

- Up to \$30 maximum daily CAB, BUS, or OTHER public transportation allowance in lieu of rental for any overnight warranty repair up to 5 days.

OR

- Up to \$10 daily FUEL allowance for rides provided by another person (i.e., friend, neighbor, etc.) in lieu of rental or other public transportation for any overnight warranty repair up to 5 days.

Note: All Courtesy Transportation arrangements will be administered by your Chevrolet dealership service management. Claim amounts should reflect all actual costs.

- Chevrolet Courtesy Transportation is not part of the BUMPER TO BUMPER New Vehicle Limited Warranty. Chevrolet reserves the right to make any changes or discontinue Courtesy Transportation at any time without notification.
- For additional program details, contact your Chevrolet dealer.

In Canada, please consult your GM Dealer for information on courtesy transportation.

■ *Service Publications*

Information on how to obtain Product Service Publications (PSP's) and Indexes as described below is applicable only in the fifty U.S. states (and the District of Columbia) and only for cars and light trucks with GVWR less than 10,000 pounds (4 536 kg).

In Canada, information pertaining to Product Service Bulletins and Indexes can be obtained by writing to:

General Motors of Canada Limited
Service Publications Department
1908 Colonel Sam Dr.
Oshawa, Ontario L1H 8P7

Chevrolet regularly sends its dealers useful service bulletins about Chevrolet products. Chevrolet monitors product performance in the field. We then prepare bulletins for servicing our products better. Now, you can get these bulletins too.

Bulletins cover various subjects. Some pertain to the proper use and care of your vehicle. Some describe costly repairs. Others describe inexpensive repairs which, if done on time with the latest parts, may avoid future costly repairs. Some bulletins tell a technician how to repair a new or unexpected condition.

Others describe a quicker way to fix your vehicle. They can help a technician service your vehicle better.

Most bulletins apply to conditions affecting a small number of cars or trucks. Your Chevrolet dealer or a qualified technician may have to determine if a specific bulletin applies to your vehicle.

Individual PSP's

If you don't want to buy all the PSP's issued by Chevrolet for all car or truck models in the model year, you can buy individual PSP's, such as those which may pertain to a particular model. To do this, you will first need to see our index of PSP's. It provides a variety of information. Here's what you'll find in the index and how you can get one:

What You'll Find in the Index:

- A list of all PSP's published by Chevrolet in a model year (1990 or later). PSP's covering all models of Chevrolet cars or light trucks (less than 10,000 pounds (4 536 kg) GVWR) are listed in the same index.
- Ordering information so you can buy the specific PSP's you may want.
- Price information for the PSP's you may want to buy.

How You Can Get an Index:

Indexes are published periodically. Most of the PSP's which could potentially apply to the most recent Chevrolet models will be listed in the most recent publication for that model year. This means you may want to wait until the end of the model year before ordering an index, if you are interested in buying PSP's pertaining to a current model year car or truck.

Some PSP's pertaining to a particular model year vehicle may be published in later years, and these would be listed in the later year's index. When you order an index for a model year that is not over yet, we'll send you the most recently published issue. Check the ordering form for indexes for earlier model years.

Cut out the ordering form, fill it out, and mail it in. We will then see to it that an index is mailed to you. There is no charge for indexes for the 1990-1994 model years.

Toll-Free Telephone Number

If you want an additional ordering form for an index, just call toll-free and we'll be happy to send you one. Automated recording equipment will take your name and mailing address. The number to call is 1-800-551-4123.

A VERY IMPORTANT REMINDER:

These PSP's are meant for technicians. They are not meant for the "do-it-yourselfer." Technicians have the equipment, tools, safety instructions, and know-how to do a job quickly and safely.

Chevrolet Service Publications

You can get these by using the order form:

Customer Assistance Information

1994 CHEVROLET SERVICE PUBLICATIONS ORDERING INFORMATION

The following publications covering the operation and servicing of your vehicle can be purchased by filling out the Service Publications Order Form in this book and mailing it with your check, money order or credit card information to Helm, Incorporated (address listed below).

CURRENT PUBLICATIONS FOR 1994 CHEVROLET CORVETTE

PRODUCT SERVICE PUBLICATIONS

Product Service Publications (PSP's), are bulletins, letters and articles published for trained dealer service personnel. See Service Publications listed previously in this section.

A cumulative index is published quarterly during the current model year. The indexes list all PSP's published by Chevrolet in the model year.

PSP Index

| Year | Form Number | Price |
|---------|------------------|-------|
| 1994 | PSP1-94 | Free |
| 1993 | PSP1-93 | Free |
| 1990-92 | PSP1-90-92 | Free |

PSP Bound Bulletin Book (Complete Year Bulletins)

| Year | Description | Form Number | Price |
|------|-----------------|-------------|-------|
| 1991 | All PSP's | PSP-91-4 | 40.00 |
| 1990 | All PSP's | PSP-90-4 | 40.00 |

For subscription information call Helm, Incorporated.

CURRENT & PAST MODEL ORDER FORMS

Service Publications are available for current and past model Chevrolet vehicles. To request an order form, please specify year and model name of vehicle.

SERVICE MANUALS

Service Manuals have the diagnosis, repair and overhaul information on engines, transmission, axle, suspension, brakes, electrical, steering, body, etc.

| Model | Form Number | Price |
|-------------------------------|-------------|-------|
| 1994 Chevrolet Corvette | ST-364-94 | TBA* |

NOTE: Please specify special body or engine types on order form. Write information in the Form Number column. For example: Turbo, Convertible.

*Price to be announced at a later date. Call 1-800-782-4356 for further information.

OWNER'S INFORMATION

Owner publications are written directly for owners and intended to provide basic operational information about the vehicle.

1994 Chevrolet Corvette Owner's Manual

In Portfolio: Includes Portfolio, Owner's Manual and Warranty Booklet.

1994 Chevrolet Corvette In-Portfolio 10260935 \$60.00
(Not including ZR1)

1994 Chevrolet Corvette ZR1 In-Portfolio . . 10260937 \$70.00

Without Portfolio: Includes Owner's Manual.

1994 Chevrolet Corvette Without Portfolio . 10260941 \$20.00

Address all inquiries to: HELM, INCORPORATED
P.O. Box 07130
Detroit, MI 48207

For information and inquiries call: 1-800-782-4356

| | | | | | |
|-------------------------------------|-----|------------------------------------|-----|--------------------------------------|----------|
| A BS | 125 | Ashtray and Lighter | 75 | Battery | 195 |
| Acceleration Slip Regulation | | ASR System | 126 | Battery Replacement, Passive Keyless | |
| System | 126 | Active Light | 87 | Entry System | 41 |
| Accessory Plug | 76 | Off Light | 86 | BBB Auto Line – Alternative | |
| Acrylic Roof Panel | 70 | Warning Light | 86 | Dispute Resolution Program, | |
| Adding Coolant | 189 | Audio Systems | 112 | GM Participation in | 253 |
| Add-On Electrical Equipment | 218 | Audio Systems, Comfort | | Before Leaving on a Long Trip | 135 |
| Air Bag System | 23 | Controls and | 105 | Belt, Lap-Shoulder | 20 |
| How the System Works | 24 | Automatic Electronic Climate | | Bi-Level | 107 |
| Servicing Your Air Bag- | | Control | 108 | Blizzard, If You're Caught in a | 138 |
| Equipped Corvette | 26 | Air Control Buttons | 108 | Block Heater, Engine | 50 |
| Readiness Light | 24 | Automatic Control | 109 | Brakes | |
| Air Cleaner | 182 | Defogging and Defrosting | | Adjustment | 194 |
| Air Conditioner Controls | 106 | Windows | 110 | Anti-Lock (ABS) | 125 |
| Air Control Buttons | 106 | Fan Control Buttons | 108 | Fluid | 193 |
| Air Filter Replacement | 183 | Manual Bi-Level | 109 | Master Cylinder | 193 |
| Alignment and Tire Balance, Wheel . | 208 | Manual Cooling | 109 | Parking | 56 |
| Aluminum Wheels | 215 | Manual Heating | 109 | Pedal Travel | 194 |
| AM/FM Stereo | | Manual Ventilation | 109 | System Parts, Replacing | 194 |
| With Cassette Tape Player | 113 | System Problems | 110 | System Warning Light | 84 |
| With Cassette Tape and | | Temperature Control Switch | 108 | Wear Indicators, Disc | 194 |
| Compact Disc Player | 115 | Temperature Sensors | 108 | Braking (Control of a Vehicle) | 124 |
| Antenna, Power Mast, Care | 118 | Automatic Transmission | 51 | Braking in Emergencies | 127 |
| Anti-Lock Brakes | 125 | Automatic Transmission Fluid | 184 | "Break-In," New Vehicle | 46 |
| System Active Light | 86 | Axle, Limited-Slip Rear | 56 | Brightness Control | 67 |
| System Warning Light | 85 | Axle, Rear | 188 | Bulb Replacement | 195 |
| To Use | 126 | B abies, Smaller Children | | Back-up Light | 198 |
| Appearance Care | 210 | and (Safety Belts) | 28 | Center High-Mounted | |
| Appearance Care and Materials | 217 | Balance, Wheel Alignment | | Stoplight | 200, 201 |
| Appearance Care, Service and | 171 | and Tire | 208 | Cornering Light | 199 |
| | | | | Fog Lamp | 196 |

Index

- Bulb Replacement
 Front Turn Signal 197
 Headlights 195
 Rear Cargo Compartment Light .. 200
 Rear Turn Signal and Taillight ... 197
 Sidemarker 199
Bulbs, Halogen 195
Bulbs, Replacement 223
- C**anadian Roadside Assistance ... 255
Capacities and Specifications 224
Carbon Monoxide 59
Care of Safety Belts 212
Cassette Tape and Compact Disc
 Player, AM/FM Stereo with 115
Cassette Tape Player, AM/FM
 Stereo with 113
Cassette Tape Player, Care of Your .. 117
Center Console 72
Chains, Tire 209
Changing a Flat Tire 159
Changing System Light 94
Check Gauges Light 93
Checking Things under the
 Hood 175
Checking Your Restraint Systems ... 33
Chemical Paint Spotting 216
Chevrolet Roadside
 Assistance 255
Chevrolet Service Publications
 (Ordering Information) 258
- Child Restraints 29
 Passenger Seat 30
 Top Strap 29
Children (Safety Belts) 28
Children, Larger (Safety Belts) 31
Cigarette Lighter 76
Cinch Feature, Lap Belt 21
Circuit Breakers, Fuses and 219
City Driving 134
Cleaner, Air 182
Cleaning
 Convertible Top 214
 Dulso-Coated Moldings 213
 Engine 215
 Fabric 211
 Glass 213
 Hardtop, and Storage of 215
 Inside of Your Corvette 210
 Instrument Panel, Top of 212
 Leather 212
 Outside of Your Corvette 214
 Problems, Special 211
 Removable Roof Panel 213
 Soft-Touch Surfaces 212
 Speaker Covers 212
 Tires 215
 Vinyl 212
 Windshield and
 Wiper Blades 213
Climate Control, Automatic
 Electronic 108
- Clock, Setting the 113
Cluster, Instrument 80
Clutch, Hydraulic 187
Comfort Controls 106
Comfort Controls and Audio
 Systems 105
Compact Disc Player, AM/FM
 Stereo with Cassette Tape and ... 115
Compact Discs, Care of Your 118
Compact Disc, To Play a 116
Compact Spare Tire 169
Compartments, Storage and 72
Concealed Headlights 67
Console, Center 72
Control of a Vehicle 124
Control, Loss of 130
Controls
 Air Conditioner 106
 Brightness 67
 Comfort 106
 Cruise 64
 Features and 35
 Seat 12
Convertible Hardtop 100
 To Install Your 103
 To Remove Your 100
Convertible Top 96
 Cleaning Your 214
 To Lower Your 96
 To Raise Your 99
Convex Outside Mirror 69

| | | | |
|---------------------------------|----------|--------------------------------|-----|
| Coolant | | | |
| Adding | 189 | | |
| Engine | 188 | | |
| Heater, Engine | 50 | | |
| How to Add to the Coolant | | | |
| Recovery Tank | 153 | | |
| How to Add to the Coolant | | | |
| High Fill Reservoir | 154, 157 | | |
| Temperature Gage, Engine | 89 | | |
| Cooling | 107 | | |
| Cooling System | 151, 152 | | |
| Corvette Action Center | 253 | | |
| Courtesy Lights | 68 | | |
| Courtesy Transportation | 255 | | |
| Cruise Control | 64 | | |
| Passing Another Vehicle | | | |
| While Using | 66 | | |
| To Erase Speed Memory | 66 | | |
| To Get Out of | 66 | | |
| To Increase Speed While Using | 65 | | |
| To Reduce Speed | | | |
| While Using | 65 | | |
| To Resume a Set Speed | 65 | | |
| To Set | 64 | | |
| Using on Hills | 66 | | |
| Curves, Driving on | 127 | | |
| Customer Assistance | | | |
| for the Hearing or Speech | | | |
| Impaired (TDD) | 252 | | |
| Customer Assistance Information | 251 | | |
| Customer Satisfaction Procedure | 252 | | |
| | | D | |
| | | Daytime Running Lights | 68 |
| | | Deep Standing Water, | |
| | | Driving through | 50 |
| | | Defects, Safety | |
| | | Reporting to General Motors | 254 |
| | | Reporting to the Canadian | |
| | | Government | 254 |
| | | Reporting to the United States | |
| | | Government | 254 |
| | | Defensive Driving | 122 |
| | | Defogger, Rear Window | 111 |
| | | Defogging and Defrosting | |
| | | Windows | 107 |
| | | Delayed Accessory Bus | 47 |
| | | Delco-Bose® AM/FM Stereo | |
| | | with Cassette Tape and | |
| | | Compact Disc Player | 115 |
| | | Dimensions, Vehicle | 227 |
| | | Dimmer (Brightness Control) | 67 |
| | | Disc Break Wear Indicators | 194 |
| | | Doing Your Own Service | |
| | | Work | 172 |
| | | Door | |
| | | Ajar Light | 94 |
| | | Locks | 37 |
| | | Locks, Power | 38 |
| | | Storage Compartment | 73 |
| | | Downshifting | 55 |
| | | Driver Information Center | 80 |
| | | Driver Position (Safety Belts) | 19 |
| | | | |
| | | D | |
| | | Driving | |
| | | At Night | 131 |
| | | City | 134 |
| | | Defensive | 122 |
| | | Drunken | 122 |
| | | Freeway | 134 |
| | | In the Rain | 132 |
| | | On Curves | 127 |
| | | On Snow or Ice | 138 |
| | | Through Deep Standing Water | 50 |
| | | Winter | 137 |
| | | Drunken Driving | 122 |
| | | E | |
| | | ECM Engine Fuse Block | 222 |
| | | Electrical Equipment, Add-On | 218 |
| | | Emergencies, Braking in | 127 |
| | | Emergencies, Steering in | 128 |
| | | Engine | |
| | | Cleaning | 215 |
| | | Coolant | 188 |
| | | Coolant (Block) Heater | 50 |
| | | Coolant Temperature Gauge | 89 |
| | | Exhaust | 59 |
| | | Identification | 218 |
| | | Oil | 178 |
| | | Oil Life Monitor | 94 |
| | | Oil Pressure Gauge | 91 |
| | | Oil Temperature Gauge | 92 |
| | | Overheating | 150 |
| | | Power Switch | 49 |

Index

- Engine
 Running 58, 59
 Starting Your 47
Environment, Your Vehicle
 and the 230
Exhaust, Engine 59
Extended Mobility Tires 205
Extender, Safety Belt 33
- F**abric Protection 211
Fan Control Buttons 106
Features and Controls 35
Fiberglass Springs 216
Filling Your Tank 174
Finish Care (Paint) 214
Finish Damage (Paint) 215
Flashers, Hazard Warning 142
Flat Tire, Changing a 159
Flat Tire, Storing a 167, 168
Flat, If a Tire Goes 159
- Fluid
 Automatic Transmission 184
 Manual Transmission 186
 Power Steering 191
 Recommended 244
 Windshield Washer 192
Fog Lights 68
Foreign Countries, Fuels in 174
Foreign Material Paint Damage 215
Forward Lamp Fuse Block 222
Freeway Driving 134
- Front
 Map Lights 68
 Seat, Manual 12
 Towing Hook-ups 148
Fuel 173
Fuel Gage 83
Fuels in Foreign Countries 174
Fuse Block
 ECM Engine 222
 Forward Lamp 222
 Instrument Panel 220
 Fuses and Circuit Breakers 219
- G**asolines for Cleaner Air 173
Gauges
 Engine Coolant Temperature 89
 Engine Oil Pressure 91
 Engine Oil Temperature 92
 Fuel 83
 Markings 82
 Readings, Numeric 83
 Warning Lights and Indicators 82
Glass 213
GM Participation in BBB Auto Line –
 Alternative Dispute Resolution
 Program 253
- H**alogen Bulbs 195
Hardtop, Cleaning and Storage of .. 215
Hardtop, Convertible 100
Hatch Release, Remote 41
- Hazard Warning Flashers 142
Headlights 67
Headlight Doors 67
Headlight High/Low Beam 62
Heater, Engine Coolant (Block) 50
Heating 107
Highway Hypnosis 135
Hill and Mountain Roads 136
Hood Release 175
Hood, Checking Things under the .. 175
Hook-Ups, Front Towing 148
Hook-Ups, Rear Towing 149
Horn 60
How to Add Coolant to the
 Coolant Recovery Tank 153
How To Add Coolant to the
 Coolant High Fill
 Reservoir 154, 157
Hydraulic Clutch 187
Hydroplaning 133
Hypnosis, Highway 135
- I**dentification Number, Vehicle 218
Idling, Rough 50
If a Tire Goes Flat 159
If You're Stuck: In Sand, Mud, Ice
 or Snow 169
Ignition Switch 46
Inflation – Tire Pressure 206
Inside Day/Night Rearview
 Mirror 69

| | | | | | |
|---|-----|----------------------------------|-----|----------------------------------|-----|
| Instrument Cluster | 80 | Lights | | Locks | |
| Instrument Panel | 78 | ASR Off | 86 | Door | 37 |
| Instrument Panel Fuse Block | 220 | ASR System Warning | 86 | Power Door | 38 |
| Instrument Panel, Cleaning the | | Brake System Warning | 84 | Loss of Control | 130 |
| Top of | 212 | Bulb Replacement | 195 | Low Coolant Light | 93 |
| Interior Lights | 68 | Charging System | 94 | Low Oil Light | 93 |
| J ump Starting | 143 | Check Gauges | 93 | Low Tire Pressure Warning | |
| K ey in the Ignition (Theft) | 43 | Courtesy | 68 | System | 87 |
| Key Release Button | 47 | Daytime Running | 68 | Lubricants, Recommended | 244 |
| Keyless Entry System, Passive | 38 | Door Ajar | 94 | M aintenance | |
| Keys | 36 | Fog | 68 | Inspections, Periodic | 242 |
| L ane Change Indicator, | | Front Map | 68 | Record | 247 |
| Turn Signal and | 61 | Gauges and Indicators, | | Schedule | 229 |
| Lap Belt Cinch Feature | 21 | Warning | 82 | Services, Scheduled | 231 |
| Lap-Shoulder Belt (Safety Belts) | 20 | Interior | 68 | Malfunction Indicator Lamp | 91 |
| Larger Children (Safety Belts) | 31 | Low Coolant | 93 | Manual | |
| Latches, Seatback | 13 | Low Oil | 93 | Front Seat | 12 |
| Leaving Your Vehicle | 38 | Low Tire Pressure Warning | 87 | Reclining Seatbacks | 13 |
| Leaving Your Vehicle with the | | Malfunction Indicator Lamp | 91 | Transmission | 53 |
| Engine Running | 58 | One to Four | 55 | Transmission Fluid | 186 |
| Lighter, Ashtray and | 75 | Operation of | 66 | Map Lights, Front | 68 |
| Lights | | Parking Brake Indicator | 85 | Master Cylinder, Brake | 193 |
| Air Bag Readiness | 24 | Passive Keyless Entry | 95 | Mirrors | |
| Anti-Lock Brake System | | Safety Belt Reminder | 19 | Convex Outside | 69 |
| Active | 86 | Security | 96 | Inside Day/Night Rearview | 69 |
| Anti-Lock Brake System | | Service Engine Soon | 91 | Power Remote Control | 69 |
| Warning | 85 | Service LTPWS | 89 | Visor Vanity, Covered | 75 |
| ASR Active | 87 | Service Ride Control | 95 | Monitor, Engine Oil Life | 94 |
| | | Lights On Reminder | 67 | | |
| | | Limited-Slip Rear Axle | 56 | | |
| | | Loading Your Vehicle | 202 | | |

Index

- N**ew Vehicle "Break-In" 46
Night, Driving at 131
Night Vision 131
Noise Reduction 113
Numeric Gauge Readings 83
- O**dometer, Speedometer and 80
Odometer, Trip 81
Off-Road Recovery 129
Off-Road Track Use 49
Oil Pressure Gauge, Engine 91
Oil Temperature Gauge, Engine 93
Oil, Engine 178
One to Four Light 55
Operation of Lights 66
Overheating, Engine 150
Owner Checks and Services 238
- P** (Park), Shifting into 57
P (Park), Shifting out of 58
- Paint**
Chemical Spotting 216
Finish Care 214
Finish Damage 215
Foreign Material 215
- Parking**
At Night 43
Brake 56
Brake Indicator Light 85
Lots 43
- Parking**
Over Things That Burn 59
Your Vehicle 58
PASS-Key 45
Passenger Position (Safety Belts) ... 27
Passenger Seat, Securing a
Child Restraint in the 30
Passing 129
Passive Keyless Entry Light 95
Passive Keyless Entry System 38
Pedal Travel, Brake 194
Periodic Maintenance Inspections .. 242
Plug, Accessory 76
PKE 38
- Power**
Antenna Mast Care 118
Door Locks 38
Remote Control Mirrors 69
Seat 12
Steering 127
Steering Fluid 191
Switch, Engine 49
Windows 60
- Pregnancy, Safety Belt Use**
during 27
- Problems on the Road** 141
- Publications, Service** 256
- Q**uestions Many People Ask about
Safety Belts – and the Answers,
Here are 18
- R**adio Reception,
Understanding 117
- Radio, To Play the**
AM/FM Stereo with Cassette
Tape Player 113
AM/FM Stereo with Cassette
Tape and Compact
Disc Player 115
- Rain, Driving in the** 132
- Rainy Weather Tips, Some**
Other 133
- Rear Axle** 188
- Rear Axle, Limited-Slip** 56
- Rear Storage Compartment** 73
- Rear Towing Hook-Ups** 149
- Rear Window Defogger** 111
- Rearview Mirror,**
Inside Day/Night 69
- Reclining Seatbacks, Manual** 13
- Recommended Fluids**
and Lubricants 244
- Recovery, Off-Road** 129
- Release Button, Key** 47
- Release, Hood** 175
- Release, Remote Hatch** 41
- Reminder Light, Safety Belt** 19
- Reminder, Lights On** 67
- Remote Control Mirrors, Power** 69
- Remote Hatch Release** 41

| | | | | | |
|--|-----|---------------------------------------|-----|--------------------------------------|-----|
| Replacement | | Running Your Engine while | | Scheduled Maintenance Services . . . | 231 |
| Air Filter | 183 | You're Parked | 59 | Scheduled Maintenance Services, | |
| Battery, Passive Keyless Entry | | S afety Belts | | Explanation of | 236 |
| System | 41 | Adults | 19 | Seatback | |
| Bulbs (Part Numbers) | 223 | Air Bag System | 21 | Latches | 13 |
| Bulbs (Service) | 195 | Care of | 212 | Manual Reclining | 13 |
| Parts | 225 | Checking | 33 | Seats | |
| Wheel | 208 | Children | 28 | And Restraint Systems | 11 |
| Wheels, Used | 209 | Extender | 33 | And Seat Controls | 12 |
| Replacing Brake System Parts | 194 | How to Wear Properly | 19 | Manual Front | 12 |
| Replacing Safety Belts after | | Label | 33 | Power | 12 |
| a Crash | 33 | Lap Belt Cinch Feature | 21 | Sport | 13 |
| Reporting Safety Defects | 254 | Lap-Shoulder | 20 | Securing a Child Restraint in the | |
| Restraint Systems, Seats and | | Larger Children | 31 | Passenger Seat | 30 |
| Restraints | | Passenger Position | 27 | Security Light | 96 |
| Checking Your System | 33 | Questions People Ask | 18 | Security Shade | 74 |
| Child | 29 | Reminder Light | 19 | Selective Ride Control | 56 |
| Ride Control, Selective | 56 | Replacing after a Crash | 33 | Service | 172 |
| Road, Problems on the | 141 | Smaller Children and Babies | 28 | and Appearance Care | 171 |
| Road, Your Driving and the | 121 | They're for Everyone | 14 | Engine Soon Light | 91 |
| Roads, Hill and Mountain | 136 | Use during Pregnancy | 27 | LTPWS Light | 89 |
| Roadside Assistance, Canadian | 255 | Why They Work | 15 | Parts Identification Label | 218 |
| Roadside Assistance, Chevrolet | 255 | Safety Defects | | Publications | 256 |
| Rocking Your Vehicle to Get It Out | 170 | Reporting to General Motors | 254 | Publications Ordering Information, | |
| Roof Panel | | Reporting to the Canadian | | Chevrolet | 258 |
| Installing | 72 | Government | 254 | Ride Control Light | 95 |
| Removing | 70 | Reporting to the United States | | Work, Doing Your Own | 172 |
| Storing | 71 | Government | 254 | Servicing Your Air Bag-Equipped | |
| Rotation, Tire | 206 | Safety Warnings and Symbols | 8 | Corvette | 26 |
| Rough Idling | 50 | Schedule, Maintenance | 229 | Setting the Clock | 113 |
| Running Lights, Daytime | 68 | | | Shade, Security | 74 |

Index

| | | | | | |
|--------------------------------------|-----|-------------------------------------|----------|------------------------------------|----------|
| Shift Speeds | 54 | Storage | | Tires | |
| Shifting into P (Park) | 57 | Rear | 73 | Inspection and Rotation | 206 |
| Shifting out of P (Park) | 58 | Vehicle | 195 | Low Tire Pressure Warning | |
| Six-Speed Manual Transmission | 53 | Storing a Flat Tire | 167, 168 | System | 87 |
| Skidding | 130 | Stuck: In Sand, Mud, Ice or Snow .. | 169 | Storing a Flat | 167, 168 |
| Smaller Children and Babies | | Sun Visors | 74 | Temperature Grades | 208 |
| (Safety Belts) | 28 | Switch, Ignition | 46 | Traction Grades | 208 |
| Snow or Ice, Driving on | 138 | Symbols, Safety Warnings and | 8 | Treadwear | 207 |
| Spare Tire, Compact | 169 | Symbols, Vehicle | 10 | Uniform Quality Grading | 207 |
| Speakers, Adjusting the | | System Problems (Electrical) | 82 | When It's Time for New | 207 |
| AM/FM Stereo with Cassette | | T achometer | 81 | Tone, Setting the | |
| Tape Player | 114 | Tank, Filling Your | 174 | AM/FM Stereo with Cassette | |
| AM/FM Stereo with Cassette Tape | | Temperature Control Lever | 106 | Tape Player | 113 |
| and Compact Disc Player | 115 | Theft | 43 | AM/FM Stereo with Cassette | |
| Specifications, Capacities and | 224 | Theft Deterrent, PASS-Key | 45 | Tape and Compact Disc | |
| Speedometer and Odometer | 80 | Theft Deterrent, Universal | 44 | Player | 115 |
| Sport Seat | 13 | Thermostat | 190 | Top Strap (Child Restraints) | 29 |
| Springs, Fiberglass | 216 | Tilt Wheel | 61 | Top, Convertible | 96 |
| Starting Your Engine | 47 | Tips, Steering | 127 | Torque Lock | 58 |
| Starting, Jump | 143 | Tips, Ventilation | 112 | Towing | |
| Steam Coming from Your Engine, | | Tire Loading | 202 | A Trailer | 139 |
| If There Is | 150 | Tires | 204 | Front Hook-Ups | 148 |
| Steam, If There Is No | 151 | Balance, Wheel Alignment and .. | 208 | Rear Hook-Ups | 149 |
| Steering | 127 | Buying New | 207 | Your Vehicle | 146 |
| Fluid, Power | 191 | Chains | 209 | Track Use, Off Road | 49 |
| In Emergencies | 128 | Changing a Flat | 159 | Trailer, Towing a | 139 |
| Power | 127 | Cleaning | 215 | Transmission | |
| Tips | 127 | Compact Spare | 169 | Automatic | 51 |
| Storage | | Extended Mobility | 205 | Fluid, Automatic | 184 |
| Compartments | 72 | Inflation Pressure | 206 | Fluid, Manual | 186 |
| Door | 73 | | | Manual | 53 |

| | | | |
|-----------------------------------|-----|--|--|
| Transmitters, Passive Keyless | | | |
| Entry System | 40 | | |
| Transportation, Courtesy | 255 | | |
| Trip Odometer | 81 | | |
| Trip, Before Leaving on a Long | 135 | | |
| Turn Signal and Lane Change | | | |
| Indicator | 61 | | |
| Turn Signal/Headlight Beam | | | |
| Lever | 61 | | |
| U nderbody Maintenance | 216 | | |
| Uniform Tire Quality Grading | 207 | | |
| Universal Theft Deterrent | 44 | | |
| Used Replacement Wheels | 209 | | |
| V ehicle | | | |
| Control of a | 124 | | |
| Damage Warnings | 8 | | |
| Dimensions | 227 | | |
| Environment and Your | 230 | | |
| Identification Number (VIN) | 218 | | |
| Leaving Your | 38 | | |
| Loading Your | 202 | | |
| Parking Your | 58 | | |
| Storage | 195 | | |
| Symbols | 10 | | |
| Towing Your | 146 | | |
| Washing Your | 214 | | |
| Ventilation | 107 | | |
| Ventilation System, | | | |
| Flow-Through | 111 | | |
| Ventilation Tips | 112 | | |
| Vision, Night | 131 | | |
| Visor Vanity Mirror, Covered | 75 | | |
| Visors, Sun | 74 | | |
| Voltmeter | 90 | | |
| W arning | | | |
| Devices, Other | 142 | | |
| Hazard Flashers | 142 | | |
| Lights, Gauges and Indicators | 82 | | |
| Safety | 8 | | |
| Vehicle Damage | 8 | | |
| Washer Fluid, Windshield | 192 | | |
| Washer, Windshield | 63 | | |
| Washing Your Vehicle | 214 | | |
| Water, Driving Through | | | |
| Deep Standing | 50 | | |
| Weatherstrips | 215 | | |
| Wheel Nut Torque | 225 | | |
| Wheel, Tilt | 61 | | |
| W heels | | | |
| Alignment and Tire Balance | 208 | | |
| Aluminum | 215 | | |
| Replacement | 208 | | |
| Used Replacement | 209 | | |
| Why Safety Belts Work | 15 | | |
| Windows | 60 | | |
| Defogging and Defrosting | 107 | | |
| Power | 60 | | |
| Rear Defogger | 111 | | |
| Windshield | | | |
| Cleaning | 213 | | |
| Specially Treated | 111 | | |
| Washer | 63 | | |
| Washer Fluid | 192 | | |
| Wipers Blades | 202 | | |
| Wipers | 62 | | |
| Winter Driving | 137 | | |
| Wipers, Windshield | 62 | | |
| Y our Driving and the Road | 121 | | |

Notes

Notes

Service Station Information

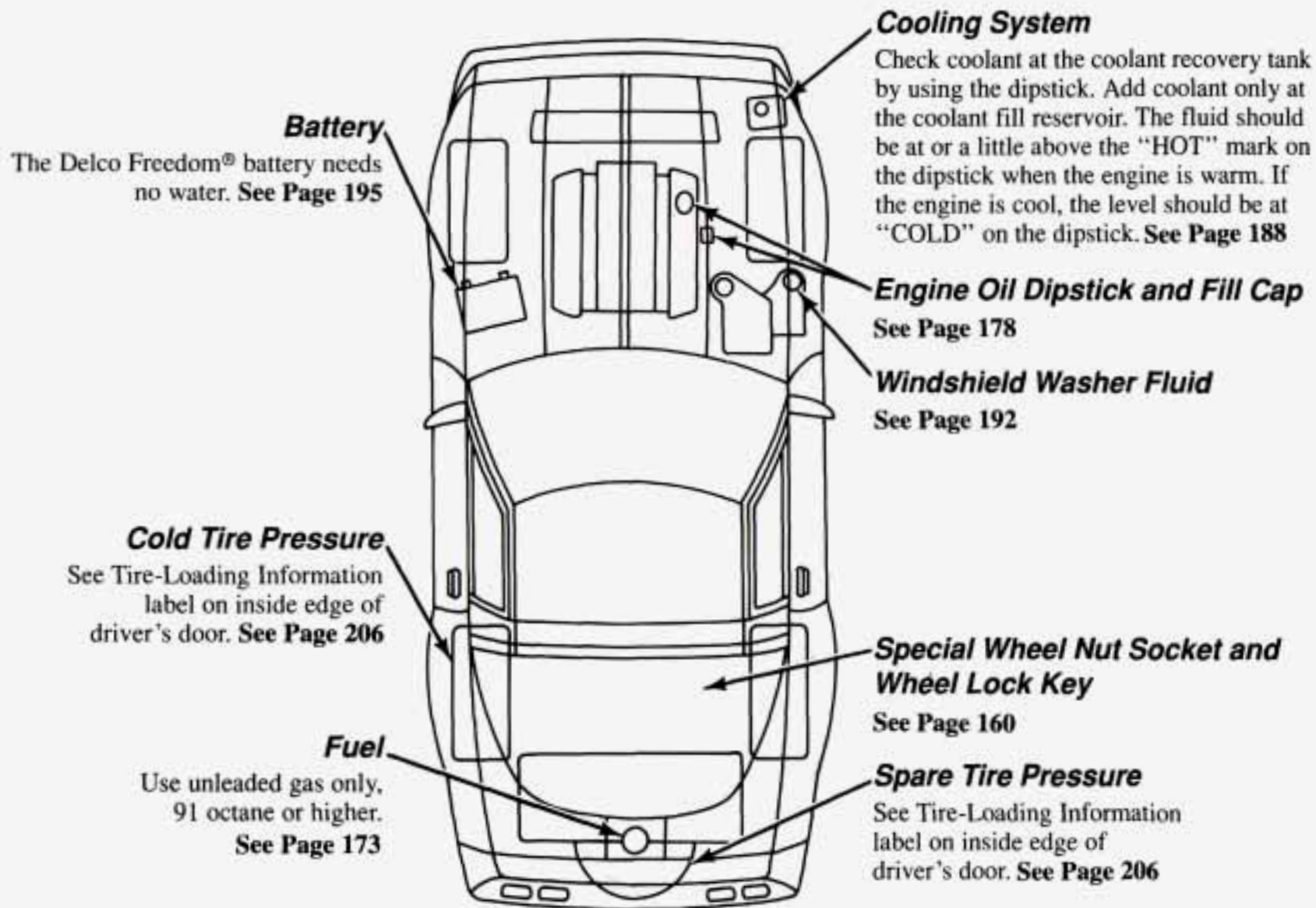



WE SUPPORT
VOLUNTARY TECHNICIAN
CERTIFICATION THROUGH

National Institute for
**AUTOMOTIVE
SERVICE
EXCELLENCE**



CHEVROLET

The GM logo features the letters "GM" in a white, bold, sans-serif font, centered within a dark blue square.