

2003

TRAILBLAZER  
TRAILBLAZER EXT



CHEVROLET

# The 2003 Chevy TrailBlazer/TrailBlazer EXT Owner Manual

<b>Seats and Restraint Systems</b> .....	1-1	Driver Information Center (DIC) .....	3-46
Front Seats .....	1-2	Audio System(s) .....	3-58
Rear Seats .....	1-6	<b>Driving Your Vehicle</b> .....	4-1
Safety Belts .....	1-9	Your Driving, the Road, and Your Vehicle .....	4-2
Child Restraints .....	1-29	Towing .....	4-42
Air Bag Systems .....	1-49	<b>Service and Appearance Care</b> .....	5-1
Restraint System Check .....	1-59	Service .....	5-3
<b>Features and Controls</b> .....	2-1	Fuel .....	5-5
Keys .....	2-3	Checking Things Under the Hood .....	5-10
Doors and Locks .....	2-8	Rear Axle .....	5-45
Windows .....	2-14	Four-Wheel Drive .....	5-46
Theft-Deterrent Systems .....	2-17	Bulb Replacement .....	5-48
Starting and Operating Your Vehicle .....	2-19	Windshield Wiper Blade Replacement .....	5-50
Mirrors .....	2-34	Tires .....	5-53
OnStar <sup>®</sup> System .....	2-38	Appearance Care .....	5-75
HomeLink <sup>®</sup> Transmitter .....	2-40	Vehicle Identification .....	5-83
Storage Areas .....	2-44	Electrical System .....	5-84
Sunroof .....	2-51	Capacities and Specifications .....	5-96
Vehicle Personalization .....	2-52	Normal Maintenance Replacement Parts .....	5-98
<b>Instrument Panel</b> .....	3-1	<b>Maintenance Schedule</b> .....	6-1
Instrument Panel Overview .....	3-4	Maintenance Schedule .....	6-2
Climate Controls .....	3-19	<b>Customer Assistance Information</b> .....	7-1
Warning Lights, Gages and Indicators .....	3-32	Customer Assistance Information .....	7-2
		Reporting Safety Defects .....	7-9
		<b>Index</b> .....	1



GENERAL MOTORS, GM, the GM Emblem, CHEVROLET, the CHEVROLET Emblem and the name TRAILBLAZER/TRAILBLAZER EXT are registered trademarks of General Motors Corporation.

This manual includes the latest information at the time it was printed. We reserve the right to make changes after that time without further notice. For vehicles first sold in Canada, substitute the name "General Motors of Canada Limited" for Chevrolet Motor Division whenever it appears in this manual.

Please keep this manual in your vehicle, so it will be there if you ever need it when you're on the road. If you sell the vehicle, please leave this manual in it so the new owner can use it.

## Canadian Owners

You can obtain a French copy of this manual from your dealer or from:

Helm, Incorporated  
P.O. Box 07130  
Detroit, MI 48207

## How to Use This Manual

Many people read their owner's manual from beginning to end when they first receive their new vehicle. If you do this, it will help you learn about the features and controls for your vehicle. In this manual, you'll find that pictures and words work together to explain things.

## Index

A good place to look for what you need is the Index in back of the manual. It's an alphabetical list of what's in the manual, and the page number where you'll find it.

## Safety Warnings and Symbols

You will find a number of safety cautions in this book. We use a box and the word CAUTION to tell you about things that could hurt you if you were to ignore the warning.

 **CAUTION:**

**These mean there is something that could hurt you or other people.**

In the caution area, we tell you what the hazard is. Then we tell you what to do to help avoid or reduce the hazard. Please read these cautions. If you don't, you or others could be hurt.



You will also find a circle with a slash through it in this book. This safety symbol means "Don't," "Don't do this" or "Don't let this happen."

## Vehicle Damage Warnings

Also, in this book you will find these notices:

**Notice:** These mean there is something that could damage your vehicle.

A notice will tell you about something that can damage your vehicle. Many times, this damage would not be covered by your warranty, and it could be costly. But the notice will tell you what to do to help avoid the damage.

When you read other manuals, you might see CAUTION and NOTICE warnings in different colors or in different words.

You'll also see warning labels on your vehicle. They use the same words, CAUTION or NOTICE.

































## Vehicle Symbols

Your vehicle has components and labels that use symbols instead of text. Symbols, used on your vehicle, are shown along with the text describing the operation or information relating to a specific component, control, message, gage or indicator.

If you need help figuring out a specific name of a component, gage or indicator reference the following topics:

- Seats and Restraint Systems in Section 1
- Features and Controls in Section 2
- Instrument Panel Overview in Section 3
- Climate Controls in Section 3
- Warning Lights, Gages and Indicators in Section 3
- Audio System(s) in Section 3
- Engine Compartment Overview in Section 5

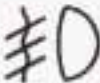
These are some examples of vehicle symbols you may find on your vehicle:

<p>CAUTION POSSIBLE INJURY</p> 	<p>LATCH BOTH LAP AND SHOULDER BELTS TO PROTECT OCCUPANT DO NOT TWIST SAFETY BELT WHEN ATTACHING</p>  	<p>MASTER LIGHTING SWITCH</p> 	<p>ENGINE COOLANT TEMP</p> 	<p>FUSE BOX ACCESS</p> 	
<p>PROTECT EYES BY SHIELDING</p> 	<p>FASTEN SEAT BELTS</p> 	<p>AIR BAG</p> 	<p>TURN SIGNALS</p> 	<p>BATTERY CHARGING SYSTEM</p> 	<p>ENGINE COOLANT FAN</p> 
<p>CAUSTIC BATTERY ACID COULD CAUSE BURNS</p> 	<p>MOVE SEAT FULLY REARWARD SECURE CHILD SEAT</p> 	<p>DO NOT INSTALL A REAR-FACING CHILD RESTRAINT IN THIS SEATING POSITION</p> 	<p>PARKING LAMPS</p> 	<p>HAZARD WARNING FLASHER</p> 	<p>FUEL</p> 
<p>AVOID SPARKS OR FLAMES</p> 	<p>PULL BELT OUT COMPLETELY THEN SECURE CHILD SEAT</p> 	<p>DO NOT INSTALL A FORWARD-FACING CHILD RESTRAINT IN THIS SEATING POSITION</p> 	<p>HAZARD WARNING FLASHER</p> 	<p>COOLANT</p> 	<p>OWNER'S MANUAL</p> 
<p>SPARK OR FLAME COULD EXPLODE BATTERY</p> 	<p>POWER WINDOW</p> 	<p>DOOR LOCK UNLOCK</p> 	<p>DAYTIME RUNNING LAMPS</p> 	<p>ENGINE OIL PRESSURE</p> 	<p>SERVICE</p> 
			<p>FOG LAMPS</p> 	<p>ANTI-LOCK BRAKES</p> 	<p>SERVICE MANUAL</p> 



## Section 1 Seats and Restraint Systems

---

<b>Front Seats</b> .....	1-2	Child Restraint Systems .....	1-35
Manual Seats .....	1-2	Where to Put the Restraint .....	1-38
Power Seats .....	1-2	Top Strap .....	1-38
Manual Lumbar .....	1-3	Top Strap Anchor Location .....	1-40
Power Lumbar .....	1-3	Lower Anchorages and Top Tethers for	
Heated Seats .....	1-3	Children (LATCH System) .....	1-40
Reclining Seatbacks .....	1-4	Securing a Child Restraint Designed for the	
Head Restraints .....	1-5	LATCH System .....	1-42
<b>Rear Seats</b> .....	1-6	Securing a Child Restraint in a Rear Outside	
Rear Seat Operation .....	1-6	Seat Position .....	1-43
<b>Safety Belts</b> .....	1-9	Securing a Child Restraint in the Right Front	
Safety Belts: They Are for Everyone .....	1-9	Seat Position .....	1-46
Questions and Answers About Safety Belts .....	1-13	Center Seat Position .....	1-48
How to Wear Safety Belts Properly .....	1-14	<b>Air Bag Systems</b> .....	1-49
Driver Position .....	1-14	Where Are the Air Bags? .....	1-52
Safety Belt Use During Pregnancy .....	1-21	When Should an Air Bag Inflate? .....	1-54
Right Front Passenger Position .....	1-22	What Makes an Air Bag Inflate? .....	1-55
Rear Seat Passengers .....	1-22	How Does an Air Bag Restrain? .....	1-55
Rear Safety Belt Comfort Guides for Children		What Will You See After an Air Bag Inflates? .....	1-56
and Small Adults .....	1-25	Servicing Your Air Bag-Equipped Vehicle .....	1-58
Safety Belt Extender .....	1-28	<b>Restraint System Check</b> .....	1-59
<b>Child Restraints</b> .....	1-29	Checking Your Restraint Systems .....	1-59
Older Children .....	1-29	Replacing Restraint System Parts	
Infants and Young Children .....	1-31	After a Crash .....	1-60



## Front Seats

### Manual Seats

#### CAUTION:

You can lose control of the vehicle if you try to adjust a manual driver's seat while the vehicle is moving. The sudden movement could startle and confuse you, or make you push a pedal when you don't want to. Adjust the driver's seat only when the vehicle is not moving.

Pull up on the lever located under the front of the manual seat to unlock it. Slide the seat to where you want it and release the lever. Then try to move the seat with your body to make sure the seat is locked into place.

### Power Seats



If you have this feature, the power seat controls are located on the outboard side of the front seat cushions.

- Move the front of the seat control up or down to adjust the front portion of the cushion.
- Move the rear of the seat control up or down to adjust the rear portion of the cushion.
- Lift up or push down on the center of the seat control to move the entire seat up or down.
- To move the seat forward or rearward, slide the seat control forward or rearward.
- To recline the seatback, press the vertical control rearward. To raise the seatback, press the vertical control forward.

## Manual Lumbar

Your vehicle may have this feature. This control is located on the outboard side of the seat.

Turn the knob counterclockwise to increase lumbar support and clockwise to decrease lumbar support.

## Power Lumbar

Your vehicle may have this feature. The driver's and passenger's seatback lumbar support can be adjusted by moving a single control located on the outboard side of the seat cushions.

To increase or decrease support, hold the control forward or rearward.

Keep in mind that as your seating position changes, as it may during long trips, so should the position of your lumbar support. Adjust the seat as needed.

## Heated Seats



Your vehicle may have heated front seats. The buttons used to control this feature are located on the front door armrests. The engine must be running for the heated seat feature to work.

To heat the entire seat, press the horizontal button with the heated seat symbol. Press the button repeatedly to cycle through the temperature settings of high, medium, low and off. The indicator lights will glow to designate the level of heat selected: three for high, two for medium and one for low. The low setting warms the seatback and cushion until the seat temperature is near body temperature. The medium and high settings heat the seatback and seat cushion to a slightly higher temperature. You will be able to feel heat in about two minutes.

To heat only the seatback, press the button with the words "BACK ONLY". An indicator light on the seatback switch will glow to designate that only the seatback is being heated. Additional presses will cycle through the heat levels for the seatback only. Press the horizontal button again to heat the whole seat.

The feature will shut off automatically when the ignition is turned off.

## Reclining Seatbacks

If your vehicle has a manual recliner, lift the lever located on the outboard side of the seat and push the seatback rearward to recline the seatback. To return the seatback to the normal position, lift the lever without pushing rearward on the seatback and the seatback will move forward.

If your vehicle has power seat controls, the vertical power seat control described earlier allows the seatback to recline.



But don't have a seatback reclined if your vehicle is moving.

## CAUTION:

Sitting in a reclined position when your vehicle is in motion can be dangerous. Even if you buckle up, your safety belts can't do their job when you're reclined like this.

The shoulder belt can't do its job. In a crash, you could go into it, receiving neck or other injuries.

The lap belt can't do its job either. In a crash the belt could go up over your abdomen. The belt forces would be there, not at your pelvic bones. This could cause serious internal injuries.

For proper protection when the vehicle is in motion, have the seatback upright. Then sit well back in the seat and wear your safety belt properly.

## Head Restraints



Adjust your head restraint so that the top of the restraint is closest to the top of your head. This position reduces the chance of a neck injury in a crash.

The head restraints lock into place when raised. To release the head restraint and lower it, press the tab located on the top of the seatback.

## Rear Seats

### Rear Seat Operation

Your vehicle may have a folding rear seat which lets you fold the seatbacks down for more cargo space.

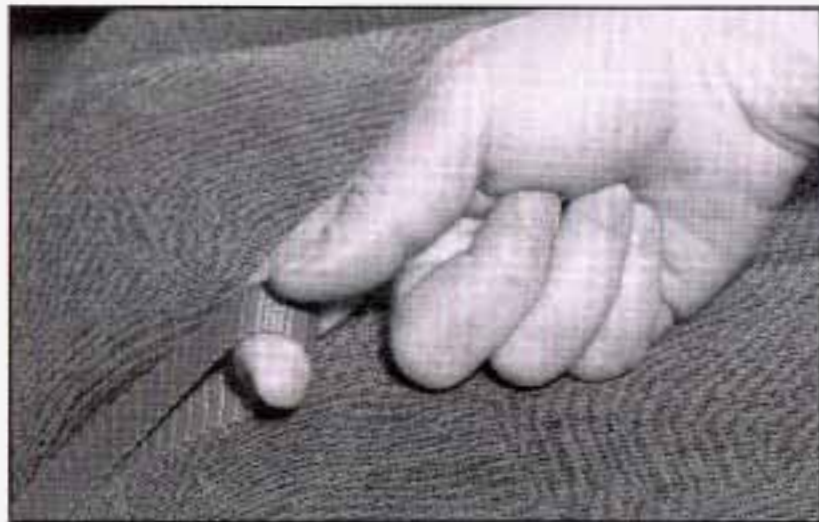

Pull up on the loop located where the seat cushion meets the seatback to fold the seat cushion up and out of the way. This will allow the seatback to fold flat and increase the cargo area.



The rear seatback handles are located on the outboard side of the rear seatbacks.

Pull the seatback toward you as you lift up on the handle. The head restraint will automatically fold out of the way when the seatback is folded down.

To raise the seatbacks, lift up the seatbacks and push on them until they lock into the upright position. Push and pull on the seatbacks to make sure that they are latched securely. Then fold the bottom seat cushion back into place.

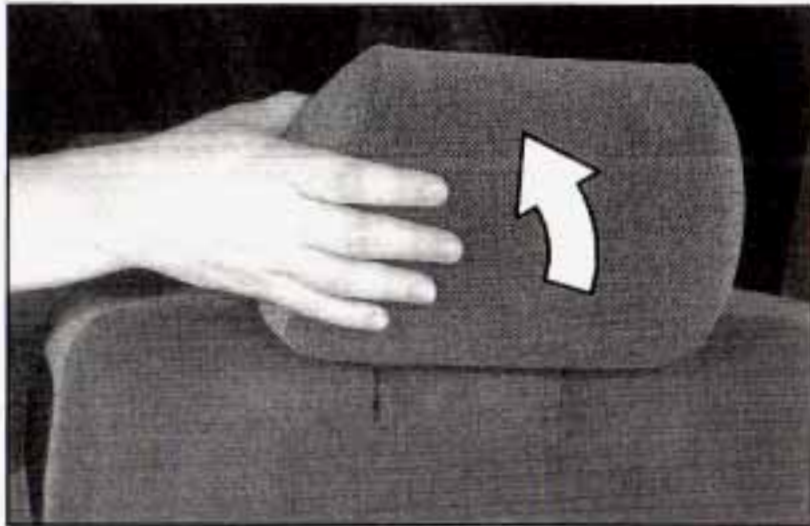

To return the head restraint to the upright position, reach behind the seat and pull the restraint up until it locks into place. Push and pull on the head restraint to make sure that it is latched securely.

## Rear Seats (TrailBlazer EXT)

The second row seat is a 65/35 split seat which may be folded and tumbled. Use this feature for gaining access to the third row seats.

To fold and tumble the second row seat(s), do the following:

1. Push the head restraints fully down.
2. Fold the seatback flat on the seat by pushing down on the front part of the lever. The lever is located on the outboard side of the seat (indicated as 1 on the handle side cover).
3. Release the rear set of seat hooks from the floor pins by pushing down on the rear part of the lever (indicated as 2 on the handle side cover). This enables the seat to be tumbled forward.

## Returning the Seats to an Upright Position

To return the seat(s) to the upright position, do the following:

1. Return the seat to the floor pins by rotating the seat down to reengage the seat hooks.
2. Try to raise the seat to check that it is locked down.
3. Pull the seat back up to return it to the upright position.

## **Entry/Exit to/from the Third Row Seat**

To enter the third row seat, you must fold and tumble the second row seat following the instructions given previously.

If you are exiting the third row with no assistance, do the following.

1. Pull the handle on the center of the second row seatback down to release and fold the seatback.
2. Reach around to the side of the second row seat and pull the back of the seat lever up to tumble the entire seat.

Be sure to return the seat to the passenger position when you are finished. Never use the third row as a seating position while the second row is folded and tumbled.

## **Folding the Third Row Seats**

1. Pull up on the handle located on the bottom of the seat cushion to release the seat cushion.
2. Lift up the seat, and then pull it forward.
3. Fold the seatback forward until it is flat.
4. Unhook the elastic loop on the back of the seatback.
5. Fold the panel located on the back of the seatback to make a flat surface.

## **Returning the Seat(s) to an Upright Position**

To return the seat to its original position, reverse the steps listed in folding the third row seats.

# Safety Belts

## Safety Belts: They Are for Everyone

This part of the manual tells you how to use safety belts properly. It also tells you some things you should not do with safety belts.

### CAUTION:

Don't let anyone ride where he or she can't wear a safety belt properly. If you are in a crash and you're not wearing a safety belt, your injuries can be much worse. You can hit things inside the vehicle or be ejected from it. You can be seriously injured or killed. In the same crash, you might not be, if you are buckled up. Always fasten your safety belt, and check that your passengers' belts are fastened properly too.

### CAUTION:

It is extremely dangerous to ride in a cargo area, inside or outside of a vehicle. In a collision, people riding in these areas are more likely to be seriously injured or killed. Do not allow people to ride in any area of your vehicle that is not equipped with seats and safety belts. Be sure everyone in your vehicle is in a seat and using a safety belt properly.



Your vehicle has a light that comes on as a reminder to buckle up. See *Safety Belt Reminder Light* on page 3-35.

In most states and in all Canadian provinces, the law says to wear safety belts. Here's why: *They work.*

You never know if you'll be in a crash. If you do have a crash, you don't know if it will be a bad one.



A few crashes are mild, and some crashes can be so serious that even buckled up, a person wouldn't survive. But most crashes are in between. In many of them, people who buckle up can survive and sometimes walk away. Without belts they could have been badly hurt or killed.

After more than 30 years of safety belts in vehicles, the facts are clear. In most crashes buckling up does matter... a lot!

## Why Safety Belts Work

When you ride in or on anything, you go as fast as it goes.

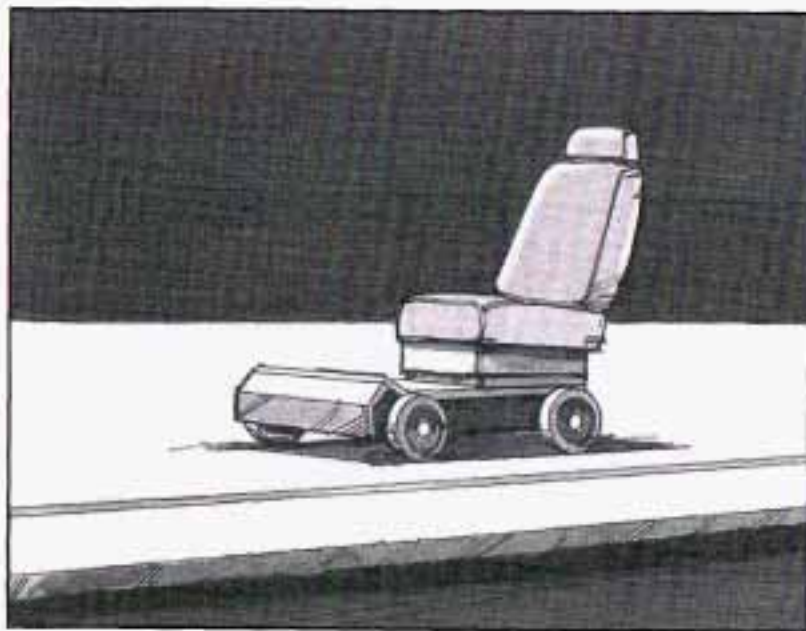

Take the simplest vehicle. Suppose it's just a seat on wheels.

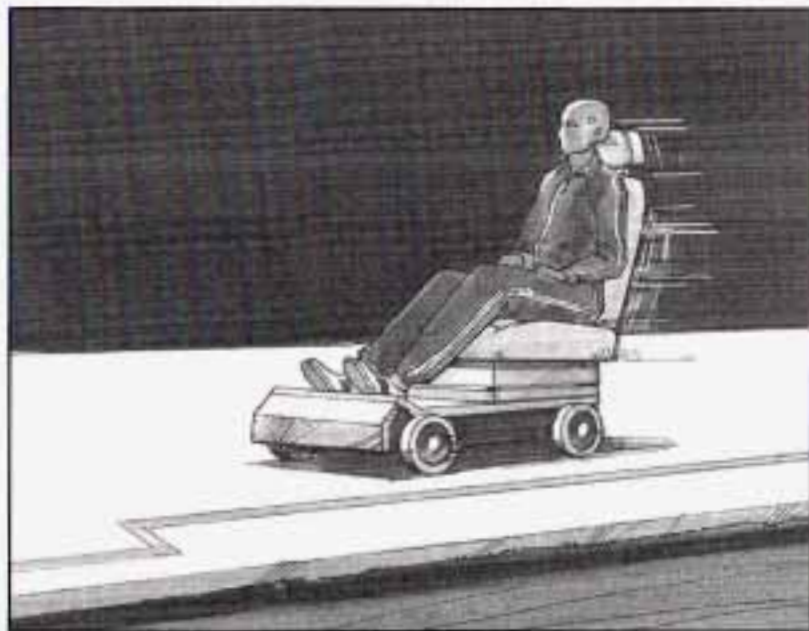

Put someone on it.

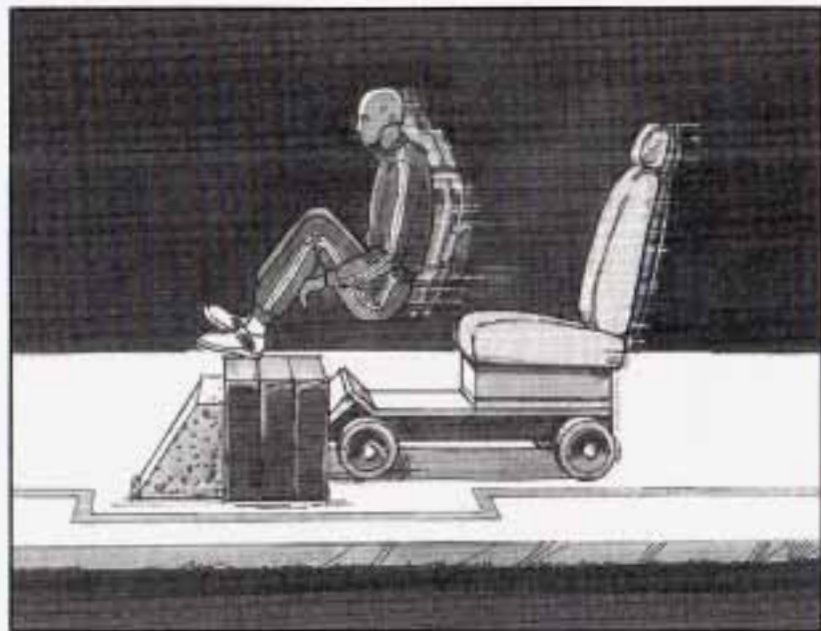

Get it up to speed. Then stop the vehicle. The rider doesn't stop.



The person keeps going until stopped by something. In a real vehicle, it could be the windshield...

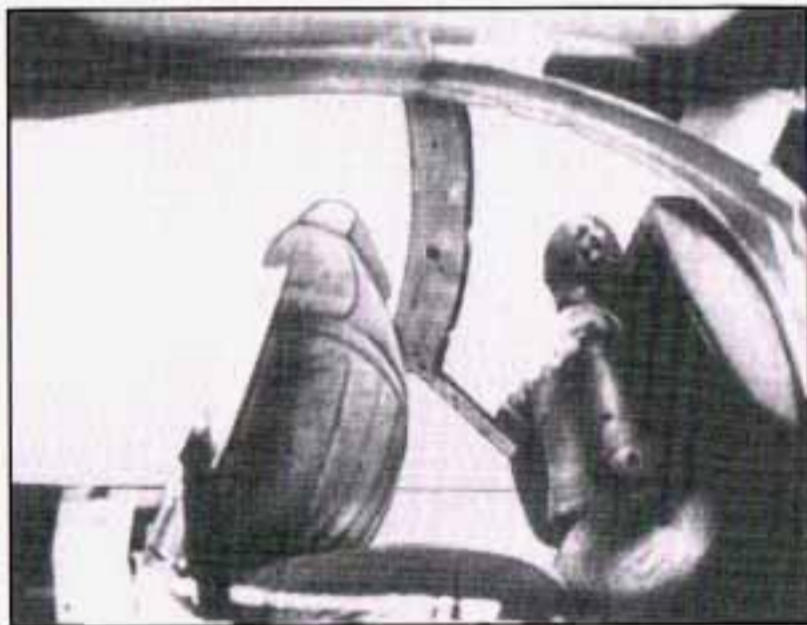

or the instrument panel...



or the safety belts!

With safety belts, you slow down as the vehicle does. You get more time to stop. You stop over more distance, and your strongest bones take the forces. That's why safety belts make such good sense.

## Questions and Answers About Safety Belts

**Q:** Won't I be trapped in the vehicle after an accident if I'm wearing a safety belt?

**A:** You *could* be – whether you're wearing a safety belt or not. But you can unbuckle a safety belt, even if you're upside down. And your chance of being conscious during and after an accident, so you *can* unbuckle and get out, is *much* greater if you are belted.

**Q:** If my vehicle has air bags, why should I have to wear safety belts?

**A:** Air bags are in many vehicles today and will be in most of them in the future. But they are supplemental systems only; so they work *with* safety belts – not instead of them. Every air bag system ever offered for sale has required the use of safety belts. Even if you're in a vehicle that has air bags, you still have to buckle up to get the most protection. That's true not only in frontal collisions, but especially in side and other collisions.

**Q:** If I'm a good driver, and I never drive far from home, why should I wear safety belts?

**A:** You may be an excellent driver, but if you're in an accident – even one that isn't your fault – you and your passengers can be hurt. Being a good driver doesn't protect you from things beyond your control, such as bad drivers.

Most accidents occur within 25 miles (40 km) of home. And the greatest number of serious injuries and deaths occur at speeds of less than 40 mph (65 km/h).

Safety belts are for everyone.

## How to Wear Safety Belts Properly

This part is only for people of adult size.

Be aware that there are special things to know about safety belts and children. And there are different rules for smaller children and babies. If a child will be riding in your vehicle, see *Older Children on page 1-29* or *Infants and Young Children on page 1-31*. Follow those rules for everyone's protection.

First, you'll want to know which restraint systems your vehicle has.

We'll start with the driver position.

### Driver Position

This part describes the driver's restraint system.

## Lap-Shoulder Belt

The driver has a lap-shoulder belt. Here's how to wear it properly.

1. Close and lock the door.
2. Adjust the seat so you can sit up straight. To see how, see "Seats" in the Index.



3. Pick up the latch plate and pull the belt across you. Don't let it get twisted.

4. Push the latch plate into the buckle until it clicks. Pull up on the latch plate to make sure it is secure. If the belt isn't long enough, see *Safety Belt Extender* on page 1-28.

Make sure the release button on the buckle is positioned so you would be able to unbuckle the safety belt quickly if you ever had to.



5. To make the lap part tight, pull up on the shoulder belt.

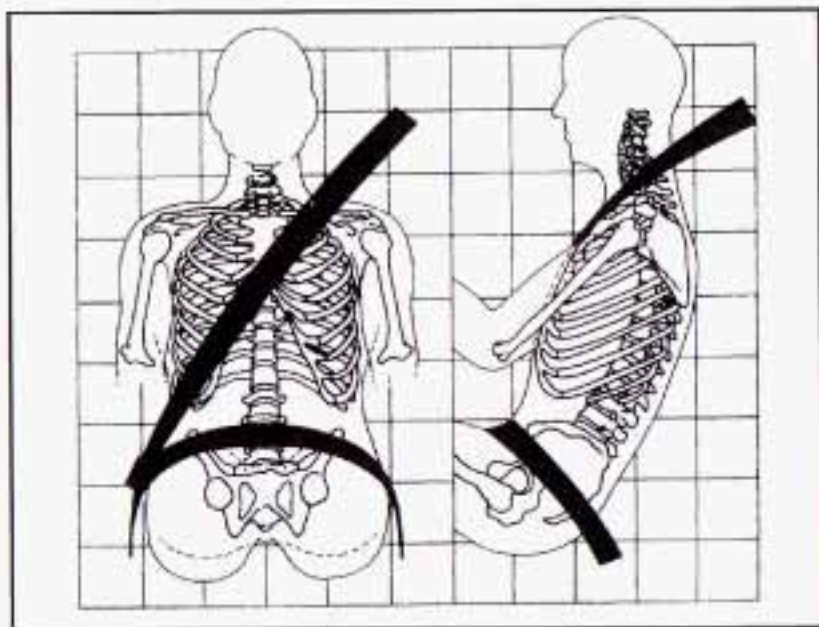

The lap part of the belt should be worn low and snug on the hips, just touching the thighs. In a crash, this applies force to the strong pelvic bones. And you'd be less likely to slide under the lap belt. If you slid under it, the belt would apply force at your abdomen. This could cause serious or even fatal injuries. The shoulder belt should go over the shoulder and across the chest. These parts of the body are best able to take belt restraining forces.

The safety belt locks if there's a sudden stop or crash, or if you pull the belt very quickly out of the retractor.

**Q:** What's wrong with this?

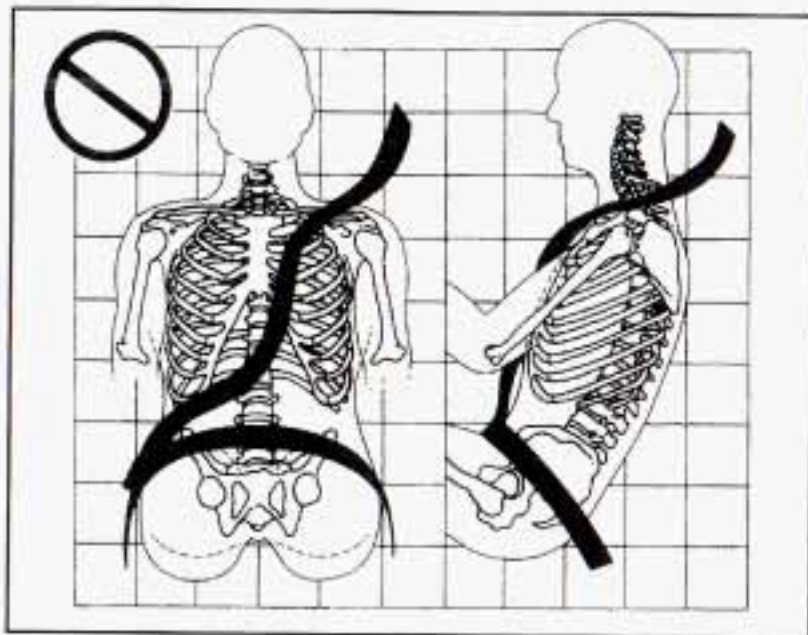

**A:** The shoulder belt is too loose. It won't give nearly as much protection this way.

**⚠ CAUTION:**

You can be seriously hurt if your shoulder belt is too loose. In a crash, you would move forward too much, which could increase injury. The shoulder belt should fit against your body.



**Q:** What's wrong with this?

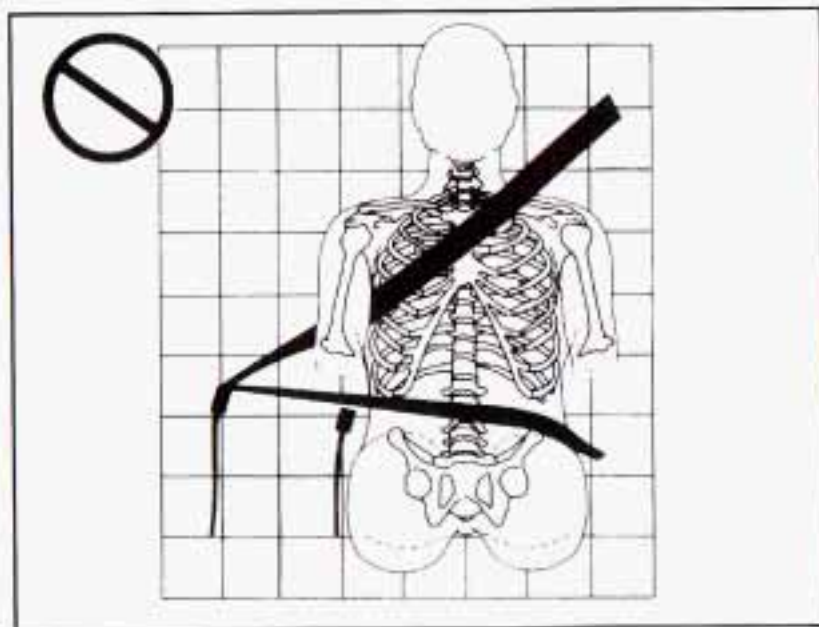

**A:** The belt is buckled in the wrong place.

**⚠ CAUTION:**

You can be seriously injured if your belt is buckled in the wrong place like this. In a crash, the belt would go up over your abdomen. The belt forces would be there, not at the pelvic bones. This could cause serious internal injuries. Always buckle your belt into the buckle nearest you.

**Q:** What's wrong with this?

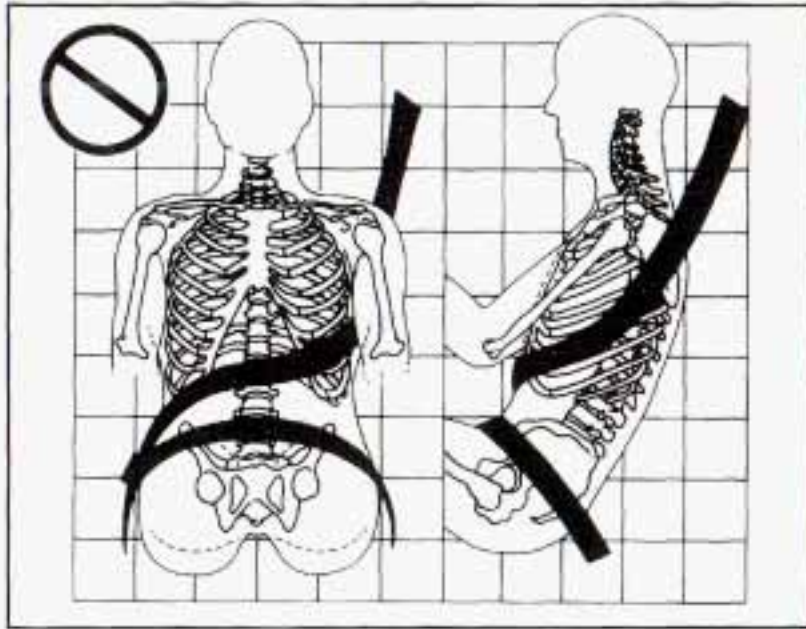

**A:** The shoulder belt is worn under the arm. It should be worn over the shoulder at all times.

**⚠ CAUTION:**

You can be seriously injured if you wear the shoulder belt under your arm. In a crash, your body would move too far forward, which would increase the chance of head and neck injury. Also, the belt would apply too much force to the ribs, which aren't as strong as shoulder bones. You could also severely injure internal organs like your liver or spleen.

**Q:** What's wrong with this?

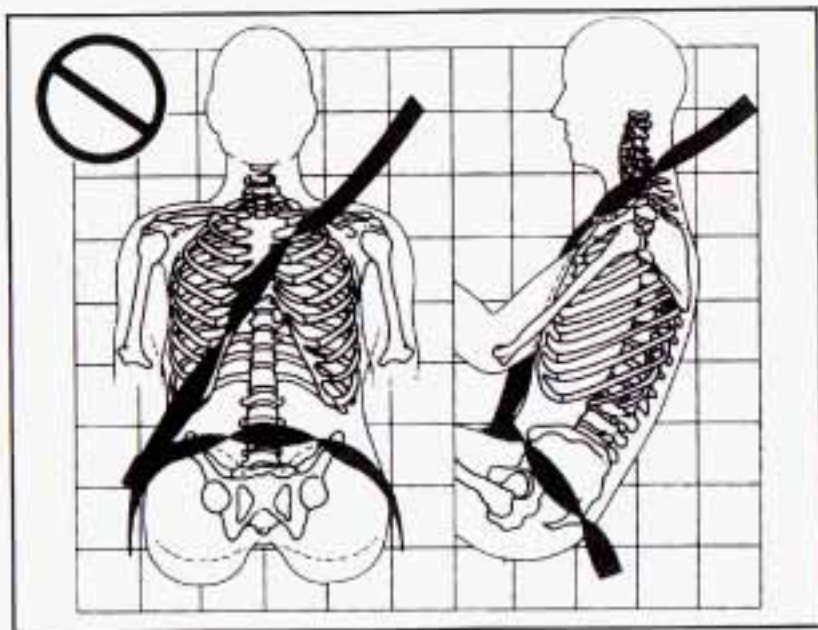

**A:** The belt is twisted across the body.

**⚠ CAUTION:**

You can be seriously injured by a twisted belt. In a crash, you wouldn't have the full width of the belt to spread impact forces. If a belt is twisted, make it straight so it can work properly, or ask your dealer to fix it.



To unlatch the belt, just push the button on the buckle. The belt should go back out of the way.

Before you close the door, be sure the belt is out of the way. If you slam the door on it, you can damage both the belt and your vehicle.

## Safety Belt Use During Pregnancy

Safety belts work for everyone, including pregnant women. Like all occupants, they are more likely to be seriously injured if they don't wear safety belts.

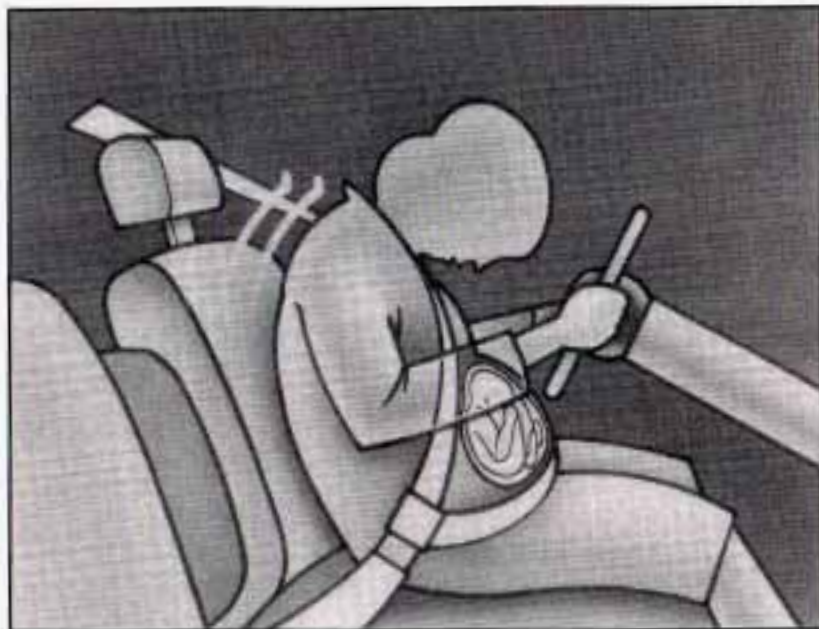

A pregnant woman should wear a lap-shoulder belt, and the lap portion should be worn as low as possible, below the rounding, throughout the pregnancy.

The best way to protect the fetus is to protect the mother. When a safety belt is worn properly, it's more likely that the fetus won't be hurt in a crash. For pregnant women, as for anyone, the key to making safety belts effective is wearing them properly.

## Right Front Passenger Position

To learn how to wear the right front passenger's safety belt properly, see *Driver Position* on page 1-14.

The right front passenger's safety belt works the same way as the driver's safety belt — except for one thing. If you ever pull the shoulder portion of the belt out all the way, you will engage the child restraint locking feature. If this happens, just let the belt go back all the way and start again.

## Rear Seat Passengers

It's very important for rear seat passengers to buckle up! Accident statistics show that unbelted people in the rear seat are hurt more often in crashes than those who are wearing safety belts.

Rear passengers who aren't safety belted can be thrown out of the vehicle in a crash. And they can strike others in the vehicle who are wearing safety belts.

## Rear Seat Passenger Positions

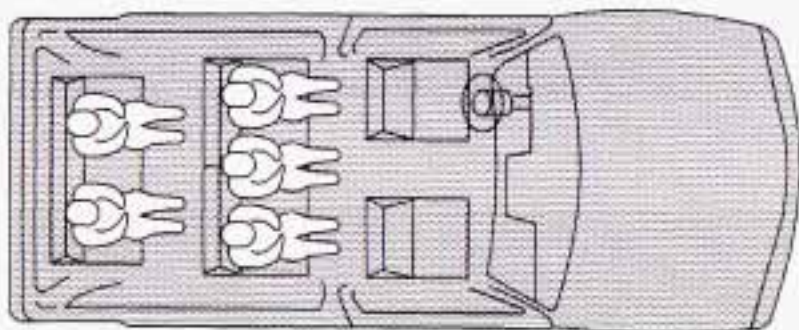
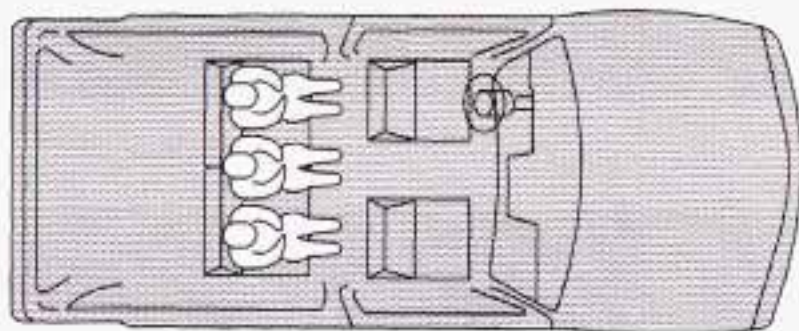

## Lap-Shoulder Belt

All rear seating positions have lap-shoulder belts. Here's how to wear one properly.



1. Pick up the latch plate and pull the belt across you. Don't let it get twisted.
2. Push the latch plate into the buckle until it clicks. Pull up on the latch plate to make sure it is secure.

When the shoulder belt is pulled out all the way, it will lock. If it does, let it go back all the way and start again. If the belt is not long enough, see *Safety Belt Extender on page 1-28*.

Make sure the release button on the buckle is positioned so you would be able to unbuckle the safety belt quickly if you ever had to.



3. To make the lap part tight, pull up on the shoulder part.

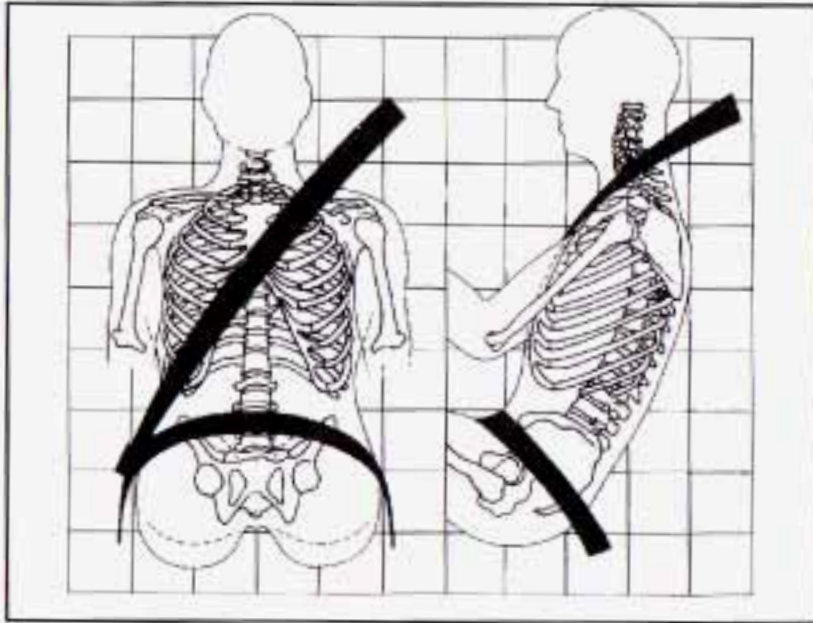

The lap part of the belt should be worn low and snug on the hips, just touching the thighs. In a crash this applies force to the strong pelvic bones. And you'd be less likely to slide under the lap belt. If you slid under it, the belt would apply force at your abdomen. This could cause serious or even fatal injuries. The shoulder belt should go over the shoulder and across the chest. These parts of the body are best able to take belt restraining forces.

**⚠ CAUTION:**

You can be seriously hurt if your shoulder belt is too loose. In a crash, you would move forward too much, which could increase injury. The shoulder belt should fit against your body.



To unlatch the belt, just push the button on the buckle.

## Rear Safety Belt Comfort Guides for Children and Small Adults

Your vehicle may already have this feature. If not, you can get it from your GM dealer.

Rear shoulder belt comfort guides provide added safety belt comfort for older children who have outgrown booster seats and for small adults. When attached to a shoulder belt, the comfort guide better positions the belt away from the neck and head.

There is one guide available for each of the rear outside passenger positions. Here's how to attach the comfort guide to the shoulder belt.



## Vehicles With No Third Row

1. Slide the guide off of its storage clip located between the interior body and the seatback.

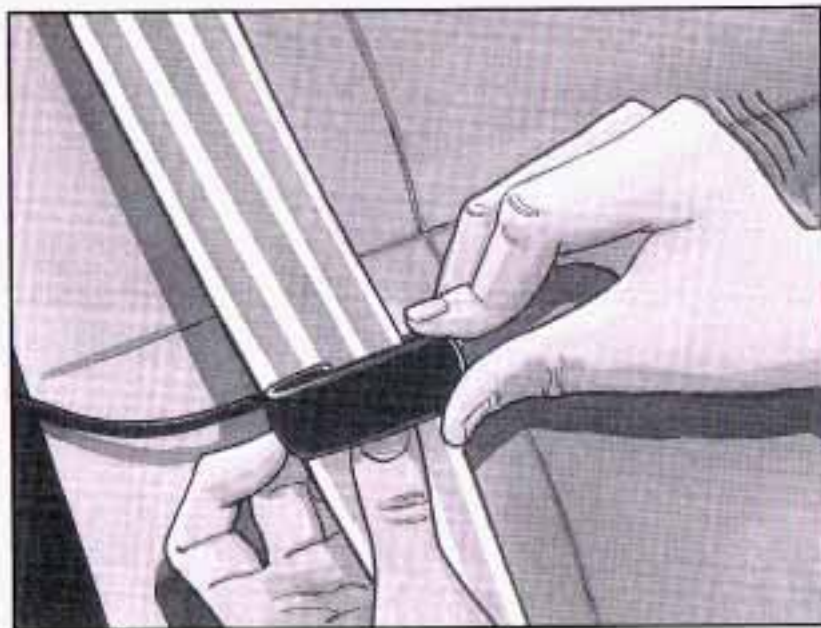

2. Slide the guide under and past the belt. The elastic cord must be under the belt. Then, place the guide over the belt and insert the two edges of the belt into the slots of the guide.

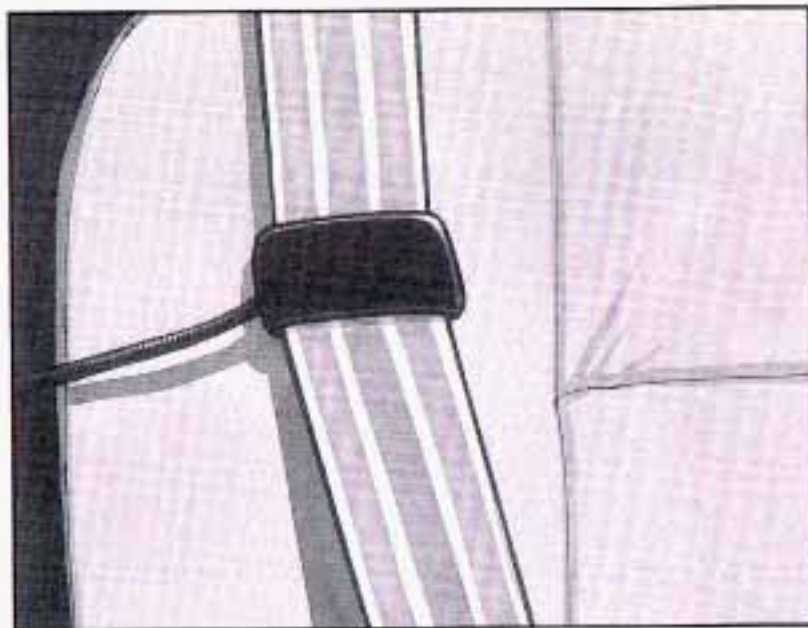

3. Be sure that the belt is not twisted and it lies flat. The elastic cord must be under the belt and the guide on top.



4. Buckle, position and release the safety belt as described in *Rear Seat Passengers* on page 1-22. Make sure that the shoulder belt crosses the shoulder.

To remove and store the comfort guides, squeeze the belt edges together so that you can take them out of the guides. Slide the guide back on its storage clip located between the interior body and the seatback.

## Vehicles With Both a Second and Third Row

1. An elastic cord with a hook end is located in a pocket on the side of the seatback. Remove the guide from its pocket.

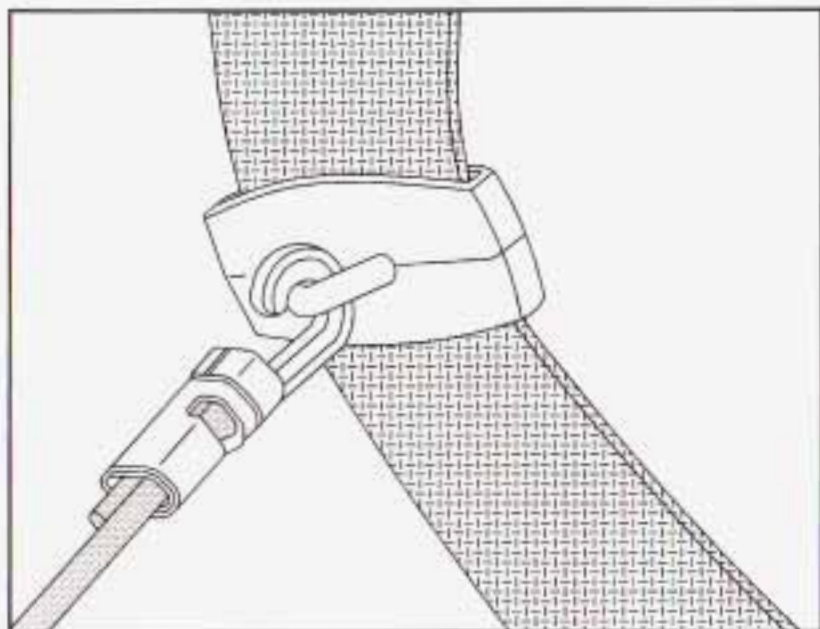

2. Align the sliding comfort guide, located on the shoulder belt, with the hook. Attach the hook to the loop on the sliding comfort guide.

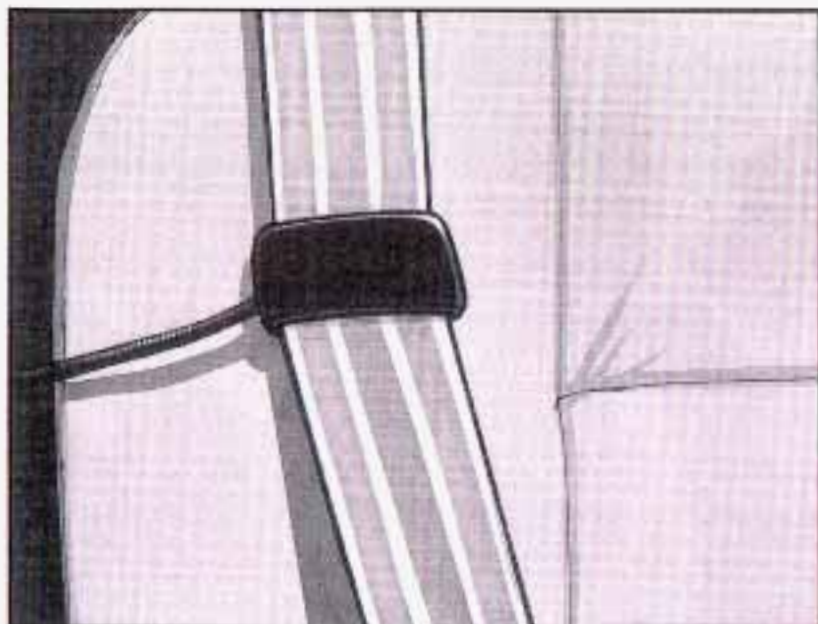

## Safety Belt Extender

If the vehicle's safety belt will fasten around you, you should use it.

But if a safety belt isn't long enough to fasten, your dealer will order you an extender. It's free. When you go in to order it, take the heaviest coat you will wear, so the extender will be long enough for you. The extender will be just for you, and just for the seat in your vehicle that you choose. Don't let someone else use it, and use it only for the seat it is made to fit. To wear it, just attach it to the regular safety belt.

3. Be sure that the belt is not twisted and it lies flat. The elastic cord must be under the belt and the guide on top.
4. Buckle, position and release the safety belt as described in *Rear Seat Passengers* on page 1-22. Make sure that the shoulder belt crosses the shoulder.

To remove and store the comfort guides, remove the hook from the loop. Slide the guide back into its storage pocket located on the side of the seatback.

## Child Restraints

### Older Children



Older children who have outgrown booster seats should wear the vehicle's safety belts.

**Q:** What is the proper way to wear safety belts?

**A:** If possible, an older child should wear a lap-shoulder belt and get the additional restraint a shoulder belt can provide. The shoulder belt should not cross the face or neck. The lap belt should fit snugly below the hips, just touching the top of the thighs. It should never be worn over the abdomen, which could cause severe or even fatal internal injuries in a crash.

Accident statistics show that children are safer if they are restrained in the rear seat.

In a crash, children who are not buckled up can strike other people who are buckled up, or can be thrown out of the vehicle. Older children need to use safety belts properly.



**⚠ CAUTION:**

Never do this.

Here two children are wearing the same belt. The belt can't properly spread the impact forces. In a crash, the two children can be crushed together and seriously injured. A belt must be used by only one person at a time.

**Q:** What if a child is wearing a lap-shoulder belt, but the child is so small that the shoulder belt is very close to the child's face or neck?

**A:** If the child is sitting in a seat next to a window, move the child toward the center of the vehicle. If the child is sitting in the center rear seat passenger position, move the child toward the safety belt buckle. In either case, be sure that the shoulder belt still is on the child's shoulder, so that in a crash the child's upper body would have the restraint the belts provide.

If the child is sitting in a rear seat outside position, see *Rear Safety Belt Comfort Guides for Children and Small Adults* on page 1-25.



## **CAUTION:**

Never do this.

Here a child is sitting in a seat that has a lap-shoulder belt, but the shoulder part is behind the child. If the child wears the belt in this way, in a crash the child might slide under the belt. The belt's force would then be applied right on the child's abdomen. That could cause serious or fatal injuries.

Wherever the child sits, the lap portion of the belt should be worn low and snug on the hips, just touching the child's thighs. This applies belt force to the child's pelvic bones in a crash.

## **Infants and Young Children**

Everyone in a vehicle needs protection! This includes infants and all other children. Neither the distance traveled nor the age and size of the traveler changes the need, for everyone, to use safety restraints. In fact, the law in every state in the United States and in every Canadian province says children up to some age must be restrained while in a vehicle.

Every time infants and young children ride in vehicles, they should have the protection provided by appropriate restraints. Young children should not use the vehicle's adult safety belts alone, unless there is no other choice. Instead, they need to use a child restraint.



**⚠ CAUTION:**

People should never hold a baby in their arms while riding in a vehicle. A baby doesn't weigh much -- until a crash. During a crash a baby will become so heavy it is not possible to hold it. For example, in a crash at only 25 mph (40 km/h), a 12-lb. (5.5 kg) baby will suddenly become a 240-lb. (110 kg) force on a person's arms. A baby should be secured in an appropriate restraint.



**⚠ CAUTION:**

Children who are up against, or very close to, any air bag when it inflates can be seriously injured or killed. Air bags plus lap-shoulder belts offer outstanding protection for adults and older children, but not for young children and infants. Neither the vehicle's safety belt system nor its air bag system is designed for them. Young children and infants need the protection that a child restraint system can provide.

**Q:** What are the different types of add-on child restraints?

**A:** Add-on child restraints, which are purchased by the vehicle's owner, are available in four basic types. Selection of a particular restraint should take into consideration not only the child's weight, height, and age but also whether or not the restraint will be compatible with the motor vehicle in which it will be used.



For most basic types of child restraints, there are many different models available. When purchasing a child restraint, be sure it is designed to be used in a motor vehicle. If it is, the restraint will have a label saying that it meets federal motor vehicle safety standards.

The restraint manufacturer's instructions that come with the restraint state the weight and height limitations for a particular child restraint. In addition, there are many kinds of restraints available for children with special needs.

 **CAUTION:**

**Newborn infants need complete support, including support for the head and neck. This is necessary because a newborn infant's neck is weak and its head weighs so much compared with the rest of its body. In a crash, an infant in a rear-facing seat settles into the restraint, so the crash forces can be distributed across the strongest part of an infant's body, the back and shoulders. Infants always should be secured in appropriate infant restraints.**

 **CAUTION:**

**The body structure of a young child is quite unlike that of an adult or older child, for whom the safety belts are designed. A young child's hip bones are still so small that the vehicle's regular safety belt may not remain low on the hip bones, as it should. Instead, it may settle up around the child's abdomen. In a crash, the belt would apply force on a body area that's unprotected by any bony structure. This alone could cause serious or fatal injuries. Young children always should be secured in appropriate child restraints.**

## Child Restraint Systems

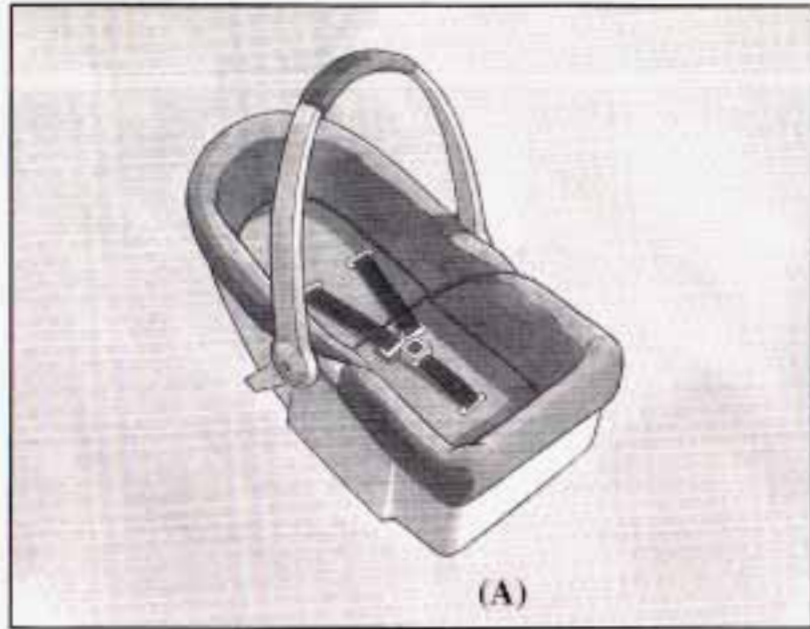

An infant car bed (A), a special bed made for use in a motor vehicle, is an infant restraint system designed to restrain or position a child on a continuous flat surface. Make sure that the infant's head rests toward the center of the vehicle.

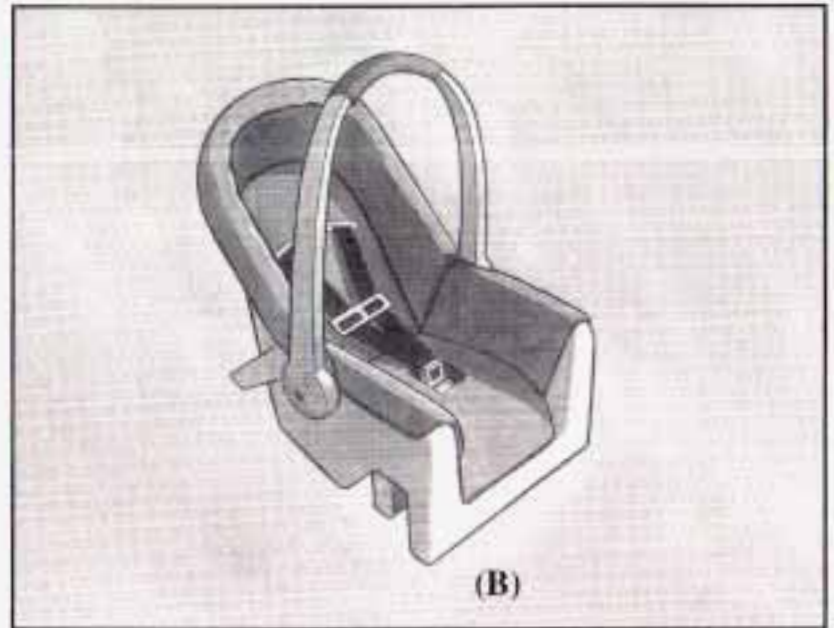

A rear-facing infant seat (B) provides restraint with the seating surface against the back of the infant. The harness system holds the infant in place and, in a crash, acts to keep the infant positioned in the restraint.

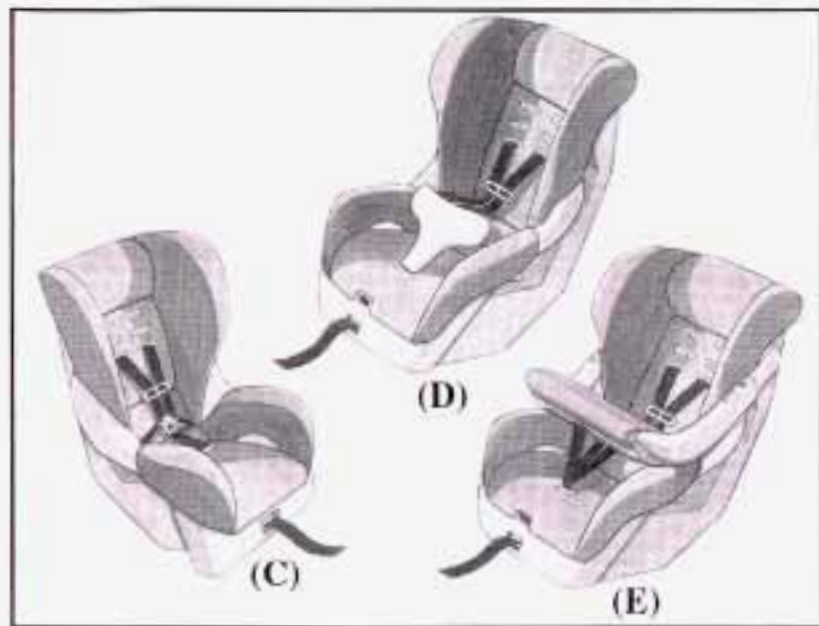

A forward-facing child seat (C-E) provides restraint for the child's body with the harness and also sometimes with surfaces such as T-shaped or shelf-like shields.

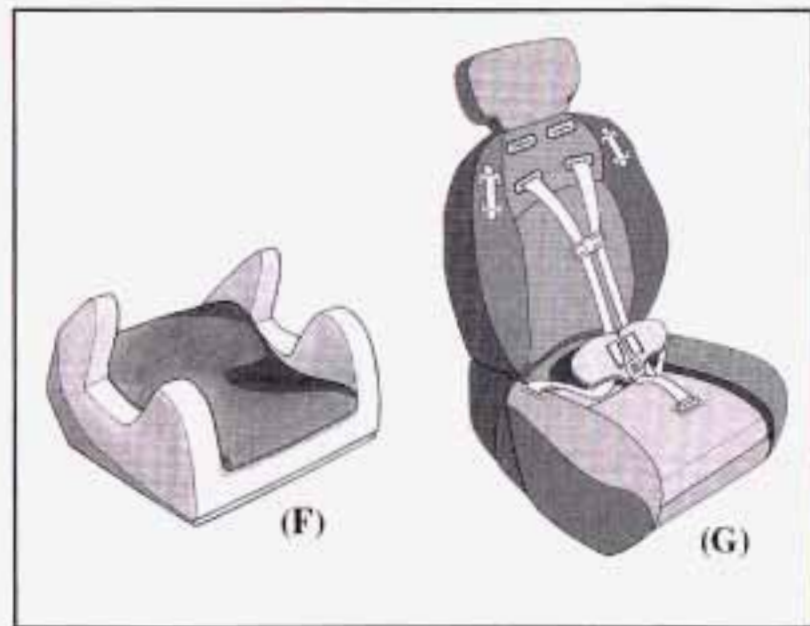

A booster seat (F-G) is a child restraint designed to improve the fit of the vehicle's safety belt system. Some booster seats have a shoulder belt positioner, and some high-back booster seats have a five-point harness. A booster seat can also help a child to see out the window.

**Q: How do child restraints work?**

**A:** A child restraint system is any device designed for use in a motor vehicle to restrain, seat, or position children. A built-in child restraint system is a permanent part of the motor vehicle. An add-on child restraint system is a portable one, which is purchased by the vehicle's owner.

For many years, add-on child restraints have used the adult belt system in the vehicle. To help reduce the chance of injury, the child also has to be secured within the restraint. The vehicle's belt system secures the add-on child restraint in the vehicle, and the add-on child restraint's harness system holds the child in place within the restraint.

One system, the three-point harness, has straps that come down over each of the infant's shoulders and buckle together at the crotch. The five-point harness system has two shoulder straps, two hip straps and a crotch strap. A shield may take the place of hip straps. A T-shaped shield has shoulder straps that are attached to a flat pad which rests low against the child's body. A shelf- or armrest-type shield has straps that are attached to a wide, shelf-like shield that swings up or to the side.

When choosing a child restraint, be sure the child restraint is designed to be used in a vehicle. If it is, it will have a label saying that it meets federal motor vehicle safety standards.

Then follow the instructions for the restraint. You may find these instructions on the restraint itself or in a booklet, or both. These restraints use the belt system in your vehicle, but the child also has to be secured within the restraint to help reduce the chance of personal injury. When securing an add-on child restraint, refer to the instructions that come with the restraint which may be on the restraint itself or in a booklet, or both, and to this manual. The child restraint instructions are important, so if they are not available, obtain a replacement copy from the manufacturer.

## Where to Put the Restraint

Accident statistics show that children are safer if they are restrained in the rear rather than the front seat. We, therefore, recommend that child restraints be secured in a rear outside seat position including an infant riding in a rear-facing infant seat, a child riding in a forward-facing child seat and an older child riding in a booster seat. *Never* put a rear-facing child restraint in the front passenger seat. Here's why:

### CAUTION:

**A child in a rear-facing child restraint can be seriously injured or killed if the right front passenger's air bag inflates. This is because the back of the rear-facing child restraint would be very close to the inflating air bag. Always secure a rear-facing child restraint in a rear seat outside position.**

**You may secure a forward-facing child restraint in the right front seat, but before you do, always move the front passenger seat as far back as it will go. It's better to secure the child restraint in a rear seat outside position.**

Wherever you install it, be sure to secure the child restraint properly.

Keep in mind that an unsecured child restraint can move around in a collision or sudden stop and injure people in the vehicle. Be sure to properly secure any child restraint in your vehicle – even when no child is in it.

## Top Strap

Some child restraints have a top strap, or "top tether." It can help restrain the child restraint during a collision. For it to work, a top strap must be properly anchored to the vehicle. Some top strap-equipped child restraints are designed for use with or without the top strap being anchored. Others require the top strap always to be anchored. Be sure to read and follow the instructions for your child restraint. If yours requires that the top strap be anchored, don't use the restraint unless it is anchored properly.

If the child restraint does not have a top strap, one can be obtained, in kit form, for many child restraints. Ask the child restraint manufacturer whether or not a kit is available.

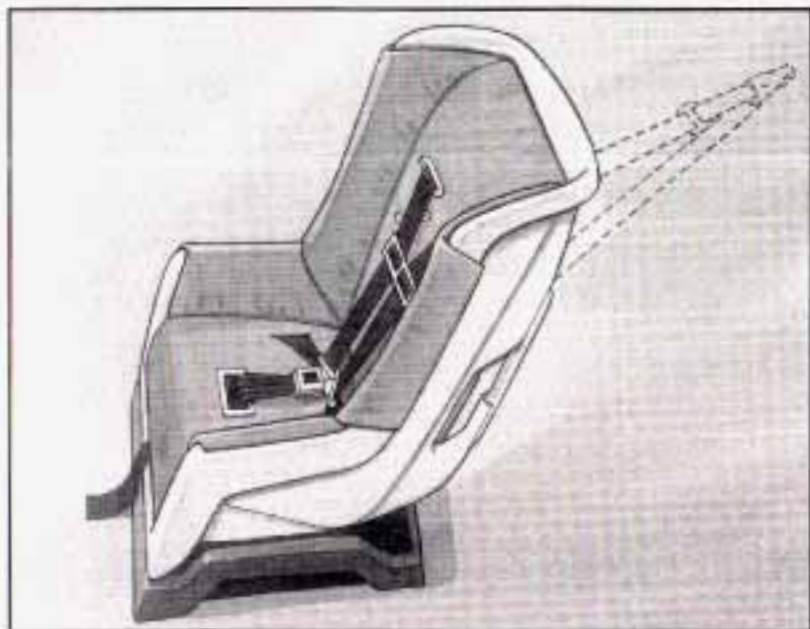

In Canada, the law requires that forward-facing child restraints have a top strap, and that the strap be anchored. In the United States, some child restraints also have a top strap. If your child restraint has a top strap, it should be anchored.

Anchor the top strap to one of the following anchor points. Be sure to use an anchor point located on the same side of the vehicle as the seating position where the child restraint will be placed.

Raise the head restraint and route the top strap under it. See *Head Restraints on page 1-5*.

Once you have the top strap anchored, you'll be ready to secure the child restraint itself. Tighten the top strap when and as the child restraint manufacturer's instructions say.

## Top Strap Anchor Location



TrailBlazer

Anchor brackets for the rear seat positions are located on the floor in the cargo area of your vehicle (TrailBlazer only). Do not use the rear tie-down brackets near the liftgate for top strap tethers.

## Lower Anchorages and Top Tethers for Children (LATCH System)

Your vehicle may have the LATCH system. If it does, you'll find anchors (A) in the rear outside seat positions.

To assist you in locating the lower anchors for this child restraint system, each seating position with the LATCH system will have two metal tabs where the seat cushion meets the seatback.

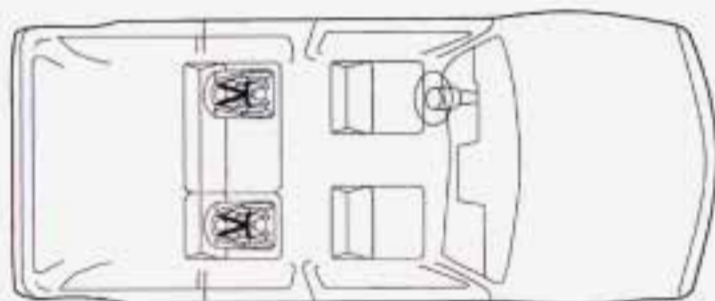

In order to use the system, you need either a forward-facing child restraint that has attaching points (B) at its base and a top tether anchor (C), or a rear-facing child restraint that has attaching points (B), as shown here.

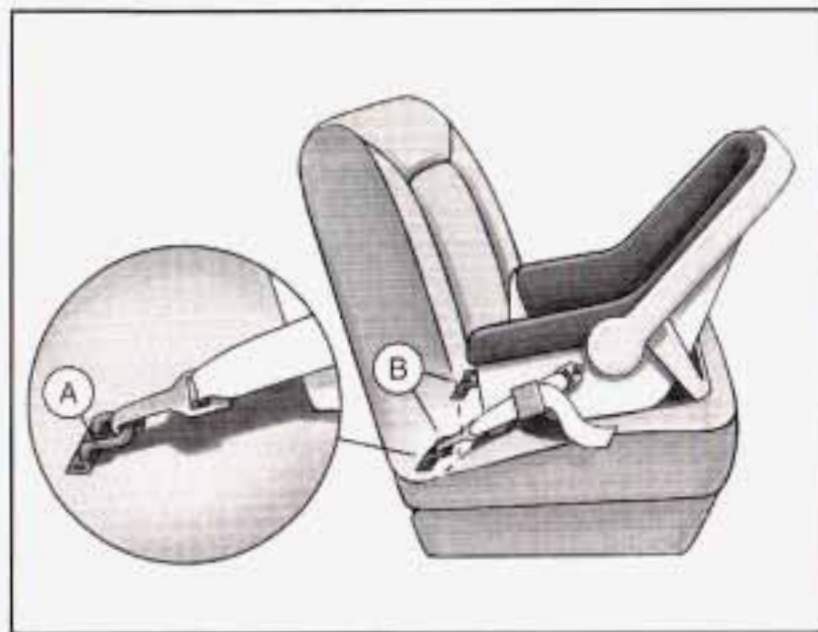
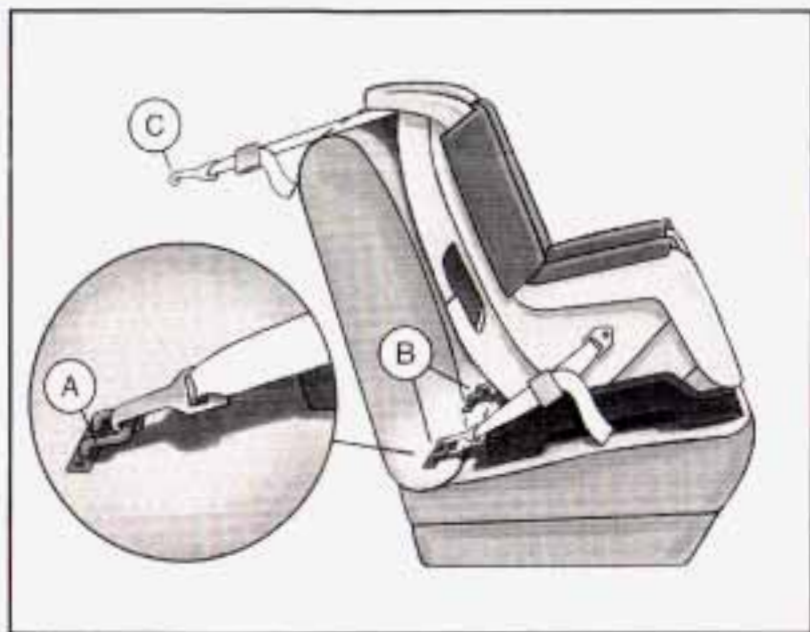

With this system, use the LATCH system instead of the vehicle's safety belts to secure a child restraint. See *Securing a Child Restraint in a Rear Outside Seat Position* on page 1-43.



 **CAUTION:**

If a LATCH-type child restraint isn't attached to its anchorage points, the restraint won't be able to protect the child correctly. In a crash, the child could be seriously injured or killed. Make sure that a LATCH-type child restraint is properly installed using the anchorage points, or use the vehicle's safety belts to secure the restraint. See "Securing a Child Restraint Designed for the LATCH System" or "Securing a Child Restraint in a Rear Outside Seat Position" in the Index for information on how to secure a child restraint in your vehicle.

## Securing a Child Restraint Designed for the LATCH System

1. Find the anchors for the seating position you want to use, where the bottom of the seatback meets the back of the seat cushion.
2. Put the child restraint on the seat.
3. Attach the anchor points on the child restraint to the anchors in the vehicle. The child restraint instructions will show you how.
4. If the child restraint is forward-facing, attach the top strap to the top strap anchor. See *Top Strap on page 1-38*. Tighten the top strap according to the child restraint instructions.
5. Push and pull the child restraint in different directions to be sure it is secure.

To remove the child restraint, simply unhook the top strap from the top tether anchor and then disconnect the anchor points.

## Securing a Child Restraint in a Rear Outside Seat Position

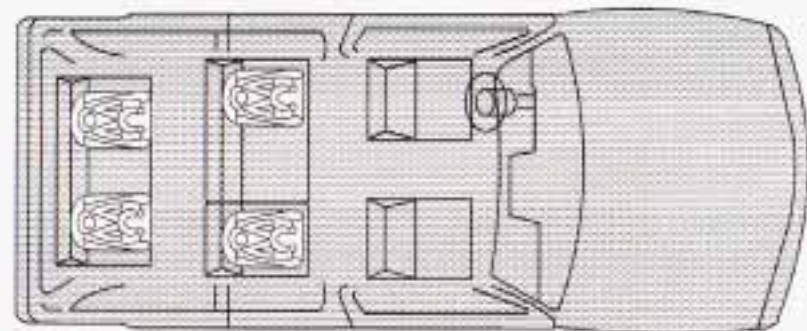
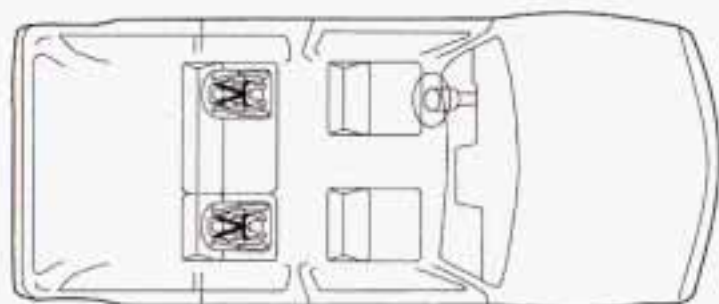

If your child restraint is equipped with the LATCH system, see *Lower Anchorages and Top Tethers for Children (LATCH System)* on page 1-40.

You'll be using the lap-shoulder belt. See *Top Strap* on page 1-38 if the child restraint has one. Be sure to follow the instructions that came with the child restraint. Secure the child in the child restraint when and as the instructions say.

1. Put the restraint on the seat.
2. Pick up the latch plate, and run the lap and shoulder portions of the vehicle's safety belt through or around the restraint. The child restraint instructions will show you how.



3. Buckle the belt. Make sure the release button is positioned so you would be able to unbuckle the safety belt quickly if you ever had to.



4. Pull the rest of the shoulder belt all the way out of the retractor to set the lock.



5. To tighten the belt, feed the shoulder belt back into the retractor while you push down on the child restraint. If you're using a forward-facing child restraint, you may find it helpful to use your knee to push down on the child restraint as you tighten the belt.
6. Push and pull the child restraint in different directions to be sure it is secure.

To remove the child restraint, just unbuckle the vehicle's safety belt and let it go back all the way. The safety belt will move freely again and be ready to work for an adult or larger child passenger.

## Securing a Child Restraint in the Right Front Seat Position

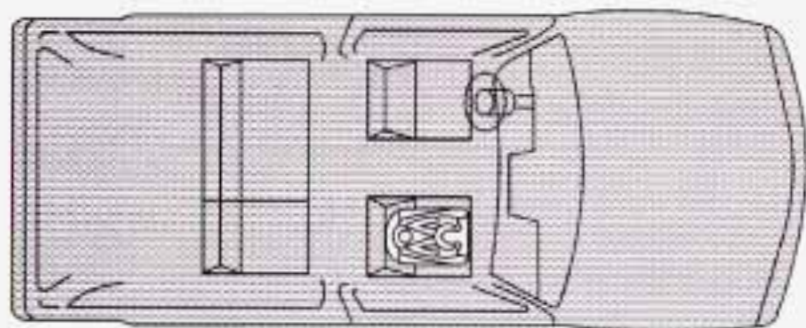

If your child restraint is equipped with the LATCH system, see *Lower Anchorages and Top Tethers for Children (LATCH System)* on page 1-40.

Your vehicle has a right front passenger air bag. **Never** put a rear facing child restraint in this seat. Here's why:

### **CAUTION:**

A child in a rear-facing child restraint can be seriously injured or killed if the right front passenger's air bag inflates. This is because the back of the rear-facing child restraint would be very close to the inflating air bag. **Always** secure a rear-facing child restraint in a rear seat.

Although a rear seat is a safer place, you can secure a forward-facing child restraint in the right front seat.

You'll be using the lap-shoulder belt. See *Top Strap* on page 1-38 if the child restraint has one. Be sure to follow the instructions that came with the child restraint. Secure the child in the child restraint when and as the instructions say.

1. Because your vehicle has a right front passenger's air bag, always move the seat as far back as it will go before securing a forward-facing child restraint. See *Power Seats* on page 1-2 or *Manual Seats* on page 1-2.
2. Put the restraint on the seat.

3. Pick up the latch plate, and run the lap and shoulder portions of the vehicle's safety belt through or around the restraint. The child restraint instructions will show you how.

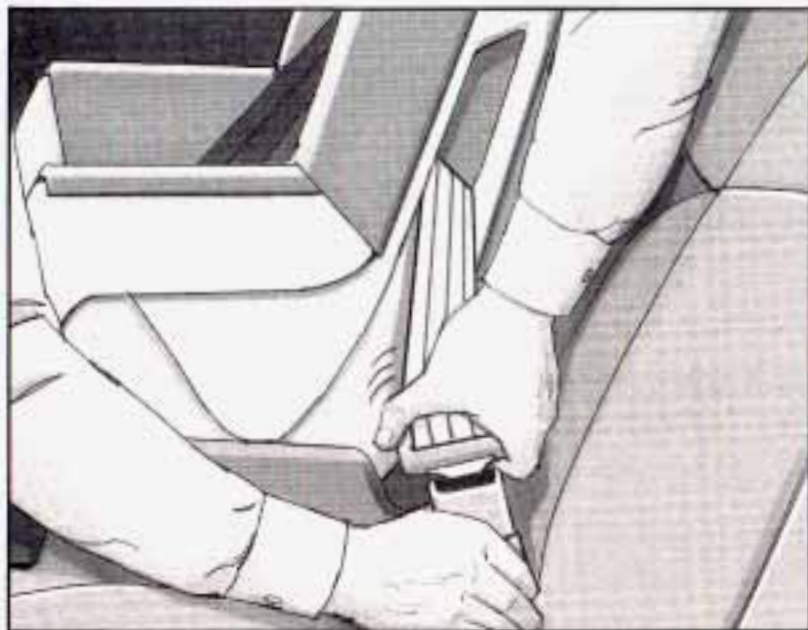

4. Buckle the belt. Make sure the release button is positioned so you would be able to unbuckle the safety belt quickly if you ever had to.



5. Pull the rest of the shoulder belt all the way out of the retractor to set the lock.



## Center Seat Position

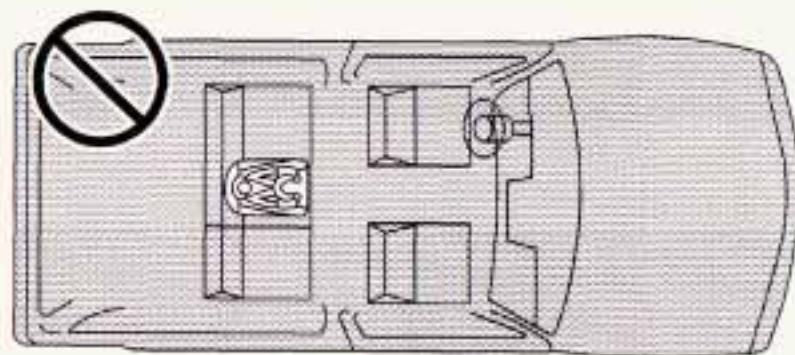

Don't use child restraints in this position. The restraints won't work properly.

6. To tighten the belt, feed the shoulder belt back into the retractor while you push down on the child restraint. You may find it helpful to use your knee to push down on the child restraint as you tighten the belt.
7. Push and pull the child restraint in different directions to be sure it is secure.

To remove the child restraint, just unbuckle the vehicle's safety belt and let it go back all the way. The safety belt will move freely again and be ready to work for an adult or larger child passenger.

## Air Bag Systems

This part explains the frontal and side impact air bag systems.

Your vehicle has air bags – a frontal air bag for the driver and another frontal air bag for the right front passenger. Your vehicle may also have a side impact air bag. Side impact air bags are available for the driver and right front passenger.

If your vehicle has a side impact air bag for the driver, the words AIR BAG will appear on the air bag covering on the side of the driver's seatback closest to the door.

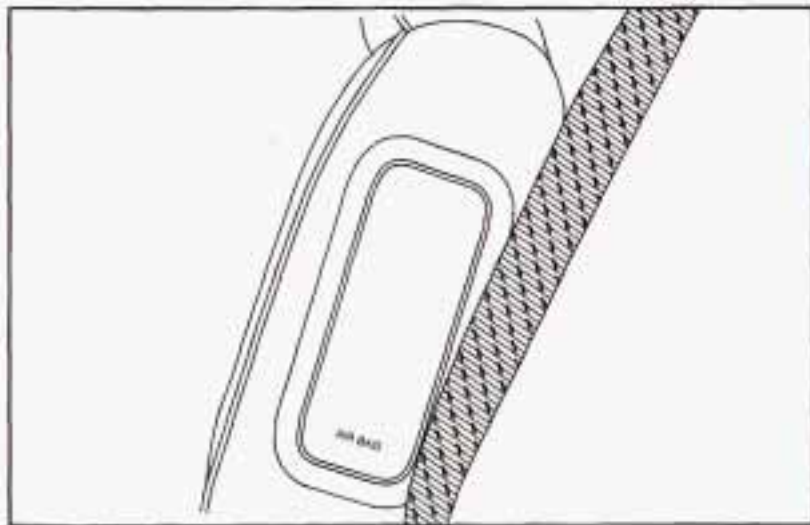

If your vehicle has a side impact air bag for the right front passenger, the words AIR BAG will appear on the air bag covering on the side of the right front passenger's seatback closest to the door.

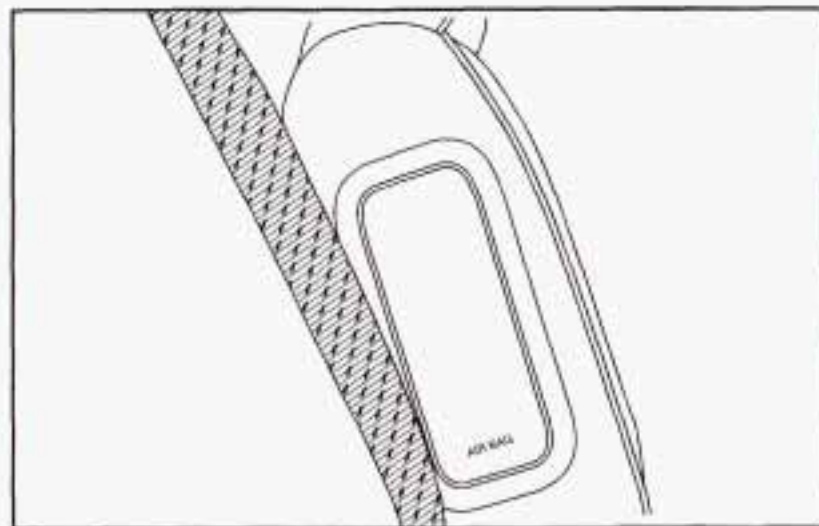

Frontal air bags are designed to help reduce the risk of injury from the force of an inflating frontal air bag. But these air bags must inflate very quickly to do their job and comply with federal regulations.

Here are the most important things to know about the air bag systems:



**⚠ CAUTION:**

You can be severely injured or killed in a crash if you aren't wearing your safety belt — even if you have air bags. Wearing your safety belt during a crash helps reduce your chance of hitting things inside the vehicle or being ejected from it. Air bags are designed to work with safety belts but don't replace them.

Frontal air bags for the driver and right front passenger are designed to deploy only in moderate to severe frontal and near frontal crashes. They aren't designed to inflate at all in rollover, rear or low-speed frontal crashes, or in many side crashes. And, for some unrestrained occupants, frontal air bags may provide less protection in frontal crashes than more forceful air bags have provided in the past.

The side impact air bags for the driver and right front passenger are designed to inflate only in moderate to severe crashes where something

**CAUTION: (Continued)**

**CAUTION: (Continued)**

hits the side of your vehicle. They aren't designed to inflate in frontal, in rollover or in rear crashes.

Everyone in your vehicle should wear a safety belt properly — whether or not there's an air bag for that person.

**⚠ CAUTION:**

Both frontal and side impact air bags inflate with great force, faster than the blink of an eye. If you're too close to an inflating air bag, as you would be if you were leaning forward, it could seriously injure you. Safety belts help keep you in position for air bag inflation before and during a crash. Always wear your safety belt, even with frontal air bags. The driver should sit as far back as possible while still maintaining control of the vehicle. Front occupants should not lean on or sleep against the door.

**⚠ CAUTION:**

Anyone who is up against, or very close to, any air bag when it inflates can be seriously injured or killed. Air bags plus lap-shoulder belts offer the best protection for adults, but not for young children and infants. Neither the vehicle's safety belt system nor its air bag system is designed for them. Young children and infants need the protection that a child restraint system can provide. Always secure children properly in your vehicle. To read how, see the part of this manual called "Older Children" or "Infants and Young Children".



There is an air bag readiness light on the instrument panel cluster, which shows the air bag symbol.

The system checks the air bag electrical system for malfunctions. The light tells you if there is an electrical problem. See *Air Bag Readiness Light* on page 3-35 for more information.

## Where Are the Air Bags?



The driver's frontal air bag is in the middle of the steering wheel.



The right front passenger's frontal air bag is in the instrument panel on the passenger's side.



If your vehicle has one, the driver's side impact air bag is in the side of the driver's seatback closest to the door.



If your vehicle has one, the right front passenger's side impact air bag is in the side of the passenger's seatback closest to the door.

## CAUTION:

**If something is between an occupant and an air bag, the bag might not inflate properly or it might force the object into that person causing severe injury or even death. The path of an inflating air bag must be kept clear. Don't put anything between an occupant and an air bag, and don't attach or put anything on the steering wheel hub or on or near any other air bag covering. Don't let seat covers block the inflation path of a side impact air bag.**

## When Should an Air Bag Inflate?

The driver's and right front passenger's frontal air bags are designed to inflate in moderate to severe frontal or near-frontal crashes. But they are designed to inflate only if the impact speed is above the system's designed "threshold level."

In addition, your vehicle has "dual stage" frontal air bags, which adjust the amount of restraint according to crash severity. For moderate frontal impacts, these

air bags inflate at a level less than full deployment. For more severe frontal impacts, full deployment occurs. If the front of your vehicle goes straight into a wall that doesn't move or deform, the threshold level for the reduced deployment is about 12 to 16 mph (19 to 26 km/h), and the threshold level for a full deployment is about 16 to 25 mph (26 to 40 km/h). The threshold level can vary, however, with specific vehicle design, so that it can be somewhat above or below this range.

If your vehicle strikes something that will move or deform, such as a parked car, the threshold level will be higher. The driver's and right front passenger's frontal air bags are not designed to inflate in rollovers, rear impacts, or in many side impacts because inflation would not help the occupant.

Your vehicle may or may not have a side impact air bag. See Air Bag Systems in the Index. Side impact air bags are designed to inflate in moderate to severe side crashes. A side impact air bag will inflate if the crash severity is above the system's designed "threshold level." The threshold level can vary with specific vehicle design. Side impact air bags are not designed to inflate in frontal or near-frontal impacts, rollovers or rear impacts, because inflation would not help the occupant. A side impact air bag will only deploy on the side of the vehicle that is struck.

In any particular crash, no one can say whether an air bag should have inflated simply because of the damage to a vehicle or because of what the repair costs were. For frontal air bags, inflation is determined by the angle of the impact and how quickly the vehicle slows down in frontal and near-frontal impacts. For side impact air bags, inflation is determined by the location and severity of the impact.

The air bag system is designed to work properly under a wide range of conditions, including off-road usage. Observe safe driving speeds, especially on rough terrain. As always, wear your safety belt. See *Off-Road Driving with Your Four-Wheel-Drive Vehicle* on page 4-14 for tips on off-road driving.

## What Makes an Air Bag Inflate?

In an impact of sufficient severity, the air bag sensing system detects that the vehicle is in a crash. For both frontal and side impact air bags, the sensing system triggers a release of gas from the inflator, which inflates the air bag. The inflator, the air bag and related hardware are all part of the air bag modules. Frontal air bag modules are located inside the steering wheel and instrument panel. For vehicles with side impact air bags, the air bag modules are located in the seatback closest to the driver's and/or right front passenger's door.

## How Does an Air Bag Restrain?

In moderate to severe frontal or near frontal collisions, even belted occupants can contact the steering wheel or the instrument panel. In moderate to severe side collisions, even belted occupants can contact the inside of the vehicle. The air bag supplements the protection provided by safety belts. Air bags distribute the force of the impact more evenly over the occupant's upper body, stopping the occupant more gradually. But the frontal air bags would not help you in many types of collisions, including rollovers, rear impacts, and many side impacts, primarily because an occupant's motion is not toward the air bag. Side impact air bags would not help you in many types of collisions, including frontal or near frontal collisions, rollovers, and rear impacts, primarily because an occupant's motion is not toward those air bags. Air bags should never be regarded as anything more than a supplement to safety belts, and then only in moderate to severe frontal or near-frontal collisions for the driver's and right front passenger's frontal air bags, and only in moderate to severe side collisions for vehicles with a driver's and right front passenger's side impact air bag.

## What Will You See After an Air Bag Inflates?

After the air bag inflates, it quickly deflates, so quickly that some people may not even realize the air bag inflated. Some components of the air bag module will be hot for a short time. These components include the steering wheel hub for the driver's frontal air bag and the instrument panel for the right front passenger's frontal air bag. For vehicles with side impact air bags, the side of the seatback closest to the driver's and/or right front passenger's door will be hot. The parts of the bag that come into contact with you may be warm, but not too hot to touch. There will be some smoke and dust coming from the vents in the deflated air bags. Air bag inflation doesn't prevent the driver from seeing or being able to steer the vehicle, nor does it stop people from leaving the vehicle.

### CAUTION:

**When an air bag inflates, there is dust in the air. This dust could cause breathing problems for people with a history of asthma or other breathing trouble. To avoid this, everyone in the vehicle should get out as soon as it is safe to do so. If you have breathing problems but can't get out of the vehicle after an air bag inflates, then get fresh air by opening a window or a door. If you experience breathing problems following an air bag deployment, you should seek medical attention.**

Your vehicle has a feature that will automatically unlock the doors and turn the interior lamps on when the air bags inflate (if battery power is available). You can lock the doors again and turn the interior lamps off by using the door lock and interior lamp controls.

In many crashes severe enough to inflate an air bag, windshields are broken by vehicle deformation. Additional windshield breakage may also occur from the right front passenger air bag.

- Air bags are designed to inflate only once. After an air bag inflates, you'll need some new parts for your air bag system. If you don't get them, the air bag system won't be there to help protect you in another crash. A new system will include air bag modules and possibly other parts. The service manual for your vehicle covers the need to replace other parts.
- Your vehicle is equipped with an electronic frontal sensor, which helps the sensing system distinguish between a moderate frontal impact and a more severe frontal impact. Your vehicle is also equipped with a crash sensing and diagnostic module,

which records information about the frontal air bag system. The module records information about the readiness of the system, when the system commands air bag inflation and driver's safety belt usage at deployment. The module also records speed, engine RPM, brake and throttle data.

- Let only qualified technicians work on your air bag systems. Improper service can mean that an air bag system won't work properly. See your dealer for service.

**Notice:** If you damage the covering for the driver's or the right front passenger's air bag, or the air bag covering on the driver's and right front passenger's seatback, the bag may not work properly. You may have to replace the air bag module in the steering wheel, both the air bag module and the instrument panel for the right front passenger's air bag, or both the air bag module and seatback for the driver's and right front passenger's side impact air bag. Do not open or break the air bag coverings.



## Servicing Your Air Bag-Equipped Vehicle

Air bags affect how your vehicle should be serviced. There are parts of the air bag systems in several places around your vehicle. Your dealer and the service manual have information about servicing your vehicle and the air bag systems. To purchase a service manual, see *Service Publications Ordering Information on page 7-10*.

### CAUTION:

**For up to 10 seconds after the ignition key is turned off and the battery is disconnected, an air bag can still inflate during improper service. You can be injured if you are close to an air bag when it inflates. Avoid yellow connectors. They are probably part of the air bag system. Be sure to follow proper service procedures, and make sure the person performing work for you is qualified to do so.**

The air bag systems do not need regular maintenance.

# Restraint System Check

## Checking Your Restraint Systems

Now and then, make sure the safety belt reminder light and all your belts, buckles, latch plates, retractors and anchorages are working properly. Look for any other loose or damaged safety belt system parts. If you see anything that might keep a safety belt system from doing its job, have it repaired.

Torn or frayed safety belts may not protect you in a crash. They can rip apart under impact forces. If a belt is torn or frayed, get a new one right away.

Also look for any opened or broken air bag covers, and have them repaired or replaced. (The air bag system does not need regular maintenance.)

## Replacing Restraint System Parts After a Crash

### CAUTION:

**A crash can damage the restraint systems in your vehicle. A damaged restraint system may not properly protect the person using it, resulting in serious injury or even death in a crash. To help make sure your restraint systems are working properly after a crash, have them inspected and any necessary replacements made as soon as possible.**

If you've had a crash, do you need new belts or LATCH system parts?

After a very minor collision, nothing may be necessary. But if the belts were stretched, as they would be if worn during a more severe crash, then you need new parts.

If the LATCH system was being used during a more severe crash, you may need new LATCH system parts.

If belts are cut or damaged, replace them. Collision damage also may mean you will need to have LATCH system, safety belt or seat parts repaired or replaced. New parts and repairs may be necessary even if the belt or LATCH system wasn't being used at the time of the collision.

If an air bag inflates, you'll need to replace air bag system parts. See the part on the air bag system earlier in this section.

## Section 2 Features and Controls

---

<b>Keys</b> .....	2-3	<b>Starting and Operating Your Vehicle</b> .....	2-19
Remote Keyless Entry System .....	2-5	New Vehicle Break-In .....	2-19
Remote Keyless Entry System Operation .....	2-6	Ignition Positions .....	2-19
<b>Doors and Locks</b> .....	2-8	Starting Your Engine .....	2-20
Door Locks .....	2-8	Engine Coolant Heater .....	2-21
Power Door Locks .....	2-9	Automatic Transmission Operation .....	2-22
Delayed Locking .....	2-9	Four-Wheel Drive .....	2-25
Programmable Automatic		Parking Brake .....	2-28
Door Locks .....	2-10	Shifting Into Park (P) .....	2-28
Rear Door Security Locks .....	2-12	Shifting Out of Park (P) .....	2-30
Lockout Protection .....	2-12	Parking Over Things That Burn .....	2-31
Leaving Your Vehicle .....	2-12	Engine Exhaust .....	2-31
Liftgate/Liftglass .....	2-13	Running Your Engine While You Are Parked ...	2-32
<b>Windows</b> .....	2-14	<b>Mirrors</b> .....	2-34
Power Windows .....	2-15	Automatic Dimming Rearview Mirror with	
Sun Visors .....	2-16	OnStar® and Compass .....	2-34
<b>Theft-Deterrent Systems</b> .....	2-17	Outside Manual Mirrors .....	2-35
Content Theft-Deterrent .....	2-17	Outside Power Mirrors .....	2-36
Passlock® .....	2-18	Outside Convex Mirror .....	2-36
		Outside Heated Mirrors .....	2-37
		Outside Automatic Dimming Mirror with Curb	
		View Assist .....	2-37

## Section 2 Features and Controls

---

<b>OnStar® System</b> .....	2-38	Luggage Carrier .....	2-48
<b>HomeLink® Transmitter</b> .....	2-40	Rear Floor Storage Lid .....	2-49
Programming the HomeLink® Transmitter .....	2-41	Convenience Net .....	2-49
<b>Storage Areas</b> .....	2-44	Cargo Cover .....	2-49
Glove Box .....	2-44	<b>Sunroof</b> .....	2-51
Overhead Console .....	2-44	<b>Vehicle Personalization</b> .....	2-52
Front Storage Area .....	2-45	Memory Seat .....	2-52
Table .....	2-47		

## Keys

### CAUTION:

Leaving children in a vehicle with the ignition key is dangerous for many reasons. A child or others could be badly injured or even killed.

They could operate the power windows or other controls or even make the vehicle move.

Don't leave the keys in a vehicle with children.





This vehicle has one double-sided key for the ignition and door locks. It will fit with either side up.

When a new vehicle is delivered, the dealer provides the owner with a pair of identical keys and a key code number.

The key code number tells your dealer or a qualified locksmith how to make extra keys. Keep this number in a safe place. If you lose your keys, you'll be able to have new ones made easily using this number. Your selling dealer should also have this number.

**Notice:** Your vehicle has a number of features that can help prevent theft. You can have a lot of trouble getting into your vehicle if you ever lock your keys inside. You may even have to damage your vehicle to get in. So be sure you have spare keys.

If you ever do get locked out of your vehicle, call the GM Roadside Assistance Center. See *Roadside Assistance Program* on page 7-5.

If your vehicle is equipped with the OnStar<sup>®</sup> system with an active subscription and you lock your keys inside the vehicle, OnStar<sup>®</sup> may be able to send a command to unlock your vehicle. See *OnStar<sup>®</sup> System* on page 2-38 for more information.

## Remote Keyless Entry System

If equipped, the keyless entry system operates on a radio frequency subject to Federal Communications Commission (FCC) Rules and with Industry Canada.

This device complies with Part 15 of the FCC Rules. Operation is subject to the following two conditions:

1. This device may not cause interference, and
2. This device must accept any interference received, including interference that may cause undesired operation of the device.

This device complies with RSS-210 of Industry Canada. Operation is subject to the following two conditions:

1. This device may not cause interference, and
2. This device must accept any interference received, including interference that may cause undesired operation of the device.

Changes or modifications to this system by other than an authorized service facility could void authorization to use this equipment.

At times you may notice a decrease in range. This is normal for any remote keyless entry system. If the transmitter does not work or if you have to stand closer to your vehicle for the transmitter to work, try this:

- Check the distance. You may be too far from your vehicle. You may need to stand closer during rainy or snowy weather.
- Check the location. Other vehicles or objects may be blocking the signal. Take a few steps to the left or right, hold the transmitter higher, and try again.
- Check to determine if battery replacement is necessary. See "Battery Replacement" under *Remote Keyless Entry System Operation on page 2-6*.
- If you are still having trouble, see your dealer or a qualified technician for service.



## Remote Keyless Entry System Operation

If your vehicle has this feature, you can lock and unlock your doors from about 3 feet (1 m) up to 30 feet (9 m) away using the remote keyless entry transmitter supplied with your vehicle.



**🔓 (Unlock):** When you press unlock, the driver's door will unlock automatically, the parking lamps may flash and the interior lights will go on.

You can program different feedback settings through the Driver Information Center (DIC). For more information see *Driver Information Center (DIC) on page 3-46*.

**🔒 (Lock):** Press lock to lock all the doors. Press lock again within three seconds and the horn will chirp.

**📣 (Panic):** Press the horn symbol to make the horn sound. The headlamps and taillamps will flash for up to 30 seconds. This can be turned off by pressing the horn button again, by waiting for 30 seconds, or by starting the vehicle.

## Matching Transmitter(s) to Your Vehicle

Each remote keyless entry transmitter is coded to prevent another transmitter from unlocking your vehicle. If a transmitter is lost or stolen, a replacement can be purchased through your dealer. Remember to bring any remaining transmitters with you when you go to your dealer. When the dealer matches the replacement transmitter to your vehicle, any remaining transmitters must also be matched. Once your dealer has coded the new transmitter, the lost transmitter will not unlock your vehicle. Each vehicle can have a maximum of four transmitters matched to it.

## Battery Replacement

Under normal use, the battery in your remote keyless entry transmitter should last about two years.

You can tell the battery is weak if the transmitter won't work at the normal range in any location. If you have to get close to your vehicle before the transmitter works, it's probably time to change the battery.

The Driver Information Center (DIC) will display a RFA # BATTERY LOW message when the transmitter battery is low.

**Notice:** When replacing the battery, use care not to touch any of the circuitry. Static from your body transferred to these surfaces may damage the transmitter.

To replace the battery in the remote keyless entry transmitter do the following:



1. Insert a thin coin in the slot between the covers of the transmitter housing. Gently pry the transmitter apart.
2. Remove and replace the battery with a three-volt CR2032 or equivalent battery, positive (+) side down.
3. Align the covers and snap them together.
4. Check the operation of the transmitter.

# Doors and Locks

## Door Locks

### CAUTION:

Unlocked doors can be dangerous.

- Passengers — especially children — can easily open the doors and fall out of a moving vehicle. When a door is locked, the handle won't open it. You increase the chance of being thrown out of the vehicle in a crash if the doors aren't locked. So, wear safety belts properly and lock the doors whenever you drive.
- Young children who get into unlocked vehicles may be unable to get out. A child can be overcome by extreme heat and can suffer permanent injuries or even death from heat stroke. Always lock your vehicle whenever you leave it.
- Outsiders can easily enter through an unlocked door when you slow down or stop your vehicle. Locking your doors can help prevent this from happening.

There are several ways to lock and unlock your vehicle. You can use the remote keyless entry system.

You can use your key to unlock your door from the outside.



You can lock or unlock the door from the inside by sliding the manual lever forward or rearward. When the door is unlocked, you can see a red area on the lever.

The manual lever on each door works only that door's lock.

## Power Door Locks



The power door lock switches are located on the driver's and front passenger's armrests.

Remove the ignition key and press the lock symbol to lock all of the doors at once. To unlock the doors, press the other side of the switch.

## Delayed Locking

This feature makes it easier to use the power door locks to lock all the doors and the liftgate when leaving your vehicle.

The first time you attempt to lock the doors using the power lock switch or the remote keyless entry transmitter (with any door or the liftgate open), three chimes will signal that delayed locking is being used. All doors and the liftgate can be reopened for up to five seconds from the time the last door is closed.

Five seconds after the last door is closed, all the doors will lock. You can lock the doors immediately by using the power door lock switch or the optional remote keyless entry transmitter a second time.

If the key is inserted in the ignition, this feature will not lock the doors. The lockout prevention feature will operate instead.

You can enable or disable the delayed locking feature. If the feature is disabled, the doors will lock immediately when a power door lock switch or remote keyless entry transmitter lock button is pressed.

## Programming Delayed Locking

When your vehicle was shipped from the factory, the delayed locking feature was programmed on, or enabled. The mode to which your vehicle was programmed may have been changed since it left the factory. To turn the delayed locking feature on or off, do the following:

1. Press and hold the power door lock switch on the driver's door in the lock position.
2. Press the remote keyless entry transmitter unlock button twice.

If the delayed locking feature was on, it would now be off. If the feature was off, it would now be on.

## Programmable Automatic Door Locks

Your vehicle is equipped with an automatic lock/unlock feature which enables you to program your vehicle's power door locks. You can program this feature through the Driver Information Center (DIC), or by the following method.

### Programmable Locking Feature

The following is the list of available programming options:

**Mode 1:** All doors lock when the transmission is shifted into gear.

**Mode 2:** All doors lock when the vehicle speed is greater than 8 mph (13 km/h).

**Mode 3:** No automatic door locking.

The automatic door locks were pre-programmed at the factory to lock all the doors when the transmission is shifted into gear. The following instructions detail how to program your door locks differently than the factory setting. Choose one of the three programming options listed above before entering the program mode.

To enter the program mode you need to do the following:

1. Begin with the ignition off. Then pull the turn signal/multifunction lever toward you and hold it there while you perform the next step.
2. Turn the key to RUN and LOCK twice. Then, with the key in LOCK, release the turn signal/multifunction lever. Once you do this, you will hear the lock switch lock and unlock, the horn will chirp twice, and a 30 second program timer will begin.
3. You are now ready to program the automatic door locks. Select one of the three programming options listed above, and press the lock side of the power door lock switch to cycle through the lock options. You will have 30 seconds to begin programming. If you exceed the 30 second limit, the locks will automatically lock and unlock and the horn will chirp twice to indicate that you have left the program mode. If this occurs, repeat the procedure beginning with Step 1 to re-enter the programming mode.

You can exit the program mode any time by turning the ignition to RUN. The locks will automatically lock and unlock and the horn will chirp twice to indicate that you are leaving the program mode. If the lock/unlock switches are not pressed while in the programming mode, the current auto lock/unlock setting will not be modified.

See your dealer for more information.

## Programmable Unlocking Feature

The following is the list of available programming options:

**Mode 1:** Driver's door unlocks when the transmission is shifted into PARK (P).

**Mode 2:** All doors unlock when the transmission is shifted into PARK (P).

**Mode 3:** All doors unlock when the key is removed from the ignition.

**Mode 4:** No automatic door unlock.

The automatic door locks were pre-programmed at the factory to unlock the driver's door once the transmission is shifted to PARK (P). The following instructions detail how to program your door locks differently than the factory setting. Choose one of the four programming options listed above before entering the program mode.

To enter the program mode you need to do the following:

1. Begin with the ignition off. Then pull the turn signal/multifunction lever toward you and hold it there while you perform the next step.

2. Turn the key to RUN and LOCK twice. Then, with the key in LOCK, release the turn signal/multifunction lever. Once you do this, you will hear the lock switch lock and unlock, the horn will chirp twice, and a 30 second program timer will begin.
3. You are now ready to program the automatic door locks. Select one of the four programming options listed above, and press the unlock side of the power door lock switch to cycle through the unlocking options. You will have 30 seconds to begin programming. If you exceed the 30 second limit, the locks will automatically lock and unlock and the horn will chirp twice to indicate that you have left the program mode. If this occurs, repeat the procedure beginning with Step 1 to re-enter the programming mode.

You can exit the program mode any time by turning the ignition to RUN. The locks will automatically lock and unlock and the horn will chirp twice to indicate that you are leaving the program mode. If the lock/unlock switches are not pressed while in the programming mode, the current auto lock/unlock setting will not be modified.

See your dealer for more information.

## Rear Door Security Locks

Your vehicle may have this feature. You can lock the rear doors so they can't be opened from the inside by passengers. To use one of these locks do the following:

1. Open one of the rear doors. You will find a security lock lever located on the inside edge of each rear door.



2. Move the lever down to engage the safety lock. Move the lever up to disengage the safety lock.

3. Close the door.
4. Do the same thing to the other rear door.

The rear doors of your vehicle cannot be opened from the inside when this feature is in use. If you want to open the rear door when the security lock is on, unlock the door and open the door from the outside.

## Lockout Protection

This feature stops the power door locks from locking when the key is in the ignition and a door is open to protect you from locking your key in the vehicle.

If the power lock switch is pressed when a door is open and the key is in the ignition, all the doors will lock and then the driver's door will unlock.

## Leaving Your Vehicle

If you are leaving the vehicle, take your key, open your door and set the lock from inside. Then get out and close the door.

## Liftgate/Liftglass

### CAUTION:

It can be dangerous to drive with the liftgate or liftglass open because carbon monoxide (CO) gas can come into your vehicle. You can't see or smell CO. It can cause unconsciousness and even death. If you must drive with the liftgate open or if electrical wiring or other cable connections must pass through the seal between the body and the liftgate or liftglass:

- Make sure all other windows are shut.
- Turn the fan on your heating or cooling system to its highest speed and select the control setting that will force outside air into your vehicle. See "Climate Controls" in the Index.
- If you have air outlets on or under the instrument panel, open them all the way. See "Engine Exhaust" in the Index.

## Liftgate Release

To unlock the liftgate, you may use the power door locks or the keyless entry system described earlier.

On some vehicles the liftglass will also unlock when the liftgate is unlocked. Press the pushbutton on the liftglass to open it.

To open the entire liftgate, lift the handle located in the center of the liftgate. If you open the liftgate, the liftgate module will lock the liftglass after a one to two second delay.

## Emergency Release for Opening Liftgate

1. Remove the trim plug to expose the access hole in the trim panel.
2. Use a tool to reach through the access hole in the trim panel.
3. Pry the left release lever up to the unlock position. Pry the right release lever up to unlatch the liftgate.
4. Reattach the trim plug.



## Windows

### CAUTION:

Leaving children in a vehicle with the windows closed is dangerous. A child can be overcome by the extreme heat and can suffer permanent injuries or even death from heat stroke. Never leave a child alone in a vehicle, especially with the windows closed in warm or hot weather.



## Power Windows



The controls for the power windows are located on the armrest on each of the side doors. With power windows, the switches operate the windows when the ignition is in RUN, ACCESSORY or when Retained Accessory Power (RAP) is active. The driver's door has a switch for each of the passenger's windows as well.

Press the bottom of the switch to lower the window.  
Press the top of the switch to raise the window.

## **Express–Down Window**

The driver's and front passenger's window switches have an express-down feature that allows you to lower the window without holding the switch down. Press the bottom of the driver's window switch down briefly to activate the express-down feature. Lightly tap the switch to open the window slightly. The express-down feature can be interrupted at any time by pressing the top of the switch.

## **Window Lockout**

Your vehicle has a lockout feature to prevent passengers from operating the power windows. A small light in the lockout switch will come on to show that the switch has been activated. Press the lockout switch again to return to normal operation.

## **Sun Visors**

To block out glare, you can pull the visor down. You can also slide the visor from side-to-side to cover the driver or passenger front window.

## **Visor Vanity Mirror**

Pull the sun visor down to expose the vanity mirror

## **Lighted Visor Vanity Mirror**

Your vehicle may have this feature. Pull the sun visor down and lift the mirror cover to turn on the lamps.

## Theft-Deterrent Systems

Vehicle theft is big business, especially in some cities. Although your vehicle has a number of theft-deterrent features, we know that nothing we put on it can make it impossible to steal. However, there are ways you can help.

### Content Theft-Deterrent

Your vehicle may be equipped with a content theft-deterrent alarm system.



United States



Canada

Here's how to operate the system:

1. Open the door.
2. Lock the door with the power door lock switch or the remote keyless entry transmitter. The SECURITY light should flash.

3. Close all doors. The SECURITY light should go off after approximately 30 seconds. The alarm is not armed until the SECURITY light goes off.

If a locked door is opened without the key or the remote keyless entry transmitter, the alarm will go off. The headlamps and parking lamps will flash for two minutes, and the horn will sound for 30 seconds, then will turn off to save the battery power.

Remember, the theft-deterrent system won't activate if you lock the doors with a key or use the manual door lock. It activates only if you use a power door lock switch with the door open, or with the remote keyless entry transmitter. You should also remember that you can start your vehicle with the correct ignition key if the alarm has been set off.

Here's how to avoid setting off the alarm by accident:

- If you don't want to activate the theft-deterrent system, the vehicle should be locked with the door key *after* the doors are closed.
- Always unlock a door with a key, or use the remote keyless entry transmitter. Unlocking a door any other way will set off the alarm.

If you set off the alarm by accident, unlock any door with the key. You can also turn off the alarm by pressing unlock on the remote keyless entry transmitter. The alarm won't stop if you try to unlock a door any other way.

## Testing the Alarm

The alarm can be tested by following these steps:

1. From inside the vehicle, lower the driver's window and open the driver's door.
2. Activate the system by locking the doors with the power door lock switch while the door is open, or with the remote keyless entry transmitter.
3. Get out of the vehicle, close the door and wait for the SECURITY light to go out.
4. Then reach in through the window, unlock the door with the manual door lock and open the door. This should set off the alarm.

When the alarm is set the power door unlock switch is not operational.

If the alarm does not sound when it should but the headlamps flash, check to see if the horn works. The horn fuse may be blown. To replace the fuse, see *Fuses and Circuit Breakers on page 5-85*.

If the alarm does not sound or the headlamps do not flash, the vehicle should be serviced by your dealer.

## Passlock<sup>®</sup>

Your vehicle is equipped with the Passlock<sup>®</sup> theft-deterrent system.

Passlock<sup>®</sup> is a passive theft-deterrent system. Passlock<sup>®</sup> enables fuel if the ignition lock cylinder is turned with a valid key. If a correct key is not used or the ignition lock cylinder is tampered with, the fuel system is disabled and the vehicle will not start.

During normal operation, the SECURITY light will turn off approximately five seconds after the key is turned to RUN.

If the engine stalls and the SECURITY light flashes, wait about 10 minutes until the light stops flashing before trying to restart the engine. Remember to release the key from START as soon as the engine starts.

If the engine does not start after three tries, the vehicle needs service.

If the engine is running and the SECURITY light comes on, you will be able to restart the engine if you turn the engine off. However, your Passlock<sup>®</sup> system is not working properly and must be serviced by your dealer. Your vehicle is not protected by Passlock<sup>®</sup> at this time. You may also want to check the fuse. See *Fuses and Circuit Breakers on page 5-85*. See your dealer for service.

In an emergency, call the GM Roadside Assistance Center. See *Roadside Assistance Program on page 7-5*.

# Starting and Operating Your Vehicle

## New Vehicle Break-In

*Notice:* Your vehicle doesn't need an elaborate "break-in." But it will perform better in the long run if you follow these guidelines:

- Keep your speed at 55 mph (88 km/h) or less for the first 500 miles (805 km).
- Don't drive at any one speed — fast or slow — for the first 500 miles (805 km). Don't make full-throttle starts.
- Avoid making hard stops for the first 200 miles (322 km) or so. During this time your new brake linings aren't yet broken in. Hard stops with new linings can mean premature wear and earlier replacement. Follow this breaking-in guideline every time you get new brake linings.
- Don't tow a trailer during break-in. See "Towing a Trailer" in the Index for more information.

## Ignition Positions

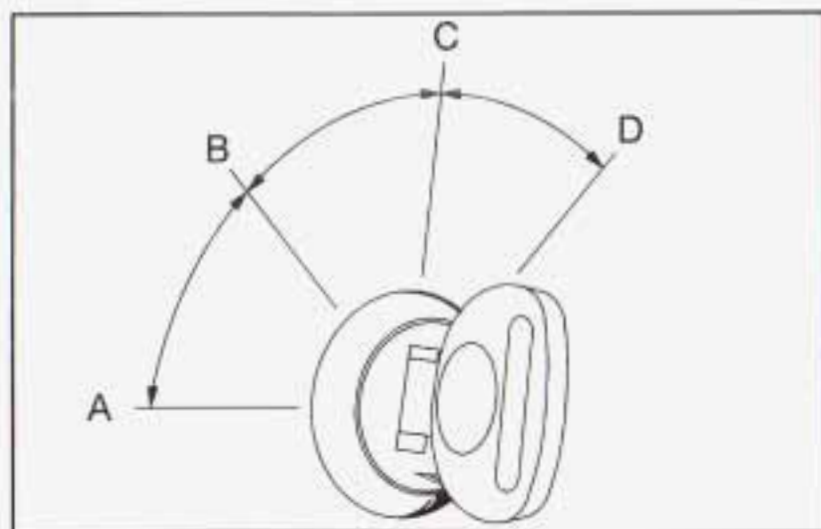

Use the key to turn the ignition switch to four different positions.

**A (LOCK):** This position locks the ignition and transmission. It's a theft-deterrent feature. You will only be able to remove the key when the ignition is turned to LOCK.

**Notice:** If your key seems stuck in LOCK and you can't turn it, be sure you are using the correct key; if so, is it all the way in? Turn the key only with your hand. Using a tool to force it could break the key or the ignition switch. If none of these works, then your vehicle needs service.

**B (ACCESSORY):** This position lets you use things like the radio and the windshield wipers when the engine is off.

**Notice:** Don't operate accessories in the ACCESSORY position for long periods of time. Prolonged operation of accessories in the ACCESSORY position could drain your battery and prevent you from starting your vehicle.

**C (RUN):** This is the position for driving.

**D (START):** This position starts the engine.

## Retained Accessory Power (RAP)

Your vehicle is equipped with a Retained Accessory Power (RAP) feature which will allow certain features of your vehicle to continue to work up to 20 minutes after the ignition key is turned to LOCK.

Your radio, power windows, sunroof (option) and overhead console will work when the ignition key is in RUN or ACCESSORY. Once the key is turned from RUN to LOCK, these features will continue to work for up to 20 minutes or until a door is opened.

## Starting Your Engine

Move your shift lever to PARK (P) or NEUTRAL (N). Your engine won't start in any other position—that's a safety feature. To restart when you're already moving, use NEUTRAL (N) only.

**Notice:** Don't try to shift to PARK (P) if your vehicle is moving. If you do, you could damage the transmission. Shift to PARK (P) only when your vehicle is stopped.

1. With your foot off the accelerator pedal, turn the ignition key to START. When the engine starts, let go of the key. The idle speed will go down as your engine gets warm.

**Notice:** Holding your key in START for longer than 15 seconds at a time will cause your battery to be drained much sooner. And the excessive heat can damage your starter motor. At 15 seconds, the starter will automatically be disengaged. Wait about 15 seconds between each try to help avoid draining your battery or damaging your starter.

2. If it doesn't start within 10 seconds, push the accelerator pedal all the way to the floor, while you hold the ignition key in START. When the engine starts, let go of the key and let up on the accelerator pedal. Wait about 15 seconds between each try.

When starting your engine in very cold weather (below 0°F or -18°C), do this:

1. With your foot off the accelerator pedal, turn the ignition key to START and hold it there up to 15 seconds. When the engine starts, let go of the key.
2. If your engine still won't start (or starts but then stops), it could be flooded with too much gasoline. Try pushing your accelerator pedal all the way to the floor and holding it there as you hold the key in START for about three seconds. When the engine starts, let go of the key and accelerator. If the vehicle starts briefly but then stops again, do the same thing, but this time keep the pedal down for five or six seconds. This clears the extra gasoline from the engine.

**Notice:** Your engine is designed to work with the electronics in your vehicle. If you add electrical parts or accessories, you could change the way the engine operates. Before adding electrical equipment, check with your dealer. If you don't, your engine might not perform properly.

## Engine Coolant Heater

Your vehicle may have this feature. In very cold weather, 0°F (-18°C) or colder, the engine coolant heater can help. You'll get easier starting and better fuel economy during engine warm-up. Usually, the coolant heater should be plugged in a minimum of four hours prior to starting your vehicle. At temperatures above 32°F (0°C), use of the coolant heater is not required.

### To Use the Engine Coolant Heater

1. Turn off the engine.
2. Open the hood and unwrap the electrical cord. The cord is located on the driver's side of the engine compartment, behind the battery.
3. Plug it into a normal, grounded 110-Volt AC outlet.



## CAUTION:

Plugging the cord into an ungrounded outlet could cause an electrical shock. Also, the wrong kind of extension cord could overheat and cause a fire. You could be seriously injured. Plug the cord into a properly grounded three-prong 110-volt AC outlet. If the cord won't reach, use a heavy-duty three-prong extension cord rated for at least 15 amps.

4. Before starting the engine, be sure to unplug and store the cord as it was before to keep it away from moving engine parts. If you don't, it could be damaged.

How long should you keep the coolant heater plugged in? The answer depends on the outside temperature, the kind of oil you have, and some other things. Instead of trying to list everything here, we ask that you contact your dealer in the area where you'll be parking your vehicle. The dealer can give you the best advice for that particular area.

## Automatic Transmission Operation

There are several different positions for your shift lever.

**PARK (P):** This position locks the rear wheels. It's the best position to use when you start the engine because your vehicle can't move easily.

## CAUTION:

It is dangerous to get out of your vehicle if the shift lever is not fully in PARK (P) with the parking brake firmly set. Your vehicle can roll.

Don't leave your vehicle when the engine is running unless you have to. If you have left the engine running, the vehicle can move suddenly. You or others could be injured. To be sure your vehicle won't move, even when you're on fairly level ground, always set your parking brake and move the shift lever to PARK (P). See "Shifting Into Park (P)" in the Index. If you're pulling a trailer, see "Towing a Trailer" in the Index.

## CAUTION:

If you have four-wheel drive, your vehicle will be free to roll — even if your shift lever is in PARK (P) — if your transfer case is in NEUTRAL. So, be sure the transfer case is in a drive gear — not in NEUTRAL. See “Four-Wheel Drive (Automatic Transfer Case) in the Index. See “Shifting Into Park (P)” in the Index.

Ensure the shift lever is fully in PARK (P) before starting the engine. Your vehicle has an automatic transmission shift lock control system. You have to fully apply the regular brakes before you can shift from PARK (P) when the ignition key is in RUN. If you cannot shift out of PARK (P), ease pressure on the shift lever, press the button on the shift lever and push the shift lever all the way into PARK (P) as you maintain brake application. Move the shift lever into the gear you wish. See *Shifting Out of Park (P)* on page 2-30.

**REVERSE (R):** Use this gear to back up.

**Notice:** Shifting to REVERSE (R) while your vehicle is moving forward could damage your transmission. Shift to REVERSE (R) only after your vehicle is stopped.

To rock your vehicle back and forth to get out of snow, ice or sand without damaging your transmission, see *If You Are Stuck: In Sand, Mud, Ice or Snow* on page 4-39.

**NEUTRAL (N):** In this position, the engine doesn't connect with the wheels. To restart when you're already moving, use NEUTRAL (N) only.

## CAUTION:

Shifting into a drive gear while your engine is “racing” (running at high speed) is dangerous. Unless your foot is firmly on the brake pedal, your vehicle could move very rapidly. You could lose control and hit people or objects. Don't shift into a drive gear while your engine is racing.

**Notice:** Damage to your transmission caused by shifting out of PARK (P) or NEUTRAL (N) with the engine racing isn't covered by your warranty.

On cold days, approximately 32°F (0°C) or colder, your transmission is designed to shift differently until the engine reaches normal operating temperature. This is intended to improve heater performance.

**DRIVE (D):** This position is for normal driving. If you need more power for passing, and you're:

- Going less than about 35 mph (55 km/h), push the accelerator pedal about halfway down.
- Going about 35 mph (55 km/h) or more, push the accelerator all the way down.

You'll shift down to the next gear and have more power.

DRIVE (D) can be used when towing a trailer, carrying a heavy load, driving on steep hills or for off-road driving. You may want to shift the transmission to THIRD (3) or, if necessary, a lower gear selection if the transmission shifts too often.

**THIRD (3):** This position is also used for normal driving, however it offers more power and lower fuel economy than DRIVE (D).

**SECOND (2):** This position gives you more power but lower fuel economy than THIRD (3). You can use SECOND (2) on hills. It can help control your speed as you go down steep mountain roads, but then you would also want to use the brakes off and on.

You can also use SECOND (2) for starting the vehicle from a stop on slippery road surfaces.

**FIRST (1):** This position gives you even more power but lower fuel economy than SECOND (2). You can use it on very steep hills, or in deep snow or mud. If the selector lever is put in FIRST (1) while the vehicle is moving forward, the transmission won't shift into first gear until the vehicle is going slowly enough.

**Notice:** If your wheels won't turn, don't try to drive. This might happen if you were stuck in very deep sand or mud or were up against a solid object. You could damage your transmission. Also, if you stop when going uphill, don't hold your vehicle there with only the accelerator pedal. This could overheat and damage the transmission. Use your brakes or shift into PARK (P) to hold your vehicle in position on a hill.

## Shift Lock Release

This vehicle is equipped with a shift lock release system. If your vehicle has a dead battery and you need to have your vehicle towed, there is a shift lock release lever that will allow you to move the shift lever out of PARK (P).

To access the shift lock release lever, do the following:

1. Press on the sides of the boot around the shift lever to release the boot.
2. Lift up the boot on the shift lever and you will see an orange lever.
3. Lift the orange lever up and move the shift lever out of PARK (P).
4. Snap the shift lever boot back in place.

## Four-Wheel Drive

If your vehicle has four-wheel drive, you can send your engine's driving power to all four wheels for extra traction. To get the most satisfaction out of four-wheel drive, you must be familiar with its operation. Read the part that follows before using four-wheel drive. You should use two-wheel drive high (2HI) for most normal driving conditions.

**Notice:** Driving in the 4-WHEEL HIGH (4HI) or 4-WHEEL LOW (4LO) positions for a long time on dry or wet pavement could shorten the life of your vehicle's drivetrain.

## Automatic Transfer Case



If your vehicle is equipped with the automatic transfer case, the transfer case knob is located to the right of the steering wheel on the instrument panel. Use this knob to shift into and out of four-wheel drive.

**2HI (Two-Wheel High):** This setting is for driving in most street and highway situations. Your front axle is not engaged in two-wheel drive. It also provides the best fuel economy.

**A4WD (Automatic Four-Wheel Drive):** This setting is ideal for use when road conditions are variable. When driving your vehicle in A4WD, the front axle is engaged, but the vehicle's power is sent to the rear wheels. When the vehicle senses a loss of traction, the system will automatically engage four-wheel drive. Driving in this mode results in slightly lower fuel economy than 2HI.

**4HI (Four-Wheel High):** Use 4HI when you need extra traction, such as on snowy or icy roads or in most off-road situations. This setting also engages your front axle to help drive your vehicle.

**4LO (Four-Wheel Low):** This setting also engages your front axle and delivers extra torque. You may never need 4LO. It sends maximum power to all four wheels. You might choose 4LO if you are driving off-road in deep sand, deep mud, and climbing or descending steep hills.

## CAUTION:

Shifting the transfer case to NEUTRAL can cause your vehicle to roll even if the transmission is in PARK (P). You or someone else could be seriously injured. Be sure to set the parking brake before placing the transfer case in NEUTRAL. See "Parking Brake" in the Index.

**NEUTRAL:** Shift the vehicle's transfer case to NEUTRAL only when towing your vehicle. See *Recreational Vehicle Towing on page 4-42* for more information.

An indicator light in the knob will show you which position the transfer case is in. The indicator lights will come on briefly when you turn on the ignition and one will stay on. If the lights do not come on, you should take your vehicle to your dealer for service. An indicator light will flash while shifting the transfer case. It will remain illuminated when the shift is complete. If for some reason the transfer case cannot make a requested shift, it will return to the last chosen setting.

If the SERVICE 4WD light on the instrument panel cluster stays on, you should take your vehicle to your dealer for service. See *Service Four-Wheel Drive Warning Light on page 3-44* for further information.

### Shifting into 4HI or A4WD

Turn the knob to 4HI or A4WD. This can be done at any speed and the indicator light will flash while shifting. It will remain illuminated when the shift is complete.

### Shifting into 2HI

Turn the knob to 2HI. This can be done at any speed.

### Shifting into 4LO

To shift to 4LO, the vehicle's engine must be running and the vehicle must be stopped or moving less than 2 mph (3.2 km/h) with the transmission in NEUTRAL (N). The preferred method for shifting into 4LO is to have your vehicle moving 1 or 2 mph (1.6 to 3.2 km/h). Turn the knob to 4LO. You must wait for the 4LO indicator light to stop flashing and remain illuminated before shifting your transmission into gear.

If you turn the knob to 4LO when your vehicle is in gear and/or moving, the 4LO indicator light will flash for 30 seconds and not complete the shift unless your vehicle is moving less than 2 mph (3.2 km/h) and the transmission is in NEUTRAL (N). After 30 seconds, the transfer case will return to the setting last chosen.

## Shifting Out of 4LO

To shift from 4LO to 4HI, A4WD or 2HI your vehicle must be stopped or moving less than 2 mph (3.2 km/h) with the transmission in NEUTRAL (N) and the engine running. The preferred method for shifting out of 4LO is to have your vehicle moving 1 or 2 mph (1.6 to 3.2 km/h). Turn the knob to 4HI, A4WD or 2HI. You must wait for the 4HI, A4WD or 2HI indicator light to stop flashing and remain illuminated before shifting your transmission into gear.

If the 4HI, A4WD or 2HI knob is turned when your vehicle is in gear and/or moving, the 4HI, A4WD or 2HI indicator light will flash for 30 seconds but will not complete the shift unless your vehicle is moving less than 2 mph (3.2 km/h) with the transmission in NEUTRAL (N).

## Shifting into NEUTRAL

Before shifting the transfer case to NEUTRAL, first make sure the vehicle is parked so that it will not roll.

1. Set the parking brake.
2. Start the vehicle.
3. Connect the vehicle to the towing vehicle.
4. Put the transmission in NEUTRAL (N).
5. Shift the transfer case to 2HI.
6. Turn the transfer case knob all of the way past 4LO and hold it there for a minimum of 10 seconds. The neutral indicator light will come on.

7. Shift the transmission to REVERSE (R) for one second, then shift the transmission to DRIVE (D) for one second.
8. Place the transmission shift lever in PARK (P).
9. Turn the ignition to LOCK.
10. Release the parking brake prior to towing.

## Shifting Out of NEUTRAL

To shift the transfer case out of NEUTRAL, do the following:

1. Set the parking brake and apply the regular brake pedal.
2. Start the vehicle with the transmission in PARK (P).
3. Turn the transfer case knob to the desired shift position (2HI, 4HI or A4WD).
4. Put the transmission in NEUTRAL (N).
5. After the transfer case has shifted out of NEUTRAL, the indicator light will go out. Shift the transmission lever to the desired position.

A re-engagement sound is normal when shifting out of NEUTRAL.

## Parking Brake

To set the parking brake, hold the regular brake pedal down with your right foot and pull up on the parking brake lever. If the ignition is on, the brake system warning light will come on.

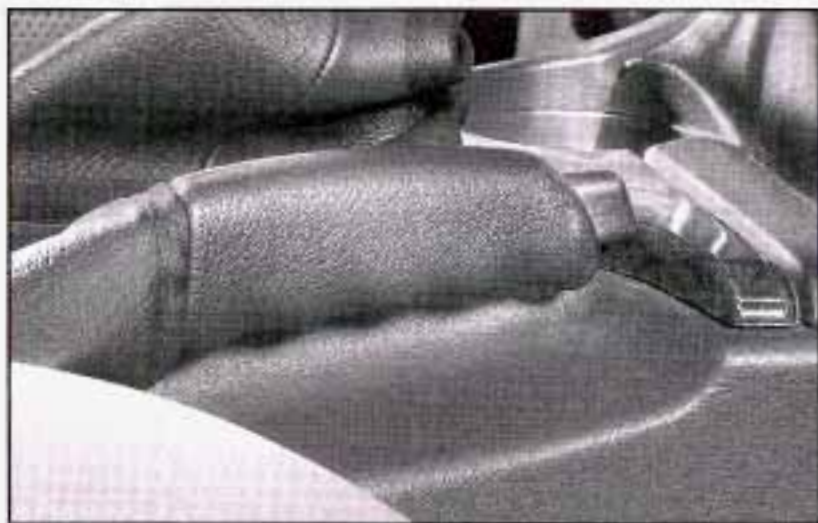

To release the parking brake, hold the regular brake pedal down. Pull the parking brake lever up until you can press in the button at the end of the lever. Hold the button in as you move the parking brake lever all the way down.

**Notice:** Driving with the parking brake on can cause your parking brake to overheat. You may have to replace them, and you could also damage other parts of your vehicle.

If you are towing a trailer and you must park on a hill, see *Towing a Trailer on page 4-47*. That section shows what to do first to keep the trailer from moving.

## Shifting Into Park (P)

### CAUTION:

It can be dangerous to get out of your vehicle if the shift lever is not fully in PARK (P) with the parking brake firmly set. Your vehicle can roll. If you have left the engine running, the vehicle can move suddenly. You or others could be injured. To be sure your vehicle won't move, even when you're on fairly level ground, use the steps that follow. With four-wheel

CAUTION: (Continued)

## **CAUTION: (Continued)**

drive, your vehicle will be free to roll — even if your shift lever is in PARK (P) — if your transfer case is in NEUTRAL. So, be sure the transfer case is in a drive gear — not in NEUTRAL. See “Four-Wheel Drive” in the Index. Always put the shift lever fully in PARK (P) with the parking brake firmly set. If you’re pulling a trailer, see “Towing a Trailer” in the Index.

1. Hold the brake pedal down with your right foot and set the parking brake.
2. Move the shift lever into PARK (P).
  - Press the button in on the side of the lever.
  - Push the lever all the way toward the front of the vehicle.
3. Turn the ignition key to LOCK.
4. Remove the key and take it with you. You know your vehicle is in PARK (P) if the key can be removed from the ignition.

## **Leaving Your Vehicle With the Engine Running**

### **CAUTION:**

It can be dangerous to leave your vehicle with the engine running. Your vehicle could move suddenly if the shift lever is not fully in PARK (P) with the parking brake firmly set.

If you have four-wheel drive, your vehicle will be free to roll — even if your lever is in PARK (P) — if your transfer case is in NEUTRAL. So be sure the transfer case is in a drive gear — not NEUTRAL. See “Four-Wheel Drive (Automatic Transfer Case)” in the Index.

**And, if you leave the vehicle with the engine running, it could overheat and even catch fire. You or others could be injured. Don't leave your vehicle with the engine running unless you have to.**

If you have to leave your vehicle with the engine running, be sure your vehicle is in PARK (P) and your parking brake is firmly set before you leave it. After you've moved the shift lever into PARK (P), hold



the regular brake pedal down. Then, see if you can move the shift lever away from PARK (P) without first pulling it toward you (or pressing the button on a console shift lever). If you can, it means that the shift lever wasn't fully locked into PARK (P).

## Torque Lock

If you are parking on a hill and you don't shift your transmission into PARK (P) properly, the weight of the vehicle may put too much force on the parking pawl in the transmission. You may find it difficult to pull the shift lever out of PARK (P). This is called "torque lock." To prevent torque lock, set the parking brake and then shift into PARK (P) properly before you leave the driver's seat. To find out how, see *Shifting Into Park (P) on page 2-28*.

When you are ready to drive, move the shift lever out of PARK (P) *before* you release the parking brake.

If torque lock does occur, you may need to have another vehicle push yours a little uphill to take some of the pressure from the parking pawl in the transmission, so you can pull the shift lever out of PARK (P).

## Shifting Out of Park (P)

Your vehicle has an automatic transmission shift lock control system. You have to fully apply the regular brakes before you can shift from PARK (P) when the ignition is in RUN. See *Automatic Transmission Operation on page 2-22*.

If you cannot shift out of PARK (P), ease pressure on the shift lever. Push the shift lever all the way into PARK (P) as you maintain brake application. Then press the shift lever button and move the shift lever into the gear you want.

If you ever hold the brake pedal down but still can't shift out of PARK (P), try this:

1. Turn the key to LOCK.
2. Apply and hold the brake until the end of Step 4.
3. Shift to NEUTRAL (N).
4. Start the vehicle and then shift to the drive gear you want.
5. Have the vehicle fixed as soon as possible.

## Parking Over Things That Burn

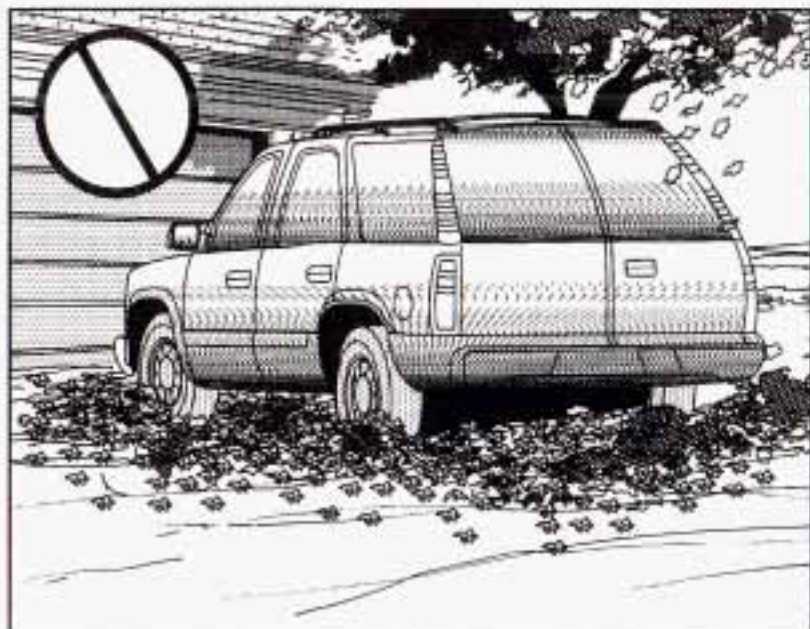

### CAUTION:

Things that can burn could touch hot exhaust parts under your vehicle and ignite. Don't park over papers, leaves, dry grass or other things that can burn.

## Engine Exhaust

### CAUTION:

Engine exhaust can kill. It contains the gas carbon monoxide (CO), which you can't see or smell. It can cause unconsciousness and death.

You might have exhaust coming in if:

- Your exhaust system sounds strange or different.
- Your vehicle gets rusty underneath.
- Your vehicle was damaged in a collision.
- Your vehicle was damaged when driving over high points on the road or over road debris.
- Repairs weren't done correctly.
- Your vehicle or exhaust system had been modified improperly.

If you ever suspect exhaust is coming into your vehicle:

- Drive it only with all the windows down to blow out any CO; and
- Have your vehicle fixed immediately.

## Running Your Engine While You Are Parked

It's better not to park with the engine running. But if you ever have to, here are some things to know.

### CAUTION:

Idling the engine with the climate control system off could allow dangerous exhaust into your vehicle. See the earlier Caution under "Engine Exhaust."

Also, idling in a closed-in place can let deadly carbon monoxide (CO) into your vehicle even if the fan is at the highest setting. One place this can happen is a garage. Exhaust — with CO — can come in easily. **NEVER** park in a garage with the engine running.

Another closed-in place can be a blizzard. See "Winter Driving" in the Index.

### CAUTION:

It can be dangerous to get out of your vehicle if the shift lever is not fully in PARK (P) with the parking brake firmly set. Your vehicle can roll. Don't leave your vehicle when the engine is running unless you have to. If you've left the engine running, the vehicle can move suddenly. You or others could be injured. To be sure your vehicle won't move, even when you're on fairly level ground, always set your parking brake and move the shift lever to PARK (P).

 **CAUTION:**

If you have four-wheel drive, your vehicle will be free to roll — even if your shift lever is in PARK (P) — if your transfer case is in NEUTRAL. So be sure the transfer case is in a drive gear — not in NEUTRAL. See “Four-Wheel Drive (Automatic Transfer case)” in the Index.

Follow the proper steps to be sure your vehicle won't move. See *Shifting Into Park (P)* on page 2-28.

If you're pulling a trailer, see *Towing a Trailer* on page 4-47.

## Mirrors

### Automatic Dimming Rearview Mirror with OnStar® and Compass



Your vehicle may have an automatic-dimming rearview mirror with a compass and the OnStar® system.

 (On/Off): This is the on/off button for the automatic dimming feature and compass.

There are three additional buttons for the OnStar® system. See your dealer for more information on the system and how to subscribe to OnStar®. See *OnStar® System on page 2-38* for more information about the services OnStar® provides.

### Mirror Operation

When turned on, this mirror automatically dims to the proper level to minimize glare from any headlamps behind you after dark.

The automatic dimming feature is turned on and off by pressing the far left button, located on the lower part of the mirror face, for up to three seconds. A light on the mirror will be lit while the feature is turned on.

### Compass Operation

Press the on/off button once to turn the compass on or off.

There is a compass display in the window in the upper right corner of the mirror face. The compass displays a maximum of two characters. For example, "NE" is displayed for north-east.

### Compass Calibration

Press and hold the on/off button down for nine seconds to activate the compass calibration mode. "CAL" will be displayed in the compass window on the mirror.

The mirror can be calibrated in one of two ways:

- Drive the vehicle in circles at 5 mph (8 km/h) or less until the display shows "CAL", or
- drive the vehicle on your everyday routine. (This method may take longer to calibrate.)

### Compass Variance

Compass variance is the difference between earth's magnetic north and true geographic north. The mirror is set to zone eight upon leaving the factory. It will be

necessary to adjust the compass to compensate for compass variance if you live outside zone eight. Under certain circumstances, such as during a long distance cross-country trip, it will be necessary to adjust for compass variance. If not adjusted to account for compass variance, your compass could give false readings.

To adjust for compass variance, do the following:

1. Find your current location and variance zone number on the map.

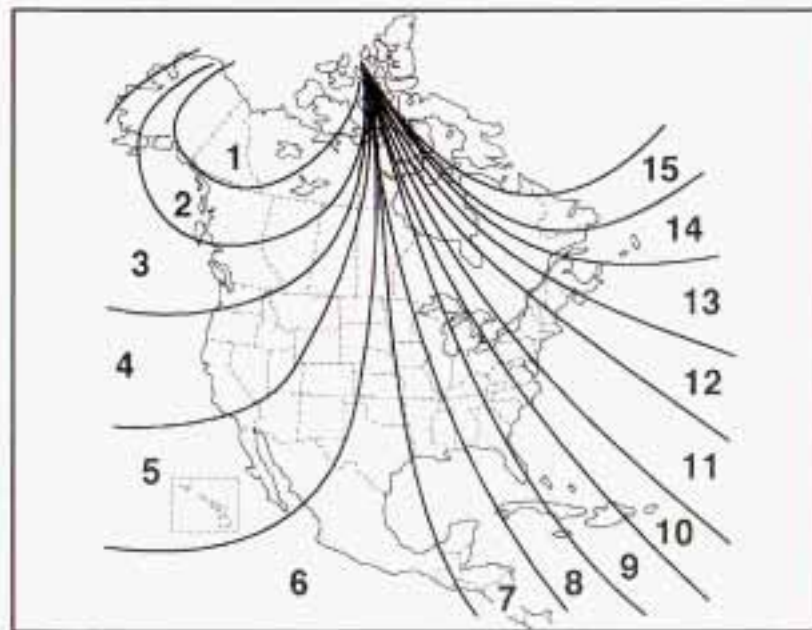

2. Press and hold the on/off button for six seconds. Release the button when "ZONE" is displayed. The number shown is the current zone number.
3. Scroll through the zone numbers that appear in the compass/temperature window on the mirror by pressing the on/off button. Once you find your zone number, release the button. After about four seconds, the mirror will return to the compass display, and the new zone number will be set.

## Outside Manual Mirrors

Adjust your outside mirrors so you can see a little of the side of your vehicle.

Fold the mirrors in before entering a car wash. To do this, pull the mirrors in toward the vehicle. Push the mirrors back out when finished.

## Outside Power Mirrors

Your vehicle may have this feature.

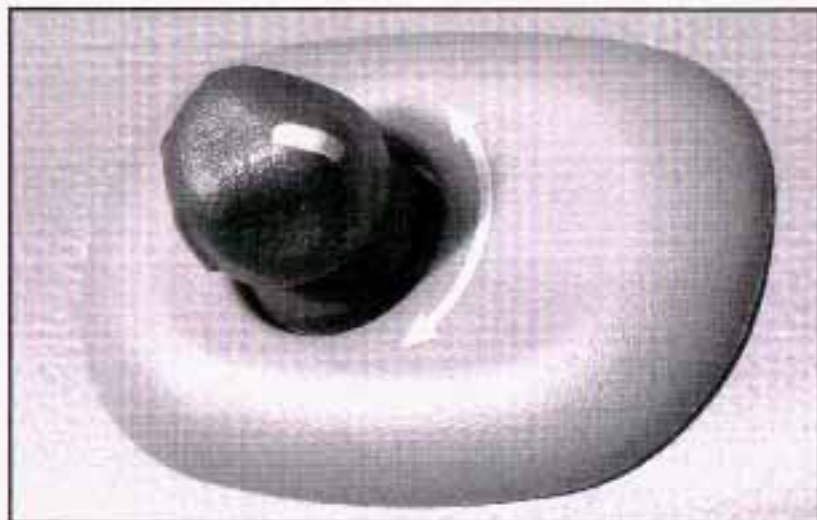

The control is located on the driver's door.

1. Twist the knob toward the mirror you desire to adjust.
2. Move the knob in the direction you want the mirror to go
3. Adjust the mirror in all four directions.
4. After you are satisfied with the position of the mirror, twist the knob to the center position or twist it to the other mirror to adjust that mirror.

If you reach the mirror's end of the travel position in any direction, the mirror will enter a ratcheting mode. This action is harmless. It is a warning that the mirror can go no further. To stop this action, back the mirror up by moving the knob in the opposite direction.

When the knob is twisted to the center position, the mirrors can not be moved with the control knob.

## Outside Convex Mirror

A convex mirror's surface is curved so you can see more from the driver's seat.

### CAUTION:

**A convex mirror can make things (like other vehicles) look farther away than they really are. If you cut too sharply into the right or left lane, you could hit a vehicle. Check your inside mirror or glance over your shoulder before changing lanes.**

## Outside Heated Mirrors

Your vehicle may have this feature.

When you operate the rear window defogger, a defogger also warms the heated driver's and passenger's outside rearview mirrors to help clear them of ice, snow and condensation.

## Outside Automatic Dimming Mirror with Curb View Assist

If your vehicle has this feature, the driver's and/or passenger's outside mirror will adjust to a preset tilt position while the vehicle is in REVERSE (R) gear. Curb view assist may be useful when you are parallel parking. The mirror(s) will return to normal position when the vehicle is shifted out of REVERSE (R) gear. Automatic mirror movement in either direction will follow a short delay.

To first activate this feature, perform the following steps:

1. Press the Personalization button, located on the steering wheel, until "Tilt Mirror in REVERSE (R)" is displayed on the DIC display.

2. Press the Select button once to select the passenger's side mirror, twice for the driver's side mirror and three times for both mirrors. Then press the Personalization button repeatedly until the display goes blank.
3. With the engine running, engage the parking brake, press the brake pedal and place the vehicle in REVERSE (R) gear.
4. Adjust the passenger's side and then the driver's side outside mirrors to the desired tilt positions. These positions will be stored into memory once the vehicle is shifted out of REVERSE (R).

When the vehicle is placed in PARK (P) or in any forward gear, the mirror(s) will return to normal driving position, following a short delay.

To change the tilt position, adjust the mirror while the vehicle is in REVERSE (R) gear with the engine running, the parking brake engaged and the brake pedal pressed. The new position will be saved into memory once the vehicle is shifted out of REVERSE (R).



## OnStar<sup>®</sup> System

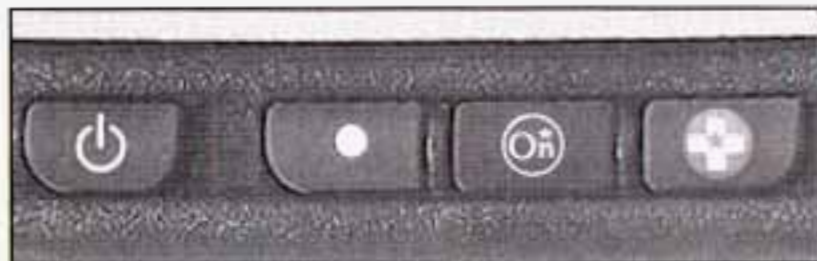

Your vehicle may be equipped with the OnStar<sup>®</sup> System. OnStar<sup>®</sup> uses global positioning system (GPS) satellite technology, wireless communications, and state of the art call centers to provide you with a wide range of safety, security, information and convenience services. An OnStar<sup>®</sup> subscription plan is included in the price of your vehicle. You can easily upgrade or extend your OnStar<sup>®</sup> services to meet your personal needs.

A complete OnStar<sup>®</sup> user's guide and the terms and conditions of the OnStar<sup>®</sup> Subscription Service Agreement are included in your OnStar<sup>®</sup> -equipped vehicle's glove box literature. For more information, visit [www.onstar.com](http://www.onstar.com), contact OnStar<sup>®</sup> at 1-888-4-ONSTAR (1-888-466-7827), or press the blue OnStar<sup>®</sup> button to speak to an OnStar<sup>®</sup> advisor 24 hours a day, 7 days a week.

## OnStar<sup>®</sup> Services

OnStar<sup>®</sup> provides a number of service plans to closely meet your needs. Some of the services currently provided by OnStar<sup>®</sup> are:

- Automatic Notification of Air Bag Deployment
- Emergency Services
- Roadside Assistance Stolen Vehicle Tracking
- AccidentAssist
- Remote Door Unlock
- Remote Diagnostics
- OnStar<sup>®</sup> MED-NET (Requires separate activation and annual fee on some plans)
- Online and Personal Concierge Services
- Route Support
- RideAssist
- Information and Convenience Services

## **OnStar<sup>®</sup> Personal Calling**

With OnStar<sup>®</sup> Personal Calling, you have a safer way to stay connected while driving. It's a hands-free wireless phone that's integrated into your vehicle. You can place calls nationwide using voice-activated dialing with no contracts, no roaming charges and no access fees. To find out more about OnStar<sup>®</sup> Personal Calling, refer to the OnStar<sup>®</sup> owner's guide in your vehicle's glove box, or call OnStar<sup>®</sup> at 1-888-4-ONSTAR (1-888-466-7827).

## **OnStar<sup>®</sup> Virtual Advisor**

With OnStar<sup>®</sup> Virtual Advisor you can listen to your favorite news, entertainment and information topics, such as traffic and weather reports, stock quotes and sports scores. You listen to your e-mail through your vehicle's speakers, and reply with your hands on the wheel and your eyes on the road.

A completed Subscription Service Agreement is required prior to delivery of OnStar<sup>®</sup> services and prepaid calling minutes are also required for OnStar<sup>®</sup> Personal Calling and OnStar<sup>®</sup> Virtual Advisor use. Terms and conditions of the Subscription Service Agreement can be found at [www.onstar.com](http://www.onstar.com).

## HomeLink<sup>®</sup> Transmitter

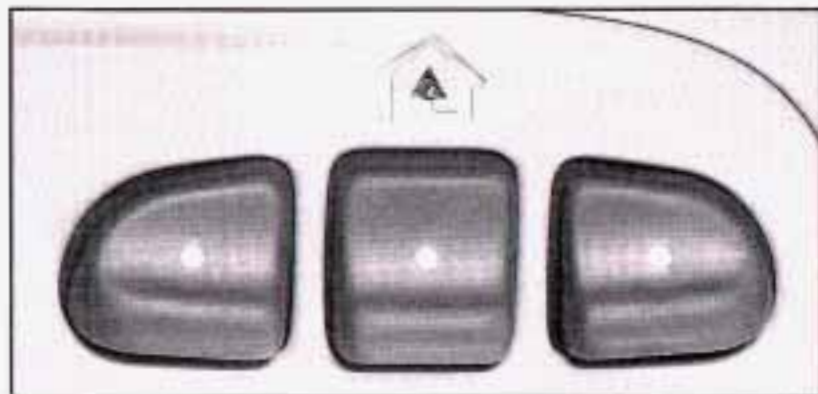

HomeLink<sup>®</sup>, a combined universal transmitter and receiver, provides a way to replace up to three hand-held transmitters used to activate devices such as gate operators, garage door openers, entry door locks, security systems and home lighting. Additional HomeLink<sup>®</sup> information can be found on the internet at [www.homelink.com](http://www.homelink.com) or by calling 1-800-355-3515.

If your vehicle is equipped with the HomeLink<sup>®</sup> Transmitter, it complies with Part 15 of the FCC Rules. Operation is subject to the following two conditions: (1) this device may not cause harmful interference, and (2) this device must accept any interference received, including interference that may cause undesired operation.

This device complies with RSS-210 of Industry Canada. Operation is subject to the following two conditions: (1) this device may not cause interference, and (2) this device must accept any interference received, including interference that may cause undesired operation of the device.

Changes and modifications to this system by other than an authorized service facility could void authorization to use this equipment.

## Programming the HomeLink<sup>®</sup> Transmitter

Do not use the HomeLink<sup>®</sup> Transmitter with any garage door opener that does not have the "stop and reverse" feature. This includes any garage door opener model manufactured before April 1, 1982.

Keep the original transmitter for use in other vehicles as well as for future HomeLink<sup>®</sup> programming. It is also recommended that upon the sale of the vehicle, the programmed HomeLink<sup>®</sup> buttons should be erased for security purposes. Refer to "Erasing HomeLink<sup>®</sup> Buttons" or, for assistance, contact HomeLink<sup>®</sup> on the internet at: [www.homelink.com](http://www.homelink.com) or by calling 1-800-355-3515.

Be sure that people and objects are clear of the garage door or gate operator you are programming. When programming a garage door, it is advised to park outside of the garage.

It is recommended that a new battery be installed in your hand-held transmitter for quicker and more accurate transmission of the radio frequency.

Your vehicle's engine should be turned off while programming the transmitter. Follow these steps to program up to three channels:

1. Press and hold down the two outside buttons, releasing only when the indicator light begins to flash, after 20 seconds. Do not hold down the

buttons for longer than 30 seconds and do not repeat this step to program a second and/or third transmitter to the remaining two HomeLink<sup>®</sup> buttons.

2. Position the end of your hand-held transmitter about 1 to 3 inches (3 to 8 cm) away from the HomeLink<sup>®</sup> buttons while keeping the indicator light in view.
3. Simultaneously press and hold both the desired button on HomeLink<sup>®</sup> and the hand-held transmitter button. Do not release the buttons until Step 4 has been completed.

Some entry gates and garage door openers may require you to substitute Step 3 with the procedure noted in "Gate Operator and Canadian Programming" later in this section.

4. The indicator light will flash slowly at first and then rapidly after HomeLink<sup>®</sup> successfully receives the frequency signal from the hand-held transmitter. Release both buttons.
5. Press and hold the newly-trained HomeLink<sup>®</sup> button and observe the indicator light.

If the indicator light stays on constantly, programming is complete and your device should activate when the HomeLink<sup>®</sup> button is pressed and released.

To program the remaining two HomeLink<sup>®</sup> buttons, begin with Step 2 under "Programming HomeLink<sup>®</sup> ." Do not repeat Step 1 as this will erase all of the programmed channels.

If the indicator light blinks rapidly for two seconds and then turns to a constant light, continue with Steps 6 through 8 following to complete the programming of a rolling-code equipped device (most commonly, a garage door opener).

6. At the garage door opener receiver (motor-head unit) in the garage, locate the "Learn" or "Smart" button. This can usually be found where the hanging antenna wire is attached to the motor-head unit.
7. Firmly press and release the "Learn" or "Smart" button. The name and color of the button may vary by manufacturer.

You will have 30 seconds to start Step 8.

8. Return to the vehicle. Firmly press and hold the programmed HomeLink<sup>®</sup> button for two seconds, then release. Repeat the press/hold/release sequence a second time, and depending on the brand of the garage door opener (or other rolling code device), repeat this sequence a third time to complete the programming. HomeLink<sup>®</sup> should now activate your rolling code equipped device.

To program the remaining two HomeLink<sup>®</sup> buttons, begin with Step 2 of "Programming HomeLink<sup>®</sup> ." Do not repeat Step 1.

## Gate Operator and Canadian Programming

Canadian radio-frequency laws require transmitter signals to "time out" or quit after several seconds of transmission. This may not be long enough for HomeLink<sup>®</sup> to pick up the signal during programming. Similarly, some U.S. gate operators are manufactured to "time out" in the same manner.

If you live in Canada, or you are having difficulty programming a gate operator by using the "Programming HomeLink<sup>®</sup> " procedures (regardless of where you live), replace Step 3 under "Programming HomeLink<sup>®</sup> " with the following:

Continue to press and hold the HomeLink<sup>®</sup> button while you press and release every two seconds (cycle) your hand-held transmitter until the frequency signal has been successfully accepted by HomeLink<sup>®</sup> . The indicator light will flash slowly at first and then rapidly. Proceed with Step 4 under "Programming HomeLink<sup>®</sup> " to complete.

## Using HomeLink®

Press and hold the appropriate HomeLink® button for at least half of a second. The indicator light will come on while the signal is being transmitted.

## Erasing HomeLink® Buttons

To erase programming from the three buttons do the following:

1. Press and hold down the two outside buttons until the indicator light begins to flash, after 20 seconds.
2. Release both buttons. Do not hold for longer than 30 seconds.

HomeLink® is now in the train (learning) mode and can be programmed at any time beginning with Step 2 under "Programming HomeLink®."

Individual buttons can not be erased, but they can be reprogrammed. See "Reprogramming a Single HomeLink® Button" next.

## Reprogramming a Single HomeLink® Button

To program a device to HomeLink® using a HomeLink® button previously trained, follow these steps:

1. Press and hold the desired HomeLink® button. Do not release the button.
2. The indicator light will begin to flash after 20 seconds. While still holding the HomeLink® button, proceed with Step 2 under "Programming HomeLink®."

## Resetting Defaults

To reset HomeLink® to default settings do the following:

1. Hold down the two outside buttons for about 20 seconds until the indicator light begins to flash.
2. Continue to hold both buttons until the HomeLink® indicator light turns off.
3. Release both buttons.

For questions or comments, contact HomeLink® at 1-800-355-3515, or on the internet at [www.homelink.com](http://www.homelink.com).

## Storage Areas

### Glove Box

To open your glove box, pull the handle on the front of the glove box and lower the door.

### Overhead Console



The overhead console includes sunglasses storage, a HomeLink® transmitter and a travel note recorder (if equipped). If your vehicle has a third row seat, the rear quarter glass switches are also located in the overhead console. These switches allow the driver to open and close each third row seat window separately.

### Sunglasses Storage Compartment

To open the sunglasses storage compartment in the overhead console, press the release button. Then pull the compartment down.

### Travel Note Recorder

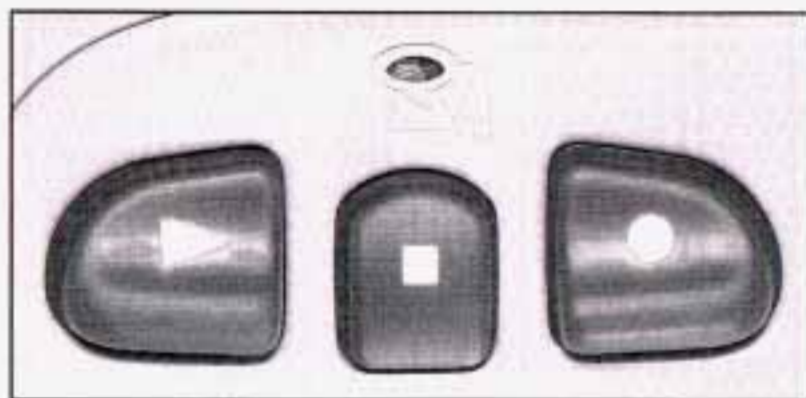

Your vehicle may have this feature.

To record a message, press the button with the circle on it and begin speaking. Press the button with the circle on it again to stop recording.

You may also press and hold the button with the circle on it while you are speaking and then let it go when you are finished.

To play back messages, press the button with the right arrow on it. Pressing the right arrow button more than once will return you to previously recorded

messages. If you press and hold this button for more than one second, all of the recorded messages will be played back.

To delete messages, press the button with the square on it while the message is playing. If you press and hold the right arrow button and the circle button at the same time for a half of a second, all of the messages will be deleted.

## Front Storage Area

If your vehicle has this console compartment, squeeze the front lever while lifting the top to open it. You can store cassettes and compact discs in the slots in front of the compartment.

Your vehicle's console will be equipped with cupholders located on the front and rear of the storage compartment.

The console may also contain one or more of the following components:

- Rear Seat Audio Controls
- Rear Seat Accessory Power Outlets
- Rear Climate Control

If your vehicle has the center armrest compartment, lift the cover to expose the storage area which includes slots for cassettes or compact discs.

## Rear Compartment Storage Panel/Cover



**Upper Position**

Your vehicle may have this feature.

Insert the front corners of the panel into the top guides and slide the panel forward. Press down on the back of the panel to lock it in place. This acts as a cargo shade.



**⚠ CAUTION:**

If you were to carry things on the adjustable shelf when it is in the upper (cargo cover) position, then during a sudden vehicle movement or a crash those things could be thrown around in the vehicle. You or others could be injured. When it is in the upper position, always secure any cargo on the floor beneath the shelf/cover.



**Lower Position**

Insert the front corners of the panel into the lower guides and slide the panel forward. Press down on the back of the panel to lock it in place. To prevent soiling the carpet, the panel may be installed either side up.

**Notice:** To help avoid damage, do not load objects over 200 lbs. (90 kg) in this position. Failure to follow this warning could damage the shelf.

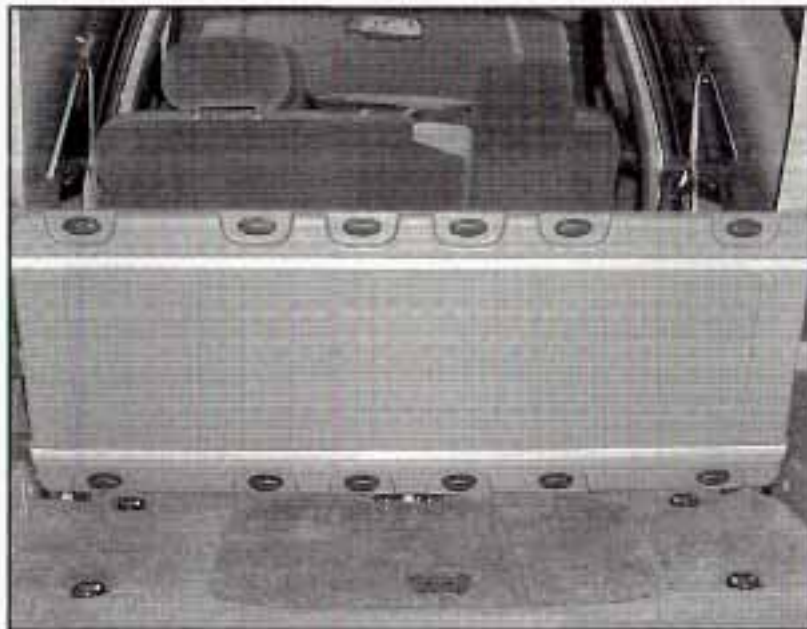

### Vertical Position

Insert the front corners of the panel into the vertical guides behind the seatbacks and slide the panel down. Plastic grocery bags can be attached to the hooks on the panel.

**Notice:** When in vertical position, the shelf panel should not be used as a barrier for large objects in the cargo area when the seatbacks are folded down.

## Table

Your vehicle may be equipped with a table. The maximum load for the table is 200 lbs. (90 kg).

To set up the table:

1. Remove the table from its stowed location in the rear of the vehicle.
2. Remove the cover.
3. Open the four legs on the underside of the table base. A leg is fully extended when the leg latch snaps into place.

Use the table base on level ground only.

To take down the table, do the following:

1. Press in the latch to disengage it from each leg. Completely fold each leg under the base.
2. Reinstall the cover.
3. Return the table to its stowed location.

## Luggage Carrier

### CAUTION:

If you try to carry something on top of your vehicle that is longer or wider than the luggage carrier — like paneling, plywood, a mattress and so forth — the wind can catch it as you drive along. This can cause you to lose control. What you are carrying could be violently torn off, and this could cause you or other drivers to have a collision, and of course damage your vehicle. You may be able to carry something like this inside. But, never carry something longer or wider than the luggage carrier on top of your vehicle.

A luggage carrier allows you to load things on top of your vehicle. The luggage carrier has side rails attached to the roof, sliding crossrails (if equipped) and places to use for tying things down. These let you load some other things on top of your vehicle, as long as they are not wide or longer than the luggage carrier.

To slide the crossrails to where you want them, pull up on the lever on each side of the crossrail. This will release the crossrail and allow you to slide it. When the crossrail is where you want it, press down on the levers to lock it into place.

**Notice:** Loading cargo that weighs more than 220 lbs. (100 kg) on the luggage carrier may damage your vehicle.

Don't exceed the maximum vehicle capacity when loading your vehicle. For more information on vehicle capacity and loading, see *Loading Your Vehicle on page 4-45*.

To prevent damage or loss of cargo as you're driving, check now and then to make sure the luggage carrier is locked and cargo is still securely fastened.

When the luggage carrier is not in use, place the crossrails at the following positions for wind noise reduction. Place one crossrail at the rear most point of the vehicle and the other crossrail above the opening of the rear door.

## Rear Floor Storage Lid

### CAUTION:

If any removable convenience item isn't secured properly, it can move around in a collision or sudden stop. People in the vehicle could be injured. Be sure to secure any such item properly.

Your vehicle has a rear floor storage lid located in the rear cargo area that allows you to put items underneath it.

To remove the rear floor storage lid, do the following:

1. Press the latch release and lift up the latch handle.
2. Raise the lid slightly to unhook it.
3. Pull the lid toward you to release it from the forward mounting tabs.

To reinstall the rear floor storage lid, reverse the previous steps. Make sure the lid is secure by applying slight pressure to the latch until you hear it click.

## Convenience Net

You may have a convenience net in the rear of your vehicle to help keep small items, like gloves and light clothing, in place during sharp turns or quick stops and starts.

The net is not designed to retain these items during off-road use. The net is not for larger, heavier items.

To use the convenience net, do the following:

1. Attach the upper loops to the retainers on either side of the liftgate opening. The label should be in the upper passenger's side corner, visible from the rear of the vehicle.
2. Attach the lower hooks to the rear cargo tie downs on the floor.

## Cargo Cover

If your vehicle has a cargo cover, you can use it to cover items in the cargo area of your vehicle.

To install the cargo cover, do the following:

1. Align the endcap with the pocket in the trim panel located behind the rear seat.
2. Compress the opposite endcap, align it with the pocket located on the opposite side of the trim panel and release.
3. Grasp the handle and unroll the cover. Latch the posts into the sockets on the inside of the vehicle to secure it.

To remove the cargo cover, do the following:

1. Release the cover from the latch posts and carefully roll it back up.
2. Compress one endcap and remove it from the pocket in the trim panel.
3. Remove the cargo cover from the other endcap so that you can remove the shade from the vehicle.

**⚠ CAUTION:**

An improperly stored cargo cover could be thrown about the vehicle during a collision or sudden maneuver. You or others could be injured. If you remove the cover, always store it in the proper storage location. When you put it back, always be sure that it is securely reattached.

## Cargo Tie Downs



There may be cargo tie downs in the rear of your vehicle that allow you to strap cargo in and keep it from moving.

## Sunroof

Your vehicle may be equipped with a power sliding sunroof. To open or close your sunroof, the ignition must be on or Retained Accessory Power (RAP) must be active.

Press and release the back of the button in the overhead console to open the sunroof. Press the front of the button to close the sunroof. Once the sunroof is closed, press the forward side of the button to open the sunroof to the vent position.

The sunroof is also equipped with a sunshade which you can pull forward to block sun rays.

# Vehicle Personalization

## Memory Seat



Your vehicle may have this feature. The controls are located on the driver's door, and are used to program and recall memory settings for the driver's seating and outside mirror positions.

Adjust the driver's seat (including the seatback recliner and lumbar) and both of the outside mirrors to the desired position. Then press and hold button 1 (for driver 1) for three seconds. A double chime will sound to let you know that the position has been stored.

A second mirror and seating position can be programmed by repeating the procedure with a second driver and pressing button 2 for three seconds. Each time button 1 or 2 is pressed and released while the vehicle is in PARK (P), a single chime will sound, and the memory position will be recalled.

If you use the unlock button on the remote keyless entry transmitter to enter your vehicle, the preset driver's seat and mirror positions will be recalled if programmed to do so through the Driver Information Center (DIC). The numbers on the back of the transmitters, 1 or 2, correspond to the numbers on the memory controls.

The seat and mirror positions can also be recalled by placing the key in the ignition if programmed to do so through the Driver Information Center (DIC).

To stop recall movement of the memory feature at any time, press one of the power seat controls or memory buttons.

Two personalized exit positions can be set by first recalling the driver's position (by pressing 1 or 2), then positioning the seat in the desired exit position for that driver. Press and hold the button with the exit symbol for three seconds. A double chime will sound to let you know that the position has been stored. With the vehicle in PARK (P), the exit position for that driver can be recalled by pressing the exit button. The mirrors, power lumbar and recline positions will not be stored or recalled for the exit positions. If no exit position is stored, the default is all the way rearward.

Further programming for automatic seat and mirror movement can be done through the Driver Information Center (DIC). You may choose to either select or not select the following:

- Automatic seat and mirror movement when the vehicle is unlocked with the remote keyless entry,
- automatic seat and mirror movement when a key is placed in the ignition, and
- automatic seat movement to the exit position when the vehicle is in PARK (P).





## Section 3 Instrument Panel

---

<b>Instrument Panel Overview</b> .....	3-4	Safety Belt Reminder Light .....	3-35
Hazard Warning Flashers .....	3-5	Air Bag Readiness Light .....	3-35
Other Warning Devices .....	3-6	Charging System Light .....	3-36
Horn .....	3-6	Voltmeter Gage .....	3-36
Tilt Wheel .....	3-6	Brake System Warning Light .....	3-37
Turn Signal/Multifunction Lever .....	3-7	Anti-Lock Brake System	
Exterior Lamps .....	3-13	Warning Light .....	3-38
Interior Lamps .....	3-16	Engine Coolant Temperature Gage .....	3-38
Accessory Power Outlets .....	3-18	Malfunction Indicator Lamp .....	3-39
Ashtrays and Cigarette Lighter .....	3-18	Oil Pressure Gage .....	3-41
<b>Climate Controls</b> .....	3-19	Change Engine Oil Light .....	3-42
Dual Climate Control System .....	3-19	Security Light .....	3-42
Dual Automatic Climate Control System .....	3-22	Cruise Control Light .....	3-43
Rear Climate Control System .....	3-27	Reduced Engine Power Light .....	3-43
Steering Wheel Climate Controls .....	3-31	Service Four-Wheel Drive	
Climate Controls Personalization .....	3-31	Warning Light .....	3-44
<b>Warning Lights, Gages and Indicators</b> .....	3-32	Check Gages Warning Light .....	3-44
Instrument Panel Cluster .....	3-33	Gate Ajar Light .....	3-44
Speedometer and Odometer .....	3-34	Fuel Gage .....	3-45
Tachometer .....	3-34	Low Fuel Warning Light .....	3-45

## Section 3 Instrument Panel

---

<b>Driver Information Center (DIC)</b> .....	3-46	<b>Theft-Deterrent Feature</b>	
DIC Operation and Displays .....	3-46	(RDS Radios) .....	3-94
DIC Warnings and Messages .....	3-54	<b>Audio Steering Wheel Controls</b> .....	3-95
<b>Audio System(s)</b> .....	3-58	<b>DVD Distortion</b> .....	3-95
Setting the Time .....	3-58	<b>Understanding Radio Reception</b> .....	3-95
Radio with CD .....	3-59	<b>Care of Your Cassette Tape Player</b> .....	3-96
Radio with Cassette and CD .....	3-65	<b>Care of Your CDs and DVDs</b> .....	3-97
Radio with Six-Disc CD .....	3-74	<b>Care of Your CD and DVD Player</b> .....	3-97
Rear Seat Entertainment System .....	3-83	<b>Cleaning the Video Screen</b> .....	3-97
Rear Seat Audio (RSA) .....	3-93	<b>Fixed Mast Antenna</b> .....	3-97
Radio Personalization .....	3-94	<b>Chime Level Adjustment</b> .....	3-97



## Instrument Panel Overview

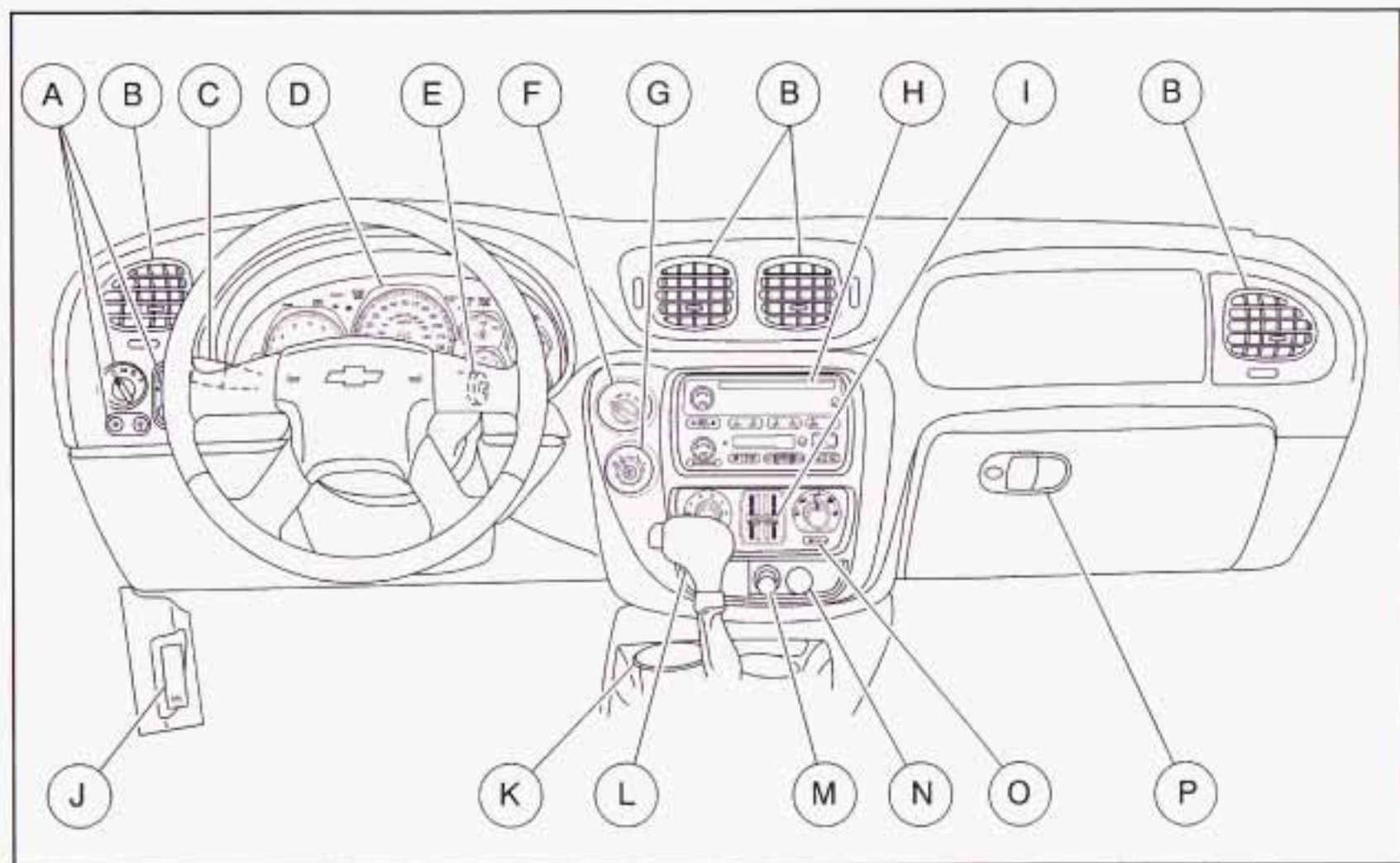

The main components of your instrument panel are the following:

- A. Exterior Lamp Controls
- B. Air Outlets
- C. Turn Signal/Multifunction Lever
- D. Instrument Panel Cluster
- E. Ignition Switch
- F. Transfer Case Controls or Traction Control Button
- G. Rear Window Washer/Wiper
- H. Audio System
  - I. Climate Controls
- J. Hood Release
- K. Ashtray
- L. Shift Lever
- M. Lighter
- N. Accessory Power Outlet
- O. Rear Window Defogger
- P. Glove Box

## Hazard Warning Flashers

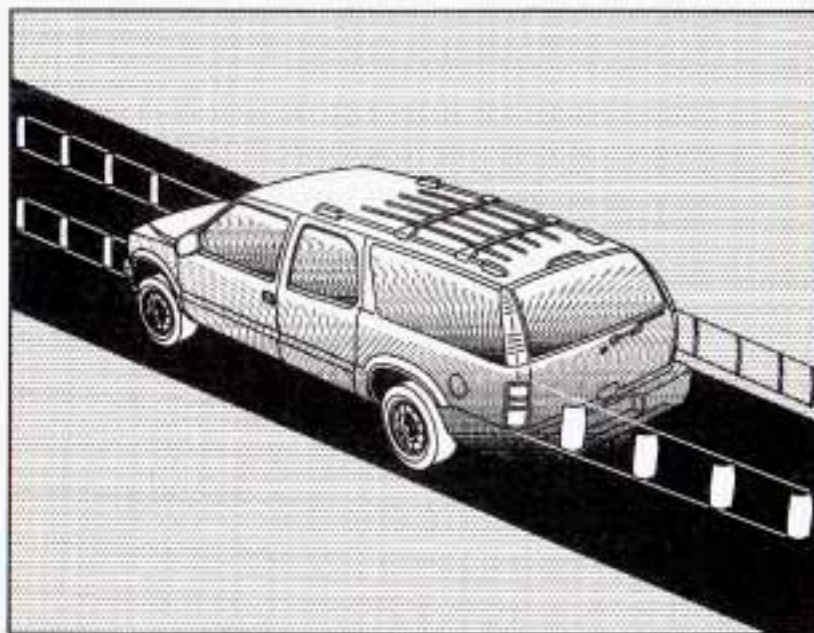

Your hazard warning flashers let you warn others. They also let police know you have a problem. Your front and rear turn signal lamps will flash on and off.



The button for the hazard warning flashers is located on top of the steering column.

The hazard warning flashers work no matter what position your key is in, and even if the key isn't in.

Press the button all the way down to make your front and rear turn signal lamps flash on and off. To turn off the flashers, press the button again until it clicks and then release it.

When the hazard warning flashers are on, the turn signals won't work.

## Other Warning Devices

If you carry reflective triangles, you can set one up at the side of the road about 300 feet (100 m) behind your vehicle.

## Horn

To sound the horn, press the horn symbols on the steering wheel pad.

## Tilt Wheel



You should adjust the steering wheel before you drive. The tilt lever is located on the driver's side of the steering column, under the turn signal lever.

You can raise it to the highest level to give your legs more room when you enter and exit the vehicle.

To tilt the wheel, hold the steering wheel and pull the lever toward you. Move the steering wheel to a comfortable level, then release the lever to lock the wheel in place.

Do not adjust the steering wheel while driving.

## Turn Signal/Multifunction Lever

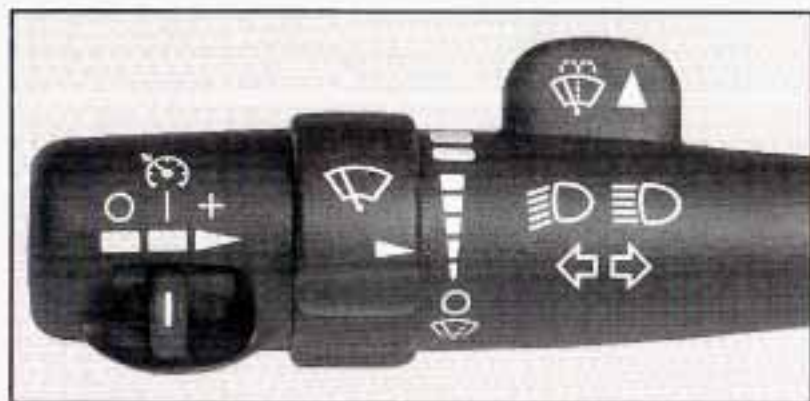

The lever on the left side of the steering column includes the following:

-  : Turn and Lane Change Signals
-  : Headlamp High/Low-Beam Changer
- Flash-to-Pass Feature
-  : Windshield Wipers
-  : Windshield Washer
-  : Cruise Control (If Equipped)

## Turn and Lane Change Signals

The turn signal has two upward (for right) and two downward (for left) positions. These positions allow you to signal a turn or a lane change.

To signal a turn, move the lever all the way up or down. When the turn is finished, the lever will return automatically.

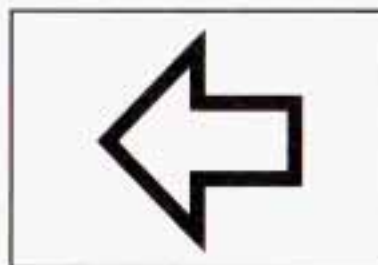

An arrow on the instrument panel cluster will flash in the direction of the turn or lane change.

To signal a lane change, just raise or lower the lever until the arrow starts to flash. Hold it there until you complete your lane change. The lever will return by itself when you release it. The bottom of the outside rearview mirrors may also be equipped with lane change indicators.

As you signal a turn or a lane change, if the arrows flash more quickly than normal, a signal bulb may be burned out and other drivers won't see your turn signal.



If a bulb is burned out, replace it to help avoid an accident. If the arrows don't go on at all when you signal a turn, check the fuse. See *Fuses and Circuit Breakers* on page 5-85 and check for burned-out bulbs.

If you have a trailer towing option with added wiring for the trailer lamps, a different turn signal flasher is used. With this flasher installed, the signal indicator will flash even if a turn signal bulb is burned out. Check the front and rear turn signal lamps regularly to make sure they are working.

## Turn Signal On Chime

If your turn signal is left on for more than 3/4 of a mile (1.2 km), a chime will sound at each flash of the turn signal. To turn off the chime, move the turn signal lever to the off position.

## Headlamp High/Low-Beam Changer

To change the headlamps from low to high beam, push the lever toward the instrument panel. To return to low-beam headlamps, pull the multifunction lever toward you. Then release it.



When the high beams are on, this indicator light on the instrument panel cluster will also be on.

## Flash-to-Pass

This feature lets you use your high-beam headlamps to signal a driver in front of you that you want to pass. It works even if your headlamps are in the automatic position.

To use it, pull the turn signal lever toward you, then release it.

If your headlamps are in the automatic position or on low beam, your high-beam headlamps will turn on. They'll stay on as long as you hold the lever toward you. The high-beam indicator on the instrument panel cluster will come on. Release the lever to return to normal operation.

## Windshield Wipers

 **(Mist):** For a single wiping cycle, turn the band to mist. Hold it there until the wipers start. Then let go. The wipers will stop after one wipe. If you want more wipes, hold the band on mist longer.

 **(Off):** To stop the wipers, move the band to off.

 **(Windshield Wipers):** Turn the band to control the windshield wipers.

You can set the wiper speed for a long or short delay between wipes. This can be very useful in light rain or snow. Turn the band to choose the delay time. The closer to the top of the lever, the shorter the delay.

For steady wiping at low speed, turn the band away from you to the first solid band past the delay settings. For high-speed wiping, turn the band further, to the second solid band past the delay settings. To stop the wipers, move the band to off.

Be sure to clear ice and snow from the wiper blades before using them. If they're frozen to the windshield, carefully loosen or thaw them. If your blades do become worn or damaged, get new blades or blade inserts.

## Rainsense™ Wipers

Your vehicle may be equipped with Rainsense™ windshield wipers. When active, these wipers are able to detect moisture on the windshield and automatically turn on the wipers.

The moisture sensor is located next to the inside rearview mirror and is mounted on the windshield.

To turn on the Rainsense™ feature, the wipers must be set to one of the five delay settings on the multifunction lever. Each of the five settings adjusts the sensitivity

of the rainsensor. For more wipes, select the higher settings; for fewer wipes, select the lower settings located closer to off on the multifunction lever.

The rainsensor will automatically control the frequency of the wipes from off to high speed according to the weather conditions. The wipers can be left in a rainsense mode even when it is not raining.

**Notice:** Turn the windshield wiper band on the multifunction lever to off to avoid wiper damage when going through an automatic car wash.

## Windshield Washer

 **(Windshield Washer):** To spray washer fluid on the windshield, press the windshield washer paddle. The wipers will clear the window and then either stop or return to your preset speed.

### CAUTION:

**In freezing weather, don't use your washer until the windshield is warmed. Otherwise the washer fluid can form ice on the windshield, blocking your vision.**

## Rear Window Washer/Wiper



This control is located to the right of the steering wheel on the instrument panel.

To turn the rear wiper on, turn the control to either 1, 2, or 3. For delayed wiping, turn the control to 1 or 2. For steady wiping, turn the control to 3. To turn the wiper off, turn the control to 0.

To wash the rear window, press the washer symbol located in the center of the control.

The rear window washer uses the same fluid bottle as the windshield washer. However, the rear window washer will run out of fluid before the windshield washer. If you can wash your windshield but not your rear window, check the fluid level.

## Cruise Control



**| (On):** Move the switch to this position to turn the cruise control system on.

**+ (Resume/Accelerate):** Move the switch to this position to resume a set speed or to accelerate.

**Ⓢ (Set):** Press this button, located at the end of the lever, to set a speed.

 **(Off):** This position turns the cruise control system off and cancels memory of a set speed.

With cruise control, you can maintain a speed of about 25 mph (40 km/h) or more without keeping your foot on the accelerator. This can really help on long trips. Cruise control does not work at speeds below about 25 mph (40 km/h).

If you apply your brakes, the cruise control will shut off.

### **CAUTION:**

- **Cruise control can be dangerous where you can't drive safely at a steady speed. So, don't use your cruise control on winding roads or in heavy traffic.**
- **Cruise control can be dangerous on slippery roads. On such roads, fast changes in tire traction can cause needless wheel spinning, and you could lose control. Don't use cruise control on slippery roads.**

### **CAUTION:**

**If you leave your cruise control on when you're not using cruise, you might hit a button and go into cruise when you don't want to. You could be startled and even lose control. Keep the cruise control switch off until you want to use cruise control.**

## Setting Cruise Control

1. Move the cruise control switch to on.
2. Get up to the speed you want.
3. Press in the set button at the end of the lever and release it.
4. Take your foot off the accelerator pedal. The accelerator pedal will not go down.

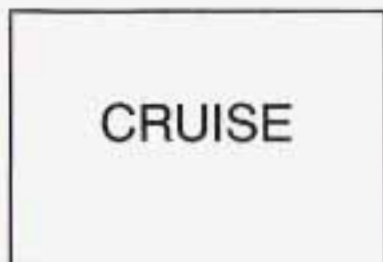

**United States**



**Canada**

The CRUISE light on the instrument panel cluster will come on when the cruise control is engaged.

## Resuming a Set Speed

Suppose you set your cruise control at a desired speed and then you apply the brake. This, of course, shuts off the cruise control. But you don't need to reset it.

Once you're going about 25 mph (40 km/h) or more, you can move the cruise control switch briefly from on to resume/accelerate.

You'll go right back up to your chosen speed and stay there.

If you hold the switch at resume/accelerate, the vehicle will keep going faster until you release the switch or apply the brake. So unless you want to go faster, don't hold the switch at resume/accelerate.

## Increasing Speed While Using Cruise Control

There are two ways to go to a higher speed:

- Use the accelerator pedal to get to the higher speed. Press the button at the end of the lever, then release the button and the accelerator pedal. You'll now cruise at the higher speed.
- Move the cruise switch from on to resume/accelerate. Hold it there until you get up to the speed you want, and then release the switch. To increase your speed in very small amounts, move the switch briefly to resume/accelerate. Each time you do this, your vehicle will go about 1 mph (1.6 km/h) faster.

## Reducing Speed While Using Cruise Control

- Press in the set button at the end of the lever until you reach the lower speed you want, then release it.
- To slow down in very small amounts, briefly press the set button. Each time you do this, you'll go about 1 mph (1.6 km/h) slower.

## Passing Another Vehicle While Using Cruise Control

Use the accelerator pedal to increase your speed. When you take your foot off the pedal, your vehicle will slow down to the cruise control speed you set earlier.

## Using Cruise Control on Hills

How well your cruise control will work on hills depends upon your speed, load and the steepness of the hills. When going up steep hills, you may want to step on the accelerator pedal to maintain your speed. When going downhill, you may have to brake or shift to a lower gear to keep your speed down. Of course, applying the brake takes you out of cruise control. Many drivers find this to be too much trouble and don't use cruise control on steep hills.

## Ending Cruise Control

There are three ways to turn off the cruise control:

- Step lightly on the brake pedal.
- Move the cruise switch to off, or
- Shift the transmission to NEUTRAL (N).

## Erasing Speed Memory

When you turn off the cruise control or the ignition, your cruise control set speed memory is erased.

## Exterior Lamps



Your exterior lamps knob is located on your instrument panel to the left of the steering wheel.

**/ (Off):** Turn the knob to this symbol and release it to turn off the Daytime Running Lamps (DRL) and the automatic headlamps. An indicator will illuminate when the position is selected.

**☰ (Automatic DRL/AHL):** Turning the knob to this symbol puts the system into automatic headlamp mode. An indicator will illuminate when the position is selected.

 **(Parking Lamps):** Turn the knob to this symbol to manually turn on the following:

- Parking Lamps
- Sidemarker Lamps
- Taillamps
- License Plate Lamps
- Instrument Panel Lights

 **(Headlamps):** Turn the knob to this symbol to turn on all the lamps listed as well as the headlamps.

## Automatic Headlamp System

When it is dark enough outside, your automatic headlamp system will turn on your headlamps at the normal brightness along with other lamps such as the taillamps, sidemarker, parking lamps and the instrument panel lights. The radio lights will also be on.

Your vehicle is equipped with a light sensor on the top of the instrument panel. Be sure it is not covered or the system will be on whenever the ignition is on.

The system may also turn on your lights when driving through a parking garage, heavy overcast weather or a tunnel. This is normal.

There is a delay in the transition between the daytime and nighttime operation of the Daytime Running Lamps (DRL) and the automatic headlamp systems,

so that driving under bridges or bright overhead street lights does not affect the system. The DRL and automatic headlamp system will only be affected when the light sensor sees a change in lighting lasting longer than the delay.

If you start your vehicle in a dark garage, the automatic headlamp system will come on immediately. Once you leave the garage, it will take approximately one minute for the automatic headlamp system to change to DRL if it is light outside. During that delay, your instrument panel cluster may not be as bright as usual. Make sure your instrument panel brightness control is in the full bright position.

To idle your vehicle with the automatic headlamp system off, set the parking brake while the ignition is off. Then start your vehicle. The automatic headlamp system will stay off until you release the parking brake, shift out of park or turn the exterior lamp control to the off position as described in "Exterior Lamps".

## Lamps On Reminder

A reminder tone will sound when your headlamps or parking lamps are manually turned on, the driver's door is open and your ignition is in LOCK or ACCESSORY. To turn the tone off, turn the knob all the way counterclockwise. In the automatic mode, the headlamps turn off once the ignition key is in LOCK.

## Daytime Running Lamps

Daytime Running Lamps (DRL) can make it easier for others to see the front of your vehicle during the day. DRL can be helpful in many different driving conditions, but they can be especially helpful in the short periods after dawn and before sunset. Fully functional daytime running lamps are required on all vehicles first sold in Canada.

The DRL system will make your headlamps come on at reduced brightness when the following conditions are met:

- The ignition is on,
- the exterior lamps knob is in automatic headlamp mode,
- the light sensor detects daytime light, and
- the transmission is not in PARK (P).

When the DRL are on, only your headlamps will be on. The taillamps, sidemarker and other lamps won't be on. The instrument panel won't be lit up either.

When it begins to get dark, the headlamps will automatically switch from DRL to the regular headlamps.

## Fog Lamps

Your vehicle may have this feature. Use your fog lamps for better vision in foggy or misty conditions. Your ignition must be in RUN for your fog lamps to work.



The fog lamp button is located on the instrument panel to the right of the exterior lamps knob.

Press the button to turn the fog lamps on. Press the button again to turn them off. A light will glow near the button when the fog lamps are on. Fog lamps will turn off whenever your high-beam headlamps are on.



## Interior Lamps

### Instrument Panel Brightness



Press the knob located next to the exterior lamps knob to extend it. Adjust the instrument panel lights. Turn the knob all the way up to turn on the interior lamps. Press the knob back into its stored position when you're not using it.

## Dome Lamp Override



The dome override button is located below the exterior lamps knob.

To turn the dome lamps off, press the button. The dome lamps will remain off when a door is open. This will override the illuminated entry feature unless you use your keyless entry transmitter to unlock the vehicle. To return the lamps to automatic operation, press the button again. The dome lamps will come on when you open a door.

### Entry Lighting

Your vehicle is equipped with an illuminated entry feature.

When a door is opened, the dome lamps will come on if the dome override button is in the "out" position. When all the doors are closed, the lamps will stay on for a short period of time and will then turn off automatically.

If you use your keyless entry transmitter to unlock the vehicle, the interior lights will come on for a short time whether or not the dome override is on.

## Exit Lighting

With exit lighting, the interior lamps will come on when you remove the key from the ignition to help you see while exiting the vehicle. With the dome override button in the "out" position, these lights will stay on for a short period of time and then will go out.

## Reading Lamps

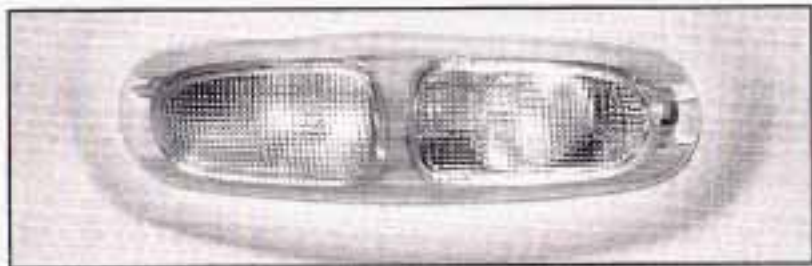

Press the lens on the lamp located above the doors to turn the reading lamps on and off.

## Dome Lamps

The dome lamps will come on when you open a door unless the dome lamp override is pressed in.

You can also turn the dome lamps on by turning the thumbwheel, located next to the exterior lamps knob, all the way up to the top detent position. In this position, the dome lamps will remain on until they are turned off.

## Battery Run-Down Protection

This feature shuts off the dome, courtesy, vanity, and reading lamps if they are left on for more than 20 minutes when the ignition is off. This will keep your battery from running down.

If the battery run-down protection shuts off the interior lamps, it may be necessary to do one of the following to return to normal operation:

- Shut off all lamps and close all doors, or
- turn the ignition key to RUN.

This feature will also turn off the parking lamps and headlamps under most circumstances, if they are left on. If you would like to turn them back on, turn the exterior lamps knob.

## Accessory Power Outlets

Your vehicle may have accessory power outlets. With the accessory power outlets, you can plug in auxiliary electrical equipment such as a cellular telephone or CB radio.

The first outlet is located to the right of the cigarette lighter on the instrument panel. The second outlet is located on the rear of the center console.

Remove the cover from the outlet to use the outlet. Be sure to put the cover back on when not using the accessory power outlet.

Certain electrical accessories may not be compatible with the accessory power outlet and could result in blown vehicle or adaptor fuses. If you experience a problem, see your dealer for additional information on the accessory power outlets.

**Notice:** Adding some electrical equipment to your vehicle can damage it or keep other things from working as they should. This wouldn't be covered by your warranty. Check with your dealer before adding electrical equipment, and never use anything that exceeds the amperage rating.

When adding electrical equipment, be sure to follow the proper installation instructions included with the equipment.

**Notice:** Power outlets are designed for accessory plugs only. Do not hang any type of accessory or accessory bracket from the plug. Improper use of the power outlet can cause damage not covered by your warranty.

## Ashtrays and Cigarette Lighter

Your vehicle may have this feature. The front ashtray is removable and fits into the front cupholder.

**Notice:** Don't put papers or other flammable items into your ashtrays. Hot cigarettes or other smoking materials could ignite them, causing a damaging fire.

To remove the front ashtray, pull the covered bin out of the cupholder.

To use the lighter, press it in all the way, and let go. When it's ready, it will pop back out by itself.

**Notice:** Don't hold a cigarette lighter in with your hand while it is heating. If you do, it won't be able to back away from the heating element when it's ready. That can make it overheat, damaging the lighter and the heating element.

# Climate Controls

## Dual Climate Control System

With this system you can control the heating, cooling and ventilation for your vehicle.



**(Fan):** Turn the left knob clockwise or counterclockwise to increase or decrease the fan speed. If the knob is in off outside air will still enter the vehicle, and will be directed based on the position of the mode knob. The temperature can still be adjusted using the temperature knob.

Turn the right knob clockwise or counterclockwise to direct the airflow inside of your vehicle.

To change the current mode, select one of the following:

**(Vent):** This mode directs air to the instrument panel outlets.

**(Bi-Level):** This mode directs about half of the air to the instrument panel outlets; then directs most of the remaining air to the floor outlets. A little air is directed toward the windshield and the side window outlets. Cooler air is directed to the upper vents and warmer air to the floor outlets.

**(Floor):** This mode directs most of the air to the floor outlets with a little air directed to the windshield and the side window outlets. The recirculation button cannot be selected while in floor mode.

**(Recirculation):** Recirculation mode is used to recirculate the air inside of your vehicle. When this button is pressed, an indicator light in the button will come on to let you know that it is active. Use this mode to help prevent outside odors and/or dust from entering your vehicle or to help cool the air inside of your vehicle more quickly. The air conditioning compressor will also come on when this mode is activated. While in recirculation mode, the windows may fog when the weather is cold and damp. To clear the fog, select either the blend or defrost mode and increase fan speed. Recirculation mode shuts off when the engine is turned off.

## Temperature Control

**Driver's Side:** The lever on the left side of the climate control panel is used to raise or lower the temperature on the driver's side of the vehicle. Slide the lever up or down to adjust the temperature.

**Passenger's Side:** The lever on the right side of the climate control panel is used to raise or lower the temperature on the passenger's side of the vehicle. Slide the lever up or down to adjust the temperature. This lever also adjusts the temperature to the rear seat outlets.

When the temperature outside is 0°F (-18°C) or lower, use the engine coolant heater, if equipped, to provide warmer faster to your vehicle.

 **(Air Conditioning):** Press this button to turn the air-conditioning system on or off. When the button is pressed, an indicator light will come on and the system will begin to cool and dehumidify the air inside of your vehicle. You may notice a slight change in engine performance when the air conditioning compressor shuts off and turns on again. This is normal.

## Defogging and Defrosting

Fog on the inside of windows is a result of high humidity (moisture) condensing on the cool window glass. This can be minimized if the climate control system is used properly. There are two modes to choose from to clear fog or frost from your windshield. Use the defog mode to clear the windows of fog or moisture and warm the passengers. Use the defrost mode to remove fog or frost from the windshield more quickly.

Turn the right knob clockwise or counterclockwise to select one of the following modes:

 **(Defog):** This mode directs the air to the floor outlets, windshield and side window outlets. The recirculation button cannot be selected while in defog mode.

 **(Defrost):** This mode directs most of the air to the windshield and the side window outlets, with only a little air directed to the floor outlets. The air conditioning compressor may run to dehumidify the air to prevent window fogging. The recirculation button cannot be selected while in defrost mode. Do not drive the vehicle until all the windows are clear.

## Rear Window Defogger

The lines you see on the rear window warm the glass.



Press this button to turn the rear window defogger on or off. An indicator light in the button will come on to let you know that the rear window defogger is active. The rear window defogger will automatically turn off approximately ten minutes after the button is pressed.

If your vehicle is equipped with heated mirrors, this button will activate them.

**Notice:** Don't use anything sharp on the inside of the rear window. If you do, you could cut or damage the warming grid, and the repairs wouldn't be covered by your warranty. Do not attach a temporary vehicle license, tape, a decal or anything similar to the defogger grid.

## Outlet Adjustment

Use the air outlets located in the center and on the side of your instrument panel to direct the airflow.

## Ventilation System

For mild outside temperatures when little heating or cooling is needed, use the vent setting to direct outside air through your vehicle.

Your vehicle's ventilation system supplies outside air to the inside of your vehicle when it is moving. With the side windows closed, air will flow into the front air inlet grilles, through the vehicle and out the air exhaust valves.

Outside air will also enter the vehicle when the heater or the air conditioning is running, unless you have selected recirculation mode.

## Operation Tips

- Keep the hood and front air inlets free of ice, snow, or any other obstruction (such as leaves). The heater and defroster will work far better, reducing the chance of fogging the inside of your windows.
- When you enter a vehicle in cold weather, turn the fan knob all the way to the right for a few moments before driving. This helps clear the intake ducts of snow and moisture, and reduces the chance of fogging the inside of your window.
- Keep the air path under the front seats clear of objects. This helps air to circulate throughout your vehicle.
- Adding outside equipment to the front of your vehicle, such as hood-air deflectors, may affect the performance of the heating and air conditioning system. Check with your dealer before adding equipment to the outside of your vehicle.

## Dual Automatic Climate Control System

Your vehicle may have the optional dual automatic climate control system. With this system you can control the heating, cooling and ventilation for your vehicle.



When your vehicle is first started, the display will show the driver's temperature setting and air delivery mode for five seconds. Then it will show the outside temperature.

**(Off):** Press this button to turn off the entire climate control system. Outside air will still enter the vehicle, and will be directed to the floor. Press the AUTO button, the mode button, the fan arrows, or either temperature knob to turn the system on.

 **(Mode):** Press this button to manually select the air delivery mode to the floor, instrument panel, or windshield outlets. The system will stay in the selected mode until the mode button is pressed again or the AUTO button is pressed.

**Driver's Side Temperature Knob:** Turn this knob clockwise or counterclockwise to manually raise or lower the temperature on the driver's side of the vehicle. The display will show the temperature setting decreasing or increasing and the word "DRIVER" will light up. This knob can also adjust the passenger's side temperature setting simultaneously if the two zones are linked. The words "DRIVER and PASS" will then light up.

**Passenger's Side Temperature Knob:** Turn this knob clockwise or counterclockwise to manually raise or lower the temperature on the passenger's side of the vehicle. The display will show the temperature setting decreasing or increasing and the word "PASS" will light up. The passenger's temperature setting can be set to match and link to the driver's temperature setting by pressing and holding the AUTO button for three seconds. By adjusting the driver's side temperature setting, the passenger's side temperature setting will follow and both "DRIVER and PASS" will be displayed. The passenger's side temperature setting also resets and relinks to the driver's side temperature setting if the vehicle has been off for more than two hours.

## Automatic Operation

**AUTO (Automatic):** When automatic operation is active, the system will control the inside temperature, the air delivery mode, and the fan speed.

Use the steps below to place the entire system in automatic mode:

1. Press the AUTO button.

When AUTO is selected, the air conditioning operation and air inlet will be automatically controlled. The air conditioning compressor will run when the outside temperature is over approximately 40°F (4°C). The air inlet will normally be set to outside air. If it's hot outside, the air inlet will automatically switch to recirculate inside air to help quickly cool down your vehicle.

2. Set the driver's and passenger's temperature.

To find your comfort setting, start with a 72°F (22°C) temperature setting and allow about 20 minutes for the system to regulate. Turn the driver's or passenger's side temperature knob to adjust the temperature setting as necessary. If you choose the temperature setting of 60°F (15°C), the system will remain at the maximum cooling setting. If you choose the temperature setting of 90°F (32°C), the system will remain at the maximum heat setting. Choosing either maximum setting may not cause the vehicle to heat or cool any faster.





## Manual Operation

To change the current setting, select one of the following:

 **(Fan):** This button allows you to manually adjust the fan speed. Press the up arrow to increase fan speed and the down arrow to decrease fan speed. The display will change to show you the selected fan speed and the driver's side temperature setting for five seconds.

 **(Mode):** Press this button to manually change the direction of the airflow in your vehicle. Keep pressing the button until the desired mode appears on the display. The display will change to show you the selected air delivery mode and the driver's temperature setting for five seconds.

 **(Vent):** This mode directs air to the instrument panel outlets.

 **(Bi-Level):** This mode directs approximately half of the air to the instrument panel outlets, then directs the remaining air to the floor outlets. A little air is directed toward the windshield and the side window outlets. Cooler air is directed to the upper outlets and warmer air to the floor outlets.

 **(Floor):** This mode directs most of the air to the floor outlets. Some air also comes out of the defroster

and side window outlets. The recirculation button cannot be selected in floor mode.

 **(Recirculation):** Press this button to turn recirculation mode on or off. When this button is pressed, an indicator light in the button will also come on to let you know that it is activated. Recirculation mode is used to recirculate the air inside of your vehicle. Use this mode to help prevent outside odors and/or dust from entering your vehicle or to help cool the air inside of your vehicle more quickly. Recirculation mode can be used with vent and bi-level modes, but it cannot be used with floor, defog or defrost modes.

If the weather is cold and damp, the system may cause the windows to fog while using recirculation mode. If the windows do start to fog, select defog or defrost mode.

 **A/C (Air Conditioning):** Press this button to manually turn the air conditioning system on or off. When the system is on, the system will automatically begin to cool and dehumidify the air inside of your vehicle.

If you select air conditioning off while in front defrost or defog mode, the air conditioning off symbol will flash to let you know this is not allowed.

You may notice a slight change in engine performance when the air-conditioning compressor shuts off and turns on again. This is normal.

 **(Air Conditioning Off):** When you turn the air conditioning off, this symbol will appear on the display. When the air conditioning is selected or in AUTO mode, the system will run the air conditioning automatically.

## Defogging and Defrosting

Fog on the inside of windows is a result of high humidity (moisture) condensing on the cool window glass. This can be minimized if the climate control system is used properly. You can use either defog or front defrost to clear fog or frost from your windshield.

 **(Defog):** Use this setting to clear the windows of fog or moisture. This setting will deliver air to the floor and windshield outlets.

 **(Front Defrost):** Press the front defrost button to defrost the windshield. The system will automatically control the fan speed if you select defrost from AUTO mode. If the outside temperature is 40°F (4°C) or warmer, your air conditioning compressor will automatically run to help dehumidify the air and dry the windshield. Do not drive the vehicle until all the windows are clear.

## Rear Window Defogger

The rear window defogger uses a warming grid to remove fog from the rear window.



Press this button to turn the rear window defogger on or off.

An indicator light in the button will come on to let you know that the rear window defogger is activated.

The rear window defogger will turn off approximately 10 minutes after the button is pressed. If you need additional warming time, press the button again.

**Notice:** Don't use a razor blade or something else sharp on the inside of the rear window. If you do, you could cut or damage the defogger and the repairs would not be covered by your warranty. Do not attach a temporary vehicle license, tape, a decal or anything similar to the defogger grid.

Do not attach a temporary vehicle license, tape, a decal or anything similar to the defogger grid.

## Outlet Adjustment

Use the air outlets located in the center and on the side of your instrument panel to direct the airflow.

## Ventilation System

For mild outside temperatures when little heating or cooling is needed, use the vent setting to direct outside air through your vehicle.

Your vehicle's ventilation system supplies outside air to the inside of your vehicle when it is moving. With the side windows closed, air will flow into the front air inlet grilles, through the vehicle and out the air exhaust valves.

Outside air will also enter the vehicle when the heater or the air conditioning compressor is running, unless you have the recirculation button pushed in.

## Operation Tips

- Keep the hood and front air inlets free of ice, snow, or any other obstruction (such as leaves). The heater and defroster will work far better, reducing the chance of fogging the inside of your windows.
- When you enter a vehicle in cold weather, turn the fan knob all the way to the right for a few moments before driving. This helps clear the intake ducts of snow and moisture, and reduces the chance of fogging the inside of your window.
- Keep the air path under the front seats clear of objects. This helps air to circulate throughout your vehicle.
- Adding outside equipment to the front of your vehicle, such as hood-air deflectors, may affect the performance of the heating and air conditioning system. Check with your dealer before adding equipment to the outside of your vehicle.

## Rear Climate Control System

Your vehicle has one of the following rear comfort control systems. With either system, the rear comfort controls will be disabled when the front comfort control system is in defrost. This occurs to provide maximum airflow to clear the windshield.



**TrailBlazer**

The temperature of the air coming through the rear outlets is determined by the front passenger's temperature setting. Press the PWR button to turn the rear comfort controls on and off. Use the mode knob to change the direction of airflow (upper, bi-level or floor) to the rear seat area.



**TrailBlazer**

If your vehicle has the rear seat audio system, the lower buttons are used to adjust the rear seat comfort controls. The temperature of the air coming through the rear outlets is determined by the front passenger's temperature setting. The button with the up and down arrows on it regulates the fan speed. The mode button can be used to change the direction of airflow (upper, bi-level or floor) to the rear seat area. To turn the rear comfort controls off, press the lower PWR button.

## Outlet Adjustment



Your vehicle may have rear seat outlets that can be used to adjust the airflow toward either seating area, the floor or upward. Move the control in the center of each outlet in any direction to direct airflow.

## TrailBlazer EXT

To operate the rear air conditioning system, the front air conditioning system must be on. With the front air conditioning system off, the rear system controls can only be used to circulate air in the rear of the vehicle.

To adjust the airflow speed, turn the fan knob (driver override switch), located on the floor console to 1, 2 or 3. The rear mode and temperature position will now mimic the front control system mode and passenger side temperature.

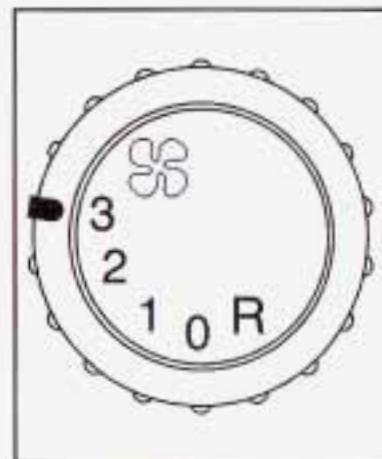



TrailBlazer EXT

 **(Panel):** When panel mode is selected in the front controller, the rear system will distribute air from the four headliner outlets.

 **(Bi-level):** When bi-level mode is selected in the front controller, the rear system will distribute air from the four headliner outlets and the third seat floor outlet.

 **(Floor):** When floor mode is selected in the front controller, the rear system will distribute air from the third seat floor outlet.

 **(Defog):** When defog mode is selected in the front controller, the rear system will distribute air from the third seat floor outlet.

 **(Defrost):** When defrost mode is selected in the front controller, the rear system will distribute air from the third seat floor outlet.

To activate the second row seat controls in the following systems, set the fan knob, located on the front console, to R.

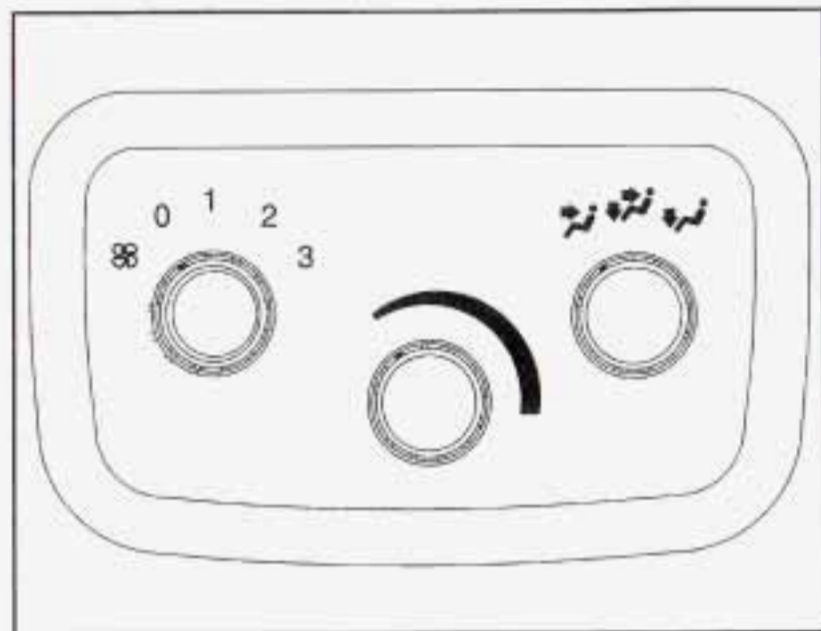

**TrailBlazer EXT**

Turn the knobs on the control panel to choose a fan speed, temperature and direction of airflow.

Selecting panel mode will deliver air to the four headliner outlets. Selecting bi-level mode will deliver warmer air to the third seat floor outlet and cooler air to the headliner outlets. Selecting floor mode will deliver air to the floor outlet located in the third seat area.

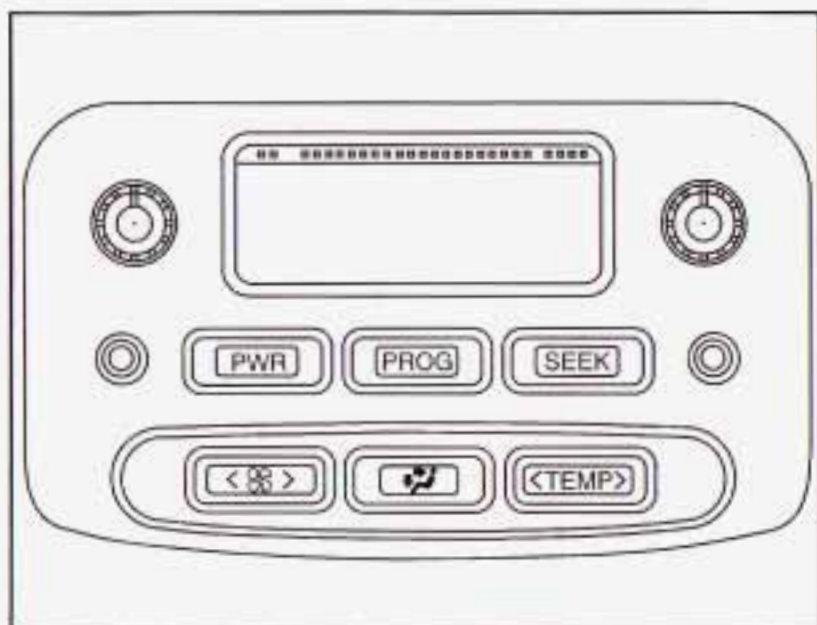

**TrailBlazer EXT**

Press the buttons at the bottom of the audio control panel to adjust the fan speed, mode and temperature for the rear passengers. The selections will be shown on the display.

Press the rear fan control button with the arrow pointing right to turn the rear climate control on. Toggle this button to adjust the air flow speed. To turn the rear system off, toggle the left arrow until the display turns off.

## Steering Wheel Climate Controls

You can adjust the fan speed and temperature of the front climate control system by using the buttons located on your steering wheel.



 **(Fan):** Press the up or down arrow on this switch to increase or decrease the fan speed.

 **(Temperature):** Press the up or down arrow on this switch to increase or decrease the temperature of the air flowing through the system.

## Climate Controls Personalization

If your vehicle is equipped with the Driver Information Center (DIC), you can store and recall the climate control settings for temperature, air delivery mode and fan speed for two different drivers. The personal choice settings recalled are determined by the transmitter used to enter the vehicle. After the button with the unlock symbol on a remote keyless entry transmitter is pressed, the climate control will adjust to the last settings of the identified driver. The settings can also be changed by pressing one of the memory buttons (1 or 2) located on the driver's door. When adjustments are made, the new settings are automatically saved for the driver.



## Warning Lights, Gages and Indicators

This part describes the warning lights and gages that may be on your vehicle. The pictures will help you locate them.

Warning lights and gages can signal that something is wrong before it becomes serious enough to cause an expensive repair or replacement. Paying attention to your warning lights and gages could also save you or others from injury.

Warning lights come on when there may be or is a problem with one of your vehicle's functions. As you will see in the details on the next few pages, some warning lights come on briefly when you start the engine just to let you know they're working. If you are familiar with this section, you should not be alarmed when this happens.

Gages can indicate when there may be or is a problem with one of your vehicle's functions. Often gages and warning lights work together to let you know when there's a problem with your vehicle.

When one of the warning lights comes on and stays on when you are driving, or when one of the gages shows there may be a problem, check the section that tells you what to do about it. Please follow this manual's advice.

Waiting to do repairs can be costly—and even dangerous. So please get to know your warning lights and gages. They're a big help.

Your vehicle may also have a Driver Information Center (DIC) that works along with the warning lights and gages. See *Driver Information Center (DIC)* on page 3-46.

## Instrument Panel Cluster

Your instrument panel cluster is designed to let you know at a glance how your vehicle is running. You'll know how fast you're going, about how much fuel you've used, and many other things you'll need to know to drive safely and economically.

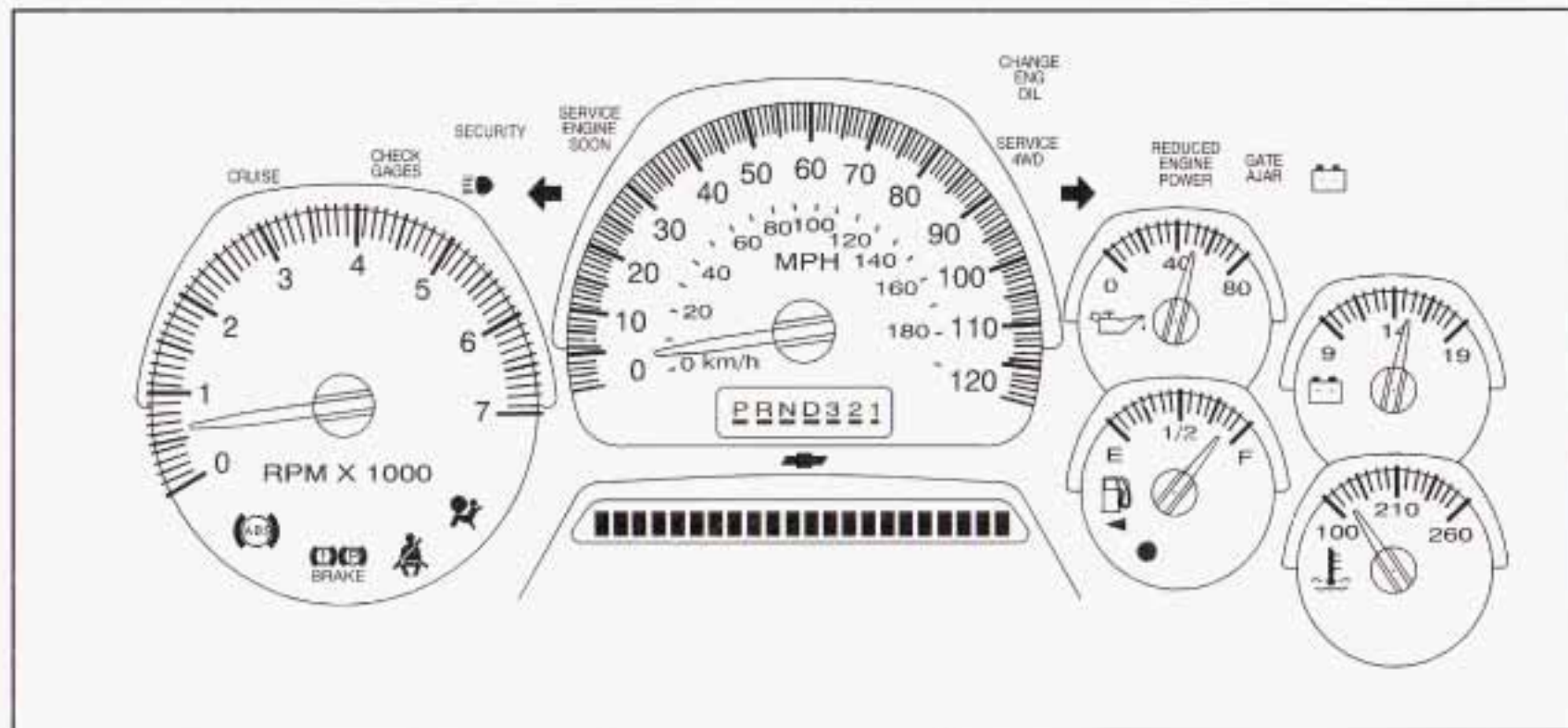

United States version shown, Canada similar

## Speedometer and Odometer

Your speedometer lets you see your speed in both miles per hour (mph) and kilometers per hour (km/h).

Your odometer shows how far your vehicle has been driven, in either miles (used in the United States) or kilometers (used in Canada).

The odometer mileage can be checked without the vehicle running. Simply press the trip odometer button.

You may wonder what happens if your vehicle needs a new odometer installed. The new one will be set to the correct millage total of the old odometer.

### Trip Odometer

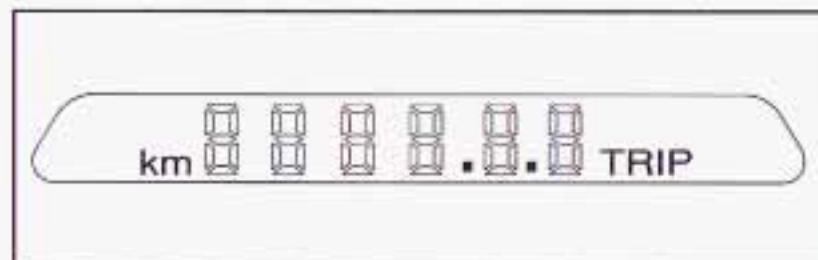

The trip odometer can tell you how far your vehicle has been driven since you last set the trip odometer to zero.

The trip odometer is part of the Driver Information Center (DIC). For vehicles without a DIC, press the stem located on the instrument panel cluster to display the trip odometer. Press and hold the stem to reset the trip odometer once it is displayed.

### Tachometer

The tachometer displays the engine speed in revolutions per minute (rpm).

**Notice:** Do not operate the engine with the tachometer in the shaded warning area, or engine damage may occur.

## Safety Belt Reminder Light

When the key is turned to RUN, a chime will come on for several seconds to remind people to fasten their safety belts, unless the driver's safety belt is already buckled.



The safety belt light will also come on and stay on for several seconds, then it will flash for several more.

If the driver's belt is already buckled, neither the chime nor the light will come on.

## Air Bag Readiness Light

There is an air bag readiness light on the instrument panel, which shows the air bag symbol. The system checks the air bag's electrical system for malfunctions. The light tells you if there is an electrical problem. The system check includes the air bag sensors, the air bag modules, the wiring and the crash sensing and diagnostic module. For more information on the air bag system, see *Air Bag Systems* on page 1-49.



This light will come on when you start your vehicle, and it will flash for a few seconds. Then the light should go out. This means the system is ready.

If the air bag readiness light stays on after you start the vehicle or comes on when you are driving, your air bag system may not work properly. Have your vehicle serviced right away.

### CAUTION:

**If the air bag readiness light stays on after you start your vehicle, it means the air bag system may not be working properly. The air bags in your vehicle may not inflate in a crash, or they could even inflate without a crash. To help avoid injury to yourself or others, have your vehicle serviced right away if the air bag readiness light stays on after you start your vehicle.**

The air bag readiness light should flash for a few seconds when you turn the ignition key to RUN. If the light doesn't come on then, have it fixed so it will be ready to warn you if there is a problem.

## Charging System Light

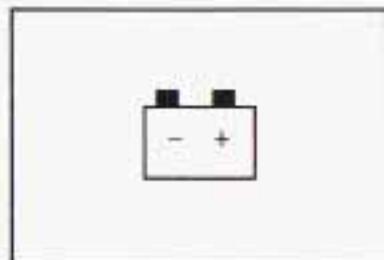

The charging system light will come on briefly when you turn on the ignition, but the engine is not running, as a check to show you it is working.

It should go out once the engine is running. If it stays on, or comes on while you are driving, you may have a problem with the charging system. It could indicate that you have problems with a generator drive belt, or another electrical problem. Have it checked right away. Driving while this light is on could drain your battery.

If you must drive a short distance with the light on, be certain to turn off all your accessories, such as the radio and air conditioner.

## Voltmeter Gage



When your engine is not running, but the ignition is on (in RUN), this gage shows your battery's state of charge in DC volts.

When the engine is running, the gage shows the condition of the charging system. Readings between the low and high warning zones indicate the normal operating range.

Readings in the low warning zone may occur when a large number of electrical accessories are operating in the vehicle and the engine is left idling for an extended period. This condition is normal since the charging system is not able to provide full power at engine idle. As engine speeds are increased, this condition should correct itself as higher engine speeds allow the charging system to create maximum power.

You can only drive for a short time with the reading in either warning zone. If you must drive, turn off all unnecessary accessories.

Readings in either warning zone indicate a possible problem in the electrical system. Have the vehicle serviced as soon as possible.

## Brake System Warning Light

When the ignition is on, the brake system warning light will come on when you set your parking brake. The light will stay on if your parking brake doesn't release fully. If it stays on after your parking brake is fully released, it means you have a brake problem. A chime may also sound when the light comes on.

Your vehicle's hydraulic brake system is divided into two parts. If one part isn't working, the other part can still work and stop you. For good braking, though, you need both parts working well.

If the warning light comes on, there could be a brake problem. Have your brake system inspected right away.



United States



Canada

This light should come on briefly when you turn the ignition key to RUN. If it doesn't come on then, have it fixed so it will be ready to warn you if there's a problem.

If the light comes on while you are driving, pull off the road and stop carefully. You may notice that the pedal is harder to push. Or, the pedal may go closer to the floor. It may take longer to stop. If the light is still on, have the vehicle towed for service. See *Towing Your Vehicle* on page 4-42.

### CAUTION:

**Your brake system may not be working properly if the brake system warning light is on. Driving with the brake system warning light on can lead to an accident. If the light is still on after you've pulled off the road and stopped carefully, have the vehicle towed for service.**

## Anti-Lock Brake System Warning Light



With the anti-lock brake system, this light will come on when you start your engine and may stay on for several seconds. That's normal. A chime may also sound when the light comes on.

If the light stays on, or comes on when you're driving, your vehicle needs service. If the regular brake system warning light isn't on, you still have brakes, but you don't have anti-lock brakes. If the regular brake system warning light is also on, you don't have anti-lock brakes and there's a problem with your regular brakes. See *Brake System Warning Light on page 3-37* earlier in this section.

The anti-lock brake system warning light should come on briefly when you turn the ignition key to RUN. If the light doesn't come on then, have it fixed so it will be ready to warn you if there is a problem.

## Engine Coolant Temperature Gage



**United States**

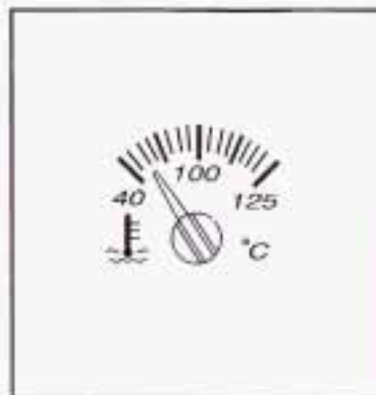

**Canada**

This gage shows the engine coolant temperature. If the gage pointer moves into the red area, it means that your engine coolant has overheated. If you have been operating your vehicle under normal driving conditions, you should pull off the road, stop your vehicle and turn off the engine as soon as possible.

See *Engine Overheating on page 5-25* for more information.

## Malfunction Indicator Lamp

### Service Engine Soon Light in the United States or Check Engine Light in Canada



United States

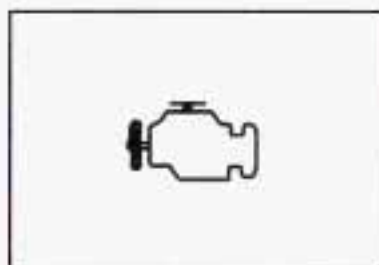

Canada

Your vehicle is equipped with a computer which monitors operation of the fuel, ignition and emission control systems.

This system is called OBD II (On-Board Diagnostics-Second Generation) and is intended to assure that emissions are at acceptable levels for the life of the vehicle, helping to produce a cleaner environment. The SERVICE ENGINE SOON or CHECK ENGINE light comes on to indicate that there is a problem and service is required. Malfunctions often will be indicated by the system before any problem is apparent. This may prevent more serious damage to

your vehicle. This system is also designed to assist your service technician in correctly diagnosing any malfunction.

**Notice:** If you keep driving your vehicle with this light on, after a while, your emission controls may not work as well, your fuel economy may not be as good and your engine may not run as smoothly. This could lead to costly repairs that may not be covered by your warranty.

**Notice:** Modifications made to the engine, transmission, exhaust, intake or fuel system of your vehicle or the replacement of the original tires with other than those of the same Tire Performance Criteria (TPC) can affect your vehicle's emission controls and may cause this light to come on. Modifications to these systems could lead to costly repairs not covered by your warranty. This may also result in a failure to pass a required Emission Inspection/Maintenance test.

This light should come on, as a check to show you it is working, when the ignition is on and the engine is not running. If the light doesn't come on, have it repaired. This light will also come on during a malfunction in one of two ways:

- **Light Flashing** — A misfire condition has been detected. A misfire increases vehicle emissions and may damage the emission control system on your vehicle. Dealer or qualified service center diagnosis and service may be required.



- **Light On Steady** — An emission control system malfunction has been detected on your vehicle. Dealer or qualified service center diagnosis and service may be required.

## If the Light Is Flashing

The following may prevent more serious damage to your vehicle:

- Reducing vehicle speed.
- Avoiding hard accelerations.
- Avoiding steep uphill grades.
- If you are towing a trailer, reduce the amount of cargo being hauled as soon as it is possible.

If the light stops flashing and remains on steady, see "If the Light Is On Steady" following.

If the light continues to flash, when it is safe to do so, *stop the vehicle*. Find a safe place to park your vehicle. Turn the key off, wait at least 10 seconds and restart the engine. If the light remains on steady, see "If the Light Is On Steady" following. If the light is still flashing, follow the previous steps, and drive the vehicle to your dealer or qualified service center for service.

## If the Light Is On Steady

You may be able to correct the emission system malfunction by considering the following:

Did you recently put fuel into your vehicle?

If so, reinstall the fuel cap, making sure to fully install the cap. See *Filling Your Tank on page 5-7*. The diagnostic system can determine if the fuel cap has been left off or improperly installed. A loose or missing fuel cap will allow fuel to evaporate into the atmosphere. A few driving trips with the cap properly installed should turn the light off.

Did you just drive through a deep puddle of water?

If so, your electrical system may be wet. The condition will usually be corrected when the electrical system dries out. A few driving trips should turn the light off.

Have you recently changed brands of fuel?

If so, be sure to fuel your vehicle with quality fuel. See *Gasoline Octane on page 5-5*. Poor fuel quality will cause your engine not to run as efficiently as designed. You may notice this as stalling after start-up, stalling when you put the vehicle into gear, misfiring, hesitation on acceleration or stumbling on acceleration. (These conditions may go away once the engine is warmed up.) This will be detected by the system and cause the light to turn on.

If you experience one or more of these conditions, change the fuel brand you use. It will require at least one full tank of the proper fuel to turn the light off.

If none of the above steps have made the light turn off, have your dealer or qualified service center check the vehicle. Your dealer has the proper test equipment and diagnostic tools to fix any mechanical or electrical problems that may have developed.

## Emissions Inspection and Maintenance Programs

Some state/provincial and local governments have or may begin programs to inspect the emission control equipment on your vehicle. Failure to pass this inspection could prevent you from getting a vehicle registration.

Here are some things you need to know to help your vehicle pass an inspection:

Your vehicle will not pass this inspection if the SERVICE ENGINE SOON or CHECK ENGINE light is on or not working properly.

Your vehicle will not pass this inspection if the OBD (on-board diagnostic) system determines that critical emission control systems have not been completely diagnosed by the system. The vehicle would be considered not ready for inspection. This can happen if you have recently replaced your battery or if your

battery has run down. The diagnostic system is designed to evaluate critical emission control systems during normal driving. This may take several days of routine driving. If you have done this and your vehicle still does not pass the inspection for lack of OBD system readiness, see your dealer or qualified service center to prepare the vehicle for inspection.

## Oil Pressure Gage

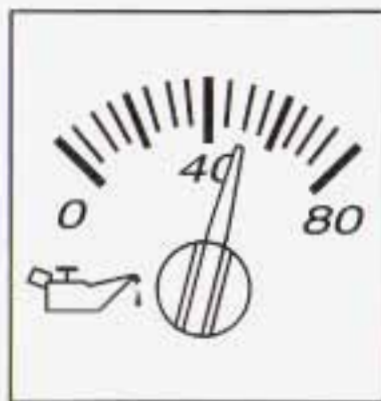

United States

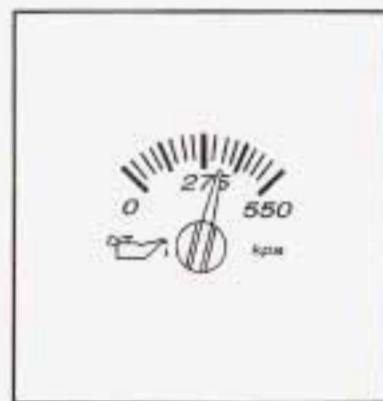

Canada

The oil pressure gage shows the engine oil pressure in psi (pounds per square inch) when the engine is running. Canadian vehicles indicate pressure in kPa (kilopascals).

## CAUTION:

Don't keep driving if the oil pressure is low. If you do, your engine can become so hot that it catches fire. You or others could be burned. Check your oil as soon as possible and have your vehicle serviced.

**Notice:** Damage to your engine from neglected oil problems can be costly and is not covered by your warranty.

Oil pressure may vary with engine speed, outside temperature and oil viscosity, but readings above the low pressure zone indicate the normal operating range.

A reading in the low pressure zone may be caused by a dangerously low oil level or other problems causing low oil pressure.

## Change Engine Oil Light

CHANGE  
ENG  
OIL

United States



Canada

This light is displayed when the engine oil needs to be changed.

Once the engine oil has been changed, the CHANGE ENG OIL light must be reset. Until it is reset, the light will be displayed when the engine is on.

## Security Light

SECURITY

United States



Canada

This light will come on briefly when you turn the key toward START. The light will stay on until the engine starts.

If the light flashes, the Passlock<sup>®</sup> system has entered a tamper mode. If the vehicle fails to start, see *Passlock<sup>®</sup>* on page 2-18.

If the light comes on continuously while driving and stays on, there may be a problem with the Passlock<sup>®</sup> system. Your vehicle will not be protected by Passlock<sup>®</sup>, and you should see your dealer.

Also, see *Content Theft-Deterrent* on page 2-17 for additional information regarding the SECURITY light.

## Cruise Control Light



United States

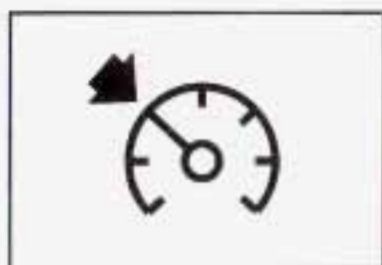

Canada

Your vehicle may have this feature. The CRUISE light appears whenever you set your cruise control.

## Reduced Engine Power Light

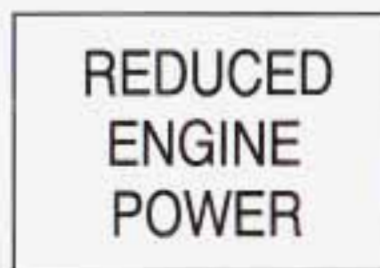

United States

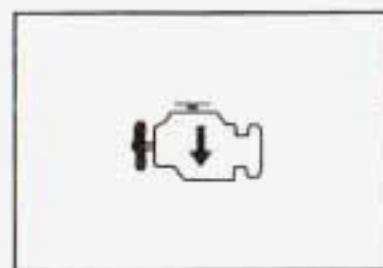

Canada

This light is displayed when a noticeable reduction in the vehicle's performance may occur. The vehicle may be driven at a reduced speed when the reduced engine power light is on but acceleration and speed may be reduced. The performance may be reduced until the next time you drive your vehicle. If this light stays on, see your dealer as soon as possible for diagnosis and repair.

This light may also come on if there is a problem with the Electronic Throttle Control (ETC) system. If this happens, take the vehicle in for service as soon as possible.

## Service Four-Wheel Drive Warning Light



United States



Canada

This light should come on briefly when you turn on the ignition, as a check to show you it is working.

The SERVICE 4WD light comes on to indicate that there may be a problem with the drive system and service is required. Malfunctions can be indicated by the system before any problem is apparent, which may prevent serious damage to the vehicle. This system is also designed to assist your service technician in correctly diagnosing a malfunction.

## Check Gages Warning Light



United States



Canada

The CHECK GAGES light will come on briefly when you are starting the engine.

If the light comes on and stays on while you are driving, check your coolant temperature and engine oil pressure gages to see if they are in the warning zones.

## Gate Ajar Light



United States



Canada

If this light comes on, your liftgate or liftglass is ajar. Try closing the liftgate or liftglass again. Never drive with the liftgate or liftglass even partially open.

## Fuel Gage



United States



Canada

When the ignition is on, the fuel gage tells you about how much fuel you have remaining.

Here are four things that some owners ask about. None of these show a problem with your fuel gage:

- At the gas station, the gas pump shuts off before the gage reads full.

- It takes a little more or less fuel to fill up than the gage indicated. For example, the gage may have indicated the tank was half full, but it actually took a little more or less than half the tank's capacity to fill the tank.
- The gage moves a little when you turn a corner or speed up.
- The gage doesn't go back to empty when you turn off the ignition.

## Low Fuel Warning Light

The light next to the fuel gage will come on briefly when you are starting the engine.

This light comes on when the fuel tank is low on fuel. To turn it off, add fuel to the fuel tank.

## Driver Information Center (DIC)

Your vehicle may have this feature. The DIC display is located on the instrument panel cluster above the steering wheel. The DIC can display information such as the trip odometer, fuel economy and personalization features. The DIC buttons are located on the steering wheel.

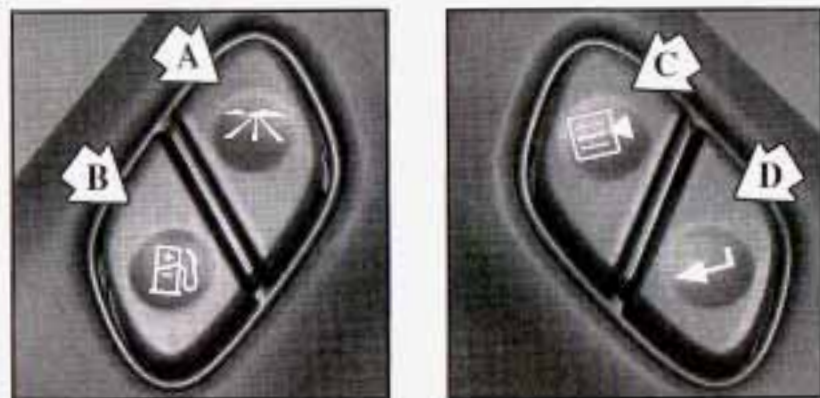

- A. **Trip Information:** This button will display the odometer, trip odometer and the timer.
- B. **Fuel Information:** This button will display the current range, average fuel economy, instant fuel economy and engine oil life.
- C. **Personalization:** This button will change personal options available on your vehicle.

- D. **Select:** This button resets certain functions and turns off or acknowledges messages on the DIC.

## DIC Operation and Displays

The DIC comes on when the ignition is on. After a short delay the DIC will display the current driver and the information that was last displayed before the engine was turned off.

If a problem is detected, a warning message will appear on the display. Pressing the select button will acknowledge any current warning or service messages.

The DIC has different modes which can be accessed by pressing the four buttons on the DIC. These buttons are trip information, fuel information, personalization and select. The button functions are detailed in the following.

### Trip Information

Use the trip information button to scroll through the odometer, TRIP A, TRIP B and TIMER.

### Odometer

Press the trip information button until the odometer appears on the display. This shows the total distance the vehicle has been driven in either miles or kilometers. Pressing the reset stem located on the instrument cluster with the vehicle off will also display the odometer.

## **Trip A and Trip B**

Press the trip information button until TRIP A or TRIP B is displayed. This shows the current distance traveled since the last reset for each trip odometer in either miles or kilometers. Both odometers can be used at the same time.

Each trip odometer can be reset to zero separately by pressing select while the desired trip odometer is displayed. You can also reset the trip odometers with the reset stem on the cluster. If you press and hold the reset stem for four seconds, the display will show the distance traveled since the last ignition cycle.

## **Timer**

The DIC can be used as a stopwatch. Press the select button while TIMER is displayed to start the timer. The display will show the amount of time that has passed since the timer was last reset (not including time the ignition is off). Time will continue to be counted as long as the ignition is on, even if another display is being shown on the DIC. The timer will record up to 99 hours, 59 minutes and 59 seconds (99:59:59) after which the display will roll back to zero.

To stop the counting of time, press the select button briefly while TIMER is displayed.

To reset the timer to zero, press and hold the select button while TIMER is displayed.

## **Fuel Information**

Use the fuel information button to scroll through the range, average fuel economy, instant fuel economy and the GM Oil Life System™.

### **Fuel Range**

Press the fuel information button until RANGE appears to display the remaining distance you can drive without refueling. It's based on fuel economy and the fuel remaining in the tank. The display will show LOW if the fuel level is low.

The fuel economy data used to determine fuel range is an average of recent driving conditions. As your driving conditions change, this data is gradually updated. Fuel range cannot be reset.

### **Average Fuel Economy**

Press the fuel information button until AVG appears in the display. Average fuel economy is how many miles per gallon your vehicle is getting based on current and past driving conditions.

Press and hold the select button while AVG, ECON is displayed to reset the average fuel economy. Average fuel economy will then be calculated starting from that point. If the average fuel economy is not reset, it will be continually updated each time you drive.



## Instant Fuel Economy

Press the fuel information button until INST appears in the display. Instant fuel economy is how many miles per gallon your vehicle is at the particular moment in time. The instant fuel economy cannot be reset.

## GM Oil Life System

Press the fuel information button until ENGINE OIL LIFE appears in the display. The GM Oil Life System™ shows an estimate of the oil's remaining useful life. It will show 100% when the system is reset after an oil change. It will alert you to change your oil on a schedule consistent with your driving conditions.

Always reset the engine oil life after an oil change. To reset the Oil Life System press and hold the select button while ENGINE OIL LIFE is displayed.

The DIC does not replace the need to maintain your vehicle as recommended in the Maintenance Schedule in this manual. Also, the oil change reminder will not detect dusty conditions or engine malfunctions that may affect the oil. Also, the oil change reminder does not measure how much oil you have in your engine. So, be sure to check your oil level often. See *Engine Oil* on page 5-15.

## Personalization

You can program certain features to a preferred setting for up to two people. Press the personalization button to scroll through the following personalization features. All of the personalization options may not be available on your vehicle. Only the options available will be displayed on your DIC.

- ALARM WARNING TYPE
- AUTOMATIC LOCKING
- AUTOMATIC UNLOCKING
- SEAT POSITION RECALL
- PERIMETER LIGHTING
- REMOTE LOCK FEEDBACK
- REMOTE UNLOCK FEEDBACK
- HEADLAMPS ON AT EXIT
- MIRROR CURB VIEW ASSIST
- EASY EXIT DRIVER SEAT
- DISPLAY UNITS (E/M)
- DISPLAY LANGUAGE

The driver's preferences are recalled by pressing the unlock button on the remote keyless entry transmitter or by pressing the appropriate memory button 1 or 2 located on the driver's door.

## Alarm Warning Type

Press the personalization button until ALARM WARNING TYPE appears in the display. To select your personalization for alarm warning type, press the select button while ALARM WARNING TYPE is displayed on the DIC. Pressing the select button will scroll through the following choices:

- ALARM WARNING: BOTH (default)
- ALARM WARNING: OFF
- ALARM WARNING: HORN
- ALARM WARNING: LAMPS

If you choose BOTH, the headlamps will flash and the horn will chirp when the alarm is active.

If you choose OFF, there will be no alarm warning on activation.

If you choose HORN, the horn will chirp when the alarm is active.

If you choose LAMPS, the headlamps will flash when the alarm is active.

Choose one of the four options and press the personalization button while it is displayed on the DIC to select it and move on to the next feature. For more information on alarm warning type, see *Content Theft-Deterrent* on page 2-17.

## Automatic Locking

Press the select button while AUTOMATIC LOCKING is displayed on the DIC to scroll through the following choices:

- LOCK DOORS OUT OF PARK (default)
- LOCK DOORS MANUALLY
- LOCK DOORS WITH SPEED

If you choose for the doors to lock out of park, the doors will lock when the vehicle is shifted out of PARK (P).

If you choose for the doors to lock manually, the doors will not be locked automatically.

If you choose for the doors to lock with speed, the doors will lock when the vehicle speed is above 8 mph (13 km/h) for three seconds.

Press the personalization button while your choice is displayed on the DIC to select it and move on to the next feature. For more information on automatic door locks see *Programmable Automatic Door Locks* on page 2-10.

## Automatic Unlocking

Press the personalization button until AUTOMATIC UNLOCKING appears in the display. To select your personalization for automatic unlocking, press the select button while AUTOMATIC UNLOCKING is displayed on the DIC. Pressing the select button will scroll through the following choices:

- UNLOCK ALL IN PARK (default)
- UNLOCK ALL AT KEY OUT
- UNLOCK DOORS MANUALLY
- UNLOCK DRIVER IN PARK

If you choose for all the doors to unlock in park, all of the doors will unlock when the vehicle is shifted into PARK (P).

If you choose for all the doors to unlock at key out, all of the doors will unlock when the key is taken out of the ignition.

If you choose for the doors to unlock manually, the doors will not be unlocked automatically.

If you choose for the driver's door to unlock in park, the driver's door will be unlocked when the vehicle is shifted into PARK (P).

Choose one of the four options and press the personalization button while it is displayed on the DIC to select it and move on to the next feature. For more information on automatic door locks see *Programmable Automatic Door Locks on page 2-10*.

## Seat Position Recall

Press the personalization button until SEAT POSITION RECALL appears in the display. To select your personalization for seat position recall, press the select button while SEAT POSITION RECALL is displayed on the DIC. Pressing the select button will scroll through the following choices:

- SEAT POSITION RECALL OFF (default)
- SEAT POSITION RECALL AT KEY IN
- SEAT POSITION RECALL ON REMOTE

If you choose seat recall off, the memory seat position you saved will only be recalled when the memory button 1 or 2 is pressed.

If you choose seat recall at key in, the memory seat position you saved will be recalled when you put the key in the ignition.

If you choose seat recall on remote, the memory seat position you saved will be recalled when you unlock the vehicle with the remote keyless entry transmitter.

Choose one of the three options and press the personalization button while it is displayed on the DIC to select it and move on to the next feature.

## Perimeter Lighting

Press the personalization button until PERIMETER LIGHTING appears in the display. To select your personalization for perimeter lighting, press the select button while PERIMETER LIGHTING is displayed on the DIC. Pressing the select button will scroll through the following choices:

- PERIMETER LIGHTING ON (default)
- PERIMETER LIGHTING OFF

If you choose for perimeter lighting to be on, the headlamps and back-up lamps will come on for 40 seconds, if it is dark enough outside, when you unlock the vehicle with the remote keyless entry transmitter.

Choose one of the two options and press the personalization button while it is displayed on the DIC to select it and move on to the next feature.

## Remote Lock Feedback

Press the personalization button until REMOTE LOCK FEEDBACK appears in the display. To select your personalization for the feedback you will receive when locking the vehicle with the remote keyless entry

transmitter, press the select button while REMOTE LOCK FEEDBACK is displayed on the DIC. Pressing the select button will scroll through the following choices:

- LOCK FEEDBACK: BOTH (default)
- LOCK FEEDBACK: OFF
- LOCK FEEDBACK: HORN
- LOCK FEEDBACK: LAMPS

If you choose both, the parking lamps will flash each time you press the button with the lock symbol on the remote keyless entry transmitter and the horn will chirp the second time you press the lock button.

If you choose off, there will be no feedback when locking the vehicle.

If you choose horn, the horn will chirp the second time you press the button with the lock symbol on the remote keyless entry transmitter.

If you choose lamps, the parking lamps will flash each time you press the button with the lock symbol on the remote keyless entry transmitter.

Choose one of the four options and press the personalization button while it is displayed on the DIC to select it and move on to the next feature.

## Remote Unlock Feedback

Press the personalization button until REMOTE UNLOCK FEEDBACK appears in the display. To select your personalization for the feedback you will receive when unlocking the vehicle with the remote keyless entry transmitter, press the select button while REMOTE UNLOCK FEEDBACK is displayed on the DIC. Pressing the select button will scroll through the following choices:

- UNLOCK FEEDBACK: LAMPS (default)
- UNLOCK FEEDBACK: BOTH
- UNLOCK FEEDBACK: OFF
- UNLOCK FEEDBACK: HORN

If you choose lamps, the parking lamps will flash each time you press the button with the unlock symbol on the remote keyless entry transmitter.

If you choose both, the parking lamps will flash each time you press the button with the unlock symbol on the remote keyless entry transmitter. The horn will chirp the second time you press the unlock button.

If you choose off, there will be no feedback when unlocking the vehicle.

If you choose horn, the horn will chirp the second time you press the button with the unlock symbol on the remote keyless entry transmitter.

Choose one of the four options and press the personalization button while it is displayed on the DIC to select it and move on to the next feature.

## Headlamps on at Exit

Press the personalization button until HEADLAMPS ON AT EXIT appears in the display. To select your personalization for how long the headlamps will stay on when you turn off the vehicle, press the select button while HEADLAMPS ON AT EXIT is displayed on the DIC. Pressing the select button will scroll through the following choices:

- HEADLAMP DELAY: 10 SEC (default)
- HEADLAMP DELAY: 20 SEC
- HEADLAMP DELAY: 40 SEC
- HEADLAMP DELAY: 60 SEC
- HEADLAMP DELAY: 120 SEC
- HEADLAMP DELAY: 180 SEC
- HEADLAMP DELAY OFF

The amount of time you choose will be the amount of time that the headlamps stay on after you turn off the vehicle. If you choose off, the headlamps will turn off as soon as you turn off the vehicle.

Choose one of the seven options and press the personalization button while it is displayed on the DIC to select it and move on to the next feature.

## Mirror Curbview Assist

Press the personalization button until MIRROR CURBVIEW ASSIST appears in the display. To select your personalization for tilt mirror in reverse, press the select button while MIRROR CURBVIEW ASSIST is displayed on the DIC. Pressing the select button will scroll through the following choices:

- CURB VIEW: OFF (default)
- CURB VIEW: PASSENGER
- CURB VIEW: DRIVER
- CURB VIEW: BOTH

If you choose off, neither outside mirror will be tilted down when the vehicle is shifted into REVERSE (R).

If you choose passenger, the passenger's outside mirror will be tilted down when the vehicle is shifted into REVERSE (R).

If you choose driver, the driver's outside mirror will be tilted down when the vehicle is shifted into REVERSE (R).

If you choose both, the driver's and passenger's outside mirror will be tilted down when the vehicle is shifted into REVERSE (R).

Choose one of the four options and press the personalization button while it is displayed on the DIC to select it and move on to the next feature.

## Easy Exit Driver Seat

Press the personalization button until EASY EXIT DRIVER SEAT appears in the display. To select your personalization for seat position exit, press the select button while EASY EXIT DRIVER SEAT is displayed on the DIC. Pressing the select button will scroll through the following choices:

- EASY EXIT SEAT: OFF (default)
- EASY EXIT SEAT: ON

If you choose for the easy exit seat feature to be on, the driver's seat will move to the exit position when the key is removed from the ignition. If you choose for this feature to be off, no seat exit recall will occur.

Choose one of the two options and press the personalization button while it is displayed on the DIC to select it and move on to the next feature.

## Display Units (ENG/MET)

Press the personalization button until DISPLAY UNITS appears in the display. To select English or metric, press the select button while DISPLAY UNITS is displayed on the DIC. Pressing the select button will scroll through the following choices:

- UNITS: ENGLISH
- UNITS: METRIC KM/L
- UNITS: METRIC L/100KM

If you choose English, all information will be displayed in English units. For example, distance in miles and fuel economy in miles per gallon is displayed.

If you choose metric KM/L, all information will be displayed in metric units. For example, distance in kilometers and fuel economy in KM/L is displayed.

If you choose metric L/100KM, all information will be displayed in metric units. For example, distance in kilometers and fuel economy in L/100KM is displayed.

Choose one of the three options and press the personalization button while it is displayed on the DIC to select it and end out of the personalization options.

## Display Language

To select your personalization for display language, press the select button while DISPLAY LANGUAGE is displayed on the DIC. Pressing the select button will scroll through the available languages:

Choosing a language will display all of the information on the DIC in the desired language.

If you accidentally choose a language that you don't want or understand, press and hold the personalization button and the trip information button at the same time. The DIC will begin scrolling through the languages in their particular language. English will be in English, French will be in French and so on. When you see the language that you would like, release both buttons. The DIC will then display the information in the language you chose.

Choose one of the options and press the personalization button while it is displayed on the DIC to select it.

## Select

The select button is used to reset certain functions and turn off or acknowledge messages on the DIC display. The select button also toggles through the options available in each personalization menu. For example, this button will reset the trip odometers, turn off the FUEL LEVEL LOW message, and toggle through the languages you can select the DIC to display information in.

## DIC Warnings and Messages

Warning messages are displayed on the DIC to notify the driver that the status of the vehicle has changed and that some action may be needed by the driver to correct the condition. More than one message may appear at one time. They will appear one behind the other. Some messages may not require immediate action but you should press the select button to acknowledge that you received the message and clear it from the display. Some messages cannot be cleared from the display because they are more urgent. These messages require action before they can be removed from the DIC display. The following are the possible messages that can be displayed and some information about them.

## **ENGINE COOLANT HOT/IDLE ENGINE**

If the cooling system temperature gets hot, this message will appear in the DIC and you will hear a chime. Stop the vehicle and let the engine idle in PARK (P) to allow the coolant to reach a safe temperature. This message will clear when the coolant temperature drops to a safe operating temperature.

## **OIL PRESSURE LOW/STOP ENGINE**

If low oil pressure levels occur, this message will be displayed on the DIC. Stop the vehicle as soon as safely possible and do not operate it until the cause of the low oil pressure has been corrected. Check your oil as soon as possible and have your vehicle serviced.

## **BATTERY NOT CHARGING**

If the battery is not charging during operation, this message will appear on the DIC. Driving with this problem could drain your battery. Have the electrical system checked as soon as possible. Pressing the select button will acknowledge this message and clear it from the DIC display.

## **SERVICE AIR BAG**

If there is a problem with the air bag system this message will be displayed on the DIC. Have a qualified technician inspect the system for problems. Pressing the select button will acknowledge this message and clear it from the DIC display.

## **SERVICE BRAKE SYSTEM**

If a problem occurs with the brake system this message will appear on the DIC. If this message appears, stop as soon as possible and turn off the vehicle. Restart the vehicle and check for the message on the DIC display. If the message is still displayed, or appears again when you begin driving, the brake system needs service.

## **TURN SIGNAL ON**

If a turn signal is left on for 3/4 of a mile (1.2 km), this message will appear on the display and you will hear a chime. Move the turn signal/multifunction lever to the off position. Pressing the select button will acknowledge this message and clear it from the DIC display.



## **REAR ACCESS OPEN**

If the liftgate or liftglass is open while the ignition is in RUN, this message will appear on the DIC and you will hear a chime. Turn off the vehicle and check the liftgate and liftglass. Restart the vehicle and check for the message on the DIC display. Pressing the select button will acknowledge this message and clear it from the DIC display.

## **FUEL LEVEL LOW**

If the fuel level is low in the vehicle's gas tank this message will appear on the DIC and you will hear a chime. Refuel as soon as possible. Pressing the select button will acknowledge this message and clear it from the DIC display.

## **CHECK WASHER FLUID**

If the washer fluid level is low, this message will appear on the DIC. Adding washer fluid will clear the message. Pressing the select button will acknowledge this message and clear it from the DIC display.

## **TRANS HOT IDLE ENGINE**

If the transmission fluid in the vehicle gets hot, this message will appear on the DIC. Driving with the transmission fluid temperature high can cause damage to the vehicle. Stop the vehicle and let it idle to allow the transmission to cool. This message will clear when the fluid temperature reaches a safe level.

## **ICE POSSIBLE**

If the outside temperature reaches a level where ice could form on the roadway, this message may appear on the DIC. If the temperature rises to a safe level, the message will clear. Pressing the select button will acknowledge this message and clear it from the DIC display.

## **DRIVER DOOR AJAR**

If the driver's door is not fully closed, this message will appear on the display and you will hear a chime. Stop and turn off the vehicle, check the door for obstacles, and close the door again. Check to see if the message still appears on the DIC. Pressing the select button will acknowledge this message and clear it from the DIC display.

## **PASSENGER DOOR AJAR**

If the passenger's door is not fully closed, this message will appear on the display and you will hear a chime. Stop and turn off the vehicle, check the door for obstacles, and close the door again. Check to see if the message still appears on the DIC. Pressing the select button will acknowledge this message and clear it from the DIC display.

## **LEFT REAR DOOR AJAR**

If the driver's side rear door is not fully closed this message will appear on the display and you will hear a chime. Stop and turn off the vehicle, check the door for obstacles, and close the door again. Check to see if the message still appears on the DIC. Pressing the select button will acknowledge this message and clear it from the DIC display.

## **RIGHT REAR DOOR AJAR**

If the passenger's side rear door is not fully closed this message will appear on the display and you will hear a chime. Stop and turn off the vehicle, check the door for obstacles, and close the door again. Check to see if the message still appears on the DIC. Pressing the select button will acknowledge this message and clear it from the DIC display.

## **RFA # BATTERY LOW**

If a remote keyless entry transmitter battery is low, this message will appear on the DIC. The battery needs to be replaced in the transmitter. Pressing the select button will acknowledge this message and clear it from the DIC display.

## Audio System(s)

**Notice:** Before you add any sound equipment to your vehicle – like a tape player, CB radio, mobile telephone or two-way radio – be sure you can add what you want. If you can, it's very important to do it properly. Added sound equipment may interfere with the operation of your vehicle's engine, Delphi Electronics radio or other systems, and even damage them. Your vehicle's systems may interfere with the operation of sound equipment that has been added improperly.

**So, before adding sound equipment, check with your dealer and be sure to check federal rules covering mobile radio and telephone units.**

Your audio system has been designed to operate easily and to give years of listening pleasure. You will get the most enjoyment out of it if you acquaint yourself with it first. Find out what your audio system can do and how to operate all of its controls to be sure you're getting the most out of the advanced engineering that went into it.

Your vehicle has a feature called Retained Accessory Power (RAP). With RAP, you can play your audio system even after the ignition is turned off. See "Retained Accessory Power (RAP)" under *Ignition Positions* on page 2-19.

## Setting the Time

Your radio may have a button marked with an H or HR to represent hours and an M or MIN to represent minutes.

Press and hold the hour button until the correct hour appears on the display. AM or PM will also appear on the display. Press and hold the minute button until the correct minute appears on the display. The time may be set with the ignition on or off.

To synchronize the time with an FM station broadcasting Radio Data System (RDS) information, press and hold the hour and minute buttons at the same time for two seconds until UPDATED and the clock symbol appear on the display. If the time is not available from the station, NO UPDAT will appear on the display instead.

RDS time is broadcast once a minute. Once you have tuned to an RDS broadcast station, it may take a few minutes for your time to update.

## Radio with CD



### Playing the Radio

**PWR (Power):** Press this knob to turn the system on and off.

**VOL (Volume):** Turn this knob to increase or to decrease volume.

**AUTO VOL (Automatic Volume):** With automatic volume, your audio system will adjust automatically to make up for road and wind noise as you drive.

Set the volume at the desired level. Press this button to select LOW, MEDIUM or HIGH. AVOL will appear on the display. Each higher setting will allow for more

volume compensation at faster vehicle speeds. Then as you drive, automatic volume increases the volume as necessary to overcome noise at any speed. The volume level should always sound the same to you as you drive. NONE will appear on the display if the radio cannot determine the vehicle speed. If you don't want to use automatic volume, select OFF.

**DISP (Display):** Press this button to switch the display between the radio station frequency and the time. Time display is available with the ignition turned off.

To change the default on the display, push the knob until you see the display you want, then hold the knob for two seconds. The radio will produce one beep and selected display will now be the default.

### Finding a Station

**AM FM:** Press this button to switch between AM, FM1 and FM2. The display will show your selection.

**TUNE:** Turn this knob to choose radio stations.

**◀ SEEK ▶:** Press the right or the left arrow to seek to the next or to the previous station and stay there.

The radio will seek only to stations that are in the selected band and only to those with a strong signal.

◀ **PSCAN** ▶ (**Preset Scan**): Press and hold one of the arrows for more than two seconds. The radio will produce one beep. The radio will scan to the first preset station stored on the pushbuttons, play for a few seconds, then go on to the next station. SCAN will be displayed. Press one of the arrows again or one of the pushbuttons to stop scanning presets.

The radio will scan only to preset stations that are in the selected band only to those with a strong signal.

## Setting Preset Stations

The six numbered pushbuttons let you return to your favorite stations. You can set up to 18 stations (six AM, six FM1 and six FM2) by performing the following steps:

1. Turn the radio on.
2. Press AM FM to select AM, FM1 or FM2.
3. Tune in the desired station.
4. Press AUTO TONE to choose the bass and treble equalization that best suits the type of station you are listening to.
5. Press and hold one of the six numbered pushbuttons. The radio will produce one beep. Whenever you press that numbered pushbutton, the station you set will return and the bass and treble equalization that you selected will also be automatically selected for that pushbutton.
6. Repeat the steps for each pushbutton.

## Setting the Tone (Bass/Treble)

**AUDIO:** Press and release the AUDIO knob until BASS or TREB appears on the display. Turn the knob to increase or to decrease. The display will show the bass or treble level. If a station is weak or noisy, you may want to decrease the treble.

To adjust the bass and treble to the middle position, push and hold the AUDIO knob. The radio will produce one beep and adjust the display level to the middle position.

To adjust all tone and speaker controls to the middle position, push and hold the AUDIO knob when no tone or speaker control is displayed. The radio will produce one beep and display ALL with the level display in the middle position.

**AUTO TONE (Automatic Tone):** Press this button to choose bass and treble equalization settings designed for country/western, jazz, talk, pop, rock and classical stations.

To return the bass and treble to the manual mode, press and release the AUDIO knob.

## Adjusting the Speakers (Balance/Fade)

**AUDIO:** To adjust the balance to the right and the left speakers, push and release the AUDIO knob until BAL appears on the display. Turn the knob to move the sound toward the right or the left speakers.

To adjust the fade to the front and the rear speakers, push and release the AUDIO knob until FADE appears on the display. Turn the knob to move the sound toward the front or the rear speakers.

To adjust the balance and fade to the middle position, push the AUDIO knob then push it again and hold it until the radio produces one beep. The balance and fade will be adjusted to the middle position and the display will show the speaker balance.

To adjust all tone and speaker controls to the middle position, push and hold the AUDIO knob when no tone or speaker control is displayed. The radio will produce one beep and display ALL with the level display in the middle position.

## Using RDS

Your audio system is equipped with a Radio Data System (RDS). RDS features are available for use only on FM stations that broadcast RDS information.

Using this system, your radio can do the following:

- Seek to stations broadcasting the selected type of programming,

- receive announcements concerning local and national emergencies,
- display messages from radio stations, and
- seek to stations with traffic announcements.

This system relies upon receiving specific information from these stations and will only work when the information is available. In rare cases, a radio station may broadcast incorrect information that will cause the radio features to work improperly. If this happens, contact the radio station.

While you are tuned to an RDS station, the station name or the call letters will appear on the display, instead of the frequency. RDS stations may also provide the time of day, a program type (PTY) for current programming and the name of the program being broadcast.

**DISP (Display):** Press this knob to change what appears on the display while using RDS. The display options are station name, RDS station frequency, PTY and the name of the program (if available).

To change the default on the display, push the knob until you see the display you want, then hold the knob for two seconds. The radio will produce one beep and selected display will now be the default.

## Finding a PTY Station

To select and find a desired PTY perform the following:

1. Press the P-TYPE LIST knob. TYPE and a PTY will appear on the display.
2. Select a category by turning the P-TYPE LIST knob.
3. Once the desired category is displayed, press the SEEK TYPE button to take you to the category's first station.
4. If you want to go to another station within that category and the category is displayed, press the SEEK TYPE button once. If the category is not displayed, press the SEEK TYPE button twice to display the category and then to go to another station.

If the radio cannot find the desired program type, NONE will appear on the display and the radio will return to the last station you were listening to.

**AM FM (Alternate Frequency):** Alternate frequency allows the radio to switch to a stronger station with the same program type. Press and hold AM FM for two seconds to turn alternate frequency on. AF ON will appear on the display. The radio may switch to stronger stations. Press and hold AM FM again for two seconds to turn alternate frequency off. AF OFF will appear on the display. The radio will not switch to other stations. When you turn the ignition off and then on again, the alternate frequency feature will automatically be turned on.

## RDS Messages

**ALERT!:** Alert warns of local or national emergencies. When an alert announcement comes on the current radio station, ALERT! will appear on the display. You will hear the announcement, even if the volume is muted or a compact disc is playing. If the compact disc player is playing, play will stop during the announcement. You will not be able to turn off alert announcements.

ALERT! will not be affected by tests of the emergency broadcast system. This feature is not supported by all RDS stations.

**INFO (Information):** If the current station has a message, the information symbol will appear on the display. Press this button to see the message. The message may display the artist and song title, call in phone numbers, etc.

If the whole message is not displayed, parts of it will appear every three seconds. To scroll through the message at your own speed, press the INFO button repeatedly. A new group of words will appear on the display with each press. Once the complete message has been displayed, the information symbol will disappear from the display until another new message is received. The old message can be displayed by pressing the INFO button until a new message is received or a different station is tuned to.

When a message is not available from an station, NO INFO will be displayed.

**TRAF (Traffic):** Press this button to receive traffic announcements. If the current tuned station does not broadcast traffic announcements, the radio will seek to a station that does. When the radio finds a station that broadcasts traffic announcements, it will stop. TRAF will appear on the display and when a traffic announcement comes on you will hear it. If no station is found, NO TRAF will appear on the display.

When a traffic announcement comes on the current station or on a related network station, you will hear it, even if the volume is muted or a compact disc is playing. The traffic symbol and TRAF will appear on the display while the announcement plays. If the compact disc player was being used, play will stop during the announcement.

**Traffic Interrupt Feature:** Your radio can interrupt the play of a CD. Press the TRAF button. The radio will seek to a station that broadcasts traffic announcements. When the radio finds a station that broadcasts traffic announcements, it will stop. TRAF will appear on the display. When a traffic announcement comes on the station that was found, you will hear it. When the traffic announcement is over, the radio will resume play of the CD. If no station is found, NO TRAF will appear on the display.

## Radio Messages

**CAL ERR (Calibration Error):** This message is displayed when the radio has not been calibrated properly for the vehicle. You must return to the dealership for service.

**LOCKED:** This message is displayed when the THEFTLOCK<sup>®</sup> system has locked up. You must return to the dealership for service.

## Playing a Compact Disc

Insert a disc partway into the slot, label side up. The player will pull it in and the disc should begin playing. The display will show the CD symbol. If you want to insert a compact disc with the ignition off, first press TUNE or EJT.

If an error appears on the display, see "Compact Disc Messages" later in this section.

**1 PREV (Previous):** Press this pushbutton to go to the previous track if the current track has been playing for less than eight seconds. If pressed when the current track has been playing for more than eight seconds, it will go to the beginning of the current track. TRACK and the track number will appear on the display. If you hold this pushbutton or press it more than once, the player will continue moving back through the disc.



**2 NEXT:** Press this pushbutton to go to the next track. TRACK and the track number will appear on the display. If you hold this pushbutton or press it more than once, the player will continue moving forward through the disc.

**3 REV (Reverse):** Press and hold this pushbutton to reverse quickly within a track. Press and hold this pushbutton for less than two seconds to reverse at six times the normal playing speed. Press and hold it for more than two seconds to reverse at 17 times the normal playing speed. Release it to play the passage. The display will show ET and the elapsed time.

**4 FWD (Forward):** Press and hold this pushbutton to advance quickly within a track. Press and hold this pushbutton for less than two seconds to advance at six times the normal playing speed. Press and hold it for more than two seconds to advance at 17 times the normal playing speed. Release it to play the passage. The display will show ET and the elapsed time.

**6 RDM (Random):** Press this pushbutton to hear the tracks in random, rather than sequential, order. RDM ON will appear on the display. RDM T and the track number will appear on the display when each track starts to play. Press this pushbutton again to turn off random play. RDM OFF will appear on the display.

**◀ SEEK ▶:** Press the left arrow to go to the start of the current or to the previous track. Press the right arrow to go to the start of the next track. If either arrow is held or pressed more than once, the player will continue moving backward or forward through the CD.

**DISP (Display):** Press this knob to see how long the current track has been playing. ET and the elapsed time will appear on the display. To change the default on the display (track or elapsed time), push the knob until you see the display you want, then hold the knob for two seconds. The radio will produce one beep and selected display will now be the default.

**AM FM:** Press this button to listen to the radio when a CD is playing. The disc will stop but remain in the player.

**CD AUX (Auxiliary):** Press this button to play a CD when listening to the radio.

**△ EJT (Eject):** Press this button to eject a CD. Eject may be activated with either the ignition or radio off. CDs may be loaded with the radio and ignition off if this button is pressed first.

## Compact Disc Messages

If the disc comes out, it could be for one of the following reasons:

- You're driving on a very rough road. When the road becomes smoother, the disc should play.
- It's very hot. When the temperature returns to normal, the disc should play.
- The disc is dirty, scratched, wet or upside down.
- The air is very humid. If so, wait about an hour and try again.

If the CD is not playing correctly, for any other reason, try a known good CD.

If any error occurs repeatedly or if an error can't be corrected, contact your dealer.

## Radio with Cassette and CD



Standard Radio Shown – Bose® Similar

## Playing the Radio

**PWR (Power):** Press this knob to turn the system on and off.

**VOL (Volume):** Turn this knob to increase or to decrease volume.

**AUTO VOL (Automatic Volume):** With automatic volume, your audio system adjusts automatically to make up for road and wind noise as you drive.

Set the volume at the desired level. Press this button to select LOW, MEDIUM or HIGH. AVOL will appear on the display. Each higher setting will allow for more

volume compensation at faster vehicle speeds. Then as you drive, automatic volume increases the volume as necessary to overcome noise at any speed. The volume level should always sound the same to you as you drive. **NONE** will appear on the display if the radio cannot determine the vehicle speed. If you don't want to use automatic volume, select **OFF**.

If your vehicle has the Bose radio, your audio system monitors the noise inside your vehicle. To use automatic volume, press the **AUTO VOL** button until **AVOL ON** appears on the display. Then, automatic volume will automatically adjust the volume of your radio so that it always sounds the same to you. To turn the automatic volume off, press the **AUTO VOL** button until **AVOL OFF** appears on the display.

**DISP (Display):** Press this button to switch the display between the radio station frequency and the time. Time display is available with the ignition turned off.

To change the default on the display, push the knob until you see the display you want, then hold the knob for two seconds. The radio will produce one beep and selected display will now be the default.

## Finding a Station

**AM FM:** Press this button to switch between AM, FM1 and FM2. The display will show your selection.

**TUNE:** Turn this knob to choose radio stations.

◀ **SEEK** ▶ : Press the right or the left arrow to seek to the next or to the previous station and stay there.

The radio will seek only to stations that are in the selected band and only to those with a strong signal.

◀ **PSCAN (Preset Scan)** ▶ : Press and hold one of the arrows for more than two seconds. The radio will produce one beep. The radio will scan to the first preset station stored on the pushbuttons, play for a few seconds, then go on to the next station. **SCAN** will be displayed. Press one of the arrows again or one of the pushbuttons to stop scanning.

The radio will scan only to presets that are in the selected band and only to those with a strong signal.

## Setting Preset Stations

The six numbered pushbuttons let you return to your favorite stations. You can set up to 18 stations (six AM, six FM1 and six FM2) by performing the following steps:

1. Turn the radio on.
2. Press **AM FM** to select AM, FM1 or FM2.
3. Tune in the desired station.
4. Press **AUTO TONE** to choose the bass and treble equalization that best suits the type of station you are listening to.

5. Press and hold one of the six numbered pushbuttons. The radio will produce one beep. Whenever you press that numbered pushbutton, the station you set will return and the bass and treble equalization that you selected will also be automatically selected for that pushbutton.
6. Repeat the steps for each pushbutton.

## Setting the Tone (Bass/Treble)

**AUDIO:** Push and release the AUDIO knob until BASS or TREB appears on the display. Turn the knob to increase or to decrease. The display will show the bass or treble level. If a station is weak or noisy, you may want to decrease the treble.

To adjust the bass and treble to the middle position, push and hold the AUDIO knob. The radio will produce one beep and adjust the display level to the middle position.

To adjust all tone and speaker controls to the middle position, push and hold the AUDIO knob when no tone or speaker control is displayed. The radio will produce one beep and display ALL with the level display in the middle position.

**AUTO TONE (Automatic Tone):** Press this button to choose bass and treble equalization settings designed for country/western, jazz, talk, pop, rock and classical stations.

To return the bass and treble to the manual mode, press and release the AUDIO knob.

If your vehicle has the Bose<sup>®</sup> radio, your audio system allows you to choose from four different equalization settings: talk, driver, normal and spatial. These settings can be used while listening to the radio or the CD player. Press the AUTO TONE button to select your choice.

**TALK:** This setting makes spoken words sound very clear. When listening to non-musical material such as news, talk shows, sports broadcasts and books on tape.

**DRIVER:** This setting gives the driver the best sound quality.

**NORMAL:** This setting enhances the stereo effects.

**SPATIAL:** This setting makes the listening space seem larger.

The radio will save separate AUTO TONE settings for each preset and source.

## Adjusting the Speakers (Balance/Fade)

**AUDIO:** To adjust the balance to the right and the left speakers, push and release the AUDIO knob until BAL appears on the display. Turn the knob to move the sound toward the right or the left speakers.

To adjust the fade to the front and the rear speakers, push and release the AUDIO knob until FADE appears on the display. Turn the knob to move the sound toward the front or the rear speakers.

To adjust the balance and fade to the middle position, push the AUDIO knob then push it again and hold it until the radio produces one beep. The balance and fade will be adjusted to the middle position and the display will show the speaker balance.

To adjust all tone and speaker controls to the middle position, push and hold the AUDIO knob when no tone or speaker control is displayed. The radio will produce one beep and display ALL with the level display in the middle position.

## Using RDS

Your audio system is equipped with a Radio Data System (RDS). RDS features are available for use only on FM stations that broadcast RDS information. Using this system, the radio can do the following:

- Seek to stations broadcasting the selected type of programming,
- receive announcements concerning local and national emergencies,
- display messages from radio stations, and
- seek to stations with traffic announcements.

This system relies upon receiving specific information from these stations and will only work when the information is available. In rare cases, a radio station may broadcast incorrect information that will cause the radio features to work improperly. If this happens, contact the radio station.

While you are tuned to an RDS station, the station name or the call letters will appear on the display, instead of the frequency. RDS stations may also provide the time of day, a program type (PTY) for current programming and the name of the program being broadcast.

**DISP (Display):** Press this knob to change what appears on the display while using RDS. The display options are station name, RDS station frequency, PTY and the name of the program (if available).

To change the default on the display, push the knob until you see the display you want, then hold the knob for two seconds. The radio will produce one beep and selected display will now be the default.

## Finding a PTY Station

To select and find a desired PTY perform the following:

1. Press the P-TYPE LIST knob. TYPE and a PTY will appear on the display.
2. Select a category by turning the P-TYPE LIST knob.

3. Once the desired category is displayed, press the SEEK TYPE button to take you to the category's first station.
4. If you want to go to another station within that category and the category is displayed, press the SEEK TYPE button once. If the category is not displayed, press the SEEK TYPE button twice to display the category and then to go to another station.

If the radio cannot find the desired program type, NONE will appear on the display and the radio will return to the last station you were listening to.

**AM FM (Alternate Frequency):** Alternate frequency allows the radio to switch to a stronger station with the same program type. Press and hold AM FM for two seconds to turn alternate frequency on. AF ON will appear on the display. The radio may switch to stronger stations. Press and hold AM FM again for two seconds to turn alternate frequency off. AF OFF will appear on the display. The radio will not switch to other stations. When you turn the ignition off and then on again, the alternate frequency feature will automatically be turned on.

## RDS Messages

**ALERT!:** Alert warns of local or national emergencies. When an alert announcement comes on the current radio station, ALERT! will appear on the display.

You will hear the announcement, even if the volume is muted or a cassette tape or compact disc is playing. If the cassette tape or compact disc player is playing, play will stop during the announcement. You will not be able to turn off alert announcements.

ALERT! will not be affected by tests of the emergency broadcast system. This feature is not supported by all RDS stations.

**INFO (Information):** If the current station has a message, the information symbol will appear on the display. Press this button to see the message. The message may display the artist and song title, call in phone numbers, etc.

If the whole message is not displayed, parts of it will appear every three seconds. To scroll through the message at your own speed, press the INFO button repeatedly. A new group of words will appear on the display with each press. Once the complete message has been displayed, the information symbol will disappear from the display until another new message is received. The old message can be displayed by pressing the INFO button until a new message is received or a different station is tuned to.

When a message is not available from a station, NO INFO will be displayed.

**TRAF (Traffic):** Press this button to receive traffic announcements. If the current tuned station does not broadcast traffic announcements, the radio will seek to a station that does. When the radio finds a station that broadcasts traffic announcements, it will stop. TRAF will appear on the display and when a traffic announcement comes on you will hear it. If no station is found, NO TRAF will appear on the display.

When a traffic announcement comes on the current station or on a related network station, you will hear it, even if the volume is muted or a cassette or CD is playing. The traffic symbol and TRAF will appear on the display while the announcement plays. If the cassette, or CD player was being used, play will stop during the announcement.

**Traffic Interrupt Feature:** Your radio can interrupt the play of a cassette, or CD. Press the TRAF button. The radio will seek to a station that broadcasts traffic announcements. When the radio finds a station that broadcasts traffic announcements, it will stop. TRAF will appear on the display. When a traffic announcement comes on the station that was found, you will hear it. When the traffic announcement is over, the radio will resume play of the cassette, or CD. If no station is found, NO TRAF will appear on the display.

## Radio Messages

**CAL ERR (Calibration Error):** This message is displayed when the radio has not been calibrated properly for the vehicle. You must return to the dealership for service.

**LOCKED:** This message is displayed when the THEFTLOCK<sup>®</sup> system has locked up. You must return to the dealership for service.

## Playing a Cassette Tape

Your tape player is built to work best with tapes that are up to 30 to 45 minutes long on each side. Tapes longer than that are so thin they may not work well in this player. The longer side with the tape visible should face to the right. If the ignition is on, but the radio is off, the tape can be inserted and will begin playing. A tape symbol is shown on the display whenever a tape is inserted. If you hear nothing but a garbled sound, the tape may not be in squarely. Press EJT to remove the tape and start over.

While the tape is playing, use the VOL, AUDIO and SEEK controls just as you do for the radio. The display will show TAPE and an arrow showing which side of the tape is playing.

If you want to insert a tape while the ignition is off, first press EJT or DISP.

If an error appears on the display, see "Cassette Tape Messages" later in this section.

**1 PREV (Previous):** Your tape must have at least three seconds of silence between each selection for previous to work. Press this pushbutton to go to the previous selection on the tape if the current selection has been playing for less than three seconds. If pressed when the current selection has been playing from 3 to 13 seconds, it will go to the beginning of the previous selection or the beginning of the current selection, depending upon the position on the tape. If pressed when the current selection has been playing for more than 13 seconds, it will go to the beginning of the current selection.

SEEK and a negative number will appear on the display while the cassette player is in the previous mode. Pressing this pushbutton multiple times will increase the number of selections to be searched back, up to -9.

**2 NEXT:** Your tape must have at least three seconds of silence between each selection for next to work. Press this pushbutton to go to the next selection on the tape. If you press the pushbutton more than once, the player will continue moving forward through the tape. SEEK and a positive number will appear on the display.

**3 REV (Reverse):** Press this pushbutton to reverse the tape rapidly. Press it again to return to playing speed. The radio will play while the tape reverses. The station frequency and REV will appear on the display. You may select stations during reverse operation by using the TUNE and SEEK.

**4 FWD (Forward):** Press this pushbutton to advance quickly to another part of the tape. Press this pushbutton again to return to playing speed. The radio will play while the tape advances. The station frequency and FWD will appear on the display. You may select stations during forward operation by using TUNE and SEEK.

**5 SIDE:** Press this pushbutton to play the other side of the tape.

**◀ SEEK ▶:** The right arrow is the same as the NEXT pushbutton, and the left arrow is the same as the PREV pushbutton. If the arrow is held or pressed more than once, the player will continue moving forward or backward through the tape. SEEK and a positive or negative number will appear on the display.

**AM FM:** Press this button to listen to the radio when a tape is playing. The tape will stop but remain in the player.

**TAPE CD:** Press this button to play a tape when listening to the radio. Press this button to switch between the tape and compact disc if both are loaded. The inactive tape or CD will remain safely inside the radio for future listening.

**△ EJT (Eject):** Press this button to stop a tape when it is playing or to eject a tape when it is not playing. Eject may be activated with the radio off. Cassette tapes may be loaded with the radio off if this button is pressed first.



## Cassette Tape Messages

**CHK TAPE (Check Tape):** If CHK TAPE appears on the radio display, the tape won't play because of one of the following errors.

- The tape is tight and the player can't turn the tape hubs. Remove the tape. Hold the tape with the open end down and try to turn the right hub counterclockwise with a pencil. Turn the tape over and repeat. If the hubs do not turn easily, your tape may be damaged and should not be used in the player. Try a new tape to make sure your player is working properly.
- The tape is broken. Try a new tape.
- The tape is wrapped around the tape head. Attempt to get the cassette out. Try a new tape.

**CLEAN:** If this message appears on the display, the cassette tape player needs to be cleaned. It will still play tapes, but you should clean it as soon as possible to prevent damage to the tapes and player. See *Care of Your Cassette Tape Player* on page 3-96.

If any error occurs repeatedly or if an error can't be corrected, contact your dealer.

## Playing a Compact Disc

Insert a disc partway into the slot, label side up. The player will pull it in and the disc should begin playing. The display will show the CD symbol. If you want to insert a compact disc with the ignition off, first press DISP or EJT.

If an error appears on the display, see "Compact Disc Messages" later in this section.

**1 PREV (Previous):** Press this pushbutton to go to the previous track if the current track has been playing for less than eight seconds. If pressed when the current track has been playing for more than eight seconds, it will go to the beginning of the current track. TRACK and the track number will appear on the display. If you hold this pushbutton or press it more than once, the player will continue moving back through the disc.

**2 NEXT:** Press this pushbutton to go to the next track. TRACK and the track number will appear on the display. If you hold this pushbutton or press it more than once, the player will continue moving forward through the disc.

**3 REV (Reverse):** Press and hold this pushbutton to reverse quickly within a track. Press and hold this pushbutton for less than two seconds to reverse at six times the normal playing speed. Press and hold it for more than two seconds to reverse at 17 times the normal playing speed. Release it to play the passage. The display will show ET and the elapsed time.

**4 FWD (Forward):** Press and hold this pushbutton to advance quickly within a track. Press and hold this pushbutton for less than two seconds to advance at six times the normal playing speed. Press and hold it for more than two seconds to advance at 17 times the normal playing speed. Release it to play the passage. The display will show ET and the elapsed time.

**6 RDM (Random):** Press this pushbutton to hear the tracks in random, rather than sequential, order. RDM ON will appear on the display. RDM T and the track number will appear on the display when each track starts to play. Press this pushbutton again to turn off random play. RDM OFF will appear on the display.

**◀ SEEK ▶:** Press the left arrow to go to the start of the current or to the previous track. Press the right arrow to go to the start of the next track. If either arrow is held or pressed more than once, the player will continue moving backward or forward through the CD.

**DISP (Display):** Press this knob to see how long the current track has been playing. ET and the elapsed time will appear on the display. To change the default on the display (track or elapsed time), push the knob until you see the display you want, then hold the knob for two seconds. The radio will produce one beep and selected display will now be the default.

**AM FM:** Press this button to listen to the radio when a CD is playing. The CD will stop but remain in the player.

**TAPE CD:** Press this button to play a tape when listening to the radio. Press this button to switch between the tape and compact disc if both are loaded. The inactive tape or CD will remain safely inside the radio for future listening.

**△ EJT (Eject):** Press this button to stop a CD when it is playing or to eject a CD when it is not playing. Eject may be activated with either the ignition or radio off. CDs may be loaded with the radio and ignition off if this button is pressed first.

## Compact Disc Messages

If the disc comes out, it could be for one of the following reasons:

- You're driving on a very rough road. When the road becomes smoother the disc should play.
- It's very hot. When the temperature returns to normal, the disc should play.
- The disc is dirty, scratched, wet or upside down.
- The air is very humid. If so, wait about an hour and try again.

If the CD is not playing correctly, for any other reason, try a known good CD.

If any error occurs repeatedly or if an error can't be corrected, contact your dealer.

## Radio with Six-Disc CD



### Playing the Radio

**PWR (Power):** Push this knob to turn the system on and off.

**VOL (Volume):** Turn the knob to increase or to decrease volume.

**AUTO VOL (Automatic Volume):** Your system has a feature called automatic volume. With this feature, your audio system adjusts automatically to make up for road and wind noise as you drive.

Set the volume at the desired level. Press this button to select MIN, MED or MAX. Each higher setting will allow for more volume compensation at faster vehicle speeds. Then, as you drive, automatic volume increases the volume, as necessary, to overcome noise at any speed. The volume level should always sound the same to you as you drive. If you don't want to use automatic volume, select OFF.

**RCL (Recall):** Push this knob to switch the display between the time and the radio station frequency. Push this knob with the ignition off to display the time.

To change the default on the display, push the knob until you see the display you want, then hold the knob for two seconds. The radio will produce one beep and selected display will now be the default.

### Finding a Station

**AM FM:** Press this button to switch between AM, FM1 and FM2. The display will show your selection.

**TUNE:** Turn this knob to select radio stations.

**< SEEK >I :** Press the right or the left arrow to go to the next or to the previous station and stay there.

The radio will seek only to stations that are in the selected band and only to those with a strong signal.

**◀ SCAN ▶** : Press and hold either SCAN arrow for two seconds until SC appears on the display and you hear a beep. The radio will go to a station, play for a few seconds, then go on to the next station. Press either SCAN arrow again to stop scanning.

To scan preset stations, press and hold either SCAN arrow for more than four seconds. PRESET SCAN will appear on the display. You will hear a double beep. The radio will go to a preset station stored on your pushbuttons, play for a few seconds, then go on to the next preset station. Press either SCAN arrow again to stop scanning presets.

The radio will scan only to stations that are in the selected band and only to those with a strong signal.

## Setting Preset Stations

The six numbered pushbuttons let you return to your favorite stations. You can set up to 18 stations (six AM, six FM1 and six FM2) by performing the following steps:

1. Turn the radio on.
2. Press AM FM to select AM, FM1 or FM2.
3. Tune in the desired station.
4. Press AUTO EQ to select the equalization that best suits the type of station selected.
5. Press and hold one of the six numbered pushbuttons until you hear a beep. Whenever you press that numbered pushbutton, the station

you set will return and the equalization that you selected will also be automatically selected for that pushbutton.

6. Repeat the steps for each pushbutton.

## Setting the Tone (Bass/Treble)

**AUDIO:** Push the AUDIO knob until BASS, MID or TREB appears on the display. Turn the knob to increase or to decrease. If a station is weak or noisy, you may want to decrease the treble.

To adjust bass, midrange or treble to the middle position, select BASS, MID or TREB and push and hold the AUDIO knob. The radio will produce one beep and adjust the display level to zero.

To adjust all tone and speaker controls to the middle position, push and hold the AUDIO knob when no tone or speaker control is displayed. The radio will produce one beep and CENTERED will appear on the display.

**AUTO EQ (Automatic Equalization):** Press this button to choose between bass, midrange and treble equalization settings designed for country, jazz, talk, pop, rock and classical program types.

To return to the manual mode (CUSTOM), press the AUTO EQ button until CUSTOM appears on the display. Then you will be able to manually adjust the bass, midrange and treble using the AUDIO knob.

## Adjusting the Speakers (Balance/Fade)

**AUDIO:** To adjust the balance between the right and the left speakers, push the AUDIO knob until BAL appears on the display. Turn the knob to move the sound toward the left or the right speakers.

To adjust the fade between the front and rear speakers, push and hold the AUDIO knob until FAD appears on the display. Turn the knob to move the sound toward the front or the rear speakers.

To adjust the balance and the fade to the middle position, select balance or fade and push and hold the AUDIO knob. The radio will beep once and will adjust the display level to the middle position.

To adjust all tone and speaker controls to the middle position, push and hold the AUDIO knob when no tone or speaker controls are displayed. The radio will produce one beep and CENTERED will appear on the display.

## Using RDS

Your audio system is equipped with a Radio Data System (RDS). RDS features are available for use only on FM stations that broadcast RDS information. Using this system, the radio can do the following:

- Seek to stations broadcasting the selected type of programming,

- receive announcements concerning local and national emergencies,
- display messages from radio stations, and
- seek to stations with traffic announcements.

This system relies upon receiving specific information from these stations and will only work when the information is available. In rare cases, a radio station may broadcast incorrect information that will cause the radio features to work improperly. If this happens, contact the radio station.

While you are tuned to an RDS station, the station name or the call letters will appear on the display instead of the frequency. RDS stations may also provide the time of day, a program type (PTY) for current programming and the name of the program being broadcast.

## Finding a PTY Station

To select and find a desired PTY perform the following:

1. Press the P-TYPE button. P-TYPE and the last selected PTY will be displayed on the screen.
2. Select a category by turning the P-TYPE knob.
3. Once the desired category is displayed, press either SEEK arrow to select the category and take you to the category's first station.

4. If you want to go to another station within that category and the category is displayed, press either SEEK arrow once. If the category is not displayed, press either SEEK arrow twice to display the category and then to go to another station.
5. If PTY times out and is no longer on the display, go back to Step 1.

If both P-TYPE and TRAF are on, the radio will search for stations with the selected PTY and traffic announcements.

To use the PTY interrupt feature, press and hold the P-TYPE button until you hear a beep on the PTY you want to interrupt with. When selected, an asterisk will appear beside that PTY on the display. You may select multiple interrupts if desired. When you are listening to a compact disc, the last selected RDS station will interrupt play if that selected program type format is broadcast.

**SCAN:** You can also scan through the channels within a category by performing the following:

1. Press the P-TYPE button. P-TYPE and the last selected PTY will be displayed on the screen.
2. Select a category by turning the P-TYPE knob.
3. Once the desired category is displayed, press and hold either SCAN arrow, and the radio will begin scanning within your chosen category.
4. Press either SCAN arrow again to stop at a particular station.

**AM FM (Alternate Frequency):** Alternate frequency allows the radio to switch to a stronger station with the same program type. Press and hold AM FM for two seconds to turn alternate frequency on. AF ON will appear on the display. The radio may switch to stronger stations. Press and hold AM FM again for two seconds to turn alternate frequency off. AF OFF will appear on the display. The radio will not switch to other stations. When you turn the ignition off and then on again, the alternate frequency feature will automatically be turned on.

## Setting Preset PTYs

The six numbered pushbuttons let you return to your favorite PTYs. These buttons have factory PTY presets. You can set up to 12 PTYs (six FM1 and six FM2) by performing the following steps:

1. Press BAND to select FM1 or FM2.
2. Press the P-TYPE button to activate program type select mode.
3. Turn the P-TYPE knob to select a PTY.
4. Press and hold one of the six numbered pushbuttons until you hear a beep. Whenever you press that numbered pushbutton, the PTY you set will return.
5. Repeat the steps for each pushbutton.

## RDS Messages

**ALERT!:** Alert warns of local or national emergencies. When an alert announcement comes on the current radio station, ALERT! will appear on the display. You will hear the announcement, even if the volume is muted or a compact disc is playing. If the compact disc player is playing, play will stop during the announcement. You will not be able to turn off alert announcements.

ALERT! will not be affected by tests of the emergency broadcast system. This feature is not supported by all RDS stations.

**INFO (Information):** If the current station has a message, INFO will appear on the display. Press this button to see the message. The message may display the artist and song title, call in phone numbers, etc.

If the whole message is not displayed, parts of it will appear every three seconds. To scroll through the message at your own speed, press the INFO button repeatedly. A new group of words will appear on the display with each press. Once the complete message has been displayed, INFO will disappear from the display until another new message is received. The old message can be displayed by pressing the INFO button until a new message is received or a different station is tuned to.

**TRAF (Traffic):** TRAF will appear on the display if the tuned station broadcasts traffic announcements. To receive the traffic announcement from the tuned station, press this button. Brackets will be displayed around TRAF and when a traffic announcement comes on the tuned radio station you will hear it.

If the current tuned station does not broadcast traffic announcements, press this button and the radio will seek to a station that does. When the radio finds a station that broadcasts traffic announcements, it will stop. Brackets will be displayed around TRAF and when a traffic announcement comes on the tuned radio station you will hear it. If no station is found, NO TRAFFIC will appear on the display.

**Traffic Interrupt Feature:** Your radio can interrupt the play of a CD. Press the TRAF button. The radio will seek to a station that broadcasts traffic announcements. When the radio finds a station that broadcasts traffic announcements, it will stop. Brackets around TRAF will appear on the display. When a traffic announcement comes on the station that was found, you will hear it. When the traffic announcement is over, the radio will resume play of the CD. If no station is found, NO TRAFFIC will appear on the display.

## Playing a Compact Disc

If an error appears on the display, see “Compact Disc Messages” later in this section.

**LOAD CD**  : Press the LOAD side of this button to load CDs into the compact disc player. This compact disc player will hold up to six discs.

To insert one disc, do the following:

1. Turn the ignition on.
2. Press and release the LOAD side of the LOAD CD button.
3. Wait for the light, located to the right of the slot, to turn green.
4. Load a disc. Insert the disc partway into the slot, label side up. The player will pull the disc in.

When a disc is inserted, the CD symbol will be displayed. If you select an equalization setting for your disc, it will be activated each time you play a disc.

If the radio is on or off, the disc will begin to play automatically.

To insert multiple discs, do the following:

1. Turn the ignition on.
2. Press and hold the LOAD side of the LOAD CD button for two seconds.  
You will hear a beep and the light, located to the right of the slot, will begin to flash.

3. Once the light stops flashing and turns green, load a disc. Insert the disc partway into the slot, label side up. The player will pull the disc in.

Once the disc is loaded, the light will begin flashing again. Once the light stops flashing and turns green you can load another disc. The disc player takes up to six discs. Do not try to load more than six.

To load more than one disc but less than six, complete Steps 1 through 3. When you have finished loading discs, with the radio on or off, press the LOAD side of the LOAD CD button to cancel the loading function. The radio will begin to play the last CD loaded.

When a disc is inserted, the CD symbol will be displayed. If more than one disc has been loaded, a number for each disc will be displayed. If you select an equalization setting for your disc, it will be activated each time you play a disc.

If the radio is on or off, the last disc loaded will begin to play automatically.

As each new track starts to play, the track number will appear on the display.

## Playing a Specific Loaded Compact Disc

For every CD loaded, a number will appear on the radio display. To play a specific CD, first press the CD AUX button to start playing a CD. Then press the numbered



pushbutton that corresponds to the CD you want to play. A small bar will appear under the CD number that is playing, and the track number will appear.

If an error appears on the radio display, see "Compact Disc Messages" later in this section.

**LOAD CD  (Eject):** Pressing the CD eject side of this button will eject a single disc or multiple discs. To eject the disc that is currently playing, press and release this button. To eject multiple discs, press and hold this button for two seconds. You will hear a beep and the light will flash to let you know when a disc is being ejected.

REMOVE CD will be displayed. You can now remove the disc. If the disc is not removed, after 25 seconds, the disc will be automatically pulled back into the receiver. If you try to push the disc back into the receiver, before the 25 second time period is complete, the receiver will sense an error and will try to eject the disc several times before stopping.

Do not repeatedly press the CD eject side of the LOAD CD eject button to eject a disc after you have tried to push it in manually. The receiver's 25-second eject timer will reset at each press of eject, which will cause the receiver to not eject the disc until the 25-second time period has elapsed.

Once the player stops and the disc is ejected, remove the disc. After removing the disc, press the PWR

knob off and then on again. This will clear the disc-sensing feature and enable discs to be loaded into the player again.

**◀ REV (Reverse):** Press and hold this button to reverse quickly within a track. You will hear sound at a reduced volume. Release it to play the passage. The display will show elapsed time.

**FWD ▶▶ (Forward):** Press and hold this button to advance quickly within a track. You will hear sound at a reduced volume. Release it to play the passage. The display will show elapsed time.

**RPT (Repeat):** With repeat, you can repeat one track or an entire disc. To use repeat, do the following:

- To repeat the track you are listening to, press and release the RPT button. RPT will appear on the display. Press RPT again to turn it off.
- To repeat the disc you are listening to, press and hold the RPT button for two seconds. RPT will appear on the display. Press RPT again to turn it off.

**RDM (Random):** With random, you can listen to the tracks in random, rather than sequential, order, on one disc or on all of the discs. To use random, do one of the following:

- To play the tracks on the disc you are listening to in random order, press and hold RDM for more than two seconds. You will hear a beep and RANDOM ONE will appear on the display. Press RDM again to turn it off.
- To play the tracks on all of the discs that are loaded in random order, press and release the RDM button. RANDOM ALL will appear on the display. Press RDM again to turn it off.

**AUTO EQ (Automatic Equalization):** Press AUTO EQ to select the desired equalization setting while playing a compact disc. The equalization will be automatically set whenever you play a compact disc. For more information on AUTO EQ, see "AUTO EQ" listed previously in this section.

**◀ SEEK ▶ :** Press the left arrow to go to the start of the current track, if more than ten seconds have passed. Press the right arrow to go to the next track. If you press the button more than once, the player will continue moving backward or forward through the disc.

**◀ SCAN ▶ :** To scan one disc, press and hold either SCAN arrow for more than two seconds until SCAN appears on the display and you hear a beep. Use this feature to listen to 10 seconds of each track of the currently selected disc. SCAN will appear on the display. Press either SCAN arrow again, to stop scanning.

To scan all loaded discs, press and hold either SCAN

arrow for more than four seconds until DISC SCAN appears on the display and you hear a beep. Use this feature to listen to 10 seconds of the first tracks of each disc loaded. Press either SCAN arrow again, to stop scanning.

**RCL (Recall):** Push this knob to see how long the current track has been playing. To change the default on the display (track and elapsed time), push the knob until you see the display you want, then hold the knob until the display flashes. The selected display will now be the default.

**AM FM:** Press this button to play the radio when a disc(s) is in the player.

## Using Song List Mode

The integrated six-disc CD changer has a feature called song list. This feature is capable of saving 20 track selections.

To save tracks into the song list feature, perform the following steps:

1. Turn the disc player on and load it with at least one disc. See "LOAD CD" listed previously in this section for more information.
2. Check to see that the disc changer is not in song list mode. S-LIST should not appear in the display. If S-LIST is present, press the SONG LIST button to turn it off.

3. Select the desired disc by pressing the numbered pushbutton and then use the SEEK SCAN right arrow button to locate the track that you want to save. The track will begin to play.
4. Press and hold the SONG LIST button for two or more seconds to save the track into memory. When SONG LIST is pressed a beep will be heard immediately. After two seconds of pressing SONG LIST continuously, two beeps will sound to confirm that the track has been saved.
5. Repeat Steps 3 and 4 for saving other selections.

If you attempt to save more than 20 selections, S-LIST FULL will appear on the display.

To play the song list, press the SONG LIST button. One beep will be heard and S-LIST will appear on the display. The recorded tracks will begin to play in the order that they were saved.

You may seek through the song list by using the SEEK SCAN arrows. Seeking past the last saved track will return you to the first saved track.

To delete tracks from the song list, perform the following steps:

1. Turn the disc player on.
2. Press the SONG LIST button to turn song list on. S-LIST will appear on the display.
3. Press the SEEK SCAN arrows to select the desired track to be deleted.

4. Press and hold the SONG LIST button for two seconds. When pressing SONG LIST, one beep will be heard immediately. After two seconds of pressing the SONG LIST button continuously, two beeps will be heard to confirm that the track has been deleted.

After a track has been deleted, the remaining tracks are moved up the list. When another track is added to the song list, the track will be added to the end of the list.

To delete the entire song list, perform the following steps:

1. Turn the disc player on.
2. Press the SONG LIST button to turn song list on. S-LIST will appear on the display.
3. Press and hold the SONG LIST button for more than four seconds. A beep will be heard, followed by two beeps after two seconds and a final beep will be heard after four seconds. S-LIST EMPTY will appear on the display indicating that the song list has been deleted.

If a disc is ejected, and the song list contains saved tracks from that disc, those tracks are automatically deleted from the song list. Any tracks saved to the song list again are added to the bottom of the list.

To end song list mode, press the SONG LIST button. One beep will be heard and S-LIST will be removed from the display.

## Compact Disc Messages

**CHECK CD:** If this message appears on the radio display, it could be due to one of the following reasons:

- You're driving on a very rough road. When the road becomes smoother, the disc should play.
- The disc is dirty, scratched, wet or upside down.
- The air is very humid. If so, wait about an hour and try again.

If the CD is not playing correctly, for any other reason, try a known good CD.

If any error occurs repeatedly or if an error can't be corrected, contact your dealer. If your radio displays an error message, write it down and provide it to your dealer when reporting the problem.

## Rear Seat Entertainment System

Your vehicle may have the optional Digital Versatile Disc (DVD) entertainment system. The entertainment system includes a DVD player, a video display screen, two sets of IR (Infrared) wireless headphones, a remote control and an instructional video disc.

### Before You Drive

The video entertainment system is for passengers in the second and third row seats only. The driver cannot safely view the video screen while driving and should not try to do so.

In severe or extreme temperature conditions your entertainment system should not be operated until the temperature is within the operating range. This will keep your video components from being damaged when the temperature is below  $-4^{\circ}\text{F}$  ( $-20^{\circ}\text{C}$ ) or above  $140^{\circ}\text{F}$  ( $60^{\circ}\text{C}$ ). To resume operation, shut off the entertainment system, pull down the video screen and then heat or cool the vehicle until the temperature is within the operating range.

## Headphones

The entertainment system includes two IR wireless headphones.

Mini-headphone jacks are also provided for use with customer provided headphones.

The wireless headphones have an ON/OFF switch and a volume control. To use the headphones turn the switch to ON. An indicator light will illuminate. If the light does not illuminate, the batteries may need to be replaced. See *Battery Replacement* later in this section for more information. Switch the headphones to OFF when not in use.

If the system is shut off, or if the headphones are out of range of the IR transmitters below the overhead RSE control panel for more than three minutes, the headphones will shut off automatically to save the batteries. If you move too far forward or step out of the vehicle, the headphones will cut out.

To adjust the volume on the headphones, use the volume control.

**Notice:** Do not store the headphones in heat or direct sunlight. This could damage the headphones and would not be covered by your warranty. Keep the headphones stored in a cool place.

## Battery Replacement

To change the batteries, do the following:

1. Loosen the screw on the battery compartment door located on the left side of the headphones.
2. Replace the two AAA batteries in the compartment. Make sure that they are installed correctly.
3. Tighten the screws to close the compartment door.

If the headphones are to be stored for a long period of time, remove the batteries and keep them in a cool, dry place.

## Stereo RCA Jacks

The RCA jacks and the mini-headphone jacks are located behind the video screen on the overhead console. The RCA jacks allow you to hook up an auxiliary device such as a camcorder or a video game unit. The yellow RCA jack is used for video and the red and white RCA jacks are used for audio. You may require adapter connectors or cables to connect

your auxiliary device to the RCA jacks. Refer to the manufacturer's instructions for proper usage. The mini-headphone jacks allow you to hook up two customer provided wired headphones.

To use the auxiliary audio and video inputs on the RSE, connect an external auxiliary device such as a camcorder to the RCA jacks and turn on both the auxiliary device power and the power on the front of the RSE player. If a disc is not present in the player, the auxiliary signal will immediately be displayed on the RSE. If a disc is present when the RSE power is turned on, the player will automatically begin playing the disc and the user will need to press the AUX button on the remote control to display and/or hear the auxiliary input signals. Each press of the AUX button on the remote control will switch the system between disc and auxiliary input. The wired headphone volume control will only operate when the DVD player power is turned on and it controls both wired headphone jacks at the same time. See *Remote Control* later in this section for more information.

## Audio Speakers

Audio from the DVD player can only be heard either through the IR headphones or wired headphones (not included). The sound will not come through the vehicle's speakers.

## Video Screen

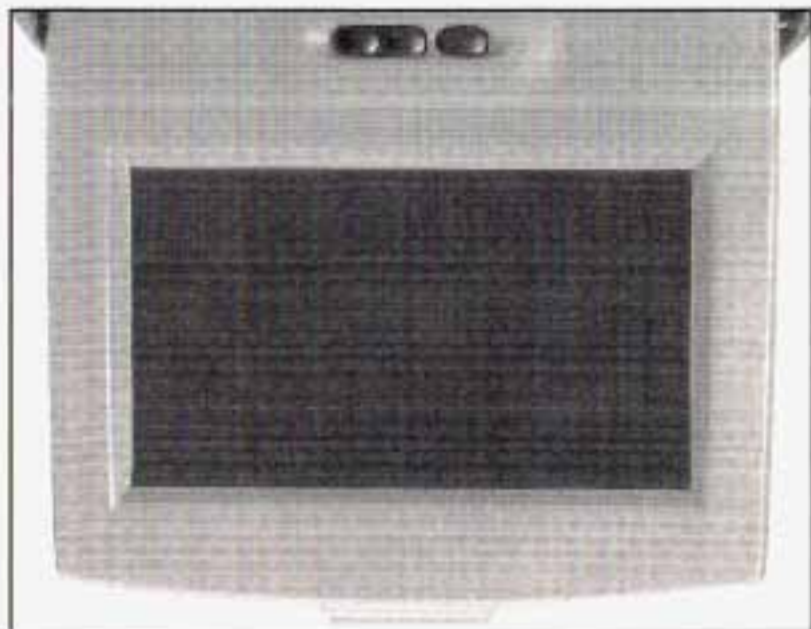

The video screen is located in the overhead console.

To use the video screen, do the following:

1. Push forward on the release button and the screen will fold down.
2. Push the screen away from you and adjust its position as desired.

When the video screen is not in use, push it up into its locked position.

The DVD player and display will continue to operate when the display is in either the up or the down position.

**Notice:** Avoid directly touching the video screen, as damage may occur. See "Cleaning the Video Screen" in the Index for more information.

## DVD Player

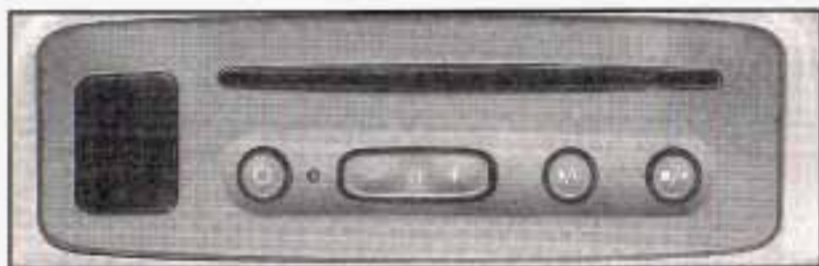

The DVD player is located in the overhead console. The DVD player can be controlled by the buttons on the DVD player and by the buttons on the remote control. See *Remote Control* later in this section for more information.

The DVD player works while the ignition is in RUN or ACCESSORY.

The entertainment system is only compatible with Region 1 DVDs authorized for use in the United States, Canada, Puerto Rico, Bermuda, the Virgin Islands and some islands in the Pacific. On some DVD jackets, you will see the region displayed. Regular audio CDs

can also be played by the DVD player. The video screen will default to off when an audio CD is played. Home recorded CDs (CDRs) may not play in this DVD player. Try the audio system's CD player instead.

If an error message appears on the front instrument panel display, see *DVD Messages* later in this section.

## DVD Player Buttons

 **PWR (Power):** Press this button to turn the DVD player on.

 **(Wired Headphone Volume):** Press the plus (+) or minus (-) symbol to increase or to decrease the wired headphone volume.

 **(Play/Pause):** Press this button to start play. Press this button while a DVD is playing to pause it. Press it again to continue playing the DVD.

 **(Stop/Eject):** Press this button to stop playing, rewinding or fast forwarding. Press the button a second time to eject the disc.

## Playing a Disc

To play a disc, gently insert the disc with the label side up into the loading slot. The DVD player will continue loading the disc and the player will automatically start.

If a disc is already in the player, press the play/pause button on the face of the player or on the remote control.

Some DVDs will not allow you to fast forward or skip the copyright or previews. Some DVDs will begin playing after the previews have finished. If the DVD does not begin playing, refer to the on-screen instructions.

## Stopping and Resume Playback

To stop a disc, press and release the stop/eject button on the DVD player or the stop button on the remote. To resume playback, press the play/pause button on the DVD player or the remote. As long as the disc has not been ejected and the stop button has not been pressed twice on the remote control, the movie should resume play from where it was last stopped. If the disc has been ejected or if the stop button on the remote has been pressed twice, the disc will resume play at the beginning.

**Parental Control Button:** This button is located on the front of the DVD console which is mounted vertically above the driver's right shoulder. Press this button while a DVD is playing to freeze the video and mute the audio to the headphones. It will also disable all other button operations from the remote and DVD player. The driver will then be able to gain the attention of the rear seat passengers. Press this button again to restore normal play of the DVD.

## Ejecting a Disc

Press the stop/eject button on the DVD player once to stop and a second time to eject the disc.

If a disc is ejected from the player, but not removed, the DVD player will reload the disc after approximately 10 to 20 seconds.

## DVD Messages

The following errors may be displayed:

- **Disc Format Error:** This message will be displayed if a disc is inserted upside down, if the disc is not able to be read or if the disc format is not compatible.
- **Disc Play Error:** This message will be displayed if the mechanism can not play the disc. Severely scratched discs will cause this error.
- **Region Code Error:** This message will be displayed for all non Region 1 discs (DVDs sold outside of North America).
- **Load/Eject Error:** This message will be displayed if the disc is not properly lined up in the mechanism.
- **Disc Not Present:** This message will be displayed if the PLAY, EJECT or DVD AUX buttons are pressed and no disc is in the player.

## Remote Control

To use the remote control, aim it at the small square window to the left of the disc slot and press the desired button. Direct sunlight or very bright light may affect the ability of the entertainment system to receive signals from the remote control. Be sure the remote's batteries are not discharged, as this will also affect the function of the remote control. Objects blocking the line of sight may also affect the function of the remote control.

**Notice:** Do not store the remote control in heat or direct sunlight. This could damage the remote control and would not be covered by your warranty. Keep the remote control stored in a cool, dry place.



## Remote Control Buttons

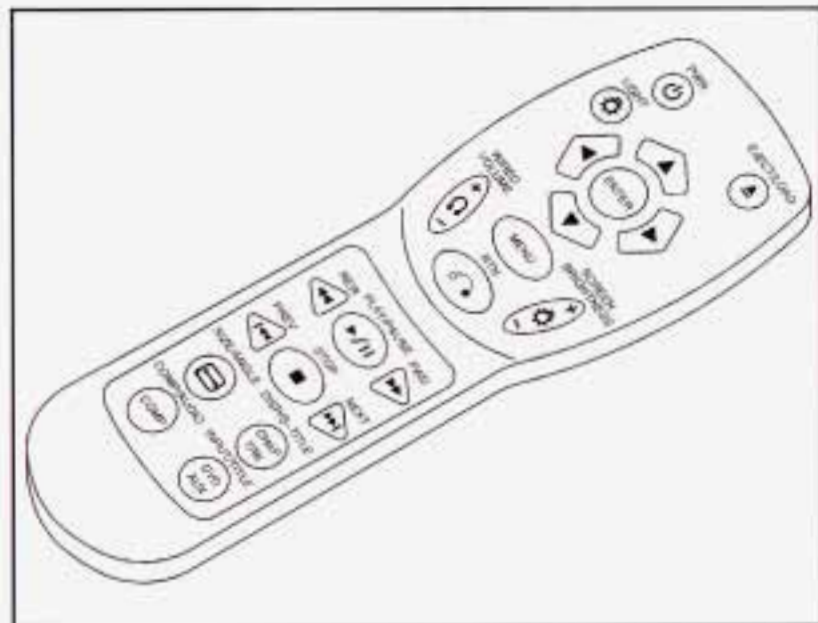

**PWR (Power):** Press this button to turn the DVD player on or off.

**▶/|| PLAY/PAUSE:** Press this button to play a disc. Press this button while a disc is playing to pause. Press it again to continue playing.

**■ STOP:** Press this button to stop playing, reversing or fast forwarding the DVD.

**▲ EJECT/LOAD:** Press this button to eject a DVD while it is playing. If the disc has been ejected and not removed from the player, pressing this button will load the disc. The stop/eject button on the DVD player will also load the disc if the disc is ejected and not removed.

**◀◀ REW (Rewind):** Press this button to reverse the DVD at 5x speed. To stop reversing, press this button again. This button may not work when the DVD is playing the copyright or the previews.

**▶▶ FWD (Fast Forward):** Press this button to fast forward the DVD at 5x speed. To stop fast forwarding, press this button again. This button may not work when the DVD is playing the copyright or the previews.

**◀◀ PREV (Previous):** Press this button to return to the start of the current chapter. Press this button again to return to the previous chapter. This button may not work when the DVD is playing the copyright or the previews.

**▶▶ NEXT:** Press this button to jump to the beginning of the next chapter. This button may not work when the DVD is playing the copyright or the previews.

**MENU:** Press this button to view the media menu. The media menu is different on every disc. Use the up and down and the right and the left arrow buttons to move the cursor around the media menu. After making your selection, press the ENTER button. Some discs may contain a short skit leading up to the media menu.

 **WIRED VOLUME:** Press the plus or the minus symbol to increase or to decrease the volume of the wired headphones. You can press repeatedly or press and hold the plus or the minus symbol to increase or to decrease the volume in large amounts.

 **SIZE/ANGLE:** This button controls the screen ratio of the video display. Press and release this button to stretch a 4:3 picture to fit the wide aspect ratio 16:9 screen.

Press and release this button to choose different angles of the same scene. Press and hold this button again to change angles. This feature is not available on all DVD discs.

**DISP/S-TITLE (Display Subtitle) CHAP TRK (Chapter Track):** Press and release this button to display the title, chapter and elapsed time of the current video segment or the track and time if a CD is being played.

Press and hold this button to see the DVDs subtitle language. Press and release this button again to change it. This feature is not available on all DVD discs.

**COMP/AUDIO (Compression) COMP:** Press and release this button to display the current compression displayed on the screen. Press this button again to select the next compression state. Three compression states are available including minimum, standard and off. The compression feature only functions on AC3 (Dolby<sup>®</sup> Digital Surround) encoded DVD video discs.

Press and hold this button to see if the DVD playing has optional audio tracks, such as different languages or commentaries. Press and release to change selections.

**INPUT/TITLE DVD AUX (Auxiliary):** Press and release this button to switch between the auxiliary input device and the DVD player.

Press and hold this button to see a display of the DVD's titles. Press and release to change the titles available.

 **RTN (Return):** When a DVD menu is active and this button is pressed, the selected option will be disabled. This button could have different functions with different discs.

 **SCREEN BRIGHTNESS:** Press the plus or the minus symbol to increase or to decrease the brightness of the screen. This button can also be found on the video screen.

 **LIGHT:** Press this button to illuminate the keypad for about eight seconds.

## Setup Menu

To access the setup menu, ensure a DVD is in the player and the video is in stop mode. Press the menu key. Once the menu is activated, use the UP, DOWN, RIGHT, LEFT, and Enter buttons to navigate the screen.

The setup menu allows the user to select default preferences for Menu Language, Subtitle Language, Audio Language, TV Aspect, TV Mode, and Dynamic Range Compression.

Not all DVDs support all the feature defaults in the setup menus. In the event a particular feature is not supported, defaults will be provided by the DVD media.

Exit the setup menu by pressing the RETURN button on the remote control. If you make changes to the system setup defaults, the disc will resume play from the beginning and not where it previously left off.

## Battery Replacement

To change the batteries, do the following:

1. Unclip the battery door located on the back of the remote control.
2. Replace the two AAA batteries in the compartment. Make sure that they are installed correctly.
3. Close the battery door securely.

If the remote control is to be stored for a long period of time, remove the batteries and keep them in a cool, dry place.

Problem	Recommended Action
No power.	The ignition might be off. The parental control button might have been pressed. (The power LED will flash.)
Disc will not play.	The Input/Title on the remote might be set for auxiliary. The disc is upside down or is not compatible.
No sound.	The volume on the headphones could be too low. Adjust it on the wired headphones on the front panel or the remote. For the wireless headphones, adjust the dial on the right earpiece on the headphones.
The picture is distorted during fast forward or fast reverse.	This is normal for this operation.

<b>Problem</b>	<b>Recommended Action</b>
The picture does not fill the screen. There are black borders on the top and bottom or on both sides or it looks stretched out.	Quickly press and release the SIZE/ANGLE button on the remote. This will fill the screen. If the screen looks stretched out, press and release the SIZE/ANGLE button again. If there are borders on the top and bottom, the movie may have been made that way for a standard screen. Pressing the SIZE/ANGLE button should fill the sides.
I ejected the disc and tried to take it out, but it was pulled back into the slot.	Eject the disc again.
The language in the audio or on the screen is wrong.	Press and hold the COMP/AUDIO button on the remote. This will access the DVD's main menu. Then follow the prompts.

<b>Problem</b>	<b>Recommended Action</b>
The remote does not work.	Point the remote directly at the player, but not the screen. The batteries could be dead or put in wrong. If the power button on the player is flashing, the parental control is on, which disables the remote.
I can not hear anything when I lower the volume.	Quickly press and release the COMP/AUDIO button on the remote. This tells you the current default setting. Press and release the COMP/AUDIO button again to choose another setting.
How do I get subtitles on or off?	Press and hold the DISP/S-TITLE buttons on the remote to go to the DVD's main menu. Then follow the prompts.

<b>Problem</b>	<b>Recommended Action</b>
After stopping the player, I push PLAY but sometimes the DVD starts where I left off and sometimes at the beginning.	Press the STOP button on the remote to resume where the DVD left off. Press the STOP button twice to start the DVD at the beginning. If the power is off and the DVD is still in the player, press and release the PLAY button.
The DVD is playing but there is no picture or sound. The auxiliary medium (video game, camcorder, etc.) is running but there is no picture or sound.	Press the INPUT/TITLE button on the remote to get to auxiliary input. The auxiliary medium's cords could be plugged into the wrong jack.
The audio or video skips or jumps.	The DVD could be dirty or scratched. Try cleaning the DVD.

<b>Problem</b>	<b>Recommended Action</b>
When I return to the DVD from the system menu, sometimes it plays from the beginning and sometimes from where it left off.	If the STOP button was pressed once, it resumes play from where it left off. If the STOP button was pressed twice, it will start at the beginning of the DVD. However, if a change was made to the menu, the DVD will start from the beginning, even if the STOP button was only pressed once.
The fast forward, fast reverse, previous and next functions do not work.	Some commands that do one thing for DVDs will not always work or perform the same function for audio, CDs or games.
My disc is stuck in the player. The EJECT/LOAD button does not work.	Press the EJECT/LOAD button on the remote, or the STOP/EJECT button on the DVD player. Turn the power off, then on again. Do not attempt to forcibly remove the disc from the player.
I lost the remote and/or the headphones.	See your dealer for assistance.

Problem	Recommended Action
What is the best way to clean the screen?	Pour some isopropyl or rubbing alcohol on a clean cloth and wipe.
Sometimes the wireless headphone audio cuts out or buzzes for a moment then it comes back.	This could be caused by interference from cell towers or by using your cell phone in the vehicle.

## Rear Seat Audio (RSA)

This feature allows rear seat passengers to listen to any of the music sources: radio, cassette tapes or CDs. The rear seat passengers can only control the music sources that the front seat passengers are not listening to. For example, rear seat passengers may listen to a cassette tape or CD through headphones while the driver listens to the radio through the front speakers. The rear seat passengers have control of the volume for each set of headphones. The front seat audio controls always override the rear seat audio controls.



TrailBlazer Shown, TrailBlazer EXT Similar

**PWR (Power):** Press this button to turn the rear seat audio system on or off. The rear speakers will be muted when the power is turned on unless you have a Bose® equipped vehicle. You may operate the rear seat audio functions even when the primary radio power is off.

**VOL (Volume):** Turn the knob clockwise to increase volume and counterclockwise to decrease volume. The left VOL knob controls the left headphone and the right VOL knob controls the right headphone.

**PROG (Program):** Press this button to switch between playing a cassette tape or a CD and listening to the radio. The inactive tape or CD will remain safely inside the radio for future listening.

**SEEK:** Press the SEEK button to seek to the next station and stay there. The display will show your selection.

To scan preset stations, press and hold the SEEK button. The radio will scan to a preset station, play for a few seconds, then go the next preset station. The display will show your selections. The SEEK button is inactive if the front radio is in use.

While listening to a cassette tape, press the SEEK button to hear the next selection on the tape. Press and hold the SEEK button to go to the other side of the tape. The SEEK button is inactive if the tape mode on the front radio is in use.

While listening to a CD, press the SEEK button to hear the next track on the CD. The SEEK button is inactive if the CD mode on the front radio or the CD changer is in use.

## Radio Personalization

If your vehicle has this feature, it allows the driver to return to the last used audio source (radio, cassette or CD) using the remote keyless entry transmitter. This feature can also store and recall AM and FM presets, volume, tone and the last selected radio station. The number on the back of each transmitter (1 or 2) corresponds to driver 1 or 2. If transmitter 1 is used to enter the vehicle, the last used audio source and/or settings set by driver 1 will be recalled. If transmitter 2 is used to enter the vehicle, the last used audio source and/or settings set by driver 2 will be recalled.

## Theft-Deterrent Feature (RDS Radios)

THEFTLOCK<sup>®</sup> is designed to discourage theft of your radio. The feature works automatically by learning a portion of the Vehicle Identification Number (VIN). If the radio is moved to a different vehicle, it will not operate and LOCKED will be displayed.

When the radio and vehicle are turned off, the blinking red light indicates that THEFTLOCK<sup>®</sup> is armed.

With THEFTLOCK<sup>®</sup> activated, your radio will not operate if stolen.

## Audio Steering Wheel Controls



If your vehicle has this feature, certain radio functions can be operated by using the controls on your steering wheel.

**AM/FM:** Press this button to switch between AM, FM1 and FM2. When playing a cassette tape or compact disc, press this button to listen to the radio.

 **(Program):** Press this button to tune to the next preset radio station. When playing a cassette tape, press this button to play the other side of the tape. When using the CD changer, this button will seek to the next track.

 **(Volume):** Press the up or the down arrow to increase or to decrease volume.

## DVD Distortion

You may experience audio distortion in the IR headphones when operating cellular phones, scanners, CB radios, Global Positioning Systems (GPS)\*, two-way radios, mobile fax, or walkie talkies.

It may be necessary to turn off the DVD player when operating one of these devices in or near the vehicle.

\* Excludes the OnStar<sup>®</sup> System.

## Understanding Radio Reception

### AM

The range for most AM stations is greater than for FM, especially at night. The longer range, however, can cause stations to interfere with each other. AM can pick up noise from things like storms and power lines. Try reducing the treble to reduce this noise if you ever get it.

### FM

FM stereo will give you the best sound, but FM signals will reach only about 10 to 40 miles (16 to 65 km). Tall buildings or hills can interfere with FM signals, causing the sound to come and go.



## Care of Your Cassette Tape Player

A tape player that is not cleaned regularly can cause reduced sound quality, ruined cassettes or a damaged mechanism. Cassette tapes should be stored in their cases away from contaminants, direct sunlight and extreme heat. If they aren't, they may not operate properly or may cause failure of the tape player.

Your tape player should be cleaned regularly after every 50 hours of use. Your radio may display CLEAN to indicate that you have used your tape player for 50 hours without resetting the tape clean timer. If this message appears on the display, your cassette tape player needs to be cleaned. It will still play tapes, but you should clean it as soon as possible to prevent damage to your tapes and player. If you notice a reduction in sound quality, try a known good cassette to see if the tape or the tape player is at fault. If this other cassette has no improvement in sound quality, clean the tape player.

For best results, use a scrubbing action, non-abrasive cleaning cassette with pads which scrub the tape head as the hubs of the cleaner cassette turn. The recommended cleaning cassette is available through your dealership.

The broken tape detection feature of your cassette tape player may identify the cleaning cassette as a damaged tape, in error. To prevent the cleaning cassette from being ejected, use the following steps:

1. Turn the ignition on.
2. Turn the radio off.
3. Press and hold the TAPE CD button for five seconds. READY will appear on the display and a cassette symbol will flash for five seconds.
4. Insert the scrubbing action cleaning cassette.
5. Eject the cleaning cassette after the manufacturer's recommended cleaning time.

After the cleaning cassette is ejected, the broken tape detection feature will be active again.

You may also choose a non-scrubbing action, wet-type cleaner which uses a cassette with a fabric belt to clean the tape head. This type of cleaning cassette will not eject on its own. A non-scrubbing action cleaner may not clean as thoroughly as the scrubbing type cleaner. The use of a non-scrubbing action, dry-type cleaning cassette is not recommended.

After you clean the player, press and hold the EJT button for five seconds to reset the CLEAN indicator. The radio will display CLEANED to show the indicator was reset.

Cassettes are subject to wear and the sound quality may degrade over time. Always make sure the cassette tape is in good condition before you have your tape player serviced.

## Care of Your CDs and DVDs

Handle discs carefully. Store them in their original cases or other protective cases and away from direct sunlight and dust. If the surface of a disc is soiled, dampen a clean, soft cloth in a mild, neutral detergent solution and clean it, wiping from the center to the edge.

Be sure never to touch the side without writing when handling discs. Pick up discs by grasping the outer edges or the edge of the hole and the outer edge.

## Care of Your CD and DVD Player

The use of CD lens cleaner discs is not advised, due to the risk of contaminating the lens of the CD optics with lubricants internal to the CD mechanism.

## Cleaning the Video Screen

Pour some isopropyl or rubbing alcohol on a clean cloth and gently wipe the video screen. Do not spray directly onto the screen and do not press too hard or too long on the video screen.

## Fixed Mast Antenna

The fixed mast antenna can withstand most car washes without being damaged. If the mast should ever become slightly bent, you can straighten it out by hand. If the mast is badly bent, as it might be by vandals, you should replace it.

Check occasionally to be sure the mast is still tightened to the fender. If tightening is required, tighten by hand, then with a wrench one quarter turn.

## Chime Level Adjustment

The volume level of the vehicle's chimes can be controlled by the radio. To change the volume level, press and hold pushbutton 6 with the ignition on and the radio power off. The chime volume level will change from the normal level to loud, and LOUD will be displayed on the radio. To change back to the default or normal setting, press and hold pushbutton 6 again. The chime level will change from the loud level to normal, and NORMAL will be displayed.



## Section 4 Driving Your Vehicle

---

<b>Your Driving, the Road, and Your Vehicle</b> .....	4-2	Driving in Rain and on Wet Roads .....	4-27
Defensive Driving .....	4-2	City Driving .....	4-30
Drunken Driving .....	4-2	Freeway Driving .....	4-31
Control of a Vehicle .....	4-5	Before Leaving on a Long Trip .....	4-32
Braking .....	4-5	Highway Hypnosis .....	4-33
Traction Assist System (TAS) .....	4-8	Hill and Mountain Roads .....	4-33
Locking Rear Axle .....	4-9	Winter Driving .....	4-35
Steering .....	4-9	If You Are Stuck: In Sand, Mud, Ice or Snow .....	4-39
Off-Road Recovery .....	4-11	<b>Towing</b> .....	4-42
Passing .....	4-12	Towing Your Vehicle .....	4-42
Loss of Control .....	4-13	Recreational Vehicle Towing .....	4-42
Off-Road Driving with Your Four-Wheel-Drive Vehicle .....	4-14	Loading Your Vehicle .....	4-45
Driving at Night .....	4-26	Adding a Snow Plow or Similar Equipment .....	4-46
		Towing a Trailer .....	4-47

# Your Driving, the Road, and Your Vehicle

## Defensive Driving

The best advice anyone can give about driving is: Drive defensively.

Please start with a very important safety device in your vehicle: Buckle up. See *Safety Belts: They Are for Everyone* on page 1-9.

Defensive driving really means “be ready for anything.” On city streets, rural roads or freeways, it means “always expect the unexpected.”

Assume that pedestrians or other drivers are going to be careless and make mistakes. Anticipate what they might do. Be ready for their mistakes.

Rear-end collisions are about the most preventable of accidents. Yet they are common. Allow enough following distance. It's the best defensive driving maneuver, in both city and rural driving. You never know when the vehicle in front of you is going to brake or turn suddenly.

Defensive driving requires that a driver concentrate on the driving task. Anything that distracts from the driving task — such as concentrating on a cellular telephone call, reading, or reaching for something on the floor — makes proper defensive driving more difficult

and can even cause a collision, with resulting injury. Ask a passenger to help do things like this, or pull off the road in a safe place to do them yourself. These simple defensive driving techniques could save your life.

## Drunken Driving

Death and injury associated with drinking and driving is a national tragedy. It's the number one contributor to the highway death toll, claiming thousands of victims every year.

Alcohol affects four things that anyone needs to drive a vehicle:

- Judgment
- Muscular Coordination
- Vision
- Attentiveness.

Police records show that almost half of all motor vehicle-related deaths involve alcohol. In most cases, these deaths are the result of someone who was drinking and driving. In recent years, more than 16,000 annual motor vehicle-related deaths have been associated with the use of alcohol, with more than 300,000 people injured.

Many adults — by some estimates, nearly half the adult population — choose never to drink alcohol, so they never drive after drinking. For persons under 21,

it's against the law in every U.S. state to drink alcohol. There are good medical, psychological and developmental reasons for these laws.

The obvious way to eliminate the leading highway safety problem is for people never to drink alcohol and then drive. But what if people do? How much is "too much" if someone plans to drive? It's a lot less than many might think. Although it depends on each person and situation, here is some general information on the problem.

The Blood Alcohol Concentration (BAC) of someone who is drinking depends upon four things:

- The amount of alcohol consumed
- The drinker's body weight
- The amount of food that is consumed before and during drinking
- The length of time it has taken the drinker to consume the alcohol.

According to the American Medical Association, a 180 lb (82 kg) person who drinks three 12 ounce (355 ml) bottles of beer in an hour will end up with a BAC of about 0.06 percent. The person would reach the same BAC by drinking three 4 ounce (120 ml) glasses of wine or three mixed drinks if each had 1 – 1/2 ounces (45 ml) of a liquor like whiskey, gin or vodka.

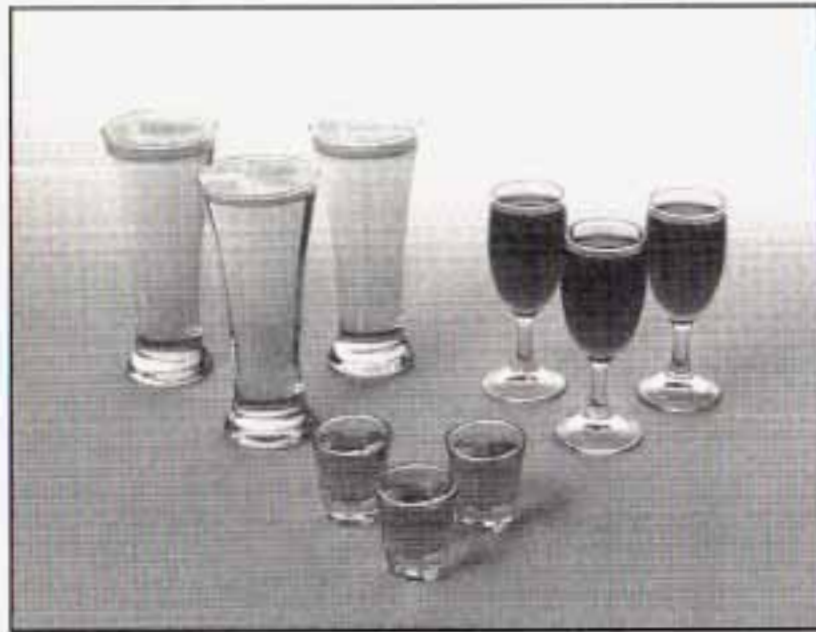

It's the amount of alcohol that counts. For example, if the same person drank three double martinis (3 ounces or 90 ml of liquor each) within an hour, the person's BAC would be close to 0.12 percent. A person who consumes food just before or during drinking will have a somewhat lower BAC level.

There is a gender difference, too. Women generally have a lower relative percentage of body water than men. Since alcohol is carried in body water, this

means that a woman generally will reach a higher BAC level than a man of her same body weight when each has the same number of drinks.

The law in an increasing number of U.S. states, and throughout Canada, sets the legal limit at 0.08 percent. In some other countries, the limit is even lower. For example, it is 0.05 percent in both France and Germany. The BAC limit for all commercial drivers in the United States is 0.04 percent.

The BAC will be over 0.10 percent after three to six drinks (in one hour). Of course, as we've seen, it depends on how much alcohol is in the drinks, and how quickly the person drinks them.

But the ability to drive is affected well below a BAC of 0.10 percent. Research shows that the driving skills of many people are impaired at a BAC approaching 0.05 percent, and that the effects are worse at night. All drivers are impaired at BAC levels above 0.05 percent. Statistics show that the chance of being in a collision increases sharply for drivers who have a BAC of 0.05 percent or above. A driver with a BAC level of 0.06 percent has doubled his or her chance of having a collision. At a BAC level of 0.10 percent, the chance of this driver having a collision is 12 times greater; at a level of 0.15 percent, the chance is 25 times greater!

The body takes about an hour to rid itself of the alcohol in one drink. No amount of coffee or number of cold showers will speed that up. "I'll be careful" isn't the right answer. What if there's an emergency, a need to

take sudden action, as when a child darts into the street? A person with even a moderate BAC might not be able to react quickly enough to avoid the collision.

There's something else about drinking and driving that many people don't know. Medical research shows that alcohol in a person's system can make crash injuries worse, especially injuries to the brain, spinal cord or heart. This means that when anyone who has been drinking — driver or passenger — is in a crash, that person's chance of being killed or permanently disabled is higher than if the person had not been drinking.

 **CAUTION:**

**Drinking and then driving is very dangerous. Your reflexes, perceptions, attentiveness and judgement can be affected by even a small amount of alcohol. You can have a serious—or even fatal—collision if you drive after drinking. Please don't drink and drive or ride with a driver who has been drinking. Ride home in a cab; or if you're with a group, designate a driver who will not drink.**

## Control of a Vehicle

You have three systems that make your vehicle go where you want it to go. They are the brakes, the steering and the accelerator. All three systems have to do their work at the places where the tires meet the road.

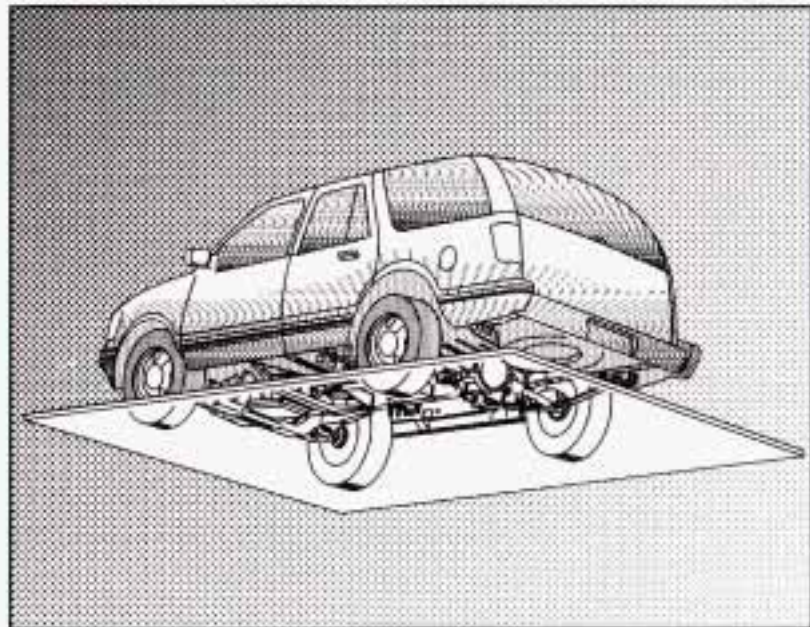

Sometimes, as when you're driving on snow or ice, it's easy to ask more of those control systems than the tires and road can provide. That means you can lose control of your vehicle.

## Braking

Braking action involves *perception time* and *reaction time*.

First, you have to decide to push on the brake pedal. That's *perception time*. Then you have to bring up your foot and do it. That's *reaction time*.

Average *reaction time* is about  $\frac{3}{4}$  of a second. But that's only an average. It might be less with one driver and as long as two or three seconds or more with another. Age, physical condition, alertness, coordination and eyesight all play a part. So do alcohol, drugs and frustration. But even in  $\frac{3}{4}$  of a second, a vehicle moving at 60 mph (100 km/h) travels 66 feet (20 m). That could be a lot of distance in an emergency, so keeping enough space between your vehicle and others is important.

And, of course, actual stopping distances vary greatly with the surface of the road (whether it's pavement or gravel); the condition of the road (wet, dry, icy); tire tread; the condition of your brakes; the weight of the vehicle and the amount of brake force applied.

Avoid needless heavy braking. Some people drive in spurts — heavy acceleration followed by heavy braking — rather than keeping pace with traffic. This is a mistake. Your brakes may not have time to cool between hard stops. Your brakes will wear out much faster if you do a lot of heavy braking. If you keep pace



with the traffic and allow realistic following distances, you will eliminate a lot of unnecessary braking. That means better braking and longer brake life.

If your engine ever stops while you're driving, brake normally but don't pump your brakes. If you do, the pedal may get harder to push down. If your engine stops, you will still have some power brake assist. But you will use it when you brake. Once the power assist is used up, it may take longer to stop and the brake pedal will be harder to push.

## Anti-lock Brake System

Your vehicle has anti-lock brakes. ABS is an advanced electronic braking system that will help prevent a braking skid.

When you start your engine and begin to drive away, your anti-lock brake system will check itself. You may hear a momentary motor or clicking noise while this test is going on. This is normal.



If there's a problem with the anti-lock brake system, this warning light will stay on. See *Anti-Lock Brake System Warning Light* on page 3-38.

Along with ABS, your vehicle has a Dynamic Rear Proportioning (DRP) system. If there's a DRP problem, both the brake and ABS warning lights will come on accompanied by a 10-second chime. The lights and chime will come on each time the ignition is turned on until the problem is repaired. See your dealer for service.

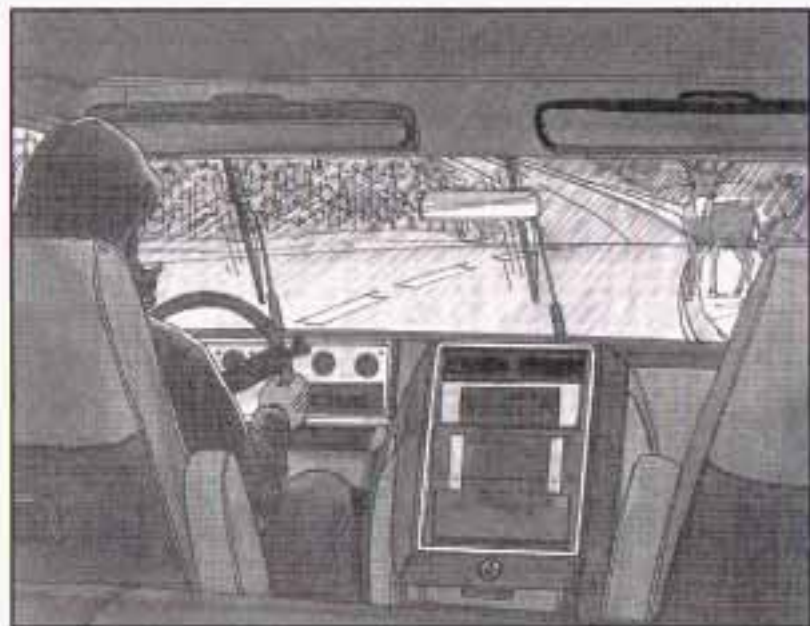

Let's say the road is wet and you're driving safely. Suddenly, an animal jumps out in front of you. You slam on the brakes and continue braking. Here's what happens with ABS:

A computer senses that wheels are slowing down. If one of the wheels is about to stop rolling, the computer will separately work the brakes at each front wheel and at both rear wheels.

The anti-lock system can change the brake pressure faster than any driver could. The computer is programmed to make the most of available tire and road conditions. This can help you steer around the obstacle while braking hard.



As you brake, your computer keeps receiving updates on wheel speed and controls braking pressure accordingly.

Remember: Anti-lock doesn't change the time you need to get your foot up to the brake pedal or always decrease stopping distance. If you get too close to the vehicle in front of you, you won't have time to apply your brakes if that vehicle suddenly slows or stops. Always leave enough room up ahead to stop, even though you have anti-lock brakes.

### **Using Anti-Lock**

Don't pump the brakes. Just hold the brake pedal down firmly and let anti-lock work for you. You may feel the brakes vibrate, or you may notice some noise, but this is normal.

### **Braking in Emergencies**

With anti-lock, you can steer and brake at the same time. In many emergencies, steering can help you more than even the very best braking.

## Traction Assist System (TAS)

Your vehicle may have a Traction Assist System (TAS) that limits wheel spin. This is especially useful in slippery road conditions. The system operates only if it senses that one or both of the rear wheels are spinning or beginning to lose traction. When this happens, the system reduces engine power to limit wheel spin.

The LOW TRAC light next to the button will come on when the TAS is limiting wheel spin. You may feel or hear the system working, but this is normal.

The Traction Assist System may operate on dry roads under some conditions. When this happens, you may notice a reduction in acceleration. This is normal and doesn't mean there's a problem with your vehicle. Examples of these conditions include a hard acceleration in a turn, an abrupt upshift or downshift of the transmission or driving on rough roads.

If your vehicle is in cruise control when the TAS begins to limit wheel spin, the cruise control will automatically disengage. When road conditions allow you to safely use it again, you may re-engage the cruise control. See *Cruise Control Light on page 3-43*. When the TRAC OFF light on the button is on, the TAS is off and will not limit wheel spin. Adjust your driving accordingly.

The TRAC OFF light on the button will come on under the following conditions:

- The Traction Assist System is turned off, either by pressing the TAS on/off button or by turning off the automatic engagement feature of the TAS.
- The transmission is in FIRST (1) gear; TAS will not operate in this gear. This is normal.
- The vehicle is driven on an extremely rough road. When the vehicle leaves the rough surface, slows down or stops, the light will go off and TAS will be on again. This is normal.
- A Traction Assist System, Anti-Lock Brake System or engine-related problem has been detected and the vehicle needs service.

The Traction Assist System, as delivered from the factory, will automatically come on whenever you start your vehicle. To limit wheel spin, especially in slippery road conditions, you should always leave the system on. But you can turn the TAS off if you ever need to. You should turn the TAS off if your vehicle ever gets stuck in sand, mud or snow and rocking the vehicle is required.



To turn the system on or off, press the TAS OFF/ON button located near the shift lever. If you used the button to turn the system off, the TRAC OFF light on the button will come on and stay on.

You can turn the system back on at any time by pressing the button again. The TRAC OFF light on the button should go off.

If desired, you can change the TAS automatic engagement feature so that the system will not come on automatically when the engine is started. To do so:

1. Park the vehicle with the ignition off and the transmission in PARK (P).
2. Turn the ignition to RUN; do not start the engine.
3. Apply the brake pedal, press the accelerator pedal to the floor and then press the TAS OFF/ON button and hold it down for at least six seconds.
4. Release the TAS button and both pedals.
5. Turn off the ignition and wait a few seconds.

The next time you start your vehicle, the TAS will not automatically come on. You can restore the automatic feature by using the same procedure. Whether the TAS is set to come on automatically or not, you can always turn the system on or off by pressing the TAS on/off button.

## Locking Rear Axle

If your vehicle has this feature, your locking rear axle can give you additional traction on snow, mud, ice, sand or gravel. It works like a standard axle most of the time, but when one of the rear wheels has no traction and the other does, this feature will allow the wheel with traction to move the vehicle.

## Steering

### Power Steering

If you lose power steering assist because the engine stops or the system is not functioning, you can steer but it will take much more effort.

## Steering Tips

### Driving on Curves

It's important to take curves at a reasonable speed.

A lot of the "driver lost control" accidents mentioned on the news happen on curves. Here's why:

Experienced driver or beginner, each of us is subject to the same laws of physics when driving on curves. The traction of the tires against the road surface makes it possible for the vehicle to change its path when you turn the front wheels. If there's no traction, inertia will keep the vehicle going in the same direction. If you've ever tried to steer a vehicle on wet ice, you'll understand this.

The traction you can get in a curve depends on the condition of your tires and the road surface, the angle at which the curve is banked, and your speed. While you're in a curve, speed is the one factor you can control.

Suppose you're steering through a sharp curve. Then you suddenly accelerate. Both control systems — steering and acceleration — have to do their work where the tires meet the road. Adding the sudden acceleration can demand too much of those places. You can lose control. See *Traction Assist System (TAS) on page 4-8*.

What should you do if this ever happens? Ease up on the accelerator pedal, steer the vehicle the way you want it to go, and slow down.

Speed limit signs near curves warn that you should adjust your speed. Of course, the posted speeds are based on good weather and road conditions. Under less favorable conditions you'll want to go slower.

If you need to reduce your speed as you approach a curve, do it before you enter the curve, while your front wheels are straight ahead.

Try to adjust your speed so you can "drive" through the curve. Maintain a reasonable, steady speed. Wait to accelerate until you are out of the curve, and then accelerate gently into the straightaway.

## Steering in Emergencies

There are times when steering can be more effective than braking. For example, you come over a hill and find a truck stopped in your lane, or a car suddenly pulls out from nowhere, or a child darts out from between parked cars and stops right in front of you. You can avoid these problems by braking — if you can stop in time. But sometimes you can't; there isn't room. That's the time for evasive action — steering around the problem.

Your vehicle can perform very well in emergencies like these. First apply your brakes.

See *Braking on page 4-5*. It is better to remove as much speed as you can from a possible collision. Then steer around the problem, to the left or right depending on the space available.



An emergency like this requires close attention and a quick decision. If you are holding the steering wheel at the recommended 9 and 3 o'clock positions, you can turn it a full 180 degrees very quickly without removing either hand. But you have to act fast, steer quickly, and just as quickly straighten the wheel once you have avoided the object.

The fact that such emergency situations are always possible is a good reason to practice defensive driving at all times and wear safety belts properly.

## Off-Road Recovery

You may find that your right wheels have dropped off the edge of a road onto the shoulder while you're driving.

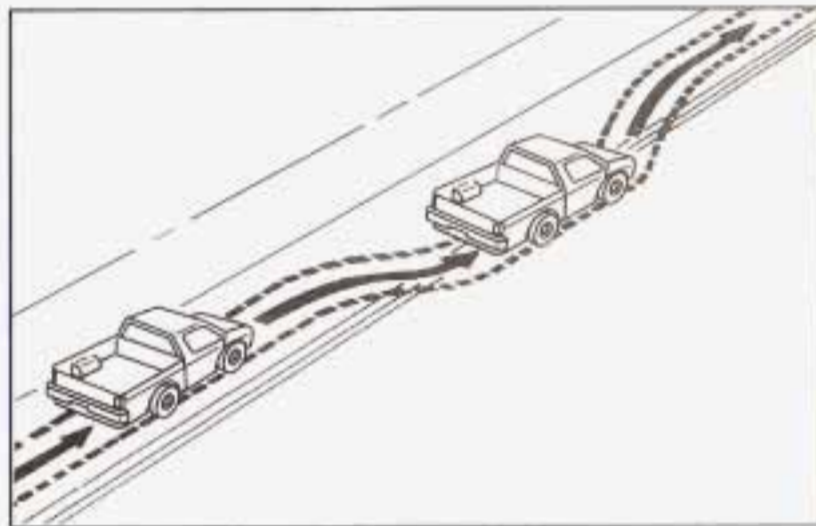

If the level of the shoulder is only slightly below the pavement, recovery should be fairly easy. Ease off the accelerator and then, if there is nothing in the way, steer so that your vehicle straddles the edge of the pavement. You can turn the steering wheel up to one-quarter turn until the right front tire contacts the pavement edge. Then turn your steering wheel to go straight down the roadway.

## Passing

The driver of a vehicle about to pass another on a two-lane highway waits for just the right moment, accelerates, moves around the vehicle ahead, then goes back into the right lane again. A simple maneuver?

Not necessarily! Passing another vehicle on a two-lane highway is a potentially dangerous move, since the passing vehicle occupies the same lane as oncoming traffic for several seconds. A miscalculation, an error in judgment, or a brief surrender to frustration or anger can suddenly put the passing driver face to face with the worst of all traffic accidents — the head-on collision.

So here are some tips for passing:

- "Drive ahead." Look down the road, to the sides and to crossroads for situations that might affect your passing patterns. If you have any doubt whatsoever about making a successful pass, wait for a better time.
- Watch for traffic signs, pavement markings and lines. If you can see a sign up ahead that might indicate a turn or an intersection, delay your pass. A broken center line usually indicates it's all right to pass (providing the road ahead is clear). Never cross a solid line on your side of the lane or a double solid line, even if the road seems empty of approaching traffic.
- Do not get too close to the vehicle you want to pass while you're awaiting an opportunity. For one thing, following too closely reduces your area of vision, especially if you're following a larger vehicle. Also, you won't have adequate space if the vehicle ahead suddenly slows or stops. Keep back a reasonable distance.
- When it looks like a chance to pass is coming up, start to accelerate but stay in the right lane and don't get too close. Time your move so you will be increasing speed as the time comes to move into the other lane. If the way is clear to pass, you will have a "running start" that more than makes up for the distance you would lose by dropping back. And if something happens to cause you to cancel your pass, you need only slow down and drop back again and wait for another opportunity.
- If other vehicles are lined up to pass a slow vehicle, wait your turn. But take care that someone isn't trying to pass you as you pull out to pass the slow vehicle. Remember to glance over your shoulder and check the blind spot.
- Check your mirrors, glance over your shoulder, and start your left lane change signal before moving out of the right lane to pass. When you are far enough ahead of the passed vehicle to see its front in your inside mirror, activate your right lane change signal and move back into the right lane.

(Remember that your right outside mirror is convex. The vehicle you just passed may seem to be farther away from you than it really is.)

- Try not to pass more than one vehicle at a time on two-lane roads. Reconsider before passing the next vehicle.
- Don't overtake a slowly moving vehicle too rapidly. Even though the brake lamps are not flashing, it may be slowing down or starting to turn.
- If you're being passed, make it easy for the following driver to get ahead of you. Perhaps you can ease a little to the right.

## Loss of Control

Let's review what driving experts say about what happens when the three control systems (brakes, steering and acceleration) don't have enough friction where the tires meet the road to do what the driver has asked.

In any emergency, don't give up. Keep trying to steer and constantly seek an escape route or area of less danger.

## Skidding

In a skid, a driver can lose control of the vehicle. Defensive drivers avoid most skids by taking reasonable care suited to existing conditions, and by not "overdriving" those conditions. But skids are always possible.

The three types of skids correspond to your vehicle's three control systems. In the braking skid, your wheels aren't rolling. In the steering or cornering skid, too much speed or steering in a curve causes tires to slip and lose cornering force. And in the acceleration skid, too much throttle causes the driving wheels to spin.

A cornering skid is best handled by easing your foot off the accelerator pedal.

If you have the Traction Assist System, remember: It helps avoid only the acceleration skid. If you do not have this system, or if the system is off, then an acceleration skid is also best handled by easing your foot off the accelerator pedal.

If your vehicle starts to slide, ease your foot off the accelerator pedal and quickly steer the way you want the vehicle to go. If you start steering quickly enough, your vehicle may straighten out. Always be ready for a second skid if it occurs.

Of course, traction is reduced when water, snow, ice, gravel or other material is on the road. For safety, you'll want to slow down and adjust your driving to these



conditions. It is important to slow down on slippery surfaces because stopping distance will be longer and vehicle control more limited.

While driving on a surface with reduced traction, try your best to avoid sudden steering, acceleration or braking (including engine braking by shifting to a lower gear). Any sudden changes could cause the tires to slide. You may not realize the surface is slippery until your vehicle is skidding. Learn to recognize warning clues — such as enough water, ice or packed snow on the road to make a “mirrored surface” — and slow down when you have any doubt.

Remember: Any anti-lock brake system (ABS) helps avoid only the braking skid.

## Off-Road Driving with Your Four-Wheel-Drive Vehicle

This off-road guide is for vehicles that have four-wheel drive. Also, see *Braking on page 4-5*. If your vehicle doesn't have four-wheel drive, you shouldn't drive off-road unless you're on a level, solid surface.

Off-road driving can be great fun. But it does have some definite hazards. The greatest of these is the terrain itself.

“Off-roading” means you've left the great North American road system behind. Traffic lanes aren't marked. Curves aren't banked. There are no road signs. Surfaces can be slippery, rough, uphill or downhill. In short, you've gone right back to nature.

Off-road driving involves some new skills. And that's why it's very important that you read this guide. You'll find many driving tips and suggestions. These will help make your off-road driving safer and more enjoyable.

### Before You Go Off-Road

There are some things to do before you go out. For example, be sure to have all necessary maintenance and service work done. Check to make sure all underbody shields (if so equipped) are properly attached.

Be sure you read all the information about your four-wheel-drive vehicle in this manual.

Is there enough fuel? Is the spare tire fully inflated? Are the fluid levels up where they should be? What are the local laws that apply to off-roading where you'll be driving? If you don't know, you should check with law enforcement people in the area. Will you be on someone's private land? If so, be sure to get the necessary permission.

## Loading Your Vehicle for Off-Road Driving

There are some important things to remember about how to load your vehicle.

- The heaviest things should be on the load floor and forward of your rear axle. Put heavier items as far forward as you can.
- Be sure the load is secured properly, so driving on the off-road terrain doesn't toss things around.

### CAUTION:

- **Cargo on the load floor piled higher than the seatbacks can be thrown forward during a sudden stop. You or your passengers could be injured. Keep cargo below the top of the seatbacks.**
- **Unsecured cargo on the load floor can be tossed about when driving over rough terrain. You or your passengers can be struck by flying objects. Secure the cargo properly.**

CAUTION: (Continued)

### CAUTION: (Continued)

- **Heavy loads on the roof raise the vehicle's center of gravity, making it more likely to roll over. You can be seriously or fatally injured if the vehicle rolls over. Put heavy loads inside the cargo area, not on the roof. Keep cargo in the cargo area as far forward and low as possible.**

You'll find other important information in this manual. See *Loading Your Vehicle* on page 4-45, *Luggage Carrier* on page 2-48 and *Tires* on page 5-53.

## Environmental Concerns

Off-road driving can provide wholesome and satisfying recreation. However, it also raises environmental concerns. We recognize these concerns and urge every off-roader to follow these basic rules for protecting the environment:

- Always use established trails, roads and areas that have been specially set aside for public off-road recreational driving; obey all posted regulations.
- Avoid any driving practice that could damage the environment — shrubs, flowers, trees, grasses — or disturb wildlife (this includes

wheel-spinning, breaking down trees or unnecessary driving through streams or over soft ground).

- Always carry a litter bag...make sure all refuse is removed from any campsite before leaving.
- Take extreme care with open fires (where permitted), camp stoves and lanterns.
- Never park your vehicle over dry grass or other combustible materials that could catch fire from the heat of the vehicle's exhaust system.

## Traveling to Remote Areas

It makes sense to plan your trip, especially when going to a remote area. Know the terrain and plan your route. You are much less likely to get bad surprises. Get accurate maps of trails and terrain. Try to learn of any blocked or closed roads.

It's also a good idea to travel with at least one other vehicle. If something happens to one of them, the other can help quickly.

Does your vehicle have a winch? If so, be sure to read the winch instructions. In a remote area, a winch can be handy if you get stuck. But you'll want to know how to use it properly.

## Getting Familiar with Off-Road Driving

It's a good idea to practice in an area that's safe and close to home before you go into the wilderness. Off-road driving does require some new and different skills. Here's what we mean.

Tune your senses to different kinds of signals. Your eyes, for example, need to constantly sweep the terrain for unexpected obstacles. Your ears need to listen for unusual tire or engine sounds. With your arms, hands, feet and body, you'll need to respond to vibrations and vehicle bounce.

Controlling your vehicle is the key to successful off-road driving. One of the best ways to control your vehicle is to control your speed. Here are some things to keep in mind. At higher speeds:

- you approach things faster and you have less time to scan the terrain for obstacles.
- you have less time to react.
- you have more vehicle bounce when you drive over obstacles.
- you'll need more distance for braking, especially since you're on an unpaved surface.

## CAUTION:

When you're driving off-road, bouncing and quick changes in direction can easily throw you out of position. This could cause you to lose control and crash. So, whether you're driving on or off the road, you and your passengers should wear safety belts.

### Scanning the Terrain

Off-road driving can take you over many different kinds of terrain. You need to be familiar with the terrain and its many different features. Here are some things to consider.

**Surface Conditions:** Off-roading can take you over hard-packed dirt, gravel, rocks, grass, sand, mud, snow or ice. Each of these surfaces affects the steering, acceleration and braking of your vehicle in different ways. Depending upon the kind of surface you are on, you may experience slipping, sliding, wheel spinning, delayed acceleration, poor traction and longer braking distances.

**Surface Obstacles:** Unseen or hidden obstacles can be hazardous. A rock, log, hole, rut or bump can startle you if you're not prepared for them. Often these

obstacles are hidden by grass, bushes, snow or even the rise and fall of the terrain itself. Here are some things to consider:

- Is the path ahead clear?
- Will the surface texture change abruptly up ahead?
- Does the travel take you uphill or downhill? (There's more discussion of these subjects later.)
- Will you have to stop suddenly or change direction quickly?

When you drive over obstacles or rough terrain, keep a firm grip on the steering wheel. Ruts, troughs or other surface features can jerk the wheel out of your hands if you're not prepared.

When you drive over bumps, rocks, or other obstacles, your wheels can leave the ground. If this happens, even with one or two wheels, you can't control the vehicle as well or at all.

Because you will be on an unpaved surface, it's especially important to avoid sudden acceleration, sudden turns or sudden braking.

In a way, off-road driving requires a different kind of alertness from driving on paved roads and highways. There are no road signs, posted speed limits or signal lights. You have to use your own good judgment about what is safe and what isn't.

Drinking and driving can be very dangerous on any road. And this is certainly true for off-road driving. At the very time you need special alertness and driving skills, your reflexes, perceptions and judgment can be affected by even a small amount of alcohol. You could have a serious — or even fatal — accident if you drink and drive or ride with a driver who has been drinking. See *Drunken Driving* on page 4-2.

## Driving on Off-Road Hills

Off-road driving often takes you up, down or across a hill. Driving safely on hills requires good judgment and an understanding of what your vehicle can and can't do. There are some hills that simply can't be driven, no matter how well built the vehicle.

### CAUTION:

**Many hills are simply too steep for any vehicle. If you drive up them, you will stall. If you drive down them, you can't control your speed. If you drive across them, you will roll over. You could be seriously injured or killed. If you have any doubt about the steepness, don't drive the hill.**

## Approaching a Hill

When you approach a hill, you need to decide if it's one of those hills that's just too steep to climb, descend or cross. Steepness can be hard to judge. On a very small hill, for example, there may be a smooth, constant incline with only a small change in elevation where you can easily see all the way to the top. On a large hill, the incline may get steeper as you near the top, but you may not see this because the crest of the hill is hidden by bushes, grass or shrubs.

Here are some other things to consider as you approach a hill.

- Is there a constant incline, or does the hill get sharply steeper in places?
- Is there good traction on the hillside, or will the surface cause tire slipping?
- Is there a straight path up or down the hill so you won't have to make turning maneuvers?
- Are there obstructions on the hill that can block your path (boulders, trees, logs or ruts)?
- What's beyond the hill? Is there a cliff, an embankment, a drop-off, a fence? Get out and walk the hill if you don't know. It's the smart way to find out.
- Is the hill simply too rough? Steep hills often have ruts, gullies, troughs and exposed rocks because they are more susceptible to the effects of erosion.

## Driving Uphill

Once you decide you can safely drive up the hill, you need to take some special steps.

- Use a low gear and get a firm grip on the steering wheel.
- Get a smooth start up the hill and try to maintain your speed. Don't use more power than you need, because you don't want your wheels to start spinning or sliding.
- Try to drive straight up the hill if at all possible. If the path twists and turns, you might want to find another route.

### CAUTION:

**Turning or driving across steep hills can be dangerous. You could lose traction, slide sideways, and possibly roll over. You could be seriously injured or killed. When driving up hills, always try to go straight up.**

- Ease up on your speed as you approach the top of the hill.
- Attach a flag to the vehicle to make you more visible to approaching traffic on trails or hills.

- Sound the horn as you approach the top of the hill to let opposing traffic know you're there.
- Use your headlamps even during the day. They make you more visible to oncoming traffic.

### CAUTION:

**Driving to the top (crest) of a hill at full speed can cause an accident. There could be a drop-off, embankment, cliff, or even another vehicle. You could be seriously injured or killed. As you near the top of a hill, slow down and stay alert.**

**Q:** What should I do if my vehicle stalls, or is about to stall, and I can't make it up the hill?

**A:** If this happens, there are some things you should do, and there are some things you must not do. First, here's what you *should* do:

- Push the brake pedal to stop the vehicle and keep it from rolling backwards. Also, apply the parking brake.
- If your engine is still running, shift the transmission to REVERSE (R), release the parking brake, and slowly back down the hill in REVERSE (R).

- If your engine has stopped running, you'll need to restart it. With the brake pedal pressed and the parking brake still applied, shift the transmission to PARK (P) and restart the engine. Then, shift to REVERSE (R), release the parking brake, and slowly back down the hill as straight as possible in REVERSE (R).
- As you are backing down the hill, put your left hand on the steering wheel at the 12 o'clock position. This way, you'll be able to tell if your wheels are straight and maneuver as you back down. It's best that you back down the hill with your wheels straight rather than in the left or right direction. Turning the wheel too far to the left or right will increase the possibility of a rollover.

Here are some things you *must not* do if you stall, or are about to stall, when going up a hill.

- Never attempt to prevent a stall by shifting into NEUTRAL (N) to "rev-up" the engine and regain forward momentum. This won't work. Your vehicle will roll backwards very quickly and you could go out of control.

Instead, apply the regular brake to stop the vehicle. Then apply the parking brake. Shift to REVERSE (R), release the parking brake, and slowly back straight down.

- Never attempt to turn around if you are about to stall when going up a hill. If the hill is steep enough to stall your vehicle, it's steep enough to cause you to roll over if you turn around. If you can't make it up the hill, you must back straight down the hill.

**Q:** Suppose, after stalling, I try to back down the hill and decide I just can't do it. What should I do?

**A:** Set the parking brake, put your transmission in PARK (P) and turn off the engine. Leave the vehicle and go get some help. Exit on the uphill side and stay clear of the path the vehicle would take if it rolled downhill. Do not shift the transfer case to NEUTRAL when you leave the vehicle. Leave it in some gear.

## CAUTION:

Shifting the transfer case to **NEUTRAL** can cause your vehicle to roll even if the transmission is in **PARK (P)**. This is because the **NEUTRAL** position on the transfer case overrides the transmission. You or someone else could be injured. If you are going to leave your vehicle, set the parking brake and shift the transmission to **PARK (P)**. But do not shift the transfer case to **NEUTRAL**. Leave the transfer case in the 2 Wheel High, 4 High or 4 Low position.

## Driving Downhill

When off-roading takes you downhill, you'll want to consider a number of things:

- How steep is the downhill? Will I be able to maintain vehicle control?
- What's the surface like? Smooth? Rough? Slippery? Hard-packed dirt? Gravel?

- Are there hidden surface obstacles? Ruts? Logs? Boulders?
- What's at the bottom of the hill? Is there a hidden creek bank or even a river bottom with large rocks?

If you decide you can go down a hill safely, then try to keep your vehicle headed straight down, and use a low gear. This way, engine drag can help your brakes and they won't have to do all the work. Descend slowly, keeping your vehicle under control at all times.

## CAUTION:

Heavy braking when going down a hill can cause your brakes to overheat and fade. This could cause loss of control and a serious accident. Apply the brakes lightly when descending a hill and use a low gear to keep vehicle speed under control.



**Q:** Are there some things I should not do when driving down a hill?

**A:** Yes! These are important because if you ignore them you could lose control and have a serious accident.

- When driving downhill, avoid turns that take you across the incline of the hill. A hill that's not too steep to drive down may be too steep to drive across. You could roll over if you don't drive straight down.
- Never go downhill with the transmission in NEUTRAL (N). This is called "free-wheeling." Your brakes will have to do all the work and could overheat and fade.

**Q:** Am I likely to stall when going downhill?

**A:** It's much more likely to happen going uphill. But if it happens going downhill, here's what to do.

- Stop your vehicle by applying the regular brakes. Apply the parking brake.
- Shift to PARK (P) and, while still braking, restart the engine.
- Shift back to a low gear, release the parking brake, and drive straight down.
- If the engine won't start, get out and get help.

## Driving Across an Incline

Sooner or later, an off-road trail will probably go across the incline of a hill. If this happens, you have to decide whether to try to drive across the incline. Here are some things to consider:

- A hill that can be driven straight up or down may be too steep to drive across. When you go straight up or down a hill, the length of the wheel base (the distance from the front wheels to the rear wheels) reduces the likelihood the vehicle will tumble end over end. But when you drive across an incline, the much more narrow track width (the distance between the left and right wheels) may not prevent the vehicle from tilting and rolling over. Also, driving across an incline puts more weight on the downhill wheels. This could cause a downhill slide or a rollover.
- Surface conditions can be a problem when you drive across a hill. Loose gravel, muddy spots, or even wet grass can cause your tires to slip sideways, downhill. If the vehicle slips sideways, it can hit something that will trip it (a rock, a rut, etc.) and roll over.
- Hidden obstacles can make the steepness of the incline even worse. If you drive across a rock with the uphill wheels, or if the downhill wheels drop into a rut or depression, your vehicle can tilt even more.

For reasons like these, you need to decide carefully whether to try to drive across an incline. Just because the trail goes across the incline doesn't mean you have to drive it. The last vehicle to try it might have rolled over.

**⚠ CAUTION:**

Driving across an incline that's too steep will make your vehicle roll over. You could be seriously injured or killed. If you have any doubt about the steepness of the incline, don't drive across it. Find another route instead.

**Q:** What if I'm driving across an incline that's not too steep, but I hit some loose gravel and start to slide downhill. What should I do?

**A:** If you feel your vehicle starting to slide sideways, turn downhill. This should help straighten out the vehicle and prevent the side slipping. However, a much better way to prevent this is to get out and "walk the course" so you know what the surface is like before you drive it.

## Stalling on an Incline

If your vehicle stalls when you're crossing an incline, be sure you (and your passengers) get out on the uphill side, even if the door there is harder to open. If you get out on the downhill side and the vehicle starts to roll over, you'll be right in its path.

If you have to walk down the slope, stay out of the path the vehicle will take if it does roll over.

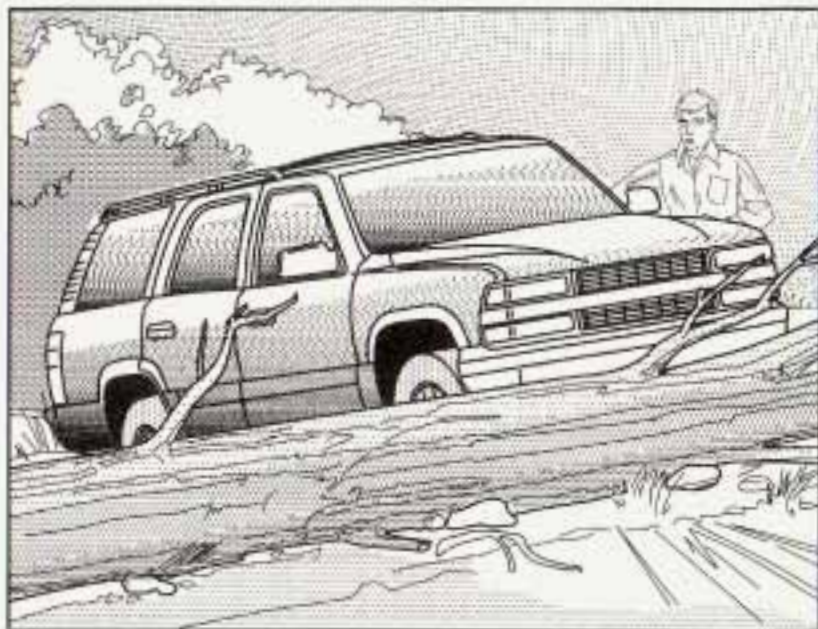

 **CAUTION:**

**Getting out on the downhill (low) side of a vehicle stopped across an incline is dangerous. If the vehicle rolls over, you could be crushed or killed. Always get out on the uphill (high) side of the vehicle and stay well clear of the rollover path.**

### **Driving in Mud, Sand, Snow or Ice**

When you drive in mud, snow or sand, your wheels won't get good traction. You can't accelerate as quickly, turning is more difficult, and you'll need longer braking distances.

It's best to use a low gear when you're in mud — the deeper the mud, the lower the gear. In really deep mud, the idea is to keep your vehicle moving so you don't get stuck.

When you drive on sand, you'll sense a change in wheel traction. But it will depend upon how loosely packed the sand is. On loosely packed sand

(as on beaches or sand dunes) your tires will tend to sink into the sand. This has an effect on steering, accelerating and braking. Drive at a reduced speed and avoid sharp turns or abrupt maneuvers.

Hard packed snow and ice offer the worst tire traction. On these surfaces, it's very easy to lose control. On wet ice, for example, the traction is so poor that you will have difficulty accelerating. And if you do get moving, poor steering and difficult braking can cause you to slide out of control.

 **CAUTION:**

**Driving on frozen lakes, ponds or rivers can be dangerous. Underwater springs, currents under the ice, or sudden thaws can weaken the ice. Your vehicle could fall through the ice and you and your passengers could drown. Drive your vehicle on safe surfaces only.**

## Driving in Water

Heavy rain can mean flash flooding, and flood waters demand extreme caution.

Find out how deep the water is before you drive through it. If it's deep enough to cover your wheel hubs, axles or exhaust pipe, don't try it — you probably won't get through. Also, water that deep can damage your axle and other vehicle parts.

If the water isn't too deep, drive slowly through it. At faster speeds, water splashes on your ignition system and your vehicle can stall. Stalling can also occur if you get your tailpipe under water. And, as long as your tailpipe is under water, you'll never be able to start your engine. When you go through water, remember that when your brakes get wet, it may take you longer to stop.

### CAUTION:

**Driving through rushing water can be dangerous. Deep water can sweep your vehicle downstream and you and your passengers could drown. If it's only shallow water, it can still wash away the ground from under your tires, and you could lose traction and roll the vehicle over. Don't drive through rushing water.**

See *Driving in Rain and on Wet Roads* on page 4-27 for more information on driving through water.

## After Off-Road Driving

Remove any brush or debris that has collected on the underbody, chassis or under the hood. These accumulations can be a fire hazard.

After operation in mud or sand, have the brake linings cleaned and checked. These substances can cause glazing and uneven braking. Check the body structure, steering, suspension, wheels, tires and exhaust system for damage. Also, check the fuel lines and cooling system for any leakage.

Your vehicle will require more frequent service due to off-road use. Refer to the Maintenance Schedule for additional information.

## Driving at Night

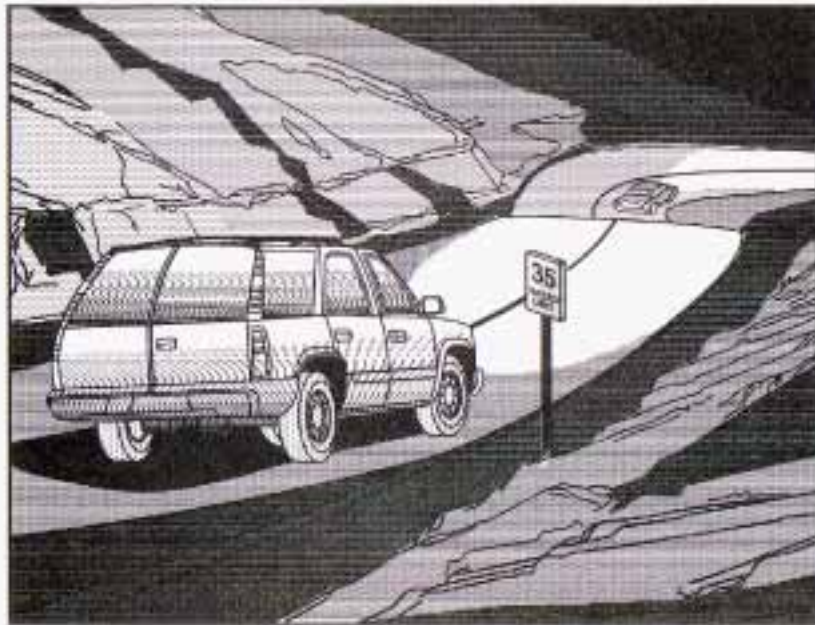

Night driving is more dangerous than day driving. One reason is that some drivers are likely to be impaired — by alcohol or drugs, with night vision problems, or by fatigue.

Here are some tips on night driving.

- Drive defensively.
- Don't drink and drive.
- Since you can't see as well, you may need to slow down and keep more space between you and other vehicles.
- Slow down, especially on higher speed roads. Your headlamps can light up only so much road ahead.
- In remote areas, watch for animals.
- If you're tired, pull off the road in a safe place and rest.

No one can see as well at night as in the daytime. But as we get older these differences increase. A 50-year-old driver may require at least twice as much light to see the same thing at night as a 20-year-old.

What you do in the daytime can also affect your night vision. For example, if you spend the day in bright sunshine you are wise to wear sunglasses. Your eyes will have less trouble adjusting to night. But if you're driving, don't wear sunglasses at night. They may cut down on glare from headlamps, but they also make a lot of things invisible.

You can be temporarily blinded by approaching headlamps. It can take a second or two, or even several seconds, for your eyes to readjust to the dark. When you are faced with severe glare (as from a driver who doesn't lower the high beams, or a vehicle with misaimed headlamps), slow down a little. Avoid staring directly into the approaching headlamps.

Keep your windshield and all the glass on your vehicle clean — inside and out. Glare at night is made much worse by dirt on the glass. Even the inside of the glass can build up a film caused by dust. Dirty glass makes lights dazzle and flash more than clean glass would, making the pupils of your eyes contract repeatedly.

Remember that your headlamps light up far less of a roadway when you are in a turn or curve. Keep your eyes moving; that way, it's easier to pick out dimly lighted objects. Just as your headlamps should be checked regularly for proper aim, so should your eyes be examined regularly. Some drivers suffer from night blindness — the inability to see in dim light — and aren't even aware of it.

## Driving in Rain and on Wet Roads



Rain and wet roads can mean driving trouble. On a wet road, you can't stop, accelerate or turn as well because your tire-to-road traction isn't as good as on dry roads. And, if your tires don't have much tread left, you'll get even less traction. It's always wise to go slower and be cautious if rain starts to fall while you are driving. The surface may get wet suddenly when your reflexes are tuned for driving on dry pavement.

The heavier the rain, the harder it is to see. Even if your windshield wiper blades are in good shape, a heavy rain can make it harder to see road signs and traffic signals, pavement markings, the edge of the road and even people walking.

It's wise to keep your wiping equipment in good shape and keep your windshield washer tank filled with washer fluid. Replace your windshield wiper inserts when they show signs of streaking or missing areas on the windshield, or when strips of rubber start to separate from the inserts.



Driving too fast through large water puddles or even going through some car washes can cause problems, too. The water may affect your brakes. Try to avoid puddles. But if you can't, try to slow down before you hit them.

**⚠ CAUTION:**

**Wet brakes can cause accidents. They won't work as well in a quick stop and may cause pulling to one side. You could lose control of the vehicle.**

**After driving through a large puddle of water or a car wash, apply your brake pedal lightly until your brakes work normally.**

## Hydroplaning

Hydroplaning is dangerous. So much water can build up under your tires that they can actually ride on the water. This can happen if the road is wet enough and you're going fast enough. When your vehicle is hydroplaning, it has little or no contact with the road.

Hydroplaning doesn't happen often. But it can if your tires do not have much tread or if the pressure in one or more is low. It can happen if a lot of water is standing on the road. If you can see reflections from trees, telephone poles or other vehicles, and raindrops "dimple" the water's surface, there could be hydroplaning.

Hydroplaning usually happens at higher speeds. There just isn't a hard and fast rule about hydroplaning. The best advice is to slow down when it is raining.

## Driving Through Deep Standing Water

**Notice:** If you drive too quickly through deep puddles or standing water, water can come in through your engine's air intake and badly damage your engine. Never drive through water that is slightly lower than the underbody of your vehicle. If you can't avoid deep puddles or standing water, drive through them very slowly.

## Driving Through Flowing Water

### CAUTION:

**Flowing or rushing water creates strong forces. If you try to drive through flowing water, as you might at a low water crossing, your vehicle can be carried away. As little as six inches of flowing water can carry away a smaller vehicle. If this happens, you and other vehicle occupants could drown. Don't ignore police warning signs, and otherwise be very cautious about trying to drive through flowing water.**

## Some Other Rainy Weather Tips

- Besides slowing down, allow some extra following distance. And be especially careful when you pass another vehicle. Allow yourself more clear room ahead, and be prepared to have your view restricted by road spray.
- Have good tires with proper tread depth. See *Tires on page 5-53*.



## City Driving



One of the biggest problems with city streets is the amount of traffic on them. You'll want to watch out for what the other drivers are doing and pay attention to traffic signals.

Here are ways to increase your safety in city driving:

- Know the best way to get to where you are going. Get a city map and plan your trip into an unknown part of the city just as you would for a cross-country trip.
- Try to use the freeways that rim and crisscross most large cities. You'll save time and energy. See *Freeway Driving* on page 4-31.
- Treat a green light as a warning signal. A traffic light is there because the corner is busy enough to need it. When a light turns green, and just before you start to move, check both ways for vehicles that have not cleared the intersection or may be running the red light.

## Freeway Driving

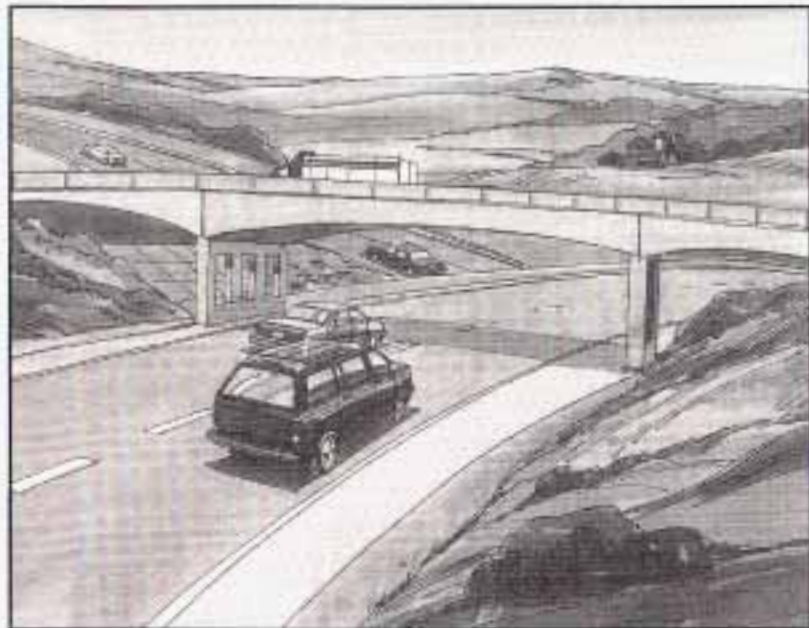

Mile for mile, freeways (also called thruways, parkways, expressways, turnpikes or superhighways) are the safest of all roads. But they have their own special rules.

The most important advice on freeway driving is: Keep up with traffic and keep to the right. Drive at the same speed most of the other drivers are driving. Too-fast or too-slow driving breaks a smooth traffic flow. Treat the left lane on a freeway as a passing lane.

At the entrance, there is usually a ramp that leads to the freeway. If you have a clear view of the freeway as you drive along the entrance ramp, you should begin to check traffic. Try to determine where you expect to blend with the flow. Try to merge into the gap at close to the prevailing speed. Switch on your turn signal, check your mirrors and glance over your shoulder as often as necessary. Try to blend smoothly with the traffic flow.

Once you are on the freeway, adjust your speed to the posted limit or to the prevailing rate if it's slower. Stay in the right lane unless you want to pass.

Before changing lanes, check your mirrors. Then use your turn signal.

Just before you leave the lane, glance quickly over your shoulder to make sure there isn't another vehicle in your "blind" spot.

Once you are moving on the freeway, make certain you allow a reasonable following distance. Expect to move slightly slower at night.

When you want to leave the freeway, move to the proper lane well in advance. If you miss your exit, do not, under any circumstances, stop and back up. Drive on to the next exit.

The exit ramp can be curved, sometimes quite sharply. The exit speed is usually posted.

Reduce your speed according to your speedometer, not to your sense of motion. After driving for any distance at higher speeds, you may tend to think you are going slower than you actually are.

## Before Leaving on a Long Trip

Make sure you're ready. Try to be well rested. If you must start when you're not fresh — such as after a day's work — don't plan to make too many miles that first part of the journey. Wear comfortable clothing and shoes you can easily drive in.

Is your vehicle ready for a long trip? If you keep it serviced and maintained, it's ready to go. If it needs service, have it done before starting out. Of course,

you'll find experienced and able service experts in dealerships all across North America. They'll be ready and willing to help if you need it.

Here are some things you can check before a trip:

- *Windshield Washer Fluid:* Is the reservoir full? Are all windows clean inside and outside?
- *Wiper Blades:* Are they in good shape?
- *Fuel, Engine Oil, Other Fluids:* Have you checked all levels?
- *Lamps:* Are they all working? Are the lenses clean?
- *Tires:* They are vitally important to a safe, trouble-free trip. Is the tread good enough for long-distance driving? Are the tires all inflated to the recommended pressure?
- *Weather Forecasts:* What's the weather outlook along your route? Should you delay your trip a short time to avoid a major storm system?
- *Maps:* Do you have up-to-date maps?

## Highway Hypnosis

Is there actually such a condition as “highway hypnosis”? Or is it just plain falling asleep at the wheel? Call it highway hypnosis, lack of awareness, or whatever.

There is something about an easy stretch of road with the same scenery, along with the hum of the tires on the road, the drone of the engine, and the rush of the wind against the vehicle that can make you sleepy. Don't let it happen to you! If it does, your vehicle can leave the road in *less than a second*, and you could crash and be injured.

What can you do about highway hypnosis? First, be aware that it can happen.

Then here are some tips:

- Make sure your vehicle is well ventilated, with a comfortably cool interior.
- Keep your eyes moving. Scan the road ahead and to the sides. Check your mirrors and your instruments frequently.
- If you get sleepy, pull off the road into a rest, service or parking area and take a nap, get some exercise, or both. For safety, treat drowsiness on the highway as an emergency.

## Hill and Mountain Roads

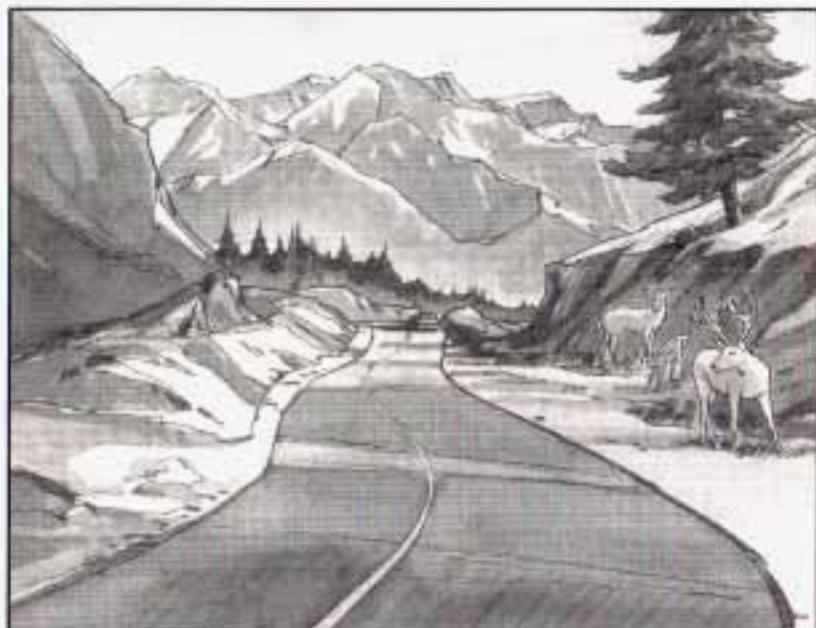

Driving on steep hills or mountains is different from driving in flat or rolling terrain.

If you drive regularly in steep country, or if you're planning to visit there, here are some tips that can make your trips safer and more enjoyable. See *Off-Road Driving with Your Four-Wheel-Drive Vehicle* on page 4-14 for information about driving off-road.

- Keep your vehicle in good shape. Check all fluid levels and also the brakes, tires, cooling system and transmission. These parts can work hard on mountain roads.
- Know how to go down hills. The most important thing to know is this: let your engine do some of the slowing down. Shift to a lower gear when you go down a steep or long hill.

 **CAUTION:**

**If you don't shift down, your brakes could get so hot that they wouldn't work well. You would then have poor braking or even none going down a hill. You could crash. Shift down to let your engine assist your brakes on a steep downhill slope.**

 **CAUTION:**

**Coasting downhill in NEUTRAL (N) or with the ignition off is dangerous. Your brakes will have to do all the work of slowing down. They could get so hot that they wouldn't work well. You would then have poor braking or even none going down a hill. You could crash. Always have your engine running and your vehicle in gear when you go downhill.**

- Know how to go uphill. You may want to shift down to a lower gear. The lower gears help cool your engine and transmission, and you can climb the hill better.
- Stay in your own lane when driving on two-lane roads in hills or mountains. Don't swing wide or cut across the center of the road. Drive at speeds that let you stay in your own lane.
- As you go over the top of a hill, be alert. There could be something in your lane, like a stalled car or an accident.

- You may see highway signs on mountains that warn of special problems. Examples are long grades, passing or no-passing zones, a falling rocks area or winding roads. Be alert to these and take appropriate action.

## Winter Driving



Here are some tips for winter driving:

- Have your vehicle in good shape for winter.
- You may want to put winter emergency supplies in your vehicle.

Include an ice scraper, a small brush or broom, a supply of windshield washer fluid, a rag, some winter outer clothing, a small shovel, a flashlight, a red cloth and reflective warning triangles. And, if you will be driving under severe conditions, include a small bag of sand, a piece of old carpet or a couple of burlap bags to help provide traction. Be sure you properly secure these items in your vehicle.

## Driving on Snow or Ice

Most of the time, those places where your tires meet the road probably have good traction.

However, if there is snow or ice between your tires and the road, you can have a very slippery situation. You'll have a lot less traction or "grip" and will need to be very careful.

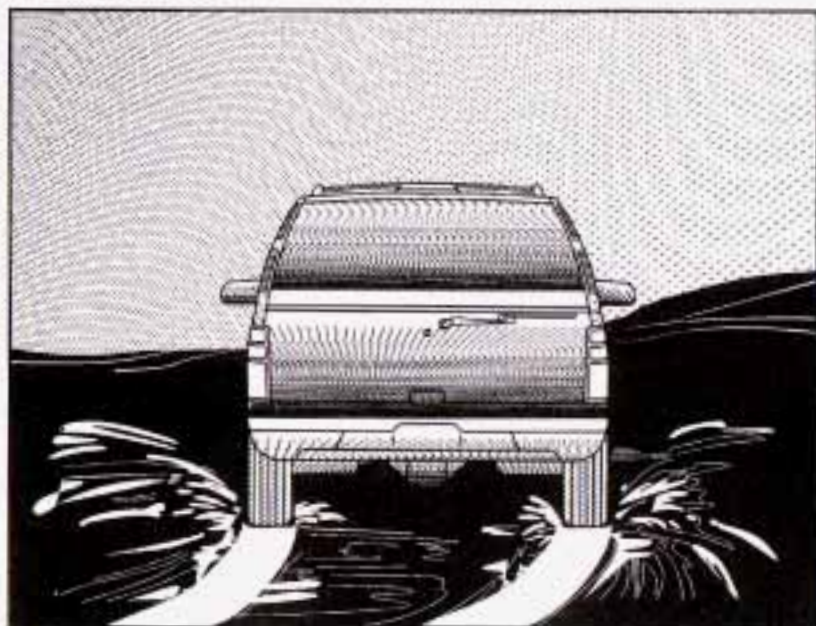

What's the worst time for this? "Wet ice." Very cold snow or ice can be slick and hard to drive on. But wet ice can be even more trouble because it may offer the least traction of all. You can get wet ice when it's about freezing (32°F; 0°C) and freezing rain begins to fall. Try to avoid driving on wet ice until salt and sand crews can get there.

Whatever the condition — smooth ice, packed, blowing or loose snow — drive with caution.

If you have traction assist, keep the system on. It will improve your ability to accelerate when driving on a slippery road. But you can turn the traction system off if your vehicle ever gets stuck in sand, mud, ice or snow. See *If You Are Stuck: In Sand, Mud, Ice or Snow* on page 4-39. Even though your vehicle has a traction system, you'll want to slow down and adjust your driving to the road conditions. See *Traction Assist System (TAS)* on page 4-8.

If you don't have a traction system, accelerate gently. Try not to break the gentle traction. If you accelerate too fast, the drive wheels will spin and polish the surface under the tires even more.

Your anti-lock brakes improve your vehicle's stability when you make a hard stop on a slippery road. Even though you have an anti-lock braking system, you'll want to begin stopping sooner than you would on dry pavement. See *Braking on page 4-5*.

- Allow greater following distance on any slippery road.
- Watch for slippery spots. The road might be fine until you hit a spot that's covered with ice. On an otherwise clear road, ice patches may appear in shaded areas where the sun can't reach: around clumps of trees, behind buildings or under bridges. Sometimes the surface of a curve or an overpass may remain icy when the surrounding roads are clear. If you see a patch of ice ahead of you, brake before you are on it. Try not to brake while you're actually on the ice, and avoid sudden steering maneuvers.

## If You're Caught in a Blizzard



If you are stopped by heavy snow, you could be in a serious situation. You should probably stay with your vehicle unless you know for sure that you are near help and you can hike through the snow. Here are some things to do to summon help and keep yourself and your passengers safe:

- Turn on your hazard flashers.



- Tie a red cloth to your vehicle to alert police that you've been stopped by the snow.
- Put on extra clothing or wrap a blanket around you. If you have no blankets or extra clothing, make body insulators from newspapers, burlap bags, rags, floor mats — anything you can wrap around yourself or tuck under your clothing to keep warm.



You can run the engine to keep warm, but be careful.

## CAUTION:

**Snow can trap exhaust gases under your vehicle. This can cause deadly CO (carbon monoxide) gas to get inside. CO could overcome you and kill you. You can't see it or smell it, so you might not know it is in your vehicle. Clear away snow from around the base of your vehicle, especially any that is blocking your exhaust pipe. And check around again from time to time to be sure snow doesn't collect there.**

**Open a window just a little on the side of the vehicle that's away from the wind. This will help keep CO out.**

Run your engine only as long as you must. This saves fuel. When you run the engine, make it go a little faster than just idle. That is, push the accelerator slightly. This uses less fuel for the heat that you get and it keeps the battery charged. You will need a well-charged battery to restart the vehicle, and possibly for signaling later on with your headlamps. Let the heater run for a while.

Then, shut the engine off and close the window almost all the way to preserve the heat. Start the engine again and repeat this only when you feel really uncomfortable from the cold. But do it as little as possible. Preserve the fuel as long as you can. To help keep warm, you can get out of the vehicle and do some fairly vigorous exercises every half hour or so until help comes.

## If You Are Stuck: In Sand, Mud, Ice or Snow

In order to free your vehicle when it is stuck, you will need to spin the wheels, but you don't want to spin your wheels too fast. The method known as "rocking" can help you get out when you're stuck, but you must use caution.

### CAUTION:

If you let your tires spin at high speed, they can explode, and you or others could be injured. And, the transmission or other parts of the vehicle can overheat. That could cause an engine compartment fire or other damage. When you're stuck, spin the wheels as little as possible. Don't spin the wheels above 35 mph (55 km/h) as shown on the speedometer.

**Notice:** Spinning your wheels can destroy parts of your vehicle as well as the tires. If you spin the wheels too fast while shifting your transmission back and forth, you can destroy your transmission.

For information about using tire chains on your vehicle, see *Tire Chains on page 5-60*.

## Rocking Your Vehicle To Get It Out

First, turn your steering wheel left and right. That will clear the area around your front wheels. If you have a four-wheel-drive vehicle, shift into 4Hi. Then shift back and forth between REVERSE (R) and a forward gear, spinning the wheels as little as possible. Release the accelerator pedal while you shift, and press lightly on the accelerator pedal when the transmission is in gear. By slowly spinning your wheels in the forward and reverse directions, you will cause a rocking motion that may free your vehicle. If that doesn't get you out after a few tries, you may need to be towed out. Or, you can use your recovery hooks if your vehicle has them. If you do need to be towed out, see *Towing Your Vehicle* on page 4-42.

## Using the Recovery Hooks

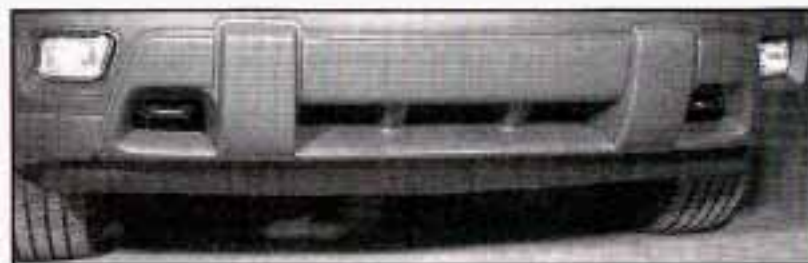

Your vehicle may be equipped with recovery hooks. The recovery hooks are provided at the front of your vehicle. You may need to use them if you're stuck off-road and need to be pulled to some place where you can continue driving.



**⚠ CAUTION:**

These hooks, when used, are under a lot of force. Always pull the vehicle straight out. Never pull on the hooks at a sideways angle. The hooks could break off and you or others could be injured from the chain or cable snapping back.

*Notice:* Never use recovery hooks to tow the vehicle. Your vehicle could be damaged and it would not be covered by warranty.

# Towing

## Towing Your Vehicle

Consult your dealer or a professional towing service if you need to have your disabled vehicle towed. See *Roadside Assistance Program on page 7-5*.

If you want to tow your vehicle behind another vehicle for recreational purposes (such as behind a motorhome), see "Recreational Vehicle Towing" following.

## Recreational Vehicle Towing

Recreational vehicle towing means towing your vehicle behind another vehicle – such as behind a motorhome. The two most common types of recreational vehicle towing are known as "dinghy towing" (towing your vehicle with all four wheels on the ground) and "dolly towing" (towing your vehicle with two wheels on the ground and two wheels up on a device known as a "dolly").

With the proper preparation and equipment, many vehicles can be towed in these ways. See "Dinghy Towing" and "Dolly Towing," following.

Here are some important things to consider before you do recreational vehicle towing:

- What's the towing capacity of the towing vehicle? Be sure you read the tow vehicle manufacturer's recommendations.
- How far will you tow? Some vehicles have restrictions on how far and how long they can tow.
- Do you have the proper towing equipment? See your dealer or trailering professional for additional advice and equipment recommendations.
- Is your vehicle ready to be towed? Just as you would prepare your vehicle for a long trip, you'll want to make sure your vehicle is prepared to be towed. See *Before Leaving on a Long Trip on page 4-32*.

## Dinghy Towing

When towing your vehicle, turn the ignition off. To prevent your battery from draining while towing, remove the Ignition A and the Ignition B fuses from the engine compartment fuse block. Be sure to reinstall the fuse when you reach your destination.

## Two-Wheel-Drive Vehicles

Two-wheel-drive vehicles should not be towed with all four wheels on the ground. Two-wheel-drive transmissions have no provisions for internal lubrication while being towed. To properly tow these vehicles, they should be placed on a platform trailer.

In rare cases when it's unavoidable that a two-wheel-drive vehicle is to be towed with all four wheels on the ground, the propeller shaft to axle yoke orientation should be marked and the propeller shaft removed following the applicable service manual removal/installation procedure.

Dust or dirt can enter the back of the transmission through the opening created by removing the propeller shaft if proper protection is not provided. Also, check the transmission fluid level before driving the truck.

## Four-Wheel-Drive Vehicles

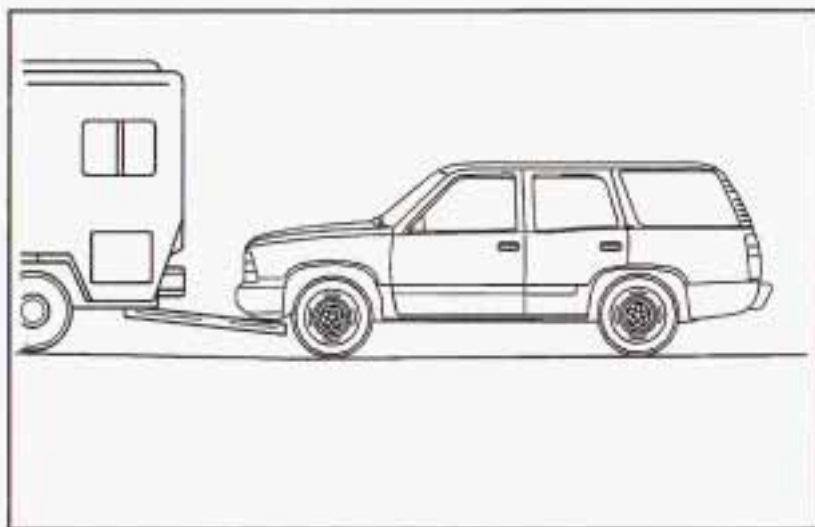

Use the following procedure to tow your vehicle:

1. Firmly set the parking brake.
2. Shift the transmission to PARK (P).
3. Securely attach the vehicle being towed to the tow vehicle.
4. Shift the transfer case to NEUTRAL (N). See "Four-Wheel Drive" in the Index for the proper procedure to select the NEUTRAL position for your vehicle.

5. Release the parking brake only after the vehicle being towed is firmly attached to the towing vehicle.
6. Turn the ignition off and remove the key. If the key is not removed, the battery will drain.

 **CAUTION:**

Shifting a four-wheel-drive vehicle's transfer case into **NEUTRAL** can cause your vehicle to roll even if the transmission is in Park (P). You or others could be injured. Make sure the parking brake is firmly set before you shift the transfer case to **NEUTRAL**.

## Dolly Towing

Your vehicle was not designed to be dolly towed. If you need to tow your vehicle, see "Dinghy Towing" earlier in this section.

 **CAUTION:**

Shifting a four-wheel-drive vehicle's transfer case into **NEUTRAL** can cause your vehicle to roll even if the transmission is in Park (P). You or others could be injured. Make sure the parking brake is firmly set before you shift the transfer case to **NEUTRAL**.

## Loading Your Vehicle

The diagram shows a rectangular label with the following fields:

- GVWR
- GAWR FRT
- GAWR RR
- MODEL
- PA
- CA
- TIRE SPEED
- RIM
- COLD TIRE PRESSURE
- SEE OWNER'S MANUAL FOR ADDITIONAL INFORMATION

A large, bold, black watermark reading "EXAMPLE" is diagonally placed across the center of the label.

The Certification/Tire label is found on the driver's door edge, above the door latch. The label shows the size of your original tires and the inflation pressures needed to obtain the gross weight capacity of your vehicle. This is called the Gross Vehicle Weight Rating (GVWR). The GVWR includes the weight of the vehicle, all occupants, fuel, cargo and trailer tongue weight, if pulling a trailer.

The Certification/Tire label also tells you the maximum weights for the front and rear axles, called Gross Axle Weight Rating (GAWR). To find out the actual loads

on your front and rear axles, you need to go to a weigh station and weigh your vehicle. Your dealer can help you with this. Be sure to spread out your load equally on both sides of the centerline.

Never exceed the GVWR for your vehicle, or the GAWR for either the front or rear axle.

And, if you do have a heavy load, you should spread it out.

Similar appearing vehicles may have different GVWRs and payloads. Please note the Certification/Tire label on your truck or consult your dealer for additional details.

### CAUTION:

**Do not load your vehicle any heavier than the GVWR, or either the maximum front or rear GAWR. If you do, parts on your vehicle can break, and it can change the way your vehicle handles. These could cause you to lose control and crash. Also, overloading can shorten the life of your vehicle.**

Using heavier suspension components to get added durability might not change your weight ratings. Ask your dealer to help you load your vehicle the right way.



**Notice:** Your warranty does not cover parts or components that fail because of overloading.

If you put things inside your vehicle — like suitcases, tools, packages, or anything else — they will go as fast as the vehicle goes. If you have to stop or turn quickly, or if there is a crash, they'll keep going.

### CAUTION:

Things you put inside your vehicle can strike and injure people in a sudden stop or turn, or in a crash.

- Put things in the cargo area of your vehicle. Try to spread the weight evenly.
- Never stack heavier things, like suitcases, inside the vehicle so that some of them are above the tops of the seats.

CAUTION: (Continued)

### CAUTION: (Continued)

- Don't leave an unsecured child restraint in your vehicle.
- When you carry something inside the vehicle, secure it whenever you can.
- Don't leave a seat folded down unless you need to.

There's also important loading information for off-road driving in this manual.

## Adding a Snow Plow or Similar Equipment

Your vehicle was neither designed nor intended for a snow plow.

**Notice:** Adding a snow plow or similar equipment to your vehicle can damage it, and the repairs wouldn't be covered by warranty. Do not install a snow plow or similar equipment on your vehicle.

## Towing a Trailer

### CAUTION:

If you don't use the correct equipment and drive properly, you can lose control when you pull a trailer. For example, if the trailer is too heavy, the brakes may not work well -- or even at all. You and your passengers could be seriously injured. You may also damage your vehicle; the resulting repairs would not be covered by your warranty. Pull a trailer only if you have followed all the steps in this section. Ask your dealer for advice and information about towing a trailer with your vehicle.

**Notice:** Pulling a trailer improperly can damage your vehicle and result in costly repairs not covered by your warranty. To pull a trailer correctly, follow the advice in this part, and see your dealer for important information about towing a trailer with your vehicle. Additional rear axle maintenance is required for a vehicle used to tow a trailer. See "Scheduled Maintenance Services" in the Index.

To identify the trailering capacity of your vehicle, you should read the information in "Weight of the Trailer" that appears later in this section.

Trailering is different than just driving your vehicle by itself. Trailering means changes in handling, durability and fuel economy. Successful, safe trailering takes correct equipment, and it has to be used properly.

That's the reason for this part. In it are many time-tested, important trailering tips and safety rules. Many of these are important for your safety and that of your passengers. So please read this section carefully before you pull a trailer.

## If You Do Decide To Pull A Trailer

If you do, here are some important points:

- There are many different laws, including speed limit restrictions, having to do with trailering. Make sure your rig will be legal, not only where you live but also where you'll be driving. A good source for this information can be state or provincial police.
- Consider using a sway control if your trailer will weigh 4,000 lbs. (1 816 kg) or less. You should always use a sway control if your trailer will weigh more than 4,000 lbs. (1 816 kg). You can ask a hitch dealer about sway controls.
- Don't tow a trailer at all during the first 500 miles (800 km) your new vehicle is driven. Your engine, axle or other parts could be damaged.

- Then, during the first 500 miles (800 km) that you tow a trailer, don't drive over 50 mph (80 km/h) and don't make starts at full throttle. This helps your engine and other parts of your vehicle wear in at the heavier loads.
- With an automatic transmission, you can tow in DRIVE (D). You may want to shift the transmission to THIRD (3) or, if necessary, a lower gear selection if the transmission shifts too often (eg., under heavy loads and/or hilly conditions).

Three important considerations have to do with weight:

- the weight of the trailer,
- the weight of the trailer tongue
- and the weight on your vehicle's tires.

## Weight of the Trailer

How heavy can a trailer safely be?

It depends on how you plan to use your rig. For example, speed, altitude, road grades, outside temperature and how much your vehicle is used to pull a trailer are all important. And, it can also depend on any special equipment that you have on your vehicle.

Look in the following chart to find the maximum trailer weight for your vehicle.

Vehicle	Axle Ratio	Maximum Trailer Weight	GCWR
2WD TRAILBLAZER (L6 Engine)	3.42	5,300 lbs. (2 406 kg)	10,000 lbs. (4 535 kg)
	3.73	5,800 lbs. (2 633 kg)	10,500 lbs. (4 762 kg)
	4.10	6,300 lbs. (2 860 kg)	11,000 lbs. (4 989 kg)
4WD TRAILBLAZER (L6 Engine)	3.42	5,200 lbs. (2 301 kg)	10,000 lbs. (4 535 kg)
	3.73	5,700 lbs. (2 588 kg)	10,500 lbs. (4 762 kg)
	4.10	6,200 lbs. (2 815 kg)	11,000 lbs. (4 989 kg)
2WD TRAILBLAZER EXT (L6 Engine)	3.42	4,900 lbs. (2 225 kg)	10,000 lbs. (4 535 kg)
	3.73	5,400 lbs. (2 452 kg)	10,500 lbs. (4 762 kg)
	4.10	5,900 lbs. (2 679 kg)	11,000 lbs. (4 989 kg)
4WD TRAILBLAZER EXT (L6 Engine)	3.42	4,800 lbs. (2 179 kg)	10,000 lbs. (4 535 kg)
	3.73	5,300 lbs. (2 406 kg)	10,500 lbs. (4 762 kg)
	4.10	5,800 lbs. (2 633 kg)	11,000 lbs. (4 989 kg)

Vehicle	Axle Ratio	Maximum Trailer Weight	GCWR
2WD TrailBlazer EXT (V8 Engine)	3.42	5,800 lbs. (2 633 kg)	11,000 lbs. (4 994 kg)
	3.73	7,200 lbs. (3 269 kg)	12,500 lbs. (5 675 kg)
4WD TrailBlazer EXT (V8 Engine)	3.42	5,700 lbs. (2 588 kg)	11,000 lbs. (4 994 kg)
	3.73	7,000 lbs. (3 178 kg)	12,500 lbs. (5 675 kg)

\*The Gross Combination Weight Rating (GCWR) is the total allowable weight of the completely loaded vehicle and trailer including any passengers, cargo, equipment and conversion. The GCWR for your vehicle should not be exceeded.

You can ask your dealer for our trailering information or advice, or you can write us at the address listed in your Warranty and Owner Assistance Information Booklet.

In Canada, write to:

General Motors of Canada Limited  
 Customer Communication Centre, 163- 005  
 1908 Colonel Sam Drive  
 Oshawa, Ontario L1H 8P7

## Weight of the Trailer Tongue

The tongue load (A) of any trailer is an important weight to measure because it affects the total or gross weight of your vehicle. The Gross Vehicle Weight (GVW) includes the curb weight of the vehicle, any cargo you may carry in it, and the people who will be riding in the vehicle. And if you will tow a trailer, you must add the tongue load to the GVW because your vehicle will be carrying that weight, too. See *Loading Your Vehicle* on page 4-45 for more information about your vehicle's maximum load capacity.

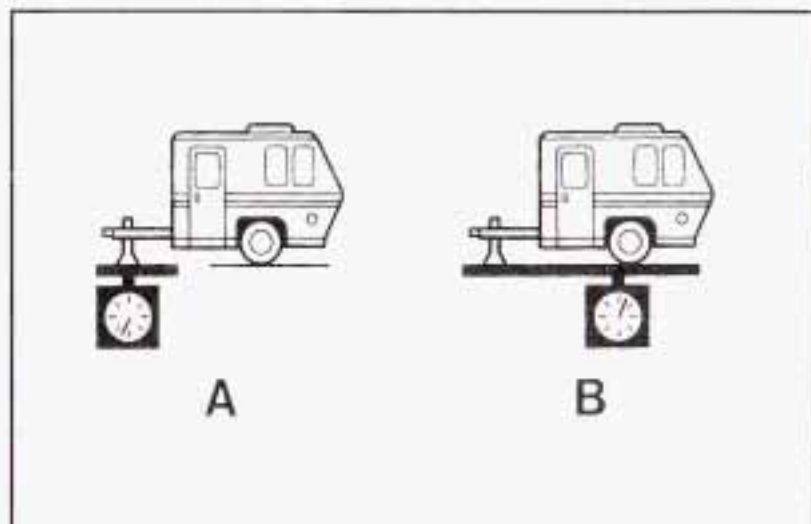

If you're using a weight-carrying or a weight-distributing hitch, the trailer tongue weight (A) should be 10 percent to 15 percent of the total loaded trailer weight (B). Do not exceed the maximum allowable tongue weight for your vehicle.

After you've loaded your trailer, weigh the trailer and then the tongue, separately, to see if the weights are proper. If they aren't, you may be able to get them right simply by moving some items around in the trailer.

## Total Weight on Your Vehicle's Tires

Be sure your vehicle's tires are inflated to the upper limit for cold tires. You'll find these numbers on the Certification label at the rear edge of the driver's door. Then, be sure you don't go over the GVW limit for your vehicle, including the weight of the trailer tongue.

## Hitches

It's important to have the correct hitch equipment. Crosswinds, large trucks going by and rough roads are a few reasons why you'll need the right hitch. Here are some rules to follow:

- If you'll be pulling a trailer that, when loaded, will weigh more than 4,000 lbs. (1 816 kg), be sure to use a properly mounted, weight-distributing hitch and sway control of the proper size. This equipment is very important for proper vehicle loading and good handling when you're driving.
- Will you have to make any holes in the body of your vehicle when you install a trailer hitch?

If you do, then be sure to seal the holes later when you remove the hitch. If you don't seal them, deadly carbon monoxide (CO) from your exhaust can get into your vehicle. Dirt and water can, too.

## Safety Chains

You should always attach chains between your vehicle and your trailer. Cross the safety chains under the tongue of the trailer to help prevent the tongue from contacting the road if it becomes separated from the hitch. Instructions about safety chains may be provided by the hitch manufacturer or by the trailer manufacturer. Follow the manufacturer's recommendation for attaching safety chains and do not attach them to the bumper. Always leave just enough slack so you can turn with your rig. Never allow safety chains to drag on the ground.

## Trailer Brakes

If your trailer weighs more than 1,500 lbs. (680 kg) loaded, then it needs its own brakes — and they must be adequate. Be sure to read and follow the instructions for the trailer brakes so you'll be able to install, adjust and maintain them properly.

Your trailer's brake system can tap into the vehicle's hydraulic brake system only if:

- The trailer parts can withstand 3,000 psi (20 650 kPa) of pressure.
- The trailer's brake system will use less than 0.02 cubic inch (0.3 cc) of fluid from your vehicle's master cylinder. Otherwise, both braking systems won't work well. You could even lose your brakes.

If everything checks out this far, then make the brake fluid tap at the port on the master cylinder that sends fluid to the rear brakes. But don't use copper tubing for this. If you do, it will bend and finally break off. Use steel brake tubing.

## Driving with a Trailer

### CAUTION:

If you have a rear-most window open and you pull a trailer with your vehicle, carbon monoxide (CO) could come into your vehicle. You can't see or smell CO. It can cause unconsciousness or death. See "Engine Exhaust" in the Index. To maximize your safety when towing a trailer:

- Have your exhaust system inspected for leaks, and make necessary repairs before starting on your trip.
- Keep the rear-most windows closed.

CAUTION: (Continued)

## **CAUTION: (Continued)**

- **If exhaust does come into your vehicle through a window in the rear or another opening, drive with your front, main heating or cooling system on and with the fan on any speed. This will bring fresh, outside air into your vehicle. Do not use the climate control setting for maximum air because it only recirculates the air inside your vehicle. See "Climate Controls" in the Index.**

Towing a trailer requires a certain amount of experience. Before setting out for the open road, you'll want to get to know your rig. Acquaint yourself with the feel of handling and braking with the added weight of the trailer. And always keep in mind that the vehicle you are driving is now a good deal longer and not nearly as responsive as your vehicle is by itself.

Before you start, check the trailer hitch and platform (and attachments), safety chains, electrical connector, lamps, tires and mirror adjustment. If the trailer has electric brakes, start your vehicle and trailer moving and

then apply the trailer brake controller by hand to be sure the brakes are working. This lets you check your electrical connection at the same time.

During your trip, check occasionally to be sure that the load is secure, and that the lamps and any trailer brakes are still working.

## **Following Distance**

Stay at least twice as far behind the vehicle ahead as you would when driving your vehicle without a trailer. This can help you avoid situations that require heavy braking and sudden turns.

## **Passing**

You'll need more passing distance up ahead when you're towing a trailer. And, because you're a good deal longer, you'll need to go much farther beyond the passed vehicle before you can return to your lane.

## **Backing Up**

Hold the bottom of the steering wheel with one hand. Then, to move the trailer to the left, just move that hand to the left. To move the trailer to the right, move your hand to the right. Always back up slowly and, if possible, have someone guide you.



## Making Turns

**Notice:** Making very sharp turns while trailering could cause the trailer to come in contact with the vehicle. Your vehicle could be damaged. Avoid making very sharp turns while trailering.

When you're turning with a trailer, make wider turns than normal. Do this so your trailer won't strike soft shoulders, curbs, road signs, trees or other objects. Avoid jerky or sudden maneuvers. Signal well in advance.

## Turn Signals When Towing a Trailer

The arrows on your instrument panel will flash whenever you signal a turn or lane change. Properly hooked up, the trailer lamps will also flash, telling other drivers you're about to turn, change lanes or stop.

When towing a trailer, the arrows on your instrument panel will flash for turns even if the bulbs on the trailer are burned out. Thus, you may think drivers behind you are seeing your signal when they are not. It's important to check occasionally to be sure the trailer bulbs are still working.

## Driving On Grades

Reduce speed and shift to a lower gear *before* you start down a long or steep downgrade. If you don't shift down, you might have to use your brakes so much that they would get hot and no longer work well.

You can tow in DRIVE (D). You may want to shift the transmission to THIRD (3) or a lower gear, under heavy loads or hilly conditions.

When towing at high altitude on steep uphill grades, consider the following: Engine coolant will boil at a lower temperature than at normal altitudes. If you turn your engine off immediately after towing at high altitude on steep uphill grades, your vehicle may show signs similar to engine overheating. To avoid this, let the engine run while parked (preferably on level ground) with the automatic transmission in PARK (P) for a few minutes before turning the engine off. If you do get the overheat warning, see *Engine Overheating on page 5-25*.

## Parking on Hills

### CAUTION:

You really should not park your vehicle, with a trailer attached, on a hill. If something goes wrong, your rig could start to move. People can be injured, and both your vehicle and the trailer can be damaged.

But if you ever have to park your rig on a hill, here's how to do it:

1. Apply your regular brakes, but don't shift into PARK (P) yet. When parking uphill, turn your wheels away from the curb. When parking downhill, turn your wheels into the curb.
2. Have someone place chocks under the trailer wheels.
3. When the wheel chocks are in place, release the regular brakes until the chocks absorb the load.
4. Reapply the regular brakes. Then apply your parking brake, and then shift into PARK (P).
5. Release the regular brakes.

### CAUTION:

It can be dangerous to get out of your vehicle if the shift lever is not fully in PARK (P) with the parking brake firmly set. Your vehicle can roll.

If you have left the engine running, the vehicle can move suddenly. You or others could be injured. To be sure your vehicle won't move, even when you're on fairly level ground, use the steps that follow.

**Always put the shift lever fully in PARK (P) with the parking brake firmly set.**

**If the transfer case on four-wheel drive vehicles is in NEUTRAL, your vehicle will be free to roll, even if your shift lever is in PARK (P). So, be sure the transfer case is in a drive gear – not in NEUTRAL.**

**See "Four-Wheel Drive (Automatic Transfer Case)" in the Index.**

## When You Are Ready to Leave After Parking on a Hill

1. Apply your regular brakes and hold the pedal down while you:
  - start your engine,
  - shift into a gear, and
  - release the parking brake.
2. Let up on the brake pedal.
3. Drive slowly until the trailer is clear of the chocks.
4. Stop and have someone pick up and store the chocks.

## Maintenance When Trailer Towing

Your vehicle will need service more often when you're pulling a trailer. See the Maintenance Schedule for more on this. Things that are especially important in trailer operation are automatic transmission fluid (don't overfill), engine oil, axle lubricant, belt(s), cooling system and brake system. Each of these is covered in this manual, and the Index will help you find them quickly. If you're trailering, it's a good idea to review these sections before you start your trip.

Check periodically to see that all hitch nuts and bolts are tight.

## Trailer Wiring Harness

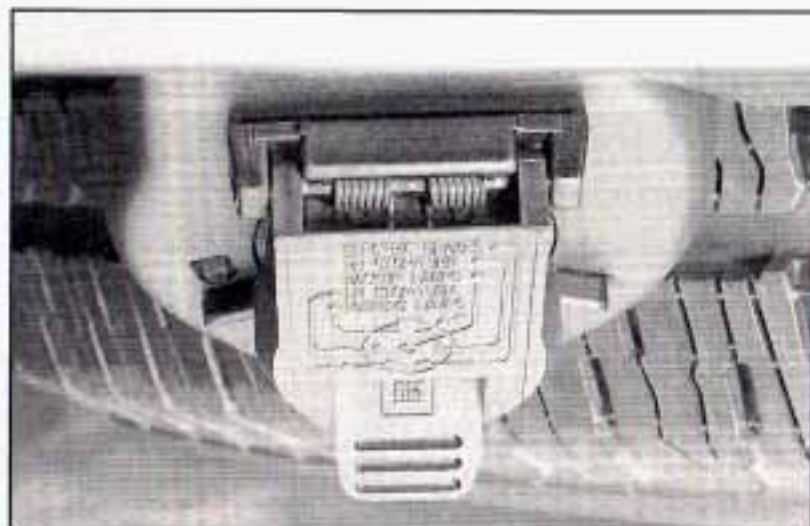

Your vehicle may be equipped with a seven-wire trailer towing harness. This harness has a seven-pin universal heavy-duty trailer connector that is attached to a bracket on the hitch platform. The seven-wire harness contains the following trailer circuits:

- Yellow: Left Stop/Turn Signal
- Dark Green: Right Stop/Turn Signal
- Brown: Running Lamps
- White: Ground
- Light Green: Back-up Lamps
- Red: Battery Feed
- Dark Blue: Electric Brakes

If you need to tow a light-duty trailer with a standard four-way round pin connector, an adapter connector is available from your dealer.

Your vehicle is also equipped with wiring for an electric trailer brake controller. These wires are located inside the vehicle on the driver's side under the instrument panel. These wires should be connected to an electric trailer brake controller by your dealer or a qualified service center.



## Section 5 Service and Appearance Care

---

<b>Service</b> .....	5-3	Power Steering Fluid .....	5-35
Doing Your Own Service Work .....	5-3	Windshield Washer Fluid .....	5-35
Adding Equipment to the Outside of Your Vehicle .....	5-4	Brakes .....	5-36
<b>Fuel</b> .....	5-5	Battery .....	5-39
Gasoline Octane .....	5-5	Jump Starting .....	5-40
Gasoline Specifications .....	5-5	<b>Rear Axle</b> .....	5-45
California Fuel .....	5-5	<b>Four-Wheel Drive</b> .....	5-46
Additives .....	5-6	<b>Bulb Replacement</b> .....	5-48
Fuels in Foreign Countries .....	5-6	Taillamps and Turn Signal Lamps .....	5-48
Filling Your Tank .....	5-7	Replacement Bulbs .....	5-49
Filling a Portable Fuel Container .....	5-9	<b>Windshield Wiper Blade Replacement</b> .....	5-50
<b>Checking Things Under the Hood</b> .....	5-10	<b>Tires</b> .....	5-53
Hood Release .....	5-10	Inflation -- Tire Pressure .....	5-53
Engine Compartment Overview .....	5-12	Tire Inspection and Rotation .....	5-54
Engine Oil .....	5-15	When It Is Time for New Tires .....	5-56
Engine Air Cleaner/Filter .....	5-19	Buying New Tires .....	5-56
Automatic Transmission Fluid .....	5-21	Uniform Tire Quality Grading .....	5-57
Engine Coolant .....	5-23	Wheel Alignment and Tire Balance .....	5-58
Radiator Pressure Cap .....	5-25	Wheel Replacement .....	5-59
Engine Overheating .....	5-25	Tire Chains .....	5-60
Cooling System .....	5-28	If a Tire Goes Flat .....	5-61
Engine Fan Noise .....	5-34	Changing a Flat Tire .....	5-61

## Section 5 Service and Appearance Care

---

<b>Appearance Care</b> .....	5-75	<b>Vehicle Identification</b> .....	5-83
Cleaning the Inside of Your Vehicle .....	5-75	Vehicle Identification Number (VIN) .....	5-83
Care of Safety Belts .....	5-78	Service Parts Identification Label .....	5-83
Weatherstrips .....	5-78	<b>Electrical System</b> .....	5-84
Cleaning the Outside of Your Vehicle .....	5-78	Add-On Electrical Equipment .....	5-84
Sheet Metal Damage .....	5-80	Headlamps .....	5-84
Finish Damage .....	5-80	Windshield Wiper Fuses .....	5-84
Underbody Maintenance .....	5-81	Power Windows and Other Power Options .....	5-84
Chemical Paint Spotting .....	5-81	Fuses and Circuit Breakers .....	5-85
GM Vehicle Care/Appearance Materials .....	5-81	<b>Capacities and Specifications</b> .....	5-96
		<b>Normal Maintenance Replacement Parts</b> .....	5-98

## Service

Your dealer knows your vehicle best and wants you to be happy with it. We hope you'll go to your dealer for all your service needs. You'll get genuine GM parts and GM-trained and supported service people.

We hope you'll want to keep your GM vehicle all GM. Genuine GM parts have one of these marks:

***ACDelco***

---

**GENUINE**  
**GM Parts**

---

**GM**  
**Goodwrench**

## Doing Your Own Service Work

If you want to do some of your own service work, you'll want to use the proper service manual. It tells you much more about how to service your vehicle than this manual can. To order the proper service manual, see *Service Publications Ordering Information on page 7-10*.

Your vehicle has an air bag system. Before attempting to do your own service work, see *Servicing Your Air Bag-Equipped Vehicle on page 1-58*.

You should keep a record with all parts receipts and list the mileage and the date of any service work you perform. See *Part E: Maintenance Record on page 6-17*.



## CAUTION:

**You can be injured and your vehicle could be damaged if you try to do service work on a vehicle without knowing enough about it.**

- **Be sure you have sufficient knowledge, experience, the proper replacement parts and tools before you attempt any vehicle maintenance task.**
- **Be sure to use the proper nuts, bolts and other fasteners. “English” and “metric” fasteners can be easily confused. If you use the wrong fasteners, parts can later break or fall off. You could be hurt.**

## Adding Equipment to the Outside of Your Vehicle

Things you might add to the outside of your vehicle can affect the airflow around it. This may cause wind noise and affect windshield washer performance. Check with your dealer before adding equipment to the outside of your vehicle.

## Fuel

Use of the recommended fuel is an important part of the proper maintenance of your vehicle.

## Gasoline Octane

Use regular unleaded gasoline with a posted octane of 87 or higher. If the octane is less than 87, you may get a heavy knocking noise when you drive. If this occurs, use a gasoline rated at 87 octane or higher as soon as possible. Otherwise, you might damage your engine. A little pinging noise when you accelerate or drive uphill is considered normal. This does not indicate a problem exists or that a higher-octane fuel is necessary. If you are using 87 octane or higher-octane fuel and hear heavy knocking, your engine needs service.

## Gasoline Specifications

It is recommended that gasoline meet specifications which were developed by the American Automobile Manufacturers Association and endorsed by the Canadian Vehicle Manufacturers Association for better vehicle performance and engine protection. Gasoline meeting these specifications could provide improved driveability and emission control system performance compared to other gasoline.



Canada Only

In Canada, look for the "Auto Makers' Choice" label on the pump.

## California Fuel

If your vehicle is certified to meet California Emission Standards (see the underhood emission control label), it is designed to operate on fuels that meet California specifications. If this fuel is not available in states adopting California emissions standards, your vehicle will operate satisfactorily on fuels meeting federal specifications, but emission control system performance may be affected. The malfunction indicator lamp may turn on (see *Malfunction Indicator Lamp on page 3-39*) and your vehicle may fail a smog-check test.

If this occurs, return to your authorized GM dealer for diagnosis. If it is determined that the condition is caused by the type of fuel used, repairs may not be covered by your warranty.

## Additives

To provide cleaner air, all gasolines in the United States are now required to contain additives that will help prevent engine and fuel system deposits from forming, allowing your emission control system to work properly. You should not have to add anything to your fuel. Gasolines containing oxygenates, such as ethers and ethanol, and reformulated gasolines may be available in your area to contribute to clean air. General Motors recommends that you use these gasolines, particularly if they comply with the specifications described earlier.

**Notice:** Your vehicle was not designed for fuel that contains methanol. Don't use fuel containing methanol. It can corrode metal parts in your fuel system and also damage the plastic and rubber parts. That damage wouldn't be covered under your warranty.

Some gasolines that are not reformulated for low emissions may contain an octane-enhancing additive called methylcyclopentadienyl manganese tricarbonyl (MMT); ask the attendant where you buy gasoline whether the fuel contains MMT. General Motors does not recommend the use of such gasolines. Fuels containing MMT can reduce the life of spark plugs and the performance of the emission control system may be affected. The malfunction indicator lamp may turn on. If this occurs, return to your authorized GM dealer for service.

## Fuels in Foreign Countries

If you plan on driving in another country outside the United States or Canada, the proper fuel may be hard to find. Never use leaded gasoline or any other fuel not recommended in the previous text on fuel. Costly repairs caused by use of improper fuel wouldn't be covered by your warranty.

To check the fuel availability, ask an auto club, or contact a major oil company that does business in the country where you'll be driving.

## Filling Your Tank

### CAUTION:

Fuel vapor is highly flammable. It burns violently, and that can cause very bad injuries. Don't smoke if you're near fuel or refueling your vehicle. Keep sparks, flames and smoking materials away from fuel.

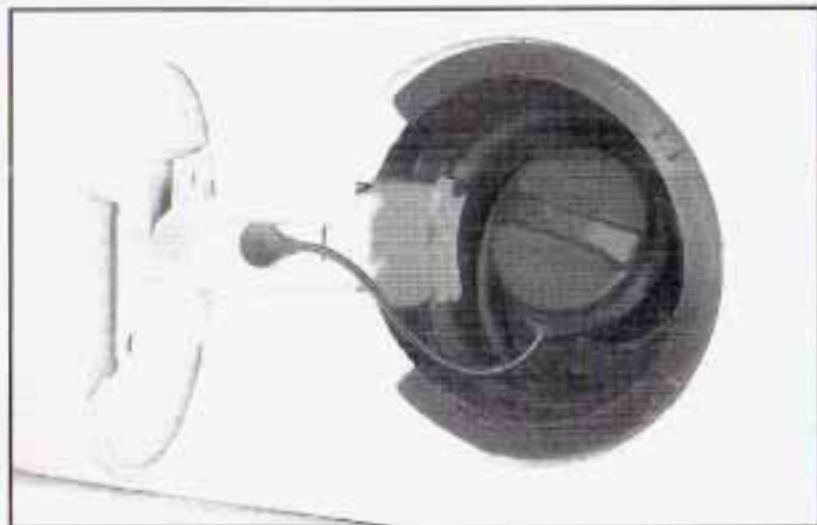

The fuel cap is located behind a hinged door on the driver's side of your vehicle.

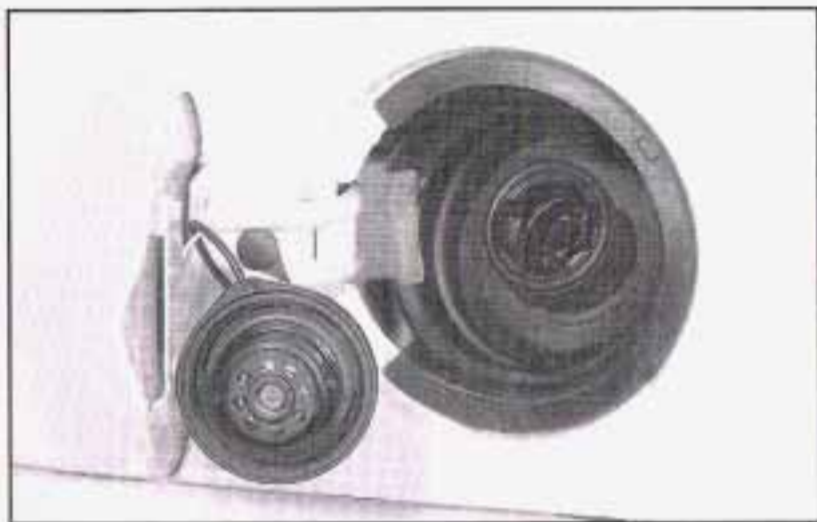

While refueling, hang the fuel cap by the tether using the hook located on the inside of the filler door.

To remove the fuel cap, turn it slowly to the left (counterclockwise). The fuel cap has a spring in it. If you let go of the cap too soon, it will spring back to the right.

**⚠ CAUTION:**

If you get fuel on yourself and then something ignites it, you could be badly burned. Fuel can spray out on you if you open the fuel cap too quickly. This spray can happen if your tank is nearly full, and is more likely in hot weather. Open the fuel cap slowly and wait for any "hiss" noise to stop. Then unscrew the cap all the way.

Be careful not to spill fuel. Clean fuel from painted surfaces as soon as possible. See *Cleaning the Outside of Your Vehicle* on page 5-78. When filling the tank do not overfill by squeezing in much more fuel after the pump shuts off.

When you put the fuel cap back on, turn it to the right (clockwise) until you hear a clicking sound. Make sure you fully install the cap. The diagnostic system can determine if the fuel cap has been left off or improperly installed. This would allow fuel to evaporate into the atmosphere. See *Malfunction Indicator Lamp* on page 3-39.

**Notice:** If you need a new fuel cap, be sure to get the right type. Your dealer can get one for you. If you get the wrong type, it may not fit properly. This may cause your malfunction indicator lamp to light and may damage your fuel tank and emissions system. See "Malfunction Indicator Lamp" in the Index.

## Filling a Portable Fuel Container

### CAUTION:

Never fill a portable fuel container while it is in your vehicle. Static electricity discharge from the container can ignite the gasoline vapor. You can be badly burned and your vehicle damaged if this occurs. To help avoid injury to you and others:

- Dispense gasoline only into approved containers.
- Do not fill a container while it is inside a vehicle, in a vehicle's trunk, pickup bed or on any surface other than the ground.
- Bring the fill nozzle in contact with the inside of the fill opening before operating the nozzle. Contact should be maintained until the filling is complete.
- Don't smoke while pumping gasoline.

## Checking Things Under the Hood

### CAUTION:

Things that burn can get on hot engine parts and start a fire. These include liquids like fuel, oil, coolant, brake fluid, windshield washer and other fluids, and plastic or rubber. You or others could be burned. Be careful not to drop or spill things that will burn onto a hot engine.

## Hood Release



1. To open the hood, first pull the handle located inside the vehicle on the lower driver's side of the instrument panel.

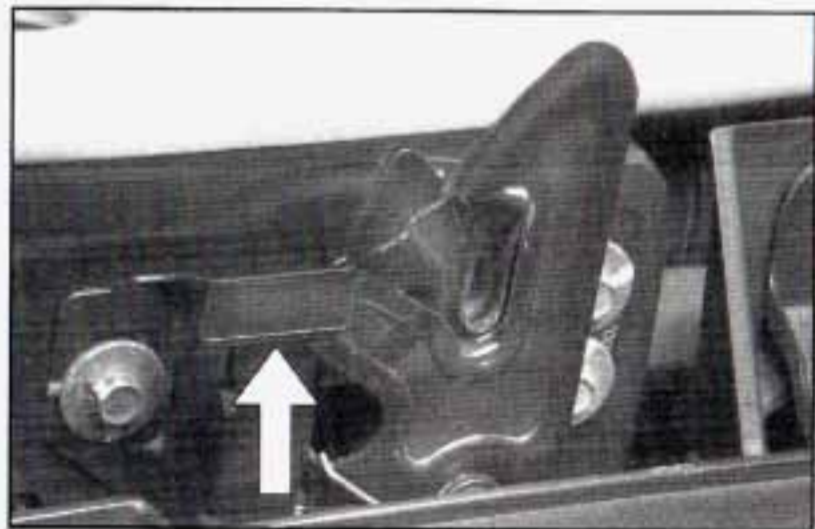

2. Then go to the front of the vehicle and release the secondary hood release.
3. Lift the hood; release the hood prop from its retainer and put the hood prop into the slot in the hood.



## Engine Compartment Overview

When you open the hood on the L6 engine, you'll see the following:

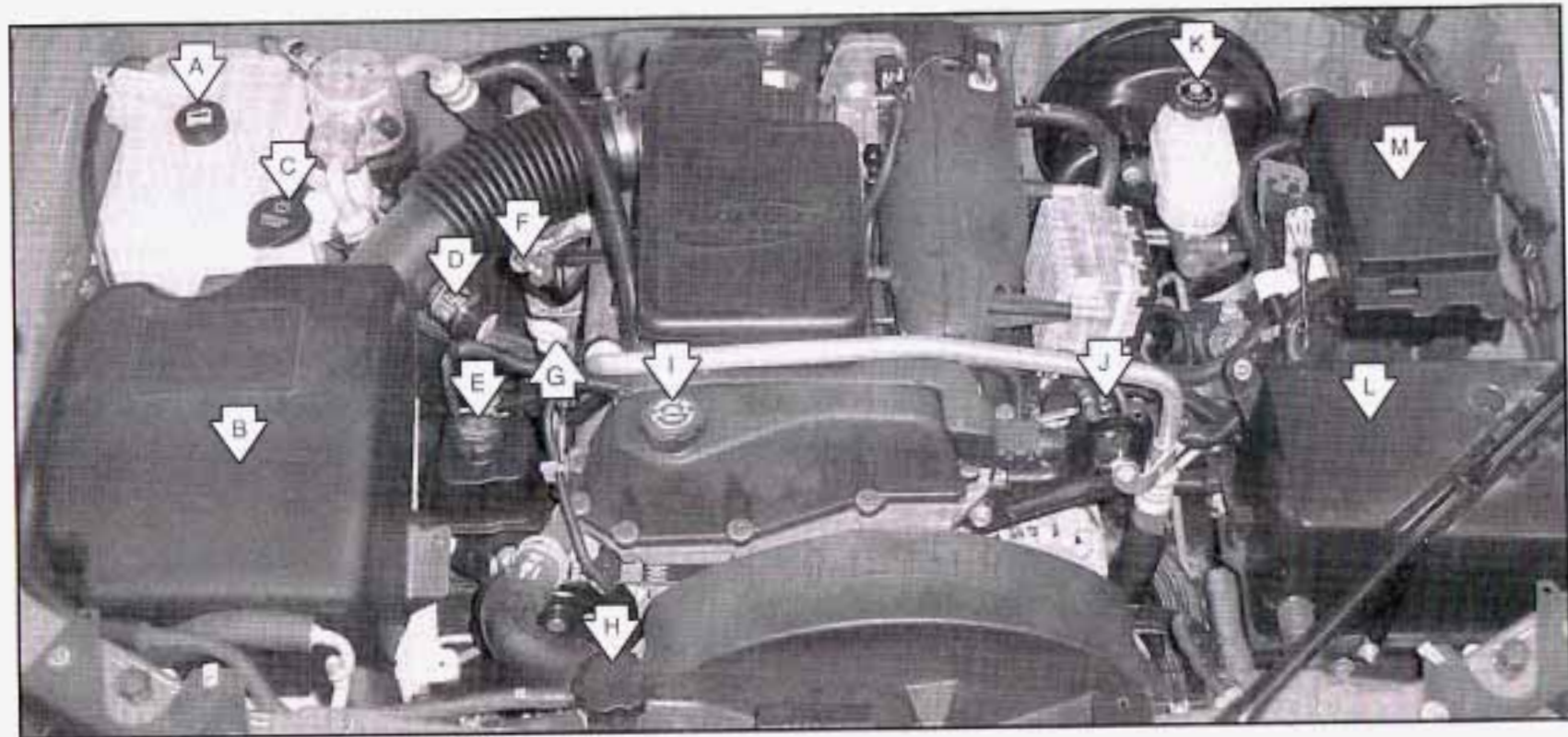

- A. Coolant Recovery Tank
- B. Engine Air Cleaner/Filter
- C. Windshield Washer Fluid Reservoir
- D. Engine Air Cleaner/Filter Indicator (If Equipped)
- E. Power Steering Fluid Reservoir
- F. Automatic Transmission Dipstick
- G. Engine Oil Dipstick

- H. Radiator Pressure Cap
- I. Engine Oil Fill Cap
- J. Remote Negative (-) Terminal Marked "GND"
- K. Brake Master Cylinder
- L. Battery
- M. Engine Compartment Fuse Block

When you open the hood on the V8 engine, you'll see the following:

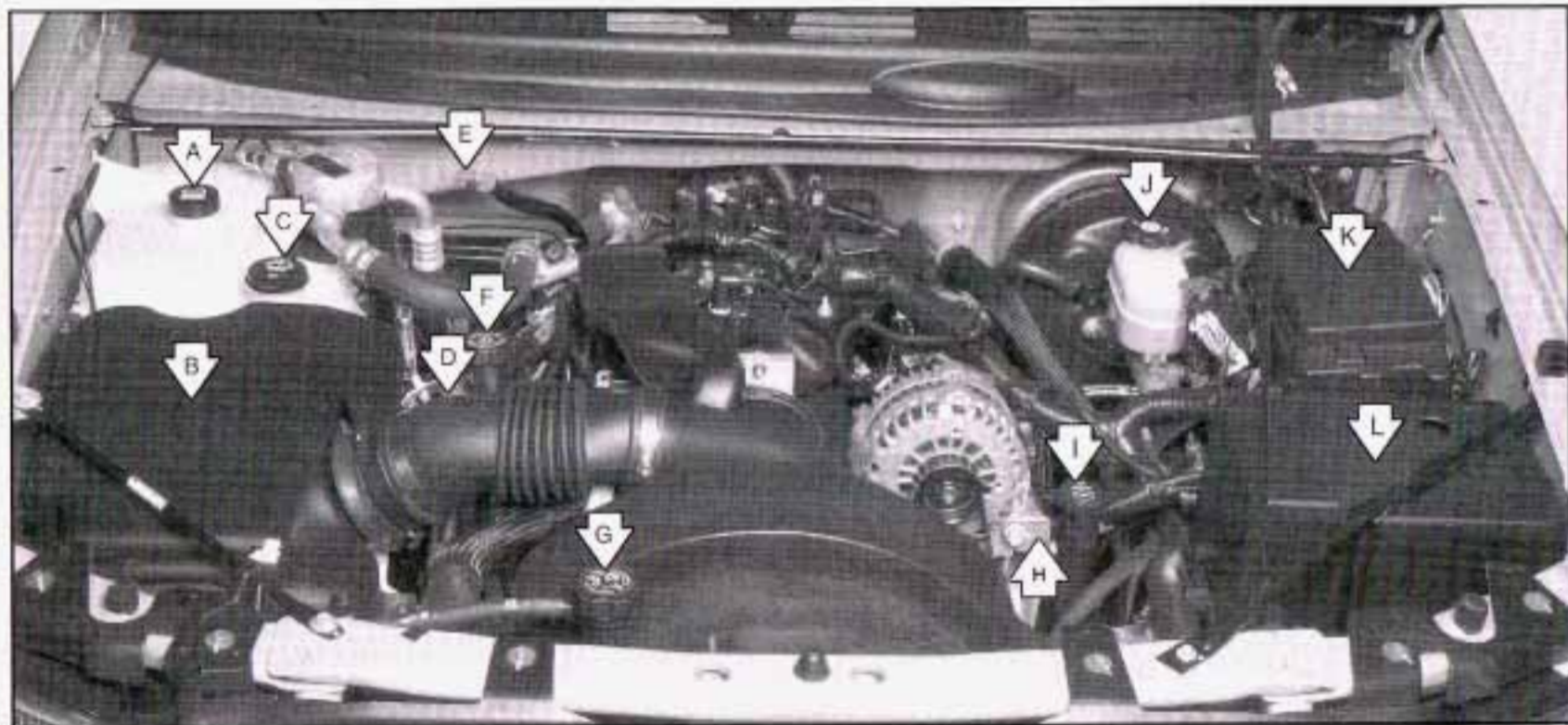

A. Coolant Recovery Tank

B. Engine Air Cleaner/Filter

C. Windshield Washer Fluid Reservoir

D. Engine Oil Dipstick

E. Automatic Transmission Dipstick

F. Engine Oil Fill Cap

G. Radiator Pressure Cap

H. Remote Negative (-) Terminal Marked "GND"

- I. Power Steering Fluid Reservoir
- J. Brake Master Cylinder
- K. Engine Compartment Fuse Block
- L. Battery

Before closing the hood, be sure all filler caps are on properly. Then lift the hood to relieve pressure on the hood prop. Remove the hood prop from its slot in the hood and return the prop to its retainer. Then pull the hood down firmly to close. It will latch when dropped from 6 to 8 inches (15 to 20 cm) without pressing on the hood.

## Engine Oil

You should check your engine oil level regularly; this is an added reminder.

### Checking Engine Oil

It's a good idea to check your engine oil every time you get fuel. In order to get an accurate reading, the oil must be warm and the vehicle must be on level ground.



The engine oil dipstick handle is a yellow ring located in the engine compartment toward the passenger's side of the vehicle. See *Engine Compartment Overview* on page 5-12 for more information on location.

Turn off the engine and give the oil several minutes to drain back into the oil pan. If you don't, the oil dipstick might not show the actual level.

Pull out the dipstick and clean it with a paper towel or cloth, then push it back in all the way. Remove it again, keeping the tip down, and check the level.

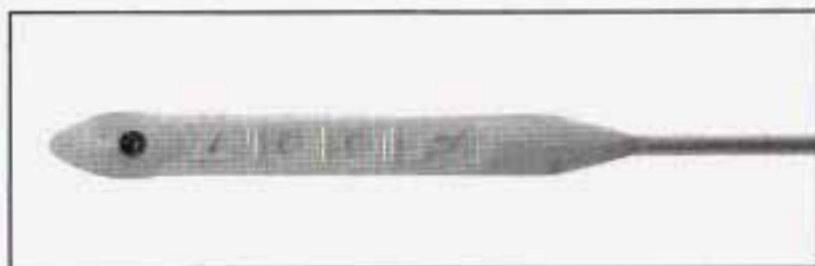

L6 Engine

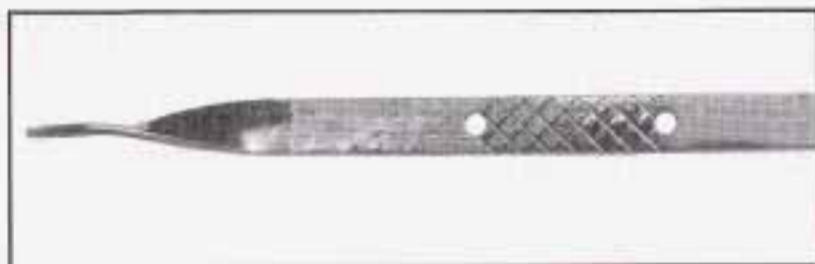

V8 Engine

## When to Add Engine Oil

If the oil is at or below the F mark for the L6 engine or the cross-hatched area at the tip of the dipstick for the V8 engine, then you'll need to add at least one quart of oil. But you must use the right kind. This part explains what kind of oil to use. For engine oil crankcase capacity, see *Capacities and Specifications on page 5-96*.

**Notice:** Don't add too much oil. If your engine has so much oil that the oil level gets above the F mark that shows the proper operating range for the L6 engine or above the cross-hatched area for the V8 engine, your engine could be damaged.



The engine oil fill cap is located in the engine compartment toward the passenger's side of the vehicle. See *Engine Compartment Overview on page 5-12* for more information on location.

Be sure to fill it enough to put the level somewhere in the proper operating range. Push the dipstick all the way back in when you're through.

## What Kind of Engine Oil to Use

Oils recommended for your vehicle can be identified by looking for the starburst symbol.

This symbol indicates that the oil has been certified by the American Petroleum Institute (API). Do not use any oil which does not carry this starburst symbol.



If you choose to perform the engine oil change service yourself, be sure the oil you use has the starburst symbol on the front of the oil container. If you have your oil changed for you, be sure the oil put into your engine is American Petroleum Institute certified for gasoline engines.

You should also use the proper viscosity oil for your vehicle, as shown in the viscosity chart.

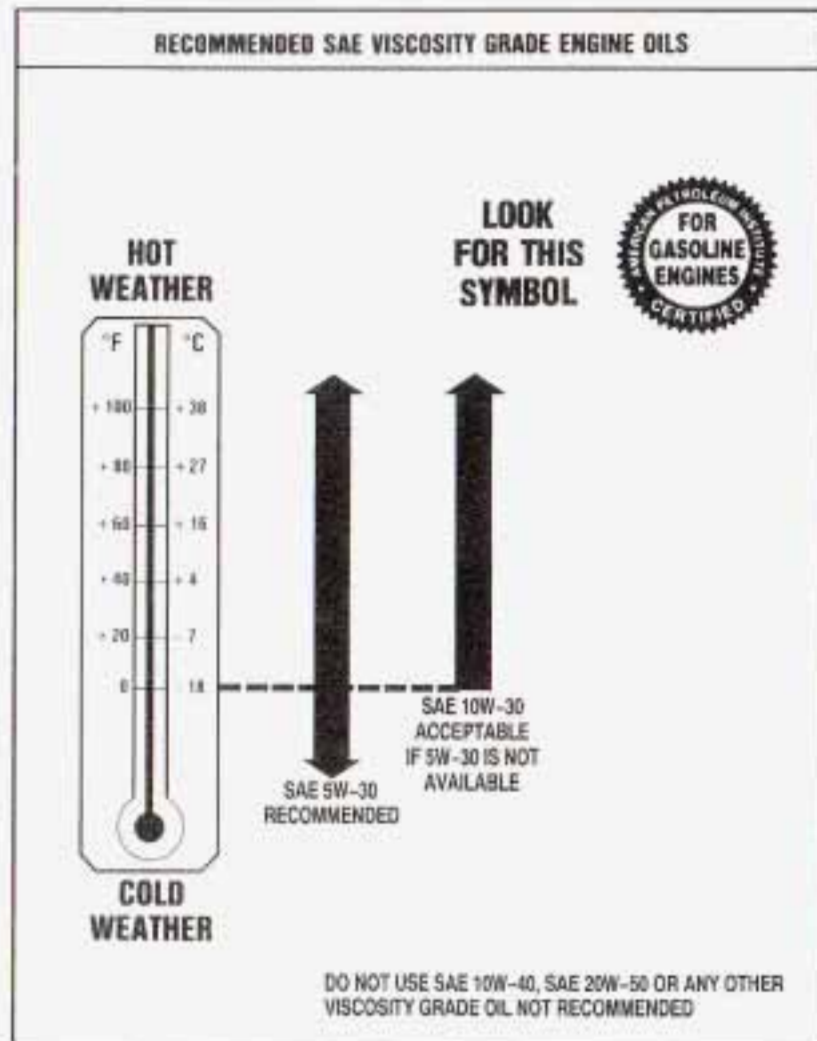

As in the chart shown previously, SAE 5W-30 is the only viscosity grade recommended for your vehicle. You should look for and use only oils which have the API Starburst symbol and which are also identified as SAE 5W-30. If you cannot find such SAE 5W-30 oils, you can use an SAE 10W-30 oil which has the API Starburst symbol, if it's going to be 0°F (-18°C) or above. Do not use other viscosity grade oils, such as SAE 10W-40 or SAE 20W-50 under any conditions.

**Notice:** Use only engine oil with the American Petroleum Institute Certified For Gasoline Engines starburst symbol. Failure to use the recommended oil can result in engine damage not covered by your warranty.

GM Goodwrench® oil meets all the requirements for your vehicle.

If you are in an area of extreme cold, where the temperature falls below -20°F (-29°C), it is recommended that you use either an SAE 5W-30 synthetic oil or an SAE 0W-30 oil. Both will provide easier cold starting and better protection for your engine at extremely low temperatures.

## Engine Oil Additives

Don't add anything to your oil. The recommended oils with the starburst symbol are all you will need for good performance and engine protection.

## When to Change Engine Oil (GM Oil Life System)

Your vehicle has a computer system that lets you know when to change the engine oil and filter. This is based on engine revolutions and engine temperature, and not on mileage. Based on driving conditions, the mileage at which an oil change will be indicated can vary considerably. For the oil life system to work properly, you must reset the system every time the oil is changed.

When the system has calculated that oil life has been diminished, it will indicate that an oil change is necessary. A CHANGE ENG OIL light in the Driver Information Center (DIC) will come on. Change your oil as soon as possible within the next two times you stop for fuel. It is possible that, if you are driving under the best conditions, the oil life system may not indicate that an oil change is necessary for over a year. However, your engine oil and filter must be changed at least once a year and at this time the system must be reset. It is also important to check your oil regularly and keep it at the proper level.

If the system is ever reset accidentally, you must change your oil at 3,000 miles (5 000 km) since your last oil change. Remember to reset the oil life system whenever the oil is changed.

## How to Reset the CHANGE ENG OIL Light

The GM Oil Life System calculates when to change your engine oil and filter based on vehicle use. Anytime your oil is changed, reset the system so it can calculate when the next oil change is required. If a situation occurs where you change your oil prior to a CHANGE ENG OIL light being turned on, reset the system.

To reset the CHANGE ENG OIL light, do the following:

1. Turn the ignition key to RUN with the engine off.
2. Fully press and release the accelerator pedal three times within five seconds.

For vehicles with the Driver Information Center, see *Driver Information Center (DIC) on page 3-46* to reset the system.

## What to Do with Used Oil

Used engine oil contains certain elements that may be unhealthy for your skin and could even cause cancer. Don't let used oil stay on your skin for very long. Clean your skin and nails with soap and water, or a good hand cleaner. Wash or properly dispose of clothing or rags containing used engine oil. See the manufacturer's warnings about the use and disposal of oil products.

Used oil can be a threat to the environment. If you change your own oil, be sure to drain all the oil from the filter before disposal. Never dispose of oil by putting it in the trash, pouring it on the ground, into sewers, or into streams or bodies of water. Instead, recycle it by taking it to a place that collects used oil. If you have a problem properly disposing of your used oil, ask your dealer, a service station or a local recycling center for help.

## Engine Air Cleaner/Filter



The engine air cleaner/filter is located toward the front of the engine compartment on the passenger's side of the vehicle.

See *Engine Compartment Overview on page 5-12* for more information on engine air cleaner filter location.





Your vehicle may have this feature. The engine air cleaner/filter assembly has an indicator that lets you know when the air filter is dirty and needs to be serviced. The indicator is located on the engine air cleaner/filter air duct.

The service window (A) with the percentage scale shows the amount of engine air cleaner/filter life used.

When both service window (A) and service window (B) turn orange, replace the engine air cleaner/filter.

After changing the engine air cleaner/filter, press the button on top of the indicator to reset it.

For vehicles without an indicator, refer to the maintenance schedule to determine when to replace the engine air cleaner/filter.

To check or replace the engine air cleaner/filter, do the following:

1. Remove the three screws on the engine air cleaner/filter and lift off the cover.

2. Twist out the old engine air cleaner/filter and replace it with a new one, if needed.
3. Reinstall the cover.

### CAUTION:

Operating the engine with the air cleaner/filter off can cause you or others to be burned. The air cleaner not only cleans the air, it stops flame if the engine backfires. If it isn't there and the engine backfires, you could be burned. Don't drive with it off, and be careful working on the engine with the air cleaner/filter off.

**Notice:** If the air cleaner/filter is off, a backfire can cause a damaging engine fire. And, dirt can easily get into your engine, which will damage it. Always have the air cleaner/filter in place when you're driving.

## Automatic Transmission Fluid

### When to Check and Change

A good time to check your automatic transmission fluid level is when the engine oil is changed.

Change both the fluid and filter every 50,000 miles (83 000 km) if the vehicle is mainly driven under one or more of these conditions:

- In heavy city traffic where the outside temperature regularly reaches 90°F (32°C) or higher.
- In hilly or mountainous terrain.
- When doing frequent trailer towing.
- Uses such as found in taxi, police or delivery service.

If you do not use your vehicle under any of these conditions, change the fluid and filter every 100,000 miles (166 000 km).

### How to Check

Because this operation can be a little difficult, you may choose to have this done at the dealership service department.

If you do it yourself, be sure to follow all the instructions here, or you could get a false reading on the dipstick.

**Notice:** Too much or too little fluid can damage your transmission. Too much can mean that some of the fluid could come out and fall on hot engine

part or exhaust system parts, starting a fire. Too little fluid could cause the transmission to overheat. Be sure to get an accurate reading if you check your transmission fluid.

Wait at least 30 minutes before checking the transmission fluid level if you have been driving:

- When outside temperatures are above 90°F (32°C).
- At high speed for quite a while.
- In heavy traffic-especially in hot weather.
- While pulling a trailer.

To get the right reading, the fluid should be at normal operating temperature, which is 180°F to 200°F (82°C to 93°C).

Get the vehicle warmed up by driving about 15 miles (24 km) when outside temperatures are above 50°F (10°C). If it's colder than 50°F (10°C), drive the vehicle in THIRD (3) until the engine temperature gage moves and then remains steady for 10 minutes.

A cold fluid check can be made after the vehicle has been sitting for eight hours or more with the engine off, but this is used only as a reference. Let the engine run at idle for five minutes if outside temperatures are 50°F (10°C) or more. If it's colder than 50°F (10°C), you may have to idle the engine longer. Should the fluid level be low during this cold check, you *must* check the fluid hot before adding fluid. Checking the fluid hot will give you a more accurate reading of the fluid level.

## Checking the Fluid Level

Prepare your vehicle as follows:

- Park your vehicle on a level place. Keep the engine running.
- With the parking brake applied, place the shift lever in PARK (P).
- With your foot on the brake pedal, move the shift lever through each gear range, pausing for about three seconds in each range. Then, position the shift lever in PARK (P).
- Let the engine run at idle for three minutes or more.

Then, without shutting off the engine, follow these steps:



The automatic transmission dipstick handle with the transmission and lock symbol is located in the engine compartment on the passenger's side of the vehicle.

See *Engine Compartment Overview* on page 5-12 for more information on location.

1. Flip the handle up and then pull out the dipstick and wipe it with a clean rag or paper towel.

2. Push it back in all the way, wait three seconds and then pull it back out again.



3. If the fluid level is in the acceptable range, push the dipstick back in all the way; then flip the handle down to lock the dipstick in place.

## How to Add Fluid

Refer to the Maintenance Schedule to determine what kind of transmission fluid to use. See *Part D: Recommended Fluids and Lubricants* on page 6-15.

Add fluid only after checking the transmission fluid while it is hot. (A cold check is used only as a reference.) If the fluid level is low, add only enough of the proper fluid to bring the level up to the HOT area for a hot check. It doesn't take much fluid, generally less than one pint (0.5 L). *Don't overfill.*

**Notice:** We recommend you use only fluid labeled DEXRON® -III, because fluid with that label is made especially for your automatic transmission. Damage caused by fluid other than DEXRON® -III is not covered by your new vehicle warranty.

- After adding fluid, recheck the fluid level as described under “How to Check”.
- When the correct fluid level is obtained, push the dipstick back in all the way; then flip the handle down to lock the dipstick in place.

## Engine Coolant

The cooling system in your vehicle is filled with DEX-COOL® engine coolant. This coolant is designed to remain in your vehicle for 5 years or 150,000 miles (240 000 km), whichever occurs first, if you add only DEX-COOL® extended life coolant.

The following explains your cooling system and how to add coolant when it is low. If you have a problem with engine overheating, see *Engine Overheating on page 5-25*.

A 50/50 mixture of clean, drinkable water and DEX-COOL® coolant will:

- Give freezing protection down to -34°F (-37°C).
- Give boiling protection up to 265°F (129°C).

- Protect against rust and corrosion.
- Help keep the proper engine temperature.
- Let the warning lights and gages work as they should.

**Notice:** When adding coolant, it is important that you use only DEX-COOL® (silicate-free) coolant. If coolant other than DEX-COOL® is added to the system, premature engine, heater core or radiator corrosion may result. In addition, the engine coolant will require change sooner – at 30,000 miles (50,000 km) or 24 months, whichever occurs first. Damage caused by the use of coolant other than DEX-COOL® is not covered by your new vehicle warranty.

## What to Use

Use a mixture of one-half *clean, drinkable water* and one-half DEX-COOL® coolant which won't damage aluminum parts. If you use this coolant mixture, you don't need to add anything else.

## CAUTION:

Adding only plain water to your cooling system can be dangerous. Plain water, or some other liquid such as alcohol, can boil before the proper coolant mixture will. Your vehicle's coolant warning system is set for the proper coolant mixture. With plain water or the wrong mixture, your engine could get too hot but you wouldn't get the overheat warning. Your engine could catch fire and you or others could be burned. Use a 50/50 mixture of clean, drinkable water and DEX-COOL<sup>®</sup> coolant.

**Notice:** If you use an improper coolant mixture, your engine could overheat and be badly damaged. The repair cost wouldn't be covered by your warranty. Too much water in the mixture can freeze and crack the engine, radiator, heater core and other parts.

If you have to add coolant more than four times a year, have your dealer check your cooling system.

**Notice:** If you use the proper coolant, you don't have to add extra inhibitors or additives which claim to improve the system. These can be harmful.

## Checking Coolant



The engine coolant recovery tank is in the engine compartment on the passenger's side of the vehicle. See *Engine Compartment Overview* on page 5-12 for more information on location.

The vehicle must be on a level surface. When your engine is cold, the coolant level should be at FULL COLD, or a little higher. When your engine is warm, the level should be at the base of the filler neck or a little higher.

## Adding Coolant

If you need more coolant, add the proper DEX-COOL<sup>®</sup> coolant mixture *at the coolant recovery tank*.

## CAUTION:

Turning the radiator pressure cap when the engine and radiator are hot can allow steam and scalding liquids to blow out and burn you badly. With the coolant recovery tank, you will almost never have to add coolant at the radiator. Never turn the radiator pressure cap – even a little – when the engine and radiator are hot.

Add coolant mixture at the recovery tank, but be careful not to spill it.

## CAUTION:

You can be burned if you spill coolant on hot engine parts. Coolant contains ethylene glycol, and it will burn if the engine parts are hot enough. Don't spill coolant on a hot engine.

Occasionally check the coolant level in the radiator. For information on how to add coolant to the radiator, see *Cooling System* on page 5-28.

## Radiator Pressure Cap

**Notice:** Your pressure cap is a pressure-type cap and must be tightly installed to prevent coolant loss and possible engine damage from overheating. See “Capacities and Specifications” for more information.

See *Engine Compartment Overview* on page 5-12 for information on location.

## Engine Overheating

You will find a coolant temperature gage on your vehicle's instrument panel.

## If Steam Is Coming From Your Engine

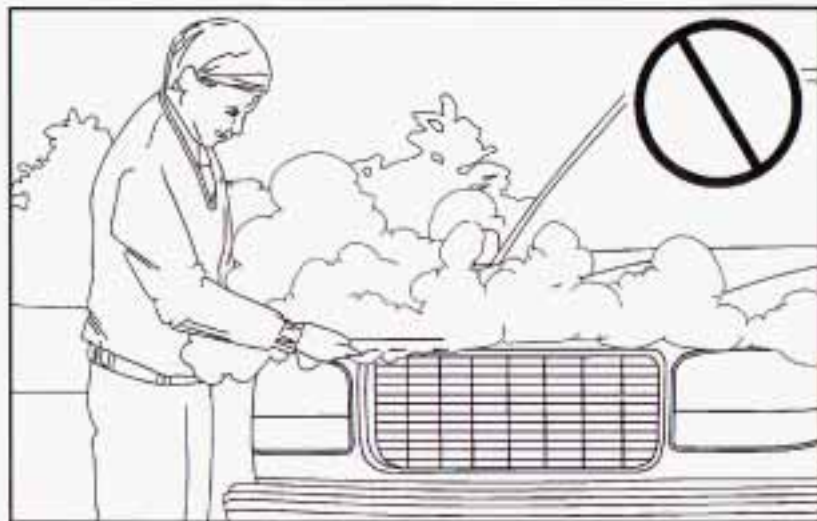

### **⚠ CAUTION:**

Steam from an overheated engine can burn you badly, even if you just open the hood. Stay away from the engine if you see or hear steam coming from it. Just turn it off and get everyone away from the vehicle until it cools down. Wait until there is no sign of steam or coolant before you open the hood.

If you keep driving when your engine is overheated, the liquids in it can catch fire. You or others could be badly burned. Stop your engine if it overheats, and get out of the vehicle until the engine is cool.

**Notice:** If your engine catches fire because you keep driving with no coolant, your vehicle can be badly damaged. The costly repairs would not be covered by your warranty.

## If No Steam Is Coming From Your Engine

If you get an engine overheat warning but see or hear no steam, the problem may not be too serious. Sometimes the engine can get a little too hot when you:

- Climb a long hill on a hot day.
- Stop after high-speed driving.
- Idle for long periods in traffic.
- Tow a trailer.

If you get the overheat warning with no sign of steam, try this for a minute or so:

1. In heavy traffic, let the engine idle in neutral while stopped. If it is safe to do so, pull off the road, shift to PARK (P) or NEUTRAL (N) and let the engine idle.
2. Turn on your heater to full hot at the highest fan speed and open the window as necessary.

If you no longer have the overheat warning, you can drive. Just to be safe, drive slower for about 10 minutes. If the warning doesn't come back on, you can drive normally.

If the warning continues and you have not stopped, pull over, stop, and park your vehicle right away.

If there's still no sign of steam, you can push down the accelerator until the engine speed is about twice as fast as normal idle speed for at least three minutes while you're parked. If you still have the warning, *turn off the engine and get everyone out of the vehicle* until it cools down.

You may decide not to lift the hood but to get service help right away.



## Cooling System

When you decide it's safe to lift the hood, here's what you'll see:

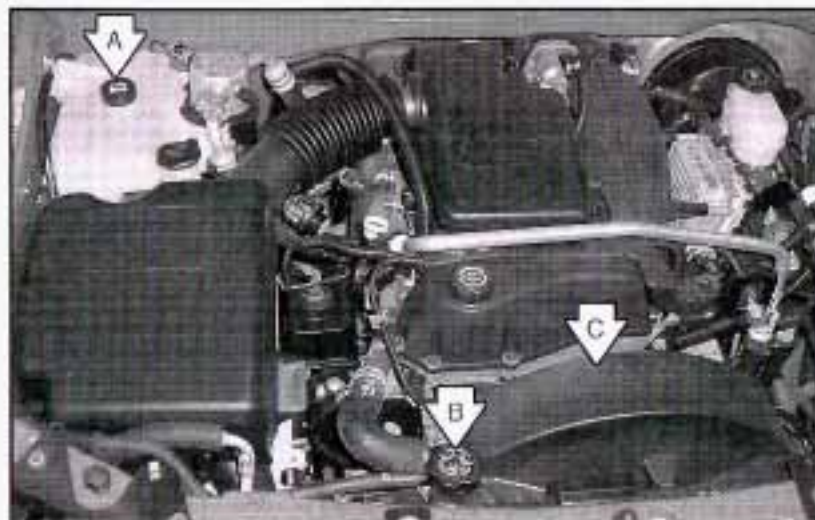

**L6 Engine**

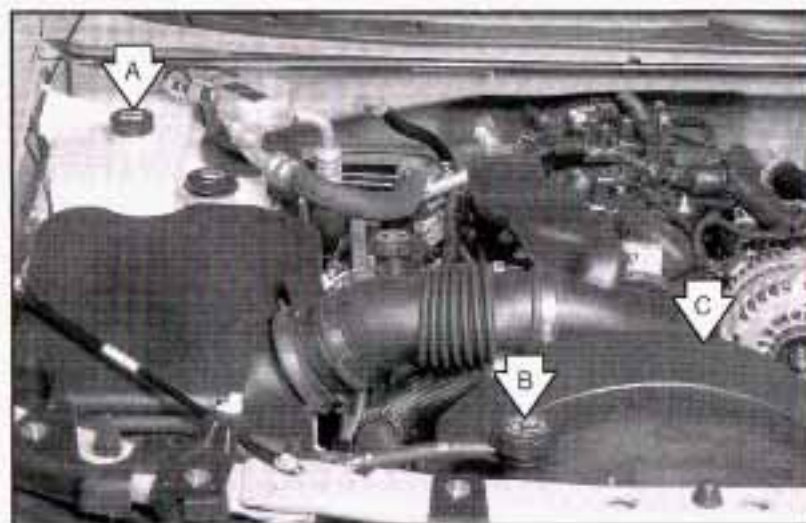

**V8 Engine**

- A. Coolant Recovery Tank
- B. Radiator Pressure Cap
- C. Engine Fan

If the coolant inside the coolant recovery tank is boiling, don't do anything else until it cools down. The vehicle should be parked on a level surface.



The coolant level should be at least up to the FULL COLD mark. If it isn't, you may have a leak at the pressure cap or in the radiator hoses, heater hoses, radiator, water pump or somewhere else in the cooling system.

If there seems to be no leak, start the engine again. The engine cooling fan speed should increase when idle speed is doubled by pushing the accelerator pedal down. If it doesn't, your vehicle needs service. Turn off the engine.

**Notice:** Engine damage from running your engine without coolant isn't covered by your warranty.

**Notice:** When adding coolant, it is important that you use only DEX-COOL<sup>®</sup> (silicate-free) coolant. If coolant other than DEX-COOL<sup>®</sup> is added to the system, premature engine, heater core or radiator corrosion may result. In addition, the engine coolant will require change sooner — at 30,000 miles (50 000 km) or 24 months, whichever occurs first. Damage caused by the use of coolant other than DEX-COOL<sup>®</sup> is not covered by your new vehicle warranty.

## How to Add Coolant to the Coolant Recovery Tank

If you haven't found a problem yet, but the coolant level isn't at the FULL COLD mark, add a 50/50 mixture of *clean, drinkable water* and DEX-COOL<sup>®</sup> engine coolant at the coolant recovery tank. See *Engine Coolant* on page 5-23 for more information.

### CAUTION:

Heater and radiator hoses, and other engine parts, can be very hot. Don't touch them. If you do, you can be burned.

Don't run the engine if there is a leak. If you run the engine, it could lose all coolant. That could cause an engine fire, and you could be burned. Get any leak fixed before you drive the vehicle.

**⚠ CAUTION:**

Adding only plain water to your cooling system can be dangerous. Plain water, or some other liquid such as alcohol, can boil before the proper coolant mixture will. Your vehicle's coolant warning system is set for the proper coolant mixture. With plain water or the wrong mixture, your engine could get too hot but you wouldn't get the overheat warning. Your engine could catch fire and you or others could be burned. Use a 50/50 mixture of clean, drinkable water and DEX COOL<sup>®</sup> coolant.

**Notice:** In cold weather, water can freeze and crack the engine, radiator, heater core and other parts. Use the recommended coolant and the proper coolant mixture.



**⚠ CAUTION:**

You can be burned if you spill coolant on hot engine parts. Coolant contains ethylene glycol and it will burn if the engine parts are hot enough. Don't spill coolant on a hot engine.

When the coolant in the coolant recovery tank is at the FULL COLD mark, start your vehicle.

If the overheat warning continues, there's one more thing you can try. You can add the proper coolant mixture directly to the radiator, but be sure the cooling system is cool before you do it.

**⚠ CAUTION:**

Steam and scalding liquids from a hot cooling system can blow out and burn you badly. They are under pressure, and if you turn the radiator pressure cap -- even a little -- they can come out at high speed. Never turn the cap when the cooling system, including the radiator pressure cap, is hot. Wait for the cooling system and radiator pressure cap to cool if you ever have to turn the pressure cap.

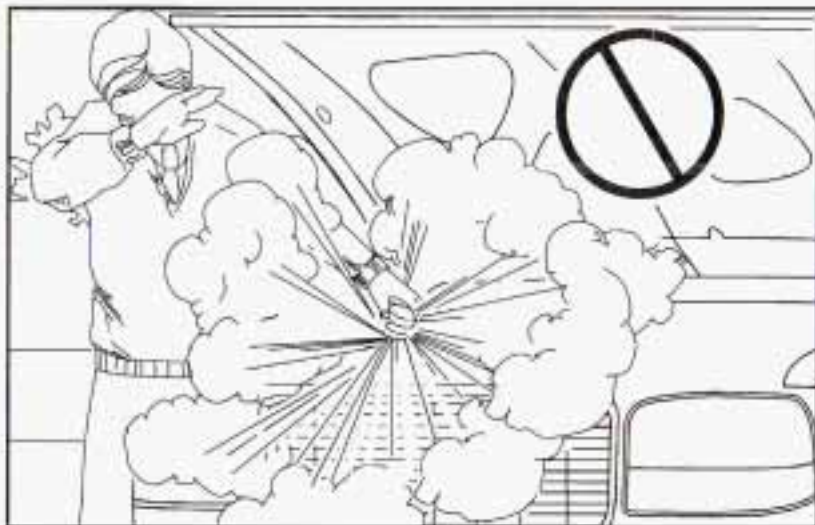

## How to Add Coolant to the Radiator



1. You can remove the radiator pressure cap when the cooling system, including the radiator pressure cap and upper radiator hose, is no longer hot. Turn the pressure cap slowly counterclockwise about one full turn.

If you hear a hiss, wait for that to stop. A hiss means there is still some pressure left.

2. Then keep turning the pressure cap. Remove the pressure cap.



3. Fill the radiator with the proper DEX-COOL<sup>®</sup> coolant mixture, up to the base of the filler neck. See *Engine Coolant* on page 5-23 for more information about the proper coolant mixture.

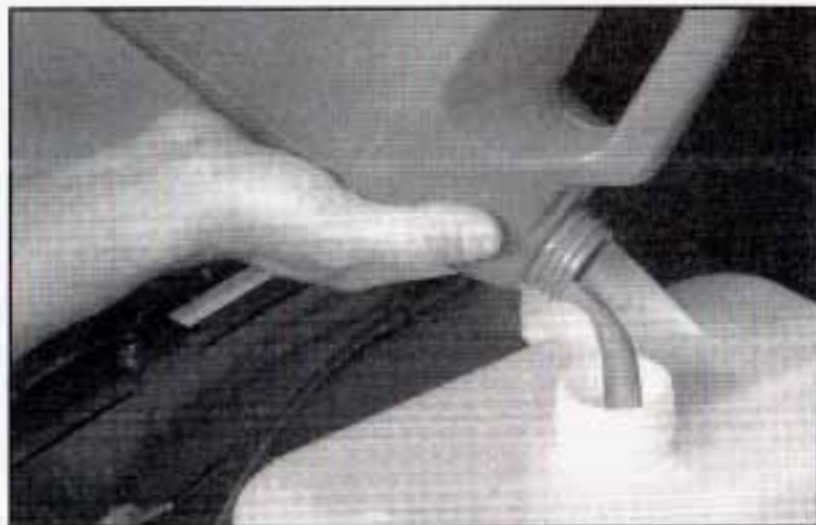

4. Then fill the coolant recovery tank to the FULL COLD mark.
5. Put the cap back on the coolant recovery tank, but leave the radiator pressure cap off.



## Engine Fan Noise

This vehicle has a clutched engine cooling fan. When the clutch is engaged, the fan spins faster to provide more air to cool the engine. In most everyday driving conditions the clutch is not engaged. This improves fuel economy and reduces fan noise. Under heavy vehicle loading, trailer towing, and/or high outside temperatures, the fan speed increases when the clutch engages. So you may hear an increase in fan noise. This is normal and should not be mistaken as the transmission slipping or making extra shifts. It is merely the cooling system functioning properly. The fan will slow down when additional cooling is not required and the clutch disengages.

You may also hear this fan noise when you start the engine. It will go away as the fan clutch disengages.

6. Start the engine and let it run until you can feel the upper radiator hose getting hot. Watch out for the engine cooling fan.
7. By this time, the coolant level inside the radiator filler neck may be lower. If the level is lower, add more of the proper DEX-COOL<sup>®</sup> coolant mixture through the filler neck until the level reaches the base of the filler neck.
8. Then replace the pressure cap. At any time during this procedure if coolant begins to flow out of the filler neck, reinstall the pressure cap. Be sure the pressure cap is hand-tight.

## Power Steering Fluid



The power steering fluid reservoir is located in the engine compartment. It is on the passenger's side of vehicles with the L6 engine and is on the driver's side of vehicles with the V8 engine.

### When to Check Power Steering Fluid

It is not necessary to regularly check power steering fluid unless you suspect there is a leak in the system or you hear an unusual noise. A fluid loss in this system could indicate a problem. Have the system inspected and repaired. See *Engine Compartment Overview on page 5-12* for reservoir location.

### How to Check Power Steering Fluid

Turn the key off, let the engine compartment cool down, wipe the cap and the top of the reservoir clean, then unscrew the cap and wipe the dipstick with a clean rag.

Replace the cap and completely tighten it. Then remove the cap again and look at the fluid level on the dipstick.

For vehicles with the L6 engine, the level should be at the C (cold) mark. For vehicles with the V8 engine, the level should be at the FULL mark. If necessary, add only enough fluid to bring the level up to the mark.

### What to Use

To determine what kind of fluid to use, see *Part D: Recommended Fluids and Lubricants on page 6-15*. Always use the proper fluid. Failure to use the proper fluid can cause leaks and damage hoses and seals.

## Windshield Washer Fluid

### What to Use

When you need windshield washer fluid, be sure to read the manufacturer's instructions before use. If you will be operating your vehicle in an area where the temperature may fall below freezing, use a fluid that has sufficient protection against freezing. See *Engine Compartment Overview on page 5-12* for reservoir location.



## Adding Washer Fluid



Open the cap with the washer symbol on it. Add washer fluid until the tank is full.

### Notice:

- When using concentrated washer fluid, follow the manufacturer's instructions for adding water.
- Don't mix water with ready-to-use washer fluid. Water can cause the solution to freeze and damage your washer fluid tank and other parts of the washer system. Also, water doesn't clean as well as washer fluid.
- Fill your washer fluid tank only three-quarters full when it's very cold. This allows for expansion if freezing occurs, which could damage the tank if it is completely full.
- Don't use engine coolant (antifreeze) in your windshield washer. It can damage your washer system and paint.

## Brakes

### Brake Fluid



Your brake master cylinder reservoir is filled with DOT-3 brake fluid. See *Engine Compartment Overview* on page 5-12 for the location of the reservoir.

There are only two reasons why the brake fluid level in the reservoir might go down. The first is that the brake fluid goes down to an acceptable level during normal brake lining wear. When new linings are put in, the fluid level goes back up. The other reason is that fluid is leaking out of the brake system. If it is, you

should have your brake system fixed, since a leak means that sooner or later your brakes won't work well, or won't work at all.

So, it isn't a good idea to "top off" your brake fluid. Adding brake fluid won't correct a leak. If you add fluid when your linings are worn, then you'll have too much fluid when you get new brake linings. You should add (or remove) brake fluid, as necessary, only when work is done on the brake hydraulic system.

### **⚠ CAUTION:**

**If you have too much brake fluid, it can spill on the engine. The fluid will burn if the engine is hot enough. You or others could be burned, and your vehicle could be damaged. Add brake fluid only when work is done on the brake hydraulic system. See "Checking Brake Fluid" in this section.**

Refer to the Maintenance Schedule to determine when to check your brake fluid. See *Part C: Periodic Maintenance Inspections* on page 6-13.

## Checking Brake Fluid

You can check the brake fluid without taking off the cap.



Just look at the brake fluid reservoir. The fluid level should be above MIN. If it isn't have your brake system checked to see if there is a leak.

After work is done on the brake hydraulic system, make sure the level is above the MIN but not over the MAX mark.

## What to Add

When you do need brake fluid, use only DOT-3 brake fluid. Use new brake fluid from a sealed container only. See *Part D: Recommended Fluids and Lubricants* on page 6-15.

Always clean the brake fluid reservoir cap and the area around the cap before removing it. This will help keep dirt from entering the reservoir.

## CAUTION:

With the wrong kind of fluid in your brake system, your brakes may not work well, or they may not even work at all. This could cause a crash. Always use the proper brake fluid.

### *Notice:*

- Using the wrong fluid can badly damage brake system parts. For example, just a few drops of mineral-based oil, such as engine oil, in your brake system can damage brake system parts so badly that they'll have to be replaced. Don't let someone put in the wrong kind of fluid.
- If you spill brake fluid on your vehicle's painted surfaces, the paint finish can be damaged. Be careful not to spill brake fluid on your vehicle. If you do, wash it off immediately. See "Appearance Care" in the Index.

## Brake Wear

Your vehicle has four-wheel disc brakes.

Disc brake pads have built-in wear indicators that make a high-pitched warning sound when the brake pads are worn and new pads are needed.

The sound may come and go or be heard all the time your vehicle is moving (except when you are pushing on the brake pedal firmly).

## CAUTION:

The brake wear warning sound means that soon your brakes won't work well. That could lead to an accident. When you hear the brake wear warning sound, have your vehicle serviced.

***Notice:*** Continuing to drive with worn-out brake pads could result in costly brake repair.

Some driving conditions or climates may cause a brake squeal when the brakes are first applied or lightly applied. This does not mean something is wrong with your brakes.

Properly torqued wheel nuts are necessary to help prevent brake pulsation. When tires are rotated, inspect brake pads for wear and evenly tighten wheel nuts in the proper sequence to GM torque specifications.

Brake linings should always be replaced as complete axle sets.

See *Brake System Inspection* on page 6-14.

## Brake Pedal Travel

See your dealer if the brake pedal does not return to normal height, or if there is a rapid increase in pedal travel. This could be a sign of brake trouble.

## Brake Adjustment

Every time you make a brake stop, your disc brakes adjust for wear.

## Replacing Brake System Parts

The braking system on a vehicle is complex. Its many parts have to be of top quality and work well together if the vehicle is to have really good braking. Your vehicle was designed and tested with top-quality GM brake parts. When you replace parts of your braking system – for example, when your brake linings wear down and you need new ones put in – be sure you get new approved GM replacement parts. If you don't, your brakes may no longer work properly. For example, if someone puts in brake linings that are wrong for your vehicle, the balance between your front and rear brakes can change — for the worse. The braking performance you've come to expect can change in many other ways if someone puts in the wrong replacement brake parts.

## Battery

Your new vehicle comes with a maintenance free ACDelco® battery. When it's time for a new battery, get one that has the replacement number shown on the original battery's label. We recommend an ACDelco® battery. See *Engine Compartment Overview on page 5-12* for battery location.

**Warning:** Battery posts, terminals and related accessories contain lead and lead compounds, chemicals known to the State of California to cause cancer and reproductive harm. Wash hands after handling.

## Vehicle Storage

If you're not going to drive your vehicle for 25 days or more, remove the black, negative (-) cable from the battery. This will help keep your battery from running down.

## CAUTION:

Batteries have acid that can burn you and gas that can explode. You can be badly hurt if you aren't careful. See "Jump Starting" next for tips on working around a battery without getting hurt.

Contact your dealer to learn how to prepare your vehicle for longer storage periods.

Also, for your audio system, see *Theft-Deterrent Feature (RDS Radios)* on page 3-94.

## Jump Starting

If your battery has run down, you may want to use another vehicle and some jumper cables to start your vehicle. But please use the following steps to do it safely.

## CAUTION:

Batteries can hurt you. They can be dangerous because:

- They contain acid that can burn you.
- They contain gas that can explode or ignite.
- They contain enough electricity to burn you.

**If you don't follow these steps exactly, some or all of these things can hurt you.**

**Notice:** Ignoring these steps could result in costly damage to your vehicle that wouldn't be covered by your warranty.

**Trying to start your vehicle by pushing or pulling it won't work, and it could damage your vehicle.**

1. Check the other vehicle. It must have a 12-volt battery with a negative ground system.

**Notice:** If the other system isn't a 12-volt system with a negative ground, both vehicles can be damaged.

2. Get the vehicles close enough so the jumper cables can reach, but be sure the vehicles aren't touching each other. If they are, it could cause a ground connection you don't want. You wouldn't be able to start your vehicle, and the bad grounding could damage the electrical systems.

To avoid the possibility of the vehicles rolling, set the parking brake firmly on both vehicles involved in the jump start procedure. Put an automatic transmission in PARK (P) or a manual transmission in NEUTRAL before setting the parking brake. If you have a four-wheel-drive vehicle, be sure the transfer case is not in NEUTRAL.

**Notice:** If you leave your radio on, it could be badly damaged. The repairs wouldn't be covered by your warranty.

3. Turn off the ignition on both vehicles. Unplug unnecessary accessories plugged into the cigarette lighter or accessory power outlets (if equipped). Turn off the radio and all lamps that aren't needed. This will avoid sparks and help to save both batteries. And it could save your radio!
4. Open both hoods and locate the batteries. Find the positive (+) and negative (-) terminals on each battery. Your vehicle has a remote negative (-) jump starting terminal. You should always use this

remote terminal instead of the terminal on the battery. The remote negative (-) terminal is located on the front engine lift bracket and is marked "GND." See *Engine Compartment Overview* on page 5-12 for more information on location.

### CAUTION:

**Using a match near a battery can cause battery gas to explode. People have been hurt doing this, and some have been blinded. Use a flashlight if you need more light.**

**Be sure the battery has enough water. You don't need to add water to the ACDelco<sup>®</sup> battery installed in your new vehicle. But if a battery has filler caps, be sure the right amount of fluid is there. If it is low, add water to take care of that first. If you don't, explosive gas could be present.**

**Battery fluid contains acid that can burn you. Don't get it on you. If you accidentally get it in your eyes or on your skin, flush the place with water and get medical help immediately.**

**⚠ CAUTION:**

Fans or other moving engine parts can injure you badly. Keep your hands away from moving parts once the engine is running.

5. Check that the jumper cables don't have loose or missing insulation. If they do, you could get a shock. The vehicles could be damaged too.

Before you connect the cables, here are some basic things you should know. Positive (+) will go to positive (+) or to a remote positive (+) terminal if the vehicle has one. Negative (-) will go to a heavy, unpainted metal engine part or to a remote negative (-) terminal if the vehicle has one. Don't connect positive (+) to negative (-) or you'll get a short that would damage the battery and maybe other parts too. And don't connect the negative (-) cable to the negative (-) terminal on the dead battery because this can cause sparks.



6. Connect the red positive (+) cable to the positive (+) terminal of the dead battery. Use a remote positive (+) terminal if the vehicle has one.



7. Don't let the other end touch metal. Connect it to the positive (+) terminal of the good battery. Use a remote positive (+) terminal if the vehicle has one.



8. Now connect the black negative (-) cable to the negative (-) terminal of the good battery. Use a remote negative (-) terminal if the vehicle has one.

Don't let the other end touch anything until the next step. The other end of the negative (-) cable *doesn't* go to the dead battery. It goes to a heavy, unpainted metal engine part or to the remote negative (-) terminal on the vehicle with the dead battery. In the L6 engine, the remote negative (-) terminal is located on the front engine lift bracket and is marked "GND." In the V8 engine, the remote negative (-) terminal is located on the accessory drive bracket and is marked "GND".



9. Connect the other end of the negative (-) cable to the remote negative (-) terminal on the vehicle with the dead battery.

10. Now start the vehicle with the good battery and run the engine for a while.
11. Try to start the vehicle that had the dead battery. If it won't start after a few tries, it probably needs service.

**Notice:** Damage to your vehicle may result from electrical shorting if jumper cables are removed incorrectly. To prevent electrical shorting, take care that the cables don't touch each other or any other metal. The repairs wouldn't be covered by your warranty.



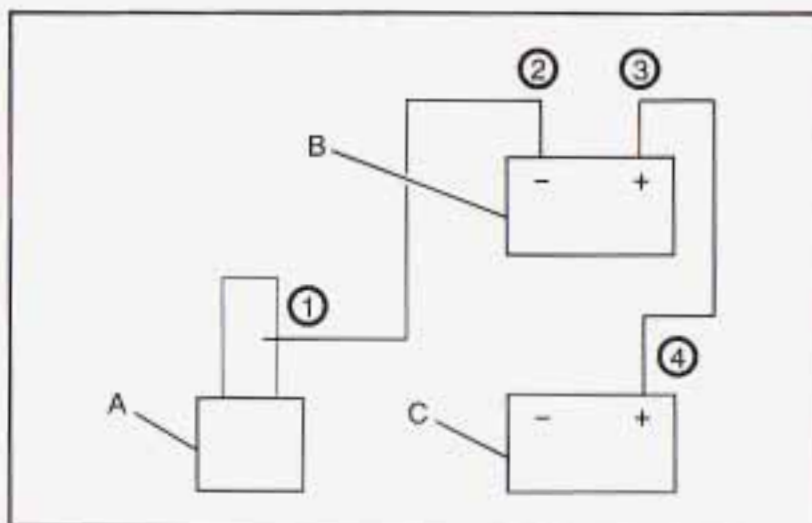

### Jumper Cable Removal

- A. Heavy, Unpainted Metal Engine Part or Remote Negative (-) Terminal
- B. Good Battery or Remote Positive (+) and Remote Negative (-) Terminals
- C. Dead Battery or Remote Positive (+) Terminal

To disconnect the jumper cables from both vehicles, do the following:

1. Disconnect the black negative (-) cable from the vehicle that had the dead battery.
2. Disconnect the black negative (-) cable from the vehicle with the good battery.
3. Disconnect the red positive (+) cable from the vehicle with the good battery.
4. Disconnect the red positive (+) cable from the other vehicle.

## Rear Axle

### When to Check Lubricant

Refer to the Maintenance Schedule to determine how often to check the lubricant.

### How to Check Lubricant

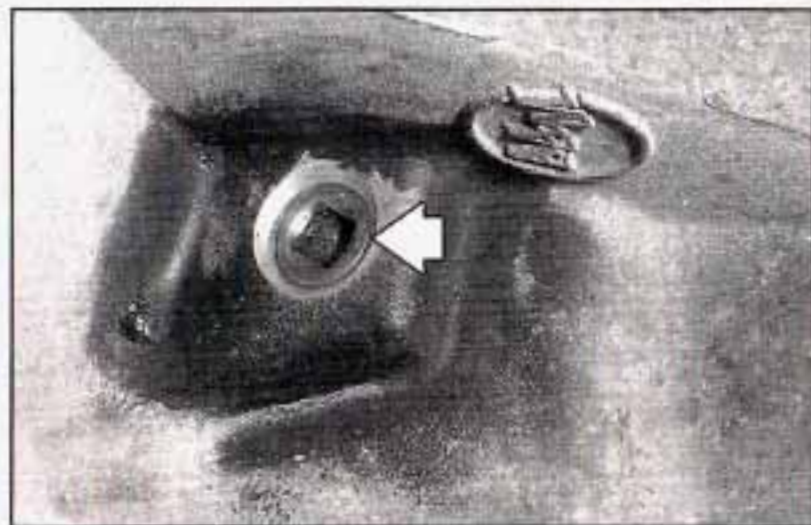

To get an accurate reading, the vehicle should be on a level surface.

The proper level is from 0 to 3/8 inch (0 to 10 mm) below the bottom of the filler plug hole.

### What to Use

Refer to the Maintenance Schedule to determine what kind of lubricant to use. See *Part D: Recommended Fluids and Lubricants* on page 6-15.

## Four-Wheel Drive

Lubricant checks in this section also apply to these vehicles. However, there are two additional systems that need lubrication.

### Transfer Case

#### When to Check Lubricant

Refer to the Maintenance Schedule to determine how often to check the lubricant. See *Part C: Periodic Maintenance Inspections* on page 6-13.

#### How to Check Lubricant

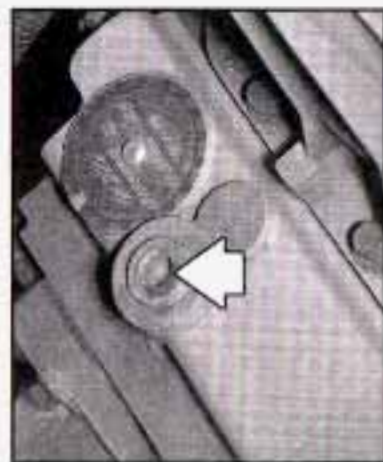

To get an accurate reading, the vehicle should be on a level surface.

If the level is below the bottom of the filler plug hole, you'll need to add some lubricant. Add enough lubricant to raise the level to the bottom of the filler plug hole. Use care not to overtighten the plug.

#### What to Use

Refer to the Maintenance Schedule to determine what kind of lubricant to use. See *Part D: Recommended Fluids and Lubricants* on page 6-15.

### Front Axle

#### When to Check and Change Lubricant

Refer to the Maintenance Schedule to determine how often to check the lubricant and when to change it.

## How to Check Lubricant

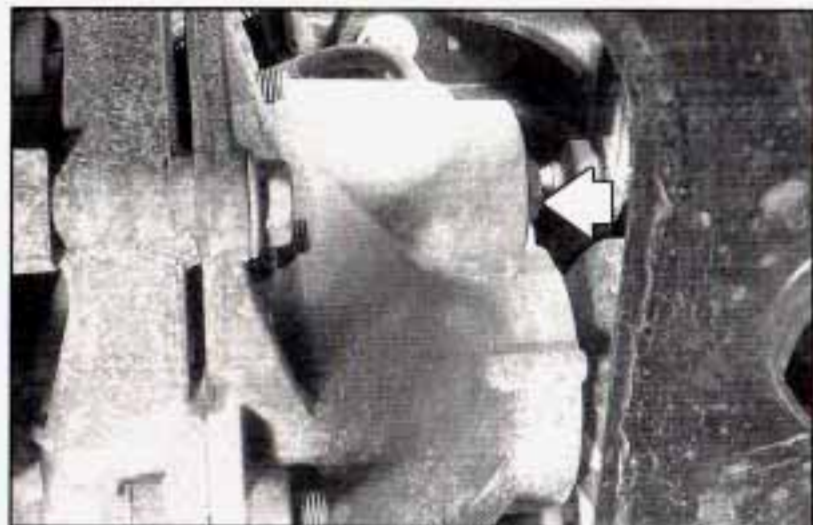

To get an accurate reading, the vehicle should be on a level surface.

If the level is below the bottom of the filler plug hole, you may need to add some lubricant.

When the differential is cold, add enough lubricant to raise the level to 1/2 inch (12 mm) below the filler plug hole.

When the differential is at operating temperature (warm), add enough lubricant to raise the level to the bottom of the filler plug hole.

### What to Use

Refer to the Maintenance Schedule to determine what kind of lubricant to use. See *Part D: Recommended Fluids and Lubricants* on page 6-15.

## Bulb Replacement

For the type of bulbs, see *Replacement Bulbs on page 5-49*.

For any bulb changing procedure not listed in this section, contact your dealer.

## Taillamps and Turn Signal Lamps

1. Open the liftgate.

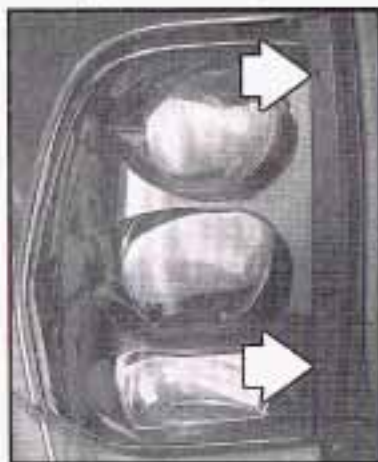

2. Remove the two screws from the lamp assembly.

3. Pull the assembly away from the vehicle.

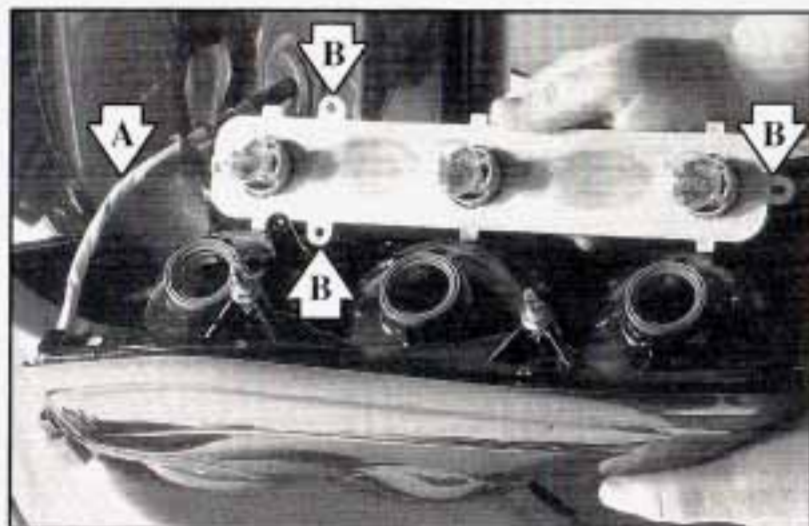

4. Unclip the wiring harness (A) and remove the three socket retaining screws (B).
5. Remove the socket by releasing the retaining tabs.

6. Holding the socket, pull the bulb to release it from the socket.
7. Push the new bulb into the socket until it clicks.
8. Reinstall the socket and screws.
9. Reconnect the wiring harness.
10. Reinstall the lamp assembly and tighten the screws.
11. Close the liftgate.

## Replacement Bulbs

Exterior Lamp	Bulb Number
Taillamps	3157
Rear Turn Signal Lamps	3157
For any bulb not listed here, contact your dealer.	

## Windshield Wiper Blade Replacement

Windshield wiper blades should be inspected at least twice a year for wear or cracking.

See *Normal Maintenance Replacement Parts* on page 5-98 for the proper type of replacement blade.

**Notice:** Use care when removing or installing a blade assembly. Accidental bumping can cause the arm to fall back and strike the windshield.

1. To remove the old wiper blades, lift the wiper arm until it locks into a vertical position.

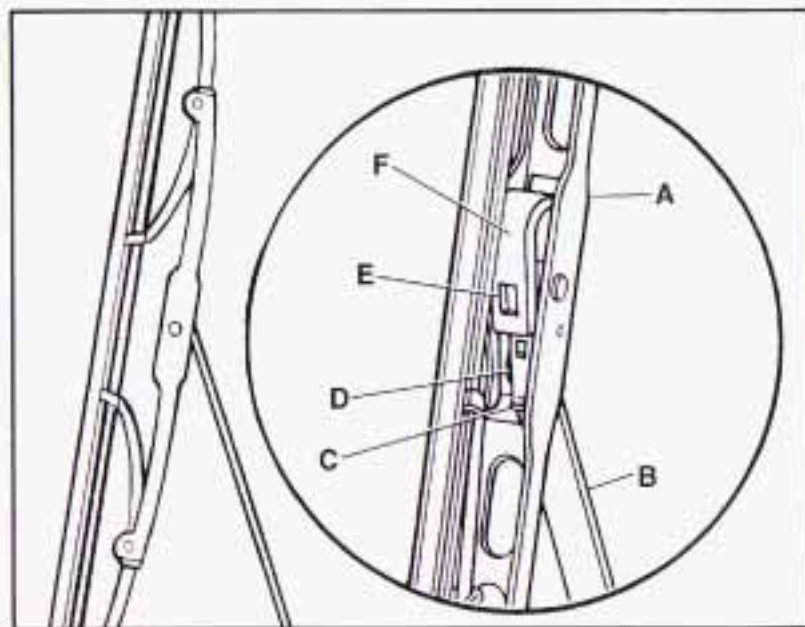

- |                   |                |
|-------------------|----------------|
| A. Blade Assembly | D. Blade Pivot |
| B. Arm Assembly   | E. Hook Slot   |
| C. Locking Tab    | F. Arm Hook    |

2. Press down on the blade assembly pivot locking tab. Pull down on the blade assembly to release it from the wiper arm hook.
3. Remove the insert from the blade assembly. The insert has two notches at one end that are locked by the bottom claws of the blade assembly. At the notched end, pull the insert from the blade assembly.

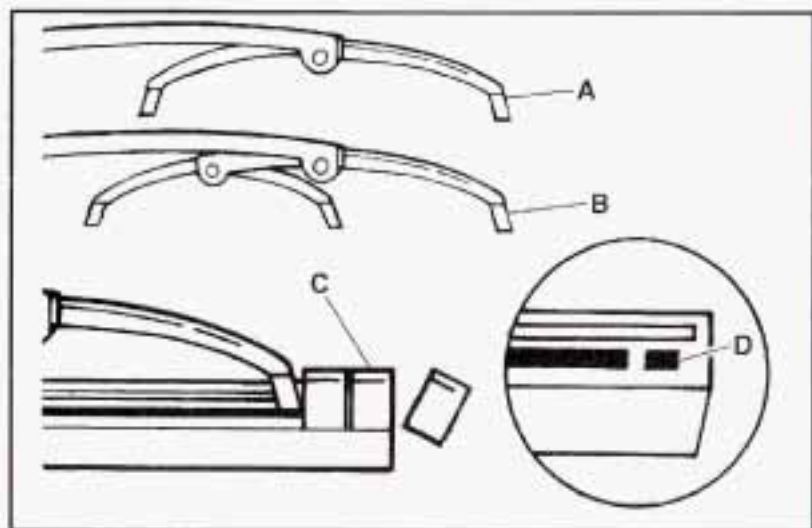

4. To install the new wiper insert, slide the insert (D), notched end last, into the end with two blade claws (A). Slide the insert all the way through the blade claws at the opposite end (B). The plastic caps (C) will be forced off as the insert is fully inserted.
5. Be sure that the notches are locked by the bottom claws. Make sure that all other claws are properly locked on both sides of the insert slots.



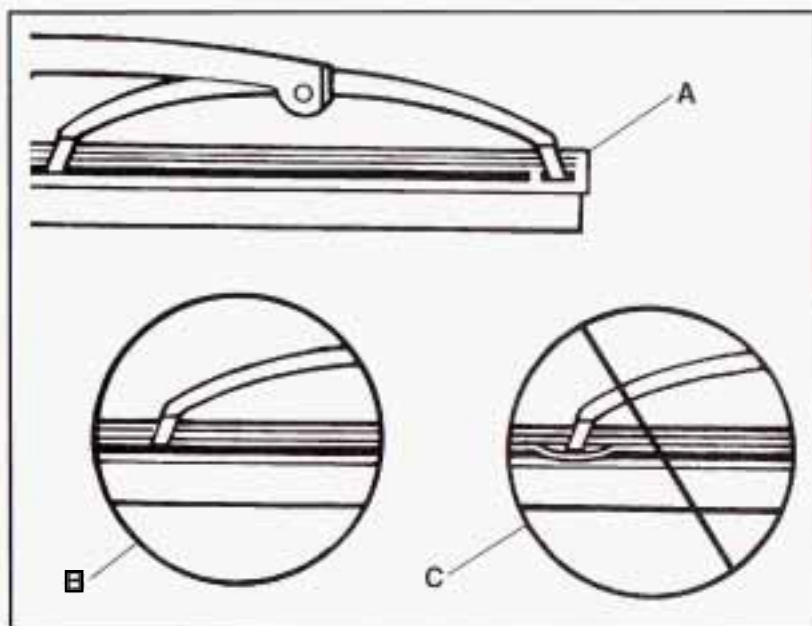

- A. Claw in Notch
- B. Correct Installation
- C. Incorrect Installation

6. Put the blade assembly pivot in the wiper arm hook. Pull up until the pivot locking tab locks in the hook slot.
7. Carefully lower the wiper arm and blade assembly onto the windshield.

## Backglass Wiper Blade Replacement

See *Windshield Wiper Blade Replacement on page 5-50* in this section for instructions on how to change the backglass wiper blade. The backglass wiper blade will not lock in a vertical position like the windshield wiper blade, so care should be used when pulling it away from the vehicle.

## Tires

Your new vehicle comes with high-quality tires made by a leading tire manufacturer. If you ever have questions about your tire warranty and where to obtain service, see your GM Warranty booklet for details.

### CAUTION:

Poorly maintained and improperly used tires are dangerous.

- **Overloading your tires can cause overheating as a result of too much friction. You could have an air-out and a serious accident. See “Loading Your Vehicle” in the Index.**
- **Underinflated tires pose the same danger as overloaded tires. The resulting accident could cause serious injury. Check all tires frequently to maintain the recommended pressure. Tire pressure should be checked when your tires are cold.**

CAUTION: (Continued)

### CAUTION: (Continued)

- **Overinflated tires are more likely to be cut, punctured or broken by a sudden impact — such as when you hit a pothole. Keep tires at the recommended pressure.**
- **Worn, old tires can cause accidents. If your tread is badly worn, or if your tires have been damaged, replace them.**

## Inflation -- Tire Pressure

The Certification/Tire label, which is on the driver's door edge, above the door latch, shows the correct inflation pressures for your tires when they're cold. "Cold" means your vehicle has been sitting for at least three hours or driven no more than 1 mile (1.6 km).

**Notice:** Don't let anyone tell you that underinflation or overinflation is all right. It's not. If your tires don't have enough air (underinflation), you can get the following:

- Too much flexing
- Too much heat
- Tire overloading
- Bad wear
- Bad handling
- Bad fuel economy

If your tires have too much air (overinflation), you can get the following:

- Unusual wear
- Bad handling
- Rough ride
- Needless damage from road hazards

## When to Check

Check your tires once a month or more.

Also, check the tire pressure of the spare tire.

## How to Check

Use a good quality pocket-type gage to check tire pressure. You can't tell if your tires are properly inflated simply by looking at them. Radial tires may look properly inflated even when they're underinflated.

Be sure to put the valve caps back on the valve stems. They help prevent leaks by keeping out dirt and moisture.

## Tire Inspection and Rotation

Tires should be rotated every 7,500 miles (12 500 km).

Any time you notice unusual wear, rotate your tires as soon as possible and check wheel alignment. Also check for damaged tires or wheels. See *When It Is Time for New Tires on page 5-56* and *Wheel Replacement on page 5-59* for more information.

Make sure the spare tire is stored securely. Push, pull, and then try to rotate or turn the tire. If it moves, use the wheel wrench to tighten the cable. See *Changing a Flat Tire on page 5-61*.

The purpose of regular rotation is to achieve more uniform wear for all tires on the vehicle. The first rotation is the most important. See "Part A: Scheduled Maintenance Services," in Section 6, for scheduled rotation intervals.

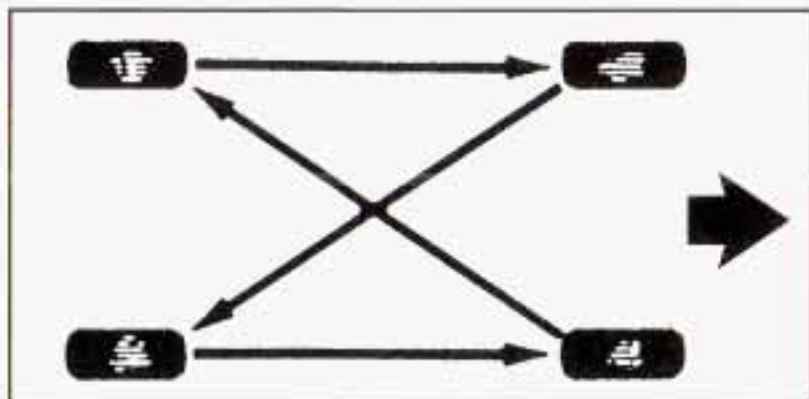

When rotating your tires, always use the correct rotation pattern shown here.

After the tires have been rotated, adjust the front and rear inflation pressures as shown on the Certification/Tire label. Make certain that all wheel nuts are properly tightened. See "Wheel Nut Torque" under *Capacities and Specifications* on page 5-96.

### **CAUTION:**

Rust or dirt on a wheel, or on the parts to which it is fastened, can make wheel nuts become loose after a time. The wheel could come off and cause an accident. When you change a wheel, remove any rust or dirt from places where the wheel attaches to the vehicle. In an emergency, you can use a cloth or a paper towel to do this; but be sure to use a scraper or wire brush later, if you need to, to get all the rust or dirt off. See "Changing a Flat Tire" in the Index.

## When It Is Time for New Tires

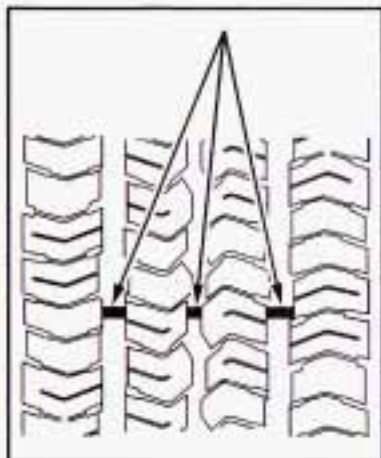

One way to tell when it's time for new tires is to check the treadwear indicators, which will appear when your tires have only 1/16 inch (1.6 mm) or less of tread remaining. Some commercial truck tires may not have treadwear indicators.

You need a new tire if any of the following statements are true:

- You can see the indicators at three or more places around the tire.
- You can see cord or fabric showing through the tire's rubber.
- The tread or sidewall is cracked, cut or snagged deep enough to show cord or fabric.
- The tire has a bump, bulge or split.
- The tire has a puncture, cut or other damage that can't be repaired well because of the size or location of the damage.

## Buying New Tires

To find out what kind and size of tires you need, look at the Certification/Tire label.

The tires installed on your vehicle when it was new had a Tire Performance Criteria Specification (TPC Spec) number on each tire's sidewall. When you get new tires, get ones with that same TPC Spec number. That way your vehicle will continue to have tires that are designed to give proper endurance, handling, speed rating, traction, ride and other things during normal service on your vehicle. If your tires have an all-season tread design, the TPC number will be followed by an "MS" (for mud and snow).

If you ever replace your tires with those not having a TPC Spec number, make sure they are the same size, load range, speed rating and construction type (bias, bias-belted or radial) as your original tires.

 **CAUTION:**

Mixing tires could cause you to lose control while driving. If you mix tires of different sizes or types (radial and bias-belted tires) the vehicle may not handle properly, and you could have a crash. Using tires of different sizes may also cause damage to your vehicle. Be sure to use the same size and type tires on all wheels.

 **CAUTION:**

If you use bias-ply tires on your vehicle, the wheel rim flanges could develop cracks after many miles of driving. A tire and/or wheel could fail suddenly, causing a crash. Use only radial-ply tires with the wheels on your vehicle.

## Uniform Tire Quality Grading

Quality grades can be found where applicable on the tire sidewall between tread shoulder and maximum section width. For example:

### Treadwear 200 Traction AA Temperature A

The following information relates to the system developed by the United States National Highway Traffic Safety Administration, which grades tires by treadwear, traction and temperature performance. (This applies only to vehicles sold in the United States.) The grades are molded on the sidewalls of most passenger car tires. The Uniform Tire Quality Grading system does not apply to deep tread, winter-type snow tires, space-saver or temporary use spare tires, tires with nominal rim diameters of 10 to 12 inches (25 to 30 cm), or to some limited-production tires.

While the tires available on General Motors passenger cars and light trucks may vary with respect to these grades, they must also conform to federal safety requirements and additional General Motors Tire Performance Criteria (TPC) standards.

## **Treadwear**

The treadwear grade is a comparative rating based on the wear rate of the tire when tested under controlled conditions on a specified government test course. For example, a tire graded 150 would wear one and a half (1.5) times as well on the government course as a tire graded 100. The relative performance of tires depends upon the actual conditions of their use, however, and may depart significantly from the norm due to variations in driving habits, service practices and differences in road characteristics and climate.

## **Traction – AA, A, B, C**

The traction grades, from highest to lowest, are AA, A, B, and C. Those grades represent the tire's ability to stop on wet pavement as measured under controlled conditions on specified government test surfaces of asphalt and concrete. A tire marked C may have poor traction performance. Warning: The traction grade assigned to this tire is based on straight-ahead braking traction tests, and does not include acceleration, cornering, hydroplaning, or peak traction characteristics.

## **Temperature – A, B, C**

The temperature grades are A (the highest), B, and C, representing the tire's resistance to the generation of heat and its ability to dissipate heat when tested under controlled conditions on a specified indoor laboratory test wheel. Sustained high temperature can

cause the material of the tire to degenerate and reduce tire life, and excessive temperature can lead to sudden tire failure. The grade C corresponds to a level of performance which all passenger car tires must meet under the Federal Motor Vehicle Safety Standard No. 109. Grades B and A represent higher levels of performance on the laboratory test wheel than the minimum required by law.

Warning: The temperature grade for this tire is established for a tire that is properly inflated and not overloaded. Excessive speed, underinflation, or excessive loading, either separately or in combination, can cause heat buildup and possible tire failure.

## **Wheel Alignment and Tire Balance**

The wheels on your vehicle were aligned and balanced carefully at the factory to give you the longest tire life and best overall performance.

Scheduled wheel alignment and wheel balancing are not needed. However, if you notice unusual tire wear or your vehicle pulling one way or the other, the alignment may need to be reset. If you notice your vehicle vibrating when driving on a smooth road, your wheels may need to be rebalanced.

## Wheel Replacement

Replace any wheel that is bent, cracked or badly rusted or corroded. If wheel nuts keep coming loose, the wheel, wheel bolts and wheel nuts should be replaced. If the wheel leaks air, replace it (except some aluminum wheels, which can sometimes be repaired). See your dealer if any of these conditions exist.

Your dealer will know the kind of wheel you need.

Each new wheel should have the same load-carrying capacity, diameter, width, offset and be mounted the same way as the one it replaces.

If you need to replace any of your wheels, wheel bolts or wheel nuts, replace them only with new GM original equipment parts. This way, you will be sure to have the right wheel, wheel bolts and wheel nuts for your vehicle.

### CAUTION:

**Using the wrong replacement wheels, wheel bolts or wheel nuts on your vehicle can be dangerous. It could affect the braking and handling of your vehicle, make your tires lose air and make you lose control. You could have a collision in which you or others could be injured. Always use the correct wheel, wheel bolts and wheel nuts for replacement.**

***Notice:*** The wrong wheel can also cause problems with bearing life, brake cooling, speedometer or odometer calibration, headlamp aim, bumper height, vehicle ground clearance and tire or tire chain clearance to the body and chassis.

See *Changing a Flat Tire* on page 5-61 for more information.



## Used Replacement Wheels

### CAUTION:

Putting a used wheel on your vehicle is dangerous. You can't know how it's been used or how far it's been driven. It could fail suddenly and cause a crash. If you have to replace a wheel, use a new GM original equipment wheel.

## Tire Chains

### CAUTION:

Don't use tire chains. There's not enough clearance. Tire chains used on a vehicle without the proper amount of clearance can cause damage to the brakes, suspension or other vehicle parts. The area damaged by the tire chains could cause you to lose control of your vehicle and you or others may be injured in a crash. Use another type of traction device only if its manufacturer recommends it for use on your vehicle and tire size combination and road conditions. Follow that manufacturer's instructions. To help avoid damage to your vehicle, drive slowly, readjust or remove the device if it's contacting your vehicle, and don't spin your wheels. If you do find traction devices that will fit, install them on the rear tires.

## If a Tire Goes Flat

It's unusual for a tire to "blowout" while you're driving, especially if you maintain your tires properly. If air goes out of a tire, it's much more likely to leak out slowly. But if you should ever have a "blowout", here are a few tips about what to expect and what to do:

If a front tire fails, the flat tire will create a drag that pulls the vehicle toward that side. Take your foot off the accelerator pedal and grip the steering wheel firmly. Steer to maintain lane position, and then gently brake to a stop well out of the traffic lane.

A rear blowout, particularly on a curve, acts much like a skid and may require the same correction you'd use in a skid. In any rear blowout, remove your foot from the accelerator pedal. Get the vehicle under control by steering the way you want the vehicle to go. It may be very bumpy and noisy, but you can still steer. Gently brake to a stop — well off the road if possible.

If a tire goes flat, the next part shows how to use your jacking equipment to change a flat tire safely.

## Changing a Flat Tire

If a tire goes flat, avoid further tire and wheel damage by driving slowly to a level place. Turn on your hazard warning flashers.

### CAUTION:

**Changing a tire can cause an injury. The vehicle can slip off the jack and roll over you or other people. You and they could be badly injured. Find a level place to change your tire. To help prevent the vehicle from moving:**

- 1. Set the parking brake firmly.**
- 2. Put the shift lever in PARK (P).**
- 3. If you have a four-wheel-drive vehicle, be sure the transfer case is in a drive gear – not in NEUTRAL.**
- 4. Turn off the engine.**
- 5. Put the wheel blocks at the front and rear of the tire farthest away from the one being changed. That would be the tire on the other side of the vehicle, at the opposite end.**

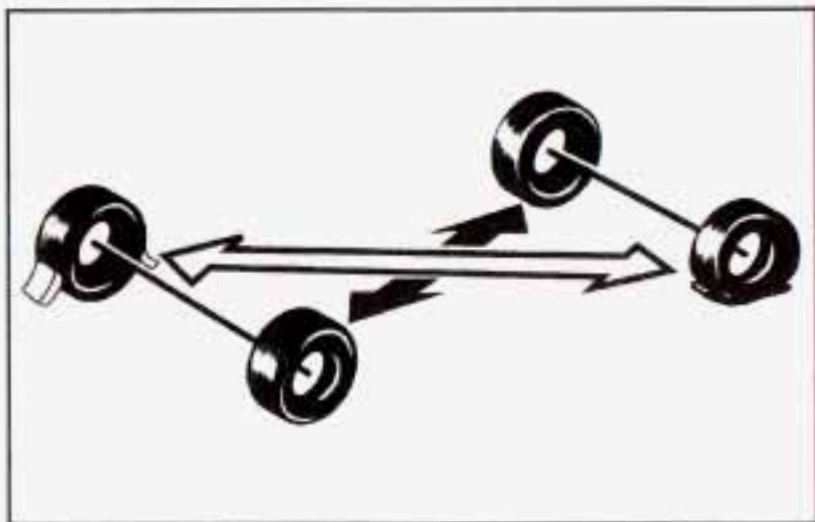

The following steps will tell you how to use the jack and change a tire.

## Removing the Spare Tire and Tools



**TrailBlazer**



### TrailBlazer EXT

The jacking equipment you will need is stored under the rear seat in the TrailBlazer or in the left rear quarter panel storage compartment in the TrailBlazer EXT. See *Rear Seat Operation* on page 1-6 for more information on accessing the jacking equipment.

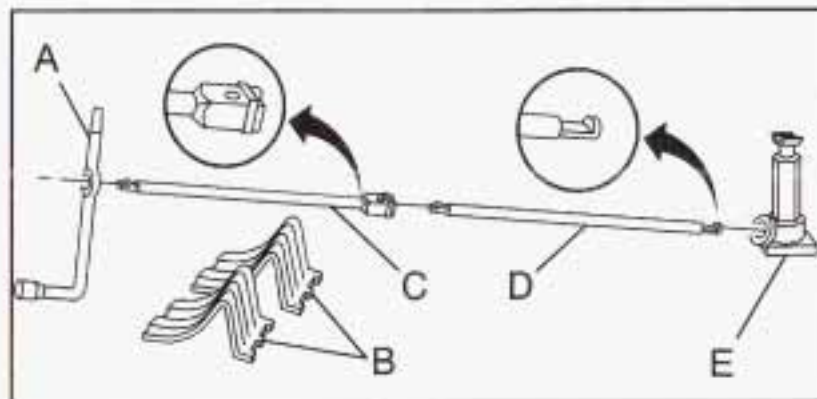

The tools you'll be using include the wheel wrench (A), tire blocks (B), extension(s) (socket end) (C), handle (jack end) (D), and jack (E). The Trailblazer EXT will include an additional extension

The following instructions explain how to remove the spare tire mounted underneath your vehicle.

**Notice:** Never remove or restow a tire from/to a storage position under the vehicle while the vehicle is supported by a jack. Always tighten the tire fully against the underside of the vehicle when restowing.

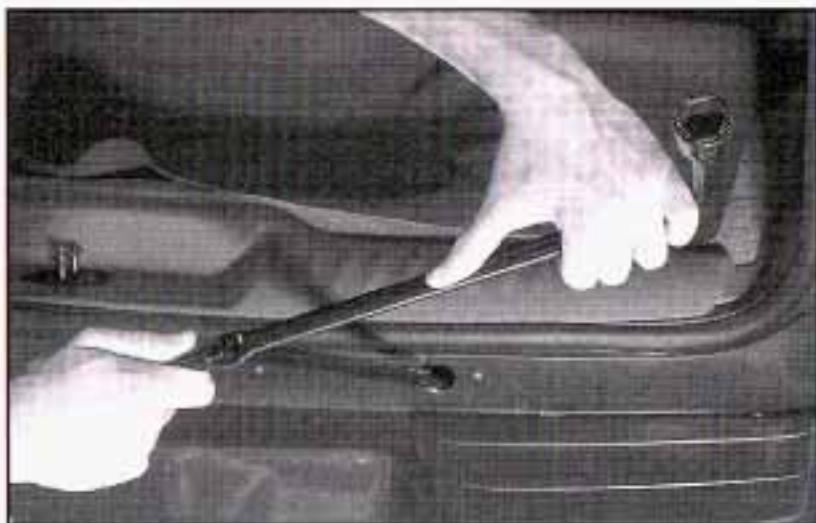

1. To remove the underbody-mounted spare, insert the socket end of the extension on a 45 °angle downward into the hoist drive shaft hole. It is exposed when the rear gate is open and is just above the rear bumper. Be sure the socket end of the extension connects into the hoist shaft.
2. Turn the wheel wrench counterclockwise to lower the spare tire. Keep turning the wheel wrench until the spare tire can be pulled out from under the vehicle.

If the spare tire does not lower to the ground, the secondary latch is engaged causing the tire not to lower. See "Secondary Latch System" later in this section.

When the tire has been completely lowered, tilt the retainer at the end of the cable and pull it through the wheel opening. Pull the tire out from under the vehicle.

**Notice:** To help avoid vehicle damage, do not drive the vehicle before the cable is restored.

3. Put the spare tire near the flat tire.

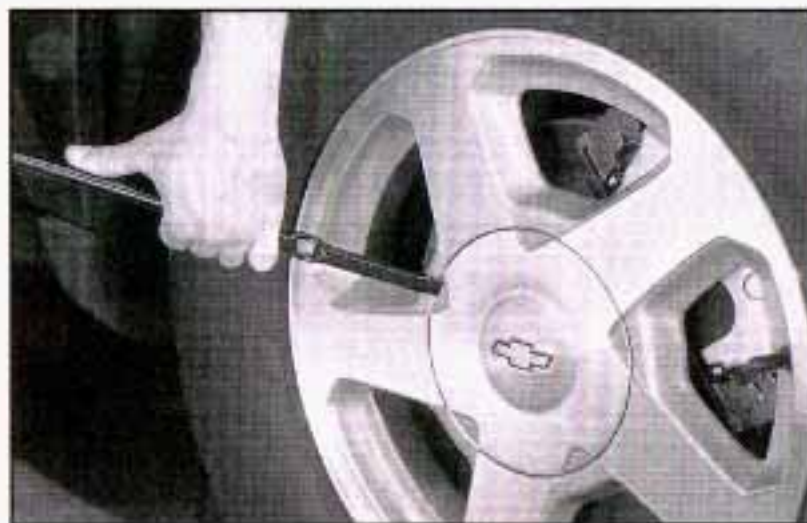

4. Use the chisel end of the wheel wrench to pry off the center cap.

See "Removing the Flat Tire and Installing the Spare Tire" later in this section to continue changing the flat tire.

## Secondary Latch System

Your vehicle has an underbody mounted tire hoist assembly equipped with a secondary latch system. It's designed to stop the spare or flat road tire from suddenly falling off your vehicle if the cable holding the spare tire is damaged. For the secondary latch to work, the tire must be stored with the valve stem pointing up. See "Storing a Flat Tire and Tools" for instructions on storing the spare or flat tire correctly.

### CAUTION:

Before beginning this procedure read all the instructions. Failure to read and follow the instructions could damage the hoist assembly and you and others could get hurt. Read and follow the instructions listed below.

### CAUTION:

Someone standing too close during the procedure could be injured by the jack. If the spare tire does not slide off the jack completely, make sure no one is behind you or on either side of you as you pull the jack out from the spare.

To release the spare tire from the secondary latch do the following:

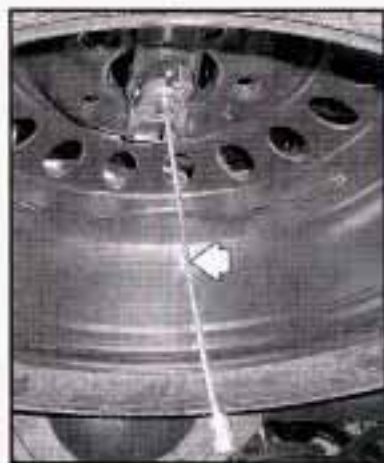

1. Check under the vehicle to see if the cable is visible.

2. If it is not visible, proceed to Step 6.

If visible, first try to tighten the cable by turning the wheel wrench clockwise until you hear two clicks or feel it skip twice. You cannot overtighten the cable.

3. Loosen the cable by turning the wheel wrench counterclockwise three or four turns.

4. Repeat this procedure at least two times.

If the spare tire lowers to the ground, continue with Step 2 of "Removing the Spare Tire and Tools" earlier in this section.

5. Turn the wrench counterclockwise until approximately 6 inches (15 cm) of cable is exposed.



6. Attach the jack handle, extension(s) and the wheel wrench to the jack and place it under the vehicle towards the front of the rear bumper. Position the center lift point of the jack under the center of the spare tire.
7. Turn the wrench clockwise to raise the jack until it lifts the end fitting.

8. Continue raising the jack until the spare tire stops moving upward and is held firmly in place. The secondary latch has released and the spare tire is balancing on the jack.
9. Lower the jack by turning the wheel wrench counterclockwise. Keep lowering the jack until the spare tire slides off the jack or is hanging by the cable.
10. Disconnect the jack handle from the jack and carefully remove the jack. Use one hand to push against the spare while firmly pulling the jack out from under the spare tire with the other hand.

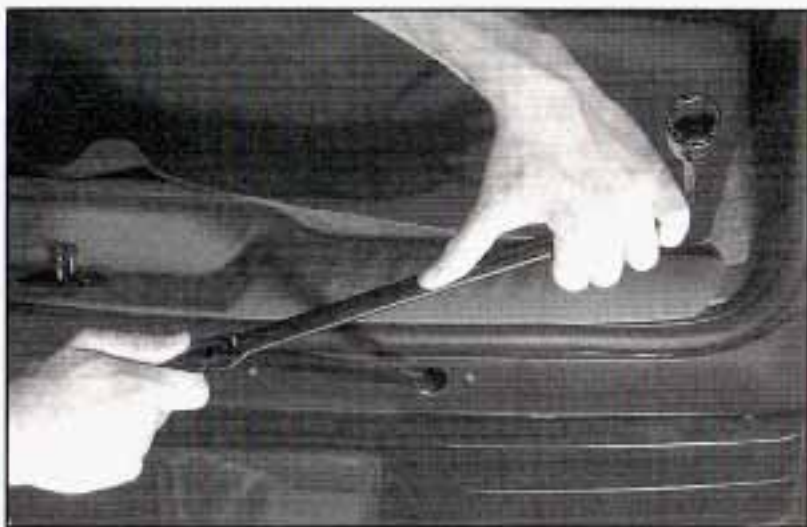

If the spare tire is hanging from the cable, insert the jack handle, extension and wheel wrench into the hoist shaft hole in the bumper, on an angle, and turn the wheel wrench counterclockwise to lower the spare the rest of the way.

11. Tilt the retainer at the end of the cable and pull it through the wheel opening. Pull the tire out from under the vehicle.
12. If the cable is hanging under the vehicle, turn the wheel wrench in the hoist shaft hole in the bumper clockwise to raise the cable back up.

Have the hoist assembly inspected as soon as you can. You will not be able to store a spare or flat tire using the hoist assembly until it has been repaired or replaced.



## Removing the Flat Tire and Installing the Spare Tire

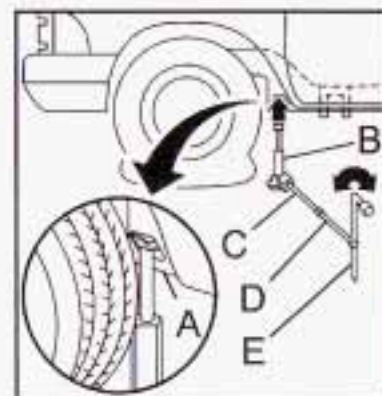

Front

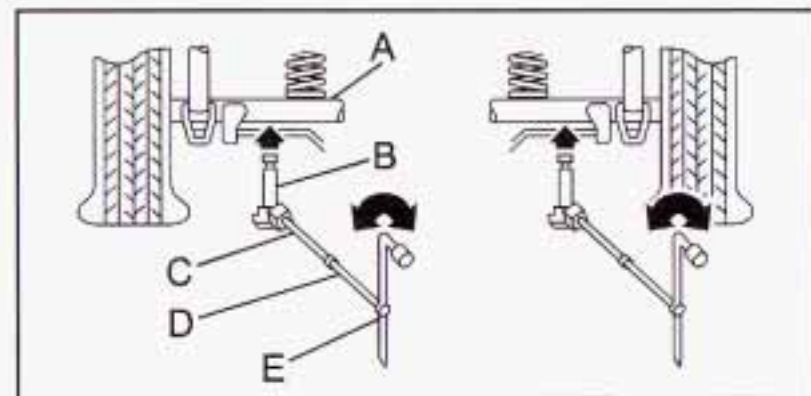

Rear

A. Frame  
B. Jack  
C. Handle

D. Extension(s)  
E. Wheel Wrench

1. Using the wheel wrench, loosen all the wheel nuts. Don't remove them yet.
2. Turn the jack adjusting knob clockwise by hand to raise the jack lift head.
3. Place the handle, extension and wheel wrench onto the jack.

4. Place the jack in the appropriate position nearest the flat tire.

**⚠ CAUTION:**

Getting under a vehicle when it is jacked up is dangerous. If the vehicle slips off the jack you could be badly injured or killed. Never get under a vehicle when it is supported only by a jack.

**⚠ CAUTION:**

Raising your vehicle with the jack improperly positioned can damage the vehicle and even make the vehicle fall. To help avoid personal injury and vehicle damage, be sure to fit the jack lift head into the proper location before raising the vehicle.

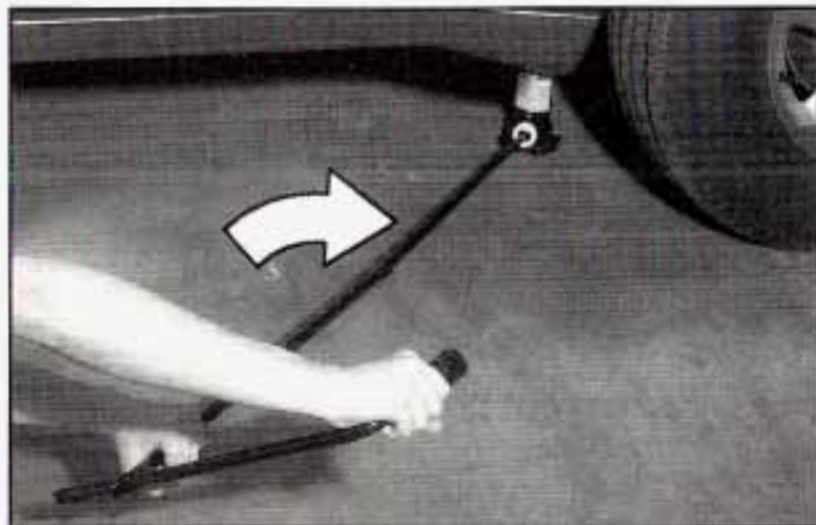

5. Raise the vehicle by turning the jack handle clockwise. Raise the vehicle far enough off the ground so there is enough room for the spare tire to fit.
6. Remove all the wheel nuts and take off the flat tire.

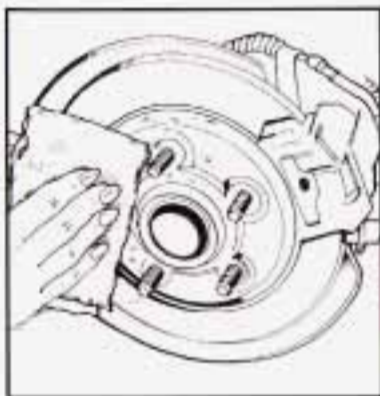

7. Remove any rust or dirt from the wheel bolts, mounting surfaces and spare wheel.

**⚠ CAUTION:**

Rust or dirt on the wheel, or on the parts to which it is fastened, can make the wheel nuts become loose after a time. The wheel could come off and cause an accident. When you change a wheel, remove any rust or dirt from the places where the wheel attaches to the vehicle. In an emergency, you can use a cloth or a paper towel to do this; but be sure to use a scraper or wire brush later, if you need to, to get all the rust or dirt off.

**⚠ CAUTION:**

Never use oil or grease on studs or nuts. If you do, the nuts might come loose. Your wheel could fall off, causing a serious accident.

8. Place the spare on the wheel mounting surface.



9. Put the nuts on by hand. Make sure the rounded end is toward the wheel.

10. Tighten each nut by hand until the wheel is held against the hub. If a nut can't be turned by hand, use the wheel wrench and see your dealer as soon as possible.

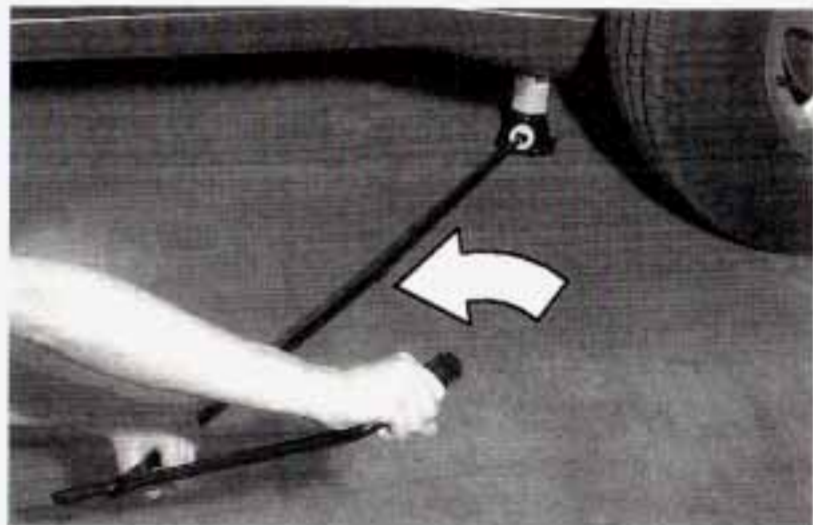

11. Lower the vehicle by turning the jack handle counterclockwise. Lower the jack completely.

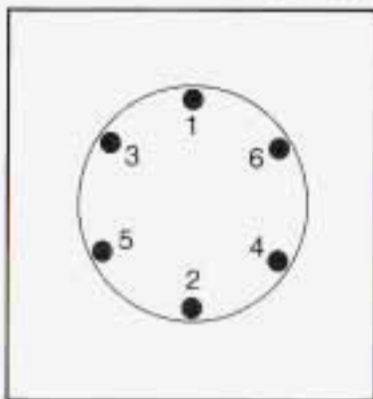

12. Use the wrench to tighten the wheel nuts firmly in a crisscross sequence as shown.

**⚠ CAUTION:**

Incorrect wheel nuts or improperly tightened wheel nuts can cause the wheel to become loose and even come off. This could lead to an accident. Be sure to use the correct wheel nuts. If you have to replace them, be sure to get new GM original equipment wheel nuts. Stop somewhere as soon as you can and have the nuts tightened with a torque wrench to 100 lb-ft (140 N•m).

**Notice:** Improperly tightened wheel nuts can lead to brake pulsation and rotor damage. To avoid expensive brake repairs, evenly tighten the wheel nuts in the proper sequence and to the proper torque specification. See "Capacities and Specifications" in the index for the wheel nut torque specification.

## Storing a Flat or Spare Tire and Tools

### CAUTION:

Storing a jack, a tire, or other equipment in the passenger compartment of the vehicle could cause injury. In a sudden stop or collision, loose equipment could strike someone. Store all these in the proper place.

### CAUTION:

The underbody-mounted spare tire needs to be stored with the valve stem pointing up. If the spare tire is stored with the valve stem pointing downward, its secondary latch won't work properly and the spare tire could loosen and suddenly fall from your vehicle. If this happened when your vehicle was being driven,

CAUTION: (Continued)

### CAUTION: (Continued)

the tire might contact a person or another vehicle, causing injury and, of course, damage to itself as well. Be sure the underbody-mounted spare tire is stored with its valve stem pointing up.

*Notice:* An aluminum wheel with a flat tire should always be stored under the vehicle with the hoist. However, storing it that way for an extended period could damage the wheel. To avoid this, always stow the wheel properly with the valve stem pointing up and have the wheel repaired as soon as possible.

Follow this diagram to store the underbody-mounted spare.

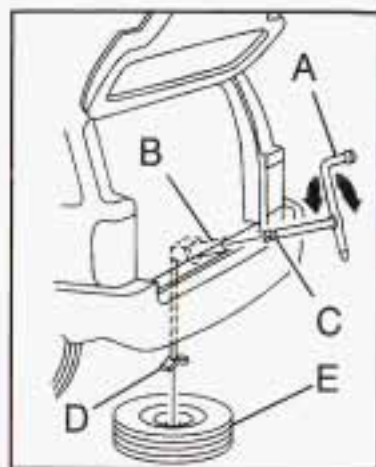

- A. Wheel Wrench
- B. Hoist Shaft
- C. Extension(s)
- D. Retainer
- E. Spare or Flat Tire  
(Valve Stem  
Pointed Up)

1. Put the tire on the ground at the rear of the vehicle, with the valve stem pointed up and to the rear.
2. Pull the retainer through the wheel.
3. Put the socket end of the extension, on an angle, through the hole in the rear bumper and into the hoist shaft.
4. Raise the tire fully against the underside of the vehicle. Continue turning the wheel wrench clockwise until you hear two clicks or feel it skip twice. This indicates that the tire is secure and the cable is tight. The spare tire hoist cannot be overtightened.

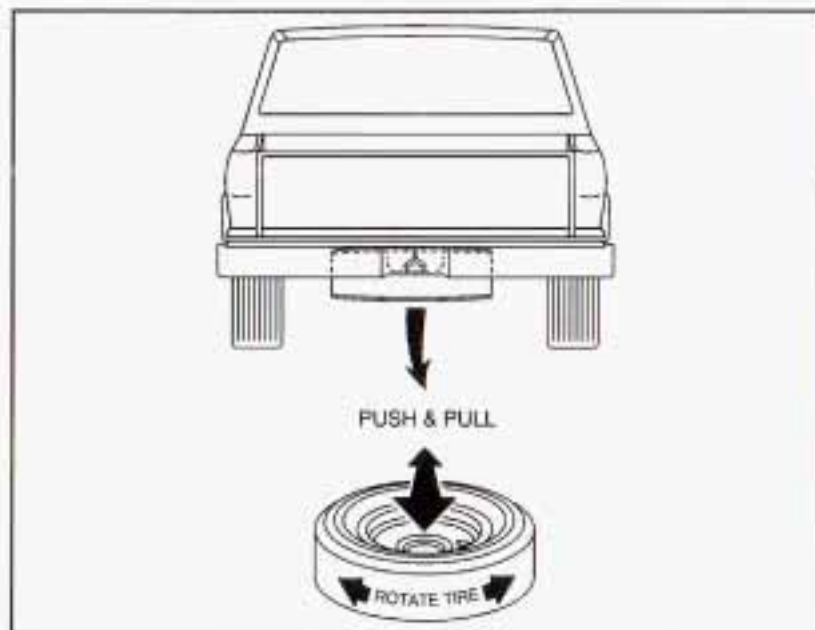

5. Make sure the tire is stored securely. Push, pull, and then try to rotate or turn the tire. If the tire moves, use the wheel wrench to tighten the cable.

Return the jack, wheel wrench and wheel blocks to the proper location in the vehicle. Roll up the instruction label and return it to the slot in the tool kit.



**TrailBlazer**

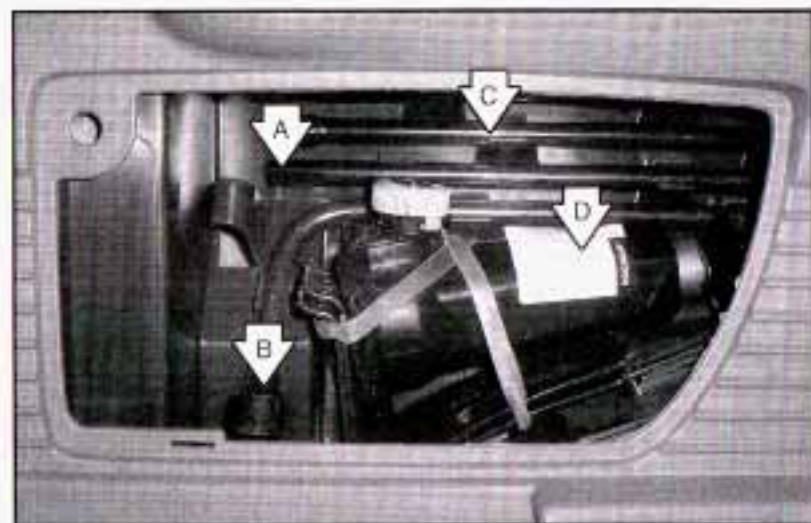

**TrailBlazer EXT**

- A. Handle
- B. Wheel Wrench
- C. Extension(s)
- D. Wheel Blocks and Jack

## Appearance Care

Remember, cleaning products can be hazardous. Some are toxic. Others can burst into flames if you strike a match or get them on a hot part of the vehicle. Some are dangerous if you breathe their fumes in a closed space. When you use anything from a container to clean your vehicle, be sure to follow the manufacturer's warnings and instructions. And always open your doors or windows when you're cleaning the inside.

*Never* use these to clean your vehicle:

- Gasoline
- Benzene
- Naphtha
- Carbon Tetrachloride
- Acetone
- Paint Thinner
- Turpentine
- Lacquer Thinner
- Nail Polish Remover

They can all be hazardous — some more than others —and they can all damage your vehicle, too.

Don't use any of these unless this manual says you can. In many uses, these will damage your vehicle:

- Alcohol
- Laundry Soap
- Bleach
- Reducing Agents

## Cleaning the Inside of Your Vehicle

Use a vacuum cleaner often to get rid of dust and loose dirt. Wipe vinyl, leather, plastic and painted surfaces with a clean, damp cloth.

### Fabric/Carpet

Your dealer has cleaners for the cleaning of fabric and carpet. They will clean normal spots and stains very well.

You can get GM – approved cleaning products from your dealer. See *GM Vehicle Care/Appearance Materials* on page 5-81.



Here are some cleaning tips:

- Always read the instructions on the cleaner label.
- Clean up stains as soon as you can – before they set.
- Carefully scrape off any excess stain.
- Use a clean cloth or sponge, and change to a clean area often. A soft brush may be used if stains are stubborn.
- If a ring forms on fabric after spot cleaning, clean the entire area immediately or it will set.

## Using Cleaner on Fabric

1. Vacuum and brush the area to remove any loose dirt.
2. Always clean a whole trim panel or section. Mask surrounding trim along stitch or welt lines.
3. Follow the directions on the container label.
4. Apply cleaner with a clean sponge. Don't saturate the material and don't rub it roughly.
5. As soon as you've cleaned the section, use a sponge to remove any excess cleaner.
6. Wipe cleaned area with a clean, water-dampened towel or cloth.
7. Wipe with a clean cloth and let dry.

## Special Fabric Cleaning Problems

Stains caused by such things as catsup, coffee (black), egg, fruit, fruit juice, milk, soft drinks, vomit, urine and blood can be removed as follows:

1. Carefully scrape off excess stain, then sponge the soiled area with cool water.
2. If a stain remains, follow the cleaner instructions described earlier.
3. If an odor lingers after cleaning vomit or urine, treat the area with a water/baking soda solution: 1 teaspoon (5 ml) of baking soda to 1 cup (250 ml) of lukewarm water.
4. Let dry.

Stains caused by candy, ice cream, mayonnaise, chili sauce and unknown stains can be removed as follows:

1. Carefully scrape off excess stain.
2. Clean with cool water and allow to dry completely.
3. If a stain remains, follow the cleaner instructions described earlier.

## Vinyl

Use warm water and a clean cloth.

- Rub with a clean, damp cloth to remove dirt. You may have to do this more than once.
- Things like tar, asphalt and shoe polish will stain if you don't get them off quickly. Use a clean cloth and vinyl/leather cleaner. See your dealer for this product.

## Leather

Use a soft cloth with lukewarm water and a mild soap or saddle soap and wipe dry with a soft cloth. Then, let the leather dry naturally. Do not use heat to dry.

- For stubborn stains, use a leather cleaner. See your dealer for this product.
- *Never* use oils, varnishes, solvent-based or abrasive cleaners, furniture polish or shoe polish on leather.
- Soiled or stained leather should be cleaned immediately. If dirt is allowed to work into the finish, it can harm the leather.

## Top of the Instrument Panel

Use only mild soap and water to clean the top surfaces of the instrument panel. Sprays containing silicones or waxes may cause annoying reflections in the windshield and even make it difficult to see through the windshield under certain conditions.

## Interior Plastic Components

Use only a mild soap and water solution on a soft cloth or sponge. Commercial cleaners may affect the surface finish.

## Glass Surfaces

Glass should be cleaned often. GM Glass Cleaner or a liquid household glass cleaner will remove normal tobacco smoke and dust films on interior glass. See *GM Vehicle Care/Appearance Materials* on page 5-81.

**Notice:** Don't use abrasive cleaners on glass, because they may cause scratches. Avoid placing decals on the inside rear window, since they may have to be scraped off later. If abrasive cleaners are used on the inside of the rear window, an electric defogger element may be damaged. Any temporary license should not be attached across the defogger grid.

## Care of Safety Belts

Keep belts clean and dry.

### CAUTION:

**Do not bleach or dye safety belts. If you do, it may severely weaken them. In a crash, they might not be able to provide adequate protection. Clean safety belts only with mild soap and lukewarm water.**

## Weatherstrips

Silicone grease on weatherstrips will make them last longer, seal better, and not stick or squeak. Apply silicone grease with a clean cloth at least every six months. During very cold, damp weather more frequent application may be required. See *Part D: Recommended Fluids and Lubricants* on page 6-15.

## Cleaning the Outside of Your Vehicle

The paint finish on your vehicle provides beauty, depth of color, gloss retention and durability.

## Washing Your Vehicle

The best way to preserve your vehicle's finish is to keep it clean by washing it often with lukewarm or cold water.

Don't wash your vehicle in the direct rays of the sun. Use a car washing soap. Don't use strong soaps or chemical detergents. Be sure to rinse the vehicle well, removing all soap residue completely. You can get GM-approved cleaning products from your dealer. See *GM Vehicle Care/Appearance Materials* on page 5-81. Don't use cleaning agents that are petroleum based, or that contain acid or abrasives. All cleaning agents should be flushed promptly and not allowed to dry on the surface, or they could stain. Dry the finish with a soft, clean chamois or an all-cotton towel to avoid surface scratches and water spotting.

High pressure car washes may cause water to enter your vehicle.

## Cleaning Exterior Lamps/Lenses

Use only lukewarm or cold water, a soft cloth and a car washing soap to clean exterior lamps and lenses. Follow instructions under "Washing Your Vehicle."

## Finish Care

Occasional waxing or mild polishing of your vehicle by hand may be necessary to remove residue from the paint finish. You can get GM-approved cleaning products from your dealer. See *GM Vehicle Care/Appearance Materials on page 5-81*.

If your vehicle has a "basecoat/clearcoat" paint finish, The clearcoat gives more depth and gloss to the colored basecoat. Always use waxes and polishes that are non-abrasive and made for a basecoat/clearcoat paint finish.

**Notice:** Machine compounding or aggressive polishing on a basecoat/clearcoat paint finish may dull the finish or leave swirl marks.

Foreign materials such as calcium chloride and other salts, ice melting agents, road oil and tar, tree sap, bird droppings, chemicals from industrial chimneys, etc., can damage your vehicle's finish if they remain on painted surfaces. Wash the vehicle as soon as possible. If necessary, use non-abrasive cleaners that are marked safe for painted surfaces to remove foreign matter.

Exterior painted surfaces are subject to aging, weather and chemical fallout that can take their toll over a period of years. You can help to keep the paint finish looking new by keeping your vehicle garaged or covered whenever possible.

## Protecting Exterior Bright Metal Parts

Bright metal parts should be cleaned regularly to keep their luster. Washing with water is all that is usually needed. However, you may use chrome polish on chrome or stainless steel trim, if necessary.

Use special care with aluminum trim. To avoid damaging protective trim, never use auto or chrome polish, steam or caustic soap to clean aluminum. A coating of wax, rubbed to high polish, is recommended for all bright metal parts.

## Windshield, Backglass and Wiper Blades

If the windshield is not clear after using the windshield washer, or if the wiper blade chatters when running, wax, sap or other material may be on the blade or windshield.

Clean the outside of the windshield with a full-strength glass cleaning liquid. The windshield is clean if beads do not form when you rinse it with water.

Grime from the windshield will stick to the wiper blades and affect their performance. Clean the blade by wiping vigorously with a cloth soaked in full-strength windshield washer solvent. Then rinse the blade with water.

Check the wiper blades and clean them as necessary; replace blades that look worn.

## Aluminum Wheels

Keep your wheels clean using a soft clean cloth with mild soap and water. Rinse with clean water. After rinsing thoroughly, dry with a soft clean towel. A wax may then be applied.

The surface of these wheels is similar to the painted surface of your vehicle. Don't use strong soaps, chemicals, abrasive polishes, abrasive cleaners, cleaners with acid, or abrasive cleaning brushes on them because you could damage the surface. Do not use chrome polish on aluminum wheels.

Don't take your vehicle through an automatic car wash that has silicone carbide tire cleaning brushes. These brushes can also damage the surface of these wheels.

## Tires

To clean your tires, use a stiff brush with tire cleaner.

**Notice:** When applying a tire dressing, always take care to wipe off any overspray or splash from all painted surfaces on the body or wheels of the vehicle. Petroleum-based products may damage the paint finish and tires.

## Sheet Metal Damage

If your vehicle is damaged and requires sheet metal repair or replacement, make sure the body repair shop applies anti-corrosion material to parts repaired or replaced to restore corrosion protection.

Original manufacturer replacement parts will provide the corrosion protection while maintaining the warranty.

## Finish Damage

Any stone chips, fractures or deep scratches in the finish should be repaired right away. Bare metal will corrode quickly and may develop into major repair expense.

Minor chips and scratches can be repaired with touch-up materials available from your dealer or other service outlets. Larger areas of finish damage can be corrected in your dealer's body and paint shop.

## Underbody Maintenance

Chemicals used for ice and snow removal and dust control can collect on the underbody. If these are not removed, accelerated corrosion (rust) can occur on the underbody parts such as fuel lines, frame, floor pan and exhaust system even though they have corrosion protection.

At least every spring, flush these materials from the underbody with plain water. Clean any areas where mud and debris can collect. Dirt packed in close areas of the frame should be loosened before being flushed. Your dealer or an underbody car washing system can do this for you.

## Chemical Paint Spotting

Some weather and atmospheric conditions can create a chemical fallout. Airborne pollutants can fall upon and attack painted surfaces on your vehicle. This damage can take two forms; blotchy, ringlet-shaped discolorations, and small irregular dark spots etched into the paint surface.

Although no defect in the paint job causes this, GM will repair, at no charge to the owner, the surfaces of new vehicles damaged by this fallout condition within 12 months or 12,000 miles (20 000 km) of purchase, whichever occurs first.

## GM Vehicle Care/Appearance Materials

See your GM dealer for more information on purchasing the following products.

### GM Vehicle Care/Appearance Materials

Description	Usage
Polishing Cloth Wax-Treated	Interior and exterior polishing cloth.
Tar and Road Oil Remover	Removes tar, road oil and asphalt.
Chrome Cleaner and Polish	Use on chrome or stainless steel.
White Sidewall Tire Cleaner	Removes soil and black marks from whitewalls.
Vinyl Cleaner	Cleans vinyl tops, upholstery and convertible tops.
Glass Cleaner	Removes dirt, grime, smoke and fingerprints.
Chrome and Wire Wheel Cleaner	Removes dirt and grime from chrome wheels and wire wheel covers.

## GM Vehicle Care/Appearance Materials (cont'd)

Description	Usage
Finish Enhancer	Removes dust, fingerprints, and surface contaminants, Spray on wipe off.
Swirl Remover Polish	Removes swirl marks, fine scratches and other light surface contamination.
Cleaner Wax	Removes light scratches and protects finish.
Foaming Tire Shine Low Gloss	Cleans, shines and protects in one easy step, no wiping necessary.

## GM Vehicle Care/Appearance Materials (cont'd)

Description	Usage
Wash Wax Concentrate	Medium foaming shampoo. Cleans and lightly waxes. Biodegradable and phosphate free.
Spot Lifter	Quickly and easily removes spots and stains from carpets, vinyl and cloth upholstery.
Odor Eliminator	Odorless spray odor eliminator used on fabrics, vinyl, leather and carpet.
See your General Motors parts department for these products. See <i>Part D: Recommended Fluids and Lubricants</i> on page 6-15.	

## Vehicle Identification

### Vehicle Identification Number (VIN)



This is the legal identifier for your vehicle. It appears on a plate in the front corner of the instrument panel, on the driver's side. You can see it if you look through the windshield from outside your vehicle. The VIN also appears on the Vehicle Certification and Service Parts labels and the certificates of title and registration.

## Engine Identification

The 8th character in your VIN is the engine code. This code will help you identify your engine, specifications and replacement parts.

## Service Parts Identification Label

You'll find this label on the inside of the glove box. It's very helpful if you ever need to order parts. On this label is:

- your VIN,
- the model designation,
- paint information and
- a list of all production options and special equipment.

Be sure that this label is not removed from the vehicle.



## Electrical System

### Add-On Electrical Equipment

**Notice:** Don't add anything electrical to your vehicle unless you check with your dealer first. Some electrical equipment can damage your vehicle and the damage wouldn't be covered by your warranty. Some add-on electrical equipment can keep other components from working as they should.

Your vehicle has an air bag system. Before attempting to add anything electrical to your vehicle, see *Servicing Your Air Bag-Equipped Vehicle on page 1-58*.

### Headlamps

The headlamp wiring is protected by four fuses. An electrical overload will cause a lamp to go on and off. If this happens, have your headlamp wiring checked right away.

### Windshield Wiper Fuses

The windshield wiper motor is protected by a circuit breaker and a fuse. If the motor overheats due to heavy snow or ice, the wiper will stop until the motor cools. If the overload is caused by some electrical problem, be sure to get it fixed.

### Power Windows and Other Power Options

Circuit breakers protect the power windows and other power accessories. When the current load is too heavy, the circuit breaker opens and closes, protecting the circuit until the problem is fixed or goes away.

## Fuses and Circuit Breakers

The wiring circuits in your vehicle are protected from short circuits by a combination of fuses and circuit breakers. This greatly reduces the chance of fires caused by electrical problems.

Look at the silver-colored band inside the fuse. If the band is broken or melted, replace the fuse. Be sure you replace a bad fuse with a new one of the identical size and rating.

If you ever have a problem on the road and don't have a spare fuse, you can borrow one that has the same amperage. Just pick some feature of your vehicle that you can get along without — like the radio or cigarette lighter— and use its fuse, if it is the correct amperage. Replace it as soon as you can.

## Engine Compartment Fuse Block

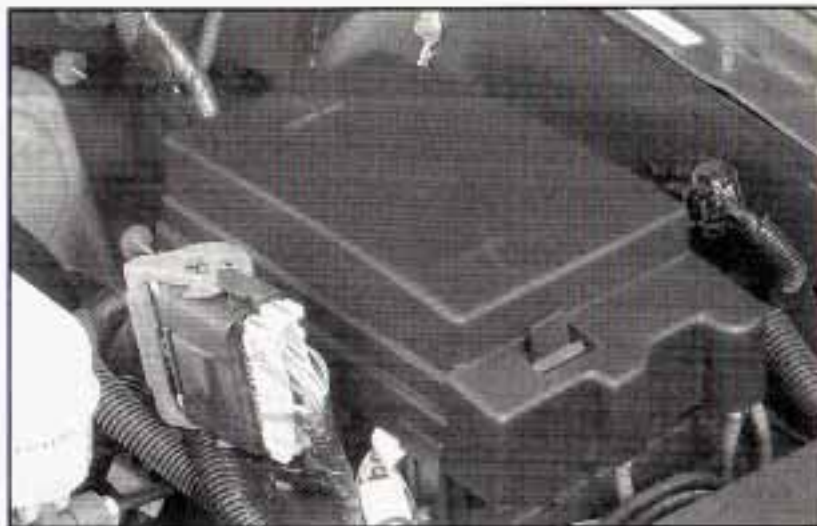

The fuse block is located under the hood in the engine compartment on the driver's side of the vehicle. See *Engine Compartment Overview* on page 5-12 for more information on location.

Remove the primary cover by pressing the two locking tabs. Remove the secondary cover by snapping off while lifting. To reinstall the fuse panel cover, reverse the sequence.

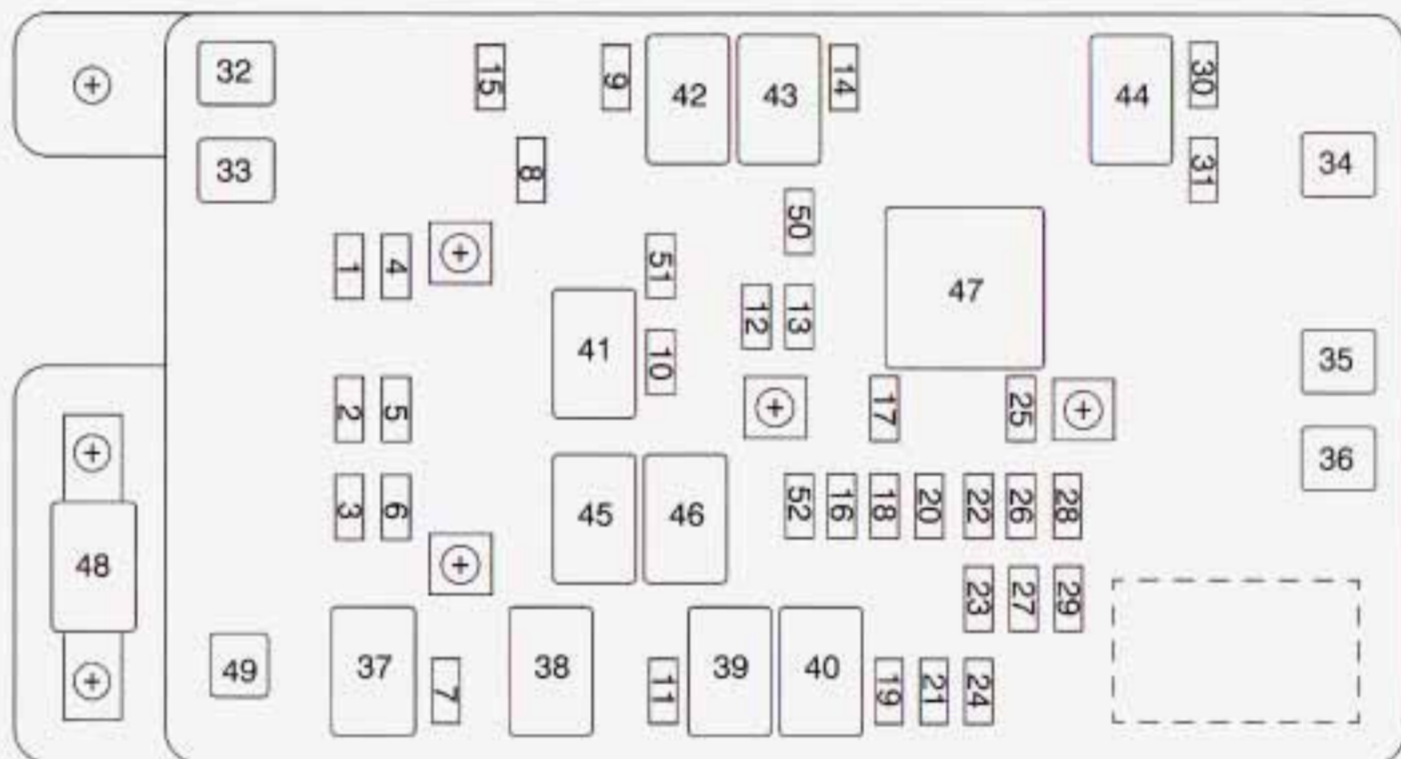

L6 Engine

Fuses	Usage
1	Electrically-Controlled Air Suspension
2	Passenger's Side High-Beam Headlamp
3	Passenger's Side Low-Beam Headlamp
4	Back-Up-Trailer Lamps
5	Driver's Side High-Beam Headlamp
6	Driver's Side Low-Beam Headlamp
7	WASH
8	Automatic Transfer Case
9	Windshield Wipers
10	Powertrain Control Module B
11	Fog Lamps
12	Stop Lamp
13	Cigarette Lighter
14	Ignition Coils
15	Air Suspension Ride
16	TBD-Ignition 1

Fuses	Usage
17	Crank
18	Air Bag
19	Electric Brake
20	Cooling Fan
21	Horn
22	Ignition E
23	Electronic Throttle Control
24	Instrument Panel Cluster, Driver Information Center
25	Automatic Shift Lock Control System
26	Engine 1
27	Back-Up
28	Powertrain Control Module 1
29	Oxygen Sensor
30	Air Conditioning
31	Truck Body Controller
32	Trailer
33	Anti-Lock Brakes (ABS)
34	Ignition A

<b>Fuses</b>	<b>Usage</b>
35	Blower Motor
36	Ignition B
50	Passenger's Side Trailer Turn
51	Driver's Side Trailer Turn
52	Hazard Flashers
<b>Relays</b>	<b>Usage</b>
37	Blank
38	Rear Window Washer
39	Fog Lamps
40	Horn

<b>Fuses</b>	<b>Usage</b>
41	Fuel Pump
42	Windshield Wipers/Washer
43	High-Beam Headlamp
44	Air Conditioning
45	Cooling Fan
46	Headlamp Driver Module
47	Starter
<b>Miscellaneous</b>	<b>Usage</b>
48	Instrument Panel Battery
49	Blank

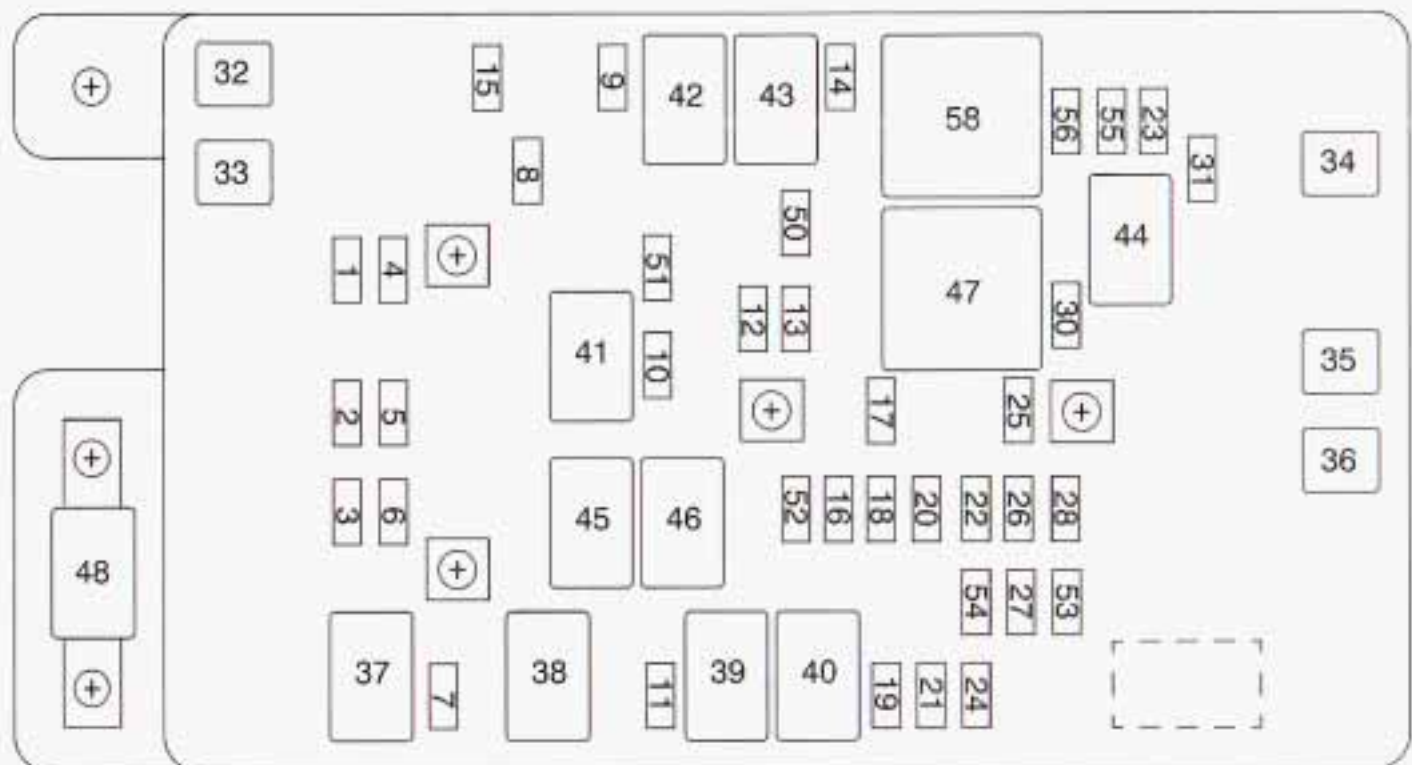

V8 Engine

<b>Fuses</b>	<b>Usage</b>
1	Electrically-Controlled Air Suspension
2	Passenger's Side High-Beam Headlamp
3	Passenger's Side Low-Beam Headlamp
4	Back-Up-Trailer Lamps
5	Driver's Side High-Beam Headlamp
6	Driver's Side Low-Beam Headlamp
7	WASH
8	Automatic Transfer Case
9	Windshield Wipers
10	Powertrain Control Module B
11	Fog Lamps
12	Stop Lamp
13	Cigarette Lighter
14	Ignition Coils
15	Canister Vent
16	TBD-Ignition 1
17	Crank
18	Air Bag

<b>Fuses</b>	<b>Usage</b>
19	Electric Brake
20	Cooling Fan
21	Horn
22	Ignition E
23	Electronic Throttle Control
24	Instrument Panel Cluster, Driver Information Center
25	Automatic Shift Lock Control System
26	Engine 1
27	Back-Up
28	Powertrain Control Module 1
30	Air Conditioning
31	Truck Body Controller
32	Trailer
33	Anti-Lock Brakes (ABS)
34	Ignition A
35	Blower Motor
36	Ignition B
50	Passenger's Side Trailer Turn
51	Driver's Side Trailer Turn
52	Hazard Flashers

<b>Fuses</b>	<b>Usage</b>
53	Oxygen Sensor Bank A
54	Oxygen Sensor Bank B
55	Injector Bank A
56	Injector Bank B
<b>Relays</b>	<b>Usage</b>
37	Headlamp Washer
38	Rear Window Washer
39	Fog Lamps
40	Horn
41	Fuel Pump
42	Windshield Wipers/Washer
43	High-Beam Headlamp
44	Air Conditioning
45	Cooling Fan
46	Headlamp Driver Module
47	Starter
58	Ignition 1
<b>Miscellaneous</b>	<b>Usage</b>
48	Instrument Panel Battery

## Rear Underseat Fuse Block





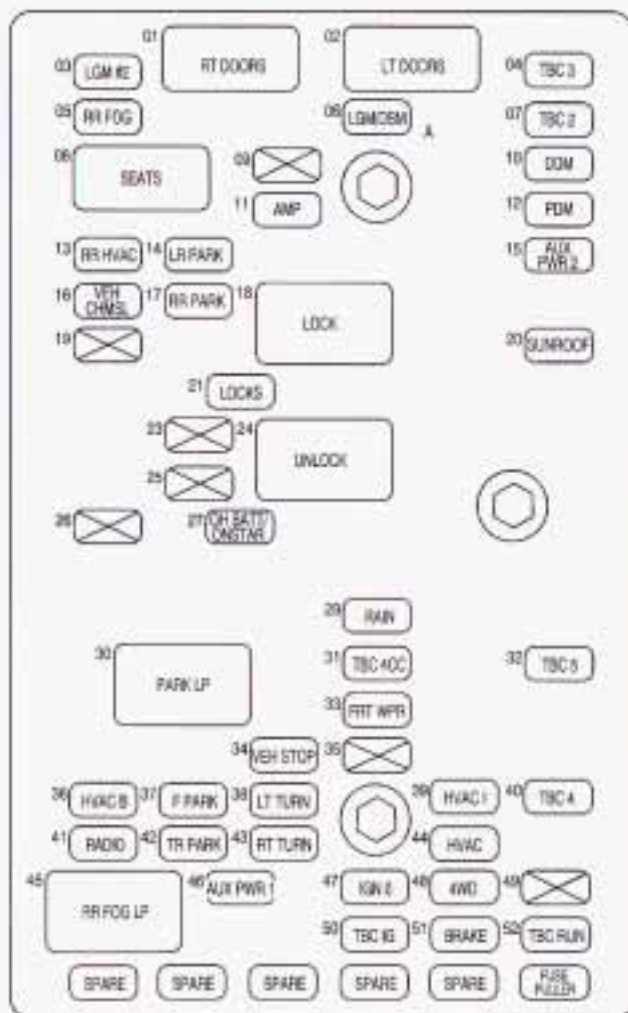

**TrailBlazer**

Fuses	Usage
01	Right Door Control Module
02	Left Door Control Module
03	Liftgate Module 2
04	Truck Body Controller 3
05	Rear Fog Lamps
06	Liftgate Module/Driver Seat Module
07	Truck Body Controller 2
08	Power Seats
09	Blank
10	Driver Door Module
11	Amplifier
12	Passenger Door Module
13	Rear Climate Controls
14	Left Rear Parking Lamps
15	Auxiliary Power 2
16	Vehicle Center High-Mounted Stop Lamp
17	Right Rear Parking Lamps
18	LOCKS
19	Blank
20	Sunroof
21	LOCK

Fuses	Usage
23	Blank
24	UNLOCK
25	Blank
26	Blank
27	OH Battery/OnStar <sup>®</sup> System
29	Rainsense <sup>™</sup> Wipers
30	Parking Lamps
31	Truck Body Controller 4 Cruise Control
32	Truck Body Controller 5
33	Front Wipers
34	Vehicle STOP
35	Blank
36	Heat Ventilation Air Conditioning B
37	Front Parking Lamps

Fuses	Usage
38	Left Turn Signal
39	Heat Ventilation Air Conditioning 1
40	Truck Body Controller 4
41	Radio
42	Trailer Park
43	Right Turn Signal
44	Heat Ventilation Air Conditioning
45	Rear Fog Lamps
46	Auxiliary Power 1
47	Ignition 0
48	Four-Wheel Drive
49	Blank
50	Truck Body Controller Ignition
51	Brakes
52	Truck Body Controller Run

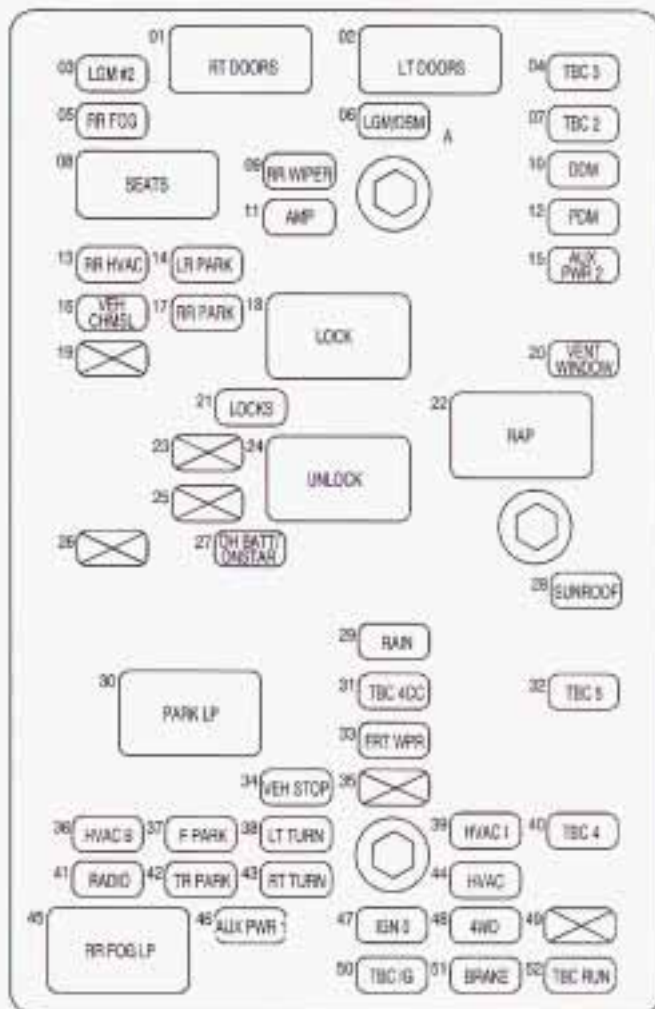

**TrailBlazer EXT**

Fuses	Usage
01	Right Door Control Module
02	Left Door Control Module
03	Liftgate Module 2
04	Truck Body Controller 3
05	Rear Fog Lamps
06	Liftgate Module/Driver Seat Module
07	Truck Body Controller 2
08	Power Seats
09	Rear Wiper
10	Driver Door Module
11	Amplifier
12	Passenger Door Module
13	Rear Climate Controls
14	Left Rear Parking Lamps
15	Auxiliary Power 2
16	Vehicle Center High-Mounted Stop Lamp
17	Right Rear Parking Lamps
18	LOCKS
19	Blank
20	Vent Window
21	LOCK

<b>Fuses</b>	<b>Usage</b>
22	Retained Accessory Power
23	Blank
24	UNLOCK
25	Blank
26	Blank
27	OH Battery/OnStar <sup>®</sup> System
28	Sunroof
29	Rainsense™ Wipers
30	Parking Lamps
31	Truck Body Controller 4 Cruise Control
32	Truck Body Controller 5
33	Front Wipers
34	Vehicle STOP
35	Blank
36	Heat Ventilation Air Conditioning B

<b>Fuses</b>	<b>Usage</b>
37	Front Parking Lamps
38	Left Turn Signal
39	Heat Ventilation Air Conditioning 1
40	Truck Body Controller 4
41	Radio
42	Trailer Park
43	Right Turn Signal
44	Heat Ventilation Air Conditioning
45	Rear Fog Lamps
46	Auxiliary Power 1
47	Ignition 0
48	Four-Wheel Drive
49	Blank
50	Truck Body Controller Ignition
51	Brakes
52	Truck Body Controller Run

# Capacities and Specifications

## Capacities and Specifications

Engine	VIN Code	Transmission	Spark Plug Gap	Firing Order
"VORTEC™ " 4200 L6	S	M30	.042 inches (1.07 mm)	1-5-3-6-2-4
"VORTEC™ " 5300 V8	T	M30	0.060 inches (1.52 mm)	1-8-7-2-6-5-4-3

Application	L6 Engine		V8 Engine	
	English	Metric	English	Metric
Wheel Nut Torque	100 lb ft	140 N•m	100 lb ft	140 N•m
Cooling System				
TrailBlazer	13.9 quarts	13.1 L	—	—
TrailBlazer EXT	15.2 quarts	14.4 L	17.9 quarts	17.0 L
Air Conditioning Refrigerant R/134a				
TrailBlazer	1.9 lbs.	0.9 kg	—	—
TrailBlazer EXT	2.8 lbs.	1.27 kg	2.8 lbs.	1.27 kg
Engine Oil with Filter	7.0 quarts	6.6 L	6.0 quarts	5.7 L
Transmission (Drain and Refill)	5.0 quarts	4.7 L	5.0 quarts	4.7 L

Application	L6 Engine		V8 Engine	
	English	Metric	English	Metric
Differential Fluid				
Rear	4.0 pints	1.9 L	4.0 pints	1.9 L
Front	2.6 pints	0.8 L	2.6 pints	0.8 L
Fuel Tank				
TrailBlazer	18.7 gallons	70.8 L	—	—
TrailBlazer with RPO NNK	22.0 gallons	83.3 L	—	—
TrailBlazer EXT	25.3 gallons	95.8 L	25.3 gallons	95.8 L
All capacities are approximate. When adding, be sure to fill to the appropriate level, as recommended in this manual. Recheck the fluid level after filling.				

## Normal Maintenance Replacement Parts

Part	Number
Engine Oil Filter	
L6	PF58*
V8	PF44*
Engine Air Cleaner	A2014C*
Automatic Transmission Filter Kit	GM Part No. 24200796
Spark Plugs	
L6	41-981*
V8	41-974*
Fuel Filter	GF831*
Windshield Wiper Blade	20.0 inches (50.8 cm)
Backglass Wiper Blade	14.0 inches (35.6 cm)
*ACDelco® part number	

## Section 6 Maintenance Schedule

---

<b>Maintenance Schedule</b> .....	6-2	At Least Once a Year .....	6-11
Introduction .....	6-2	Part C: Periodic Maintenance Inspections .....	6-13
Your Vehicle and the Environment .....	6-2	Steering, Suspension and Front Drive Axle	
Maintenance Requirements .....	6-2	Boot and Seal Inspection .....	6-13
How This Section is Organized .....	6-3	Exhaust System Inspection .....	6-14
Part A: Scheduled Maintenance Services .....	6-4	Fuel System Inspection .....	6-14
Using Your Maintenance Schedule .....	6-4	Engine Cooling System Inspection .....	6-14
Scheduled Maintenance .....	6-5	Transfer Case and Front Axle (Four-Wheel	
Part B: Owner Checks and Services .....	6-9	Drive) Inspection .....	6-14
At Each Fuel Fill .....	6-9	Brake System Inspection .....	6-14
At Least Once a Month .....	6-10	Part D: Recommended Fluids and Lubricants ....	6-15
At Least Twice a Year .....	6-10	Part E: Maintenance Record .....	6-17



## Maintenance Schedule

### Introduction

**IMPORTANT:**  
KEEP ENGINE OIL  
AT THE PROPER  
LEVEL AND CHANGE AS  
RECOMMENDED



***Protection  
Plan***

*Have you purchased the GM Protection Plan? The Plan supplements your new vehicle warranties. See your Warranty and Owner Assistance booklet or your dealer for details.*

## Your Vehicle and the Environment

Proper vehicle maintenance not only helps to keep your vehicle in good working condition, but also helps the environment. All recommended maintenance procedures are important. Improper vehicle maintenance can even affect the quality of the air we breathe. Improper fluid levels or the wrong tire inflation can increase the level of emissions from your vehicle. To help protect our environment, and to keep your vehicle in good condition, please maintain your vehicle properly.

### Maintenance Requirements

Maintenance intervals, checks, inspections and recommended fluids and lubricants as prescribed in this manual are necessary to keep your vehicle in good working condition. Any damage caused by failure to follow recommended maintenance may not be covered by warranty.

## How This Section is Organized

This maintenance schedule is divided into five parts:

**“Part A: Scheduled Maintenance Services”** explains what to have done and how often. Some of these services can be complex, so unless you are technically qualified and have the necessary equipment, you should let your dealer’s service department or another qualified service center do these jobs.

### CAUTION:

**Performing maintenance work on a vehicle can be dangerous. In trying to do some jobs, you can be seriously injured. Do your own maintenance work only if you have the required know-how and the proper tools and equipment for the job. If you have any doubt, have a qualified technician do the work.**

If you want to get the service information, see *Service Publications Ordering Information* on page 7-10.

**“Part B: Owner Checks and Services”** tells you what should be checked and when. It also explains what you can easily do to help keep your vehicle in good condition.

**“Part C: Periodic Maintenance Inspections”** explains important inspections that your dealer’s service department or another qualified service center should perform.

**“Part D: Recommended Fluids and Lubricants”** lists some recommended products necessary to help keep your vehicle properly maintained. These products, or their equivalents, should be used whether you do the work yourself or have it done.

**“Part E: Maintenance Record”** is a place for you to record and keep track of the maintenance performed on your vehicle. Keep your maintenance receipts. They may be needed to qualify your vehicle for warranty repairs.

## Part A: Scheduled Maintenance Services

This part contains engine oil scheduled maintenance which explains the engine oil life system and how it indicates when to change the engine oil and filter. Also, listed are scheduled maintenance services which are to be performed at the mileage intervals specified.

### Using Your Maintenance Schedule

We at General Motors want to help you keep your vehicle in good working condition. But we don't know exactly how you'll drive it. You may drive very short distances only a few times a week. Or you may drive long distances all the time in very hot, dusty weather. You may use your vehicle in making deliveries. Or you may drive it to work, to do errands or in many other ways.

Because of all the different ways people use their vehicles, maintenance needs vary. You may need more frequent checks and replacements. So please read the following and note how you drive. If you have any questions on how to keep your vehicle in good condition, see your dealer.

This part tells you the maintenance services you should have done and when you should schedule them. When you go to your dealer for your service needs, you'll know that GM-trained and supported service people will perform the work using genuine GM parts.

The proper fluids and lubricants to use are listed in Part D. Make sure whoever services your vehicle uses these. All parts should be replaced and all necessary repairs done before you or anyone else drives the vehicle.

This schedule is for vehicles that:

- carry passengers and cargo within recommended limits. You will find these limits on your vehicle's Certification/Tire label. See *Loading Your Vehicle on page 4-45*.
- are driven on reasonable road surfaces within legal driving limits.
- are driven off-road in the recommended manner. See *Off-Road Driving with Your Four-Wheel-Drive Vehicle on page 4-14*.
- use the recommended fuel. See *Gasoline Octane on page 5-5*.

## Scheduled Maintenance

The services shown in this schedule up to 100,000 miles (166 000 km) should be repeated after 100,000 miles (166 000 km) at the same intervals for the life of this vehicle. The services shown at 150,000 miles (240 000 km) should be repeated at the same interval after 150,000 miles (240 000 km) for the life of this vehicle.

See *Part B: Owner Checks and Services* on page 6-9 and *Part C: Periodic Maintenance Inspections* on page 6-13.

## Footnotes

† *The U.S. Environmental Protection Agency or the California Air Resources Board has determined that the failure to perform this maintenance item will not nullify the emission warranty or limit recall liability prior to the completion of the vehicle's useful life. We, however, urge that all recommended maintenance services be performed at the indicated intervals and the maintenance be recorded.*

+ *A good time to check your brakes is during tire rotation. See Brake System Inspection on page 6-14.*

## Engine Oil Scheduled Maintenance

**Change engine oil and filter as indicated by the GM Oil Life System (or every 12 months, whichever occurs first). Reset the system.**

Your vehicle has a computer system that lets you know when to change the engine oil and filter. This is based on engine revolutions and engine temperature, and not on mileage. Based on driving conditions, the mileage at which an oil change will be indicated can vary considerably. For the oil life system to work properly, you must reset the system every time the oil is changed.

When the system has calculated that oil life has been diminished, it will indicate that an oil change is necessary. A CHANGE ENGINE OIL light will come on. Change your oil as soon as possible within the next two times you stop for fuel. It is possible that, if you are driving under the best conditions, the oil life system may not indicate that an oil change is necessary for over a year. However, your engine oil and filter must be changed at least once a year and at this time the system must be reset. It is also important to check your oil regularly and keep it at the proper level.

If the system is ever reset accidentally, you must change your oil at 3,000 miles (5 000 km) since your last oil change. Remember to reset the oil life system whenever the oil is changed. See *Engine Oil* on page 5-15 for information on resetting the system.

After the services are performed, record the date, odometer reading and who performed the service on the maintenance record pages in Part E of this schedule.

*An Emission Control Service.*

### **7,500 Miles (12 500 km)**

- Check rear/front axle fluid level and add fluid as needed. Check constant velocity joints and axle seals for leaking.
- Rotate tires. See *Tire Inspection and Rotation on page 5-54* for proper rotation pattern and additional information. (See footnote +.)

### **15,000 Miles (25 000 km)**

- Inspect engine air cleaner filter if you are driving in dusty conditions. Replace filter if necessary. *An Emission Control Service.* (See footnote †.)
- Check rear/front axle fluid level and add fluid as needed. Check constant velocity joints and axle seals for leaking.
- Rotate tires. See *Tire Inspection and Rotation on page 5-54* for proper rotation pattern and additional information. (See footnote +.)

### **22,500 Miles (37 500 km)**

- Check rear/front axle fluid level and add fluid as needed. Check constant velocity joints and axle seals for leaking.
- Rotate tires. See *Tire Inspection and Rotation on page 5-54* for proper rotation pattern and additional information. (See footnote +.)

### **30,000 Miles (50 000 km)**

- Check rear/front axle fluid level and add fluid as needed. Check constant velocity joints and axle seals for leaking.
- Rotate tires. See *Tire Inspection and Rotation on page 5-54* for proper rotation pattern and additional information. (See footnote +.)
- Replace fuel filter. *An Emission Control Service.* (See footnote †.)
- Replace engine air cleaner filter. *An Emission Control Service.*

### **37,500 Miles (62 500 km)**

- Check rear/front axle fluid level and add fluid as needed. Check constant velocity joints and axle seals for leaking.
- Rotate tires. See *Tire Inspection and Rotation on page 5-54* for proper rotation pattern and additional information. (See footnote +.)

## 45,000 Miles (75 000 km)

- Inspect engine air cleaner filter if you are driving in dusty conditions. Replace filter if necessary. *An Emission Control Service. (See footnote †.)*
- Check rear/front axle fluid level and add fluid as needed. Check constant velocity joints and axle seals for leaking.
- Rotate tires. See *Tire Inspection and Rotation on page 5-54* for proper rotation pattern and additional information. *(See footnote +.)*

## 50,000 Miles (83 000 km)

- Change automatic transmission fluid and filter if the vehicle is mainly driven under one or more of these conditions:
  - In heavy city traffic where the outside temperature regularly reaches 90°F (32°C) or higher.
  - In hilly or mountainous terrain.
  - When doing frequent trailer towing.
  - Uses such as found in taxi, police or delivery service.

*If you do not use your vehicle under any of these conditions, change the fluid and filter at 100,000 miles (166 000 km).*

- Automatic Transfer Case Only: Change transfer case fluid.

## 52,500 Miles (87 500 km)

- Check rear/front axle fluid level and add fluid as needed. Check constant velocity joints and axle seals for leaking.
- Rotate tires. See *Tire Inspection and Rotation on page 5-54* for proper rotation pattern and additional information. *(See footnote +.)*

## 60,000 Miles (100 000 km)

- Check rear/front axle fluid level and add fluid as needed. Check constant velocity joints and axle seals for leaking.
- Rotate tires. See *Tire Inspection and Rotation on page 5-54* for proper rotation pattern and additional information. *(See footnote +.)*
- Replace fuel filter. *An Emission Control Service. (See footnote †.)*
- Replace engine air cleaner filter. *An Emission Control Service.*

## 67,500 Miles (112 500 km)

- Check rear/front axle fluid level and add fluid as needed. Check constant velocity joints and axle seals for leaking.
- Rotate tires. See *Tire Inspection and Rotation on page 5-54* for proper rotation pattern and additional information. *(See footnote +.)*

## 75,000 Miles (125 000 km)

- ❑ Inspect engine air cleaner filter if you are driving in dusty conditions. Replace filter if necessary. *An Emission Control Service.* (See footnote †.)
- ❑ Check rear/front axle fluid level and add fluid as needed. Check constant velocity joints and axle seals for leaking.
- ❑ Rotate tires. See *Tire Inspection and Rotation* on page 5-54 for proper rotation pattern and additional information. (See footnote +.)

## 82,500 Miles (137 500 km)

- ❑ Check rear/front axle fluid level and add fluid as needed. Check constant velocity joints and axle seals for leaking.
- ❑ Rotate tires. See *Tire Inspection and Rotation* on page 5-54 for proper rotation pattern and additional information. (See footnote +.)

## 90,000 Miles (150 000 km)

- ❑ Check rear/front axle fluid level and add fluid as needed. Check constant velocity joints and axle seals for leaking.
- ❑ Replace fuel filter. *An Emission Control Service.* (See Footnote †.)

- ❑ Replace engine air cleaner filter. *An Emission Control Service.*
- ❑ Rotate tires. See *Tire Inspection and Rotation* on page 5-54 for proper rotation pattern and additional information. (See footnote +.)

## 97,500 Miles (162 500 km)

- ❑ Check rear/front axle fluid level and add fluid as needed. Check constant velocity joints and axle seals for leaking.
- ❑ Rotate tires. See *Tire Inspection and Rotation* on page 5-54 for proper rotation pattern and additional information. (See footnote +.)

## 100,000 Miles (166 000 km)

- ❑ V8 Engine Only: Inspect spark plug wires. *An Emission Control Service.*
- ❑ Replace spark plugs. *An Emission Control Service.*
- ❑ Change automatic transmission fluid and filter if the vehicle is mainly driven under one or more of these conditions:
  - In heavy city traffic where the outside temperature regularly reaches 90°F (32°C) or higher.
  - In hilly or mountainous terrain.
  - When doing frequent trailer towing.
  - Uses such as found in taxi, police or delivery service.

- ❑ If you haven't used your vehicle under severe service conditions listed previously and, therefore, haven't changed your automatic transmission fluid, change both the fluid and filter
- ❑ Automatic Transfer Case Only: Change transfer case fluid.
- ❑ V8 Engine Only: Inspect Positive Crankcase Ventilation (PCV) valve. *An Emission Control Service.*

### **150,000 Miles (240 000 km)**

- ❑ Drain, flush and refill cooling system (or every 60 months since last service, whichever occurs first). See *Engine Coolant on page 5-23* for what to use. Inspect hoses. Clean radiator, condenser, pressure cap and neck. Pressure test the cooling system and pressure cap. *An Emission Control Service.*
- ❑ Inspect engine accessory drive belt. *An Emission Control Service.*

## **Part B: Owner Checks and Services**

Listed in this part are owner checks and services which should be performed at the intervals specified to help ensure the safety, dependability and emission control performance of your vehicle.

Be sure any necessary repairs are completed at once. Whenever any fluids or lubricants are added to your vehicle, make sure they are the proper ones, as shown in Part D.

### **At Each Fuel Fill**

*It is important for you or a service station attendant to perform these underhood checks at each fuel fill.*

#### **Engine Oil Level Check**

Check the engine oil level and add the proper oil if necessary. See *Engine Oil on page 5-15* for further details.

#### **Engine Coolant Level Check**

Check the engine coolant level and add DEX-COOL<sup>®</sup> coolant mixture if necessary. See *Engine Coolant on page 5-23* for further details.



## Windshield Washer Fluid Level Check

Check the windshield washer fluid level in the windshield washer tank and add the proper fluid if necessary. See *Windshield Washer Fluid* on page 5-35 for further details.

## At Least Once a Month

### Tire Inflation Check

Make sure tires are inflated to the correct pressures. Don't forget to check your spare tire. See *Tires* on page 5-53 for further details.

### Cassette Tape Player Service

Clean cassette tape player. Cleaning should be done every 50 hours of tape play. See *Audio System(s)* on page 3-58 for further details.

## At Least Twice a Year

### Restraint System Check

Make sure the safety belt reminder light and all your belts, buckles, latch plates, retractors and anchorages are working properly. Look for any other loose or damaged safety belt system parts. If you see anything that might keep a safety belt system from doing its job, have it repaired. Have any torn or frayed safety belts replaced.

Also look for any opened or broken air bag coverings, and have them repaired or replaced. (The air bag system does not need regular maintenance.)

### Wiper Blade Check

Inspect wiper blades for wear or cracking. Replace blade inserts that appear worn or damaged or that streak or miss areas of the windshield. Also see *Cleaning the Outside of Your Vehicle* on page 5-78.

### Spare Tire Check

At least twice a year, after the monthly inflation check of the spare tire determines that the spare is inflated to the correct tire inflation pressure, make sure that the spare tire is stored securely. Push, pull, and then try to rotate or turn the tire. If it moves, use the wheel wrench/ratchet to tighten the cable. See *Changing a Flat Tire* on page 5-61.

### Engine Air Cleaner Filter Restriction Indicator Check

Your vehicle may be equipped with an engine air cleaner filter restriction indicator located on the air cleaner in the engine compartment. The indicator lets you know when the air cleaner filter is dirty and needs to be changed. Check the indicator at least twice a year or when your engine oil is changed, whichever occurs first. See *Engine Air Cleaner/Filter* on page 5-19

for more information. Inspect your air cleaner filter restriction indicator more often if the vehicle is used in dusty areas or under off road conditions.

## Weatherstrip Lubrication

Silicone grease on weatherstrips will make them last longer, seal better, and not stick or squeak. Apply silicone grease with a clean cloth. During very cold, damp weather more frequent application may be required. See *Part D: Recommended Fluids and Lubricants on page 6-15*.

## Automatic Transmission Check

Check the transmission fluid level; add if needed. See *Automatic Transmission Fluid on page 5-21*. A fluid loss may indicate a problem. Check the system and repair if needed.

## At Least Once a Year

### Key Lock Cylinders Service

Lubricate the key lock cylinders with the lubricant specified in Part D.

### Body Lubrication Service

Lubricate all hood latch assembly, secondary latch, pivots, spring anchor, release pawl, rear compartment hinges, outer liftgate handle pivot points, rear door

detent link, roller mechanism, liftgate handle pivot points, latch bolt, fuel door hinge, cargo door hinge, locks and folding seat hardware. Part D tells you what to use. More frequent lubrication may be required when exposed to a corrosive environment.

## Starter Switch Check

### CAUTION:

**When you are doing this check, the vehicle could move suddenly. If it does, you or others could be injured. Follow the steps below.**

1. Before you start, be sure you have enough room around the vehicle.
2. Firmly apply both the parking brake and the regular brake. See *Parking Brake on page 2-28* if necessary.

Do not use the accelerator pedal, and be ready to turn off the engine immediately if it starts.

3. Try to start the engine in each gear. The starter should work only in PARK (P) or NEUTRAL (N). If the starter works in any other position, your vehicle needs service.

## Automatic Transmission Shift Lock Control System Check

### CAUTION:

When you are doing this check, the vehicle could move suddenly. If it does, you or others could be injured. Follow the steps below.

1. Before you start, be sure you have enough room around the vehicle. It should be parked on a level surface.
2. Firmly apply the parking brake. See *Parking Brake on page 2-28* if necessary.  
Be ready to apply the regular brake immediately if the vehicle begins to move.
3. With the engine off, turn the key to the RUN position, but don't start the engine. Without applying the regular brake, try to move the shift lever out of PARK (P) with normal effort. If the shift lever moves out of PARK (P), your vehicle needs service.

## Ignition Transmission Lock Check

While parked, and with the parking brake set, try to turn the ignition key to LOCK in each shift lever position.

- The key should turn to LOCK only when the shift lever is in PARK (P).
- The key should come out only in LOCK.

## Parking Brake and Automatic Transmission Park (P) Mechanism Check

### CAUTION:

When you are doing this check, your vehicle could begin to move. You or others could be injured and property could be damaged. Make sure there is room in front of your vehicle in case it begins to roll. Be ready to apply the regular brake at once should the vehicle begin to move.

Park on a fairly steep hill, with the vehicle facing downhill. Keeping your foot on the regular brake, set the parking brake.

- To check the parking brake's holding ability: With the engine running and transmission in NEUTRAL (N), slowly remove foot pressure from the regular brake pedal. Do this until the vehicle is held by the parking brake only.
- To check the PARK (P) mechanism's holding ability: With the engine running, shift to PARK (P). Then release the parking brake followed by the regular brake.

## Underbody Flushing Service

At least every spring, use plain water to flush any corrosive materials from the underbody. Take care to clean thoroughly any areas where mud and other debris can collect.

## Part C: Periodic Maintenance Inspections

Listed in this part are inspections and services which should be performed at least twice a year (for instance, each spring and fall). *You should let your dealer's service department or other qualified service center do these jobs. Make sure any necessary repairs are completed at once.*

Proper procedures to perform these services may be found in a service manual. See *Service Publications Ordering Information on page 7-10.*

## Steering, Suspension and Front Drive Axle Boot and Seal Inspection

Inspect the front and rear suspension and steering system for damaged, loose or missing parts, signs of wear or lack of lubrication. Inspect the power steering lines and hoses for proper hook-up, binding, leaks, cracks, chafing, etc. Clean and then inspect the drive axle boot seals for damage, tears or leakage. Replace seals if necessary.

## Exhaust System Inspection

Inspect the complete exhaust system. Inspect the body near the exhaust system. Look for broken, damaged, missing or out-of-position parts as well as open seams, holes, loose connections or other conditions which could cause a heat build-up in the floor pan or could let exhaust fumes into the vehicle. See *Engine Exhaust* on page 2-31.

## Fuel System Inspection

Inspect the complete fuel system for damage or leaks.

## Engine Cooling System Inspection

Inspect the hoses and have them replaced if they are cracked, swollen or deteriorated. Inspect all pipes, fittings and clamps; replace as needed. Clean the outside of the radiator and air conditioning condenser. To help ensure proper operation, a pressure test of the cooling system and pressure cap is recommended at least once a year.

## Transfer Case and Front Axle (Four-Wheel Drive) Inspection

Every 12 months or at engine oil change intervals, check front axle and transfer case and add lubricant when necessary. A fluid loss could indicate a problem; check and have it repaired, if needed. Check vent hose at transfer case for kinks and proper installation. More frequent lubrication may be required on off-road use.

## Brake System Inspection

Inspect the complete system. Inspect brake lines and hoses for proper hook-up, binding, leaks, cracks, chafing, etc. Inspect disc brake pads for wear and rotors for surface condition. Inspect other brake parts, including calipers, parking brake, etc. Check parking brake adjustment. You may need to have your brakes inspected more often if your driving habits or conditions result in frequent braking.

## Part D: Recommended Fluids and Lubricants

Fluids and lubricants identified below by name, part number or specification may be obtained from your dealer.

Usage	Fluid/Lubricant
Engine Oil	Engine oil with the American Petroleum Institute Certified for Gasoline Engines starburst symbol of the proper viscosity. To determine the preferred viscosity for your vehicle's engine, see <i>Engine Oil on page 5-15</i> .
Engine Coolant	50/50 mixture of clean, drinkable water and use only DEX-COOL <sup>®</sup> Coolant. See <i>Engine Coolant on page 5-23</i> .
Hydraulic Brake System	Delco Supreme 11 Brake Fluid or equivalent DOT-3 brake fluid.
Windshield Washer Solvent	GM Optikleen <sup>®</sup> Washer Solvent or equivalent.

Usage	Fluid/Lubricant
Parking Brake Cable Guides	Chassis Lubricant (GM Part No. U.S. 12377985, in Canada 88901242, or equivalent) or lubricant meeting requirements of NLGI #2, Category LB or GC-LB.
Power Steering System	GM Power Steering Fluid (GM Part No. U.S. 1052884, in Canada 993294, or equivalent).
Automatic Transmission	DEXRON <sup>®</sup> -III Automatic Transmission Fluid.
Key Lock Cylinders	Multi-Purpose Lubricant, Superlube (GM Part No. U.S. 12346241, in Canada 10953474, or equivalent).
Chassis Lubrication	Chassis Lubricant (GM Part No. U.S. 12377985, in Canada 88901242, or equivalent) or lubricant meeting requirements of NLGI #2, Category LB or GC-LB.
Front and Rear Axle	SAE 75W-90 Synthetic Axle Lubricant (GM Part No. U.S. 12378261, in Canada 10953455) or equivalent meeting GM Specification 9986115.

Usage	Fluid/Lubricant
Transfer Case	AUTO-TRAK II Fluid (GM Part No. U.S. 12378508, in Canada 10953626).
Rear Driveline Center Spline and Universal Joints	Chassis Lubricant (GM Part No. U.S. 12377985, in Canada 88901242, or equivalent) or lubricant meeting requirements of NLGI #2, Category LB or GC-LB.
Constant Velocity Universal Joint	Chassis Lubricant (GM Part No. U.S. 12377985, in Canada 88901242, or equivalent) or lubricant meeting requirements of NLGI #2, Category LB or GC-LB.
Hood Latch Assembly, Secondary Latch, Pivots, Spring Anchor and Release Pawl	Lubriplate Lubricant Aerosol (GM Part No. U.S. 12346293, in Canada 992723, or equivalent) or lubricant meeting requirements of NLGI #2, Category LB or GC-LB.

Usage	Fluid/Lubricant
Hood and Door Hinges, Body Door Hinge Pins, Liftgate Hinge and Linkage, Folding Seats and Fuel Door Hinge	Multi-Purpose Lubricant, Superlube (GM Part No. U.S. 12346241, in Canada 10953474, or equivalent).
Outer Tailgate Handle Pivot Points and Hinges	Multi-Purpose Lubricant, Superlube (GM Part No. U.S. 12346241, in Canada 10953474, or equivalent).
Weatherstrip Conditioning	Dielectric Silicone Grease (GM Part No. U.S. 12345579, in Canada 10953014, or equivalent).
Weatherstrip Squeaks	Synthetic Grease with Teflon, Superlube (GM Part No. U.S. 12371287, in Canada 10953437, or equivalent).

## Part E: Maintenance Record

After the scheduled services are performed, record the date, odometer reading and who performed the service and any additional information from "Owner Checks and Services" or "Periodic Maintenance" on the following record pages. Also, you should retain all maintenance receipts.

### Maintenance Record

Date	Odometer Reading	Serviced By	Maintenance Record



### Maintenance Record (cont'd)

Date	Odometer Reading	Serviced By	Maintenance Record

### Maintenance Record (cont'd)

Date	Odometer Reading	Serviced By	Maintenance Record

### Maintenance Record (cont'd)

Date	Odometer Reading	Serviced By	Maintenance Record

## Section 7 Customer Assistance Information

---

<b>Customer Assistance Information</b> .....	7-2	<b>Reporting Safety Defects</b> .....	7-9
Customer Satisfaction Procedure .....	7-2	Reporting Safety Defects to the United States	
Online Owner Center .....	7-3	Government .....	7-9
Customer Assistance for Text		Reporting Safety Defects to the Canadian	
Telephone (TTY) Users .....	7-3	Government .....	7-9
Customer Assistance Offices .....	7-4	Reporting Safety Defects to General Motors .....	7-10
GM Mobility Program for Persons with		Service Publications Ordering Information .....	7-10
Disabilities .....	7-5		
Roadside Assistance Program .....	7-5		
Courtesy Transportation .....	7-7		

# Customer Assistance Information

## Customer Satisfaction Procedure

Your satisfaction and goodwill are important to your dealer and to Chevrolet. Normally, any concerns with the sales transaction or the operation of your vehicle will be resolved by your dealer's sales or service departments. Sometimes, however, despite the best intentions of all concerned, misunderstandings can occur. If your concern has not been resolved to your satisfaction, the following steps should be taken:

**STEP ONE:** Discuss your concern with a member of dealership management. Normally, concerns can be quickly resolved at that level. If the matter has already been reviewed with the sales, service or parts manager, contact the owner of the dealership or the general manager.

**STEP TWO:** If after contacting a member of dealership management, it appears your concern cannot be resolved by the dealership without further help, contact the Chevrolet Customer Assistance Center by calling 1-800-222-1020. In Canada, contact GM of Canada Customer Communication Centre in Oshawa by calling 1-800-263-3777 (English) or 1-800-263-7854 (French).

We encourage you to call the toll-free number in order to give your inquiry prompt attention. Please have the following information available to give the Customer Assistance Representative:

- Vehicle Identification Number (This is available from the vehicle registration or title, or the plate at the top left of the instrument panel and visible through the windshield.)
- Dealership name and location
- Vehicle delivery date and present mileage

When contacting Chevrolet, please remember that your concern will likely be resolved at a dealer's facility. That is why we suggest you follow Step One first if you have a concern.

**STEP THREE:** Both General Motors and your dealer are committed to making sure you are completely satisfied with your new vehicle. However, if you continue to remain unsatisfied after following the procedure outlined in Steps One and Two, you should file with the GM/BBB Auto Line Program to enforce any additional rights you may have. Canadian owners refer to your Warranty and Owner Assistance Information booklet for information on the Canadian Motor Vehicle Arbitration Plan (CAMVAP).

The BBB Auto Line Program is an out of court program administered by the Council of Better Business Bureaus to settle automotive disputes regarding vehicle repairs or the interpretation of the New Vehicle Limited Warranty. Although you may be required to resort to this informal dispute resolution program prior to filing a court action, use of the program is free of charge and your case will generally be heard within 40 days. If you do not agree with the decision given in your case, you may reject it and proceed with any other venue for relief available to you.

You may contact the BBB using the toll-free telephone number or write them at the following address:

BBB Auto Line  
Council of Better Business Bureaus, Inc.  
4200 Wilson Boulevard  
Suite 800  
Arlington, VA 22203-1804  
Telephone: 1-800-955-5100

This program is available in all 50 states and the District of Columbia. Eligibility is limited by vehicle age, mileage and other factors. General Motors reserves the right to change eligibility limitations and/or discontinue its participation in this program.

## Online Owner Center

The Owner Center at MyGMLink is a resource for your GM ownership needs. You can find your specific vehicle information all in one place.

### The Owner Center allows you to:

- Get e-mail service reminders.
- Access information about your specific vehicle, including tips and videos and an electronic version of this owner's manual.
- Keep track of your vehicle's service history and maintenance schedule.
- Find GM dealers for service nationwide.
- Receive special promotions and privileges only available to MyGMLink members.

Refer to the web for updated information.

To register your vehicle visit [www.MyGMLink.com](http://www.MyGMLink.com).

## Customer Assistance for Text Telephone (TTY) Users

To assist customers who are deaf, hard of hearing, or speech-impaired and who use Text Telephones (TTYs), Chevrolet has TTY equipment available at its Customer Assistance Center. Any TTY user can communicate with Chevrolet by dialing: 1-800-833-CHEV (2438). (TTY users in Canada can dial 1-800-263-3830.)

## Customer Assistance Offices

Chevrolet encourages customers to call the toll-free number for assistance. If a U.S. customer wishes to write to Chevrolet, the letter should be addressed to Chevrolet's Customer Assistance Center.

### United States

Chevrolet Motor Division  
Chevrolet Customer Assistance Center  
P.O. Box 33170  
Detroit, MI 48232-5170

1-800-222-1020

1-800-833-2438 (For Text Telephone devices (TTYs))

Roadside Assistance: 1-800-CHEV-USA® (243-8872)

Fax Number: 313-381-0022

From Puerto Rico:

1-800-496-9992 (English)

1-800-496-9993 (Spanish)

Fax Number: 313-381-0022

From U.S. Virgin Islands:

1-800-496-9994

Fax Number: 313-381-0022

### Canada

General Motors of Canada Limited  
Customer Communication Centre, 163-005  
1908 Colonel Sam Drive  
Oshawa, Ontario L1H 8P7

1-800-263-3777 (English)

1-800-263-7854 (French)

1-800-263-3830 (For Text Telephone devices (TTYs))

Roadside Assistance: 1-800-268-6800

### All Overseas Locations

Please contact the local General Motors Business Unit.

### Mexico, Central America and Caribbean Islands/Countries (Except Puerto Rico and U.S. Virgin Islands)

General Motors de Mexico, S. de R.L. de C.V.

Customer Assistance Center

Paseo de la Reforma # 2740

Col. Lomas de Bezares

C.P. 11910, Mexico, D.F.

01-800-508-0000

Long Distance: 011-52-53 29 0 800

## GM Mobility Program for Persons with Disabilities



This program, available to qualified applicants, can reimburse you up to \$1,000 toward aftermarket driver or passenger adaptive equipment you may require for your vehicle (hand controls, wheelchair/scooter lifts, etc.).

This program can also provide you with free resource information, such as area driver assessment centers and mobility equipment installers. The program is available for a limited period of time from the date of vehicle purchase/lease. See your dealer for more details or call the GM Mobility Assistance Center at 1-800-323-9935. Text telephone (TTY) users, call 1-800-833-9935.

GM of Canada also has a Mobility Program. Call 1-800-GM-DRIVE (463-7483) for details. All TTY users call 1-800-263-3830.

## Roadside Assistance Program

To enhance Chevrolet's strong commitment to customer satisfaction, Chevrolet is excited to announce the establishment of the Chevrolet Roadside Assistance Center. As the owner of a 2003 Chevrolet, membership in Roadside Assistance is free.

Roadside Assistance is available 24 hours a day, 365 days a year, by calling 1-800-CHEV-USA (243-8872). This toll-free number will provide you over-the-phone roadside assistance with minor mechanical problems. If your problem cannot be resolved over the phone, our advisors have access to a nationwide network of dealer recommended service providers. Roadside membership is free; however some services may incur costs.

Roadside offers two levels of service to the customer, *Basic Care* and *Courtesy Care*:

Roadside *Basic Care* provides:

- Toll-free number, 1-800-CHEV-USA (243-8872), text telephone (TTY) users, call 1-888-889-2438
- Free towing for warranty repairs
- Basic over-the-phone technical advice
- Available dealer services at reasonable costs (i.e., wrecker services, locksmith/key service, glass repair, etc.)



Roadside *Courtesy Care* provides:

- Roadside *Basic Care* services (as outlined previously)
- Plus:
- FREE Non-Warranty Towing (to the closest dealer from a legal roadway)
  - FREE Locksmith/Key Service (when keys are lost on the road or locked inside)
  - FREE Flat Tire Service (spare installed on the road)
  - FREE Jump Start (at home or on the road)
  - FREE Fuel Delivery (\$5 of fuel delivered on the road)

Chevrolet offers *Courtesy Transportation* for customers needing warranty service. *Courtesy Transportation* will be offered in conjunction with the coverage provided by the Bumper-to-Bumper New Vehicle Limited Warranty to eligible purchasers of 2003 Chevrolet passenger cars and light duty trucks. (See your selling dealer for details.)

*Courtesy Care* is available to retail and retail lease customers operating 2003 and newer Chevrolet vehicles for a period of 3 years/36,000 miles (60 000 km), whichever occurs first. All *Courtesy Care* services must be pre-arranged by Chevrolet Roadside or dealer service management.

*Basic Care* and *Courtesy Care* are not part of or included in the coverage provided by the New Vehicle Limited Warranty. Chevrolet reserves the right to modify or discontinue *Basic Care* and *Courtesy Care* at any time.

The Roadside Assistance Center uses companies that will provide you with quality and priority service. When roadside services are required, our advisors will explain any payment obligations that may be incurred for utilizing outside services.

For prompt assistance when calling, please have the following available to give to the advisor;

- Vehicle Identification Number (VIN)
- License plate number
- Vehicle color
- Vehicle location
- Telephone number where you can be reached
- Vehicle mileage
- Description of problem

## Canadian Roadside Assistance

Vehicles purchased in Canada have an extensive Roadside Assistance program accessible from anywhere in Canada or the United States. Please refer to the Warranty and Owner Assistance Information book.

## Courtesy Transportation

Chevrolet has always exemplified quality and value in its offering of motor vehicles. To enhance your ownership experience, we and our participating dealers are proud to offer Courtesy Transportation, a customer support program for new vehicles.

The Courtesy Transportation program is offered to retail purchase/lease customers in conjunction with the Bumper-to-Bumper coverage provided by the New Vehicle Limited Warranty. Several transportation options are available when warranty repairs are required. This will reduce your inconvenience during warranty repairs.

### Plan Ahead When Possible

When your vehicle requires warranty service, you should contact your dealer and request an appointment. By scheduling a service appointment and advising your service consultant of your transportation needs, your dealer can help minimize your inconvenience.

If your vehicle cannot be scheduled into the service department immediately, keep driving it until it can be scheduled for service, unless, of course, the problem is safety-related. If it is, please call your dealership, let them know this, and ask for instructions.

If the dealer requests that you simply drop the vehicle off for service, you are urged to do so as early in the work day as possible to allow for same day repair.

## Transportation Options

Warranty service can generally be completed while you wait. However, if you are unable to wait Chevrolet helps minimize your inconvenience by providing several transportation options. Depending on the circumstances, your dealer can offer you one of the following:

### Shuttle Service

Participating dealers can provide you with shuttle service to get you to your destination with minimal interruption of your daily schedule. This includes a one way shuttle ride to a destination up to 10 miles from the dealership.

### Public Transportation or Fuel Reimbursement

If your vehicle requires overnight warranty repairs, reimbursement up to \$30 per day (five day maximum) may be available for the use of public transportation such as taxi or bus. In addition, should you arrange transportation through a friend or relative, reimbursement for reasonable fuel expenses up to \$10 per day (five day maximum) may be available. Claim amounts should reflect actual costs and be supported by original receipts.

## Courtesy Rental Vehicle

When your vehicle is unavailable due to overnight warranty repairs, your dealer may arrange to provide you with a courtesy rental vehicle or reimburse you for a rental vehicle you obtained, at actual cost, up to a maximum of \$30.00 per day supported by receipts. This requires that you sign and complete a rental agreement and meet state, local and rental vehicle provider requirements. Requirements vary and may include minimum age requirements, insurance coverage, credit card, etc. You are responsible for fuel usage charges and may also be responsible for taxes, levies, usage fees, excessive mileage or rental usage beyond the completion of the repair.

Generally it is not possible to provide a like-vehicle as a courtesy rental.

## Additional Program Information

Courtesy Transportation is available during the Bumper-to-Bumper warranty coverage period, but it *is not* part of the New Vehicle Limited Warranty. A separate booklet entitled "Warranty and Owner Assistance Information" furnished with each new vehicle provides detailed warranty coverage information.

Courtesy Transportation is available only at participating dealers and all program options, such as shuttle service, may not be available at every dealer. Please contact your dealer for specific information about availability. All Courtesy Transportation arrangements will be administered by appropriate dealer personnel.

**Canadian Vehicles:** For warranty repairs during the Complete Vehicle Coverage period of the General Motors of Canada New Vehicle Limited Warranty, alternative transportation may be available under the Courtesy Transportation Program. Please consult your dealer for details.

*General Motors reserves the right to unilaterally modify, change or discontinue Courtesy Transportation at any time and to resolve all questions of claim eligibility pursuant to the terms and conditions described herein at its sole discretion.*

## Reporting Safety Defects

### Reporting Safety Defects to the United States Government

If you believe that your vehicle has a defect which could cause a crash or could cause injury or death, you should immediately inform the National Highway Traffic Safety Administration (NHTSA), in addition to notifying General Motors.

If NHTSA receives similar complaints, it may open an investigation, and if it finds that a safety defect exists in a group of vehicles, it may order a recall and remedy campaign. However, NHTSA cannot become involved in individual problems between you, your dealer or General Motors.

To contact NHTSA, you may either call the Auto Safety Hotline toll-free at 1-800-424-9393 (or 366-0123 in the Washington, D.C. area) or write to:

NHTSA, U.S. Department of Transportation  
Washington, D.C. 20590

You can also obtain other information about motor vehicle safety from the hotline.

### Reporting Safety Defects to the Canadian Government

If you live in Canada, and you believe that your vehicle has a safety defect, you should immediately notify Transport Canada, in addition to notifying General Motors of Canada Limited. You may write to:

Transport Canada  
330 Sparks Street  
Tower C  
Ottawa, Ontario K1A 0N5

## Reporting Safety Defects to General Motors

In addition to notifying NHTSA (or Transport Canada) in a situation like this, we certainly hope you'll notify us. Please call us at 1-800-222-1020, or write:

Chevrolet Motor Division  
Chevrolet Customer Assistance Center  
P.O. Box 33170  
Detroit, MI 48232-5170

In Canada, please call us at 1-800-263-3777 (English) or 1-800-263-7854 (French). Or, write:

General Motors of Canada Limited  
Customer Communication Centre, 163-005  
1908 Colonel Sam Drive  
Oshawa, Ontario L1H 8P7

## Service Publications Ordering Information

### Service Manuals

Service Manuals have the diagnosis and repair information on engines, transmission, axle, suspension, brakes, electrical, steering, body, etc.

RETAIL SELL PRICE: \$120.00

### Transmission, Transaxle, Transfer Case Unit Repair Manual

This manual provides information on unit repair service procedures, adjustments, and specifications for GM transmissions, transaxles, and transfer cases.

RETAIL SELL PRICE: \$50.00

## Service Bulletins

Service Bulletins give technical service information needed to knowledgeably service General Motors cars and trucks. Each bulletin contains instructions to assist in the diagnosis and service of your vehicle.

In Canada, information pertaining to Product Service Bulletins can be obtained by contacting your General Motors dealer or by calling 1-800-GM-DRIVE (1-800-463-7483).

## Owner's Information

Owner publications are written specifically for owners and intended to provide basic operational information about the vehicle. The owner's manual will include the Maintenance Schedule for all models.

In-Portfolio: Includes a Portfolio, Owner's Manual, and Warranty Booklet.

RETAIL SELL PRICE: \$35.00

Without Portfolio: Owner's Manual only.

RETAIL SELL PRICE: \$25.00

## Current and Past Model Order Forms

Service Publications are available for current and past model GM vehicles. To request an order form, please specify year and model name of the vehicle.

**ORDER TOLL FREE: 1-800-551-4123**  
**Monday-Friday 8:00 AM - 6:00 PM Eastern Time**

For Credit Card Orders Only  
(VISA-MasterCard-Discover), visit Helm, Inc. on the World Wide Web at: [www.helminc.com](http://www.helminc.com)

Or you can write to:

Helm, Incorporated  
P. O. Box 07130  
Detroit, MI 48207

Prices are subject to change without notice and without incurring obligation. Allow ample time for delivery.

Note to Canadian Customers: All listed prices are quoted in U.S. funds. Canadian residents are to make checks payable in U.S. funds.



## A

Accessory Power Outlets .....	3-18	Appearance Care (cont.)	
Adding a Snow Plow or Similar Equipment .....	4-46	Cleaning the Inside of Your Vehicle .....	5-75
Adding Washer Fluid .....	5-36	Cleaning the Outside of Your Vehicle .....	5-78
Additional Program Information .....	7-8	Finish Damage .....	5-80
Additives, Fuel .....	5-6	GM Vehicle Care/Appearance Materials .....	5-81
Add-On Electrical Equipment .....	5-84	Sheet Metal Damage .....	5-80
Adjusting the Speakers (Balance/Fade) .....	3-61, 3-67, 3-76	Underbody Maintenance .....	5-81
Air Bag		Weatherstrips .....	5-78
Readiness Light .....	3-35	Ashtrays .....	3-18
Air Bag Systems .....	1-49	Audio Speakers .....	3-84
How Does an Air Bag Restrain? .....	1-55	Audio System(s) .....	3-58
Servicing Your Air Bag-Equipped Vehicle .....	1-58	Audio Steering Wheel Controls .....	3-95
What Makes an Air Bag Inflate? .....	1-55	Care of Your Cassette Tape Player .....	3-96
What Will You See After an Air Bag Inflates? .....	1-56	Care of Your CD and DVD Player .....	3-97
When Should an Air Bag Inflate? .....	1-54	Care of Your CDs and DVDs .....	3-97
Where Are the Air Bags? .....	1-52	Chime Level Adjustment .....	3-97
Air Cleaner/Filter, Engine .....	5-19	Fixed Mast Antenna .....	3-97
All Overseas Locations .....	7-4	Audio Systems	
Aluminum Wheels .....	5-80	Radio Personalization .....	3-94
AM .....	3-95	Audio System(s)	
Antenna, Fixed Mast .....	3-97	Radio with Cassette and CD .....	3-65
Anti-Lock Brake System .....	4-6	Radio with CD .....	3-59
Anti-Lock Brake, System Warning Light .....	3-38	Radio with Six-Disc CD .....	3-74
Appearance Care .....	5-75	Rear Seat Audio (RSA) .....	3-93
Care of Safety Belts .....	5-78	Setting the Time .....	3-58
Chemical Paint Spotting .....	5-81	Theft-Deterrent Feature .....	3-94
		Understanding Radio Reception .....	3-95
		Automatic Headlamp System .....	3-14
		Automatic Transfer Case .....	2-25



Automatic Transmission	
Fluid .....	5-21
Operation .....	2-22
Automatic Transmission Check .....	6-11
Automatic Transmission Shift Lock Control	
System Check .....	6-12

## B

Backglass Wiper Blade Replacement .....	5-52
Backing Up .....	4-53
Battery .....	5-39
BATTERY NOT CHARGING .....	3-55
Battery Replacement .....	2-7
Battery Run-Down Protection .....	3-17
Before Leaving on a Long Trip .....	4-32
Before You Drive .....	3-83
Body Lubrication Service .....	6-11
Brake	
Parking .....	2-28
System Inspection .....	6-14
System Warning Light .....	3-37
Brake Adjustment .....	5-39
Brake Fluid .....	5-36
Brake Pedal Travel .....	5-39
Brake Wear .....	5-38
Brakes .....	5-36
Braking .....	4-5
Braking in Emergencies .....	4-7

Break-In, New Vehicle .....	2-19
Bulb Replacement .....	5-48
Replacement Bulbs .....	5-49
Taillamps and Turn Signal Lamps .....	5-48
Buying New Tires .....	5-56

## C

California Fuel .....	5-5
Canada .....	7-4
Canadian Owners .....	ii
Canadian Roadside Assistance .....	7-6
Capacities and Specifications .....	5-96
Carbon Monoxide .....	4-35, 4-47, 2-31
Care of	
Safety Belts .....	5-78
Your Cassette Tape Player .....	3-96
Your CD and DVD Player .....	3-97
Your CDs and DVDs .....	3-97
Cargo Cover .....	2-49
Cargo Tie Downs .....	2-50
Cassette Tape Messages .....	3-72
Cassette Tape Player Service .....	6-10
Center Seat Position, Child Restraints .....	1-48
Chains, Tires .....	5-60
Charging System Light .....	3-36
Check	
Engine Light .....	3-39
Gages Warning Light .....	3-44

CHECK WASHER FLUID .....	3-56	Cleaning (cont.)	
Checking Brake Fluid .....	5-37	Video Screen .....	3-97
Checking Coolant .....	5-24	Weatherstrips .....	5-78
Checking Engine Oil .....	5-15	Cleaning Exterior Lamps/Lenses .....	5-78
Checking Things Under the Hood .....	5-10	Climate Control System	
Checking Your Restraint Systems .....	1-59	Climate Controls Personalization .....	3-31
Chemical Paint Spotting .....	5-81	Dual .....	3-19
Child Restraints		Dual Automatic .....	3-22
Center Seat Position .....	1-48	Rear .....	3-27
Child Restraint Systems .....	1-35	Steering Wheel Controls .....	3-31
Infants and Young Children .....	1-31	Compact Disc Messages .....	3-65, 3-73, 3-83
Lower Anchorages and Top Tethers for		Compass Calibration .....	2-34
Children (LATCH System) .....	1-40	Compass Operation .....	2-34
Older Children .....	1-29	Compass Variance .....	2-34
Securing a Child Restraint Designed		Content Theft-Deterrent .....	2-17
for the LATCH System .....	1-42	Control of a Vehicle .....	4-5
Securing a Child Restraint in a Rear		Convenience Net .....	2-49
Outside Seat Position .....	1-43	Coolant	
Securing a Child Restraint in the Right		Engine Temperature Gage .....	3-38
Front Seat Position .....	1-46	Heater, Engine .....	2-21
Top Strap .....	1-38	Cooling System .....	5-28
Top Strap Anchor Location .....	1-40	Cruise Control .....	3-10
Where to Put the Restraint .....	1-38	Cruise Control Light .....	3-43
Chime Level Adjustment .....	3-97	Current and Past Model Order Forms .....	7-11
Cigarette Lighter .....	3-18	Customer Assistance Information	
Cleaning		Courtesy Transportation .....	7-7
Inside of Your Vehicle .....	5-75	Customer Assistance for Text	
Outside of Your Vehicle .....	5-78	Telephone (TTY) Users .....	7-3
Underbody Maintenance .....	5-81		

Customer Assistance Information (cont.)	
Customer Assistance Offices .....	7-4
Customer Satisfaction Procedure .....	7-2
GM Mobility Program for Persons with Disabilities .....	7-5
Reporting Safety Defects to General Motors ....	7-10
Reporting Safety Defects to the Canadian Government .....	7-9
Reporting Safety Defects to the United States Government .....	7-9
Roadside Assistance Program .....	7-5
Service Publications Ordering Information .....	7-10

## D

Daytime Running Lamps .....	3-15
Defensive Driving .....	4-2
Defogging and Defrosting .....	3-20, 3-25
Delayed Locking .....	2-9
Dinghy Towing .....	4-42
Doing Your Own Service Work .....	5-3
Dome Lamp Override .....	3-16
Dome Lamps .....	3-17
Door	
Delayed Locking .....	2-9
Locks .....	2-8
Power Door Locks .....	2-9
Programmable Automatic Door Locks .....	2-10
Rear Door Security Locks .....	2-12

Driver	
Position, Safety Belt .....	1-14
DRIVER DOOR AJAR .....	3-56
Driver Information Center (DIC) .....	3-46
DIC Operation and Displays .....	3-46
DIC Warnings and Messages .....	3-54
Driving	
At Night .....	4-26
City .....	4-30
Defensive .....	4-2
Drunken .....	4-2
Freeway .....	4-31
Hill and Mountain Roads .....	4-33
In Rain and on Wet Roads .....	4-27
Winter .....	4-35
Driving On Grades .....	4-54
Driving on Snow or Ice .....	4-36
Driving Through Deep Standing Water .....	4-29
Driving Through Flowing Water .....	4-29
Driving with a Trailer .....	4-52
Dual Automatic Climate Control System .....	3-22
Dual Climate Control System .....	3-19
DVD	
Cleaning the Video Screen .....	3-97
Distortion .....	3-95
Rear Seat Entertainment System .....	3-83
DVD Player .....	3-85

## E

Electrical System	
Add-On Equipment .....	5-84
Fuses and Circuit Breakers .....	5-85
Headlamps .....	5-84
Power Windows and Other Power Options .....	5-84
Windshield Wiper Fuses .....	5-84
Emergency Release for Opening Liftgate .....	2-13
Emissions Inspection and Maintenance	
Programs .....	3-41
Engine	
Air Cleaner/Filter .....	5-19
Battery .....	5-39
Change Engine Oil Light .....	3-42
Check and Service Engine Soon Light .....	3-39
Coolant .....	5-23
Coolant Heater .....	2-21
Coolant Temperature Gage .....	3-38
Cooling System Inspection .....	6-14
Engine Compartment Overview .....	5-12
Exhaust .....	2-31
Fan Noise .....	5-34
Oil .....	5-15
Overheating .....	5-25
Reduced Power Light .....	3-43
Starting .....	2-20
Engine Air Cleaner Filter Restriction	
Indicator Check .....	6-10

Engine Compartment Fuse Block .....	5-85
ENGINE COOLANT HOT/IDLE ENGINE .....	3-55
Engine Coolant Level Check .....	6-9
Engine Oil Additives .....	5-18
Engine Oil Level Check .....	6-9
Engine Oil Scheduled Maintenance .....	6-5
Entertainment System	
Cleaning the Video Screen .....	3-97
DVD Distortion .....	3-95
Entry Lighting .....	3-16
Erasing HomeLink® Buttons .....	2-43
Exit Lighting .....	3-17
Express-Down Window .....	2-16
Extender, Safety Belt .....	1-28
Exterior Lamps .....	3-13

## F

Fabric/Carpet .....	5-75
Filter	
Engine Air Cleaner .....	5-19
Finding a PTY Station .....	3-62, 3-68, 3-76
Finding a Station .....	3-59, 3-66, 3-74
Finish Care .....	5-79
Finish Damage .....	5-80
Fixed Mast Antenna .....	3-97
Flash-to-Pass .....	3-8
Flat Tire .....	5-61
Flat Tire, Changing .....	5-61

Fluid	
Automatic Transmission .....	5-21
Power Steering .....	5-35
Windshield Washer .....	5-35
FM .....	3-95
Fog Lamps .....	3-15
Following Distance .....	4-53
Footnotes .....	6-5
Four-Wheel Drive .....	2-25, 5-46
Front Axle .....	5-46
Front Storage Area .....	2-45
Fuel .....	5-5
Additives .....	5-6
California Fuel .....	5-5
Filling a Portable Fuel Container .....	5-9
Filling Your Tank .....	5-7
Fuels in Foreign Countries .....	5-6
Gage .....	3-45
Gasoline Octane .....	5-5
Gasoline Specifications .....	5-5
Low Warning Light .....	3-45
System Inspection .....	6-14
Fuel Information .....	3-47
FUEL LEVEL LOW .....	3-56
Fuses	
Fuses and Circuit Breakers .....	5-85
Windshield Wiper .....	5-84

## G

Gage	
Check Gages Warning Light .....	3-44
Engine Coolant Temperature .....	3-38
Fuel .....	3-45
Oil Pressure .....	3-41
Speedometer .....	3-34
Tachometer .....	3-34
Voltmeter Gage .....	3-36
Garage Door Opener .....	2-40
Gasoline	
Octane .....	5-5
Specifications .....	5-5
Gate Ajar Light .....	3-44
Gate Operator and Canadian Programming .....	2-42
Glass Surfaces .....	5-77
Glove Box .....	2-44
GM Mobility Program for Persons with Disabilities .....	7-5

## H

Hazard Warning Flashers .....	3-5
Head Restraints .....	1-5
Headlamp High/Low-Beam Changer .....	3-8
Headlamps	
Bulb Replacement .....	5-48
Electrical System .....	5-84
Headphones .....	3-83

Heated Seats .....	1-3
Highway Hypnosis .....	4-33
Hill and Mountain Roads .....	4-33
Hitches .....	4-51
HomeLink® Transmitter, Programming .....	2-41
HomeLink® Transmitter .....	2-40
Hood	
Checking Things Under .....	5-10
Release .....	5-10
Horn .....	3-6
How to Add Coolant to the Coolant Recovery Tank .....	5-29
How to Add Coolant to the Radiator .....	5-32
How to Add Fluid .....	5-22
How to Check .....	5-21, 5-54
How to Check Lubricant .....	5-45
How to Check Power Steering Fluid .....	5-35
How to Use This Manual .....	ii
How to Wear Safety Belts Properly .....	1-14
Hydroplaning .....	4-29

## I

ICE POSSIBLE .....	3-56
If No Steam Is Coming From Your Engine .....	5-27
If Steam Is Coming From Your Engine .....	5-26
If the Light Is Flashing .....	3-40

If the Light Is On Steady .....	3-40
If You Are Stuck in Sand, Mud, Ice or Snow .....	4-39
If You Do Decide To Pull A Trailer .....	4-48
If You're Caught in a Blizzard .....	4-37
Ignition Positions .....	2-19
Ignition Transmission Lock Check .....	6-12
Infants and Young Children, Restraints .....	1-31
Inflation -- Tire Pressure .....	5-53
Inspection	
Brake System .....	6-14
Engine Cooling System .....	6-14
Exhaust System .....	6-14
Fuel System .....	6-14
Part C - Periodic Maintenance .....	6-13
Steering, Suspension and Front Drive	
Axle Boot and Seal .....	6-13
Transfer Case and Front Axle (Four-Wheel Drive) .....	6-14
Instrument Panel	
Cluster .....	3-33
Overview .....	3-4
Instrument Panel Brightness .....	3-16
Interior Lamps .....	3-16
Interior Plastic Components .....	5-77

## J

Jump Starting .....	5-40
---------------------	------

## K

Key Lock Cylinders Service .....	6-11
Keyless Entry System .....	2-5
Keys .....	2-3

## L

Lamps	
Exterior .....	3-13
Interior .....	3-16
Lamps On Reminder .....	3-14
Lap-Shoulder Belt .....	1-15, 1-23
LATCH System	
Child Restraints .....	1-40
Securing a Child Restraint Designed for the LATCH System .....	1-42
Leather .....	5-77
Leaving Your Vehicle .....	2-12
Leaving Your Vehicle With the Engine Running .....	2-29
LEFT REAR DOOR AJAR .....	3-57
Liftgate Release .....	2-13
Liftgate/Liftglass .....	2-13
Liftglass/Liftgate .....	2-13
Light	
Air Bag Readiness .....	3-35
Anti-Lock Brake System Warning .....	3-38
Brake System Warning .....	3-37
Change Engine Oil .....	3-42
Charging System .....	3-36

## Light (cont.)

Check Gages Warning .....	3-44
Cruise Control .....	3-43
Gate Ajar .....	3-44
Low Fuel Warning .....	3-45
Malfunction Indicator .....	3-39
Reduced Engine Power .....	3-43
Safety Belt Reminder .....	3-35
Security .....	3-42
Service Four-Wheel-Drive Warning Light .....	3-44
Lighted Visor Vanity Mirror .....	2-16
Loading Your Vehicle .....	4-45
Locking Rear Axle .....	4-9
Lockout Protection .....	2-12
Locks	
Delayed Locking .....	2-9
Door .....	2-8
Leaving Your Vehicle .....	2-12
Lockout Protection .....	2-12
Power Door .....	2-9
Programmable Automatic Door Locks .....	2-10
Rear Door Security Locks .....	2-12
Loss of Control .....	4-13
Low Fuel Warning Light .....	3-45
Luggage Carrier .....	2-48
Lumbar	
Manual Controls .....	1-3
Power Controls .....	1-3

## M

Maintenance, Normal Replacement Parts .....	5-98
Maintenance Schedule	
At Each Fuel Fill .....	6-9
At Least Once a Month .....	6-10
At Least Once a Year .....	6-11
At Least Twice a Year .....	6-10
Brake System Inspection .....	6-14
Engine Cooling System Inspection .....	6-14
Exhaust System Inspection .....	6-14
Fuel System Inspection .....	6-14
How This Section is Organized .....	6-3
Introduction .....	6-2
Maintenance Requirements .....	6-2
Part A - Scheduled Maintenance Services .....	6-4
Part B - Owner Checks and Services .....	6-9
Part C - Periodic Maintenance Inspections .....	6-13
Part D - Recommended Fluids and Lubricants .....	6-15
Part E - Maintenance Record .....	6-17
Scheduled Maintenance .....	6-5
Steering, Suspension and Front Drive Axle	
Boot and Seal Inspection .....	6-13
Transfer Case and Front Axle (Four-Wheel	
Drive) Inspection .....	6-14
Using Your .....	6-4
Your Vehicle and the Environment .....	6-2
Maintenance When Trailer Towing .....	4-56

Making Turns .....	4-54
Malfunction Indicator Light .....	3-39
Manual Lumbar Controls .....	1-3
Manual Seats .....	1-2
Matching Transmitter(s) to Your Vehicle .....	2-6
Memory Seat .....	2-52
Message	
DIC Warnings and Messages .....	3-54
Mexico, Central America and Caribbean	
Islands/Countries (Except Puerto Rico	
and U.S. Virgin Islands) .....	7-4
Mirror Operation .....	2-34
Mirrors	
Automatic Dimming Rearview with OnStar®	
and Compass .....	2-34
Outside Automatic Dimming Mirror with Curb	
View Assist .....	2-37
Outside Convex Mirror .....	2-36
Outside Heated Mirrors .....	2-37
Outside Manual Mirrors .....	2-35
Outside Power Mirrors .....	2-36
MyGMLink.com .....	7-3

## N

New Vehicle Break-In .....	2-19
Normal Maintenance Replacement Parts .....	5-98



## O

Odometer .....	3-34
Off-Road Recovery .....	4-11
Oil	
Change Engine Oil Light .....	3-42
Engine .....	5-15
Pressure Gage .....	3-41
OIL PRESSURE LOW/STOP ENGINE .....	3-55
Older Children, Restraints .....	1-29
Online Owner Center .....	7-3
OnStar <sup>®</sup> Personal Calling .....	2-39
OnStar <sup>®</sup> Services .....	2-38
OnStar <sup>®</sup> System .....	2-38
OnStar <sup>®</sup> Virtual Advisor .....	2-39
Operating Your All-Wheel-Drive Vehicle Off	
Paved Roads .....	4-14
Other Warning Devices .....	3-6
Outlet Adjustment .....	3-21, 3-26
Outside	
Automatic Dimming Mirror with Curb	
View Assist .....	2-37
Convex Mirror .....	2-36
Heated Mirrors .....	2-37
Manual Mirrors .....	2-35
Power Mirrors .....	2-36
Overhead Console .....	2-44
Owners, Canadian .....	ii
Owner's Information .....	7-11

## P

Park (P)	
Shifting Out of .....	2-30
Parking	
Brake .....	2-28
Over Things That Burn .....	2-31
Parking Brake and Automatic Transmission	
Park (P) Mechanism Check .....	6-12
Parking on Hills .....	4-55
Park(P)	
Shifting Into .....	2-28
Part A - Scheduled Maintenance Services .....	6-4
Part B - Owner Checks and Services .....	6-9
Part C - Periodic Maintenance Inspections .....	6-13
Part D - Recommended Fluids and Lubricants ....	6-15
Part E - Maintenance Record .....	6-17
PASSENGER DOOR AJAR .....	3-56
Passing .....	4-12, 4-53
Passlock <sup>®</sup> .....	2-18
Personalization .....	3-48
Personalization, Climate Controls .....	3-31
Plan Ahead When Possible .....	7-7
Playing a Cassette Tape .....	3-70
Playing a Compact Disc .....	3-63, 3-72, 3-79
Playing a Specific Loaded	
Compact Disc .....	3-79
Playing the Radio .....	3-59, 3-65, 3-74

Power	
Accessory Outlets .....	3-18
Door Locks .....	2-9
Electrical System .....	5-84
Lumbar Controls .....	1-3
Reduced Engine Light .....	3-43
Seat .....	1-2
Steering Fluid .....	5-35
Windows .....	2-15
Power Steering .....	4-9
Programmable Automatic Door Locks .....	2-10
Programmable Locking Feature .....	2-10
Programmable Unlocking Feature .....	2-11
Programming the HomeLink® Transmitter .....	2-41

## Q

Questions and Answers About Safety Belts .....	1-13
--	------

## R

Radiator Pressure Cap .....	5-25
Radio Messages .....	3-63, 3-70
Radios .....	3-58
Care of Your Cassette Tape Player .....	3-96
Care of Your CD and DVD Player .....	3-97
Care of Your CDs and DVDs .....	3-97
Radio Personalization .....	3-94
Radio with Cassette and CD .....	3-65

Radios (cont.)	
Radio with CD .....	3-59
Radio with Six-Disc CD .....	3-74
Rear Seat Audio .....	3-93
Setting the Time .....	3-58
Theft-Deterrent .....	3-94
Understanding Reception .....	3-95
Rainsense™ Wipers .....	3-9
RDS Messages .....	3-62, 3-69, 3-78
Reading Lamps .....	3-17
REAR ACCESS OPEN .....	3-56
Rear Axle .....	5-45
Locking .....	4-9
Rear Climate Control System .....	3-27
Rear Compartment Storage Panel/Cover .....	2-45
Rear Door Security Locks .....	2-12
Rear Floor Storage Lid .....	2-49
Rear Safety Belt Comfort Guides .....	1-25
Rear Seat Audio (RSA) .....	3-93
Rear Seat Entertainment System .....	3-83
Rear Seat Operation .....	1-6
Rear Seat Passenger Positions .....	1-22
Rear Seat Passengers, Safety Belts .....	1-22
Rear Seats (TrailBlazer EXT) .....	1-7
Rear Underseat Fuse Block .....	5-91
Rear Window Defogger .....	3-21, 3-25
Rearview Mirror, Automatic Dimming with OnStar® and Compass .....	2-34
Reclining Seatbacks .....	1-4

Recreational Vehicle Towing .....	4-42
Reduced Engine Power Light .....	3-43
Remote Control .....	3-87
Remote Keyless Entry System .....	2-5
Remote Keyless Entry System, Operation .....	2-6
Removing the Flat Tire and Installing the Spare Tire .....	5-68
Removing the Spare Tire and Tools .....	5-62
Replacement Bulbs .....	5-49
Replacing Brake System Parts .....	5-39
Replacing Restraint System Parts After a Crash .....	1-60
Reporting Safety Defects	
Canadian Government .....	7-9
General Motors .....	7-10
United States Government .....	7-9
Reprogramming a Single HomeLink® Button .....	2-43
Resetting Defaults .....	2-43
Restraint System Check .....	6-10
Checking Your Restraint Systems .....	1-59
Replacing Restraint System Parts After a Crash .....	1-60
Restraint Systems	
Checking .....	1-59
Replacing Parts .....	1-60
Restraints, Head .....	1-5
Retained Accessory Power (RAP) .....	2-20
RFA # BATTERY LOW .....	3-57
Right Front Passenger Position, Safety Belts .....	1-22
RIGHT REAR DOOR AJAR .....	3-57

Roadside	
Assistance Program .....	7-5
Rocking Your Vehicle To Get It Out .....	4-40
Running Your Engine While You Are Parked .....	2-32

## S

Safety Belt	
Reminder Light .....	3-35
Safety Belts	
Care of .....	5-78
Driver Position .....	1-14
How to Wear Safety Belts Properly .....	1-14
Questions and Answers About Safety Belts .....	1-13
Rear Safety Belt Comfort Guides for Children and Small Adults .....	1-25
Rear Seat Passengers .....	1-22
Right Front Passenger Position .....	1-22
Safety Belt Extender .....	1-28
Safety Belt Use During Pregnancy .....	1-21
Safety Belts Are for Everyone .....	1-9
Safety Chains .....	4-52
Safety Warnings and Symbols .....	iii
Scheduled Maintenance .....	6-5
Seats	
Head Restraints .....	1-5
Heated Seats .....	1-3
Manual .....	1-2

Seats (cont.)	
Manual Lumbar .....	1-3
Memory .....	2-52
Power Lumbar .....	1-3
Power Seats .....	1-2
Rear Seat Operation .....	1-6
Reclining Seatbacks .....	1-4
Securing a Child Restraint	
Designed for the LATCH System .....	1-42
Rear Outside Seat Position .....	1-43
Right Front Seat Position .....	1-46
Security Light .....	3-42
Select .....	3-54
Service .....	5-3
Adding Equipment to the Outside of Your Vehicle .....	5-4
Doing Your Own Work .....	5-3
Engine Soon Light .....	3-39
Four-Wheel-Drive Warning Light .....	3-44
Publications Ordering Information .....	7-10
SERVICE AIR BAG .....	3-55
SERVICE BRAKE SYSTEM .....	3-55
Service Bulletins .....	7-11
Service Engine Soon Light in the United States or Check Engine Light in Canada .....	3-39
Service Manuals .....	7-10
Setting Preset PTYs .....	3-77
Setting Preset Stations .....	3-60, 3-66, 3-75
Setting the Time .....	3-58
Setting the Tone (Bass/Treble) .....	3-60, 3-67, 3-75
Sheet Metal Damage .....	5-80
Shift Lock Release .....	2-24
Shifting Into Park (P) .....	2-28
Shifting Out of Park (P) .....	2-30
Skidding .....	4-13
Snow Plow .....	4-46
Some Other Rainy Weather Tips .....	4-29
Spare Tire Check .....	6-10
Special Fabric Cleaning Problems .....	5-76
Specifications, Capacities .....	5-96
Speedometer .....	3-34
Starter Switch Check .....	6-11
Starting Your Engine .....	2-20
Steering .....	4-9
Steering in Emergencies .....	4-10
Steering, Suspension and Front Drive Axle	
Boot and Seal Inspection .....	6-13
Steering Tips .....	4-10
Steering Wheel Comfort Controls .....	3-31
Steering Wheel Controls, Audio .....	3-95
Stereo RCA Jacks .....	3-84
Storage Areas	
Convenience Net .....	2-49
Front Storage Area .....	2-45
Glove Box .....	2-44
Luggage Carrier .....	2-48
Overhead Console .....	2-44
Rear Floor Storage Lid .....	2-49
Storing a Flat or Spare Tire and Tools .....	5-72
Stuck in Sand, Mud, Ice or Snow .....	4-39

Sun Visors .....	2-16
Sunglasses Storage Compartment .....	2-44
Sunroof .....	2-51

## T

Table .....	2-47
Tachometer .....	3-34
Taillamps	
Turn Signal Lamps .....	5-48
Testing the Alarm .....	2-18
Theft-Deterrent, Radio .....	3-94
Theft-Deterrent Systems .....	2-17
Content Theft-Deterrent .....	2-17
Passlock <sup>®</sup> .....	2-18
Tilt Wheel .....	3-6
Tire Inflation Check .....	6-10
Tires .....	5-53, 5-80
Buying New Tires .....	5-56
Chains .....	5-60
Changing a Flat Tire .....	5-61
If a Tire Goes Flat .....	5-61
Inflation -- Tire Pressure .....	5-53
Inspection and Rotation .....	5-54
Uniform Tire Quality Grading .....	5-57
Wheel Alignment and Tire Balance .....	5-58
Wheel Replacement .....	5-59
When It Is Time for New Tires .....	5-56
To Use the Engine Coolant Heater .....	2-21
Top of the Instrument Panel .....	5-77

Top Strap .....	1-38
Top Strap Anchor Location .....	1-40
Torque Lock .....	2-30
Total Weight on Your Vehicle's Tires .....	4-51
Towing	
Recreational Vehicle .....	4-42
Towing a Trailer .....	4-47
Your Vehicle .....	4-42
Traction	
Assist System (TAS) .....	4-8
Trailer Brakes .....	4-52
Trailer Wiring Harness .....	4-57
TRANS HOT IDLE ENGINE .....	3-56
Transfer Case .....	5-46
Transfer Case and Front Axle (Four-Wheel Drive) Inspection .....	6-14
Transmission	
Fluid, Automatic .....	5-21
Transmission Operation, Automatic .....	2-22
Transmission, Transaxle, Transfer Case Unit Repair Manual .....	7-10
Transportation Options .....	7-7
Travel Note Recorder .....	2-44
Trip Information .....	3-46
Trip Odometer .....	3-34
Turn and Lane Change Signals .....	3-7
TURN SIGNAL ON .....	3-55
Turn Signal/Multifunction Lever .....	3-7
Turn Signals When Towing a Trailer .....	4-54
Two-Wheel-Drive Vehicles .....	4-43

## U

Underbody Flushing Service .....	6-13
Understanding Radio Reception .....	3-95
Uniform Tire Quality Grading .....	5-57
United States .....	7-4
Used Replacement Wheels .....	5-60
Using Cleaner on Fabric .....	5-76
Using HomeLink® .....	2-43
Using RDS .....	3-61, 3-68, 3-76
Using Song List Mode .....	3-81
Using the Recovery Hooks .....	4-40

## V

Vehicle	
Control .....	4-5
Damage Warnings .....	iv
Loading .....	4-45
Symbols .....	iv
Vehicle Identification	
Number (VIN) .....	5-83
Service Parts Identification Label .....	5-83
Vehicle Personalization	
Memory Seat .....	2-52

Vehicle Storage .....	5-39
Video Screen .....	3-85
Vinyl .....	5-77
Visor Vanity Mirror .....	2-16
Visors .....	2-16
Voltmeter Gage .....	3-36

## W

Warning Lights, Gages and Indicators .....	3-32
Warnings	
DIC Warnings and Messages .....	3-54
Hazard Warning Flashers .....	3-5
Other Warning Devices .....	3-6
Safety and Symbols .....	iii
Vehicle Damage .....	iv
Washing Your Vehicle .....	5-78
Weatherstrip Lubrication .....	6-11
Weight of the Trailer .....	4-49
Weight of the Trailer Tongue .....	4-50
What Kind of Engine Oil to Use .....	5-16
What to Add .....	5-37
What to Do with Used Oil .....	5-19
What to Use .....	5-23, 5-35, 5-45

Wheels	
Alignment and Tire Balance .....	5-58
Replacement .....	5-59
When to Add Engine Oil .....	5-16
When to Change Engine Oil (GM Oil Life System) .....	5-18
When to Check .....	5-54
When to Check and Change .....	5-21
When to Check Lubricant .....	5-45
When to Check Power Steering Fluid .....	5-35
When You Are Ready to Leave After Parking on a Hill .....	4-56
Where to Put the Restraint .....	1-38
Why Safety Belts Work .....	1-10
Window Lockout .....	2-16
Windows .....	2-14

Windows (cont.)	
Power .....	2-15
Windshield, Backglass and Wiper Blades .....	5-79
Windshield Washer .....	3-9
Fluid .....	5-35
Windshield Washer Fluid Level Check .....	6-10
Windshield Wiper	
Blade Replacement .....	5-50
Fuses .....	5-84
Windshield Wipers .....	3-8
Winter Driving .....	4-35
Wiper Blade Check .....	6-10

## Y

Your Vehicle and the Environment .....	6-2
--	-----







