

# 2010 Chevrolet Silverado and GMC Sierra Two-mode Hybrid

---

<b>In Brief</b> .....	1-1	<b>Driving Your Vehicle</b> .....	5-1
Initial Drive Information .....	1-2	Your Driving, the Road, and the Vehicle .....	5-2
Hybrid Features .....	1-2	Towing .....	5-2
<b>Seats and Restraint System</b> .....	2-1	<b>Service and Appearance Care</b> .....	6-1
Rear Seats .....	2-2	Service .....	6-2
Restraint System Check .....	2-2	Checking Things Under the Hood .....	6-3
<b>Features and Controls</b> .....	3-1	Electrical System .....	6-23
Storage Areas .....	3-2	Appearance Care .....	6-25
Starting and Operating Your Vehicle .....	3-14	Capacities and Specifications .....	6-26
<b>Instrument Panel</b> .....	4-1	<b>Maintenance Schedule</b> .....	7-1
Climate Controls .....	4-2	Maintenance Schedule .....	7-2
Warning Lights, Gages, and Indicators .....	4-3	<b>Index</b> .....	i-1
Driver Information Center (DIC) .....	4-11		
Audio System(s) .....	4-13		

---

GENERAL MOTORS, GM and the GM Emblem, CHEVROLET, the CHEVROLET Emblem, GMC, the GMC Emblem, and the names SILVERADO and SIERRA are registered trademarks of General Motors.

This manual describes features that may or may not be on your specific vehicle either because they are options that you did not purchase or due to changes subsequent to the printing of this owner manual. Please refer to the purchase documentation relating to your specific vehicle to confirm each of the features found on your vehicle. For vehicles first sold in Canada, substitute the name "General Motors of Canada Limited" for Pontiac Motor Division wherever it appears in this manual.

Keep this manual in the vehicle for quick reference.

## Canadian Owners

### Propriétaires Canadiens

A French language copy of this manual can be obtained from your dealer/retailer or from:

On peut obtenir un exemplaire de ce guide en français auprès du concessionnaire ou à l'adresse suivante:

Helm, Incorporated  
P.O. Box 07130  
Detroit, MI 48207

1-800-551-4123

Numéro de poste 6438 de langue française

[www.helminc.com](http://www.helminc.com)

## **Introduction**

Your hybrid pickup is designed to be more fuel efficient than the standard pickup, which results in reduced carbon dioxide emissions.

## **Using this Supplement**

This supplement contains information specific to the hybrid components of the vehicle. It does not explain everything you need to know about the vehicle. Read this supplement along with the owner manual to learn about the vehicle's features and controls.

## **Index**

A good place to look for what you need is the Index in back of this supplement. It is an alphabetical list of what is in the supplement, and the page number where you will find it.

 **NOTES**

---

---

---

---

---

---

---

---

---

---

---

---

---

---

---

---

---

---

---

---

---

---

---

# Section 1 In Brief

---

<b>Initial Drive Information</b> .....	1-2	Regenerative Braking .....	1-4
Transmission .....	1-2	Battery .....	1-4
<b>Hybrid Features</b> .....	1-2	Service .....	1-4
Hybrid Safety Information .....	1-2		
Fuel Economy Gage .....	1-3		
Automatic Engine Start/Stop Feature .....	1-3		

# Initial Drive Information

## Transmission

### Range Selection Mode

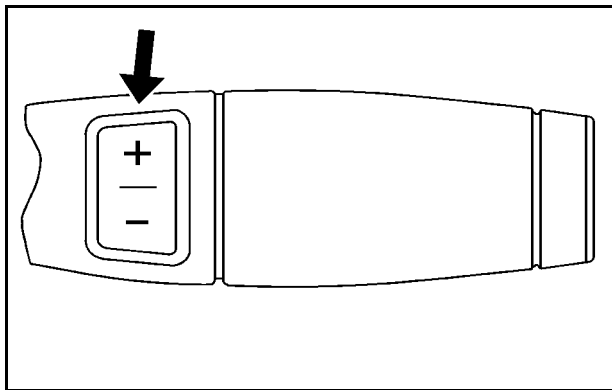

The Range Selection Mode switch is located on the shift lever. To enable the Range Selection feature, move the column shift lever to the M (Manual) position. The current range will appear next to the M. This is the highest attainable range with all lower gears accessible. As an example, when 3 (Third) gear is selected, 1 (First) through 3 (Third) gears are available.

Press the plus/minus buttons, located on the steering column shift lever, to select the desired range of gears for current driving conditions. See Automatic Transmission Operation in the owner manual.

Cruise control can be used while the vehicle is in Range Selection Mode.

## Hybrid Features

### Hybrid Safety Information

This vehicle has a standard 12-volt battery and a high-voltage hybrid battery. Only a trained service technician with the proper knowledge and tools should inspect, test, or replace the hybrid battery. See your dealer/retailer if the hybrid battery needs service.

The 12-volt battery cables, in the engine compartment, are clearly labeled. In emergency situations, first responders can cut those cables to disable the high-voltage hybrid battery system.

## Fuel Economy Gage

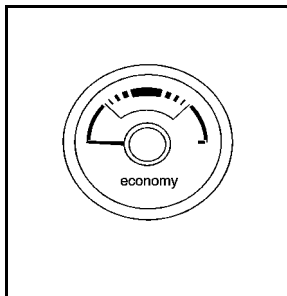

**United States**

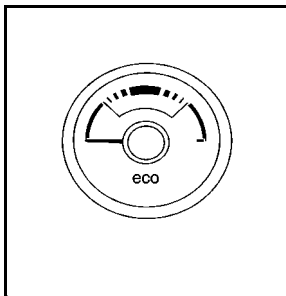

**Canada**

This gage indicates fuel efficiency. To obtain the best fuel efficiency, operate the vehicle so that the indicator is in the high efficiency band.

Modifying both braking and acceleration behavior to keep the indicator in the center of the gage will result in the best system efficiency and fuel economy.

See *Fuel Economy Gage* on page 4-5.

## Automatic Engine Start/Stop Feature

Start the engine as you would any other engine. See “Starting the Engine” in the owner manual for more information on starting. The hybrid system provides very quiet engine starting. If pulling a trailer with trailer brakes, see *Towing a Trailer* on page 5-2 for more information.

### Auto Stop

The vehicle has an Auto Stop feature. After a successful engine start, the engine may turn off and operate in the Auto Stop mode.

Keep your foot firmly on the brake pedal until you are ready for the vehicle to move.

Engine OFF and AUTO STOP modes are indicated on the tachometer display. When the tachometer needle indicates OFF, the engine is not running and will remain off until the ignition key is placed in the START position or a remote vehicle start is performed. When the tachometer needle indicates AUTO STOP, the hybrid system is on, the engine is not running, but may Auto Start at any time without notice. See *Tachometer* on page 4-4 for more information.

A chime will sound if the driver door is opened while in Auto Stop as a reminder that the ignition switch is not in the LOCK/OFF position. Always turn the ignition switch to LOCK/OFF and remove the key from the ignition switch when exiting the vehicle.

## Auto Start

The vehicle also has an Auto Start feature. The engine will remain off while in Auto Stop mode until vehicle conditions require the engine to run. The near-instant starting of the engine from Auto Stop mode is called Auto Start.

## EV Mode

The vehicle also has an EV mode which uses only the electric motor to move the vehicle. With light acceleration, the vehicle will drive in EV mode. EV mode is unavailable when the vehicle is out of fuel.

See Starting the Vehicle in the Two-Mode Hybrid supplement to the owner manual.

## Regenerative Braking

Regenerative braking enables the electric drive motor to operate as a generator when coasting or braking. Energy from the moving vehicle recharges the hybrid battery.

The hydraulic disc brakes work with the regenerative braking to insure effective braking.

The braking system is computer controlled and blends the regenerative braking with the conventional hydraulic disc brakes to meet any requirements for deceleration. Because the controller applies the hydraulic brakes through its high pressure accumulator, you may

occasionally hear the motor driven pump when it recharges the system. This is normal. In the event of a controller problem, the brake pedal may be harder to push and the stopping distance may be longer.

See Regenerative Braking, Warning Lights, Gages, and Indicators and Driver Information Center (DIC) in the owner manual.

## Battery

This vehicle has a standard 12-volt battery and a high-voltage hybrid battery. When a new standard 12-volt battery is needed, see your dealer/retailer for one that has the replacement number shown on the original battery's label.

Only a trained service technician with the proper knowledge and tools should inspect, test, or replace the hybrid battery. See your dealer/retailer if the hybrid battery needs service. See *Battery on page 6-17*.

## Service

Never try to do your own service on hybrid components. You can be injured and the vehicle can be damaged if you try to do your own service work. Service and repair of these hybrid components should only be performed by a trained service technician with the proper knowledge and tools. See *Doing Your Own Service Work on page 6-2*.



## Section 2 Seats and Restraint System

---

<b>Rear Seats</b> .....	2-2	<b>Restraint System Check</b> .....	2-2
Rear Seat Operation (Hybrid Full Bench) .....	2-2	Replacing Restraint System Parts After a Crash .....	2-2

## Rear Seats

### Rear Seat Operation (Hybrid Full Bench)

#### Folding Rear Seat

**Notice:** Folding a rear seat with the safety belts still fastened may cause damage to the seat or the safety belts. Always unbuckle the safety belts and return them to their normal stowed position before folding a rear seat.

Make sure that nothing is on the seat.

To fold the seat, slowly pull the seat cushion up.

To return the seat to the normal seating position, slowly pull the seat cushion down.

#### **WARNING:**

A safety belt that is improperly routed, not properly attached, or twisted will not provide the protection needed in a crash. The person wearing the belt could be seriously injured. After raising the rear seatback, always check to be sure that the safety belts are properly routed and attached, and are not twisted.

## Restraint System Check

### Replacing Restraint System Parts After a Crash

If an airbag inflates or the vehicle has been in a crash, the vehicle's sensing system may command the automatic hybrid battery disconnect to open. The battery will disconnect. The hybrid battery will be off and the vehicle will not start. The airbag readiness light and/or SERVICE HYBRID SYSTEM warning message may come on in the driver information center. See "Airbag Readiness Light" in the owner manual and *Driver Information Center (DIC)* on page 4-11 for more information.

To operate the vehicle, the automatic hybrid battery disconnect must be serviced by a qualified service technician and sensing system parts will need to be replaced. Have the vehicle serviced right away.

## Section 3 Features and Controls

---

<b>Storage Areas</b> .....	3-2	<b>Starting and Operating Your Vehicle</b> .....	3-14
Tonneau Cover (Hard Tonneau) .....	3-2	Starting the Vehicle .....	3-14
Tonneau Cover (Soft Tonneau) .....	3-7	Automatic Transmission Operation .....	3-16
		Engine Coolant Heater .....	3-19
		Regenerative Braking .....	3-21
		Running the Vehicle While Parked .....	3-21

## Storage Areas

### Tonneau Cover (Hard Tonneau)

#### Installing the Cover

#### CAUTION:

An improperly stored cargo cover could be thrown about the vehicle during a collision or sudden maneuver. Someone could be injured. If the cover is removed, always store it in the proper storage location. After positioning the cargo cover back on the vehicle, always be sure that it is securely reattached by properly securing the straps and latches.

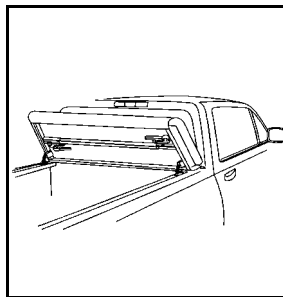

1. Position the tonneau cover onto the top of the pickup box with the locator tabs positioned into the front stake pockets.
2. Align the front edge of the cover with the front edge of the bed rail so that it is centered on each side of the truck bed.
3. Lower the front clamp from its storage position.

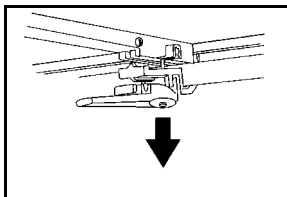

4. Tilt the clamp assembly so that the locator is in the slot, pull down on the assembly, and slide the clamp under the edge of the inner lip of the bed rail.

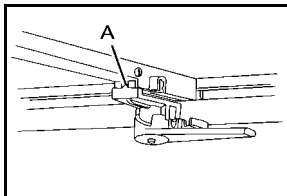

5. Pull the handle toward the rear of the truck to engage the clamp. Make sure the locator is secure into the slot (A). If unable to completely engage clamp, see the tightening and loosening procedures later in this section.
6. The clamp should be securely engaged. Shake the handle assembly to make sure the handle does not move.

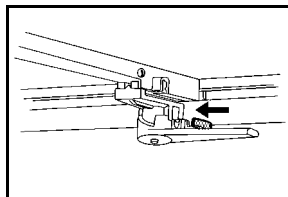

7. There are locking features on the front clamps only. With the handle in the clamped position, push the locking tab to engage the lock.
8. Repeat the clamp attachment steps 3 through 7 for the opposite side.

## Closing the Cover

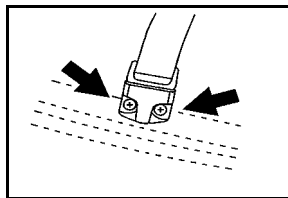

1. Release both the retention straps located on the top of the cover behind the cab and press into the stored position.
2. Unfold the tonneau cover to the closed position.

3. Lower the rear set of clamp assemblies from the stored position.

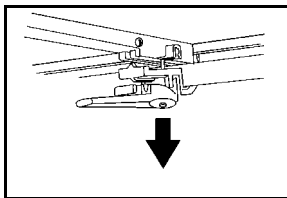

4. Tilt the clamp assembly so that the locator is in the slot, pull down on the assembly, and slide the clamp under the edge of the inner lip on the bed rail.

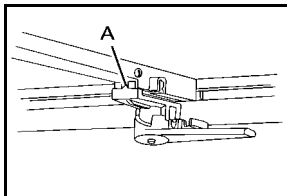

5. Pull the handle toward the rear of the truck to engage the clamp. Make sure the locator is secured into the slot (A). If unable to completely engage clamp, see the tightening and loosening procedures later in this section.

6. The clamp should be securely engaged. Shake the handle assembly to make sure the handle does not move.
7. Repeat the clamp attachment steps 3 through 6 for the opposite side.
8. Close the endgate.

## Opening the Tonneau Cover

1. Turn both of the rear handles inward to release compression.
2. Pull the clamp down and turn the assemblies to disengage them from the lip of the pickup box.
3. Open the cover to expose the handles.

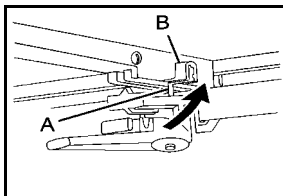

4. Align the clamp assembly bolt (A) with the retention feature (B).
5. Turn the handle assembly and clamp assembly bolt sideways (A) into the slot of the retention feature (B).

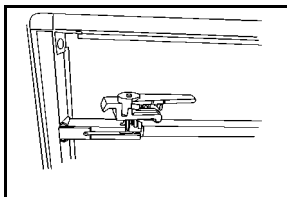

6. The handle should lie flat on the panel with the handles facing inward. Press firmly to secure.  
This step must be done before stowing the cover.
7. Fold the cover forward.

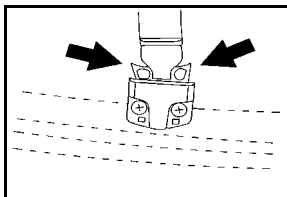

8. Remove the retaining strap from the bow. Connect the retention buckle ends. One end is located on the front of the tonneau cover behind the cab and the other end is on the tonneau cover
9. Pull on each strap to make sure both buckles are attached.

## Removing the Tonneau Cover

1. Open the cover by following the procedure described previously, under "Opening the Tonneau Cover".

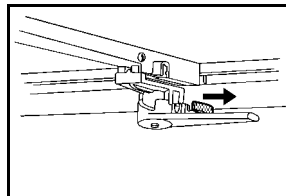

2. Disengage the locking tabs, located on the front handles, by pulling them rearward.
3. Turn the handles inward to release.
4. Pull the clamp down and turn the assembly to disengage it from the lip of the truck box.
5. Turn the cover to expose the handles.

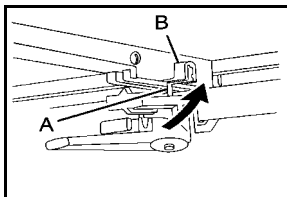

6. Align the clamp assembly bolt (A), with the retention feature (B).
7. Turn the handle assembly sideways by tilting the assembly bolt (A) into the slot of the retention feature (B).

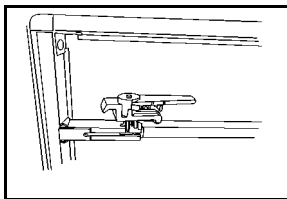

8. The handle should lie flat on the panel with the handles facing inward. Press firmly to secure.
9. Remove the tonneau cover from the vehicle.

## Tightening the Clamp

1. Push the handle forward to release it from the clamped position.
2. Disengage the clamp from the inner edge of the bed rail and slide the assembly inward.
3. Adjust the clamp height on the bolt by turning the entire clamp assembly counter-clockwise.
4. Attach the clamps as indicated in steps 4 and 5 of Installing the Cover.

## Loosening the Clamp

1. Return the handle to the fully disengaged position.
2. Disengage the clamp from the inner edge of the bed rail and slide the assembly inward.
3. Adjust the clamp height by turning the entire clamp assembly clockwise.
4. Reattach the clamps as indicated in steps 4 and 5 of Installing the Cover.



# Tonneau Cover (Soft Tonneau)

## Side Rail

### **WARNING:**

An improperly stored cargo cover could be thrown about the vehicle during a collision or sudden maneuver. Someone could be injured. If the cover is removed, always store it in the proper storage location. After positioning the cargo cover back on the vehicle, always be sure that it is securely reattached by properly securing the straps and latches.

## Installation

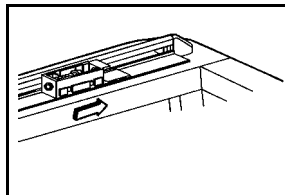

1. The adjuster screw end of each side rail should point in the direction of the cab.

2. Place each side rail on top of the truck box.

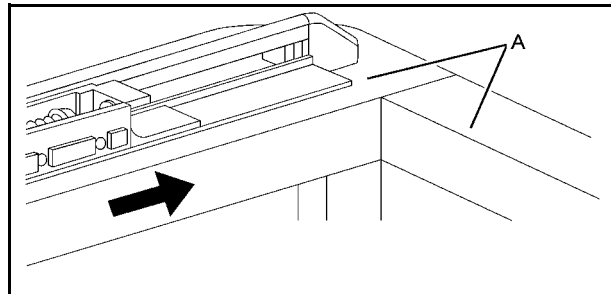

3. Align the front edge of the side rail with the front inside edge of pickup box.

## Clamp Installation

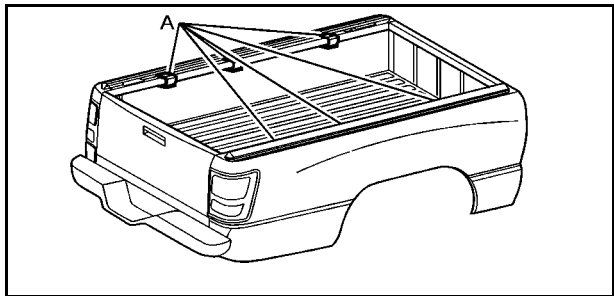

1. Position three outer clamps (A), on each side rail. The positions on the siderails are marked CLAMP.

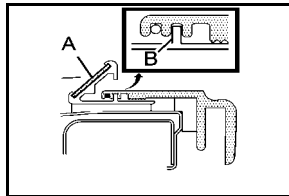

2. Position the grooves of the clamps on the side rails (A) using the center groove (B).

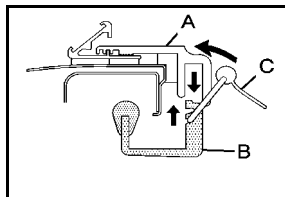
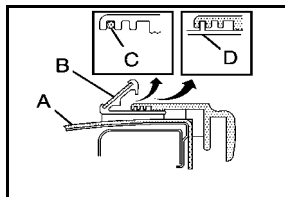

3. If the pickup box has molded bed rail protectors (A), remove the insert (C) from the outer groove on the clamp, and position the clamp on the side rail (B) using the outer groove (D).
4. Slide the inner clamp (B) into the outer clamp (A).
5. Turn the latch (C) onto the outer clamp.

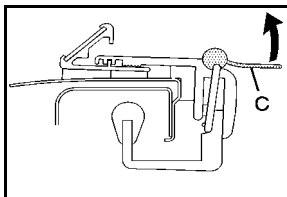

6. Tighten the clamp by turning the latch (C) toward the side rail. Make sure there is no gap between the rubber clamp pad and the side rail.
7. If the truck box has a molded bed rail protector, insert the latch into the top notch on the inner clamp.
8. Clean the vehicle's painted surface below the pull strap using a 50/50 mixture of rubbing alcohol and tap water.

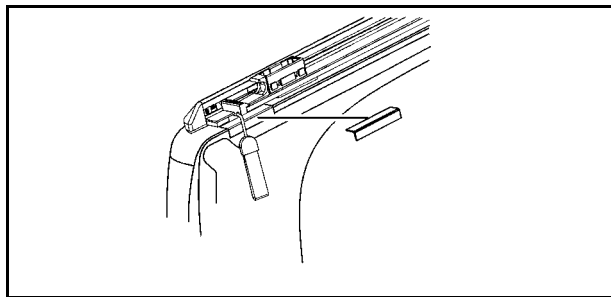

9. Remove the paper from the provided clear tape strip and apply to the painted surface below the pull strap.

### **Adjustment**

If there is excessive sideways movement of the crossrails, move and re-install the clamps on the loose areas using the inner groove of the clamp.

## Cover Installation

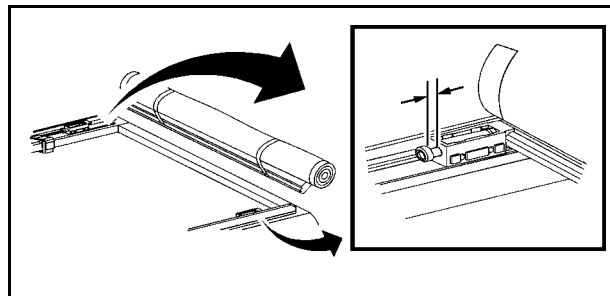
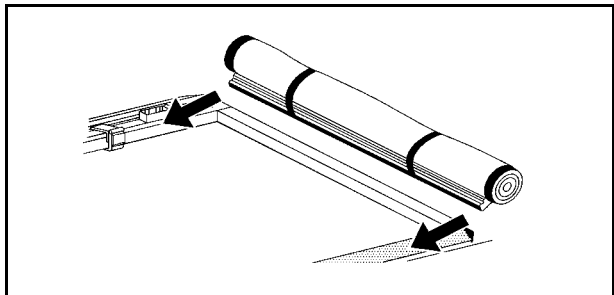

1. Place the cover assembly into the front pivot mounts firmly against the adjustment screws.

2. Verify the gap between the adjuster screws and pivot mounts is  $\frac{3}{16}$  in. Adjust if needed.

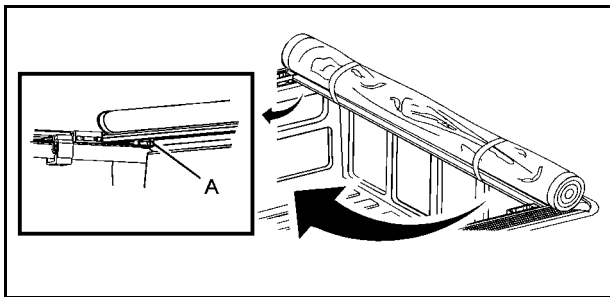

3. Loosen the wing bolt (A), then slide the latch outboard into the side rail. Tighten down the wing bolt (A). Do this on both sides. Both latches must remain engaged and the wing bolts tightened while the cover is on the vehicle. Make sure by lifting up on each end of the cover assembly.

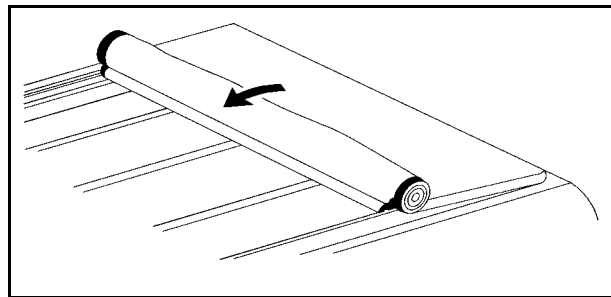

4. Unbuckle both straps and roll the cover out. Make sure that each bow falls in between the side rails. If the bows do not fit between the side rails, verify that the clamps are pushed fully outboard without any gaps between the clamp pad and pickup box. If additional clearance is required, remove the clamp closest to the interference. Remove the orange strip to allow access to the outer slot of the upper clamp. Reinstall the clamp using the outer groove of the upper clamp. If bows are too loose, adjust the clamp closest to the bow with the excessive clearance to the inner groove of the upper clamp.

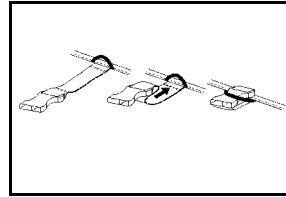
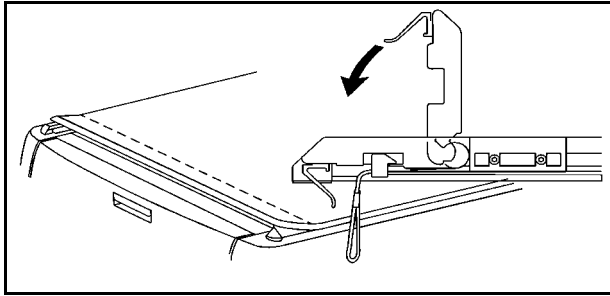

7. Secure the buckles by folding them once, then slide them under the cord located on the cover.

### Secure in Open Position

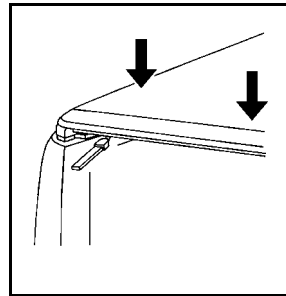

1. To open the cover, open tailgate and push down on the cover. The pull back on pull strap.

5. When the cover is rolled out, place the rear rail into the rear pivot mounts. Firmly press down on each side of the cover, until the latches are secured into the side rails. If latch is too tight, loosen the tension adjustment screws. If the latch is not securely holding the rear rail, tighten the tension adjustment screws. Only the driver's side has a latch.
6. Secure the driver side Velcro<sup>®</sup> of the cover to the side rail. Then pull the cover tight across the bed and fasten the Velcro<sup>®</sup> on the passenger side.

2. From the drivers side, roll the cover up tightly.
3. When the cover is rolled up, buckle both tie-down straps. Pull both straps tight.

## Removal

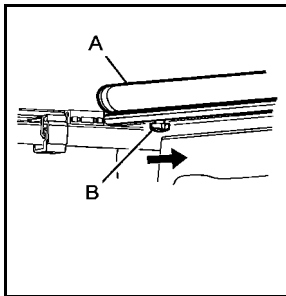

1. Secure the cover (A) into the open position.
2. Loosen wing bolts (B) on both driver and passenger side of front rail, then slide latches inboard until released from the side rail.

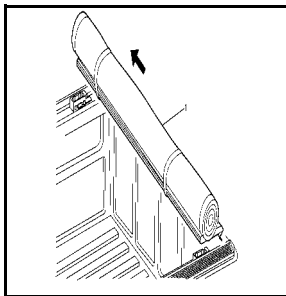

3. Pick the cover assembly up on the driver side and pull the whole assembly off the truck box.

## Adjustment

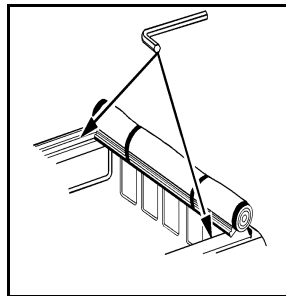

1. If the cover is too loose, turn the tensioning screw clockwise to tighten the tension of the vinyl. This makes it harder to operate the rear release latch. The tensioning screws are located on each side rail. Use the provided 1/4 inch key to turn the tensioning screws.
2. Adjust the screws on both sides to the same tension.

# Starting and Operating Your Vehicle

## Starting the Vehicle

### **WARNING:**

Exiting the vehicle, without first shifting into P (Park), may cause the vehicle to move, and you or others can be seriously injured. Because the vehicle has the Automatic Engine Start/Stop feature, the vehicle's engine might seem to be shut off when you come to a complete stop. However, once the brake pedal is released, the vehicle can move. The vehicle's engine can also restart at any time.

Shift to P (Park) and turn the ignition to LOCK/OFF, before exiting the vehicle.

Start the engine as you would any other engine. See "Starting the Engine" in the owner manual for more information on starting. If pulling a trailer with trailer brakes, see *Towing a Trailer on page 5-2* for more information.

## Auto Stop

The vehicle has an Auto Stop feature. After a successful engine start, the engine may turn off and operate in the Auto Stop mode. Some of the vehicle conditions that allow the engine to stop running and enter the Auto Stop mode are:

- Ignition switch is in the ON/RUN position.
- The hood is closed.
- The gear selector is in P (Park), R (Reverse), N (Neutral) or D (Drive).
- The hybrid battery is at an acceptable state of charge.
- The hybrid battery voltage, temperature or power limits are not exceeded. In very hot conditions, Auto Stop may be unavailable until the hybrid battery has cooled.
- The engine is at operating temperature.
- The vehicle may enter Auto Stop after a remote vehicle start.

If you are on an incline, the hybrid drive motor can help keep the vehicle from rolling backwards, even if the engine is in Auto Stop.

With your foot off the brake and the vehicle on level ground, the hybrid drive motor may cause the vehicle to roll slowly forward, even when the engine is in Auto Stop.



Keep your foot firmly on the brake pedal until you are ready for the vehicle to move.

Engine OFF and AUTO STOP modes are indicated on the tachometer display. When the tachometer needle indicates OFF, the engine is not running and will remain off until the ignition key is placed in the START position or a remote vehicle start is performed. When the tachometer needle indicates AUTO STOP, the hybrid system is on, the engine is not running, but may Auto Start at any time without notice. See *Tachometer on page 4-4* for more information.

A chime will sound if the driver door is opened while in Auto Stop as a reminder that the ignition switch is not in the LOCK/OFF position. Always turn the ignition switch to LOCK/OFF and remove the key from the ignition switch when exiting the vehicle.

## Auto Start

The vehicle also has an Auto Start feature. The engine will remain off while in Auto Stop mode until vehicle conditions require the engine to run. The near-instant starting of the engine from Auto Stop mode is called Auto Start. Some of the vehicle conditions that may cause the engine to Auto Start are:

- The hood is opened.
- The gear selector is in M (Manual Mode).
- The hybrid battery state of charge is too low.

- The hybrid battery voltage, temperature or power limits are exceeded.
- A remote vehicle start has been requested.
- The engine is not at operating temperature.
- Acceleration demands require the use of the engine.

## EV Mode

The vehicle also has an Electric Vehicle (EV) mode which uses only the electric motor to move the vehicle. With light acceleration, the vehicle will drive in EV mode. EV mode is unavailable when the vehicle is out of fuel.

If increased acceleration is required, or the vehicle reaches approximately 40 km/h (30 mph), the engine will start automatically. The engine shuts off at speeds below 40 km/h (25 mph) unless the transmission is in M (Manual Mode) or Auto Stop is disabled.

During heavy acceleration, both the engine and hybrid electric motors supply power. A sensation similar to a transmission gear change can be felt as the transmission changes modes. Engine RPM may remain above 4,000 RPM for a longer period during hard acceleration.

## Automatic Transmission Operation

The vehicle has an electronic shift position indicator within the instrument panel cluster.

There are several different positions for the shift lever.

P R N D M     

See “Range Selection Mode” later in this section.

**P (Park)** : This position locks the rear wheels. It is the best position to use when you start the engine because the vehicle cannot move easily.

When parked on a hill, especially when the vehicle has a heavy load, you may notice an increase in the effort to shift out of P (Park). See “Shifting Into P (Park)” in the Index of vehicle's owner manual for more information.

### **WARNING:**

It is dangerous to get out of the vehicle if the shift lever is not fully in P (Park) with the parking brake firmly set. The vehicle can roll.

Do not leave the vehicle when the engine is running unless you have to. If you have left the engine running, the vehicle can move suddenly. You or others could be injured. To be sure the vehicle will not move, even when you are on fairly level ground, always set the parking brake and move the shift lever to P (Park). See Shifting Into Park in the Owner Manual. If you are pulling a trailer, see *Towing a Trailer on page 5-2*.

 **WARNING:**

If you have Four-Wheel Drive, the vehicle will be free to roll — even if the shift lever is in P (Park) — if the transfer case is in Neutral. So, be sure the transfer case is in a drive gear, Two-Wheel Drive High or Four-Wheel Drive High or Four-Wheel Drive Low — not in Neutral. See “Shifting Into Park” in the Owner Manual.

**R (Reverse):** Use this gear to back up.

**Notice:** Shifting to R (Reverse) while the vehicle is moving forward could damage the transmission. The repairs would not be covered by the vehicle warranty. Shift to R (Reverse) only after the vehicle is stopped.

To rock the vehicle back and forth to get out of snow, ice, or sand without damaging the transmission, see “If Your Vehicle is Stuck in Sand, Mud, Ice, or Snow” in the Index of the vehicle’s owner manual.

**N (Neutral):** In this position, the engine and transmission are not connected with the wheels. To restart the engine when the vehicle is already moving, use N (Neutral) only.

 **WARNING:**

Shifting into a drive gear while the engine is running at high speed is dangerous. Unless your foot is firmly on the brake pedal, the vehicle could move very rapidly. You could lose control and hit people or objects. Do not shift into a drive gear while the engine is running at high speed.

**Notice:** Shifting out of P (Park) or N (Neutral) with the engine running at high speed may damage the transmission. The repairs would not be covered by the vehicle warranty. Be sure the engine is not running at high speed when shifting the vehicle.

**D (Drive):** This position is for normal driving. It provides the best fuel economy. If you need more power for passing, and you are:

- Going less than about 35 mph (55 km/h), push the accelerator pedal about halfway down.
- Going about 35 mph (55 km/h) or more, push the accelerator all the way down.

D (Drive) or M (Manual Mode) can be used when towing a trailer, carrying a heavy load, driving on steep hills, or for off-road driving. You may want to shift the transmission to a lower gear selection if the transmission shifts too often.

Downshifting the transmission in slippery road conditions could result in skidding. See “Skidding” under “Loss of Control” in the owner manual for more information.

When temperatures are very cold, the transmission's gear shifting may be delayed, providing more stable shifts until the engine warms up. Shifts may be more noticeable with a cold transmission. This difference in shifting is normal.

**M (Manual Mode)**: This position lets drivers select the range of gears appropriate for current driving conditions. If the vehicle has this feature, see “Range Selection Mode” later in this section.

**Notice:** Spinning the tires or holding the vehicle in one place on a hill using only the accelerator pedal may damage the transmission. The repair will not be covered by the vehicle warranty. If you are stuck, do not spin the tires. When stopping on a hill, use the brakes to hold the vehicle in place.

The vehicle has a shift stabilization feature that adjusts the transmission shifting to the current driving conditions to reduce rapid upshifts and downshifts. If the shift stabilization feature determines that a current vehicle speed cannot be maintained, the transmission does not upshift. In some cases, this may appear to be a delayed shift, however the transmission is operating normally.

## Range Selection Mode

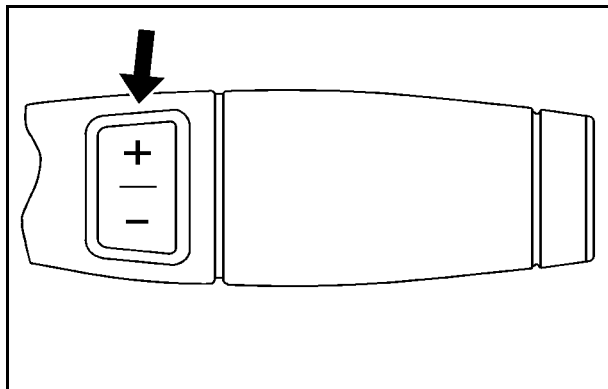

The Range Selection Mode controls the vehicle's transmission.

To use this feature:

1. Move the shift lever to the M (Manual Mode).
2. Press the plus/minus button to upshift or downshift selecting the desired range of gears.

A number displays next to the M, indicating the current gear that has been selected. The number displayed in the gear indicator is the highest gear that can be used.

The vehicle can automatically shift to lower gears as it adjusts to driving conditions. When 3 (Third) is selected, 1 (First) through 3 (Third) gears are automatically shifted by the vehicle, but 4 (Fourth) cannot be used until it is selected.

The Range Selection Mode controls the vehicle and engine speed while driving down a hill or towing a trailer, by allowing you to select a desired range of gears.

When you move the shift lever into M, the transmission will default to M4. In this gear range, effective engine braking occurs at speeds above 45 mph (72 km/h).

Pushing the minus (-) button on the shift lever reduces the gear range.

In the M3 gear range, effective engine braking occurs at speeds above 35 mph (56 km/h).

In the M2 gear range, effective engine braking occurs at speeds above 25 mph (40 km/h).

In the M1 gear range, effective engine braking occurs at speeds above 10 mph (16 km/h).

When operating in M (Manual Mode), Auto Stop is disabled. For better vehicle efficiency, operate the vehicle in D (Drive) not M (Manual Mode).

Cruise control can be used while using the Range Selection Mode.

## Engine Coolant Heater

The engine coolant heater can provide easier starting and better fuel economy during engine warm-up in cold weather conditions at or below  $-18^{\circ}\text{C}$  ( $0^{\circ}\text{F}$ ). Vehicles with an engine heater should be plugged in at least four hours before starting. An internal thermostat in the plug-end of the cord may exist which will prevent engine coolant heater operation at temperatures above  $-18^{\circ}\text{C}$  ( $0^{\circ}\text{F}$ ).

## To Use the Engine Coolant Heater

1. Turn off the engine.
2. Open the hood and unwrap the electrical cord. The cord is secured to a wiring harness between the engine and the Hybrid Auxiliary Underhood Fuse Block with a clip. Carefully remove the wire tie which secures the electrical cord. Do not cut the electrical cord.
3. Plug the cord into a normal, grounded 110-volt AC outlet.

### **WARNING:**

Plugging the cord into an ungrounded outlet could cause an electrical shock. Also, the wrong kind of extension cord could overheat and cause a fire. You could be seriously injured. Plug the cord into a properly grounded three-prong 110-volt AC outlet. If the cord will not reach, use a heavy-duty three-prong extension cord rated for at least 15 amps.

4. Before starting the engine, be sure to unplug and store the cord as it was before to keep it away from moving engine parts. If you do not, it could be damaged.

The length of time the heater should remain plugged in depends on several factors. Ask a dealer/retailer in the area where you will be parking the vehicle for the best advice on this.

## Regenerative Braking

Regenerative braking is a hybrid technology that enables the electric drive motor to operate as a generator when coasting or braking. Energy from the moving vehicle recharges the hybrid battery.

The hydraulic disc brakes work with the regenerative braking to insure effective braking, such as when a high braking demand is requested.

The braking system is computer controlled and blends the regenerative braking with the conventional hydraulic disc brakes to meet any requirements for deceleration. The controller interprets the braking request and uses regenerative braking, conventional hydraulic braking or a combination of both as necessary. Because the controller applies the hydraulic brakes through its high pressure accumulator, you may occasionally hear the motor driven pump when it recharges the system. This is normal.

In the event of a controller problem, the brake pedal may be harder to push and the stopping distance may be longer.

## Running the Vehicle While Parked

It is better not to park with the engine running. But if you ever have to, here are some things to know.

### **WARNING:**

Exiting the vehicle, without first shifting into P (Park), may cause the vehicle to move, and you or others can be seriously injured. Because the vehicle has the Automatic Engine Start/Stop feature, the vehicle's engine might seem to be shut off when you come to a complete stop. However, once the brake pedal is released, the vehicle can move. The vehicle's engine can also restart at any time.

Shift to P (Park) and turn the ignition to LOCK/OFF, before exiting the vehicle.

Follow the proper steps to be sure the vehicle will not move. See "Shifting Into Park" in the owner manual for more information.

If pulling a trailer, see *Towing a Trailer on page 5-2* for more information.

# NOTES

---

---

---

---

---

---

---

---

---

---

---

---

---

---

---

---

---

---

---

---

---

---

---

---



## Section 4 Instrument Panel

---

<b>Climate Controls</b> .....	4-2	Engine Coolant Temperature Gage .....	4-8
<b>Warning Lights, Gages, and Indicators</b> .....	4-3	Oil Pressure Gage .....	4-8
Instrument Panel Cluster .....	4-3	Oil Pressure Light .....	4-9
Tachometer .....	4-4	Fuel Gage .....	4-10
Charging System Light .....	4-4	<b>Driver Information Center (DIC)</b> .....	4-11
Fuel Economy Gage .....	4-5	DIC Warnings and Messages .....	4-11
Brake System Warning Light .....	4-5	<b>Audio System(s)</b> .....	4-13
Antilock Brake System (ABS) Warning Light ....	4-7	Navigation/Radio System .....	4-13
StabiliTrak <sup>®</sup> Indicator Light .....	4-7		

## Climate Controls

For more information on the vehicle's climate control system, see "Climate Control System" in the owner manual.

### Electric Air Conditioning Compressor

This hybrid vehicle has a electrically powered air conditioning compressor. This allows for continuous air conditioning operation and passenger comfort, even while the hybrid engine cycles on and off.

When operating the climate control system, select the AUTO mode and the desired temperature setting. The climate control system automatically adjusts the fan speed and airflow direction. The climate control system continues to adjust the climate control settings chosen for best use of electrical power.

At mild temperatures, select a warmer air conditioner temperature or turn the air conditioner off to get maximum fuel economy. Continuous air conditioner use can cause the vehicle to Auto Start more frequently. During hot weather, driving with the windows closed and the air conditioner set to Auto mode, will result in better Hybrid system performance.

Some noise may be heard occasionally from the compressor, especially when air conditioning use is high and the engine has turned off.

# Warning Lights, Gages, and Indicators

## Instrument Panel Cluster

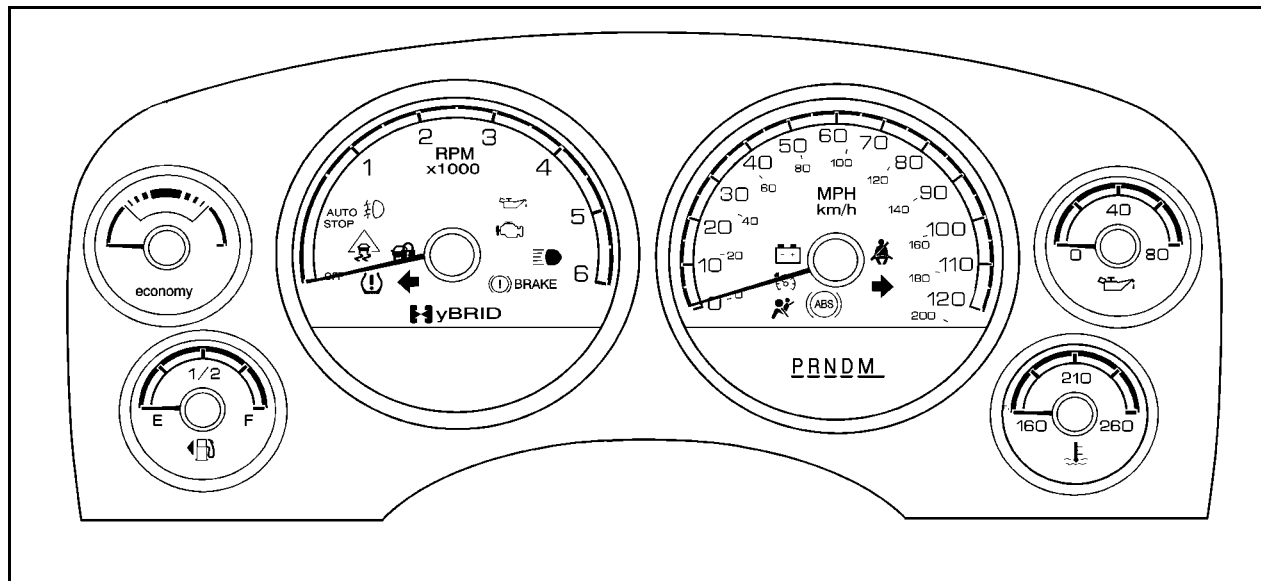

United States version shown, Canada similar

## Tachometer

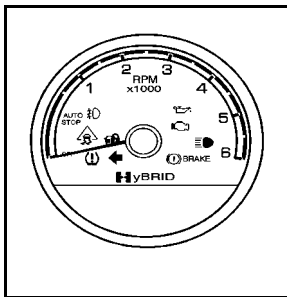

**United States Version  
shown, Canada similar**

When the gas engine is off and the key is in the ON/RUN position, the position of the tachometer indicator shows the state of the vehicle:

- AUTO STOP position indicates that the vehicle is still able to move and the engine could restart, by an Auto Start, at any time.
- OFF position indicates that the vehicle is off.

When the engine is on, the tachometer indicator shows the engine's revolutions per minute (rpm).

## Charging System Light

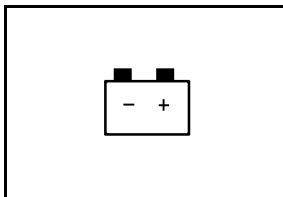

This 12 V battery light comes on briefly when the ignition is turned to ON/RUN, but the engine is not running, as a check to show it is working.

It should go out once the engine has been started. If it stays on, or comes on while driving, there could be a problem with the 12 V charging system. Have the vehicle serviced by your dealer/retailer. A 12 V charging system Driver Information Center (DIC) message may also appear. See *DIC Warnings and Messages on page 4-11* for more information. This light could indicate that there are electrical problems. Have it checked right away. If a short distance must be driven with the light on, be certain to turn off all the accessories.

## Fuel Economy Gage

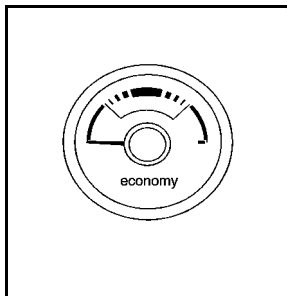

United States

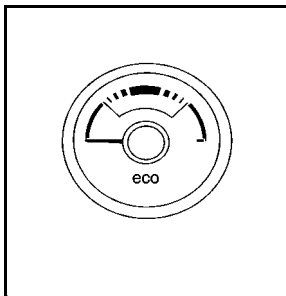

Canada

This gage shows displays how efficiently the vehicle is being driven.

There are three zones on the drive efficiency gage.

**Green Zone :** Fuel efficient driving behavior makes the indicator display in the green zone on the gage.

**White Zones :** Decreased fuel efficiency driving behavior makes the indicator display in the two white zones. The indicator in the white zone on the left side of the gage indicates decreased fuel efficiency with a large amount of decelerations. The indicator in the white zone on the right side of the gage indicates decreased fuel efficiency with a large amount of accelerations.

## Brake System Warning Light

With the ignition in ON/RUN, the brake system warning light comes on when the parking brake is set. If the vehicle is driven with the parking brake engaged, a chime sounds when the vehicle speed is greater than 5 mph (8 km/h).

The vehicle's hydraulic brake system is divided into two parts. If one part is not working, the other part can still work and stop the vehicle. For good braking, though, both parts need to be working well.

If the warning light comes on and a chime sounds there could be a brake problem. Have the brake system inspected right away.

This light also comes on due to low brake fluid. See the owner manual for more information.

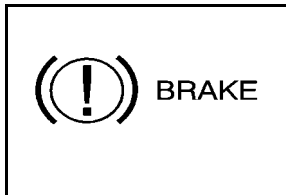

**United States**

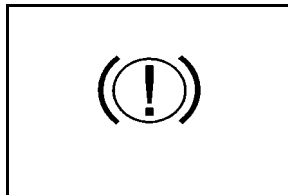

**Canada**

This light should come on briefly when the ignition key is turned to ON/RUN. If it does not come on then, have it fixed so it will be ready to warn if there is a problem.

**⚠ WARNING:**

The brake system might not be working properly if the brake system warning light is on. Driving with the brake system warning light on can lead to a crash. If the light is still on after the vehicle has been pulled off the road and carefully stopped, have the vehicle towed for service.

If the light comes on while driving, pull off the road and stop carefully. The pedal might be harder to push or can go closer to the floor. It may take longer to stop. If the light does not go out, have the vehicle towed for service. See *Towing Your Vehicle on page 5-2*.

## Antilock Brake System (ABS) Warning Light

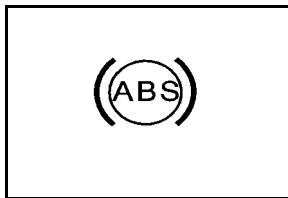

For vehicles with the Antilock Brake System (ABS), this light comes on briefly when the engine is in ON/RUN.

That is normal. If the light does not come on then, have it fixed so it will be ready to warn if there is a problem.

If the ABS light stays on, turn the ignition off, if the light comes on while driving, stop as soon as it is safely possible and turn the ignition off. Then start the engine again to reset the system. If the ABS light still stays on, or comes on again while driving, the vehicle needs service. If the regular brake system warning light is not on, the vehicle still has brakes, but not antilock brakes. If the regular brake system warning light is also on, the vehicle does not have antilock brakes and there is a problem with the regular brakes. See *Brake System Warning Light* on page 4-5.

For vehicles with a Driver Information Center (DIC), see *DIC Warnings and Messages* on page 4-11 for all brake related DIC messages.

## StabiliTrak<sup>®</sup> Indicator Light



For vehicles with StabiliTrak, this warning light comes on briefly when the ignition is in ON/RUN.

If it does not, have the vehicle serviced by your dealer/retailer. If the system is working normally the indicator light goes off.

If the light comes on and stays on while driving, there could be a problem with the StabiliTrak system and the vehicle might need service. When this warning light is on, the StabiliTrak system is off and does not limit wheel spin.

The light flashes if the system is active and is working to assist the driver with directional control of the vehicle in difficult driving conditions.

See the owner manual for more information.

## Engine Coolant Temperature Gage

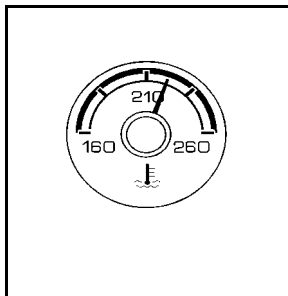

United States

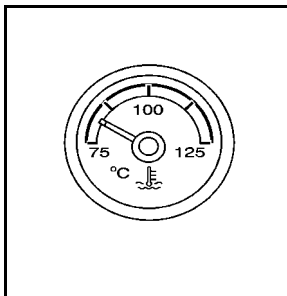

Canada

This gage shows the engine coolant temperature.

It also provides an indicator of how hard the vehicle is working. During a majority of the operation, the gage reads 210°F (100°C) or less. If a load is being pulled or going up hills, it is normal for the temperature to fluctuate and go over the 235°F (113°C) mark. However, if the gage reaches the 260°F (125°C) mark, it indicates that the cooling system is working beyond its capacity.

## Oil Pressure Gage

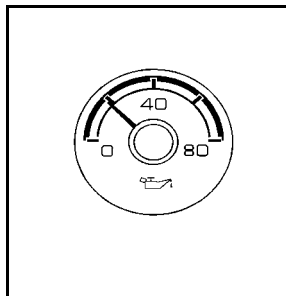

United States

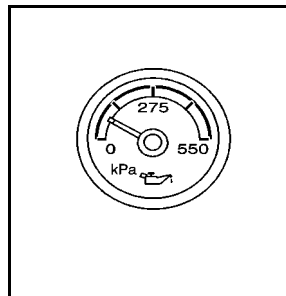

Canada

The oil pressure gage shows the engine oil pressure in psi (pounds per square inch) when the engine is running. Canadian vehicles indicate pressure in kPa (kilopascals).

Oil pressure should be 29 to 80 psi (200 to 550 kPa). In certain situations, such as long extended idles on hot days, it could read as low as 15 psi (105 kPa) and still be considered normal.

A reading in the low pressure zone may be caused by a dangerously low oil level or some other problem causing low oil pressure. Check the oil as soon as possible.



## **WARNING:**

Do not keep driving if the oil pressure is low. The engine can become so hot that it catches fire. Someone could be burned. Check the oil as soon as possible and have the vehicle serviced.

**Notice:** Lack of proper engine oil maintenance can damage the engine. The repairs would not be covered by the vehicle warranty. Always follow the maintenance schedule in this manual for changing engine oil.

## **AUTO STOP**

When the engine goes into Automatic Engine Stop, the oil pressure gage drops to zero when the tachometer is at the AUTO STOP position. This is normal and oil pressure returns to the normal operating range once the engine starts.

See *Starting the Vehicle on page 3-14* for more information.

AUTO STOP displays in the Driver Information Center (DIC) when the vehicle speed is zero. See *DIC Warnings and Messages on page 4-11* for more information.

## **Oil Pressure Light**

### **WARNING:**

Do not keep driving if the oil pressure is low. The engine can become so hot that it catches fire. Someone could be burned. Check the oil as soon as possible and have the vehicle serviced.

**Notice:** Lack of proper engine oil maintenance can damage the engine. The repairs would not be covered by the vehicle warranty. Always follow the maintenance schedule in this manual for changing engine oil.

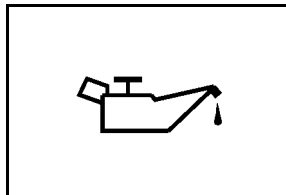

This light comes on briefly as a check it works, when the ignition is in ON/RUN. If it does not, have the vehicle serviced.

If the light comes on and stays on, it means that oil is not flowing through the engine properly. The vehicle could be low on oil and might have some other system problem.

During an AUTO STOP there is zero oil pressure, but this light will not come on.

## Fuel Gage

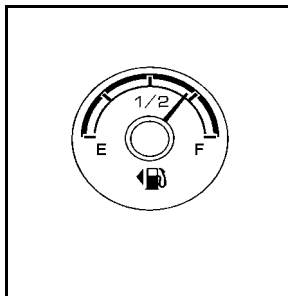

United States

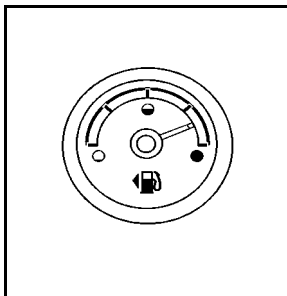

Canada

When the ignition is on, the fuel gage shows approximately how much fuel is left in the fuel tank. An arrow on the fuel gage indicates the side of the vehicle the fuel door is on. The gage first indicates E (empty) before the vehicle is out of fuel, but the vehicle should be refueled as soon as possible.

Listed are four situations that may occur with the fuel gage, none of these indicate a problem:

- At the gas station, the fuel pump shuts off before the gage reads F (full).
- It takes a little more or less fuel to fill up than the fuel gage indicated. For example, the gage may have indicated the tank was half full, but it actually took a little more or less than half the tank's capacity to fill the tank.
- The gage moves a little while turning a corner or while accelerating.
- The gage does not go back to E (empty) when the ignition is turned off.

## Driver Information Center (DIC)

### Trip/Fuel Menu Items

Press the trip/fuel button to display the Trip/Fuel Menu items. For more items see “DIC Operation and Displays” in the owner manual.

### BATTERY VOLTAGE

This display shows the current battery voltage. If the voltage is in the normal range, the value will display. For example, the display may read BATTERY VOLTAGE 13.2 VOLTS. If the voltage is high or low, the display will read HIGH or LOW. Your vehicle's charging system regulates voltage based on the state of the battery. The battery voltage may fluctuate when viewing this information on the DIC. This is normal. See “Charging System Light” in the owner manual for more information. If there is a problem with the battery charging system, the DIC will display a message. See *DIC Warnings and Messages on page 4-11*.

### INST ECON (Instantaneous Economy)

This display normally shows instantaneous fuel economy. When the vehicle is in Auto Stop mode AUTO STOP or INST ECON = 99 MPG (l/100km) will be displayed. See *Starting the Vehicle on page 3-14* for more information.

## DIC Warnings and Messages

Warning messages are displayed on the DIC to notify the driver that the status of the vehicle has changed and that some action may be needed by the driver to correct the condition. If there is more than one message that needs to be displayed they will appear one after another.

Some messages may not require immediate action, but you can press any of the DIC buttons on the instrument panel or the trip odometer reset stem to acknowledge that you received the messages and to clear them from the display.

Some messages cannot be cleared from the DIC display because they are more urgent. These messages require action before they can be cleared. You should take any messages that appear on the display seriously and remember that clearing the messages will only make the messages disappear, not correct the problem.

For information on other DIC messages, see “DIC Warnings and Messages” in the owner manual Index.

## **HOOD OPEN**

If the hood is not fully closed or there is a problem with the hood switch, this message will be displayed. Close the hood to clear the message. If the HOOD OPEN message continues to be displayed after verifying the hood is closed, you should have the hood switch serviced. Failure to service the hood switch properly can result in an Auto Start condition.

Auto Stops will be disabled when this message is displayed. If the vehicle is in auto stop mode when this message appears, the engine will instantly start.

## **OIL PRESSURE LOW STOP ENGINE**

If engine oil pressure is low, this message will be displayed on the DIC. Stop the vehicle as soon as safely possible and do not operate it until the cause of the low oil pressure has been corrected. Check your oil level as soon as possible and have your vehicle serviced. See “Engine Oil” in the owner manual Index.

## **SERVICE BATTERY CHARGING SYSTEM**

If the 12V battery system faults or fails this message will appear on the DIC. The battery/charging system light will appear in the instrument panel cluster. See “Battery

Warning Light” in the owner manual Index. Driving with this message on could drain the battery. Have the electrical system checked as soon as possible.

## **SERVICE BRAKE SYSTEM**

This message will be displayed if there is a problem with the brake system. You will still be able to brake, but it will be noticeably more difficult. Pull off the road to a safe location and have your vehicle towed to the nearest dealer/retailer for service. See “Brakes,” “Brake System Warning Light,” and “ABS Brake System Warning Light” in the owner manual Index.

## **SERVICE HYBRID SYSTEM**

If this message is displayed on the DIC, the vehicle may continue to operate, but you need to have it serviced as soon as possible.

## **SERVICE POWER STEERING**

This message displays if a problem has been detected with the electric power steering. Have your vehicle serviced by your dealer/retailer immediately.

## Audio System(s)

### Navigation/Radio System

For vehicles with a navigation radio system, see the Navigation System manual for more information.

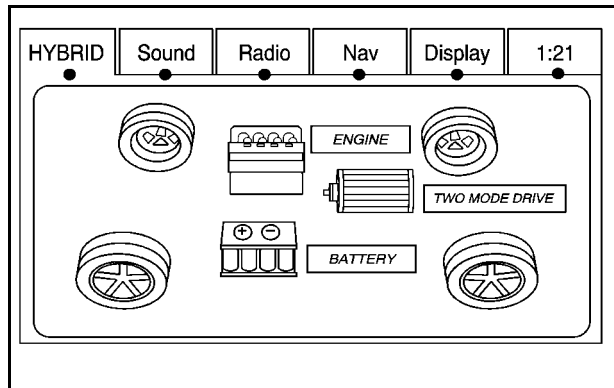

To view the hybrid screen, press the MENU button on the radio. The hybrid screen displays when entering the Configuration Menu.

The display shows:

- Auto Stop
- Battery Charging
- Engine Idle
- 2-Wheel and 4-Wheel Drive Modes for:
  - Engine Power
  - Battery Power
  - Hybrid Power

 **NOTES**

---

---

---

---

---

---

---

---

---

---

---

---

---

---

---

---

---

---

---

---

---

---

---

---

---

## Section 5 Driving Your Vehicle

---

<b>Your Driving, the Road, and the Vehicle</b> .....	5-2	<b>Towing</b> .....	5-2
Electric Power Steering .....	5-2	Towing Your Vehicle .....	5-2
		Towing a Trailer .....	5-2

# Your Driving, the Road, and the Vehicle

## Electric Power Steering

This vehicle has On-Demand Electric-Assist Power Steering instead of conventional full-time hydraulic power steering. It uses electricity supplied by the same battery which is re-charged by the regenerative braking system.

Because the system is On-Demand Electric-Assist, energy is used only when the steering wheel is turned, or when the steering gear is used to help isolate the forces of rough roads. This system does not use power steering fluid, making it maintenance-free.

## Towing

### Towing Your Vehicle

Consult your dealer/retailer or a professional towing service if the disabled vehicle needs to be towed.

## Towing a Trailer

For more information, see “Towing a Trailer” in the owner manual Index.

### Weight of the Trailer

How heavy can a trailer safely be?

It depends on how the rig is used. For example, speed, altitude, road grades, outside temperature and how much the vehicle is used to pull a trailer are all important. It can depend on any special equipment on the vehicle, and the amount of tongue weight the vehicle can carry.

Maximum trailer weight is calculated assuming only the driver is in the tow vehicle and it has all the required trailering equipment. The weight of additional optional equipment, passengers and cargo in the tow vehicle must be subtracted from the maximum trailer weight.

Use the following charts to determine how much the vehicle can weigh, based upon the vehicle model and options.



<b>Vehicle</b>	<b>Axle Ratio</b>	<b>Maximum Trailer Weight</b>	<b>GCWR*</b>
2WD 6.0 L V8	3.08	6,100 lbs (2 767 kg)	12,000 lbs (5 443 kg)
4WD 6.0 L V8	3.08	5,900 lbs (2 676 kg)	12,000 lbs (5 443 kg)

\*The Gross Combination Weight Rating (GCWR) is the total allowable weight of the completely loaded vehicle and trailer including any passengers, cargo, equipment and conversions. The GCWR for the vehicle should not be exceeded.

## Trailer Brakes

If a trailer is being towed that has trailer brakes and the trailer brakes are manually applied while driving slower than 25 mph (40 km/h), the vehicle may go into auto stop mode even if the brakes are not being pressed. Using the trailer brake system manually can make the hybrid vehicle perform as if the brake pedal in the vehicle is being pressed. The trailer brake operation

check will still work. If the trailer brakes are manually applied for an extended period of time, the SERVICE BRAKE SYSTEM DIC message comes on. The message goes off after the trailer brakes have been released. No other action is necessary. For more information, see “Trailer Brakes” in the Index of the vehicle's owner manual.

 **NOTES**

---

---

---

---

---

---

---

---

---

---

---

---

---

---

---

---

---

---

---

---

---

---

---

---

## Section 6 Service and Appearance Care

---

<b>Service</b> .....	6-2	<b>Brakes</b> .....	6-13
Doing Your Own Service Work .....	6-2	<b>Battery</b> .....	6-17
<b>Checking Things Under the Hood</b> .....	6-3	<b>Jump Starting</b> .....	6-18
High Voltage Devices and Wiring .....	6-3	<b>Electrical System</b> .....	6-23
Engine Compartment Overview .....	6-4	High Voltage Devices and Wiring .....	6-23
Automatic Transmission Fluid .....	6-5	Fuses and Circuit Breakers .....	6-24
Drive Motor/Generator Control Module (DMCM)		Underhood Fuse Block .....	6-24
Coolant Surge Tank Pressure Cap .....	6-8	<b>Appearance Care</b> .....	6-25
Drive Motor/Generator Control Module (DMCM)		Vehicle Care/Appearance Materials .....	6-25
Cooling System .....	6-9	<b>Capacities and Specifications</b> .....	6-26
Power Steering Fluid .....	6-13		

# Service

## Doing Your Own Service Work

### **WARNING:**

Never try to do your own service on hybrid components. You can be injured and the vehicle can be damaged if you try to do your own service work. Service and repair of these hybrid components should only be performed by a trained service technician with the proper knowledge and tools.

### **WARNING:**

You can be injured and the vehicle could be damaged if you try to do service work on a vehicle without knowing enough about it.

- Be sure you have sufficient knowledge, experience, the proper replacement parts, and tools before attempting any vehicle maintenance task.
- Be sure to use the proper nuts, bolts, and other fasteners. English and metric fasteners can be easily confused. If the wrong fasteners are used, parts can later break or fall off. You could be hurt.

If doing some of your own service work, use the proper service manual. It tells you much more about how to service the vehicle than this manual can. To order the proper service manual, see “Service Publications Ordering Information” in the owner manual.

This vehicle has an airbag system. Before attempting to do your own service work, see “Servicing Your Airbag-Equipped Vehicle” in the owner manual.

Keep a record with all parts receipts and list the mileage and the date of any service work performed. See “Maintenance Record” in the owner manual.

## Checking Things Under the Hood

### High Voltage Devices and Wiring

#### **WARNING:**

Exposure to high voltage can cause shock, burns, and even death. The high voltage systems in your vehicle can only be serviced by technicians with special training.

High voltage devices are identified by labels. Do not remove, open, take apart, or modify these devices. High voltage cable or wiring has orange covering. Do not probe, tamper with, cut, or modify high voltage cable or wiring.

## Engine Compartment Overview

When you open the hood on your vehicle, you will see:

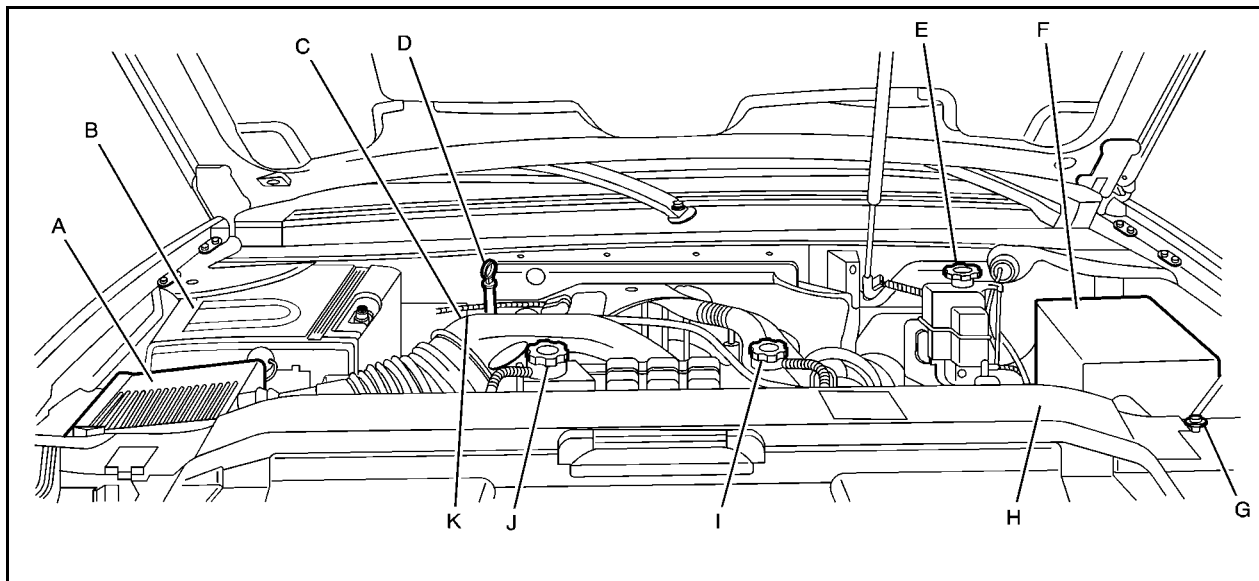

- A. See “Engine Air Cleaner/Filter” in the owner manual.
- B. Drive Motor/Generator Control Module (DMCM). See *Drive Motor/Generator Control Module (DMCM) Cooling System on page 6-9*.
- C. Engine Oil Dipstick. See “Engine Oil” in the owner manual.
- D. Automatic Transmission Fluid Dipstick. See *Automatic Transmission Fluid on page 6-5*.
- E. Brake Fluid Reservoir. See *Brakes on page 6-13*.
- F. See “Underhood Fuse Block” in the owner manual.
- G. See “Windshield Washer Fluid” in the owner manual.
- H. Hybrid Auxiliary Fuse Block. See *Underhood Fuse Block on page 6-24*.
- I. DMCM Coolant Surge Tank Pressure Cap. See *Drive Motor/Generator Control Module (DMCM) Coolant Surge Tank Pressure Cap on page 6-8*.
- J. See “Coolant Surge Tank Pressure Cap” in the owner manual.
- K. Engine Oil Fill Cap. See “Engine Oil” in the owner manual.

## Automatic Transmission Fluid

### When to Check and Change Automatic Transmission Fluid

It is usually not necessary to check the transmission fluid level. The only reason for fluid loss is a transmission leak or overheating the transmission. If you suspect a small leak, then use the following checking procedures to check the fluid level. However, if there is a large leak, then it may be necessary to have the vehicle towed to a dealer/retailer service department and have it repaired before driving the vehicle further.

**Notice: Use of the incorrect automatic transmission fluid may damage the vehicle, and the damages may not be covered by the vehicle's warranty. Always use the automatic transmission fluid listed in *Recommended Fluids and Lubricants on page 7-2*.**

Change the fluid and filter at the intervals listed in the Maintenance Schedule. See Scheduled Maintenance in the owner manual. Be sure to use the transmission fluid listed in *Recommended Fluids and Lubricants on page 7-2*.

## How to Check Automatic Transmission Fluid

**Notice:** Too much or too little fluid can damage your transmission. Too much can mean that some of the fluid could come out and fall on hot engine parts or exhaust system parts, starting a fire. Too little fluid could cause the transmission to overheat. Be sure to get an accurate reading if you check your transmission fluid.

Before checking the fluid level, prepare the vehicle as follows:

1. Start the engine and park the vehicle on a level surface. Keep the engine running.
2. Apply the parking brake and place the shift lever in P (Park).
3. With your foot on the brake pedal, move the shift lever through each gear range, pausing for about three seconds in each range. Then, move the shift lever back to P (Park).
4. Allow the engine to idle (500 – 800 RPM) for at least one minute. Slowly release the brake pedal.
5. Keep the engine running and press the Trip/Fuel button or trip odometer reset stem until TRANS TEMP (Transmission Temperature) displays on the Driver Information Center (DIC).

6. Using the TRANS TEMP reading, determine and perform the appropriate check procedure. If the TRANS TEMP reading is not within the required temperature ranges, allow the vehicle to cool, or operate the vehicle until the appropriate transmission fluid temperature is reached.

### Cold Check Procedure

Use this procedure only as a reference to determine if the transmission has enough fluid to be operated safely until a hot check procedure can be made. The hot check procedure is the most accurate method to check the fluid level. Perform the hot check procedure at the first opportunity. Use this cold check procedure to check fluid level when the transmission temperature is between 24°C and 34°C (75°F and 93°F).

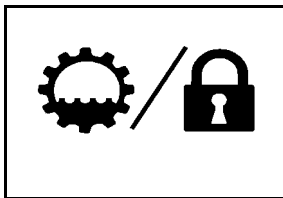

1. Locate the transmission dipstick at the rear of the engine compartment, on the passenger side of the vehicle.

See *Engine Compartment Overview* on page 6-4 for more information.

2. Pull out the dipstick and wipe it with a clean rag or paper towel.



3. Install the dipstick by pushing it back in all the way, wait three seconds, and then pull it back out again.
4. Check both sides of the dipstick and read the lower level. Repeat the check procedure to verify the reading.

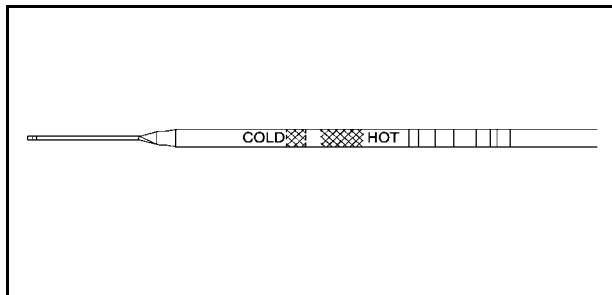

5. If the fluid level is below the COLD check band, add only enough fluid as necessary to bring the level into the COLD band. It does not take much fluid, generally less than 0.5 Liter (1 Pint). Do not overfill.
6. Perform a hot check at the first opportunity after the transmission reaches a normal operating temperature between 60°C and 75°C (140°F and 167°F).
7. If the fluid level is in the acceptable range, push the dipstick back in all the way.

## Hot Check Procedure

Use this procedure to check the transmission fluid level when the transmission fluid temperature is between 60°C and 75°C (140°F and 167°F).

The hot check is the most accurate method to check the fluid level. The hot check should be performed at the first opportunity in order to verify the cold check. The fluid level rises as fluid temperature increases, so it is important to ensure the transmission temperature is within range.

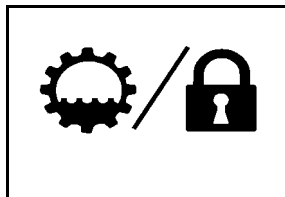

1. Locate the transmission dipstick at the rear of the engine compartment, on the passenger side of the vehicle.

See *Engine Compartment Overview* on page 6-4 for more information.

2. Pull out the dipstick and wipe it with a clean rag or paper towel.
3. Install the dipstick by pushing it back in all the way, wait three seconds, and then pull it back out again.
4. Check both sides of the dipstick and read the lower level. Repeat the check procedure to verify the reading.

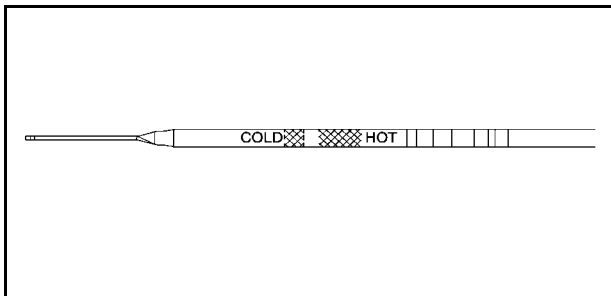

## Consistency of Readings

Always check the fluid level at least twice using the procedure described previously. Consistency (repeatable readings) is important to maintaining proper fluid level. If readings are still inconsistent, contact your dealer/retailer.

## Drive Motor/Generator Control Module (DMCM) Coolant Surge Tank Pressure Cap

5. Safe operating level is within the HOT cross hatch band on the dipstick. If the fluid level is not within the HOT band, and the transmission temperature is between 60°C and 75°C (140°F and 167°F), add or drain fluid as necessary to bring the level into the HOT band. If the fluid level is low, add only enough fluid to bring the level into the HOT band. It does not take much fluid, generally less than 0.5 Liter (1 Pint). Do not overfill.
6. If the fluid level is in the acceptable range, push the dipstick back in all the way.

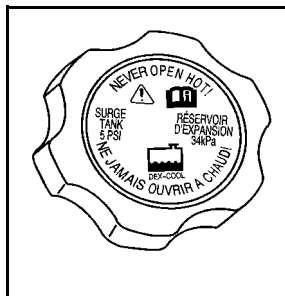

See *Engine Compartment Overview on page 6-4* for more information on location.

The Drive Motor/Generator Control Module (DMCM) coolant surge tank pressure cap must be fully installed on the hybrid coolant surge tank.

**Notice:** If the pressure cap is not tightly installed, coolant loss and possible damage to the Drive Motor/Generator Control Module (DMCM) may occur. Be sure the cap is properly and tightly secured.

## Drive Motor/Generator Control Module (DMCM) Cooling System

In addition to the regular cooling system, the vehicle also has a cooling system for the DMCM system. This system is serviced differently than the vehicle's main cooling system. The DMCM cooling system includes the DMCM coolant surge tank, DMCM surge tank pressure cap, DMCM cooling pumps, hybrid cooling radiator and the Drive Motor/Generator Control Module (DMCM). The DMCM cooling system uses a 50/50 pre-mixed DEX-COOL™ coolant and deionized water available at your dealer/retailer. See “Engine Coolant” and “Cooling System” in the owner manual for more information.

When you decide it is safe to lift the hood, here is what you will see:

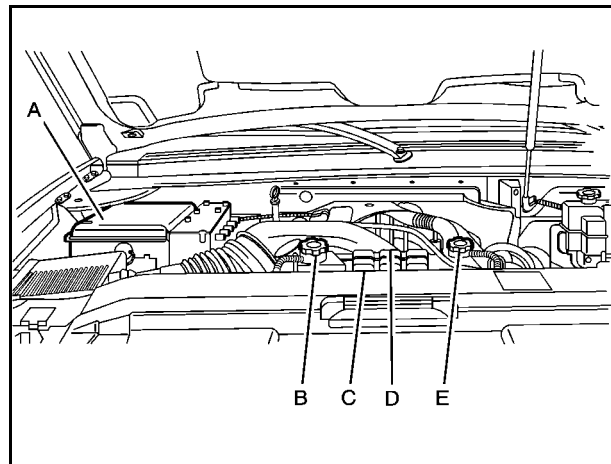

- A. Drive Motor/Generator Control Module (DMCM)
- B. Engine Coolant Surge Tank Pressure Cap
- C. DMCM Coolant Surge Tank/Engine Coolant Surge Tank
- D. DMCM Cooling Hoses (Out of View)
- E. DMCM Coolant Surge Tank Pressure Cap

If the coolant inside the DMCM coolant surge tank is boiling, do not do anything else until it cools down.

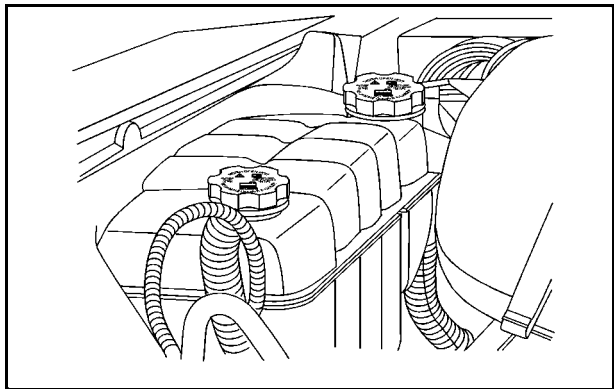

The coolant level should be at or above the FULL COLD mark with the vehicle parked on a level surface. If it is not, there might be a leak at the DMCM cooler core, DMCM pressure cap, DMCM cooler hoses, DMCM cooling pump or somewhere else in the DMCM cooling system.

**Notice:** Running the engine when there is a leak in the hybrid cooling system can cause the hybrid cooling system to lose all coolant and can damage the system. Get any leak fixed before you drive the vehicle or run the engine.

## How to Add Coolant to the DMCM Coolant Surge Tank

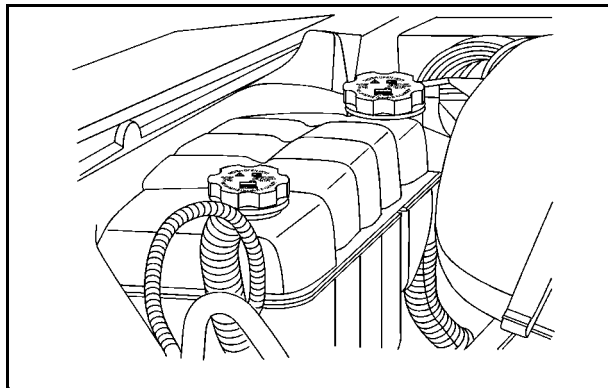

If no problem has been found yet, check to see if coolant is visible in the DMCM coolant surge tank. If coolant is visible, add pre-mixed DEX-COOL™ coolant, available at your dealer/retailer, at the DMCM coolant surge tank, but be sure the DMCM cooling system, including the DMCM coolant surge tank pressure cap, is cool before you do it. Use the procedure following.

**⚠ WARNING:**

Steam and scalding liquids from a hot cooling system can blow out and burn you badly. They are under pressure, and if you turn the coolant surge tank pressure cap — even a little — they can come out at high speed. Never turn the cap when the cooling system, including the coolant surge tank pressure cap, is hot. Wait for the cooling system and coolant surge tank pressure cap to cool if you ever have to turn the pressure cap.

**Notice:** Using coolant other than a pre-mixed DEX-COOL, available at your dealer/retailer, may damage your vehicle. Any repairs would not be covered by your warranty. Always use a pre-mixed DEX-COOL (silicate-free) coolant in your vehicle.

**⚠ WARNING:**

You can be burned if you spill coolant on hot engine parts. Coolant contains ethylene glycol and it will burn if the engine parts are hot enough. Do not spill coolant on a hot engine.

If the DMCM coolant is empty, the vehicle must be serviced by your dealer and a special fill procedure must be followed.

**Notice:** Attempting to fill the DMCM cooling surge tank yourself when the fluid level is empty can damage your vehicle. Your vehicle must be serviced.

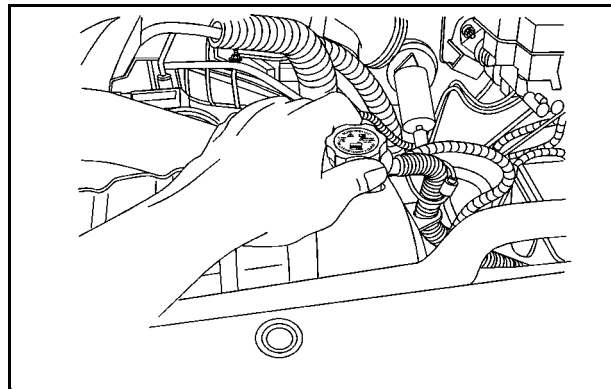

1. Park the vehicle on a level surface and turn the vehicle off. Remove the DMCM coolant surge tank pressure cap when the DMCM cooling system, including the DMCM coolant surge tank pressure cap and DMCM cooling hoses, are no longer hot.

Turn the DMCM coolant surge tank pressure cap slowly counterclockwise (left) about one full turn. Wait 30 seconds.

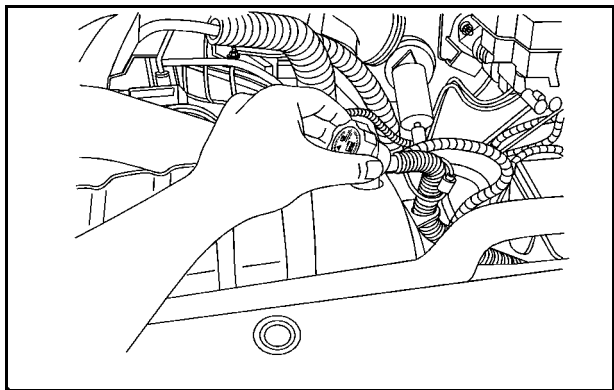

2. Then keep turning the DMCM coolant surge tank pressure cap slowly, and remove it.
3. Add the pre-mixed DEX-COOL™, available at your dealer/retailer, to the DMCM coolant surge tank until the level reaches the FULL COLD mark.
4. Turn the ignition to ON/RUN without starting the engine. The hybrid cooling pumps will run and any trapped air will purge to the surge tank.

5. Add the pre-mixed DEX-COOL™, available at your dealer/retailer, until the coolant level is maintained at the FULL COLD mark. This should take no longer than two minutes of hybrid cooling pump operation.

If the level cannot be kept at the FULL COLD level, your vehicle may need service. See your dealer/retailer.

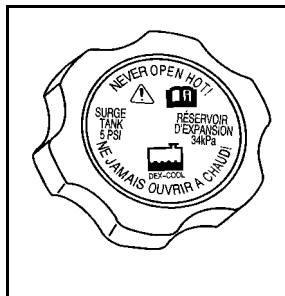

6. Then replace the DMCM coolant surge tank pressure cap. Be sure the pressure cap is hand-tight and fully seated.

**Notice:** Using tap water, cooling system sealers or conditioners in an attempt to stop coolant leaks can damage the DMCM and engine cooling systems. Never use tap water, cooling system sealers or conditioners in your cooling system.

## Power Steering Fluid

The vehicle has electric power steering and does not use power steering fluid.

## Brakes

### Brake Fluid

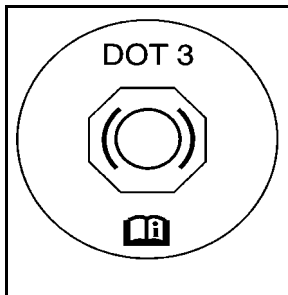

The brake master cylinder reservoir is filled with DOT 3 brake fluid. See *Engine Compartment Overview on page 6-4* for the location of the reservoir.

There are only two reasons why the brake fluid level in the reservoir might go down:

- The brake fluid level goes down because of normal brake lining wear. When new linings are installed, the fluid level goes back up.
- A fluid leak in the brake hydraulic system can also cause a low fluid level. Have the brake hydraulic system fixed, since a leak means that sooner or later the brakes will not work well.

Do not top off the brake fluid. Adding fluid does not correct a leak. If fluid is added when the linings are worn, there will be too much fluid when new brake linings are installed. Add or remove brake fluid, as necessary, only when work is done on the brake hydraulic system.

**⚠ WARNING:**

If too much brake fluid is added, it can spill on the engine and burn, if the engine is hot enough. You or others could be burned, and the vehicle could be damaged. Add brake fluid only when work is done on the brake hydraulic system. See “Checking Brake Fluid” in this section.

When the brake fluid falls to a low level, the brake warning light comes on. See “Brake System Warning Light” in the owner manual.

Refer to the Maintenance Schedule to determine when to check the brake fluid. See “Scheduled Maintenance” in the owner manual.

## Checking Brake Fluid

Check brake fluid by looking at the brake fluid reservoir. See *Engine Compartment Overview* on page 6-4.

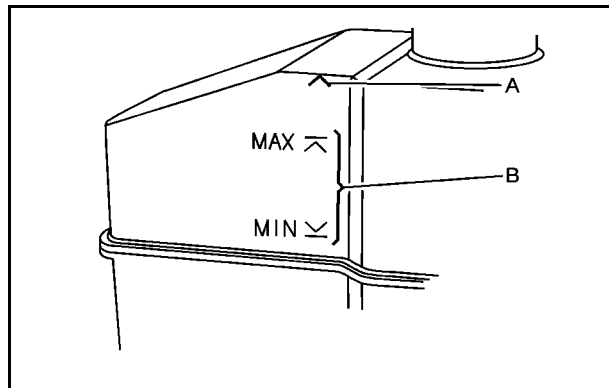

With the engine not running for at least one minute, the maximum fluid level (A) is at the top of the reservoir body. With the engine running, the fluid level should be in the proper operating range (B) between the MIN and MAX marks. If it is not, have the brake hydraulic system checked to see if there is a leak.

After work is done on the brake hydraulic system, make sure the level, with the engine running, is in the proper operating range (B) between the MIN and MAX marks.



## What to Add

Use only new DOT 3 brake fluid from a sealed container. See “Recommended Fluids and Lubricants” in the owner manual.

Always clean the brake fluid reservoir cap and the area around the cap before removing it. This helps keep dirt from entering the reservoir.

### **WARNING:**

With the wrong kind of fluid in the brake hydraulic system, the brakes might not work well. This could cause a crash. Always use the proper brake fluid.

## Notice:

- **Using the wrong fluid can badly damage brake hydraulic system parts. For example, just a few drops of mineral-based oil, such as engine oil, in the brake hydraulic system can damage brake hydraulic system parts so badly that they will have to be replaced. Do not let someone put in the wrong kind of fluid.**
- **If brake fluid is spilled on the vehicle's painted surfaces, the paint finish can be damaged. Be careful not to spill brake fluid on the vehicle. If you do, wash it off immediately. See “Washing Your Vehicle” in the owner manual.**

## Brake Wear

This vehicle has disc brakes. Disc brake pads have built-in wear indicators that make a high-pitched warning sound when the brake pads are worn and new pads are needed. The sound can come and go or be heard all the time the vehicle is moving, except when applying the brake pedal firmly.

### **WARNING:**

The brake wear warning sound means that soon the brakes will not work well. That could lead to an accident. When the brake wear warning sound is heard, have the vehicle serviced.

### **Notice: Continuing to drive with worn-out brake pads could result in costly brake repair.**

Some driving conditions or climates can cause a brake squeal when the brakes are first applied or lightly applied. This does not mean something is wrong with the brakes.

Properly torqued wheel nuts are necessary to help prevent brake pulsation. When tires are rotated, inspect brake pads for wear and evenly tighten wheel nuts in the proper sequence to torque specifications in “Capacities and Specifications” in the owner manual.

Brake linings should always be replaced as complete axle sets.

## Brake Pedal Travel

See your dealer/retailer if the brake pedal does not return to normal height, or if there is a rapid increase in pedal travel. This could be a sign that brake service might be required.

## Brake Adjustment

Every time the brakes are applied, the disc brakes adjust for wear.

## Replacing Brake System Parts

The braking system on a vehicle is complex. Its many parts have to be of top quality and work well together if the vehicle is to have really good braking. The vehicle was designed and tested with top-quality brake parts. When parts of the braking system are replaced — for example, when the brake linings wear down and new ones are installed — be sure to get new approved replacement parts. If this is not done, the brakes might not work properly. For example, if someone puts in brake linings that are wrong for the vehicle, the balance between the front and rear brakes can change — for the worse. The braking performance expected can change in many other ways if the wrong replacement brake parts are installed.

## Battery

This vehicle has a standard 12-volt battery and a high-voltage hybrid battery.

Refer to the replacement number on the original battery label when a new standard 12-volt battery is needed.

Only a trained service technician with the proper knowledge and tools should inspect, test, or replace the hybrid battery. See your dealer/retailer if the hybrid battery needs service. The dealer/retailer has information on how to recycle the hybrid battery. There is also information available at <http://www.recyclemybattery.com>.

If an airbag inflates or the vehicle has been in a crash, the vehicle's sensing system might command the automatic hybrid battery disconnect to open. See *Replacing Restraint System Parts After a Crash* on page 2-2 for more information .

### **DANGER:**

Battery posts, terminals, and related accessories contain lead and lead compounds, chemicals known to the State of California to cause cancer and reproductive harm. Wash hands after handling.

## Vehicle Storage

### **WARNING:**

Batteries have acid that can burn you and gas that can explode. You can be badly hurt if you are not careful. See *Jump Starting on page 6-18* for tips on working around a battery without getting hurt.

**Infrequent Usage:** Remove the 12-volt battery black, negative (-) cable from the battery to keep the battery from running down.

**Extended Storage:** Remove the 12-volt battery black, negative (-) cable from the battery or use a battery trickle charger.

Remember to reconnect the battery when ready to drive the vehicle.

## Jump Starting

### **WARNING:**

Personal injury, death, or damage to the vehicle can result if you try jump starting or using a battery charger on the high voltage hybrid battery. Use only the 12-volt battery for jump starting and charging.

If the vehicle's 12-volt battery has run down, you may want to use another vehicle and some jumper cables to start your vehicle. Use the following steps to do it safely.

### **WARNING:**

Batteries can hurt you. They can be dangerous because:

- They contain acid that can burn you.
- They contain gas that can explode or ignite.
- They contain enough electricity to burn you.

If you do not follow these steps exactly, some or all of these things can hurt you.

**Notice:** Ignoring these steps could result in costly damage to the vehicle that would not be covered by the warranty.

**Trying to start the vehicle by pushing or pulling it will not work, and it could damage the vehicle.**

1. Check the other vehicle. It must have a 12-volt battery with a negative ground system.

**Notice:** If the other vehicle's system is not a 12-volt system with a negative ground, both vehicles can be damaged. Only use vehicles with 12-volt systems with negative grounds to jump start your vehicle.

2. Get the vehicles close enough so the jumper cables can reach, but be sure the vehicles are not touching each other. It could cause a ground connection you do not want. You would not be able to start your vehicle, and the bad grounding could damage the electrical systems.

To avoid the possibility of the vehicles rolling, set the parking brake firmly on both vehicles involved in the jump start procedure. Put the automatic transmission in P (Park) or a manual transmission

in N (Neutral) before setting the parking brake. If you have a four-wheel-drive vehicle, be sure the transfer case is in a drive gear, not in N (Neutral).

**Notice:** If you leave the radio or other accessories on during the jump starting procedure, they could be damaged. The repairs would not be covered by the warranty. Always turn off the radio and other accessories when jump starting the vehicle.

3. Turn off the ignition on both vehicles. Unplug unnecessary accessories plugged into the cigarette lighter or the accessory power outlets. Turn off the radio and all the lamps that are not needed.

This avoids sparks and helps save both batteries. It could save the radio!

4. Open the hood on the other vehicle and locate the positive (+) and negative (-) terminal locations on that vehicle.

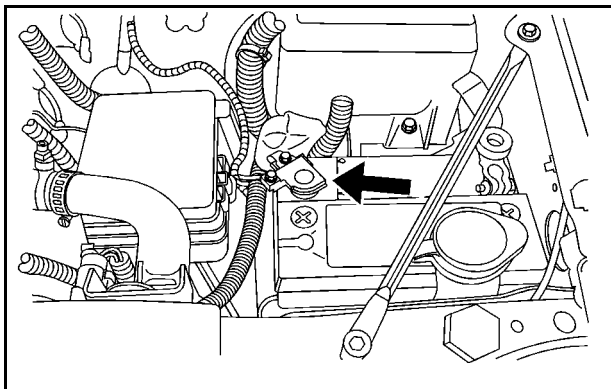

The positive (+) connection is located under a red plastic cover at the positive battery post. To uncover the remote positive (+) terminal, open the red plastic cover.

5. The remote negative (-) is a solid engine ground.

**⚠ WARNING:**

An electric fan can start up even when the engine is not running and can injure you. Keep hands, clothing and tools away from any underhood electric fan.

**⚠ WARNING:**

Using an open flame near a battery can cause battery gas to explode. People have been hurt doing this, and some have been blinded. Use a flashlight if you need more light.

Be sure the battery has enough water. You do not need to add water to the battery installed in your new vehicle. But if a battery has filler caps, be sure the right amount of fluid is there. If it is low, add water to take care of that first. If you do not, explosive gas could be present.

Battery fluid contains acid that can burn you. Do not get it on you. If you accidentally get it in your eyes or on your skin, flush the place with water and get medical help immediately.

 **WARNING:**

Fans or other moving engine parts can injure you badly. Keep your hands away from moving parts once the engine is running.

6. Check that the jumper cables do not have loose or missing insulation. If they do, you could get a shock. The vehicles could be damaged too.

Before you connect the cables, here are some basic things you should know. Positive (+) goes to positive (+) or to a remote positive (+) terminal if the vehicle has one. Negative (-) will go to a heavy, unpainted metal engine part or a solid engine ground.

Do not connect positive (+) to negative (-) or you will get a short that would damage the battery and maybe other parts too. Do not connect the negative (-) cable to the negative (-) terminal on the dead battery because this can cause sparks.

7. Connect the red positive (+) cable to the positive (+) terminal of the vehicle with the dead battery. Use a remote positive (+) if the vehicle has one.
8. Do not let the other end touch metal. Connect it to the positive (+) terminal of the good battery. Use a remote positive (+) if the vehicle has one.
9. Now connect the black negative (-) cable to the negative (-) terminal of the good battery. Use a remote negative (-) if the vehicle has one.  
Do not let the other end touch anything until the next step. The other end of the negative (-) cable does not go to the dead battery. It goes to a heavy, unpainted metal engine part or to the remote negative (-) terminal on the vehicle with the dead battery.

10. Connect the other end of the negative (-) cable to the remote negative (-) terminal, on the vehicle with the dead battery.
11. Now start the vehicle with the good battery and run the engine for a while.
12. Try to start the vehicle that had the dead battery. If it will not start after a few tries, it probably needs service.

**Notice:** If the jumper cables are connected or removed in the wrong order, electrical shorting may occur and damage the vehicle. The repairs would not be covered by the vehicle warranty. Always connect and remove the jumper cables in the correct order, making sure that the cables do not touch each other or other metal.

## Jumper Cable Removal

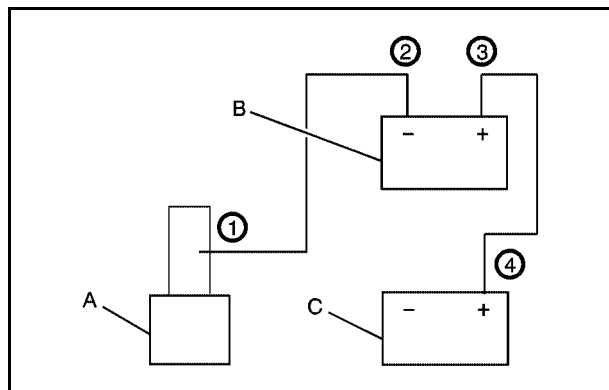

- A. Heavy, Unpainted Metal Engine Part or Remote Negative (-) Terminal
- B. Good Battery or Remote Positive (+) and Remote Negative (-) Terminals
- C. Dead Battery or Remote Positive (+) Terminal



To disconnect the jumper cables from both vehicles:

1. Disconnect the black negative (-) cable from the vehicle that had the bad battery.
2. Disconnect the black negative (-) cable from the vehicle with the good battery.
3. Disconnect the red positive (+) cable from the vehicle with the good battery.
4. Disconnect the red positive (+) cable from the other vehicle.
5. Return the remote positive (+) terminal cover to its original position.

## Electrical System

### High Voltage Devices and Wiring

#### **WARNING:**

Exposure to high voltage can cause shock, burns, and even death. The high voltage systems in your vehicle can only be serviced by technicians with special training.

High voltage devices are identified by labels. Do not remove, open, take apart, or modify these devices. High voltage cable or wiring has orange covering. Do not probe, tamper with, cut, or modify high voltage cable or wiring.

## Fuses and Circuit Breakers

The wiring circuits in the vehicle are protected from short circuits by a combination of fuses, circuit breakers and fusible thermal links. This greatly reduces the chance of fires caused by electrical problems.

Be sure you replace a bad fuse with a new one of the identical size and rating.

If you ever have a problem on the road and do not have a spare fuse, you can borrow one that has the same amperage. Just pick some feature of the vehicle that you can get along without, like the radio or cigarette lighter, and use its fuse, if it is the correct amperage. Replace it as soon as you can.

The vehicle also has a special fuse in the battery box for the 300-volt batteries. If this fuse has failed and needs to be replaced, the vehicle will be disabled and you will need to have the vehicle repaired by your dealer/retailer. Do not attempt to self-service this fuse.

## Underhood Fuse Block

### Hybrid Auxiliary Underhood Fuse Block

The hybrid underhood fuse block is located in the engine compartment near the front of the vehicle. Lift the cover for access to the fuse/relay block. See *Engine Compartment Overview on page 6-4* for more

information on its location. For more information on the main underhood fuse block, see “Underhood Fuse Block” in the owner manual.

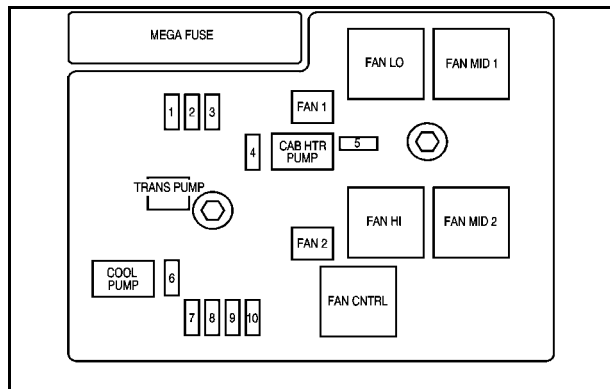

Fuses	Usage
1	ACPO (SUV Only)
2	BECM FAN
3	ACCM
4	CAB HTR PMP
5	EMPTY
6	COOL PUMP
7	EPS

<b>Fuses</b>	<b>Usage</b>
8	Drive Motor/Generator Control Module 1
9	Drive Motor/Generator Control Module 2
10	BECM

<b>J-Case</b>	<b>Usage</b>
FAN 1	Cooling Fan 1
TRANS PUMP	Auxiliary Transmission Fluid Pump
FAN 2	Cooling Fan 2
CAB HTR PMP	Cab Heater Pump

<b>Relays</b>	<b>Usage</b>
FAN LOW	Cooling Fan Low Speed Relay
FAN MID 1	Cooling Fan Mid 1
FAN HI	Cooling Fan High Speed Relay
FAN MID 2	Cooling Fan Mid 2
FAN CNTRL	Cooling Fan Control

## Appearance Care

### Vehicle Care/Appearance Materials

When scraping the windshield glass to remove ice and snow, stay clear of the hybrid decal.

To have the hybrid decals removed from the vehicle, please see your dealer/retailer.

## Capacities and Specifications

Application	Capacities	
	English	Metric
Automatic Transmission* (Pan Removal and Filter Replacement)	11.5 qt	10.9 L
Cooling System		
Drive Motor Generator Control Module Cooling System	2.9 qt	2.7 L
6.0L V8 Engine Cooling System	17.2 qt	16.3 L
Fuel Tank	26.0 gal	98.4 L
*See <i>Automatic Transmission Fluid on page 6-5</i> for information on checking fluid level.		
All capacities are approximate. Recheck fluid level after filling.		

### Engine Specifications

Engine	VIN Code	Transmission	Spark Plug Gap
6.0L V8	J	Automatic	0.040 in (1.02 mm)

## Section 7 Maintenance Schedule

---

<b>Maintenance Schedule</b> .....	7-2
Recommended Fluids and Lubricants .....	7-2
Engine Drive Belt Routing .....	7-2

## Maintenance Schedule

### Recommended Fluids and Lubricants

Fluids identified below are specific to the hybrid vehicle and can be obtained from your dealer/retailer. See the owner manual for the other fluids and lubricants recommended for the vehicle.

Usage	Fluid/Lubricant
Drive Motor/ Generator Control Module (DMCM) Cooling System	Always use the pre-mixed 50/50 mixture of de-ionized water and DEX-COOL <sup>®</sup> (silicate-free) coolant available at your dealer/retailer. See <i>Drive Motor/Generator Control Module (DMCM) Cooling System on page 6-9.</i>

### Engine Drive Belt Routing

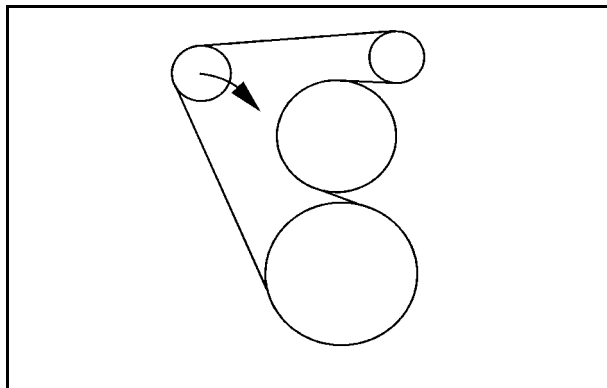

## A

Antilock Brake System (ABS)	
Warning Light .....	4-7
Audio System(s)	
Navigation/Radio System .....	4-13
Automatic Transmission, Fluid .....	6-5

## B

Battery .....	6-17
Belt Routing, Engine .....	7-2
Brakes .....	6-13
Regenerative Braking .....	3-21
System Warning Light .....	4-5

## C

Canadian Owners .....	ii
Capacities and Specifications .....	6-26
Charging System Light .....	4-4
Climate Controls .....	4-2
Coolant	
Engine Temperature Gage .....	4-8
Coolant Surge Tank Pressure Cap, (DMCM) .....	6-8
Cooling System, (DMCM) .....	6-9
Covers	
Tonneau .....	3-2, 3-7

## D

Drive Motor/Generator Control Module (DMCM)	
Coolant Surge Tank Pressure Cap .....	6-8
Drive Motor/Generator Control Module (DMCM)	
Cooling System .....	6-9
Driver Information Center (DIC) .....	4-11
Warnings and Messages .....	4-11

## E

Engine	
Compartment Overview .....	6-4
Coolant Temperature Gage .....	4-8
Drive Belt Routing .....	7-2
Engine Coolant Heater .....	3-19

## F

Fluid	
Power Steering .....	6-13
Fuel	
Gage .....	4-10
Fuel Economy Gage .....	4-5

## G

Gages	
Engine Coolant Temperature .....	4-8
Fuel .....	4-10
Fuel Economy .....	4-5
Oil Pressure .....	4-8
Tachometer .....	4-4

## H

High Voltage Devices and Wiring .....	6-3
---------------------------------------	-----

## I

Instrument Panel Cluster .....	4-3
Introduction .....	iii

## J

Jump Starting .....	6-18
---------------------	------

## L

Lights	
Antilock Brake System (ABS) Warning .....	4-7
Brake System Warning .....	4-5
Charging System .....	4-4
Oil Pressure .....	4-9
StabiliTrak <sup>®</sup> Indicator .....	4-7

## M

Maintenance Schedule	
Recommended Fluids and Lubricants .....	7-2
Manual, How to Use .....	iii



<b>N</b>	
Navigation/Radio System .....	4-13

<b>O</b>	
Oil	
Pressure Light .....	4-9
Oil Pressure Gage .....	4-8
Owners, Canadian .....	ii

<b>P</b>	
Power	
Steering Fluid .....	6-13

<b>R</b>	
Radios	
Navigation/Radio System .....	4-13
Rear Seat Operation .....	2-2
Recommended Fluids and Lubricants .....	7-2

Regenerative Braking .....	3-21
Restraint System Check	
Replacing Restraint System Parts	
After a Crash .....	2-2
Running the Vehicle While Parked .....	3-21

<b>S</b>	
Seats	
Rear Seat Operation .....	2-2
Service	
Doing Your Own Work .....	6-2
Specifications and Capacities .....	6-26
StabiliTrak® Indicator Light .....	4-7
Starting Your Vehicle .....	3-14
Steering	
Fluid, Power .....	6-13

## T

Tachometer .....	4-4
Tonneau Cover .....	3-2, 3-7
Towing	
Towing Your Vehicle .....	5-2
Trailer .....	5-2
Transmission, Automatic Fluid .....	6-5

## V

Vehicle	
Running While Parked .....	3-21
Voltage Devices, and Wiring .....	6-3

## W

Wiring, High Voltage Devices .....	6-3
------------------------------------	-----