

# Bluetooth Keyboard Users Manual

## Getting Start

Thank you for choosing this ultra thin keyboard with Bluetooth technology to ensure no hinder communication between the keyboard and your computer without connecting cable. The transmission and receiving of keyboard are free from angle restriction.

## Package Content

When you purchase the keyboard, it contains:

1x Bluetooth Keyboard

2x AAA Battery

## Keyboard Bottom View

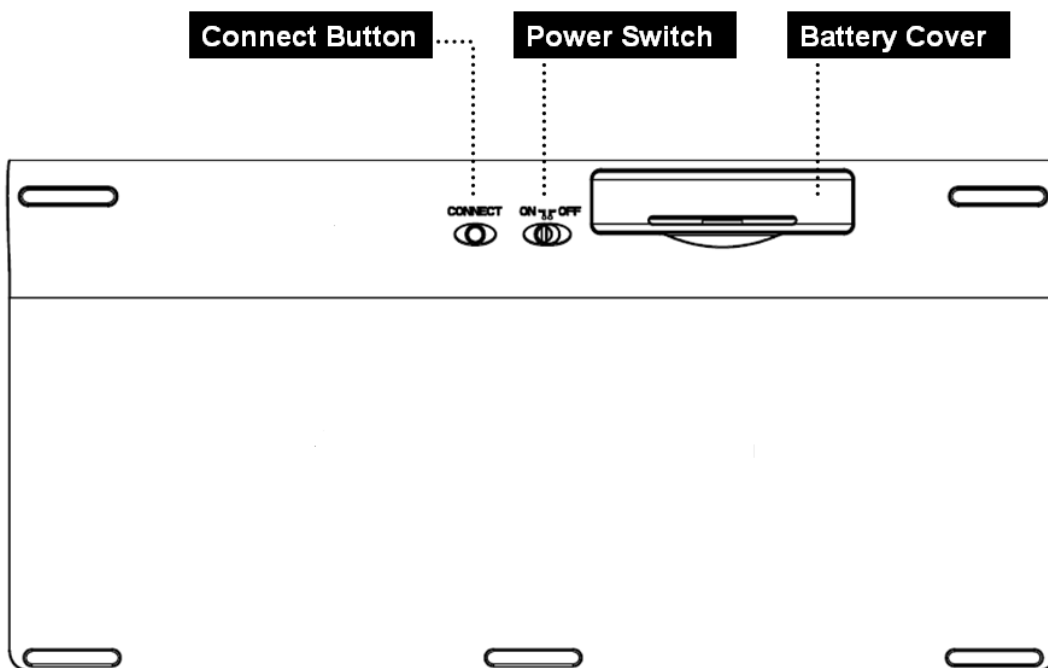

## LED Indication

### ➤ Battery Status



Battery low : Red Led flashes slowly

### ➤ Connect Status



Power On: Green Led brighten for few seconds

Pairing : Green Led flashes for approximately 3 minutes and will stop flash while pairing is successful.

Searching: Green Led flashes till search is finished











## Replacing the batteries



When you purchase this keyboard, the package includes 2 AAA batteries. When the batteries run out of the power, please replace them with new batteries (Please refer to Battery LED indicator). When replacing the batteries, please open the compartment cover and slide the batteries into it. Please don't mix old batteries with new batteries or different types of battery together.

Battery power consumption is low during off mode, so we suggest turning the switch (in the bottom of the keyboard) to "OFF" if you will not use it for a while.

**Warning:** Please keep the batteries out of reach of children, and do not expose them to fire, high temperatures or water.

## Hot Keys Function

|   |                                  |
|---|----------------------------------|
|    | Mute the sound                   |
|   | Decrease volume                  |
|  | Increase volume                  |
|  | Go to Internet                   |
|  | Backward                         |
|  | Forward                          |
|  | Activate default search function |
|  | Go to previous track             |
|  | Stop                             |
|  | Play/Pause                       |

|   |                     |
|---|---------------------|
|  | Go to next track    |
|  | Battery indicator   |
|  | Connector Indicator |

## **Pairing the keyboard**

1. Put batteries into keyboard and set power switch to On.
2. Turn on Bluetooth connecting function on device.
3. Start the PC's Bluetooth add device dialog.
4. Press Connect Button on the keyboard. You will see a Green Led flashing on the F12 Key.
5. Choose PC's Bluetooth keyboard device icon.
6. Enter password as PC's requested and click "Enter".
7. When the keyboard is connected, you will see the information on the screen.

## **Troubleshooting and Tips**

The keyboard does not operate following installation or is not recognized.

- Make sure the batteries are not too weak.
- To determine whether the keyboard or computer causes the problem test the keyboard on a second computer if possible; or test another keyboard on your current computer.

If you are still unable to solve the problem, please contact your point of sale or your dealer.

If you need to exchange the keyboard, please note that you must return it to your dealer in its original packaging and also produce proof of purchase (receipt). Keep your receipt in a safe place after purchase.

## **FEDERAL COMMUNICATIONS COMMISSION (FCC) STATEMENT**

This equipment has been tested and found to comply with the limits for a Class B digital device, Pursuant to Part 15 the FCC rules. These limits are designed to provide reasonable protection against harmful interference in a residential installation. This equipment generates, uses and can radiate radio frequency energy and, if not installed and used in accordance with the instructions, may cause harmful interference to radio communications. However, there is no guarantee that interference will not occur in a particular installation. If this equipment does cause harmful interference will not occur in a particular installation. If this equipment does cause harmful interference to radio or television reception, which can be determined by turning the equipment off and on, the user is encouraged to try to correct the interference by one or more of the following measures:

- Reorient or relocate the receiving antenna.
- Increase the separation between the equipment and receiver.
- Connect the equipment into an outlet on a circuit different from that to which the receiver is connected.
- Consult the dealer or an experienced radio/TV technician for help.

This device complies with part 15 of the FCC rules. Operation is subject to the following two conditions:

(1) This device may not cause harmful Interference, and (2) This device must accept any interference received, including interference that may cause undesired operation.

### **WARNING:**

You are cautioned that changes or modifications not expressly approved by the party responsible for compliance could void your authority to operate the equipment.

### **CAUTION: AVOID PROLONGED USE OF THE KEYBOARD WITHOUT BREAKS.**

Take regular breaks and keep a good posture. Consult your physician promptly if you notice any lost of motion or pain in your wrist when using the keyboard.