

User' Manual

CONTENTS

<u>NOTICE</u>	2
<u>WARNING</u>	2
<u>TRADEMARK</u>	4
<u>BASIC CARE AND TIPS FOR USING YOUR LAPTOP</u>	5
CHAPTER 1 LEARNING THE LAPTOP	7
<u>1.1 FRONT VIEW</u>	8
<u>1.2 LEFT VIEW</u>	10
<u>1.3 RIGHT VIEW</u>	11
<u>1.4 BOTTOM VIEW</u>	12
<u>1.5 STATUS INDICATORS</u>	13
CHAPTER 2 LEARNING THE BASICS	14
<u>2.1 SELECT A PLACE TO WORK</u>	14
<u>2.2 FIX BATTERY PACK</u>	19
<u>2.3 CONNECT AC ADAPTER</u>	20
<u>2.4 TURN ON/TURN OFF THE LAPTOP</u>	21
<u>2.5 USE TOUCH PAD</u>	22
<u>2.6 USE KEYBOARD</u>	23
<u>2.7 CARRYING YOUR LAPTOP</u>	30
CHAPTER 3 BIOS SETUP UTILITY	31
<u>3.1 ACTIVATE THE BIOS SETUP UTILITY</u>	31
<u>3.2 SECURITY</u>	31
<u>3.3 SET BOOT PRIORITY ORDER</u>	32
<u>3.4 RECOVER ORIGINAL SETTINGS</u>	32
<u>3.5 TIPS & NOTICE</u>	32
CHAPTER 4 INSTALL DRIVERS	33
<u>4.1 INSTALL OS</u>	33
<u>4.2 INSTALL DRIVERS</u>	33
<u>4.3 TIPS</u>	33
CHAPTER 5 POWER MANAGEMENT	34
<u>5.1 AC ADAPTER</u>	34
<u>5.2 LITHIUM ION (LI-ION) BATTERY PACK</u>	34
<u>5.3 POWER MANAGEMENT</u>	39
CHAPTER 6 TROUBLESHOOTING	40

Notice

Version (1.0) (2009.9)

The content of this manual may be improved and updated by our company from time to time. Please accept our sincere apologies for any mistakes or carelessness maybe existed in this manual. In case there is any discrepancy between physical product and this manual, the physical product should prevail.

This product is in line with Q/SIE75 Enterprise Standards of China Great Wall Computer Shenzhen Co., Ltd.

Principle

All the marks and tags existing in the user's manual shall stand for the meanings as below:



The information with this mark and tag shall mean the potential problems lying in data loss, equipment damage or human safety probably caused by un-proper operation. Please read the information carefully and remember in heart.



This mark and tag shall mean alarming the customer to note some operations which may cause damages.



This mark and tag shall mean showing the important information, general notice, word explanation, information for your reference and relative general knowledge about how to use the Laptop, etc..

Warning

Changes may be made periodically to the information in this publication without obligation to notify any person who possesses such revision or changes. Such changes will be incorporated in the new edition of this manual or supplementary documents and publications. This company makes no representation or warranties, either expressed or implied, with respect to the contents hereof and specially disclaims the implied warranties of merchantability or fitness for a particular purpose.

No part of this publication may be reproduced, stored in a retrieval system, or transmitted, in any form or by any means, electronic, mechanical, photocopy, recording, or otherwise, without the prior written permission of China Great Wall Computer Shenzhen Co., Ltd.

This device complies with part 15 of the FCC Rules. Operation is subject to the following two conditions: (1) This device may not cause harmful interference, and (2) this device must accept any interference received, including interference that may cause undesired operation. Changes or modifications not expressly approved by the party responsible for compliance could void the user's authority to operate the equipment.

Do not attempt to disassemble the Computer and battery by yourself. Non-expert handling of the devices may damage them.

The Notebook A86 is designed and manufactured not to exceed limits for exposure to radio frequency (RF) energy set by the Federal Communications Commission (FCC) of the U.S. Government. These limits are part of comprehensive guidelines and establish permitted levels of RF energy for the general population. The guidelines are based on standards that were developed by independent scientific organizations through periodic and thorough evaluation of scientific studies. The standards include a substantial safety margin designed to assure the safety of all persons, regardless of age or health. The antenna installed in the lid (display) which provides at least 20 cm separation from the user body with the lid open (at top of display section) inside; The exposure standard for WLAN employs a unit of measurement known as the FCC Part 1.1310(b) (1), FCC Part 2.1091, and Maximum Permissible Exposure (MPE).

This equipment has been tested and found to comply with the limits for a Class B digital device, pursuant to Part 15 of the FCC Rules. These limits are designed to provide reasonable protection against harmful interference in a residential installation. This equipment generates uses and can radiate radio frequency energy and, if not installed and used in accordance with the instructions, may cause harmful interference to radio communications. However, there is no guarantee that interference will not occur in a particular installation.

If this equipment does cause harmful interference to radio or television reception, which can be determined by turning the equipment off and on, the user is encouraged to try to correct the interference by one or more of the following measures:

User' Manual

- Reorient or relocate the receiving antenna.
- Increase the separation between the equipment and receiver.
- Connect the equipment into an outlet on a circuit different from that to which the receiver is connected.
- Consult the dealer or an experienced radio/TV technician for help.

Trademark

Intel[®]、Pentium[®]、Centrino[™]、Celeron[®] are registered trademarks of Intel Corporation.

Windows 2000[®]、Windows XP[®]、Windows Vista[®] are registered trademarks of Microsoft Corporation.

All other brand and product names in this manual are trademarks or registered trademarks of their respective companies and are used by Great Wall legally.

Basic care and tips for using your Laptop

Taking care of your Laptop

Your Laptop will serve you well if you take good care of it.

DO NOT place the Laptop on uneven or unstable work surfaces. Please kindly contact your local dealer if the casing has been damaged.

DO NOT place drop objects on the top of the Laptop and do not shove any foreign objects into it.

DO NOT expose or use the laptop near liquids, rain, or moisture. DO NOT use the modem during an electrical storm.

DO NOT expose the Laptop to dirty or dusty environments.

DO NOT expose the Laptop to strong magnetic or electrical fields.

DO NOT expose the Laptop in extreme temperatures (below 0oC (32oF) or above 50o C (122oF)) or to direct sunlight.

DO NOT block the air vents of the Laptop.

DO NOT press or touch the display panel. Do not place it together with small items that may scratch or enter the Laptop.

DO NOT use the Laptop when the flight is taking off or landing;

Do not use the Laptop beside the apparatus of hospital to avoid disturbing the operating of the apparatus.

Taking care of your LCD panel

DO NOT touch or press the LCD panel of your Laptop with finger or sharp objects which may cause the damage to the panel.

Open and close the panel gently to avoid damage to the panel.

DO NOT place anything on the panel.

Keep the panel away from hardy items such as fastener, watch, buckle to avoid scrapping the panel.

DO NOT use any chemical lotion to clean the panel. Clean the panel with special cloth for the panel. Do not clean the dust with hand which may leave your fingerprint on the panel.

DO NOT have any lotion into the panel.

Taking care of your AC Adapter

Here are some ways to take care of your AC Adapter:

User' Manual

DO NOT connect the adapter to any other devices.

DO NOT step on the power cord or place heavy objects on top of it. Carefully route the power cord and any cables away from personal traffic.

When unplugging the power cord, do not pull the cord itself but pull the plug.

The total ampere ratings of the equipment plugged in should not exceed the ampere rating of the cord if you are using an extension cord. Also, the total current rating of all equipments plugged into a single wall outlet should not exceed the fuse rating.

Taking care of your battery pack

Here are some ways to take care of your battery pack:

Please use only batteries of the same kind as replacements. Turn the power off before removing or replacing batteries.

DO NOT tamper with batteries. Keep them away from children.

Dispose of used batteries according to local regulations. Recycle if at all possible.

Cleaning and servicing

When cleaning the Laptop, please follow these steps:

Power off the Laptop and remove the battery pack;

Disconnect the AC Adapter;

Use a soft cloth moistened with water. Do not use liquid or aerosol cleaners.

If any of the following occurs:

The Laptop has been dropped or the body has been damaged;

Liquid has been spilled into the Laptop;

The Laptop does not operate normally;

Please refer to “Troubleshooting” on page 30.

Chapter 1 Learning the Laptop

In this chapter, we will show you around your new Notebook.

Front View

Left View

Right View

Back View

Bottom View

Status Indicators



.....

In this handbook picture male supplies the reference, the product outward appearance and matches colors the type which possible and you actually purchases to have a part of difference, please take material object as.

1.1 Front View

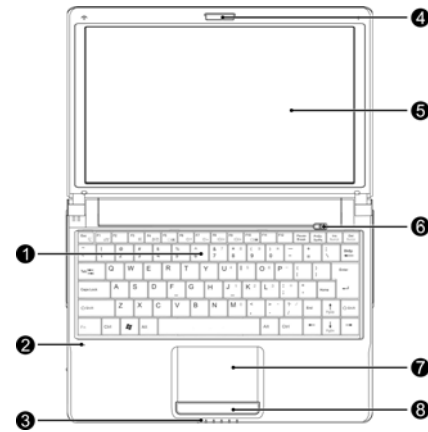

Icon	Item	Description
1	Keyboard	Use to input the date
2	Array Microphone	The built-in array microphone is an Omni-directional audio input device. It allows for the stereo reception and transmission of voice and/or other audio data to any program capable of accepting such input.
3	Status Indicator Lights	The Status indicator lights correspond to specific operating modes. see the“ Status Indicators”
4	Web Camera	The built-in 1.3 Mega pixel camera allows you to snap a photo or create a video chat or video conference within just a click. (This feature depends on your configuration.)
5	Display Panel	The display panel is a color LCD panel with back lighting for the display of text and graphics
6	Power Button	This button turns your notebook on and off as well as puts it to sleep. (See Suspend/Power On Button in the Power On section for more information.)
7	Touch Pad	The Touch Pad device is a mouse-like cursor control with two buttons and a touch sensitive movement pad.
8	Left Right key	Choose Key, as same as the left right key of the mouse.

1.2 Left View

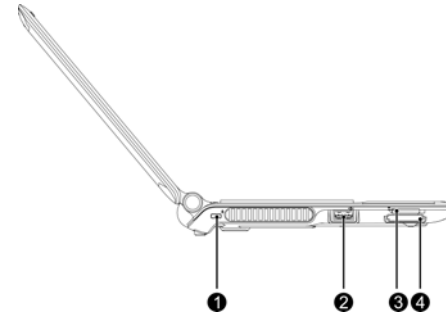

Icon	Item	Description
1	Kensington lock hole	To connect compatible kensington lock.
2	USB port	To connect peripheral equipment with USB interface.
3	SIM card slot	Can support SIM card.
4	Card reader	To read from SD/MMC/MMC PRO Card.

1.3 Right View

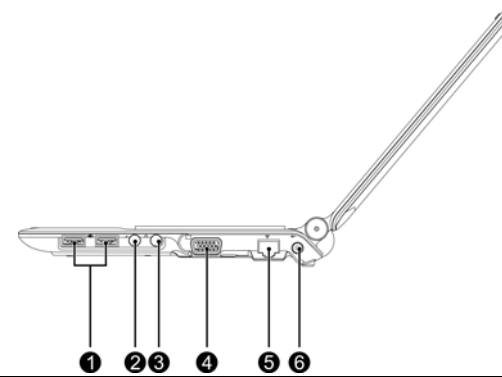

Icon	Item	Description
1、 2	USB port	To connect peripheral equipment with USB interface.
3	MIC jack	To connect MIC to input audio signal.
4	Stereo speaker	Output sound
5	VGA Port	To connect VGA monitor.
6	LAN RJ45 jack	To connect LAN.
7	Power Adapter Port	To connect AC Adapter

1.4 Bottom View

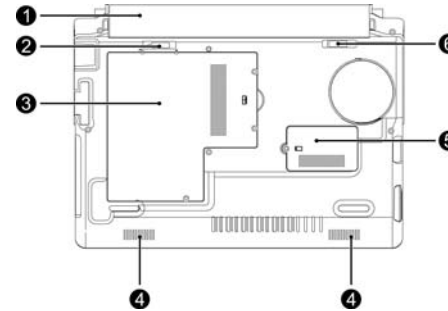

Icon	Item	Description
1	Battery	Installed in the battery compartment, to supply power to the Laptop when AC power is disconnected.
2	Battery latch	To fix and lock battery.
3	HDD Cover	To uninstall or change HDD.
4	Stereo speaker	Output sound
5	Memory Cover	To uninstall or change Memory.
6	Battery latch	To fix and lock battery.

1.5 Status Indicators

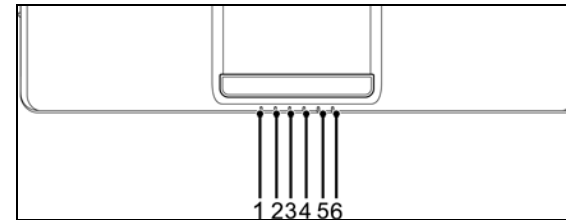

Icon	Item	Description
1	Power indicator	This light on the power button illuminates when the computer is powered on.
2	Battery indicator	Green indicates fully charged. Red indicates battery is being charged. Flashing indicates battery is running low
3	HDD Activity indicator	The Hard Disk Drive (HDD) Activity indicator tells you whether your internal hard drive is being accessed and, if so, how fast.
4	Wireless LAN Activity indicator	The Wireless LAN Activity indicator tells you whether your computer is connected to a wireless network or not.
5	Number Lock indicator	This indicator states that the internal keyboard is set in ten-key numeric keypad mode.
6	CAPS Lock indicator	This indicator tells you that the keyboard is set to type in all capital letters.

Chapter 2 Learning the Basics

2.1 Select a place to work

The Laptop is portable and designed to be used in a variety of circumstances and locations. Please refer to the following information to use it more comfortably:

Creating Laptop-friendly environment

Place the Laptop on a flat surface that is large enough for the Laptop and any other items you need to use, such as a printer. Leave enough space around the Laptop and other equipment in order to provide adequate ventilation and prevent overheating.

To keep your Laptop in prime operating condition, protect your work area from:

- ◆ Dust, moisture, and direct sunlight.
- ◆ Equipment that generates a strong electromagnetic field, such as stereo speakers (other than speakers that are connected to the Laptop) or speakerphones.
- ◆ Rapid changes in temperature or humidity and sources of temperature change, such as air conditioner vents or heaters.
- ◆ Extreme heat, cold, or humidity. The suitable ones are relative temperature between 10°C ~ 35°C, and relative humidity between 20% ~ 80%.
- ◆ Liquids and corrosive chemicals.



.....

Notice: If you spill liquid into the Laptop, please turn it off immediately, unplug it from AC power source, and let it dry out completely before turning it on again.

If the Laptop does not operate correctly after you turn it on again, please kindly contact your local dealer.

Keeping yourself comfortable

Strain and stress injuries are becoming more common as people spend more time using their Laptops. With a little care and proper use of the equipment, you can work comfortably throughout the day. This section provides hints on avoiding strain and stress injuries. For more information, consult books on ergonomics, repetitive-strain injury, and repetitive-stress syndrome.

Placement of the Laptop

Proper placement of the Laptop and external devices is important to avoid stress-related injuries.

- ◆ Place the Laptop on a flat surface at a comfortable height and distance.
- ◆ You should be able to type without twisting your torso or neck, and look at the screen without slouching.
- ◆ If you are using an external monitor, the top of the display should be no higher than eye level.
- ◆ If you are using a paper holder, set it at about the same height and distance as the screen.

Seating and posture

When using your Laptop, please maintain good posture with your body relaxed and your weight distributed evenly. Proper seating is a primary factor for reducing your work strain. Some people find a backless chair is more comfortable than a conventional chair.

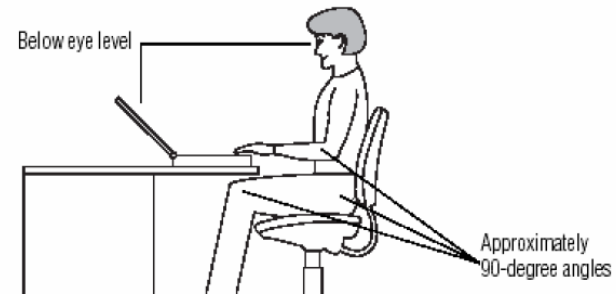

Correct positioning and posture of Laptop

Whichever type you choose, use the following guidelines to adjust your chair for maximum computing comfort:

- ◆ Position your chair so that the keyboard is at or slightly below the level of your elbow. You should be able to type comfortably with your shoulders relaxed and your forearms parallel to the floor.
- ◆ If you are using a conventional chair:
- ◆ Your knees should be slightly higher than your hips. If necessary, please use a footrest to raise the level of your knees and ease the pressure on the back of your thighs.
- ◆ Adjust the back of your chair so that it supports the lower curve of your spine.
- ◆ If necessary, please use a cushion to provide extra back support. Lower-back-supported cushions are available at many office supply stores.
- ◆ Sit with your back straight so that your knees, hips, and elbows form approximately 90-degree angles when you are working. DO NOT slump forward or lean back too far.

Lighting

Proper lighting can improve the visibility of the display and reduce eyestrain.

User' Manual

- ◆ Position the display panel or external monitor to make sure sunlight or bright indoor lighting does not reflect off the screen. Also, please use tinted windows or shades to reduce glare.
- ◆ Please avoid placing your Laptop in front of a bright light that could shine directly in your eyes.
- ◆ If possible, use soft, indirect lighting in your Laptop work area.

Arms and wrists

- ◆ To avoid bending, arching, or twisting your wrists, please keep them in a relaxed, natural position while typing.
- ◆ Exercise your hands, wrists, and arms to improve circulation.



.....

Notice: Using the Laptop keyboard incorrectly may result in discomfort and possible injury. If your hands, wrists, and/or arms bother you while typing, stop using the Laptop and rest. If the discomfort persists, please consult a physician.

Work habits

The key to avoid discomfort or injury from strain is to vary your activities. If possible, please schedule a variety of tasks into your working day. Finding ways to break up the routine can reduce stress and improve your efficiency.

- ◆ Take frequent breaks to change position, stretch your muscles, and relieve your eyes. A break of two or three minutes every half-hour is more effective than a long break after several hours.
- ◆ Avoid performing repetitive activities for long periods. Please intersperse such activities with other tasks.
- ◆ Focusing your eyes on your Laptop screen for long periods can cause eyestrain. Look away from the Laptop frequently and focus your eyes on a distant object for at least 30 seconds.

Precautions

Your Laptop is designed to provide optimum safety and ease of use, and to withstand the rigors of travel. You are recommended to observe certain precautions to further reduce the risk of personal injury or damage to the Laptop.

User' Manual

- ◆ Avoid prolonged physical contact with the underside of the Laptop. If the Laptop is used for long periods, its case may become very warm. While the temperature may not feel too hot to the touch, if you maintain physical contact with the Laptop for a long time (if you rest the Laptop on your lap, for example), your skin might suffer low-heat injury.
- ◆ Never apply heavy pressure to the Laptop or subject it to sharp impacts. Excessive pressure or impact may damage the Laptop components or cause your Laptop to malfunction.
- ◆ Some PC Cards may become hot with prolonged use. If two cards are installed, both may become hot even if only one is being used. Overheating of a PC Card can result in errors or instability in its operation. So please be careful when you are removing a PC Card that has been used for a long period.
- ◆ Avoid spilling liquids into the Laptop's keyboard. If you do spill a liquid that gets into the keyboard, turn off the Laptop immediately, then leave the Laptop turned off overnight to let it dry out before you use it again.
- ◆ Never turn off the Laptop if a drive-in-use light indicates a drive is active. Turning off the Laptop while it is reading from or writing to a disk may damage the disk, the drive, or both.
- ◆ Keep the Laptop and disks away from objects that generate strong magnetic fields, such as large stereo speakers.
- ◆ Information on diskettes is stored magnetically. Placing a magnet too close to a diskette can erase important files.
- ◆ Scan all new files for viruses.

This precaution is especially important for files you receive via diskette, CD or DVD discs, email, or download from the Internet. Occasionally, even new programs you buy from a supplier may contain a Laptop virus. You'll need a special program to check for viruses. Please ask your local dealer for help if need.

2.2 Fix battery pack

Follow the following items to fix battery pack:

- ◆ Turn the Laptop upside down on the even table.
- ◆ Push the battery latch to the position of 『□』.
- ◆ Fix the battery pack as the big arrow shows.
- ◆ After a sound of click, push the battery latch to the position of 『□』.



.....

Warning:

- 1) Do not disassemble the battery pack.
- 2) Keep the battery pack away from the metal items .
- 3) Keep the battery pack away from the water or lotion.
- 4) Keep the battery pack away from children.

Uninstall the battery pack

Follow the below items to uninstall the battery pack:

1. Be sure the Laptop is turned off. Turn the Laptop upside down.
2. Release the latch to 『□』, the battery pack will pop up a little.
3. Take off the battery pack.



.....

Notice: If you want to use your Laptop, please connect it to AC electricity power before uninstalling battery pack.

2.3 Connect AC Adapter

The AC adapter enables you to power the Laptop from an AC outlet and to charge the Laptop's battery pack. The AC power light on the Laptop glows when the device is plugged in.

To connect AC power to the Laptop, you should:

1. Plug AC adapter into the DC-in on the right side of the Laptop.
2. Connect the power cable to AC adapter.
3. Connect the power cable to a live electrical outlet.

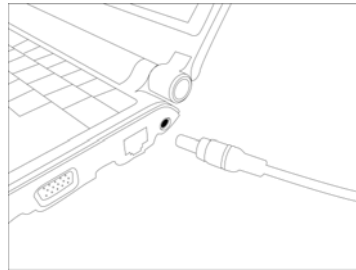

The picture showed here may be different from the exact outlook of the Laptop due to different style of our product. Please consider the outlook showed by the Laptop as standard.

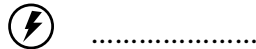

Warning: The AC adapter is special for the Great Wall certain Laptop Model. Please do not use it to other equipments; or do not use other AC adapter to the Laptop.

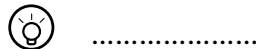

Tips: Please take outlet switch to matcher your Laptop's power cord if you travel to different country or area.

2.4 Turn on/turn off the Laptop

Turn on the Laptop

After the Laptop is powered and the LCD is opened to a suitable angle, you can press the power key to turn on the Laptop. Press the power button about one second to turn on the Laptop.

ⓘ

In the event the system can not be turned off in the above way, you can hold the power key about four seconds to turn off the Laptop. But in this way, you may lose your data which has not been saved before you do so.

Turn off the Laptop

Your can turn off the system at Windows menu:
Click "**Start**", then "**Turn off** " select "**Turn off** " to turn off the Laptop.

ⓘ

Notice: In the event the system can not be turned off in the above way, you can hold the power key about four seconds to turn off the Laptop. But in this way, you may lose your data which has not been saved before you do so.

💡

Tips: The operation described in this chapter only works under Windows®XP for other operation system, please refer to respective help documents.



2.5 Use Touch pad

The built-in touch pad is a PS/2-compatible pointing device that senses movement on its surface. This means that cursor responds as you move your finger on the surface of the touchpad. The central location on the palm rest provides optimum comfort and support.

The picture showed here may be different from the exact touch pad outlook of the Laptop due to different style of touch pad. Please consider the touch pad outlook showed by the Laptop as standard.

Touchpad function

Here how to use the Touch Pad pointing device:

1. The rectangular surface acts like a miniature duplicate of your display screen. To move the mouse cursor, place the finger lightly on the sensor pad and move in the desired direction. If you reach the end of the pad, lift your finger and place it back down on the other side of the pad.
2. To select an item, click on the item by pressing the left button control or by simply tapping on the surface once. A light, quick tap always works best. To execute an item, click the left button twice or do a quick double tap on the surface.
3. To simulate holding the mouse button down (dragging an icon or selection), use the tap-and-drag gesture. This feels much like a double-click, except that the finger remains on the pad after the second tap: Tap, lift, tap, hold and move. The simulated button remains held as long as the finger remains on the pad.



1. left Selection Button
2. right Selection Button
3. touchpad



.....

Notice: Keep your fingers dry

Pad dry and clean. Thus the touch pad can be sensitive enough to finger movement. Hence the lighter the touch is, the better the response is. Tapping too hard will not improve the touch pad responsiveness.

2.6 Use Keyboard

Your laptop computer is equipped with an 87 keys keyboard that provides all the functionality of a full-sized 101 or 102-key keyboard. Aside from the standard typewriter-layout keyboard of your computer, there are a number of extra features and function controls on the built-in keyboard including Windows system hot keys.

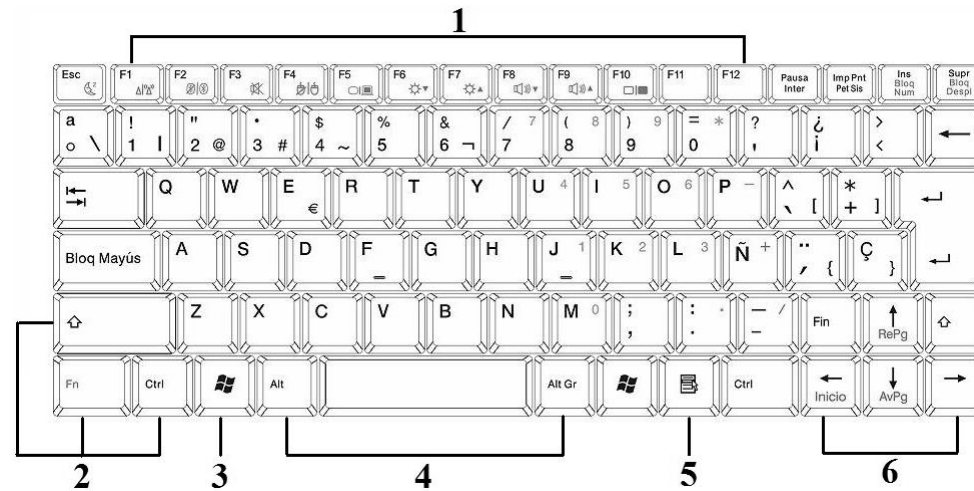

- 1. Function Keys
- 2. Control Keys
- 3. Windows Start Menu Key
- 4. Control Keys
- 5. Windows Shortcut Key
- 6. Cursor Control Keys

Key features and operations are described below:

◆ **Function Keys**

Function keys are application-driven, like F1 through F12 can be found on the keyboard. These keys work together with the Fn key to activate special functions. Some keys (printed in blue on keypad) are preprogrammed with dual functions.

◆ **Control keys** — Ctrl, Alt, Fn, and Shift are controls used in conjunction with other keys to change their functions. To use control keys, press and hold the control key while pressing another key. For example, "Press Ctrl-C" means to hold down the Ctrl key and type the letter C. Key combinations work especially to the application you are running.

◆ **Windows keys**

Use the following two keys to facilitate your work:

- ◇ Start Menu key: Displays the Start menu.
- ◇ Shortcut/Application key: Provides quick access to shortcut menus. This key acts like a right mouse button.







◆ **Cursor Control keys**

Cursor control keys let you position the cursor on the screen where you want. In the screen, the cursor is a blinking underline, block, or vertical bar depending on the application. The cursor indicates where the next text typed is inserted.

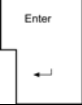

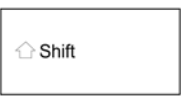

◆ **Typewriter keys**

Typewriter keys (also called alphanumeric keys) are used to enter text and characters. Keys with blue print on them behave differently when combined with control keys.



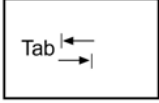

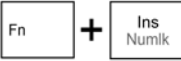
Basic Keyboard Functions

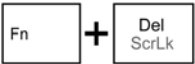
Keypad	Function Description
	<p><Enter> key. Execute a command. Within many text editing application programs, the <Enter> key inserts a hard carriage return, just like what ordinary typewriter does.</p>
	<p><Esc> key. Press this key to cancel or escape from a command or function.</p>
	<p><Ins> key. Known as the Insert key. Press this key to toggle the keyboard data entry from insert to type over mode.</p>
	<p><PrtScr> key. Known as the Print Screen key. Press this key to map the whole screen to share memory for your specific usage.</p>
	<p> key. Known as the Delete key. Press this key to delete the character to the right of the cursor, or delete marked texts or items.</p>
	<p><Pause> key. Press this key to temporarily halt execution of a command. Pressing any other key to resume execution of a command.</p>
	<p><Backspace> key. Press this key to delete the character to the left of the cursor.</p>
	<p><Shift> key. Press this key in combination with alphabet letters to produce uppercase letters in typing. Use this key in combination with those two-character keys (found on the second row of the keyboard) to produce the upper marked keys. Also used in most application program in combination with other keys to execute a certain command.</p>



User' Manual

 The icon shows the word "Tab" followed by a left-pointing arrow above a vertical line and a right-pointing arrow below a vertical line.	<Tab> key. Press this key to move the cursor to the next tab stop on the right. This key works much the same as in ordinary typewriter.
 The icon shows the word "Ctrl" inside a rectangular box.	<Ctrl> key. Known as the Control key. Used in most application program in combination with other keys to execute a certain command.
 The icon shows the word "Alt" inside a rectangular box.	<Alt> key. Known as the Alternate key. Used in most application program in combination with other keys to execute a certain command.
 The icon shows a box with "Fn", a plus sign, and a box with "Ins Numlk".	<Fn> + <Num Lock> key. Activates the embedded 15-key numeric keypad. The keys are color coded blue.
 The icon shows the words "Caps Lock" inside a rectangular box.	<Caps Lock> key. Used in most application program to always activate uppercase alphabet characters.
 The icon shows a box with "Fn", a plus sign, and a box with "Del ScrLk".	<Fn> + <Scroll Lock> key. Used in most application program to scroll the screen without having to move the cursor.

Cursor Control Keys

Keypad	Function Description
	Up arrow key. Moves the cursor up one line at a time.
	Down arrow key. Moves the cursor down one line at a time.
	Left arrow key. Moves the cursor to the left one space at a time.
	Right arrow key. Moves the cursor to the right one space at a time.

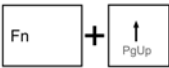
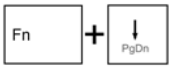
Screen Control Keys

Keypad	Function Description
	<Home> key. Moves the cursor to the beginning of a screen or line.
	<Fn>+<PgUp> key. Moves the cursor up one screen at a time
	<Fn>+<PgDn> key. Moves the cursor down one screen at a time
	<End> key. Moves the cursor to the end of a screen or line.

Windows Hot Keys

Keypad	Function Description
	<Start> key. Pulls up the Windows Start menu.

Fn Combination Keys (Hot Keys)



Use  Fn key combined with other keys to activate, close or set special functions. These combinations are also called Hot Keys. To use the Hot Keys, press and hold down <Fn> together with the keys described below.

Keypad	Function Description
Fn+Esc	Places the notebook in Suspend mode. Pressing the Power button returns it to active mode.
Fn+F1	Enables or disables the wireless network connection
Fn+F2	Enables or disables the Bluetooth connection (Option)
Fn+F3	Mutes the computer's volume
Fn+F4	Enables or disables the TouchPad
Fn+F5	Switch displays. Depending on presence of external display
Fn+F6	Decrease Screen brightness
Fn+F7	Increase Screen brightness
Fn+F8	Decreases the computer's volume.
Fn+F9	Increases the computer's volume.
Fn+F10	Toggle the LCD display on and off
Fn+Ins	Press this key to turn on the numeric keypad overlay, The numeric mode keyboard indicator light glows when the numeric overlay is on.
Fn+Del	Press this key to scroll the screen under some programs.

2.7 Carrying your Laptop

Your Laptop is durable and stable. But it will be good for your Laptop if some cautions as following are adopted when you are moving the Laptop:

- ◆ Check the indicators of the built-in hard disk and disk driver to make sure all the disks are stopped working.
- ◆ Power off the Laptop.
- ◆ Disconnect all the peripheral equipments before moving the Laptop.
- ◆ Disconnect AC adapter before moving the Laptop.
- ◆ DO NOT carry your Laptop by LCD panel or the rear part of the Laptop.
- ◆ Please use the packaged bag to carry your Laptop.



.....

Tips: You can keep your Laptop in Hibernation mode to save your working status on the Laptop if you will carry the Laptop to a meeting. In this way, when you open the Laptop next time, the original status will be showed to you.



.....

Warning: Do not move your Laptop when the HDD or ODD is running.



.....

Tips: Please check whether your power cord matches the local power supply or not if you will travel to other county/area or not.

Chapter 3 BIOS Setup Utility

The BIOS Setup Utility is a hardware configuration program built into your Laptop' BIOS (basic input/output system). Your Laptop is already properly configured and optimized, and you do not need to run this utility. However, if you encounter configuration problems, you may need to run it.

3.1 Activate the BIOS Setup Utility

To activate the BIOS Setup Utility, press F2 or Del during POST.

3.2 Security

The Security screen contains parameters that help safeguard and protect your Laptop from unauthorized use.

Set Supervisor Password

With this setting, only authorized user can enter the system. Follow the below to set:

Select menu **Security**.

Select "**Set Supervisor Password**" and then press "**Enter**".

Input the desired password twice.

Press "**Enter**", when box of **Setup Notice** shows password information.

Set User Password

It's always the same to set user passport as that of supervisor password. But the former can only enter OS, not BIOS Setup.

3.3 Set Boot priority order

With this setting, you can set the order of booting the hardware of the Laptop. (please refer the quick help)

3.4 Recover original settings

In the exit from the BIOS Setup Utility, you can return to original settings by "Load Setup Defaults" or press "F9".

3.5 Tips & Notice

1. For more information about Menu and Keys, please refer to the help information of respective selection. There may be difference of BIOS setting between different versions of BIOS of different batch of laptops produced.
2. The BIOS of your Laptop has been initialized to best settings. It's advised you not to change it if not so necessary.
3. Do not lose the password of your system. In the event of this, you should have to refer to the service center of your Laptop.
4. If you change the BIOS settings and can not return to original settings, you can return to original settings by "Load Setup Defaults".

Discard Changes: User can discard current settings and return to last settings.

Save Changes: User can save the settings but will not exit the BIOS setting menu.

Chapter 4 Install drivers

4.1 Install OS

Please take the OS CD in your external ODD driver, install the OS to your Laptop by flow the OS handle manual.

4.2 Install drivers

The drivers DISC will run automatically when it is inserted to Laptop's optical DISC driver.

4.3 Tips

The pictures showed at this chapter may be different from those showed by your Laptop due to different versions of drivers. Please set pictures of your Laptop as standard.

Chapter 5 Power Management

Power Supply of the Laptop is introduced in this chapter. The power supplied to the Laptop comes from the power converted by AC Adapter from alternative currency or battery pack.

5.1 Ac adapter

The power supplied to the Laptop comes from the power by AC Adapter is used to convert alternative currency to direct currency to power the Laptop. Insert the plug of adapter into the electricity socket, and then the indicator of the power will light up.



.....

Notice: Please read "Taking care of your AC adapter" before using.



.....

Warning: There are high-voltage components in adapter. To avoid injury to your body, DO NOT disassemble adapter and repair it.

5.2 Lithium Ion (Li-Ion) battery pack

Your Laptop uses one battery pack that gives you long use between charges.

Battery pack characteristics

The battery pack has the following characteristics

- ◆ Employ current battery technology standards
- ◆ Battery-low warning

Whenever possible, use the AC adapter. The battery will come in handy when you travel or during a power failure. It is advisable to have an extra fully-charged battery pack available as backup. Contact your dealer for more details.

Maximizing battery life

Laptop batteries, like all other batteries, are “consumables”. This means that their use is consumed over a period of time, and that their performance diminishes over this lifecycle. In order to maximize the length of your battery’s life, please read and adhere to the recommendations set out below.

Conditioning a new battery pack

When using a battery pack for the first time, there is a “conditioning” process that should be followed first before using it with your Laptop.

- ◆ Insert the battery into the Laptop. Do not turn the Laptop on.
- ◆ Connect the AC adapter to a power source (i.e., a power outlet) and to the Laptop and fully recharge the battery.
- ◆ Disconnect the adapter from the power source.
- ◆ Use the Laptop on battery power. Do not plug in AC power during this initial use period.
- ◆ Once the battery is fully depleted of charge while being used (i.e., the Laptop warns you to “switch to AC power”), turn the Laptop off and follow step 1 again.



.....

Notice: Repeat these steps two times. Total conditioning process is 3 charges/ discharges.

Use this process with a new battery or with a battery that's been stored without being used for a long time. If the Laptop is to be stored for more than two weeks, we suggest you remove the battery pack.



.....

Warning: Do not expose battery packs to temperatures below 0°C (32°F) or above 50°C (122°F). This may adversely

affect the battery pack.

By following this process you will have conditioned your battery to accept the maximum charge possible. Failure to follow this procedure will not allow you to get the longest possible battery charge from your battery and will also shorten the effective lifespan of your battery.

The useful life span of the battery is adversely affected by the following usage patterns:

- ◆ Using the Laptop on constant AC power, while the battery is inserted in the Laptop. If you are to use the Laptop on AC power constantly, please remove the battery from the unit after it is fully charged.
- ◆ Not discharging/recharging the battery to its extremes as explained in "Conditioning a new battery pack" above.
- ◆ Frequency of use (the more you use the battery, the faster it will reach the end of its effective life cycle). A standard Laptop battery has a life span of about 500 charges.

Charging the battery

To charge the battery, slide the battery pack into the battery bay and plug the AC adapter into the Laptop and an electrical outlet.

Charging modes

The adapter has two charging modes:

- ◆ Rapid mode

The Laptop uses rapid charging when power is turned off and a powered AC adapter is connected to it. In rapid mode, a fully depleted battery gets fully charged in approximately 3 hours.

- ◆ Charge-in-use mode

When the Laptop is in use with the AC adapter plugged in, the Laptop also charges the battery pack if installed. This mode will take longer to fully charge a battery than rapid mode. In charge-in-use mode, a fully depleted battery gets fully charged in approximately 4.5 hours.



.....

Tips: We suggest that you charge the battery pack before retiring for the day, letting it charge overnight before traveling. This ensures a fully charged battery for use the next day.

Checking the battery level

Using the Windows battery meter:

The Windows battery meter indicates the present battery level. Simply rest your cursor on the battery meter (or AC plug) icon on the taskbar to see the present charge level of your battery.

Optimizing battery life

This section helps you get the most out of battery operation. Optimizing battery life prolongs the charge/recharge cycle and improves recharge efficiency. Follow these suggestions to optimize and maximize battery power:

- ◆ Purchase an extra battery pack.
- ◆ Use the AC adapter whenever possible so that the battery is reserved for on-the-go computing.
- ◆ Keep the battery pack in the Laptop powered by the AC adapter. The constant trickle charge maintains the battery level to eliminate the battery self-discharge effect. The charge-in-use function also charges the battery pack.
- ◆ Disable the parallel port if no devices are connected to this port. You can do this through the BIOS Setup Utility.
- ◆ Eject the PC Card from the slot when it is not in use, since the PC Card draws extra power.
- ◆ Store the battery pack in a cool, dry place. The recommended storage temperature for battery packs ranges from 10 to 30 degrees centigrade. The higher the storage temperature, the faster the battery pack self-discharges.
- ◆ The batteries can be recharged about 300 times when used as directed. Excessive recharging decreases battery life.
- ◆ Take care of your battery pack and AC adapter. See "Taking care of your Laptop".

Battery-low warning

You never need to worry about battery power as long as you are using the AC adapter. However, when you operate the Laptop on battery power, pay extra attention to the battery gauge on the status LCD.

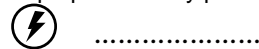

User' Manual

Warning! Connect the AC adapter to the Laptop as soon as possible. Data is lost when Laptop power is cut off during Standby mode.

Table below shows the recommended course of action to take when you encounter a battery-low condition.

Situation	Recommended Action
AC adapter and power outlet available	Connect the AC adapter to the Laptop. Save all necessary files. Resume work. Power off the Laptop before recharging the battery rapidly.
An extra fully-charged battery pack available	Save all necessary files. Exit the application. Power off the Laptop. Replace the battery pack. Power on the Laptop and resume work.
AC adapter or power outlet not available	Save all necessary files. Exit the application. Power off the Laptop.



.....

Tips: You can use your Laptop during charging it. The charging time will be shorter if you turn off your Laptop to charge it.



.....

Notice: Please read "Taking care your battery pack" before charging it.

5.3 Power management

This Laptop has a built-in power management unit that monitors system activity. System activity refers to any activity involving one or more of the following devices: keyboard, mouse, floppy drive, hard disk, peripherals connected to the serial and parallel ports, and video memory. If no activity is detected for a period of time (called an inactivity timeout), the Laptop stops some or all of these devices in order to conserve energy.

This Laptop employs a power management scheme that supports ACPI (Advanced Configuration and Power Interface) which allows for maximum power conservation and maximum performance at the same time. ACPI enables Windows to control the amount of power given to each device attached to the Laptop. Windows handles all power-saving chores for your Laptop. For more information, please refer to Windows help.

Chapter 6 Troubleshooting

This chapter contains advice and solutions to a few basic troubles you might encounter when you use the Laptop. Please refer to this chapter and follow the instructions to solve troubles.

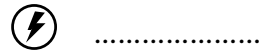

Warning: Under the condition that you can't handle trouble, please refer to your dealer to get professional service.

AC Adapter

Trouble	Solution
No power supplies to the Laptop	Make sure the AC adapter is well connected to the power source and the Laptop.
	Check the cable and plug to make sure they are OK. If they are broken, please contact your local dealer ASAP.

Battery pack

Trouble	Solution
No power supplies to the Laptop	The remaining power in battery pack may be not enough to power on the Laptop. Connect AC Adapter to recharge it.
Can't be recharged after connecting AC Adapter	Check temperature of battery pack's surface. Battery pack can't be recharged if its temperature is too high or too low. Recharged it after its temperature is the same with the normal environment one.
	If battery pack is fully discharged, it won't be recharged at once. Please wait for some minutes.
	If the power indicators of battery pack are always not lit up, its life may be over. Please contact your dealer to buy another one.
Battery life is not as long as it should be	Battery life depends on using condition of the Laptop. You can change the settings in Power Manager of OS to save power.

User' Manual

	Battery pack can't exert its full capacity if it works when not fully recharged frequently. Power the Laptop by battery pack until its power drops to a critically low level and the Laptop emits a high-pitched beep or displays a warning message; after that, recharge battery pack to make battery pack work longer.
--	--

Keyboard

Trouble	Solution
Press character keys but number displayed instead of character	Check if <i>Num Lock</i> is activated. Press <i>Fn + Num Lock</i> and make sure the indicator of <i>Num LK</i> key isn't on.
Confusing display	Make sure there is not certain software to configure to the keyboard.

Hard disc driver (HDD)

Trouble	Solution
HDD can't be booted	Operating system was corrupted by incorrect operating or virus. Try to clean virus and then configure your operating system correctly.
	The documents of your OS maybe run in error, please refer to the manual of your OS.
HDD performs very slowly	There is too much file fragment. Use disk defrag tools to rearrange the programs on the hard disk.

Optical disc driver (HDD)

Trouble	Solution
Can't read from CD-ROM disk	The disk may be dirty. Clean it with a soft damp cloth. Avoid cleaning the disk in a circular way. The disk should be wiped in a radial direction, that is, from the inner side outward.
	The laser lens may have become cloudy or blocked by particulate objects. Please do some cleaning.
Some disks can't be read	Make sure the configuration of software and hardware is set correctly to support your ODD.

LCD

Trouble	Solution
The screen is blank	Press hot key <i>Fn + F5</i> to change the display mode if certain external monitor is connected.
	Make sure the system isn't in the mode of Hibernation or Standby.

Printer

Trouble	Solution
The data can't be output from the Laptop to printer	Make sure printer is powered on.
	Make sure its cable is OK and its USB interface is well connected to the Laptop.
	Make sure your printer is compatible to your Laptop.
Error printing	Please refer to the user's manual of your printer for help.

Audio

Trouble	Solution
No sound emitted	Adjust sound controller.
	Check the setting of sound volume of software.
	Check if the ear phone is firmly connected.。
	Check the Devices Manager of Windows. Be sure the Sound function has been activated and isn't interfered with other hardware.

USB

Trouble	Solution
Equipments connected can't work	Check and be sure USB port of the Laptop is firmly connected with the USB cord of the equipment.
	Be sure the driver of the equipment is installed correctly.

Stand by / Hibernation

Trouble	Solution
Can't enter into Standby /Hibernation	Please check if the Windows Media Player is running. If Yes, the Laptop can't enter into Standby or Hibernation mode. Please close Windows Media Player.

IEEE 1394

Trouble	Solution
Equipments connected can't work	Be sure equipment is firmly connected to the Laptop.
	Be sure the equipment is turned on.
	Reinstall the driver of the equipment and configure it under the instruction of your OS.

LAN

Trouble	Solution
Can't be connected	Be sure the RJ45 connector is firmly connected to the Network Hub or Switch.
Can't be booted	Check the configuration of hardware in BIOS Setup Utility and activate the function of LAN Waken.