

Installation and Setup Manual

020-102404-02

Access Series LCD Panels **UHD551-L and UHD651-L**

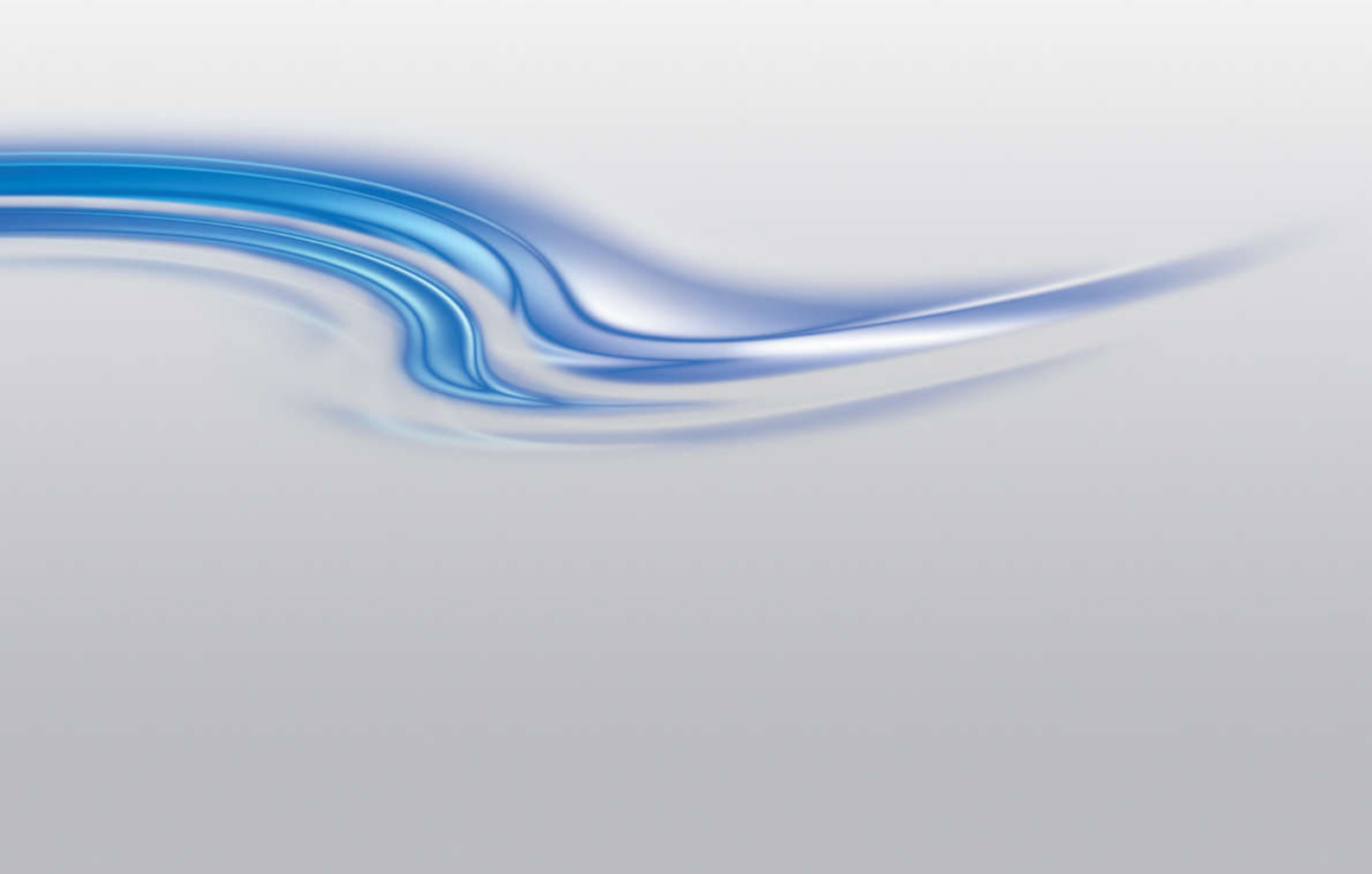

NOTICES

COPYRIGHT AND TRADEMARKS

Copyright © 2017 Christie Digital Systems USA Inc. All rights reserved.

All brand names and product names are trademarks, registered trademarks or trade names of their respective holders.

GENERAL

Every effort has been made to ensure accuracy, however in some cases changes in the products or availability could occur which may not be reflected in this document. Christie reserves the right to make changes to specifications at any time without notice. Performance specifications are typical, but may vary depending on conditions beyond Christie's control such as maintenance of the product in proper working conditions. Performance specifications are based on information available at the time of printing. Christie makes no warranty of any kind with regard to this material, including, but not limited to, implied warranties of fitness for a particular purpose. Christie will not be liable for errors contained herein or for incidental or consequential damages in connection with the performance or use of this material. Canadian manufacturing facility is ISO 9001 and 14001 certified.

WARRANTY

Products are warranted under Christie's standard limited warranty, the complete details of which are available by contacting your Christie dealer or Christie. In addition to the other limitations that may be specified in Christie's standard limited warranty and, to the extent relevant or applicable to your product, the warranty does not cover:

- a. Problems or damage occurring during shipment, in either direction.
- b. Problems or damage caused by combination of a product with non-Christie equipment, such as distribution systems, cameras, DVD players, etc., or use of a product with any non-Christie interface device.
- c. Problems or damage caused by misuse, improper power source, accident, fire, flood, lightning, earthquake, or other natural disaster.
- d. Problems or damage caused by improper installation/alignment, or by equipment modification, if by other than Christie service personnel or a Christie authorized repair service provider.
- e. Problems or damage caused by use of a product on a motion platform or other movable device where such product has not been designed, modified or approved by Christie for such use.
- f. Except where the product is designed for outdoor use, problems or damage caused by use of the product outdoors unless such product is protected from precipitation or other adverse weather or environmental conditions and the ambient temperature is within the recommended ambient temperature set forth in the specifications for such product.
- g. Image retention on LCD flat panels.
- h. Defects caused by normal wear and tear or otherwise due to normal aging of a product.

The warranty does not apply to any product where the serial number has been removed or obliterated. The warranty also does not apply to any product sold by a reseller to an end user outside of the country where the reseller is located unless (i) Christie has an office in the country where the end user is located or (ii) the required international warranty fee has been paid.

The warranty does not obligate Christie to provide any on site warranty service at the product site location.

PREVENTATIVE MAINTENANCE

Preventative maintenance is an important part of the continued and proper operation of your product. Please see the Maintenance section for specific maintenance items as they relate to your product. Failure to perform maintenance as required, and in accordance with the maintenance schedule specified by Christie, will void the warranty.

REGULATORY

The product has been tested and found to comply with the limits for a Class A digital device, pursuant to Part 15 of the FCC Rules. These limits are designed to provide reasonable protection against harmful interference when the product is operated in a commercial environment. The product generates, uses, and can radiate radio frequency energy and, if not installed and used in accordance with the instruction manual, may cause harmful interference to radio communications. Operation of the product in a residential area is likely to cause harmful interference in which case the user will be required to correct the interference at the user's own expense.

CAN ICES-3 (A) / NMB-3 (A)

이 기기는 업무용(A급)으로 전자파적합능력을 한 기기이오니 판매자 또는 사용자는 이점을 주의하시기 바랍니다, 가정 외의 지역에서 사용 하는 것을 목적으로 합니다.

ENVIRONMENTAL

The product is designed and manufactured with high-quality materials and components that can be recycled and reused. This symbol  means that electrical and electronic equipment, at their end-of-life, should be disposed of separately from regular waste. Please dispose of the product appropriately and according to local regulations. In the European Union, there are separate collection systems for used electrical and electronic products. Please help us to conserve the environment we live in!

Content

Package handling.	5
Unpacking the panel.	5
Cleaning the panel.	5
Important safeguards.	6
General safety warnings.	6
AC power precautions.	6
Parts list.	6
Related documentation.	7
Installing a display panel.	8
Display components.	8
Display panel control joystick.	9
Remote control.	9
Mounting a display panel.	11
Installing a display panel on an indented wall.	11
Configuring the display panel after installation.	12
Connecting sources to the panel.	12
Controlling CEC-enabled devices.	12
Selecting the audio destination.	13
Connecting to a wired network.	13
Connecting to a wireless network.	13
Connecting to the display panel over Bluetooth.	14
Copying settings from one display panel to another.	14
Playing content on the display panels.	16
Playing media over the network.	16
Playing media from USB.	17
Playing USB media automatically.	17
Identifying the starting URL.	18
Displaying an image when no signal is detected.	18
Display panel menu contents.	19
Troubleshooting.	24
Understanding the LED status indicators.	24

Wireless network not available.	24
Connection is slow.	25
Disruption during playback or slow reactions.	25
Internet connection not available.	25
Audio video sharing not working.	25
Invalid domain.	26
Specifications.	27
Physical specifications.	27
Power specifications.	27
Environmental specifications.	27
Regulatory.	28
Modification statement.	28
Safety.	28
RF exposure statement.	28
RF exposure.	29
Electro-magnetic compatibility.	29
Environmental.	29

Package handling

Learn how to remove the display panel from the packaging and how to handle the display panel.

Unpacking the panel

Learn how to remove the panel from the packaging.

Each LCD panel is packed inside a box carton. To protect the panel during transportation, additional packing material has been placed within the carton.

1. Before unpacking, prepare a stable, level, and clean surface near a wall outlet.
2. Set the box in an upright position and pull out the white carton locks.
3. Lift up the top cover carton.
4. Remove the ESD bag before removing the display from the bottom tray carton.
5. Remove any additional packaging, such as protective stickers, from the display panel.

Cleaning the panel

Learn how to clean the display panel.

After disconnecting the power cable, wipe contaminated parts and each part of the product screen lightly with a dry and soft cloth.

Do not use a liquid, spray cleaners, or any abrasive cleaners to clean the LCD panel.

Washing with various cleaning agents, brighteners, abrasives, waxes, benzene, alcohol, solvent, surface active agent, may damage the surface of the product.

Important safeguards

To prevent personal injury and to protect the device from damage, read and follow these safety precautions.

General safety warnings

Observe these important safety rules to avoid personal injury or damage to the product.



Warning! If not avoided, the following could result in death or serious injury.

- This product is intended for indoor use only.
- Do not operate the product at an altitude exceeding 2000 m.
- FIRE AND SHOCK HAZARD! Use only the attachments, accessories, tools, and replacement parts specified by Christie.
- Always provide proper ventilation for the product to prevent overheating.
- FIRE HAZARD! Do not install near any devices that produce heat such as amplifiers, radiators, heat registers, or stoves.

AC power precautions

Learn the safety precautions related to AC power.



Warning! If not avoided, the following could result in death or serious injury.

- SHOCK HAZARD! Disconnect the product from AC before moving, servicing, cleaning, removing components, or opening any enclosure.
- FIRE AND SHOCK HAZARD! Do not attempt operation unless the power cord, power socket, and power plug meet the appropriate local rating standards.
- Never compromise the ground or earth connection of the product.
- SHOCK HAZARD! The AC power cord must be inserted into an outlet with grounding.
- The appliance coupler and main power supply plug must be easily accessible for disconnecting the product from the power source.
- FIRE OR SHOCK HAZARD! Do not overload power outlets and extension cords.
- SHOCK HAZARD! Only use the AC power cord provided with the product or recommended by Christie.
- FIRE HAZARD! Do not use a power cord, harness, or cable that appears damaged.
- TRIP OR FIRE HAZARD! Position all cables where they cannot contact hot surfaces, be pulled, be tripped over, or damaged by persons walking on or objects rolling over the cables.

Parts list

Your display panel is shipped with the following items. If any items are missing or damaged, contact your dealer.

- Remote control and batteries
- IR extender cable

- Product Safety Guide and USB flash drive

Related documentation

Additional information on the LCD panels is available in the following documents.

- *Installing the Touch Overlay (P/N: 020-102431-XX)*
- *Access Series LCD Panels External Controls (P/N: 020-102554-XX)*

Installing a display panel

Learn how to install a display panel and connect sources.

Display components

Learn about the various parts of the display panel.

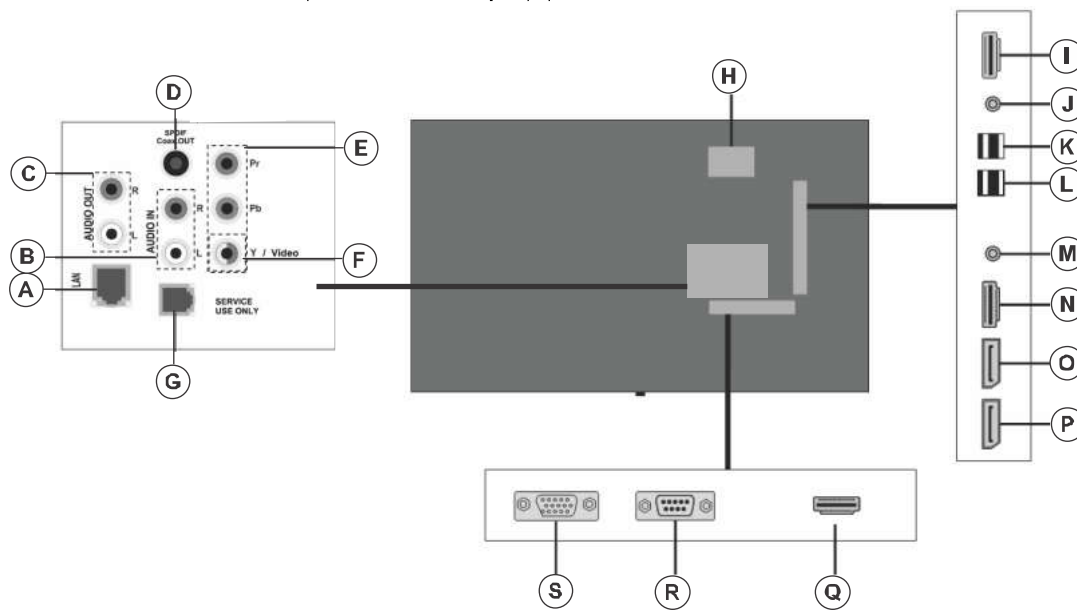

A	Ethernet/LAN port (RJ45)	K	USB 2,0
B	Audio in	L	USB 3,0
C	Audio out	M	Headphone
D	SPDIF Coaxial out	N	HDMI 1
E	YPbPr	O	DisplayPort In
F	Video in	P	DisplayPort Out
G	RJ12 (Service use only)	Q	HDMI 2
H	Internal USB Compartment	R	RS232

I	<p>HDMI Out</p> <p>Only the content received from the HDMI1 input port (N) can be outputted from this port. The HDMI output port functions when a source device is connected to the HDMI input.</p>	S	VGA
J	IR input		

Display panel control joystick

Learn about the control joystick on the rear of the display panel.

The on-screen display menu cannot be displayed with the control joystick.

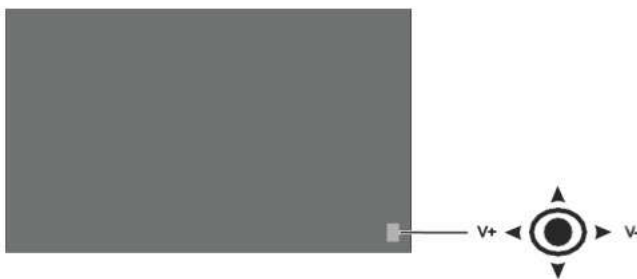

1. To turn on the display panel, press the center of the control joystick.
2. To turn off the display panel and put it into standby mode, press and hold the center of the control joystick for a few seconds.
3. To change the source, press the center of the control joystick.
4. To scroll through the available sources, move the joystick up and down.
5. To change the volume, press the control joystick left and right.
To increase the volume, move the joystick right. To decrease the volume, move the joystick left.

Remote control

Learn the functions of the remote control.

Before you insert batteries in the remote control, consider the following:

- Ensure that the battery polarities are correct.
- Do not mix an old battery with a new one or mix different types of batteries together.
- Do not expose batteries to excessive heat such as sunlight or fire.

If you will not use the remote control for a long time, consider removing the batteries to avoid damage from battery leakage.

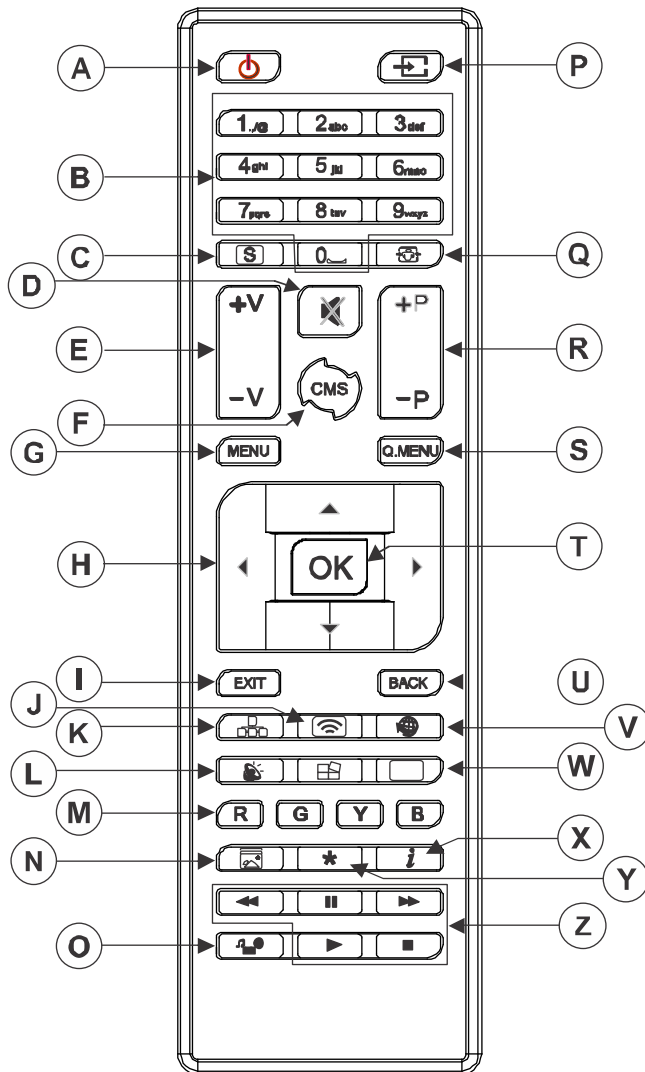

A	Standby —Switches the display panel on and off.	N	Picture Mode —Cycles between picture modes.
B	Numeric buttons	O	Media browser —Opens the media browsing screen.
C	Signage —Displays the Signage Settings menu.	P	Source —Shows all available content sources.
D	Mute —Silences the volume of the display panel.	Q	Screen —Changes the aspect ratio of the screen.
E	Volume —Increases or decreases the volume.	R	Not supported
F	CMS —Opens the predefined Start URL. To open the predefined starting image, press and hold the CMS button for three seconds.	S	Quick Menu —Displays a list of menus for quick access.
G	Menu —Displays the main menu.	T	OK —Confirms user selections.

H	Directional buttons —Navigates through sub-menus and settings,	U	Back —Returns to previous screen,
I	Exit —Exits the displayed menu, or returns to the previous screen,	V	Internet —Opens the predefined Start URL,
J	Wireless Display —Opens the wireless display connection screen,	W	Picture —Displays the Picture Settings menu,
K	Network —Displays the Network/Internet Settings menu,	X	Info —Displays information about on-screen content,
L	Sound —Displays the Sound Settings menu,	Y	Not supported
M	Colored Buttons —For colored button functions, follow the on-screen instructions,	Z	Play buttons —Rewind, play, fast forward, stop, or pause media,

Mounting a display panel

Use only the approved wall-mount kit designed for your display panel.

If you decide to wall-mount a display panel, ensure that the wall-mount bracket is installed according to the instructions that are included with it. The wall must be capable of supporting three times the weight of the display panel, or be reinforced.

Installing a display panel on an indented wall

When installing the display panel on an indented wall, ensure there is sufficient space around the display panel and the wall for ventilation.

The ambient temperature must be between 0-35°C (32-95°F). Do not expose the product to direct sunlight.

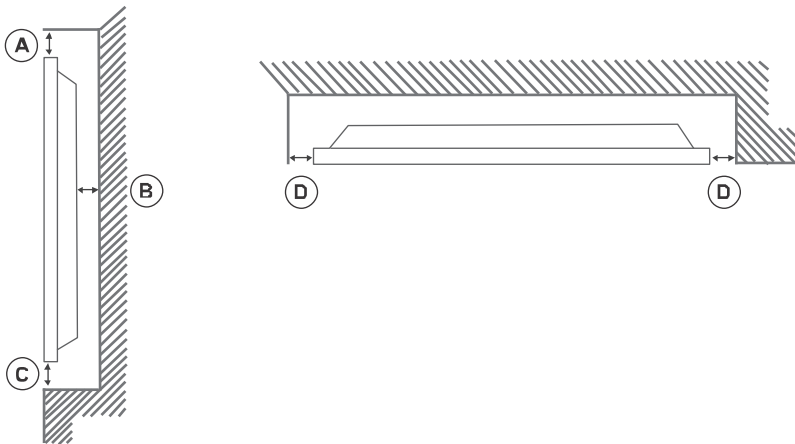

A	Minimum 70 mm
B	Minimum 50 mm
C	Minimum 50 mm
D	Minimum 50 mm

Configuring the display panel after installation

After turning the display panel on for the first time, complete the initial configuration.

1. Power on the display panel.
2. Using the display panel remote, select the display language and press **OK**.
3. Select the country and press **OK**.
4. Set and confirm a PIN.
For some countries, the PIN cannot be set to 0000.
5. Configure the Signage settings, such as the OSD orientation, automatic software updates, and display panel ID.
Model name, Serial number, and Software version cannot be modified.
6. Press **OK**.
7. Connect the display panel to a network.
8. Press **OK**.
9. To repeat this process and reset the display panel settings to the factory defaults, select **Signage Settings > First time installation** and press **OK**. Type the PIN, and accept the confirmation message.
10. To exit the menu, on the remote press **Menu** again.

Connecting sources to the panel

Select the port the source computer is connected to.

1. Connect a cable from the source computer to the display panel.
2. On the display panel remote, press **Menu**.
3. Select **System > Settings > Sources**.
4. Select the source input and press **OK**.
5. To exit the menu, on the remote, press **Menu** again.

Controlling CEC-enabled devices

Control CEC-enabled devices connected through the HDMI ports using the display panel remote.

1. On the remote, press **Menu**.
2. Select **System > Settings > More > CEC**.
3. Select **Enable**.
4. On the remote control, press **Source**.
5. In the Sources list, select the HDMI input of the connected CEC device.
When a new CEC source device is connected, the connected HDMI port name is replaced with the name of the CEC source device in the Source menu.
6. To exit the menu, on the remote, press **Menu** again.

Selecting the audio destination

Configure whether the audio is played through an amplifier or through the display panel.

Compatible audio devices must support System Audio Control.

1. On the display panel remote, press **Menu**.
2. *Enable the CEC option* (on page 12).
3. Select **System > Settings > More > Speakers**.
4. Select the destination for the audio.
 - **Display**—All audio is played through the display panel speakers.
 - **Amplifier**—All audio is played through the connected sound system, the display panel speakers are muted, and the volume is controlled using the remote for the display panel.

The display panel also supports also ARC (Audio Return Channel) feature. This is an audio link meant to replace other cables between the display panel and the audio system.

When ARC is active, the audio of the display panel is not muted automatically. To hear audio from connected audio devices only, the volume of the display panel must be turned down manually.

5. To exit the menu, on the remote, press **Menu** again.

Connecting to a wired network

For wired connections, connect the display panel to the modem or router with an Ethernet cable.

1. On the display panel remote, press **Menu**.
2. Select **System Settings > Network/Internet Settings > Network Type**.
3. Select the **Wired device** network connection.
4. Select **Advanced Settings** and press **OK**.
5. Change the IP address setting to **Manual** and type the IP address for the display panel.
6. To save the settings, press **OK**.
7. Repeat steps 6 and 7 for the DNS settings.
8. To exit the menu, on the remote, press **Menu** again.

Connecting to a wireless network

Content stored on a mobile device connected to the wireless network can be accessed and displayed on the display panel through the Media Browser.

The display panel supports 802.11 a,b,g and n type modems. Christie recommends using the IEEE 802.11n communication protocol.

The display panel cannot connect to networks with a hidden wireless network name (SSID). If the modem shares the same SSID as another modem in the area, change the SSID of the modem. Use a wired connection if you experience problems with a wireless connection.

1. On the display panel remote, press **Menu**.
2. Select **System Settings > Network/Internet Settings > Network Type**.

3. Select the **Wireless device** network connection.
The display scans for wireless networks automatically.
4. Select the network from the list.
5. If required, using the directional buttons on the remote, enter the network password and press **OK**.
Alternatively, if the router has a WPS (Wi-Fi Protected Setup) button, select **Press WPS on your WiFi router** and press **OK**, and press the WPS button on the router.
When the IP address is displayed on the screen, the connection with the network has been established.
6. Select **Advanced Settings** and press **OK**.
7. Change the IP address setting to **Manual** and type the IP address for the display panel.
8. To save the settings, press **OK**.
9. Repeat steps 8 and 9 for the DNS settings.
10. To exit the menu, on the remote press **Menu** again.

Connecting to the display panel over Bluetooth

Connect Bluetooth devices to the display panel.

1. On the Bluetooth-enabled device, turn on pairing mode.
2. To connect audio devices, select **System > Sound > Audio Link**.
To connect remote controls, select **System > Settings > More > Smart Remote**.
3. To initiate device discovery, on the remote, press the green button.
4. From the list of available devices, select the device to connect to and press **OK**.
If the message **Device connected** is displayed, the connection was successfully. If the connection fails, try again.
5. To exit the menu, on the remote, press **Menu** again.

Copying settings from one display panel to another

For installations with multiple display panels, copy the settings from one display panel and import them onto the other display panels.

The settings copied include database files, all preference data, and the signage and link option settings.

The Copy from USB and Copy to USB menu options are only available when a USB device is connected to the display panel.

1. Copy the settings to an external USB storage device.
 - a) Connect the USB storage device to the display panel.
 - b) On the display panel remote, press **Menu**.
 - c) Select **Signage Settings > Clone to USB**.
The settings are saved to a folder named `Closed <number>`.

2. Copy the settings from the external USB storage device to the display panel.
 - a) Connect the USB storage device to the display panel.
 - b) On the display panel remote, press **Menu**.
 - c) Select **Signage Settings > Clone from USB**.
 - d) Navigate to the folder created in 1C and click **OK**.
3. To exit the menu, on the remote, press **Menu** again.





Playing content on the display panels

Learn how to play images, video, and audio on the display panels.

Playing media over the network

Play content available on the same network as the display panel.

For higher playback quality, Christie recommends using a wired connection when connecting the display panel to other devices.

1. Connect the display panel to the wired or wireless network.
2. On the display panel remote, press **Media Browser**.
3. While in the Media Browser, on the remote, press **Menu**.
4. Select the media type.
5. Select the media server or network to connect to and press **OK**.
To refresh the device list, on the remote, press the green button.
6. If the selected media type is video, navigate to the location of the video files and select the file to play.
7. To play other media types, go back to main Media Browser menu and select the media type and the network again.
To switch to next media type quickly without changing the network, press the blue button.
8. Play the selected content.
 - To play all files in the list as a loop, in their original order, start playback with the **Play** button and activate .
 - To play the same file continuously, start playback with the **OK** button and activate .
 - To shuffle all files in the list once, start playback with the **Play** button and activate .
 - To shuffle all files in the list indefinitely, start playback with the **Play** button and activate  and .
9. To exit the menu, on the remote, press **Menu** again.

Related information

Connecting to a wired network (on page 13)

Connecting to a wireless network (on page 13)

Playing media from USB

Play photos, music, and movie files stored on a USB device by connecting it to the display panel.





USB memory sticks and 2.5" and 3.5" inch external hard drives with external power supplies can provide content to the display panel through the USB inputs of the display panel. Certain types of USB hard drives, flash drives, and USB devices such as MP3 players may not be compatible with the display panel. The display panel supports FAT32 and NTFS disk formatting.

If both an internal USB device and external device are inserted, the media player uses the external device only.

USB hubs can be used with the USB inputs of the display panel. External power supplied USB hubs are recommended. When connecting a USB hard drive, use the USB inputs of the display panel directly.

Back up the files on your storage devices before connecting them to the display panel.

Before removing the USB device, ensure files are not being read or played from the device. Failure to do so may cause physical damage to the USB player and the USB device itself.

1. Back up the files on the storage devices before connecting them to the display panel.
2. Connect a USB hard drive or flash drive to one of the USB inputs located on the side of the display panel.
3. On the display panel remote, press **Media Browser**.
4. While in the Media Browser, on the remote, press **Menu**.
5. Navigate to the media to show on the display panel.
The Media Browser menu can only display 1000 image files stored on the connected USB device.
6. Play the selected content.
 - To play all files in the list as a loop, in their original order, start playback with the **Play** button and activate .
 - To play the same file continuously, start playback with the **OK** button and activate .
 - To shuffle all files in the list once, start playback with the **Play** button and activate .
 - To shuffle all files in the list indefinitely, start playback with the **Play** button and activate  and .
7. To exit the menu, on the remote, press **Menu** again.

Playing USB media automatically

Automatically start playing the media content on a USB device.

The content types available through the Media Browser are played in a predetermined order: photo, video, and then audio. If there are photo files in the root directory of the USB device, the Media Browser plays the photos in alphabetical order by file name. If there are no photo files, the USB device is checked for video content, and then audio.

1. On the display panel remote, press **Media Browser**.
2. While in the Media Browser, on the remote, press **Menu**.
3. Select **Settings**.
4. Enable the **AutoPlay** option.
5. To exit the menu, on the remote, press **Menu** again.

Identifying the starting URL

Specify the URL to be displayed when the display panel is powered on.

1. Create a file named starturl.txt and save it in the root directory of any USB storage device.
2. Open the file in a text editor, and type the URL to display.
The URL can be a link to a file or an HTTP or HTTPS address.
3. Save and close the file.
4. Connect the USB storage device to the display panel.
5. In the display panel menu, select **Signage Settings > USB Operations** and press **OK**.
6. Turn the display panel off and on.
7. To check if the starting URL has the correct link, select **Signage Settings > Link options**.

Displaying an image when no signal is detected

Set the behavior of the display panel when no signal is detected from the selected input source.

1. In the display panel menu, select **Signage Settings > No Signal**.
2. To set the display panel to check the connected USB devices for available files to play, select **Failover**.

If no playable files are available or there is no USB device connected to the display panel, the No Signal image is displayed and the display panel turns off after five minutes.

If the No Signal image is not available, the message "No Signal OSD" is displayed on the screen, and the display panel turns off after five minutes.

Display panel menu contents

Learn the structure of the display panel menu tree.

System > Picture menu

Mode	Changes the picture mode to suit the site preference or requirements. Picture mode can be set to one of these options: Text, Game, Sports, Signage, and Natural.	
Contrast	Adjusts the light and dark values on the screen.	
Brightness	Adjusts the brightness values on the screen.	
Sharpness	Sets the sharpness value for the objects displayed on the screen.	
Color	Sets the color value and adjusts the colors.	
Energy Saving	Sets the Energy Saving to Custom, Minimum, Medium, Maximum, Auto, Screen Off, or Off. The available options may differ depending on the selected mode.	
	Backlight	Controls the backlight level. The backlight function is inactive if the Energy Saving is set to an option other than Custom .
Advanced Settings		
	Dynamic Contrast	Changes the dynamic contrast ratio to the desired value.
	Noise Reduction	Reduces the amount of noise in a picture if the signal is weak.
	Color Temp	Sets the desired color temperature value. Cool (1300K), Normal (9300K), and Warm (8500K) options are available.
	Picture Zoom	Sets the desired image size format.
	Movie Sense	Sets Movie Sense to Low, Medium, High, or Off. While Movie Sense is active, the video settings on the display panel are optimized for motion images. When the Movie Sense option is set to Low, Medium or High, the Movie Sense demo option is available. While demo mode is active, the screen is divided into two sections, one displaying the movie sense activity, and the other displaying the normal settings for the display panel.
	Film Mode	Adjusts the display for films with fast motion scenes.

	RGB Gain	Adjusts the strength of the red, green, and blue colors, RGB Gain can also be used for fine adjustments of white balance in the picture.
	HDMI Full Range	Enhances the blackness in the picture.
PC Position		Appears only when the input source is set to VGA/PC.
	Auto position	Automatically optimizes the display.
	H Position	Shifts the image horizontally to the right or left of the screen.
	V Position	Shifts the image vertically towards the top or bottom of the screen.
	Dot Clock	Corrects the interference that appears as vertical banding in dot intensive presentations like spreadsheets, paragraphs, or text in smaller fonts.
	Phase	Clears hazy or noisy pictures, by trial and error.
Reset		Resets the picture settings to factory default settings (except Game mode).
While in VGA (PC) mode, some items in Picture menu are unavailable. Instead, VGA mode settings are added to the Picture Settings.		

System > Sound menu

Volume	Adjusts the volume level.
Equalizer	Selects the equalizer mode. Custom settings can be made only when in User mode.
Balance	Adjusts whether the sound comes from the left or right speaker.
Headphone	Sets headphone volume. To prevent damage to your hearing, before using headphones, ensure that the headphone volume is set to a low level. This is only available if the Headphone/Lineout option is set to Headphone .
Audio Link	Discovers and wirelessly connects sound devices to the display panel.
AVL (Automatic Volume Limiting)	Sets the sound to a fixed output level for all sources.
Headphone/Lineout	Sets the type of external audio. Lineout —An external amplifier is connected to the display panel using the headphone jack. Headphone —Headphones are connected to the display panel.
Digital Out	Sets the digital out audio type to PCM or Compressed.
Bass Gain	Controls the bass gain level.

System > Settings menu

Language	Sets the OSD menu language.
Date/Time	Sets the date and time.
Sources	Enables or disables selected source options.
Network/Internet Settings	Displays network/internet settings.

More		Displays other setting options of the display panel.
	Menu Timeout	Changes the timeout duration for menu screens.
	Standby Led	Enables or disables the functionality of the standby LED. If disabled, the LED will not function.
	Software upgrade	Ensures that the display panel has the latest firmware.
	Application Version	Displays the current software version.
	Auto Display OFF	Sets the desired time for the display panel to automatically go into standby mode when not being operated.
	Audio Video Sharing	Shares files stored on a smartphone or tablet. Sharing software must be installed on the connected device.
	Power Up Mode	Configures the power up mode preference as Last State, Always On, and Standby.
	CEC	Enables and disables the CEC functionality completely.
	CEC Auto Power On	Allows connected HDMI-CEC compatible devices to turn on the display panel and switch to its input source automatically.
	Speakers	Sets whether audio is heard through the display panel speakers or a connected compatible audio device set.
	DP Stream Setting	Sets the DisplayPort stream type as MST or SST. This menu item appears only when the input source is set to DP.
	Smart Remote	Discovers and wirelessly connects remote control devices to the display panel.
	Quick standby	When enabled, if the display panel is turned off using RS232 or LAN commands, it can be turned on again.

Signage Settings menu

Set ID	Sets the device ID with a value between 0-100.
OSD Orientation	Sets the orientation of the display panel on-screen display.
Software upgrade	Ensures that the display panel has the latest firmware.
Serial number	Displays the serial number of the unit.
Model name	Displays the model name of the unit.
Save model information	Copies the model information data of the unit to a connected USB device.
Clone to USB	Copies the database files from the unit to a connected USB device.
Clone from USB	Copies the database files from a connected USB device to the unit.
Internal USB operations	Copies files from an internal USB drive to the unit. Only available when an internal USB device is connected.
Power Up Mode	Configures the power up mode preference to Last state, Always on, or Standby.
Quick Standby	When this feature is enabled, if the display panel is turned off using RS232 and LAN commands, it can be turned on again with the RS232 and LAN commands.

OPS Settings	<p>Open the OPS Settings menu screen, Three sub-menu options are available:</p> <p>OPS Information—Displays read-only information about the OPS unit, if supported.</p> <p>OPS Status—Displays whether the OPS module is on or off. Allows the change of status via soft PSON signal (0,5s)</p> <p>Power down—Turns the OPS off via hard PSON signal (5s)</p> <p>This menu is not available if an OPS is not connected to the display panel.</p>
Copy app cache from USB	<p>Copies app cache data from a connected USB device to the unit.</p>
Scheduler Settings	<p>Sets the unit to turn on or off automatically at defined time with the defined input source setting.</p> <p>If the Source option is set as Last State, the input source will not be changed at power-up.</p> <p>If the Source option is set as USB, the media files in the connected USB device are played back automatically.</p>
Link options	<p>Displays the current Start URL and Settings URL links, and the configuration for the Open browser initial page and NTP server link preferences.</p>
Pixel shift	<p>Enables or disables pixel shifting, used to avoid image retention that can occur when displaying fixed patterns or still images for a long periods of time. If enabled, the picture and OSD (On-Screen Display) is shifted at specified time intervals.</p>
USB Information	<p>Displays the Current Total space and Free space information of the connected USB device, and formats the connected USB device.</p>
Power on Delay	<p>Sets a delay value at power on, from 0 to 2000 ms in steps of 100 ms. The display panel turns on after the set delay time is expired.</p>
USB operations	<p>Highlight and press OK to perform USB operations.</p>
No Signal	<p>Sets the behavior preference of the display panel, when no signal is detected from the currently set input source. Failover and Input Search options are available.</p> <p>If no playable files are available or there is no USB device connected to the display panel, the No Signal image is displayed and the display panel turns off after five minutes.</p> <p>If the No Signal image is not available, the message "No Signal OSD" is displayed on the screen, and the display panel turns off after five minutes.</p> <p>If Input Search is selected the display panel searches all available input sources consecutively to find a signal. If no signal is detected from other available sources, "No Signal OSD" is displayed and the display panel turns off after a period of 30 seconds.</p>
No signal Power off	<p>When enabled, if no signal is received from the selected source, the display panel turns itself off after a period of five minutes. This feature only works if all of the following circumstances occur:</p> <ul style="list-style-type: none"> ▪ No Signal option is set as Failover. ▪ A USB device is not connected to the display panel, or a USB device is connected, but no playable files are installed in the USB device.
Auto launch	<p>Configures the auto launch preference as CMS (Start URL), Open Browser (Open Browser initial page), or Disabled.</p>

Last Status	Enables the display panel to reopen with the closing status,
Panel Lock	Prohibits the use of the buttons on the display panel.
RCU Inhibit	Inhibits the use of the remote. The remote control functions in Stand-By mode independently from this setting. If this option is set as Limited only the Volume Up/Down, Numeric Buttons, and the Standby button on the remote are functional.
Volume Settings	Displays the volume preferences.
USB Option	Disables the USB ports on the display panel, or select the 5V option to provide 5 volts power over USB. When set to 5V, browsing the USB content through the Media Browser is disabled.
Boot Up Picture mode	Configures the picture mode preference at power on. If set as Off, the last set picture mode is used at power on.
TV Live Time	Displays the amount of time the panel has been active since the panel was first turned on, including any time the panel was in stand-by.
Reset to Default Values	Returns the display panel to default settings.
First time installation	Resets all settings to factory defaults, and begins the First Time Installation configuration. The PIN configured during the first configuration is required to carry out this operation.

Troubleshooting

Learn about common issues and their solutions.

Understanding the LED status indicators

Identify the LED state flashing pattern and meaning.

LED Status	Status of the monitor
Power LED not lit	Power on
Power LED lit	Power off (Standby mode)
Power LED flashing (slow)	Scheduler active
Power LED flashing (fast)	Power up/down and software update

Wireless network not available

The wireless network does not appear in the list of available networks.

Resolution

- Ensure the display panel wireless connection is allowed through the network firewall.
- Try searching for wireless networks again.
- If the wireless network does not function properly, use the wired network.
- If the display panel does not function using the wired connection, check the modem and router.
- If the router does not have a problem, check the internet connection of your modem.

Related information

Connecting to a wired network (on page 13)

Connection is slow

The network connection to the display panel is slow.

Resolution

To get information on the internet service area, connection speed, signal quality, and other settings, refer to the wireless modem documentation.

Disruption during playback or slow reactions

While content is playing on the display panel, the video is disrupted or slow to play.

Resolution

- Ensure the display panels are at least three meters away from microwave ovens, mobile telephones, Bluetooth-enabled devices, or any other Wi-Fi compatible devices.
- Change the active channel on the WLAN router.

Internet connection not available

The display panel cannot connect to the internet.

Resolution

- Ensure the display panel wireless connection is allowed through the network firewall.
- The MAC address of the display panel is authenticated each time when connecting to the internet. If the MAC address of the computer or modem is permanently registered, it is possible that the display panel might not connect to the internet. Because the display panel has its own MAC address, the internet service provider cannot validate the MAC address of the display panel. For this reason, the display panel cannot connect to the internet. Contact the internet service provider and request information on how to connect a different device, such as the display panel, to the internet.

Audio video sharing not working

Audio and video cannot be shared to the display panel.

Resolution

- Ensure the display panel wireless connection is allowed through the network firewall.
- The MAC address of the display panel is authenticated each time when connecting to the internet. If the MAC address of the computer or modem is permanently registered, it is possible that the display panel might not connect to the internet. Because the display panel has its own MAC address, the internet service provider cannot validate the MAC address of the display panel. For this reason, the display panel cannot connect to the internet.

Contact the internet service provider and request information on how to connect a different device, such as the display panel, to the internet.

Invalid domain

An invalid domain error is displayed when trying to share media.

Resolution

Prior to sharing any files in the media server program on the computer, ensure that an authorized username and password is used for logging in, and that the domain is active. If the domain is invalid, this might cause problems while browsing files in Audio Video Sharing mode.

Specifications

Learn about the product specifications. Due to continuing research, specifications are subject to change without notice.

Physical specifications

Learn the physical specifications for the tiles and the power supply.

	UHD551-L	UHD651-L
Dimensions (W x H x D)	1238 mm x 712 mm x 104 mm (48.74 in x 28.02 in x 3.19 in)	1459 mm x 841 mm x 96 mm (57.44 in x 33.11 in x 3.78 in)
Weight	17,5 kg (38,58 lb)	22,5 kg (49,6 lb)
Resolution	3840 x 2160 (16:9) UHD	
VESA wall mount measurements		
Hole pattern size	400 mm x 200 mm	400 mm x 400 mm
Screw thread size	M6	
Screw length	9.5 mm minimum, 16.5 mm maximum	

Power specifications

Learn the power requirements for the display panels.

	UHD551-L	UHD651-L
Input rating	110-240V AC 50-60Hz 1300mA	110-240V AC 50-60Hz 1400mA

Environmental specifications

Learn the environmental specifications for the display panels.

Non-operating environment

	UHD551-L	UHD651-L
Temperature	-20 °C - 60 °C (-4 °F - 140 °F)	

	UHD551-L	UHD651-L
Humidity	20 – 90% RH (No condensation)	

Operating environment

	UHD551-X	UHD651-X
Temperature	0 °C - 40 °C (32 °F - 104 °F)	
Humidity	10 – 90% RH (No condensation)	

Regulatory

This product conforms to the following regulations related to product safety, environmental requirements and electromagnetic compatibility (EMC).

Modification statement

Christie Digital Systems has not approved any changes or modifications to this device by the user. Any changes or modifications could void the user's authority to operate the equipment.

Christie Digital Systems n'approuve aucune modification apportée à l'appareil par l'utilisateur, quelle qu'en soit la nature. Tout changement ou modification peuvent annuler le droit d'utilisation de l'appareil par l'utilisateur.

Safety

- CAN/CSA C22.2 No. 60950-1
- ANSI/UL 60950-1
- IEC 60950-1
- EN 60950-1

RF exposure statement

This device complies with Part 15 of the FCC Rules and Innovation, Science and Economic Development Canada licence-exempt RSS standard(s). Operation is subject to the following two conditions: (1) this device may not cause interference, and (2) this device must accept any interference, including interference that may cause undesired operation of the device.

Le présent appareil est conforme aux CNR d'Innovation, Sciences et Développement économique Canada applicables aux appareils radio exempts de licence. L'exploitation est autorisée aux deux conditions suivantes : (1) l'appareil ne doit pas produire de brouillage, et (2) l'utilisateur de l'appareil doit accepter tout brouillage radioélectrique subi, même si le brouillage est susceptible d'en compromettre le fonctionnement.

RF exposure

This device complies with the radiation exposure limits of the ISDE for an uncontrolled environment. The antenna must be installed so as to keep a minimum distance of 20 centimeters between the source of radiation and your body. The transmitter shall not be co-located or operate in conjunction with any other antenna or transmitter.

Cet appareil est conforme aux limites d'exposition aux rayonnements de l'ISDE pour un environnement non contrôlé. L'antenne doit être installée de façon à garder une distance minimale de 20 centimètres entre la source de rayonnements et votre corps. L'émetteur ne doit pas être colocalisé ni fonctionner conjointement avec à autre antenne ou autre émetteur.

Electro-magnetic compatibility

Emissions

- FCC CFR47, Part 15, Subpart B, Class A
- ICES-003 (A), ISSUE 5, Class A
- CISPR 32/EN 55032
- IEC 61000-3-2/EN61000-3-2

Immunity

- CISPR 24/EN55024
- IEC 61000-3-3/EN61000-3-3
- IEC/EN61000
- IEC 61000-4-2/EN61000-4-2
- IEC 61000-4-3/EN61000-4-3
- IEC 61000-4-4/EN61000-4-4
- IEC 61000-4-5/EN61000-4-5
- IEC 61000-4-6/EN61000-4-6
- IEC 61000-4-11/EN61000-4-11

Environmental

EU Directive (2011/65/EU) on the restriction of the uses of certain hazardous substances (RoHS) in electrical and electronic equipment and the applicable official amendment(s).

EU Regulation (EC) No. 1907/2006 on the registration, evaluation, authorization and restriction of chemicals (REACH) and the applicable official amendment(s).

EU Directive (2012/19/EU) on waste and electrical and electronic equipment (WEEE) and the applicable official amendment(s).

China Ministry of Information Industry (along with 7 other Government Agencies) Order No.32 (01/2016) on the control of pollution caused by electronic information products, hazardous substances

concentration limits (GB/T 26572 - 2011), and the applicable product marking requirement (SJ/T 11364 - 2014)

Corporate offices

USA—Cypress
ph: 714-236-8610
Canada—Kitchener
ph: 519-744-8005

Consultant offices

Italy
ph: +39 (0) 2 9902 1161

Worldwide offices

Australia
ph: +61 (0) 7 3624 4888
Brazil
ph: +55 (11) 2548 4753
China (Beijing)
ph: +86 10 6561 0240
China (Shanghai)
ph: +86 21 6278 7708

Eastern Europe and
Russian Federation
ph: +36 (0) 1 47 48 100
France
ph: +33 (0) 1 41 21 44 04
Germany
ph: +49 2161 664540

India
ph: +91 (080) 6708 9999
Japan (Tokyo)
ph: 81 3 3599 7481
Korea (Seoul)
ph: +82 2 702 1601
Republic of South Africa
ph: +27 (0) 11 510 0094

Singapore
ph: +65 6877-8737
Spain
ph: +34 91 633 9990
United Arab Emirates
ph: +971 4 3206688
United Kingdom
ph: +44 (0) 118 977 8000